

# FCC TEST REPORT

according to

## FCC Rules and Regulations

### Part 15 Subpart E

Applicant	Silex Technology Inc.
Address	15-15 Takaida, Higashiosaka-shi, Osaka 577-0053 Japan
Equipment	802.11 Wireless Device Server
Model No.	SX-200
Series No.	SX-600, XRX-600
FCC ID	N6C-SX-200
Trade Name	Silex

Laboratory accreditation



1332

- The test result refers exclusively to the test presented test model / sample.,
- Without written approval of **Exclusive Certification Corp.** the test report shall not be reproduced except in full.
- The EUT is also considered as a kind of computer peripheral, because the connection to computer is necessary for typical use. It has been verified to comply with the requirements of FCC Part 15, Subpart B, Class B (DoC). The test report has been issued separately.

## CONTENTS

CERTIFICATE OF COMPLIANCE.....	4
1. Report of Measurements and Examinations.....	5
1.1. List of Measurements and Examinations .....	5
2. Test Configuration of Equipment under Test.....	6
2.1. Feature of Equipment under Test.....	6
2.2. RF Specifications .....	6
2.3. Test Mode and Test Software.....	7
2.4. Description of Test System.....	7
2.5. Connection Diagram of Test System.....	8
3. General Information of Test.....	9
3.1. Description of series model.....	9
3.2. History of this test report .....	9
4. Antenna Requirements .....	10
4.1. Standard Applicable .....	10
4.2. Antenna Construction and Directional Gain.....	10
5. Test of Conducted Emission .....	10
5.1. Test Limit .....	11
5.2. Test Procedures .....	11
5.3. Typical Test Setup .....	12
5.4. Measurement equipment .....	12
5.5. Test Result and Data.....	13
5.6. Test Photographs .....	17
6. Test of Radiated Emission .....	18
6.1. Test Limit .....	18
6.2. Test Procedures .....	18
6.3. Typical Test Setup .....	19
6.4. Measurement equipment .....	19
6.5. Test Result of Radiated Emission .....	20
6.6. Test Photographs .....	28
7. Peak Transmit Power.....	29
7.1. Test Procedure .....	29
7.2. Test Setup Layout .....	29
7.3. Measurement equipment .....	29
7.4. Test Result and Data.....	29
8. Peak Power Excursion.....	34
8.1. Test Procedure .....	34
8.2. Test Setup Layout .....	34
8.3. Measurement equipment .....	34
8.4. Test Result and Data.....	34
9. Peak Power Spectral Density.....	37
9.1. Test Procedure .....	37
9.2. Test Setup Layout .....	37
9.3. Measurement equipment .....	37
9.4. Test Result and Data.....	37
10. Frequency Stability.....	40
10.1. Test Procedure .....	40

10.2. Test Setup Layout.....40

10.3. Measurement equipment .....40

10.4. Test Result and Data.....41

11. Band Edges Measurement .....42

11.1. Test Procedure .....42

11.2. Measurement equipment .....42

11.3. Test Result and Data.....42

11.4. Restrict Band Emission Measurement Data .....44

12. Restricted Bands of Operation.....45

12.1. Labeling Requirement.....45

Appendix A. Photographs of EUT.....A1 ~ A8

# CERTIFICATE OF COMPLIANCE

according to

## FCC Rules and Regulations

### Part 15 Subpart E

Applicant	Silex Technology Inc.
Address	15-15 Takaida, Higashiosaka-shi, Osaka 577-0053 Japan
Equipment	802.11 Wireless Device Server
Model No.	SX-200
Series No.	SX-600, XRX-600
FCC ID	N6C-SX-200
Trade Name	Silex

#### I HEREBY CERTIFY THAT :

The measurements shown in this test report were made in accordance with the procedures given in **ANSI C63.4**. The equipment was **passed** the test performed according to **FCC Rules and Regulations Part 15 Subpart E (2003)**.

The test was carried out on Mar. 09, 2006 at **Exclusive Certification Corp.**

#### Signature

  
Anson Chou / Manager

## 1. Report of Measurements and Examinations

### 1.1. List of Measurements and Examinations

For Frequency 5.15GHz ~ 5.35GHZ

Applied Standard : FCC Part 15, Subpart E (Section 15.407)		
FCC Rule	Description of Test	Result
15.407(b)(5)	. Conducted Emission	Pass
15.407(b/1/2/3)(b)(5)	. Radiated Emission	Pass
15.407(a/1/2/3)	. Peak Transmit Power	Pass
15.407(a)(6)	. Peak Power Excursion	Pass
15.407(a/1/2/3)	. Peak Power Spectral Density	Pass
15.407(g)	. Frequency Stability	Pass

Test engineer: \_\_\_\_\_

*Jerry*

## 2. Test Configuration of Equipment under Test

### 2.1. Feature of Equipment under Test

- Compatibility: compatible with IEEE 802.11a, 802.11b, 802.11h and 802.11j WLAN standards
- Security: supports 64 or 128 bit WEP encryption, WPA, 802.1x.
- Support for 54, 48, 36, 24, 18, 12, 9 and 6Mbps OFDM, 5.5Mbps CCK and legacy 2 and 1Mbps data rates
- Drivers supports Windows 2000 (SR1), XP and Linux
- Supports dual diversity antenna
- Standard MiniPCI Type IIIB form factor
- Intelligent power control, including 802.11 Power Save Mode
- Ad-Hoc and Infrastructure modes supported
- FCC Parts 15 certified (USA), WiFi and RoHS compliant

### 2.2. RF Specifications

<b>Radio Emission Type</b>	Comply with IEEE 802.11a, 802.11b, 802.11g, 802.11h and 802.11j DSSS (Direct Sequence Spread Spectrum) physical layer.
<b>Operating Frequency</b>	2.412 GHz ~ 2.484 GHz ISM band 2.4 GHz ~ 2.497 GHz (Japan ISM band) 4.9 GHz ~ 5.9 GHz ISM band
<b>Data Modulation types</b>	OFDM (Orthogonal Frequency Division Multiplexing) CCK (Complementary Code Keying) DQPSK (Differential Quadrature Phase Shift Keying), DBPSK (Differential Binary Phase Shift Keying)
<b>Channel Number</b>	Channels 1-11 (and 12-14) for IEEE 802.11b/g Channels 36, 40, 44, 48, 52, 56, 60, 64, 149, 153, 157, 161, 165 for IEEE 802.11a
<b>Data Rate</b>	54Mbps with fall back rates of 48, 36, 24, 18, 12, 11, 9, 6, 5.5, 2, 1 Mbps
<b>Security</b>	64/128 bits WEP Encryption, WPA, 802.1x Authentication
<b>Media Access Protocol</b>	CSMA/CA (Carrier Sense Multiple Access with Collision Avoidance) with ACK architecture, 32 bits MAC-layer
<b>Antenna Connector Type</b>	2 pieces of SMT ultra-miniature coaxial connectors
<b>Operating Voltage</b>	3.3 VDC $\pm$ 5%
<b>Bus Interface</b>	Mini PCI
<b>Antenna port impedance</b>	50ohm
<b>Channel Switching Speed</b>	260 uSec
<b>LO Settling Time</b>	61 uSec

### 2.3. Test Mode and Test Software

The following test mode and test software was performed for conduction and radiation test:

- 802.11a (CH 36: Test Define CH1: 5180MHz)
- 802.11a (CH 48: Test Define CH4: 5240MHz)
- 802.11a (CH 52: Test Define CH5: 5260MHz)
- 802.11a (CH 64: Test Define CH8: 5320MHz)
- An executive programs, "Hyper termindl.exe" Application under WIN XP
- Modulation type: OFDM .

### 2.4. Description of Test System

Device	Manufacturer	Model No.	Description
PC	IBM	IGV	Power Cable, Unshielding 1.8 m
Monitor	SlimAGE	510A	Power Cable, Adapter Unshielding 1.8 m Data Cable, VGA shielding 1.35 m
Keyboard	IBM	KB-0225	Data Cable, PS2 shielding 1.85 m
Mouse	IBM	MO28VO	Data Cable, USB shielding 1.85 m
Modem	ACEXX	DM-1414	Power Cable, Adapter Unshielding 1.8 m Data Cable, RS232 Unshielding 1.35 m
Printer	HP	Desk Jet400	Power Cable, Adapter Unshielding 1.8 m Data Cable, PRINT Shielding 1.6 m
Printer	HP	LJ-1015	Power Cable, Adapter Unshielding 1.8 m Data Cable, PRINT Shielding 1.6 m
Printer	Epson	S-C43UX	Power Cable, Adapter Unshielding 1.8 m Data Cable, PRINT Shielding 1.6 m

Use Cable:

Cable	Description
RJ-45*1	Unshielding, 1.5m

## 2.5. Connection Diagram of Test System

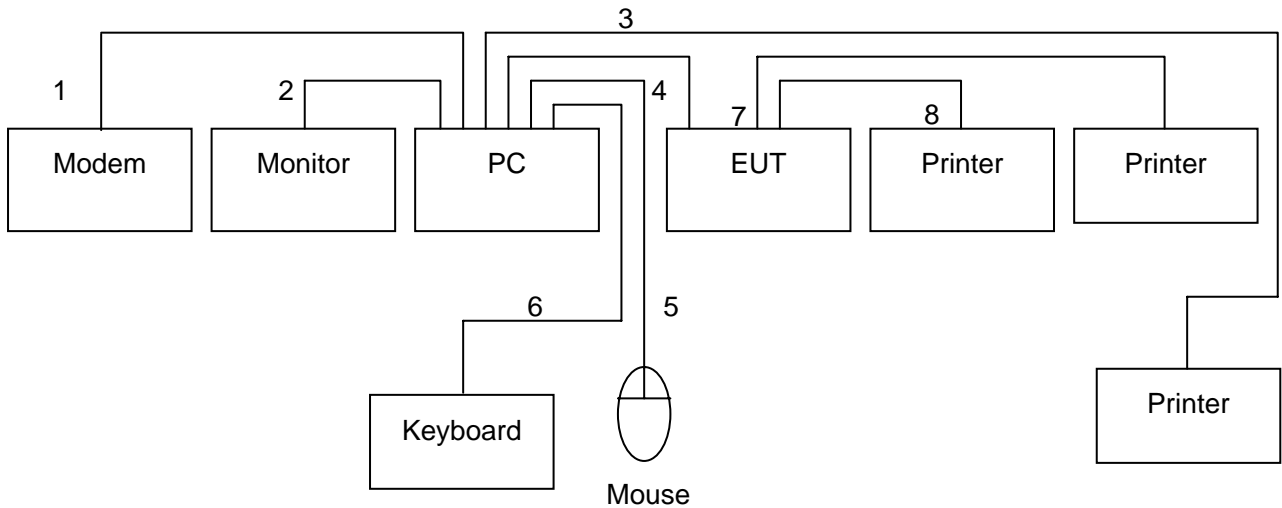

1. The I/O cable is connected from PC to the Modem.
2. The I/O cable is connected from PC to the Monitor.
3. The I/O cable is connected from PC to the Printer.
4. The RJ45 cable is connected from PC to the EUT.
5. The I/O cable is connected from PC to the Mouse.
6. The I/O cable is connected from PC to the Keyboard.
7. The I/O cable is connected from EUT to the Printer.
8. The I/O cable is connected from EUT to the Printer.



### 3. General Information of Test

Test Site:	Exclusive Certification Corp. 4F-2, No. 28, Lane 78, Xing-Ai Rd. Nei-hu, Taipei City 114 Taiwan R.O.C.
Test Site Location (OATS1-SD):	No.68-1, Shihbachongsi, shihding Township, Taipei City 223, Taiwan, R.O.C.
Test Voltage:	AC 120V/ 60Hz
Test in Compliance with:	ANSI C63.4-2003 FCC Part 15 Subpart E
Frequency Range Investigated:	AC Power Conducted Emission : from 150kHz to 30 MHz Radiated and conducted Emission: from 30 MHz to 40 GHz
Test Distance:	The test distance of radiated emission from antenna to EUT is 3 M.

#### 3.1. Description of series model

Model No.	Printer server function
SX-200	Enable
SX-600	Disable
XRX-600	Disable

Note: the printer server function to be control by firmware, and the electronics is identical.

#### 3.2. History of this test report

ORIGINAL.

## 4. Antenna Requirements

### 4.1. Standard Applicable

For intentional device, according to FCC 47 CFR Section 15.203, an intentional radiator shall be designed to ensure that no antenna other than that furnished by the responsible party shall be used with the device.

And according to FCC 47 CFR Section 15.247 (b), if transmitting antennas of directional gain greater than 6dBi are used, the power shall be reduced by the amount in dB that the directional gain of the antenna exceeds 6dBi.

### 4.2. Antenna Construction and Directional Gain

Antenna 1:

Antenna type: Reverse SMA connect, Dipole antenna

Antenna Gain: 2 dBi for 2.4 GHz Band.

0 dBi for 5 GHz Band.

Antenna 2:

Antenna type: Reverse SMA connect, Dipole antenna

Antenna Gain: 5 dBi for 2.4 GHz Band.

3 dBi for 5 GHz Band.

## 5. Test of Conducted Emission

### 5.1. Test Limit

Conducted Emissions were measured from 150 kHz to 30 MHz with a bandwidth of 9 KHz on the 120 VAC power and return leads of the EUT according to the methods defined in ANSI C63.4-2003 Section 3.1. The EUT was placed on a nonmetallic stand in a shielded room 0.8 meters above the ground plane as shown in section 1.3.1. The interface cables and equipment positioning were varied within limits of reasonable applications to determine the position produced maximum conducted emissions.

Frequency (MHz)	Quasi Peak (dB $\mu$ V)	Average (dB $\mu$ V)
0.15 – 0.5	66-56*	56-46*
0.5 – 5.0	56	46
5.0 – 30.0	60	50

\*Decreases with the logarithm of the frequency.

### 5.2. Test Procedures

- a. The EUT was placed 0.4 meter from the conducting wall of the shielding room was kept at least 80 centimeters from any other grounded conducting surface.
- b. Connect EUT to the power mains through a line impedance stabilization network (LISN).
- c. All the support units are connecting to the other LISN.
- d. The LISN provides 50 ohm coupling impedance for the measuring instrument.
- e. The FCC states that a 50 ohm, 50 micro-Henry LISN should be used.
- f. Both sides of AC line were checked for maximum conducted interference.
- g. The frequency range from 150 kHz to 30 MHz was searched.
- h. Set the test-receiver system to Peak Detect Function and Specified Bandwidth with Maximum Hold Mode.

### 5.3. Typical Test Setup

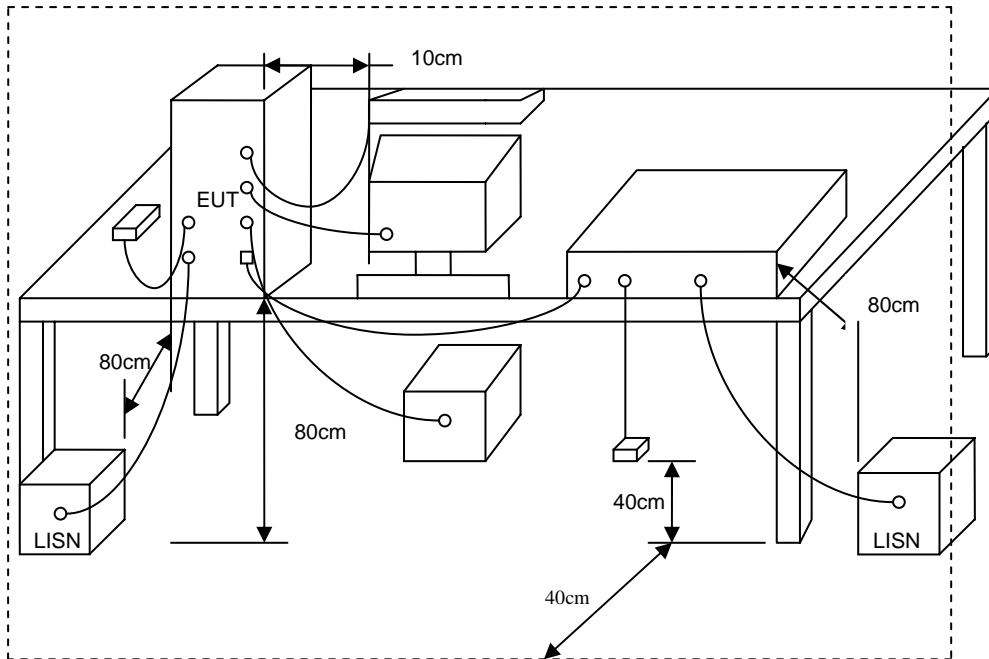

### 5.4. Measurement equipment

Instrument/Ancillary	Model No.	Manufacturer	Serial No.	Valid Date
Receiver	SCR3501	Schaffner	437	2006/11/03
LISN	NNB-2/16Z	MESS TEC	02/10191	2007/03/30
LISN	NNB-2/16Z	ROLF HEINE	03/10058	2007/04/26

5.5. Test Result and Data

EUT : SX-200  
 Power : AC 120V  
 Test Mode : 802.11a CH 1  
 Memo : MT12-4120100-A1

Pol/Phase : NEUTRAL  
 Temperature : 25 °C  
 Humidity : 65 %

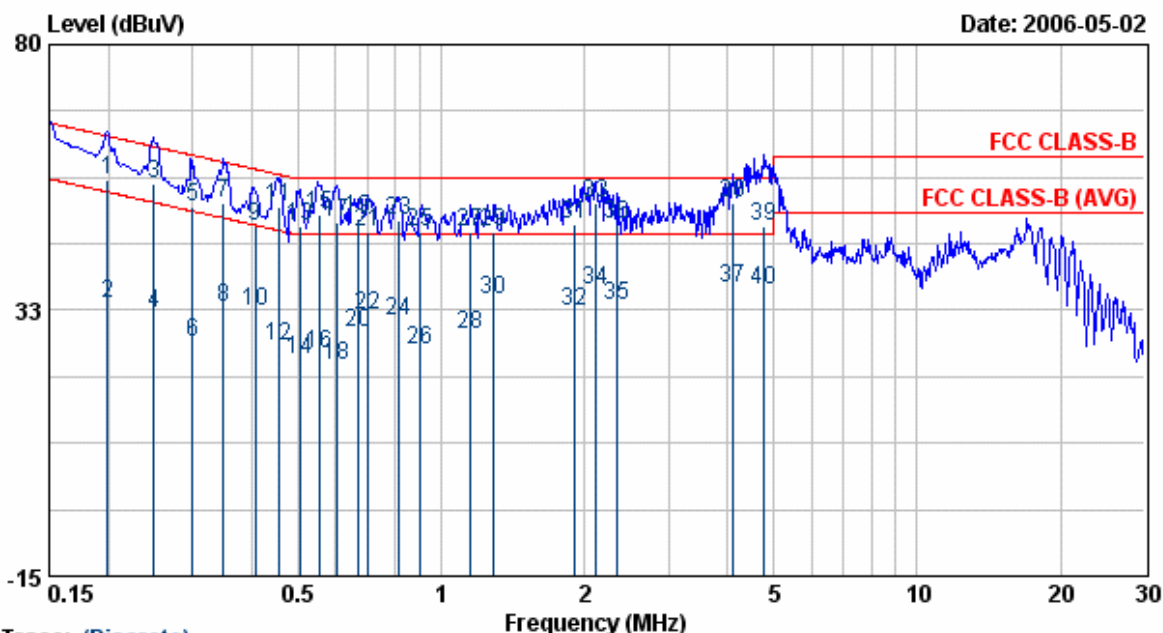

Trace: (Discrete)

Freq	Read Level	Factor	Level	Limit	Over Limit	Remark
MHz	dBuV	dB	dBuV	dBuV	dBuV	
0.20	55.50	0.20	55.70	63.66	-7.96	QP
0.20	33.40	0.20	33.60	53.66	-20.06	AVERAGE
0.25	54.70	0.29	54.99	61.81	-6.81	QP
0.25	31.65	0.29	31.94	51.81	-19.86	AVERAGE
0.30	50.45	0.38	50.83	60.23	-9.40	QP
0.30	26.28	0.38	26.66	50.23	-23.57	AVERAGE
0.35	51.18	0.44	51.62	59.00	-7.38	QP
0.35	32.48	0.44	32.92	49.00	-16.08	AVERAGE
0.41	47.05	0.50	47.55	57.73	-10.18	QP
0.41	31.87	0.50	32.37	47.73	-15.36	AVERAGE
0.46	50.32	0.50	50.82	56.76	-5.94	QP
0.46	25.60	0.50	26.10	46.76	-20.66	AVERAGE
0.50	47.16	0.50	47.66	56.00	-8.34	QP
0.50	23.31	0.50	23.81	46.00	-22.19	AVERAGE
0.55	49.27	0.50	49.77	56.00	-6.23	QP
0.55	24.24	0.50	24.74	46.00	-21.26	AVERAGE
0.60	47.81	0.50	48.31	56.00	-7.69	QP
0.60	22.25	0.50	22.75	46.00	-23.25	AVERAGE
0.67	48.50	0.50	49.00	56.00	-7.00	QP
0.67	27.88	0.50	28.38	46.00	-17.62	AVERAGE
0.70	46.07	0.50	46.57	56.00	-9.43	QP
0.70	31.24	0.50	31.74	46.00	-14.26	AVERAGE
0.82	48.12	0.50	48.62	56.00	-7.38	QP
0.82	30.00	0.50	30.50	46.00	-15.50	AVERAGE
0.91	45.92	0.50	46.42	56.00	-9.58	QP

0.91	24.82	0.50	25.32	46.00	-20.68	AVERAGE
1.15	45.94	0.52	46.46	56.00	-9.54	QP
1.15	27.65	0.52	28.17	46.00	-17.83	AVERAGE
1.29	46.11	0.54	46.65	56.00	-9.35	QP
1.29	33.92	0.54	34.46	46.00	-11.54	AVERAGE
1.91	47.15	0.59	47.74	56.00	-8.26	QP
1.91	31.82	0.59	32.41	46.00	-13.59	AVERAGE
2.11	51.06	0.60	51.66	56.00	-4.34	QP
2.11	35.65	0.60	36.25	46.00	-9.75	AVERAGE
2.35	32.79	0.60	33.39	46.00	-12.61	AVERAGE
2.35	47.33	0.60	47.93	56.00	-8.07	QP
4.10	35.84	0.60	36.44	46.00	-9.56	AVERAGE
4.10	50.97	0.60	51.57	56.00	-4.43	QP
4.75	46.92	0.60	47.52	56.00	-8.48	QP
4.75	35.38	0.60	35.98	46.00	-10.02	AVERAGE

- 
- Remarks: 1. Level = Read Level + Factor  
 2. Factor = LISN(ISN) Factor + Cable Loss  
 3. According to technical experiences, all spurious emission of 802.11a mode at channel 1,4,5,8 are almost the same below 1GHz, so that the channel 1 was chosen as representative in final test.  
 4. The data is worse case.

EUT : SX-200  
 Power : AC 120V  
 Test Mode : 802.11a CH 1  
 Memo : MT12-4120100-A1

Pol/Phase : LINE  
 Temperature : 25 °C  
 Humidity : 65 %

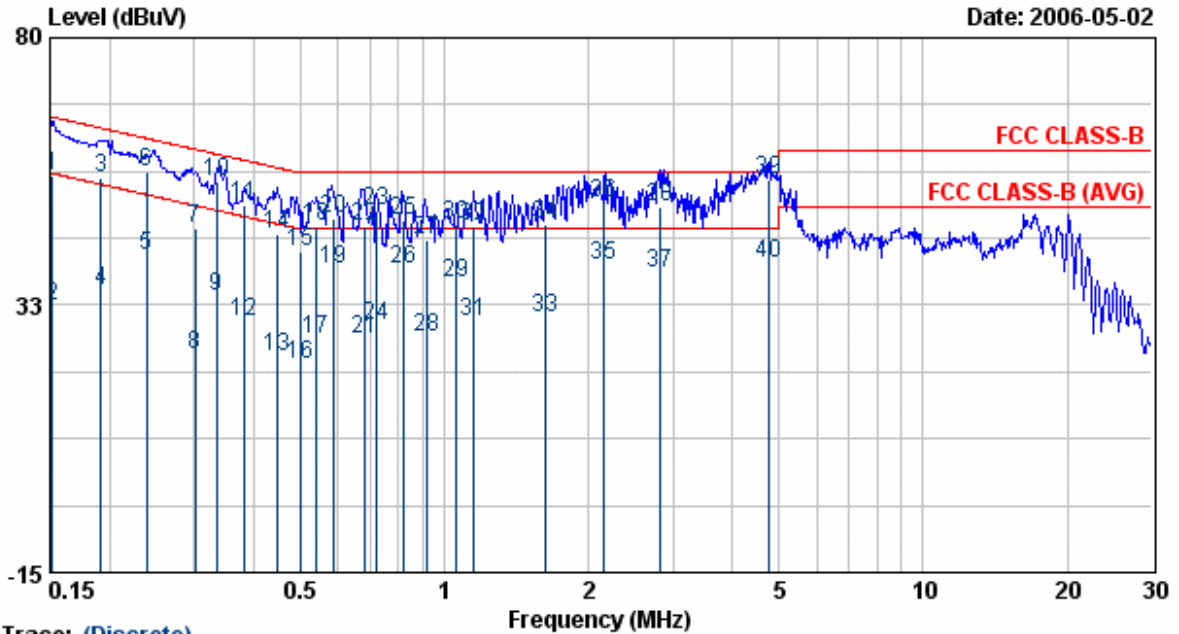

Trace: (Discrete)

Freq	Read Level	Factor	Level	Limit	Over Limit	Remark
MHz	dBuV	dB	dBuV	dBuV	dBuV	
0.15	55.22	0.38	55.60	65.91	-10.31	QP
0.15	32.00	0.38	32.38	55.91	-23.53	AVERAGE
0.19	54.66	0.31	54.97	63.96	-8.99	QP
0.19	34.86	0.31	35.17	53.96	-18.79	AVERAGE
0.24	40.90	0.38	41.28	52.13	-10.86	AVERAGE
0.24	55.64	0.38	56.02	62.13	-6.12	QP
0.30	45.83	0.48	46.31	60.18	-13.87	QP
0.30	23.06	0.48	23.54	50.18	-26.64	AVERAGE
0.33	33.45	0.52	33.97	49.33	-15.36	AVERAGE
0.33	53.92	0.52	54.44	59.33	-4.89	QP
0.38	49.64	0.58	50.22	58.23	-8.01	QP
0.38	28.92	0.58	29.50	48.23	-18.73	AVERAGE
0.45	22.74	0.59	23.33	46.94	-23.61	AVERAGE
0.45	44.56	0.59	45.15	56.94	-11.79	QP
0.50	41.39	0.58	41.97	56.01	-14.04	QP
0.50	21.22	0.58	21.80	46.01	-24.21	AVERAGE
0.54	25.75	0.57	26.32	46.00	-19.68	AVERAGE
0.54	45.98	0.57	46.55	56.00	-9.45	QP
0.59	38.25	0.56	38.81	46.00	-7.19	AVERAGE
0.59	47.40	0.56	47.96	56.00	-8.04	QP
0.68	25.94	0.54	26.48	46.00	-19.52	AVERAGE
0.68	46.07	0.54	46.61	56.00	-9.39	QP
0.72	48.60	0.54	49.14	56.00	-6.86	QP
0.72	28.18	0.54	28.72	46.00	-17.28	AVERAGE
0.82	47.09	0.52	47.61	56.00	-8.39	QP

0.82	38.28	0.52	38.80	46.00	-7.20	AVERAGE
0.92	43.42	0.51	43.93	56.00	-12.07	QP
0.92	26.35	0.51	26.86	46.00	-19.14	AVERAGE
1.05	36.04	0.52	36.56	46.00	-9.44	AVERAGE
1.05	46.20	0.52	46.72	56.00	-9.28	QP
1.16	29.12	0.54	29.66	46.00	-16.34	AVERAGE
1.16	46.01	0.54	46.55	56.00	-9.45	QP
1.63	29.75	0.64	30.39	46.00	-15.61	AVERAGE
1.63	46.29	0.64	46.93	56.00	-9.07	QP
2.16	38.96	0.70	39.66	46.00	-6.34	AVERAGE
2.16	49.79	0.70	50.49	56.00	-5.51	QP
2.81	37.41	0.70	38.11	46.00	-7.89	AVERAGE
2.81	49.15	0.70	49.85	56.00	-6.15	QP
4.74	54.10	0.68	54.78	56.00	-1.22	QP
4.74	39.35	0.68	40.03	46.00	-5.97	AVERAGE

- Remarks:
1. Level = Read Level + Factor
  2. Factor = LISN(ISN) Factor + Cable Loss
  3. According to technical experiences, all spurious emission of 802.11a mode at channel 1,4,5,8 are almost the same below 1GHz, so that the channel 1 was chosen as representative in final test.
  4. The data is worse case.

Test engineer:

Ben



### 5.6. Test Photographs

Front View



Rear View



## 6. Test of Radiated Emission

### 6.1. Test Limit

Radiated emissions from 30 MHz to 40 GHz were measured according to the methods defines in ANSI C63.4-2003. The EUT was placed, 0.8 meter above the ground plane, as shown in section 1.4.2. The interface cables and equipment positions were varied within limits of reasonable applications to determine the positions producing maximum radiated emissions

### 6.2. Test Procedures

- a. The EUT was placed on a rotatable table top 0.8 meter above ground.
- b. The EUT was set 3 meters from the interference receiving antenna which was mounted on the top of a variable height antenna tower.
- c. The table was rotated 360 degrees to determine the position of the highest radiation.
- d. The antenna is a broadband antenna and its height is varied between one meter and four meters above ground to find the maximum value of the field strength both horizontal polarization and vertical polarization of the antenna are set to make the measurement.
- e. For each suspected emission the EUT was arranged to its worst case and then tune the antenna tower (from 1 M to 4 M) and turn table (from 0 degree to 360 degrees) to find the maximum reading.
- f. Set the test-receiver system to Peak or CISPR quasi-peak Detect Function and specified bandwidth with Maximum Hold Mode.
- g. If the emission level of the EUT in peak mode was 3 dB lower than the limit specified, then testing will be stopped and peak values of EUT will be reported, otherwise, the emissions which do not have 3 dB margin will be repeated one by one using the quasi-peak method and reported.
- h. For testing above 1GHz, the emission level of the EUT in peak mode was 20dB lower than average limit (that means the emission level in peak mode also complies with the limit in average mode), then testing will be stopped and peak values of EUT will be reported, otherwise, the emissions will be measured in average mode again and reported.

### 6.3. Typical Test Setup

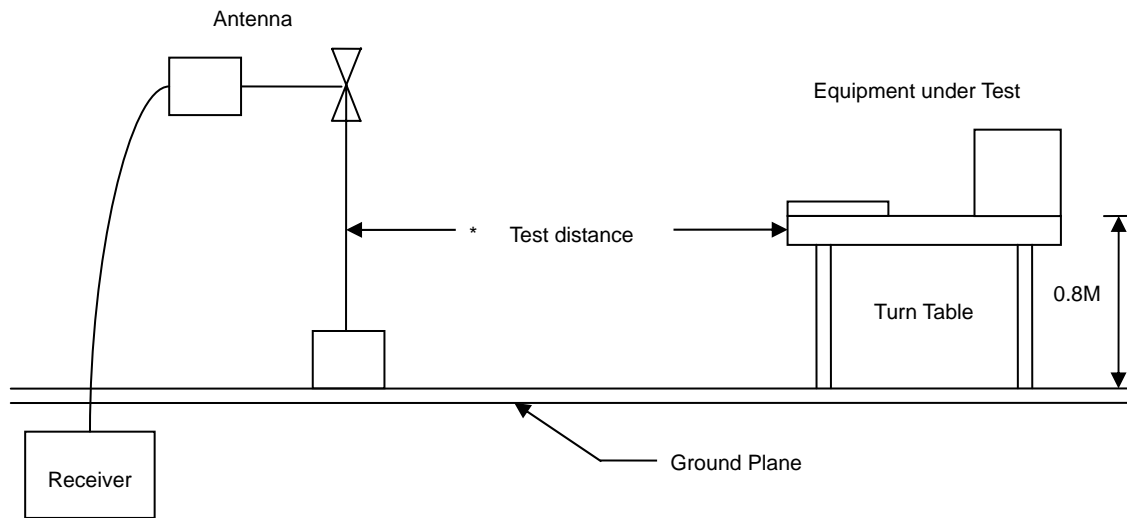

### 6.4. Measurement equipment

Instrument/Ancillary	Model No.	Manufacturer	Serial No.	Valid Date
EMI Receiver	8546A	HP	3807A00454	2007/04/13
Spectrum Analyzer	FSP40	R&S	100047	2007/01/16
Horn Antenna	3115	EMCO	31589	2007/02/12
Horn Antenna	3116	EMCO	31970	2007/02/09
Bilog Antenna	CBL6112B	Schaffner	2840	2007/04/19
Amplifier	8449B	Agilent	3008A01954	2007/01/08
Amplifier	8447D	Agilent	2944A10531	2006/08/09
Amplifier	PA-840	COM-POWER	711885	2006/08/10

6.5. Test Result of Radiated Emission

EUT	: SX-200	Pol/Phase	: HORIZONTAL
Power	: AC 120V	Temperature	: 24 °C
Test Mode	: Transmit/Receive	Humidity	: 70 %
Operation Channel	: 1	Atmospheric Pressure	: 1015 hPa
Modulation Type	: 802.11a		
Rate	: 54 Mbps		
Memo	: MT12-4120100-A1		

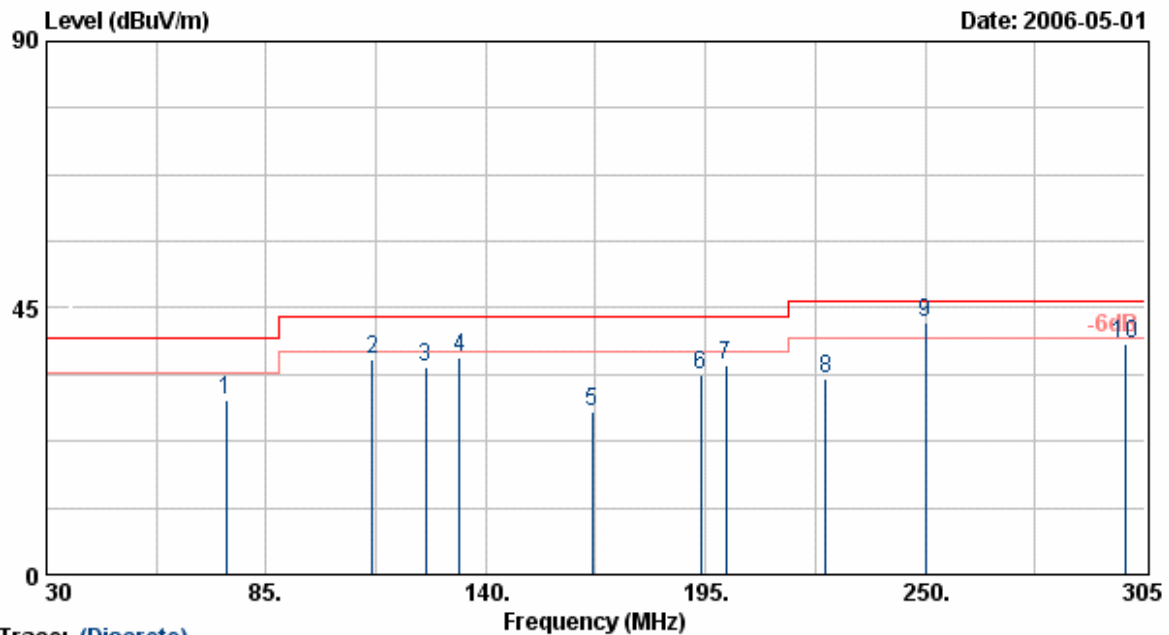

Trace: (Discrete)

Frequency (MHz)	Meter Reading (dBuV)	Corrected Factor (dBuV/m)	Result (dBuV/m)	Limit (dB)	Margin (dB)	Remark	Table Deg.	Ant High (cm)
75.05	49.74	-20.27	29.47	40.00	-10.53	Peak	85	200
111.64	52.60	-16.33	36.27	43.50	-7.23	Peak	77	200
125.03	50.80	-15.68	35.12	43.50	-8.38	Peak	77	200
133.38	52.33	-15.75	36.58	43.50	-6.92	Peak	169	200
166.70	44.60	-17.14	27.46	43.50	-16.04	Peak	66	200
193.85	51.60	-17.84	33.76	43.50	-9.74	Peak	88	200
200.01	53.21	-18.01	35.20	43.50	-8.30	Peak	100	200
225.00	50.00	-17.07	32.93	46.00	-13.07	Peak	330	200
250.06	56.66	-14.02	42.64	46.00	-3.36	QP	312	200
300.00	52.00	-13.21	38.79	46.00	-7.21	Peak	312	200

Notes:

1. Result = Meter Reading + Corrected Factor
2. Corrected Factor = Antenna Factor + Cable Loss - Amplifier
3. The resolution bandwidth of test receiver/spectrum analyzer is 120KHz and video bandwidth is 300kHz for Peak detection and Quasi-peak detection at frequency below 1GHz.
4. According to technical experiences, all spurious emission of 802.11a mode at channel 1,4,5,8 are almost the same below 1GHz, so that the channel 1 was chosen as representative in final test.
5. The data is worse case.

EUT	: SX-200	Pol/Phase	: HORIZONTAL
Power	: AC 120V	Temperature	: 24 °C
Test Mode	: Transmit/Receive	Humidity	: 70 %
Operation Channel	: 1	Atmospheric Pressure	: 1015 hPa
Modulation Type	: 802.11a		
Rate	: 54 Mbps		
Memo	: MT12-4120100-A1		

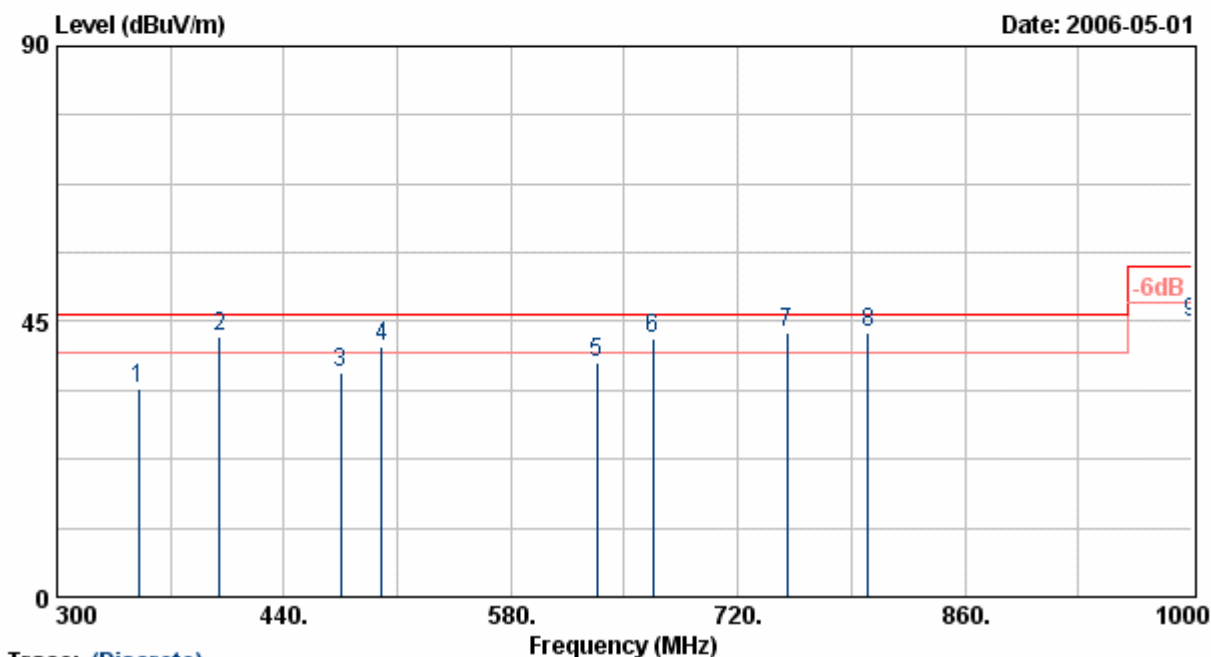

Trace: (Discrete)

Frequency (MHz)	Meter Reading (dBUV)	Corrected Factor (dBUV/m)	Result (dBUV/m)	Limit (dB)	Margin (dB)	Remark	Table Deg.	Ant High (cm)
350.40	45.66	-11.54	34.12	46.00	-11.88	Peak	254	200
400.06	52.66	-10.12	42.54	46.00	-3.46	QP	32	200
475.06	44.20	-7.41	36.79	46.00	-9.21	Peak	0	200
500.06	47.44	-6.58	40.86	46.00	-5.14	QP	45	200
633.26	41.55	-3.36	38.19	46.00	-7.81	Peak	0	200
667.75	45.32	-3.03	42.29	46.00	-3.71	QP	0	200
750.09	44.70	-1.44	43.26	46.00	-2.74	QP	156	200
800.09	44.63	-1.53	43.10	46.00	-2.90	QP	156	200
999.98	43.87	0.96	44.83	54.00	-9.17	Peak	351	200

Notes:

1. Result = Meter Reading + Corrected Factor
2. Corrected Factor = Antenna Factor + Cable Loss - Amplifier
3. The resolution bandwidth of test receiver/spectrum analyzer is 120KHz and video bandwidth is 300kHz for Peak detection and Quasi-peak detection at frequency below 1GHz.
4. According to technical experiences, all spurious emission of 802.11a mode at channel 1,4,5,8 are almost the same below 1GHz, so that the channel 1 was chosen as representative in final test.
5. The data is worse case.

EUT : SX-200  
 Power : AC 120V  
 Test Mode : Transmit/Receive  
 Operation Channel: 1  
 Modulation Type : 802.11a  
 Rate : 54 Mbps  
 Memo : MT12-4120100-A1

Pol/Phase : VERTICAL  
 Temperature : 24 °C  
 Humidity : 70 %  
 Atmospheric Pressure: 1015 hPa

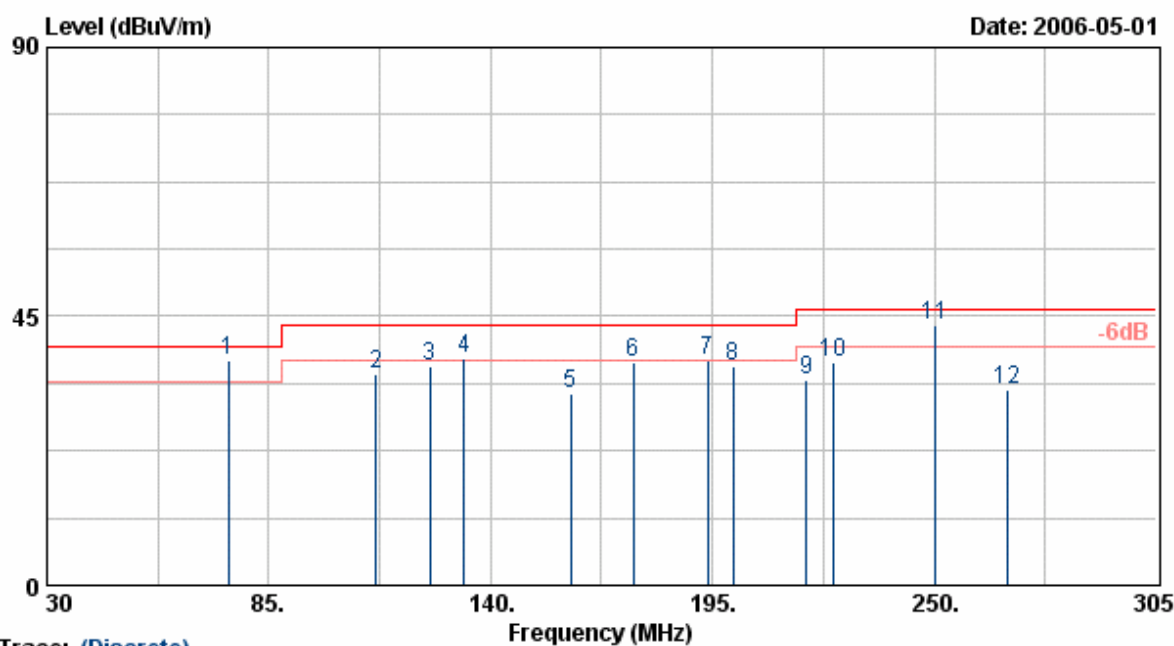

Trace: (Discrete)

Frequency (MHz)	Meter Reading (dBuV)	Corrected Factor (dBuV/m)	Result (dBuV/m)	Limit (dB)	Margin (dB)	Remark	Table Deg.	Ant High (cm)
75.04	57.86	-20.28	37.58	40.00	-2.42	QP	93	100
111.64	51.63	-16.33	35.30	43.50	-8.20	Peak	211	100
125.05	52.21	-15.68	36.53	43.50	-6.97	Peak	211	100
133.35	53.62	-15.75	37.87	43.50	-5.63	QP	0	100
159.80	48.55	-16.60	31.95	43.50	-11.55	Peak	144	100
175.30	55.26	-17.82	37.44	43.50	-6.06	Peak	323	100
193.80	55.44	-17.84	37.60	43.50	-5.90	QP	323	100
200.03	54.80	-18.01	36.79	43.50	-6.71	Peak	300	100
218.25	52.14	-17.77	34.37	46.00	-11.63	Peak	35	100
225.00	54.30	-17.07	37.23	46.00	-8.77	Peak	35	100
250.04	57.70	-14.02	43.68	46.00	-2.32	QP	0	100
268.34	46.40	-13.52	32.88	46.00	-13.12	Peak	0	100

Notes:

1. Result = Meter Reading + Corrected Factor
2. Corrected Factor = Antenna Factor + Cable Loss - Amplifier
3. The resolution bandwidth of test receiver/spectrum analyzer is 120KHz and video bandwidth is 300kHz for Peak detection and Quasi-peak detection at frequency below 1GHz.
4. According to technical experiences, all spurious emission of 802.11a mode at channel 1,4,5,8 are almost the same below 1GHz, so that the channel 1 was chosen as representative in final test.
5. The data is worse case.

EUT : SX-200  
 Power : AC 120V  
 Test Mode : Transmit/Receive  
 Operation Channel: 1  
 Modulation Type : 802.11a  
 Rate : 54 Mbps  
 Memo : MT12-4120100-A1

Pol/Phase : VERTICAL  
 Temperature : 24 °C  
 Humidity : 70 %  
 Atmospheric Pressure: 1015 hPa

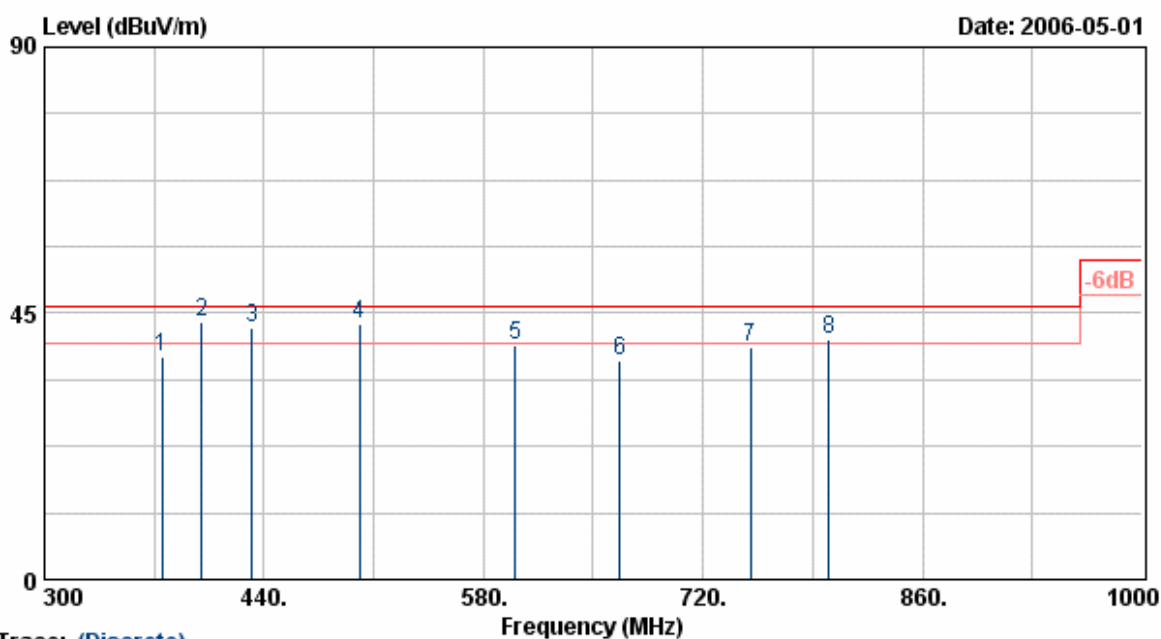

Trace: (Discrete)

Frequency (MHz)	Meter Reading (dBUV)	Corrected Factor (dBUV/m)	Result (dBUV/m)	Limit (dB)	Margin (dB)	Remark	Table Deg.	Ant High (cm)
375.03	48.44	-10.75	37.69	46.00	-8.31	Peak	166	100
400.05	53.70	-10.12	43.58	46.00	-2.42	QP	166	100
432.30	51.25	-8.86	42.39	46.00	-3.61	QP	223	100
500.65	49.90	-6.54	43.36	46.00	-2.64	QP	223	100
600.04	43.40	-3.79	39.61	46.00	-6.39	Peak	131	100
666.75	39.88	-3.01	36.87	46.00	-9.13	Peak	131	100
750.00	40.80	-1.44	39.37	46.00	-6.63	Peak	0	100
800.10	42.25	-1.53	40.72	46.00	-5.28	QP	0	100

Notes:

1. Result = Meter Reading + Corrected Factor
2. Corrected Factor = Antenna Factor + Cable Loss - Amplifier
3. The resolution bandwidth of test receiver/spectrum analyzer is 120KHz and video bandwidth is 300kHz for Peak detection and Quasi-peak detection at frequency below 1GHz.
4. According to technical experiences, all spurious emission of 802.11a mode at channel 1,4,5,8 are almost the same below 1GHz, so that the channel 1 was chosen as representative in final test.
5. The data is worse case.

Emission frequencies 1~40 GHz

Channel 01, Transmit Rate: 54Mbps

Test Date: May. 01, 2006    Temperature: 24    Humidity: 70%    Atmospheric pressure: 1015 hPa

Frequency (MHz)	Ant-Pol H/V	Meter Reading (dBuV)	Corrected Factor (dB)	Result@3m (dBuV/m)	Limit@3m (dBuV/m)	Margin (dB)	Remark	Table Deg.	Ant High (m)
10360.00	H	---	15.79	---	68.3	---	Peak	---	---
15540.00	H	---	17.13	---	54.0	---	Ave	---	---
20720.00	H	---	28.10	---	54.0	---	Ave	---	---
25900.00	H	---	31.67	---	68.3	---	Peak	---	---
10360.00	V	---	14.93	---	68.3	---	Peak	---	---
15540.00	V	---	16.44	---	54.0	---	Ave	---	---
20720.00	V	---	28.10	---	54.0	---	Ave	---	---
25900.00	V	---	31.67	---	68.3	---	Peak	---	---

## Notes:

1. Result = Meter Reading + Corrected Factor
2. Corrected Factor = Antenna Factor + Cable Loss – Amplifier
3. The resolution bandwidth of test receiver/spectrum analyzer is 120 kHz and video bandwidth is 300 kHz for Peak detection and Quasi-peak detection at frequency below 1GHz.
4. The resolution bandwidth of test receiver/spectrum analyzer is 1 MHz and video bandwidth is 3 MHz for Peak detection at frequency above 1GHz.
5. The resolution bandwidth of test receiver/spectrum analyzer is 1MHz and video bandwidth is 10Hz for Average detection at frequency above 1GHz.
6. The other emissions is too below to be measured.



Emission frequencies 1~40 GHz

Channel 04, Transmit Rate: 54Mbps

Test Date: May. 01, 2006 Temperature: 24 Humidity: 70% Atmospheric pressure: 1015 hPa

Frequency (MHz)	Ant-Pol H/V	Meter Reading (dBuV)	Corrected Factor (dB)	Result@3m (dBuV/m)	Limit@3m (dBuV/m)	Margin (dB)	Remark	Table Deg.	Ant High (m)
10480.00	H	---	16.08	---	68.3	---	Peak	---	---
15720.00	H	---	16.70	---	54.0	---	Ave	---	---
20960.00	H	---	28.67	---	54.0	---	Ave	---	---
26200.00	H	---	32.07	---	68.3	---	Peak	---	---
10480.00	V	---	15.27	---	68.3	---	Peak	---	---
15720.00	V	---	16.04	---	54.0	---	Ave	---	---
20960.00	V	---	28.67	---	54.0	---	Ave	---	---
26200.00	V	---	32.07	---	68.3	---	Peak	---	---

## Notes:

1. Result = Meter Reading + Corrected Factor
2. Corrected Factor = Antenna Factor + Cable Loss – Amplifier
3. The resolution bandwidth of test receiver/spectrum analyzer is 120 kHz and video bandwidth is 300 kHz for Peak detection and Quasi-peak detection at frequency below 1GHz.
4. The resolution bandwidth of test receiver/spectrum analyzer is 1 MHz and video bandwidth is 3 MHz for Peak detection at frequency above 1GHz.
5. The resolution bandwidth of test receiver/spectrum analyzer is 1MHz and video bandwidth is 10Hz for Average detection at frequency above 1GHz.

Emission frequencies 1~40 GHz

Channel 05, Transmit Rate: 54Mbps

Test Date: May. 01, 2006    Temperature: 24    Humidity: 70%    Atmospheric pressure: 1015 hPa

Frequency (MHz)	Ant-Pol H/V	Meter Reading (dBuV)	Corrected Factor (dB)	Result@3m (dBuV/m)	Limit@3m (dBuV/m)	Margin (dB)	Remark	Table Deg.	Ant High (m)
10520.00	H	---	16.13	---	68.3	---	Peak	---	---
15780.00	H	---	16.55	---	54.0	---	Ave	---	---
21040.00	H	---	28.90	---	54.0	---	Ave	---	---
26300.00	H	---	32.23	---	68.3	---	Peak	---	---
10520.00	V	---	15.33	---	68.3	---	Peak	---	---
15780.00	V	---	15.91	---	54.0	---	Ave	---	---
21040.00	V	---	28.90	---	54.0	---	Ave	---	---
26300.00	V	---	32.23	---	68.3	---	Peak	---	---

## Notes:

1. Result = Meter Reading + Corrected Factor
2. Corrected Factor = Antenna Factor + Cable Loss – Amplifier
3. The resolution bandwidth of test receiver/spectrum analyzer is 120 kHz and video bandwidth is 300 kHz for Peak detection and Quasi-peak detection at frequency below 1GHz.
4. The resolution bandwidth of test receiver/spectrum analyzer is 1 MHz and video bandwidth is 3 MHz for Peak detection at frequency above 1GHz.
5. The resolution bandwidth of test receiver/spectrum analyzer is 1MHz and video bandwidth is 10Hz for Average detection at frequency above 1GHz.
6. The other emissions is too below to be measured.

Emission frequencies 1~40 GHz

Channel 08, Transmit Rate: 54Mbps

Test Date: May. 01, 2006    Temperature: 24    Humidity: 70%    Atmospheric pressure: 1015 hPa

Frequency (MHz)	Ant-Pol H/V	Meter Reading (dBuV)	Corrected Factor (dB)	Result@3m (dBuV/m)	Limit@3m (dBuV/m)	Margin (dB)	Remark	Table Deg.	Ant High (m)
10640.00	H	---	16.16	---	68.3	---	Peak	---	---
15960.00	H	---	16.12	---	54.0	---	Ave	---	---
21280.00	H	---	29.75	---	54.0	---	Ave	---	---
26600.00	H	---	32.52	---	68.3	---	Peak	---	---
10640.00	V	---	15.36	---	68.3	---	Peak	---	---
15960.00	V	---	15.41	---	54.0	---	Ave	---	---
21280.00	V	---	29.75	---	54.0	---	Ave	---	---
26600.00	V	---	32.52	---	68.3	---	Peak	---	---

Notes:

1. Result = Meter Reading + Corrected Factor
2. Corrected Factor = Antenna Factor + Cable Loss – Amplifier
3. The resolution bandwidth of test receiver/spectrum analyzer is 120 kHz and video bandwidth is 300 kHz for Peak detection and Quasi-peak detection at frequency below 1GHz.
4. The resolution bandwidth of test receiver/spectrum analyzer is 1 MHz and video bandwidth is 3 MHz for Peak detection at frequency above 1GHz.
5. The resolution bandwidth of test receiver/spectrum analyzer is 1MHz and video bandwidth is 10Hz for Average detection at frequency above 1GHz.
6. The other emissions is too below to be measured

## 6.6. Test Photographs

Front View



Rear View



## 7. Peak Transmit Power

### 7.1. Test Procedure

The antenna port (RF output) of the EUT was connected to the input (RF input) of a spectrum analyzer. Power was read directly from the spectrum analyzer and cable loss connection was added to the reading to obtain power at the EUT antenna terminal. The EUT Output Power was set to maximum to produce the worse case test result.

### 7.2. Test Setup Layout

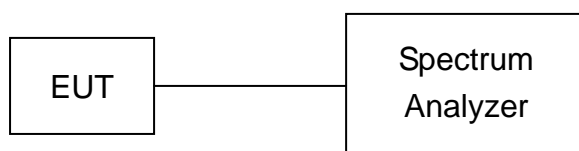

### 7.3. Measurement equipment

Instrument/Ancillary	Model No.	Manufacturer	Serial No.	Valid Date.
Spectrum Analyzer	FSP40	R&S	100047	2007/01/16

### 7.4. Test Result and Data

Transmit Rate: 54Mbps

Test Date: Apr. 29, 2006    Temperature: 25    Humidity: 68%    Atmospheric pressure: 1014 hPa

Channel	Frequency (MHz)	Peak Power Output (dBm)	Peak Power Output (mW)	26dB Occupied Bandwidth (MHz)
1	5180	15.88	38.7	19.5
4	5240	15.97	39.5	19.5
5	5260	15.97	39.5	19.5
8	5320	15.99	39.7	19.3

Peak Transmit Power

Channel 01:

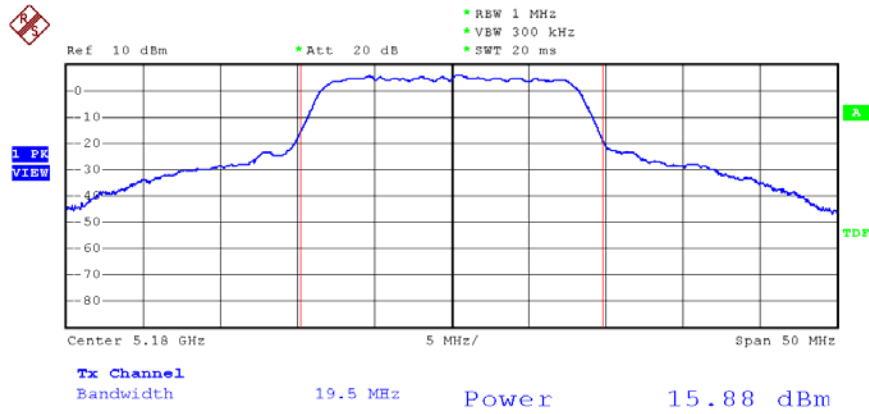

Date: 1.MAY.2006 12:03:33

Channel 04:

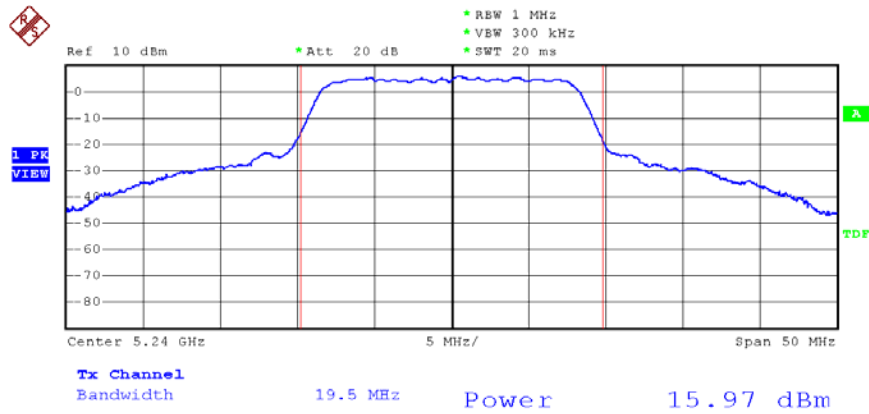

Date: 1.MAY.2006 12:02:23

Channel 05:

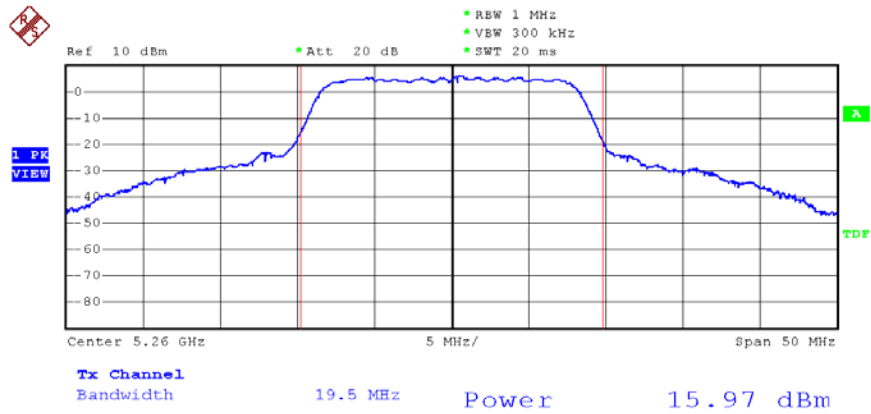

Date: 1.MAY.2006 12:00:46

Channel 08:

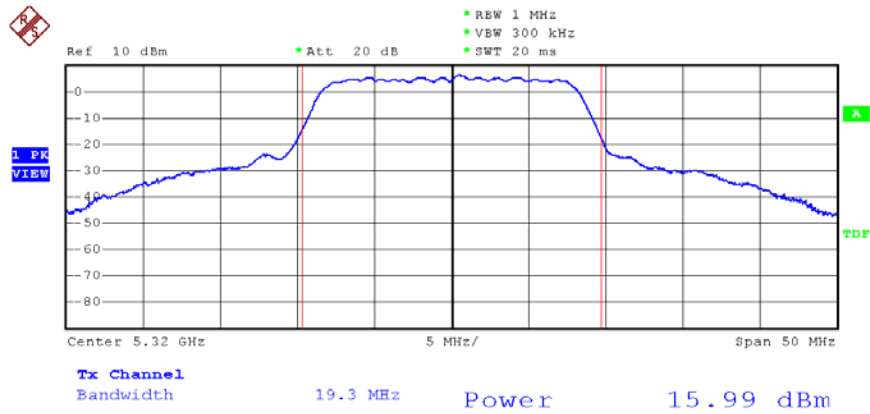

Date: 1.MAY.2006 11:57:33

26dB Occupied Bandwidth (MHz)

Channel 01:

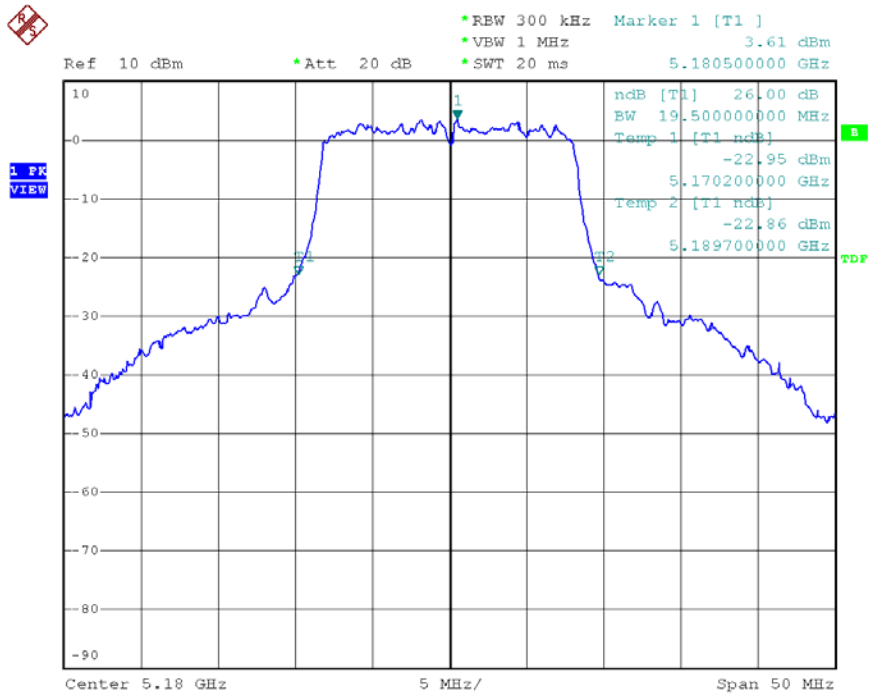

Date: 1.MAY.2006 12:03:10

Channel 04:

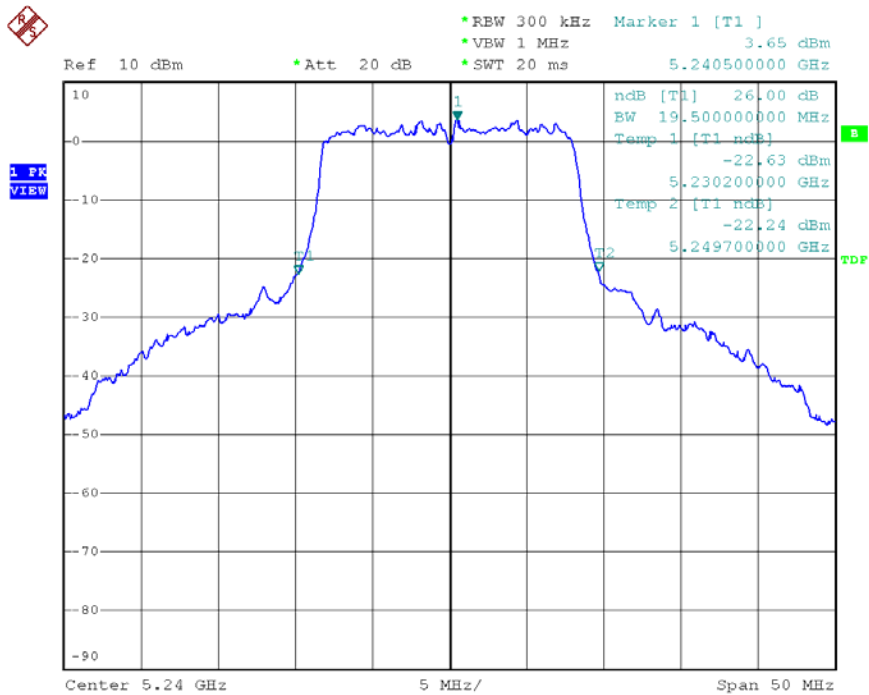

Date: 1.MAY.2006 12:01:57



Channel 05:

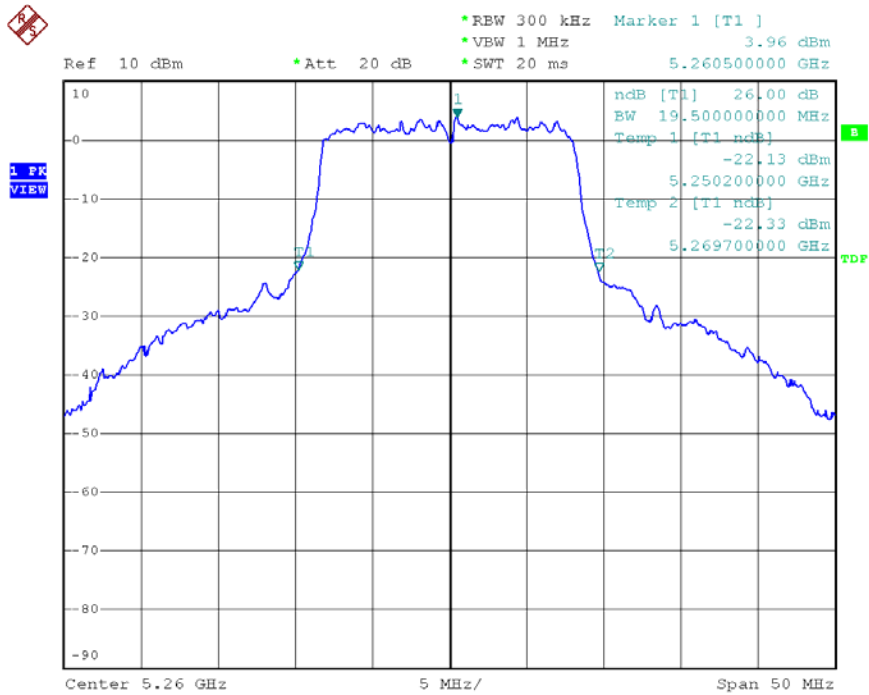

Date: 1.MAY.2006 11:59:49

Channel 08:

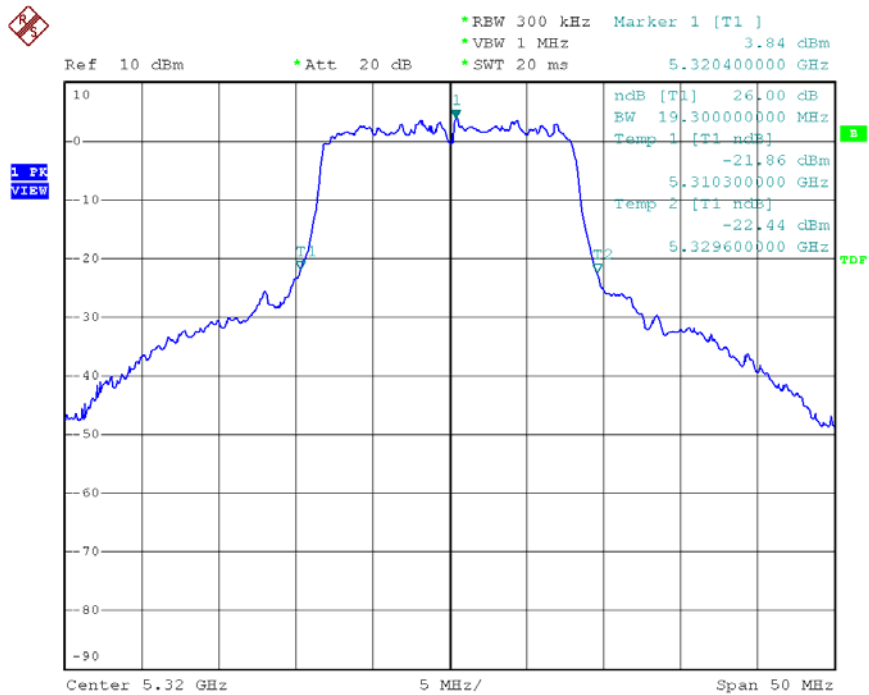

Date: 1.MAY.2006 11:56:36

## 8. Peak Power Excursion

### 8.1. Test Procedure

- a. The transmitter output was connected to the spectrum analyzer
- b. Using Peak detector and max-hold function for Trace 1 MHz and VBW to 3 MHz for Trace 1.
- c. Set RBW of spectrum analyzer to 1 MHz and VBW to 3 MHz for Trace 1.
- d. Set RBW of spectrum analyzer to 1 MHz and VBW to 300 kHz for Trace 2.
- e. The largest difference between Trace 1 and Trace 2 in any 1 MHz band on any frequency was recorded.

### 8.2. Test Setup Layout

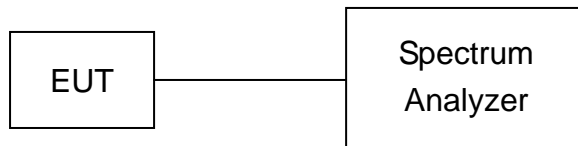

### 8.3. Measurement equipment

Instrument/Ancillary	Model No.	Manufacturer	Serial No.	Valid Date.
Spectrum Analyzer	FSP40	R&S	100047	2007/01/16

### 8.4. Test Result and Data

Transmit Rate: 54Mbps

Test Date: Apr. 29, 2006    Temperature: 25    Humidity: 68%    Atmospheric pressure: 1014 hPa

Channel	Frequency (MHz)	Peak Power Excursion (dBm)
1	5180	7.83
4	5240	7.28
5	5260	7.29
8	5320	7.52

Channel 01:

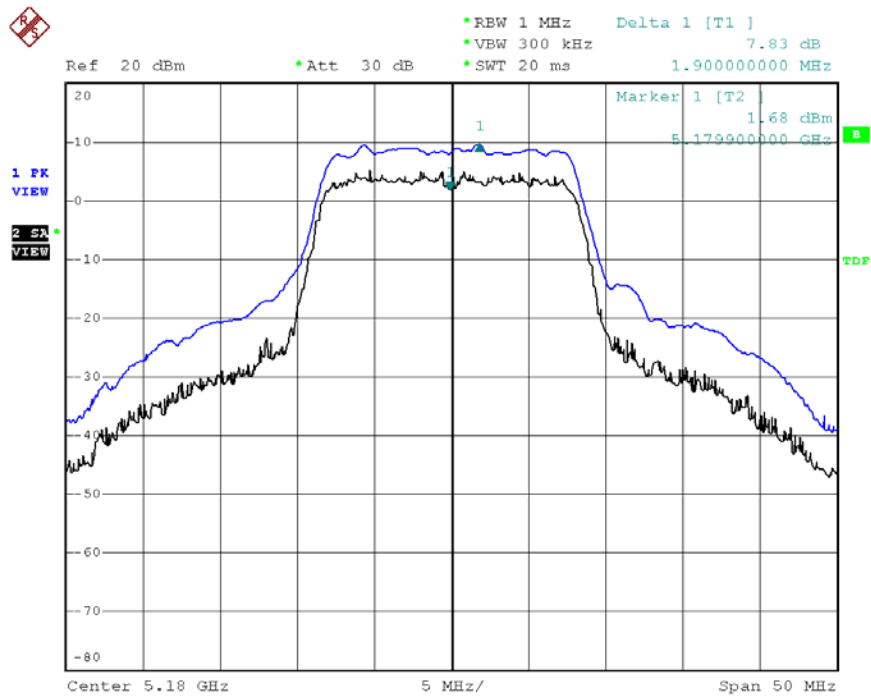

Date: 1.MAY.2006 13:06:22

Channel 04:

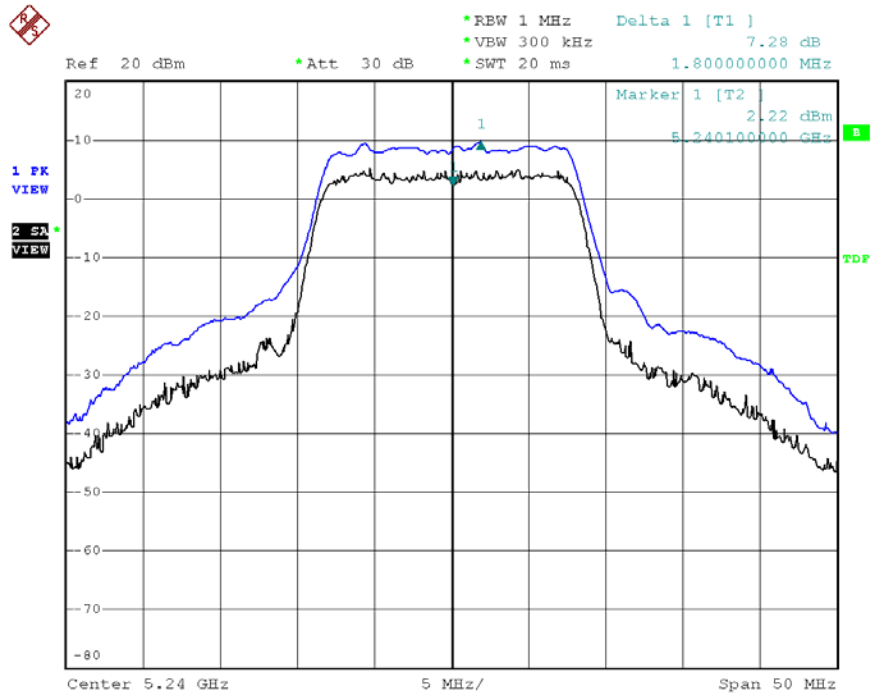

Date: 1.MAY.2006 13:08:38

Channel 05:

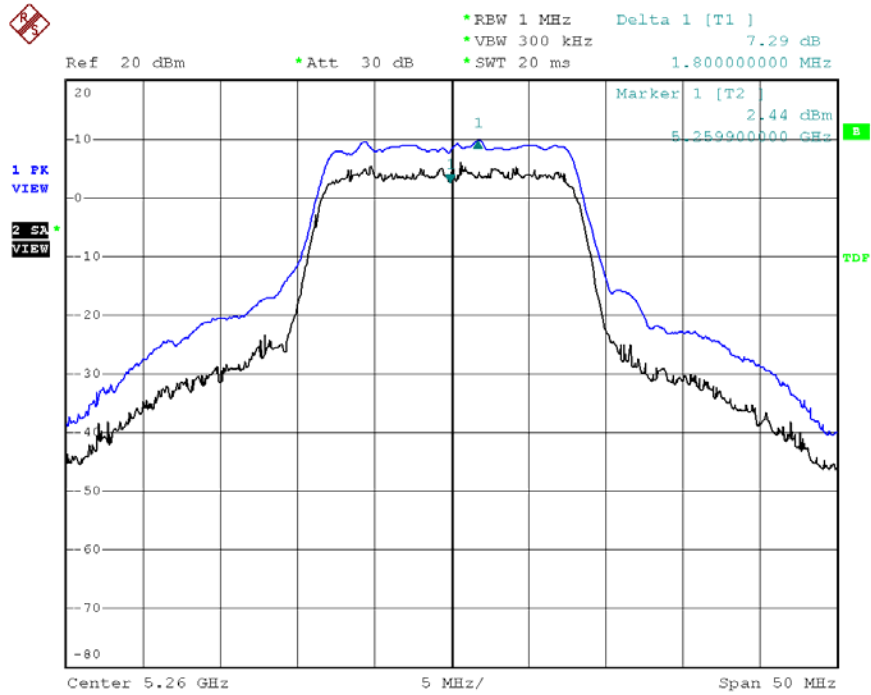

Date: 1.MAY.2006 13:11:12

Channel 08:

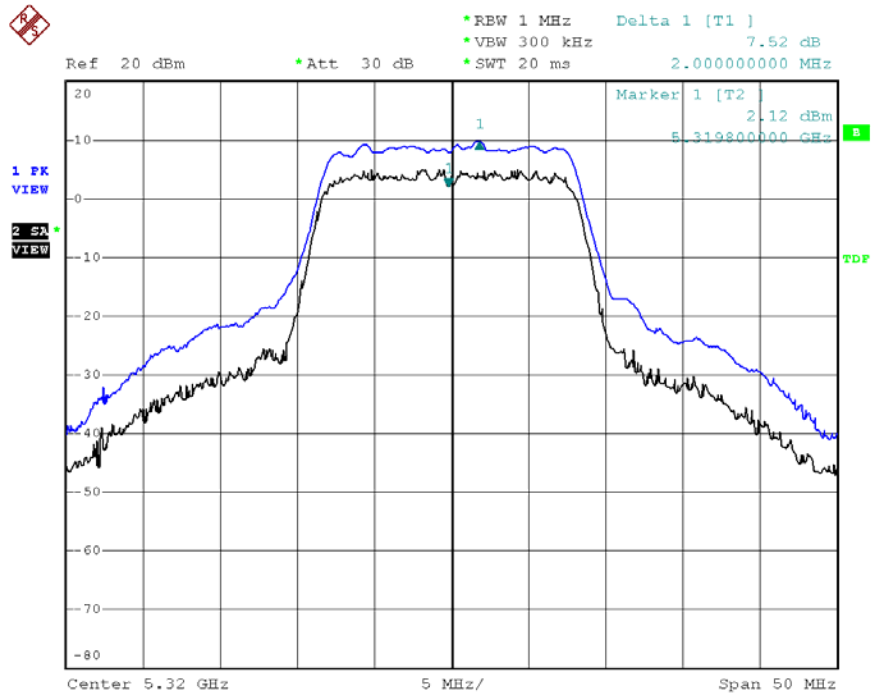

Date: 1.MAY.2006 13:13:07

## 9. Peak Power Spectral Density

### 9.1. Test Procedure

- a. The transmitter output was connected to spectrum analyzer.
- b. Set RBW of spectrum analyzer to 1 MHz and VBW to 3 MHz
- c. The Peak Power Spectral Density is the highest level found across the emission in any 1MHz Band

### 9.2. Test Setup Layout

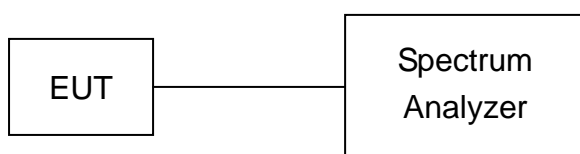

### 9.3. Measurement equipment

Instrument/Ancillary	Model No.	Manufacturer	Serial No.	Valid Date.
Spectrum Analyzer	FSP40	R&S	100047	2007/01/16

### 9.4. Test Result and Data

Transmit Rate: 54Mbps

Test Date: Apr. 29, 2006    Temperature: 25    Humidity: 68%    Atmospheric pressure: 1014 hPa

Channel	Frequency (MHz)	RF Power Level In 1MHz BW (dBm)
1	5180	3.46
4	5240	3.24
5	5260	3.13
8	5320	2.88

Channel 01:

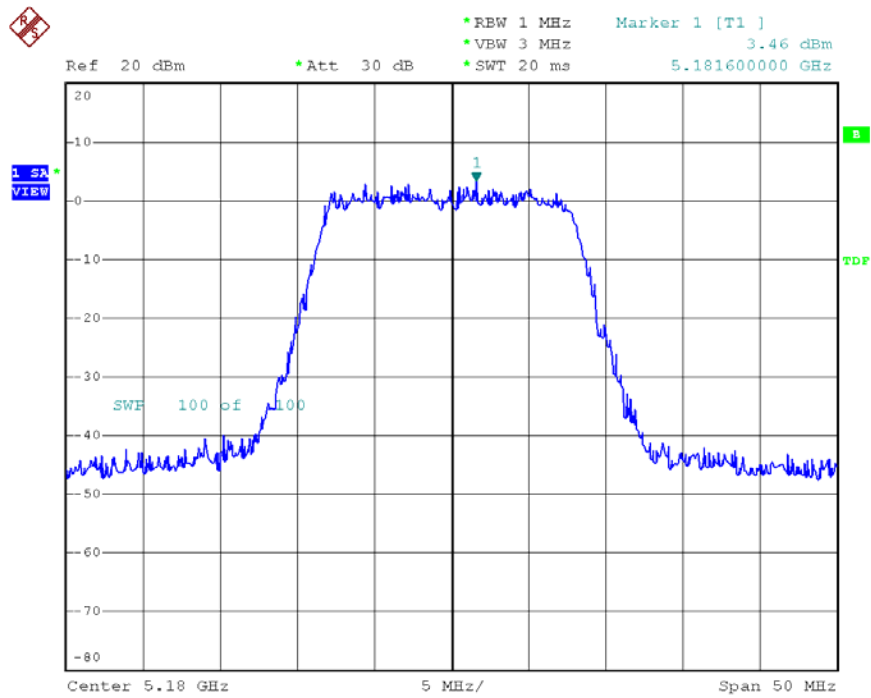

Date: 1.MAY.2006 13:22:13

Channel 04:

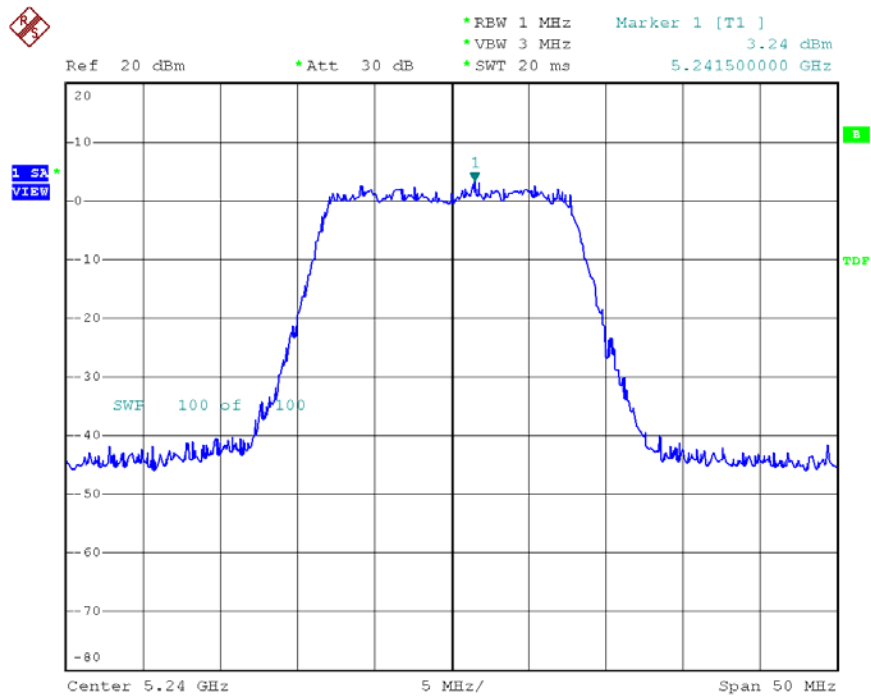

Date: 1.MAY.2006 13:23:40

Channel 05:

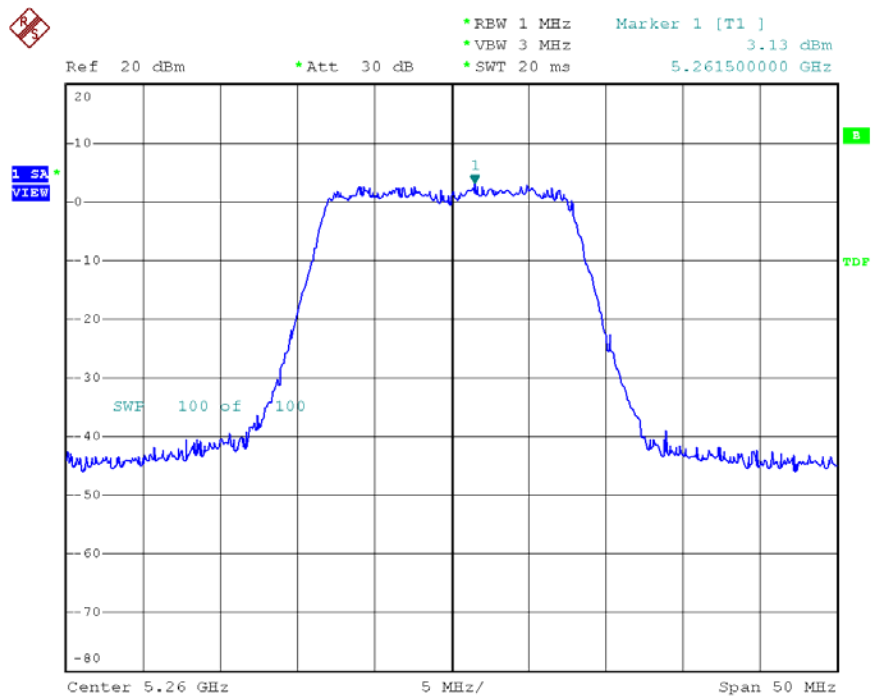

Date: 1.MAY.2006 13:24:52

Channel 08:

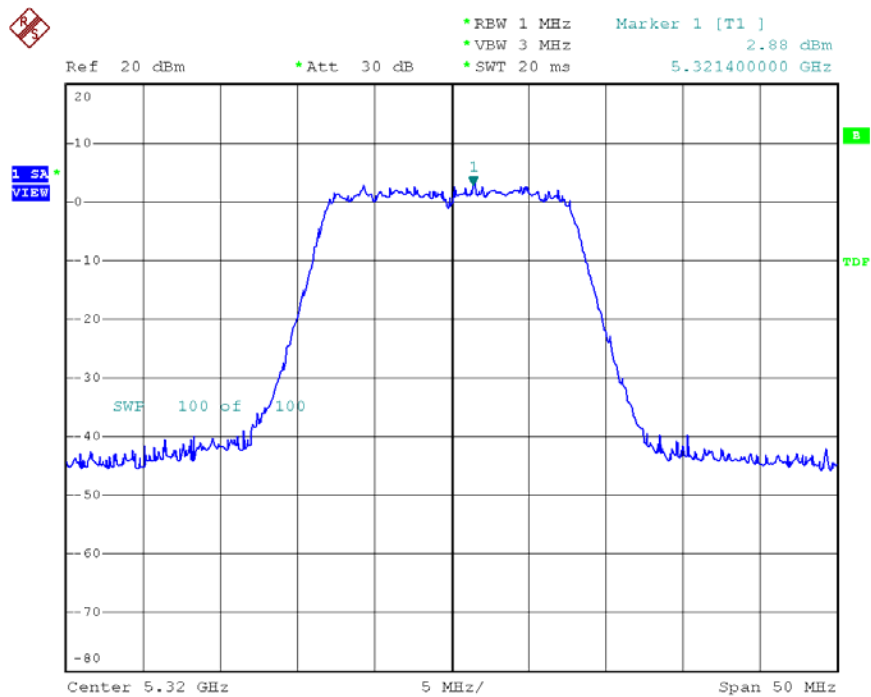

Date: 1.MAY.2006 13:25:52

## 10. Frequency Stability

### 10.1. Test Procedure

- a. The EUT was placed inside the Temperature and Humidity chamber.
- b. The transmitter output was connected to spectrum analyzer.
- c. Turn the EUT on and couple its output to a spectrum analyzer.
- d. Turn the EUT off and set the chamber to the highest temperature specified.
- e. Allow sufficient time (approximately 30 min) for the temperature of the chamber to stabilize, turn the EUT on and measure the operating frequency after 2, 5, and 10 minutes.
- f. Repeat step 2 and 3 with the temperature chamber set to the lowest temperature.
- g. The test chamber was allowed to stabilize at +20 degree C for a minimum of 30 minutes. The supply voltage was then adjusted on the EUT from 85% to 115% and the frequency record.

### 10.2. Test Setup Layout

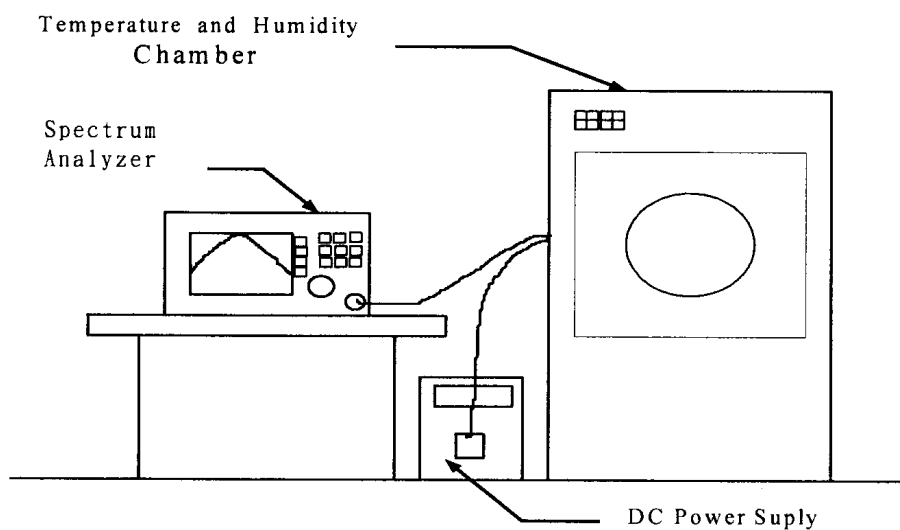

### 10.3. Measurement equipment

Instrument/Ancillary	Model No.	Manufacturer	Serial No.	Valid Date.
Spectrum Analyzer	FSP40	R&S	100047	2007/01/16
TEMPERATURE CHAMBER	TMJ-9712	T MACHINE	T-12-040111	2007/02/16
DC Power Supply	GPD-3030	GM	7020936	N/A
AC POWER CONVERTER	AFC-11005	APC	F103120008	N/A



## 10.4. Test Result and Data

Operating frequency: 5320 MHz							
Temp (°C)	Power supply (V)	2 minute		5 minute		10 minute	
		(MHz)	(%)	(MHz)	(%)	(MHz)	(%)
50	102	5319.9855	-0.000273	5319.9808	-0.000361	5319.9802	-0.000372
	120	5319.9392	-0.001143	5319.999	-0.000019	5319.9826	-0.000327
	138	5319.9386	-0.001154	5319.99	-0.000188	5319.9882	-0.000222
40	102	5319.9388	-0.001150	5319.9664	-0.000632	5319.9884	-0.000218
	120	5319.9492	-0.000955	5319.97	-0.000564	5319.9884	-0.000218
	138	5319.945	-0.001034	5319.9774	-0.000425	5319.9888	-0.000211
30	102	5319.949	-0.000959	5319.9806	-0.000365	5319.9484	-0.000970
	120	5319.976	-0.000451	5319.9822	-0.000335	5319.9484	-0.000970
	138	5319.9484	-0.000970	5319.9488	-0.000962	5319.9884	-0.000218
20	102	5319.9384	-0.001158	5319.9392	-0.001143	5319.9664	-0.000632
	120	5319.9884	-0.000218	5319.9386	-0.001154	5319.97	-0.000564
	138	5319.9482	-0.000974	5319.9388	-0.001150	5319.9774	-0.000425
10	102	5319.97	-0.000564	5319.9492	-0.000955	5319.9806	-0.000365
	120	5319.9488	-0.000962	5319.945	-0.001034	5319.9822	-0.000335
	138	5319.9392	-0.001143	5319.949	-0.000959	5319.94	-0.001128
0	102	5319.9386	-0.001154	5319.976	-0.000451	5319.9734	-0.000500
	120	5319.9706	-0.000553	5319.9706	-0.000553	5319.969	-0.000583
	138	5319.9674	-0.000613	5319.9672	-0.000617	5319.9664	-0.000632
-10	102	5319.977	-0.000432	5319.9774	-0.000425	5319.97	-0.000564
	120	5319.978	-0.000414	5319.978	-0.000414	5319.9774	-0.000425
	138	5319.9392	-0.001143	5319.9792	-0.000391	5319.9806	-0.000365
-20	102	5319.9664	-0.000632	5319.982	-0.000338	5319.9822	-0.000335
	120	5319.97	-0.000564	5319.9812	-0.000353	5319.98	-0.000376
	138	5319.9774	-0.000425	5319.924	-0.001429	5319.9838	-0.000305
-30	102	5319.9806	-0.000365	5319.989	-0.000207	5319.9852	-0.000278
	120	5319.9822	-0.000335	5319.9844	-0.000293	5319.989	-0.000207
	138	5319.976	-0.000451	5319.9842	-0.000297	5319.995	-0.000094

Limit :

Manufacturers of U-NII devices are responsible for ensuring frequency stability such that an emission is maintained within the band of operation under all conditions of normal operation as specified in the users manual.

## 11. Band Edges Measurement

### 11.1. Test Procedure

- a. The transmitter output was connected to the spectrum analyzer via a low lose cable.
- b. Set both RBW and VBW of spectrum analyzer to 100 KHz with convenient frequency span including 100 MHz bandwidth from band edge.
- c. The band edges was measured and recorded..

### 11.2. Measurement equipment

Instrument/Ancillary	Model No.	Manufacturer	Serial No.	Valid Date
EMI Receiver	8546A	HP	3807A00454	2007/04/13
Spectrum Analyzer	FSP40	R&S	100047	2007/01/16
Horn Antenna	3115	EMCO	31589	2007/02/12
Horn Antenna	3116	EMCO	31970	2007/02/09
Bilog Antenna	CBL6112B	Schaffner	2840	2007/04/19
Amplifier	8449B	Agilent	3008A01954	2007/01/08
Amplifier	8447D	Agilent	2944A10531	2006/08/09
Amplifier	PA-840	COM-POWER	711885	2006/08/10

### 11.3. Test Result and Data

Transmit Rate: 54Mbps

Test Date: Apr. 29, 2006    Temperature: 25    Humidity: 68%    Atmospheric pressure: 1014 hPa

Channel	Frequency (MHz)	Maximum Value In Frequency (MHz)	Maximum Value (dBm)
1	5180	5143.60	-41.76
8	5320	5356.40	-42.21

Channel 01:

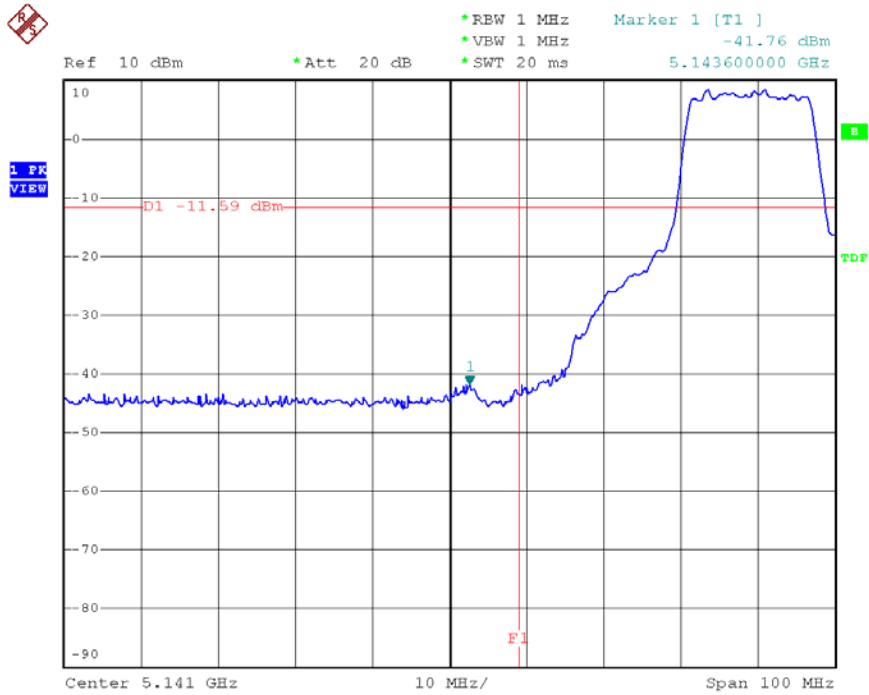

Date: 1.MAY.2006 13:34:09

Channel 08:

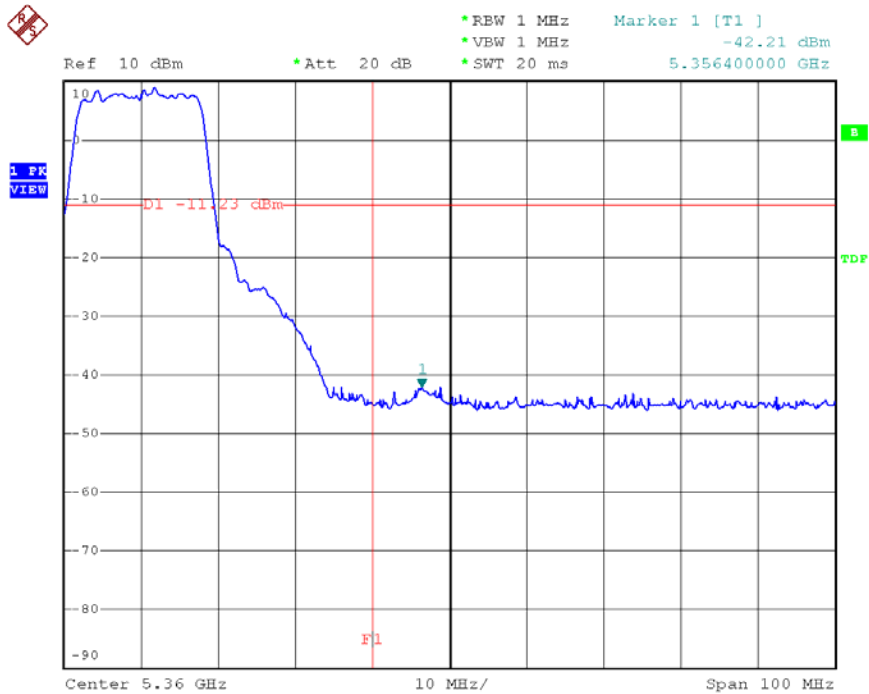

Date: 1.MAY.2006 13:32:27

**11.4. Restrict Band Emission Measurement Data**

Transmit Rate: 54Mbps

Test Date: Apr. 29, 2006    Temperature: 24    Humidity: 70%    Atmospheric pressure: 1015 hPa

Channel 01, Fundamental Frequency: 5180 MHz

Frequency (MHz)	Ant-Pol H/V	Meter Reading (dBuV)		Corrected Factor (dB)	Result (dBuV/m)		Limit (dBuV/m)		Margin (dB)	Table Deg.	Ant High (m)
		Peak	Ave		Peak	Ave	Peak	Ave			
5149.875	H	45.97	34.13	6.56	52.53	40.69	74	54	-13.31	200	1.2
5149.875	V	52.86	41.02	6.56	59.42	47.58	74	54	-6.42	188	1.0

Channel 08, Fundamental Frequency: 5320 MHz

Frequency (MHz)	Ant-Pol H/V	Meter Reading (dBuV)		Corrected Factor (dB)	Result (dBuV/m)		Limit (dBuV/m)		Margin (dB)	Table Deg.	Ant High (m)
		Peak	Ave		Peak	Ave	Peak	Ave			
5395.667	H	46.20	34.97	7.15	53.35	42.12	74	54	-11.88	200	1.2
5395.667	V	53.05	41.84	7.15	60.20	48.99	74	54	-5.01	188	1.0

Notes:

1. Result = Meter Reading + Factor
2. Factor = Antenna Factor + Cable Loss – Amplifier
3. The resolution bandwidth of test receiver/spectrum analyzer is 1MHz and video bandwidth is 3 MHz for Peak detection at frequency above 1GHz.
4. The resolution bandwidth of test receiver/spectrum analyzer is 1MHz and video bandwidth is 10 MHz for Average detection at frequency above 1GHz.

## 12. Restricted Bands of Operation

Only spurious emissions are permitted in any of the frequency bands listed below:

MHz	MHz	MHz	GHz
0.09000 – 0.11000	16.42000 – 16.42300	399.9 – 410.0	4.500 – 5.250
0.49500 – 0.505**	16.69475 – 16.69525	608.0 – 614.0	5.350 – 5.460
2.17350 – 2.19050	16.80425 – 16.80475	960.0 – 1240.0	7.250 – 7.750
4.12500 – 4.12800	25.50000 – 25.67000	1300.0 – 1427.0	8.025 – 8.500
4.17725 – 4.17775	37.50000 – 38.25000	1435.0 – 1626.5	9.000 – 9.200
4.20725 – 4.20775	73.00000 – 74.60000	1645.5 – 1646.5	9.300 – 9.500
6.21500 – 6.21800	74.80000 – 75.20000	1660.0 – 1710.0	10.600 – 12.700
6.26775 – 6.26825	108.00000 – 121.94000	1718.8 – 1722.2	13.250 – 13.400
6.31175 – 6.31225	123.00000 – 138.00000	2200.0 – 2300.0	14.470 – 14.500
8.29100 – 8.29400	149.90000 – 150.05000	2310.0 – 2390.0	15.350 – 16.200
8.36200 – 8.36600	156.52475 – 156.52525	2483.5 – 2500.0	17.700 – 21.400
8.37625 – 8.38675	156.70000 – 156.90000	2655.0 – 2900.0	22.010 – 23.120
8.41425 – 8.41475	162.01250 – 167.17000	3260.0 – 3267.0	23.600 – 24.000
12.29000 – 12.29300	167.72000 – 173.20000	3332.0 – 3339.0	31.200 – 31.800
12.51975 – 12.52025	240.00000 – 285.00000	3345.8 – 3358.0	36.430 – 36.500
12.57675 – 12.57725	322.00000 – 335.40000	3600.0 – 4400.0	Above 38.6
13.36000 – 13.41000			

\*\* : Until February 1, 1999, this restricted band shall be 0.490-0.510 MHz

### 12.1. Labeling Requirement

The device shall bear the following statement in a conspicuous location on the device:

This device complies with part 15 of the FCC Rules. Operation is subject to the following two conditions: (1) This device may not cause harmful interference, and (2) this device must accept any interference received, including interference that may cause undesired operation.