

25.0 x 7.0 x 0.5 (mm) Wi-Fi Dual Band PCB Antenna with Cable (AA258) Engineering Specification

1. Explanation of Product Number

H	2	B	1	P	C	1	A	1	C	x	x	x	x
				(1)	(2)	(3)	(4)	(5)					



Product Code

- (1) Product Applications:
P: WiFi dual band antenna dipole type
- (2) Dimensions:
C1: 25.0 x 7.0 x 0.5 (mm)
- (3) Material:
A: GF
- (4) Working Frequencies:
1C: 2400~2484 & 5150~5850 MHz
- (5) Antenna Series:
xx: serial number



詠業科技股份有限公司
Unictron Technologies Corporation
Website: www.unictron.com

THIS DRAWINGS AND SPECIFICATIONS ARE THE PROPERTY OF UNICTRON TECHNOLOGIES CORPORATION AND SHALL NOT BE REPRODUCED OR USED AS THE BASIS FOR THE MANUFACTURE OR SALE OF APPARATUS OR DEVICES WITHOUT PERMISSION

Prepared by : **Sandy** Designed by : **Gavin** Checked by : **Mike Yang** Approved by : **Herbert**

TITLE : 25.0 x 7.0 x 0.5 (mm) Wi-Fi Dual Band PCB Antenna with Cable (AA258) Engineering Specification

DOCUMENT NO.

H2B1PC1A1Cxxxx

REV.
A

2. Features

- *Stable and reliable in performances
- *Compact size
- *RoHS 2.0 compliance

3. Applications

- * IEEE802.11(a/b/g/n/ac).
- * Hand-held devices when IEEE802.11(a/b/g/n/ac) functions are needed.

4. Description

Unictron's PCB antenna with cable series are specially designed for IEEE802.11(a/b/g/n/ac) applications. Based on Unictron's proprietary design and processes, this antenna has excellent stability and sensitivity to consistently provide high signal reception efficiency.

5. Operating Condition:

Temperature	-10 to +85 °C	(With double-sided tape)
	- 40 to +85 °C	(Without double-sided tape)
Humidity	10 to 95% RH	

6. Storage Condition:

Temperature	-10 to +85 °C	(With double-sided tape)
	- 40 to +85 °C	(Without double-sided tape)
Humidity	10 to 95% RH	



詠業科技股份有限公司
Unictron Technologies Corporation
Website:www.unictron.com

THIS DRAWINGS AND SPECIFICATIONS ARE THE PROPERTY OF UNICTRON TECHNOLOGIES CORPORATION AND SHALL NOT BE REPRODUCED OR USED AS THE BASIS FOR THE MANUFACTURE OR SALE OF APPARATUS OR DEVICES WITHOUT PERMISSION

Prepared by : **Sandy** Designed by : **Gavin** Checked by : **Mike Yang** Approved by : **Herbert**

TITLE : 25.0 x 7.0 x 0.5 (mm) Wi-Fi Dual Band PCB Antenna with Cable (AA258) Engineering Specification

DOCUMENT NO.

H2B1PC1A1Cxxxx

REV.
A

7. Electrical Specifications

(Antenna is attached on a 2.0mm-thick ABS +PC material plate)

7-1. 2400~2484 MHz Band

Characteristics		Specifications	Unit
Outline Dimensions		25.0 x 7.0 x 0.5	mm
Working Frequency (Center Frequency)		2400~2484 (2442)	MHz
Bandwidth		100Min.(typical)	MHz
VSWR(@Center Frequency)*		2Max. (typical)	
Impedance		50	Ω
Polarization		Linear Polarization	
Peak Gain	(@2442MHz)	2.9 (typical)	dBi
Efficiency		56.9 (typical)	%

*Center frequency will be offset to another frequency according to the conditions of user's ground plane and radome.

*Bandwidth & VSWR are tested at Unictron test environment.

7-2. Peak Gain at 2400~2484 MHz Band

Length	Gain(dBi)	Loss	Total
50mm	2.9	0.23	2.67
100mm	2.9	0.36	2.54
150mm	2.9	0.58	2.32
200mm	2.9	0.66	2.24
250mm	2.9	0.8	2.1
300mm	2.9	0.95	1.95



詠業科技股份有限公司
Unictron Technologies Corporation
Website: www.unictron.com

THIS DRAWINGS AND SPECIFICATIONS ARE THE PROPERTY OF UNICTRON TECHNOLOGIES CORPORATION AND SHALL NOT BE REPRODUCED OR USED AS THE BASIS FOR THE MANUFACTURE OR SALE OF APPARATUS OR DEVICES WITHOUT PERMISSION

Prepared by : **Sandy**

Designed by : **Gavin**

Checked by : **Mike Yang**

Approved by : **Herbert**

**TITLE : 25.0 x 7.0 x 0.5 (mm) Wi-Fi Dual Band PCB Antenna
with Cable (AA258) Engineering Specification**

**DOCUMENT
NO.**

H2B1PC1A1Cxxxx

REV.

A

7-3. 5150~5250 MHz Band

Characteristics		Specifications	Unit
Working Frequency (Center Frequency)		5150~5250 (5200)	MHz
Bandwidth		700Min.(typical)	MHz
VSWR(@Center Frequency)*		2Max. (typical)	
Impedance		50	Ω
Polarization		Linear Polarization	
Peak Gain	(@5200MHz)	4.0 (typical)	dBi
Efficiency		66.2 (typical)	%

* Center frequency will be offset to another frequency according to the conditions of user's ground plane and radome.

*Bandwidth &VSWR are tested at Unictron test environment.

7-4 Peak Gain at 5150~5250 MHz Band

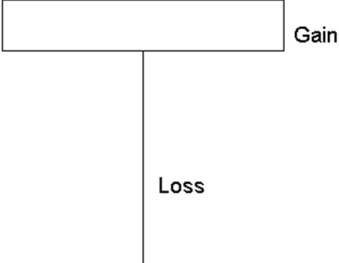
	Length	Gain(dBi)	Loss	Total
	50mm	4.0	0.78	3.22
	100mm	4.0	1.02	2.98
	150mm	4.0	1.23	2.77
	200mm	4.0	1.64	2.36
	250mm	4.0	1.68	2.32
	300mm	4.0	2.27	1.73



詠業科技股份有限公司
Unictron Technologies Corporation
Website:www.unictron.com

THIS DRAWINGS AND SPECIFICATIONS ARE THE PROPERTY OF UNICTRON TECHNOLOGIES CORPORATION AND SHALL NOT BE REPRODUCED OR USED AS THE BASIS FOR THE MANUFACTURE OR SALE OF APPARATUS OR DEVICES WITHOUT PERMISSION

Prepared by : **Sandy**

Designed by : **Gavin**

Checked by : **Mike Yang**

Approved by : **Herbert**

TITLE : 25.0 x 7.0 x 0.5 (mm) Wi-Fi Dual Band PCB Antenna with Cable (AA258) Engineering Specification

DOCUMENT NO.

H2B1PC1A1Cxxxx

REV. A

7-5. 5250~5350 MHz Band

Characteristics		Specifications	Unit
Working Frequency (Center Frequency)		5250~5350 (5300)	MHz
Bandwidth		700Min.(typical)	MHz
VSWR(@Center Frequency)*		2Max. (typical)	
Impedance		50	Ω
Polarization		Linear Polarization	
Peak Gain	(@5300MHz)	4.9 (typical)	dBi
Efficiency		76.3 (typical)	%

* Center frequency will be offset to another frequency according to the conditions of user's ground plane and radome.

*Bandwidth &VSWR are tested at Unictron test environment.

7-6 Peak Gain at 5250~5350 MHz Band

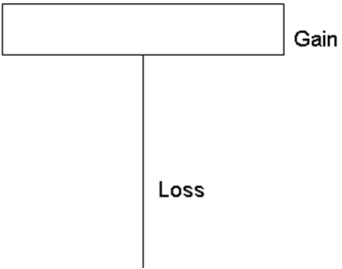
	Length	Gain(dBi)	Loss	Total
	50mm	4.9	0.99	3.91
	100mm	4.9	1.16	3.74
	150mm	4.9	1.49	3.41
	200mm	4.9	1.79	3.11
	250mm	4.9	1.87	3.03
	300mm	4.9	2.34	2.56



詠業科技股份有限公司
Unictron Technologies Corporation
Website:www.unictron.com

THIS DRAWINGS AND SPECIFICATIONS ARE THE PROPERTY OF UNICTRON TECHNOLOGIES CORPORATION AND SHALL NOT BE REPRODUCED OR USED AS THE BASIS FOR THE MANUFACTURE OR SALE OF APPARATUS OR DEVICES WITHOUT PERMISSION

Prepared by : **Sandy**

Designed by : **Gavin**

Checked by : **Mike Yang**

Approved by : **Herbert**

TITLE : 25.0 x 7.0 x 0.5 (mm) Wi-Fi Dual Band PCB Antenna with Cable (AA258) Engineering Specification

DOCUMENT NO.

H2B1PC1A1Cxxxx

REV. A

7-7. 5470~5725 MHz Band

Characteristics		Specifications	Unit
Working Frequency (Center Frequency)		5470~5725 (5600)	MHz
Bandwidth		700Min.(typical)	MHz
VSWR(@Center Frequency)*		2Max. (typical)	
Impedance		50	Ω
Polarization		Linear Polarization	
Peak Gain	(@5600MHz)	4.0 (typical)	dBi
Efficiency		70.1 (typical)	%

* Center frequency will be offset to another frequency according to the conditions of user's ground plane and radome.

*Bandwidth &VSWR are tested at Unictron test environment.

7-8 Peak Gain at 5470~5725 MHz Band

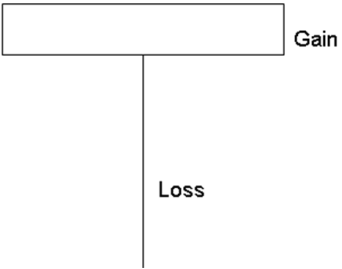
	Length	Gain(dBi)	Loss	Total
	50mm	4.0	1.18	2.77
	100mm	4.0	1.34	2.61
	150mm	4.0	1.50	2.45
	200mm	4.0	1.87	2.08
	250mm	4.0	1.90	2.05
	300mm	4.0	2.31	1.64



詠業科技股份有限公司
Unictron Technologies Corporation
Website:www.unictron.com

THIS DRAWINGS AND SPECIFICATIONS ARE THE PROPERTY OF UNICTRON TECHNOLOGIES CORPORATION AND SHALL NOT BE REPRODUCED OR USED AS THE BASIS FOR THE MANUFACTURE OR SALE OF APPARATUS OR DEVICES WITHOUT PERMISSION

Prepared by : **Sandy**

Designed by : **Gavin**

Checked by : **Mike Yang**

Approved by : **Herbert**

TITLE : 25.0 x 7.0 x 0.5 (mm) Wi-Fi Dual Band PCB Antenna with Cable (AA258) Engineering Specification

DOCUMENT NO.

H2B1PC1A1Cxxxx

REV. A

7-9. 5725~5850 MHz Band

Characteristics		Specifications	Unit
Working Frequency (Center Frequency)		5725~5850 (5790)	MHz
Bandwidth		700Min.(typical)	MHz
VSWR(@Center Frequency)*		2Max. (typical)	
Impedance		50	Ω
Polarization		Linear Polarization	
Peak Gain	(@5790MHz)	5.0 (typical)	dBi
Efficiency		67.8 (typical)	%

* Center frequency will be offset to another frequency according to the conditions of user's ground plane and radome.

*Bandwidth &VSWR are tested at Unictron test environment.

7-10 Peak Gain at 5725~5850 MHz Band

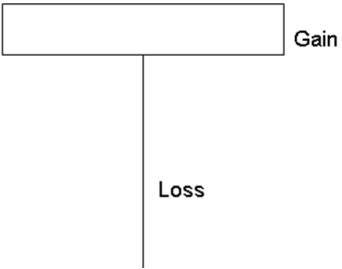
	Length	Gain(dBi)	Loss	Total
	50mm	5.6	1.63	3.92
	100mm	5.6	1.67	3.88
	150mm	5.6	1.92	3.63
	200mm	5.6	2.1	3.45
	250mm	5.6	2.47	3.08
	300mm	5.6	2.83	2.72



詠業科技股份有限公司
Unictron Technologies Corporation
Website:www.unictron.com

THIS DRAWINGS AND SPECIFICATIONS ARE THE PROPERTY OF UNICTRON TECHNOLOGIES CORPORATION AND SHALL NOT BE REPRODUCED OR USED AS THE BASIS FOR THE MANUFACTURE OR SALE OF APPARATUS OR DEVICES WITHOUT PERMISSION

Prepared by : **Sandy**

Designed by : **Gavin**

Checked by : **Mike Yang**

Approved by : **Herbert**

TITLE : 25.0 x 7.0 x 0.5 (mm) Wi-Fi Dual Band PCB Antenna with Cable (AA258) Engineering Specification

DOCUMENT NO.

H2B1PC1A1Cxxxx

REV. A

7-11. 5850~5895 MHz Band

Characteristics		Specifications	Unit
Working Frequency (Center Frequency)		5850~5895 (5870)	MHz
Bandwidth		700Min.(typical)	MHz
VSWR(@Center Frequency)*		2Max. (typical)	
Impedance		50	Ω
Polarization		Linear Polarization	
Peak Gain	(@5870MHz)	6.0 (typical)	dBi
Efficiency		76.2 (typical)	%

* Center frequency will be offset to another frequency according to the conditions of user's ground plane and radome.

*Bandwidth &VSWR are tested at Unictron test environment.

7-12 Peak Gain at 5850~5895 MHz Band

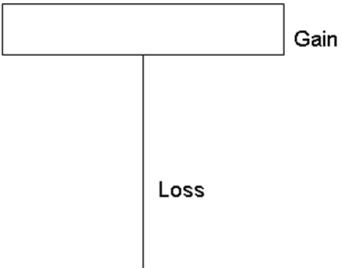
	Length	Gain(dBi)	Loss	Total
	50mm	6.0	1.57	4.4
	100mm	6.0	1.58	4.39
	150mm	6.0	1.89	4.08
	200mm	6.0	1.92	4.05
	250mm	6.0	2.32	3.65
	300mm	6.0	2.51	3.46



詠業科技股份有限公司
Unictron Technologies Corporation
Website:www.unictron.com

THIS DRAWINGS AND SPECIFICATIONS ARE THE PROPERTY OF UNICTRON TECHNOLOGIES CORPORATION AND SHALL NOT BE REPRODUCED OR USED AS THE BASIS FOR THE MANUFACTURE OR SALE OF APPARATUS OR DEVICES WITHOUT PERMISSION

Prepared by : **Sandy**

Designed by : **Gavin**

Checked by : **Mike Yang**

Approved by : **Herbert**

TITLE : 25.0 x 7.0 x 0.5 (mm) Wi-Fi Dual Band PCB Antenna with Cable (AA258) Engineering Specification

DOCUMENT NO.

H2B1PC1A1Cxxxx

REV. A

7-13. 5925~6425 MHz Band

Characteristics		Specifications	Unit
Working Frequency (Center Frequency)		5925~6425 (6175)	MHz
Bandwidth		700Min.(typical)	MHz
VSWR(@Center Frequency)*		2Max. (typical)	
Impedance		50	Ω
Polarization		Linear Polarization	
Peak Gain	(@6175MHz)	5.2 (typical)	dBi
Efficiency		48.3 (typical)	%

* Center frequency will be offset to another frequency according to the conditions of user's ground plane and radome.

*Bandwidth &VSWR are tested at Unictron test environment.

7-14 Peak Gain at 5925~6425 MHz Band

Length	Gain(dBi)	Loss	Total
50mm	5.2	1.61	3.59
100mm	5.2	1.67	3.53
150mm	5.2	1.92	3.28
200mm	5.2	2.1	3.1
250mm	5.2	2.47	2.73
300mm	5.2	2.83	2.37



詠業科技股份有限公司
Unictron Technologies Corporation
Website:www.unictron.com

THIS DRAWINGS AND SPECIFICATIONS ARE THE PROPERTY OF UNICTRON TECHNOLOGIES CORPORATION AND SHALL NOT BE REPRODUCED OR USED AS THE BASIS FOR THE MANUFACTURE OR SALE OF APPARATUS OR DEVICES WITHOUT PERMISSION

Prepared by : **Sandy**

Designed by : **Gavin**

Checked by : **Mike Yang**

Approved by : **Herbert**

TITLE : 25.0 x 7.0 x 0.5 (mm) Wi-Fi Dual Band PCB Antenna with Cable (AA258) Engineering Specification

DOCUMENT NO.

H2B1PC1A1Cxxxx

REV. A

7-15. 6425~6525 MHz Band

Characteristics		Specifications	Unit
Working Frequency (Center Frequency)		6425~6525 (6475)	MHz
Bandwidth		700Min.(typical)	MHz
VSWR(@Center Frequency)*		2Max. (typical)	
Impedance		50	Ω
Polarization		Linear Polarization	
Peak Gain	(@6475 Hz)	5.0 (typical)	dBi
Efficiency		46.5 (typical)	%

* Center frequency will be offset to another frequency according to the conditions of user's ground plane and radome.

*Bandwidth &VSWR are tested at Unictron test environment.

7-16 Peak Gain at 6425~6525 MHz Band

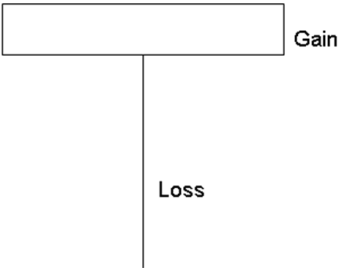
	Length	Gain(dBi)	Loss	Total
	50mm	5.4	1.72	3.63
	100mm	5.4	1.7	3.65
	150mm	5.4	2.15	3.2
	200mm	5.4	2.3	3.05
	250mm	5.4	2.5	2.85
	300mm	5.4	2.86	2.49



詠業科技股份有限公司
Unictron Technologies Corporation
Website:www.unictron.com

THIS DRAWINGS AND SPECIFICATIONS ARE THE PROPERTY OF UNICTRON TECHNOLOGIES CORPORATION AND SHALL NOT BE REPRODUCED OR USED AS THE BASIS FOR THE MANUFACTURE OR SALE OF APPARATUS OR DEVICES WITHOUT PERMISSION

Prepared by : **Sandy**

Designed by : **Gavin**

Checked by : **Mike Yang**

Approved by : **Herbert**

TITLE : 25.0 x 7.0 x 0.5 (mm) Wi-Fi Dual Band PCB Antenna with Cable (AA258) Engineering Specification

DOCUMENT NO.

H2B1PC1A1Cxxxx

REV. A

7-17. 6525~6875 MHz Band

Characteristics		Specifications	Unit
Working Frequency (Center Frequency)		6525~6875 (6700)	MHz
Bandwidth		700Min.(typical)	MHz
VSWR(@Center Frequency)*		2Max. (typical)	
Impedance		50	Ω
Polarization		Linear Polarization	
Peak Gain	(@6700MHz)	4.1 (typical)	dBi
Efficiency		52.4 (typical)	%

* Center frequency will be offset to another frequency according to the conditions of user's ground plane and radome.

*Bandwidth &VSWR are tested at Unictron test environment.

7-18 Peak Gain at 6525~6875 MHz Band

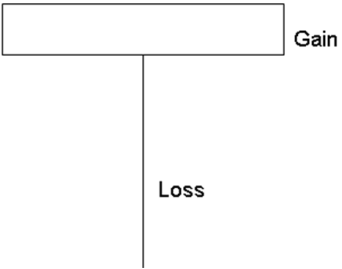
	Length	Gain(dBi)	Loss	Total
	50mm	4.1	1.75	2.33
	100mm	4.1	1.82	2.26
	150mm	4.1	2.22	1.86
	200mm	4.1	2.34	1.74
	250mm	4.1	2.53	1.55
	300mm	4.1	2.78	1.3



詠業科技股份有限公司
Unictron Technologies Corporation
Website:www.unictron.com

THIS DRAWINGS AND SPECIFICATIONS ARE THE PROPERTY OF UNICTRON TECHNOLOGIES CORPORATION AND SHALL NOT BE REPRODUCED OR USED AS THE BASIS FOR THE MANUFACTURE OR SALE OF APPARATUS OR DEVICES WITHOUT PERMISSION

Prepared by : **Sandy**

Designed by : **Gavin**

Checked by : **Mike Yang**

Approved by : **Herbert**

TITLE : 25.0 x 7.0 x 0.5 (mm) Wi-Fi Dual Band PCB Antenna with Cable (AA258) Engineering Specification

DOCUMENT NO.

H2B1PC1A1Cxxxx

REV. A

7-19. 6875~7125 MHz Band

Characteristics		Specifications	Unit
Working Frequency (Center Frequency)		6875~7125 (7000)	MHz
Bandwidth		700Min.(typical)	MHz
VSWR(@Center Frequency)*		2Max. (typical)	
Impedance		50	Ω
Polarization		Linear Polarization	
Peak Gain	(@7000MHz)	3.2 (typical)	dBi
Efficiency		42.3 (typical)	%

* Center frequency will be offset to another frequency according to the conditions of user's ground plane and radome.

*Bandwidth &VSWR are tested at Unictron test environment.

7-20 Peak Gain at 6875~7125 MHz Band

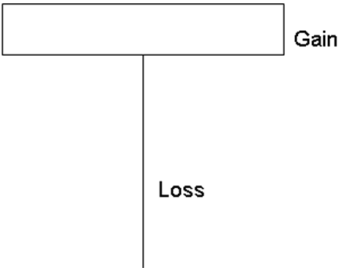
	Length	Gain(dBi)	Loss	Total
	50mm	3.2	1.78	1.37
	100mm	3.2	1.92	1.23
	150mm	3.2	2.35	0.8
	200mm	3.2	2.41	0.74
	250mm	3.2	2.76	0.39
	300mm	3.2	3.21	-0.06



詠業科技股份有限公司
Unictron Technologies Corporation
Website:www.unictron.com

THIS DRAWINGS AND SPECIFICATIONS ARE THE PROPERTY OF UNICTRON TECHNOLOGIES CORPORATION AND SHALL NOT BE REPRODUCED OR USED AS THE BASIS FOR THE MANUFACTURE OR SALE OF APPARATUS OR DEVICES WITHOUT PERMISSION

Prepared by : **Sandy**

Designed by : **Gavin**

Checked by : **Mike Yang**

Approved by : **Herbert**

TITLE : 25.0 x 7.0 x 0.5 (mm) Wi-Fi Dual Band PCB Antenna with Cable (AA258) Engineering Specification

DOCUMENT NO.

H2B1PC1A1Cxxxx

REV. A

7-21. Return Loss & VSWR

Return Loss (S₁₁)

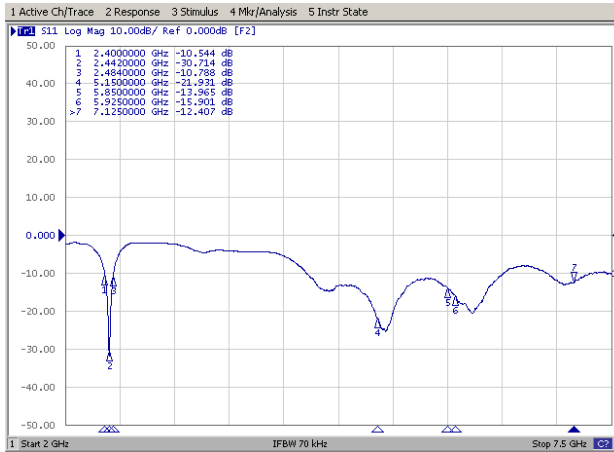

VSWR (S₁₁)

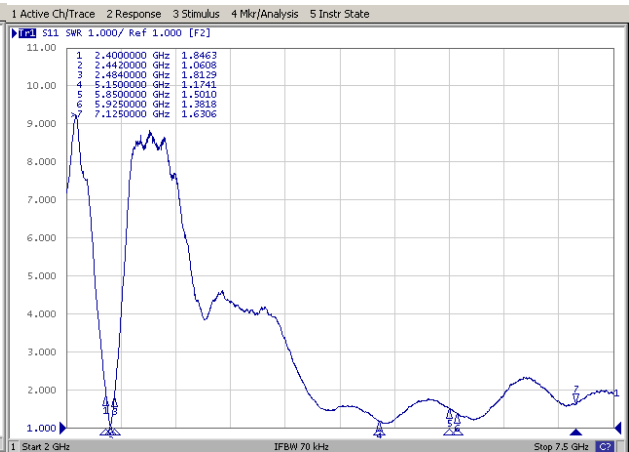

詠業科技股份有限公司
 Unictron Technologies Corporation
 Website: www.unictron.com

THIS DRAWINGS AND SPECIFICATIONS ARE THE PROPERTY OF UNICTRON TECHNOLOGIES CORPORATION AND SHALL NOT BE REPRODUCED OR USED AS THE BASIS FOR THE MANUFACTURE OR SALE OF APPARATUS OR DEVICES WITHOUT PERMISSION

Prepared by : **Sandy**

Designed by : **Gavin**

Checked by : **Mike Yang**

Approved by : **Herbert**

TITLE : 25.0 x 7.0 x 0.5 (mm) Wi-Fi Dual Band PCB Antenna with Cable (AA258) Engineering Specification

DOCUMENT NO.

H2B1PC1A1Cxxxx

REV. A

8. Dimensions of PCB antenna with cable (unit: mm)

8-1 I-PEX (MHF I)

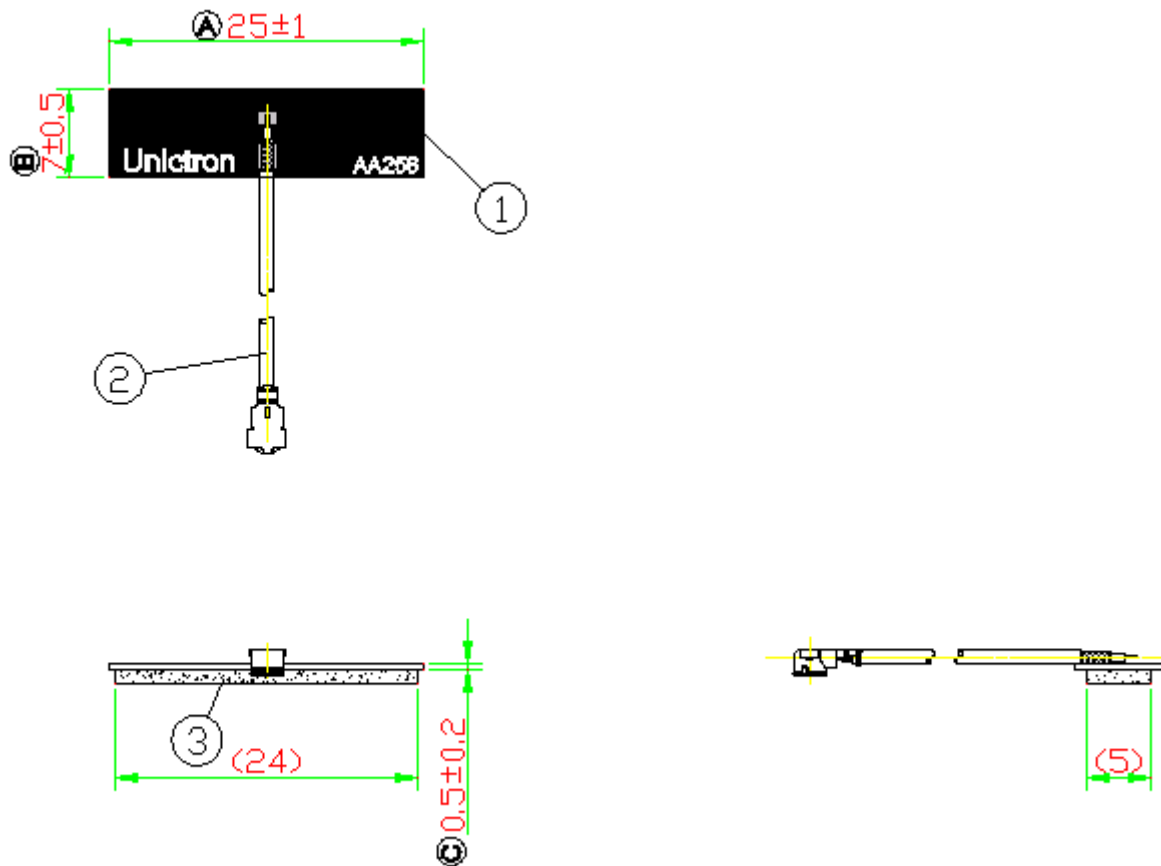

NOTE:

1. All materials are RoHS 2.0 compliant.
2. "A~D" Critical Dimensions.
3. "()" Reference Dimensions.

Item	Name	Material	Color	Q'ty
1	AA258_PCB (25mm*7mm*0.5mm)	FR4	Black	1
2	I-PEX Connector (MHF I) _ Cable1.13mm	FEP	Gray	1
3	Adhesive Tape	PE	Black	1



詠業科技股份有限公司
Unictron Technologies Corporation
Website: www.unictron.com

THIS DRAWINGS AND SPECIFICATIONS ARE THE PROPERTY OF UNICTRON TECHNOLOGIES CORPORATION AND SHALL NOT BE REPRODUCED OR USED AS THE BASIS FOR THE MANUFACTURE OR SALE OF APPARATUS OR DEVICES WITHOUT PERMISSION

Prepared by : Sandy

Designed by : Gavin

Checked by : Mike Yang

Approved by : Herbert

TITLE : 25.0 x 7.0 x 0.5 (mm) Wi-Fi Dual Band PCB Antenna
with Cable (AA258) Engineering Specification

DOCUMENT
NO.

H2B1PC1A1Cxxxx

REV.

A

8-2 I-PEX (MHF 4L)

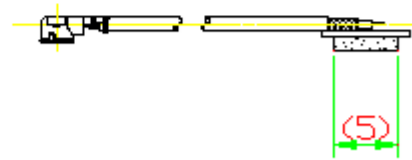
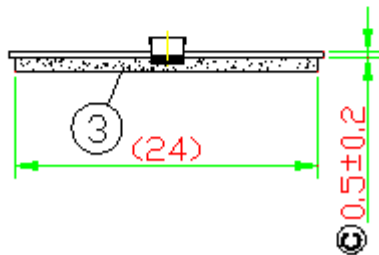
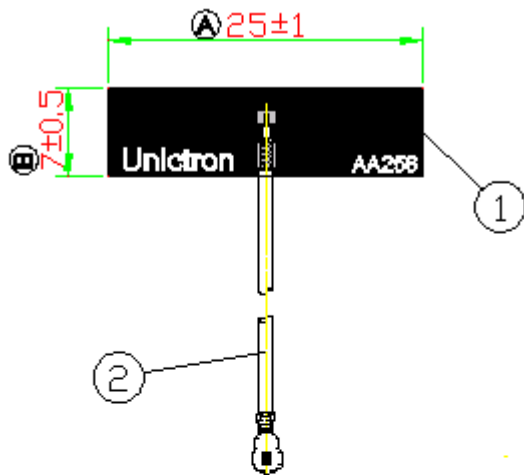

NOTE:

1. All materials are RoHS 2.0 compliant.
2. "A~D" Critical Dimensions.
3. "()" Reference Dimensions.

Item	Name	Material	Color	Q'ty
1	AA258_PCB (25mm*7mm*0.5mm)	FR4	Black	1
2	I-PEX Connector (MHF 4L)_Cable Φ 1.13mm	FEP	Gray	1
3	Adhesive Tape	PE	Black	1



詠業科技股份有限公司
Unictron Technologies Corporation
Website: www.unictron.com

THIS DRAWINGS AND SPECIFICATIONS ARE THE PROPERTY OF UNICTRON TECHNOLOGIES CORPORATION AND SHALL NOT BE REPRODUCED OR USED AS THE BASIS FOR THE MANUFACTURE OR SALE OF APPARATUS OR DEVICES WITHOUT PERMISSION

Prepared by : Sandy

Designed by : Gavin

Checked by : Mike Yang

Approved by : Herbert

TITLE : 25.0 x 7.0 x 0.5 (mm) Wi-Fi Dual Band PCB Antenna
with Cable (AA258) Engineering Specification

DOCUMENT
NO.

H2B1PC1A1Cxxxx

REV.

A

9. Package

9-1. Weight and Quantity:

9-1-1. Unit Weight: 0.7 ± 0.2 (g)

9-1-2. Quantity:

Each PE Bag: 25 pcs

Each Outer Box: 5000 pcs

9-1-3. Total Weight:

N.W.: 3.5 ± 1 kg

G.W.: 4.1 ± 1 kg

Process	Photos	Remark
1		Put 25 pcs in a PE bag and attach label on PE bag.
2		Put 200 PE bags into an outer box with 5,000 pcs of antenna inside.



詠業科技股份有限公司
Unictron Technologies Corporation
Website: www.unictron.com

THIS DRAWINGS AND SPECIFICATIONS ARE THE PROPERTY OF UNICTRON TECHNOLOGIES CORPORATION AND SHALL NOT BE REPRODUCED OR USED AS THE BASIS FOR THE MANUFACTURE OR SALE OF APPARATUS OR DEVICES WITHOUT PERMISSION

Prepared by : **Sandy**

Designed by : **Gavin**

Checked by : **Mike Yang**

Approved by : **Herbert**

TITLE : 25.0 x 7.0 x 0.5 (mm) Wi-Fi Dual Band PCB Antenna with Cable (AA258) Engineering Specification

DOCUMENT NO.

H2B1PC1A1Cxxxx

REV.

A

9-2. Dimensions

9-2-1 Outer Box (605mm*400mm*190mm)

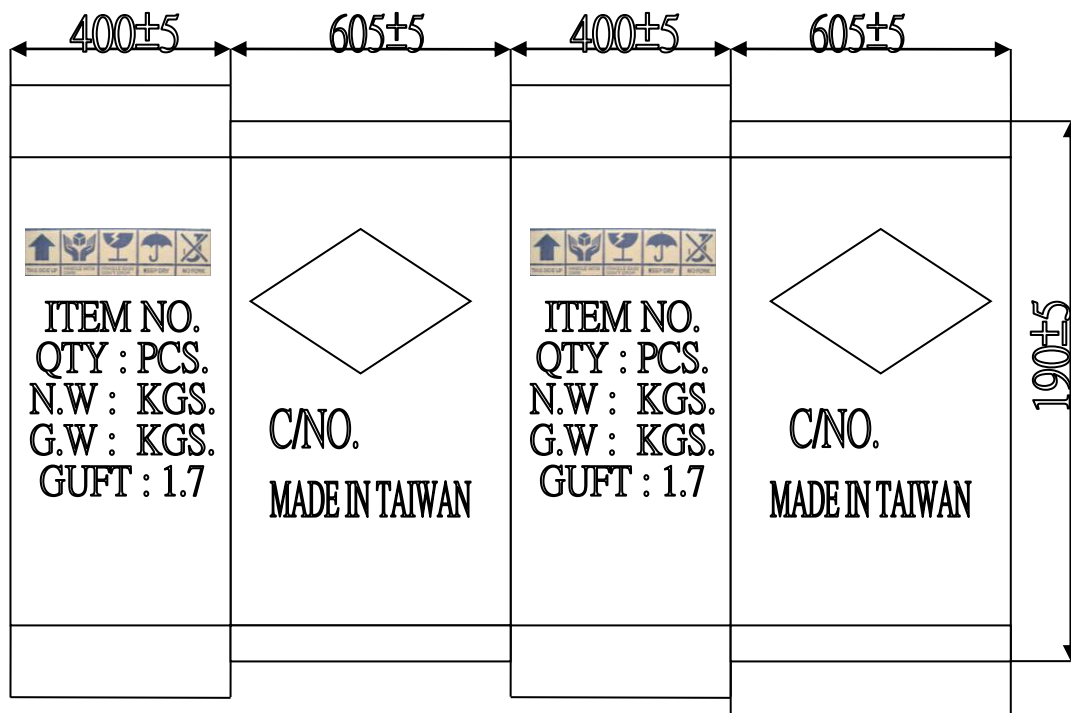

10. Country of Origin

Company Name	Unictron Technologies Corporation
Factory	Second Factory
Postal Code	32556
Country of Origin	Taiwan
Address	5F NO. 83, Kewang Rd., Longtan Dist., Taoyuan City, Taiwan



詠業科技股份有限公司
Unictron Technologies Corporation
Website:www.unictron.com

THIS DRAWINGS AND SPECIFICATIONS ARE THE PROPERTY OF UNICTRON TECHNOLOGIES CORPORATION AND SHALL NOT BE REPRODUCED OR USED AS THE BASIS FOR THE MANUFACTURE OR SALE OF APPARATUS OR DEVICES WITHOUT PERMISSION

Prepared by : **Sandy**

Designed by : **Gavin**

Checked by : **Mike Yang**

Approved by : **Herbert**

TITLE : 25.0 x 7.0 x 0.5 (mm) Wi-Fi Dual Band PCB Antenna with Cable (AA258) Engineering Specification

DOCUMENT NO.

H2B1PC1A1Cxxxx

REV.

A

11. Reference Date

11-1 Measurement Setup

1. Reflection Coefficient Measurement

- (a) Equipment : Network Analyzer(Agilent E5071A) (Fig. 1)
- (b) Item : Impedance、 Return loss、 VSWR



Fig. 1 Network Analyzer

2. Gain Pattern Measurement

- (a) Equipment : Anechoic Chamber, Network Analyzer (Agilent E5071C), Standard Horn. (Fig. 2)
- (b) Item : Gain .

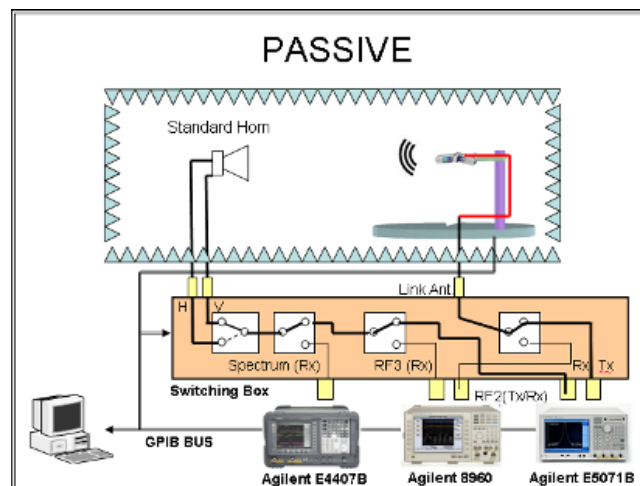

Fig. 2 Anechoic Chamber



詠業科技股份有限公司
 Unictron Technologies Corporation
 Website:www.unictron.com

THIS DRAWINGS AND SPECIFICATIONS ARE THE PROPERTY OF UNICTRON TECHNOLOGIES CORPORATION AND SHALL NOT BE REPRODUCED OR USED AS THE BASIS FOR THE MANUFACTURE OR SALE OF APPARATUS OR DEVICES WITHOUT PERMISSION

Prepared by : **Sandy**

Designed by : **Gavin**

Checked by : **Mike Yang**

Approved by : **Herbert**

TITLE : 25.0 x 7.0 x 0.5 (mm) Wi-Fi Dual Band PCB Antenna with Cable (AA258) Engineering Specification

DOCUMENT NO.

H2B1PC1A1Cxxxx

REV.

A

12. Radiation Pattern

12-1.2400~2484 MHz Band (L=100mm)

12-1-1.3D Gain Pattern @ 2445 MHz (unit: dBi)

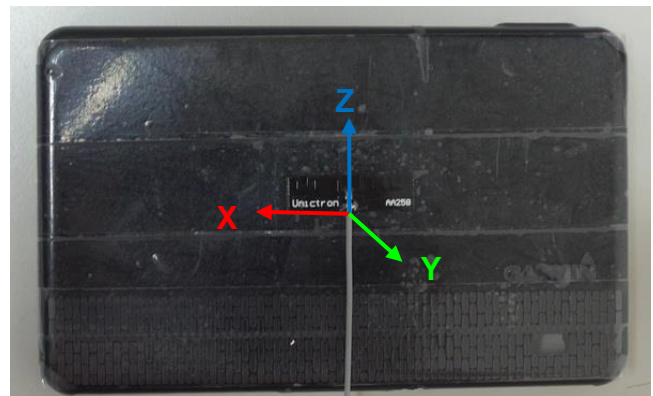
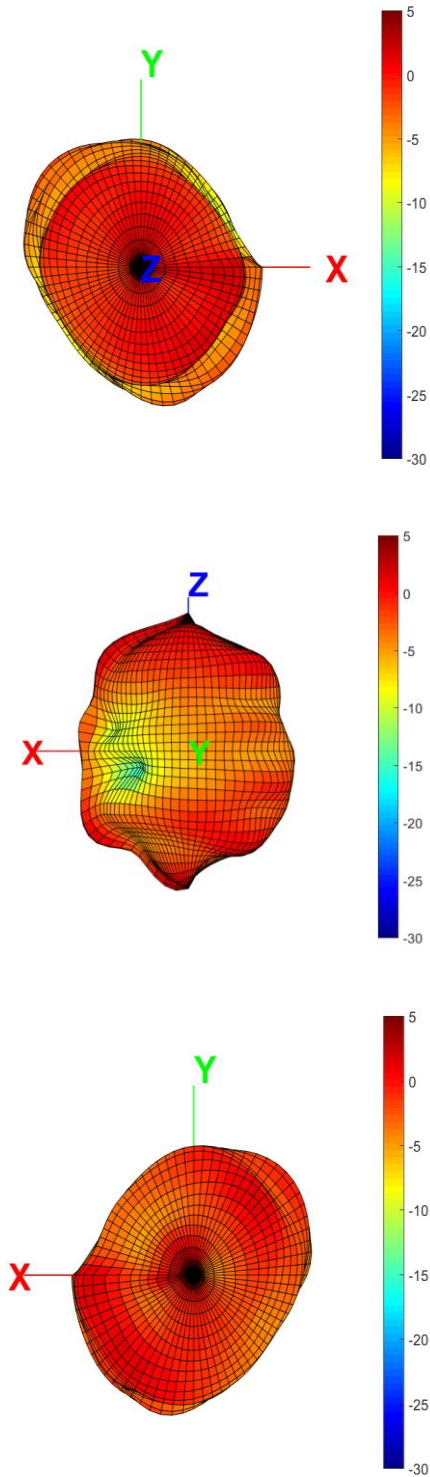

詠業科技股份有限公司
Unictron Technologies Corporation
Website:www.unictron.com

THIS DRAWINGS AND SPECIFICATIONS ARE THE PROPERTY OF UNICTRON TECHNOLOGIES CORPORATION AND SHALL NOT BE REPRODUCED OR USED AS THE BASIS FOR THE MANUFACTURE OR SALE OF APPARATUS OR DEVICES WITHOUT PERMISSION

Prepared by : Sandy

Designed by : Gavin

Checked by : Mike Yang

Approved by : Herbert

TITLE : 25.0 x 7.0 x 0.5 (mm) Wi-Fi Dual Band PCB Antenna with Cable (AA258) Engineering Specification

DOCUMENT NO.

H2B1PC1A1Cxxxx

REV.

A

12.2. 5150~5250 MHz Band (L=100mm)

12-2-1.3D Gain Pattern @ 5200 MHz (unit: dBi)

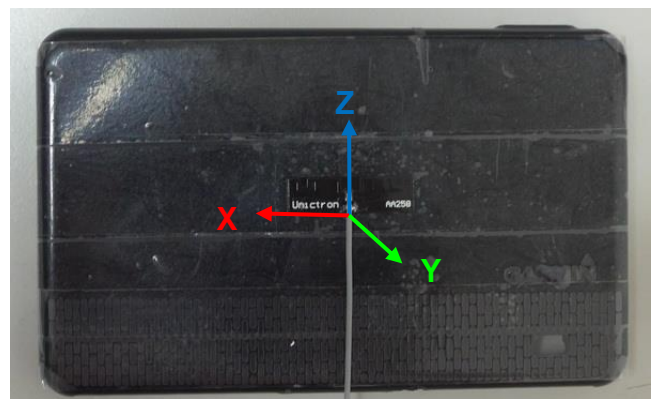
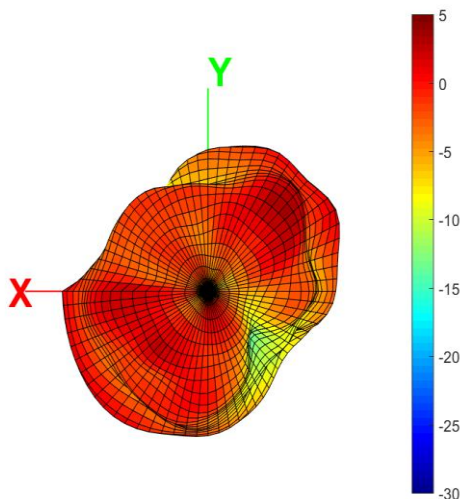
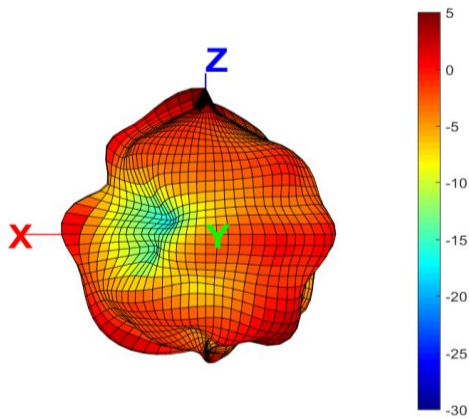
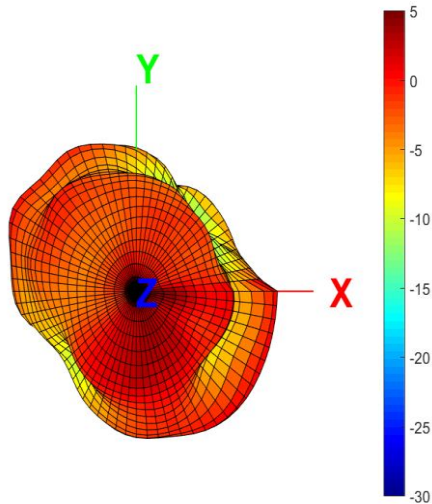

詠業科技股份有限公司
 Unictron Technologies Corporation
 Website:www.unictron.com

THIS DRAWINGS AND SPECIFICATIONS ARE THE PROPERTY OF UNICTRON TECHNOLOGIES CORPORATION AND SHALL NOT BE REPRODUCED OR USED AS THE BASIS FOR THE MANUFACTURE OR SALE OF APPARATUS OR DEVICES WITHOUT PERMISSION

Prepared by : Sandy

Designed by : Gavin

Checked by : Mike Yang

Approved by : Herbert

TITLE : 25.0 x 7.0 x 0.5 (mm) Wi-Fi Dual Band PCB Antenna with Cable (AA258) Engineering Specification

DOCUMENT NO.

H2B1PC1A1Cxxxx

REV. A

12.3. 5250~5350 MHz Band (L=100mm)

12-3-1.3D Gain Pattern @ 5300 MHz (unit: dBi)

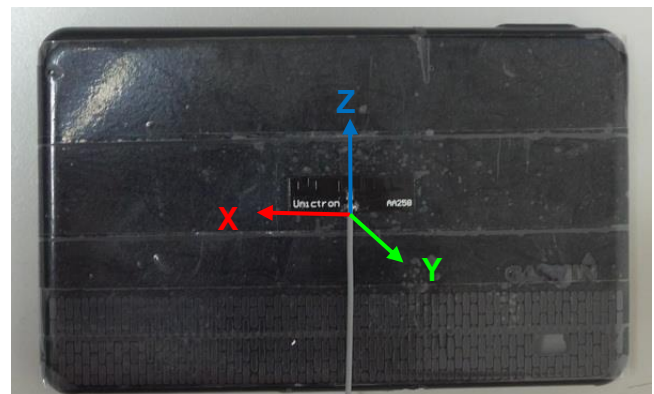
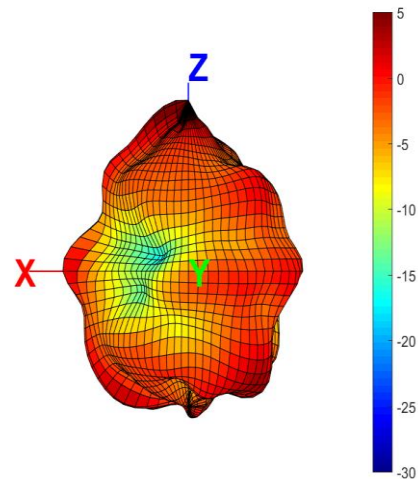
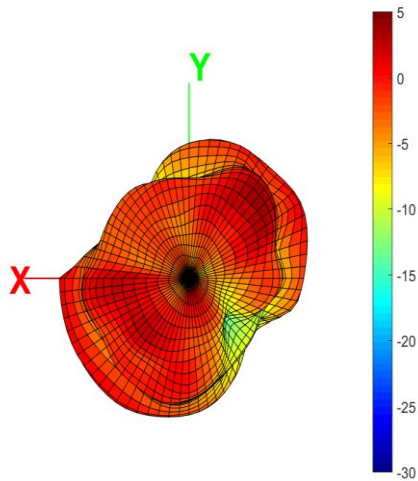
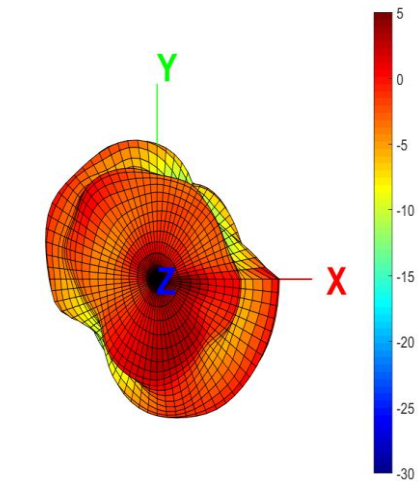

詠業科技股份有限公司
Unictron Technologies Corporation
Website:www.unictron.com

THIS DRAWINGS AND SPECIFICATIONS ARE THE PROPERTY OF UNICTRON TECHNOLOGIES CORPORATION AND SHALL NOT BE REPRODUCED OR USED AS THE BASIS FOR THE MANUFACTURE OR SALE OF APPARATUS OR DEVICES WITHOUT PERMISSION

Prepared by : Sandy

Designed by : Gavin

Checked by : Mike Yang

Approved by : Herbert

TITLE : 25.0 x 7.0 x 0.5 (mm) Wi-Fi Dual Band PCB Antenna with Cable (AA258) Engineering Specification

DOCUMENT NO.

H2B1PC1A1Cxxxx

REV.
A

12.4. 5470~5725 MHz Band (L=100mm)

12-4-1.3D Gain Pattern @ 5600 MHz (unit: dBi)

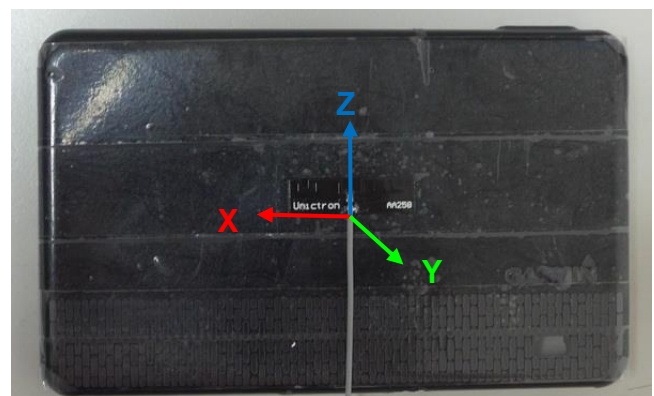
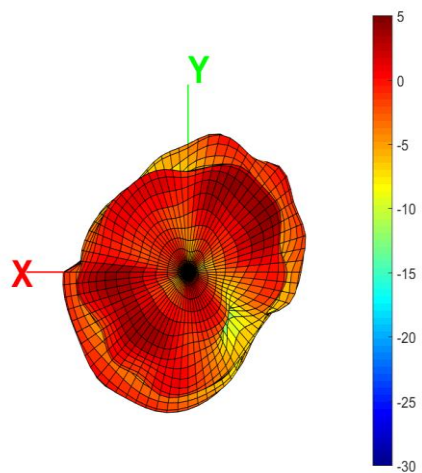
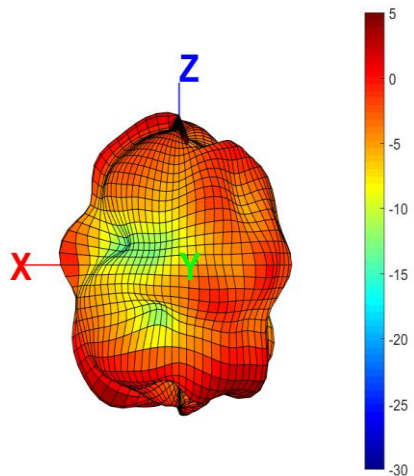
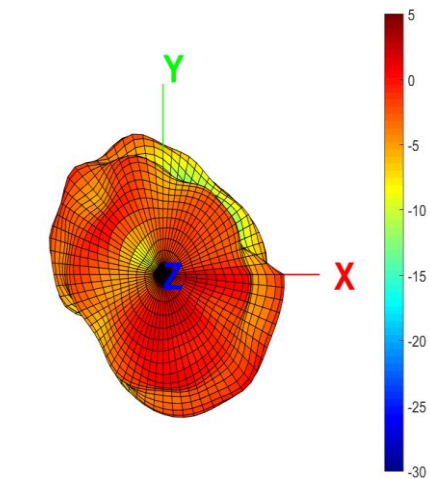

詠業科技股份有限公司
 Unictron Technologies Corporation
 Website: www.unictron.com

THIS DRAWINGS AND SPECIFICATIONS ARE THE PROPERTY OF UNICTRON TECHNOLOGIES CORPORATION AND SHALL NOT BE REPRODUCED OR USED AS THE BASIS FOR THE MANUFACTURE OR SALE OF APPARATUS OR DEVICES WITHOUT PERMISSION

Prepared by : Sandy

Designed by : Gavin

Checked by : Mike Yang

Approved by : Herbert

TITLE : 25.0 x 7.0 x 0.5 (mm) Wi-Fi Dual Band PCB Antenna with Cable (AA258) Engineering Specification

DOCUMENT NO.

H2B1PC1A1Cxxxx

REV.
A

12.5. 5725~5850 MHz Band (L=100mm)

12-5-1.3D Gain Pattern @ 5790 MHz (unit: dBi)

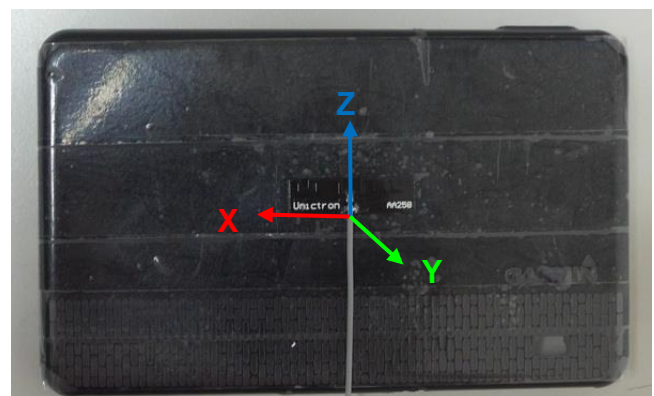
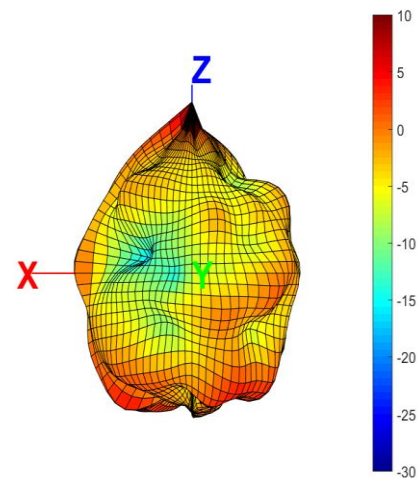
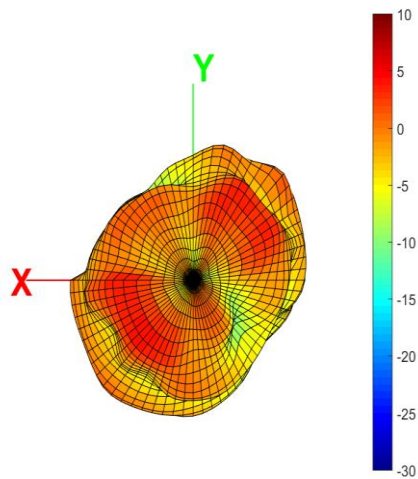
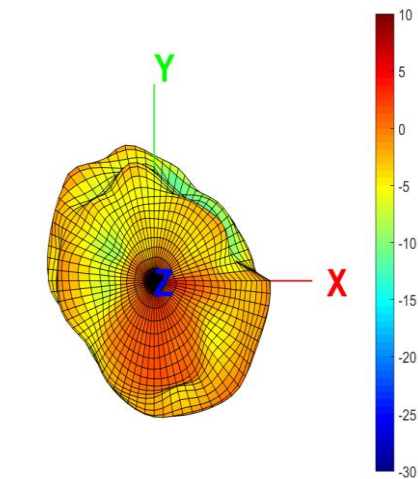

詠業科技股份有限公司
Unictron Technologies Corporation
Website:www.unictron.com

THIS DRAWINGS AND SPECIFICATIONS ARE THE PROPERTY OF UNICTRON TECHNOLOGIES CORPORATION AND SHALL NOT BE REPRODUCED OR USED AS THE BASIS FOR THE MANUFACTURE OR SALE OF APPARATUS OR DEVICES WITHOUT PERMISSION

Prepared by : Sandy

Designed by : Gavin

Checked by : Mike Yang

Approved by : Herbert

TITLE : 25.0 x 7.0 x 0.5 (mm) Wi-Fi Dual Band PCB Antenna with Cable (AA258) Engineering Specification

DOCUMENT NO.

H2B1PC1A1Cxxxx

REV.

A

12.6. 5850~5895 MHz Band (L=100mm)

12-6-1.3D Gain Pattern @ 5870 MHz (unit: dBi)

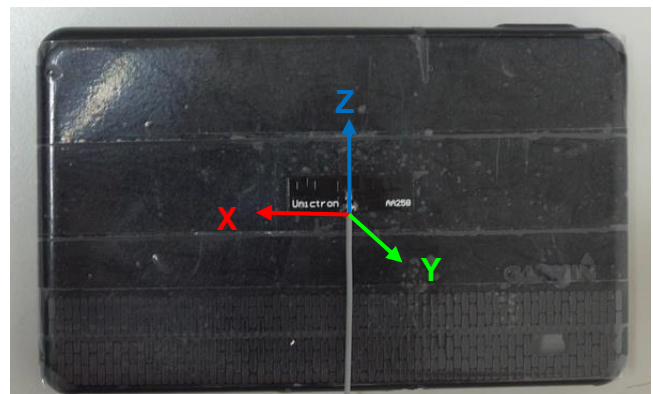
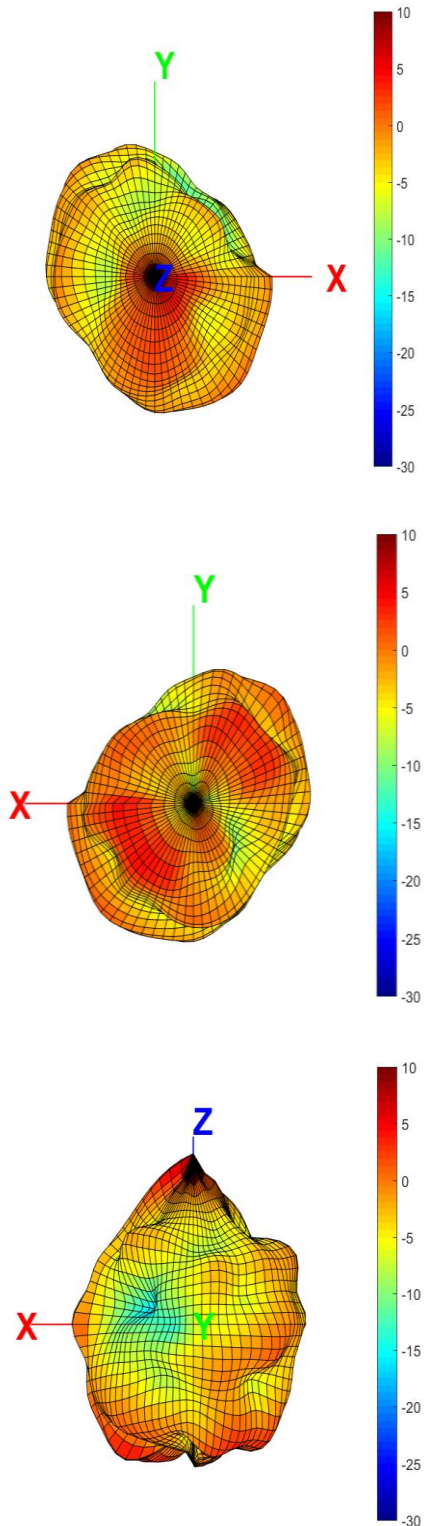

詠業科技股份有限公司
 Unictron Technologies Corporation
 Website: www.unictron.com

THIS DRAWINGS AND SPECIFICATIONS ARE THE PROPERTY OF UNICTRON TECHNOLOGIES CORPORATION AND SHALL NOT BE REPRODUCED OR USED AS THE BASIS FOR THE MANUFACTURE OR SALE OF APPARATUS OR DEVICES WITHOUT PERMISSION

Prepared by : Sandy

Designed by : Gavin

Checked by : Mike Yang

Approved by : Herbert

TITLE : 25.0 x 7.0 x 0.5 (mm) Wi-Fi Dual Band PCB Antenna with Cable (AA258) Engineering Specification

DOCUMENT NO.

H2B1PC1A1Cxxxx

REV.

A

12.7. 5925~6425 MHz Band (L=100mm)

12-7-1.3D Gain Pattern @ 6175 MHz (unit: dBi)

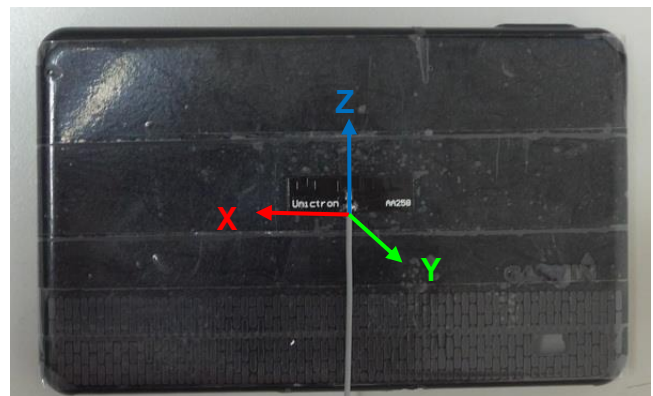
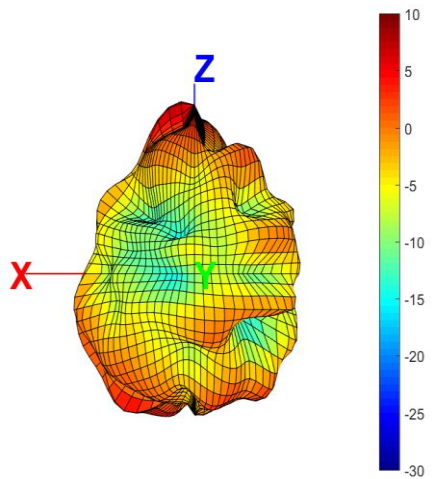
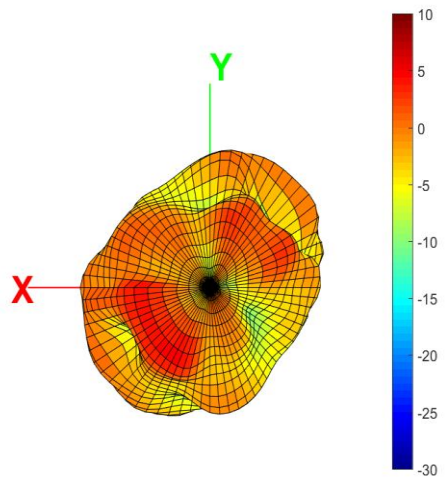
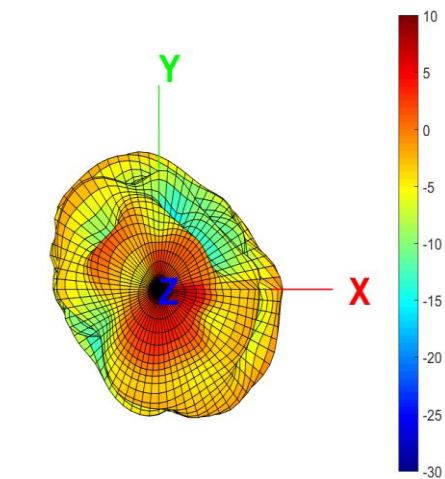

詠業科技股份有限公司
Unictron Technologies Corporation
Website:www.unictron.com

THIS DRAWINGS AND SPECIFICATIONS ARE THE PROPERTY OF UNICTRON TECHNOLOGIES CORPORATION AND SHALL NOT BE REPRODUCED OR USED AS THE BASIS FOR THE MANUFACTURE OR SALE OF APPARATUS OR DEVICES WITHOUT PERMISSION

Prepared by : Sandy

Designed by : Gavin

Checked by : Mike Yang

Approved by : Herbert

TITLE : 25.0 x 7.0 x 0.5 (mm) Wi-Fi Dual Band PCB Antenna with Cable (AA258) Engineering Specification

DOCUMENT NO.

H2B1PC1A1Cxxxx

REV.
A

12.8. 6425~6525 MHz Band (L=100mm)

12-8-1.3D Gain Pattern @ 6475 MHz (unit: dBi)

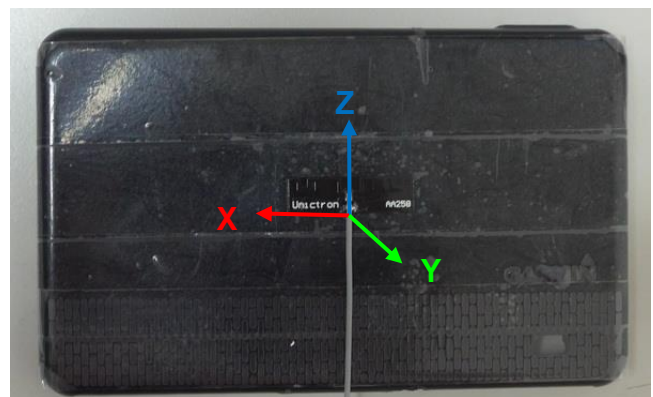
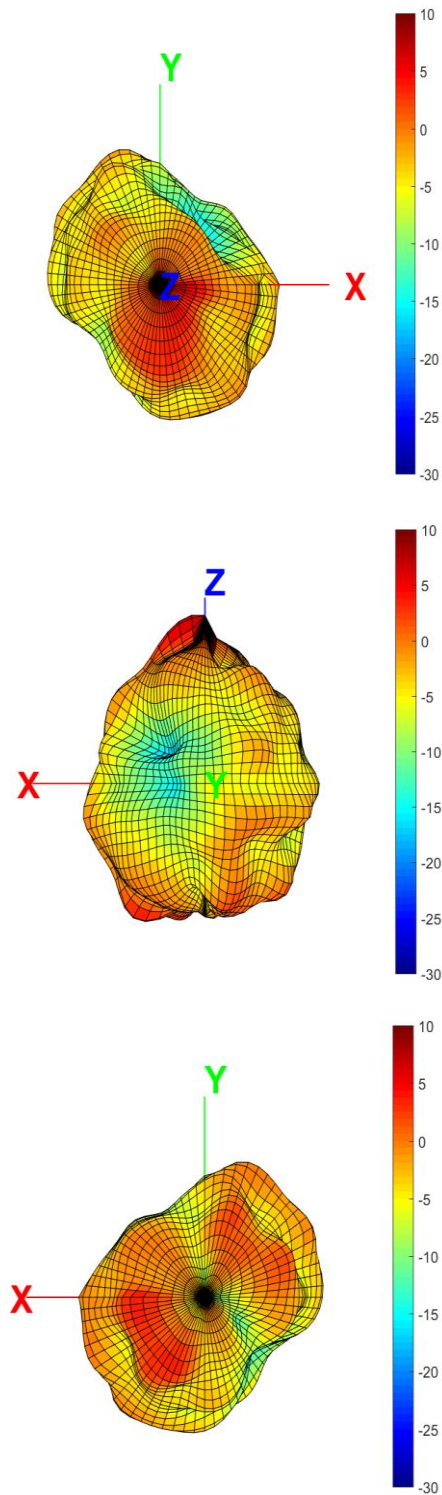

詠業科技股份有限公司
 Unictron Technologies Corporation
 Website: www.unictron.com

THIS DRAWINGS AND SPECIFICATIONS ARE THE PROPERTY OF UNICTRON TECHNOLOGIES CORPORATION AND SHALL NOT BE REPRODUCED OR USED AS THE BASIS FOR THE MANUFACTURE OR SALE OF APPARATUS OR DEVICES WITHOUT PERMISSION

Prepared by : Sandy

Designed by : Gavin

Checked by : Mike Yang

Approved by : Herbert

TITLE : 25.0 x 7.0 x 0.5 (mm) Wi-Fi Dual Band PCB Antenna with Cable (AA258) Engineering Specification

DOCUMENT NO.

H2B1PC1A1Cxxxx

REV.

A

12.9. 6525~6875 MHz Band (L=100mm)

12-9-1.3D Gain Pattern @ 6700 MHz (unit: dBi)

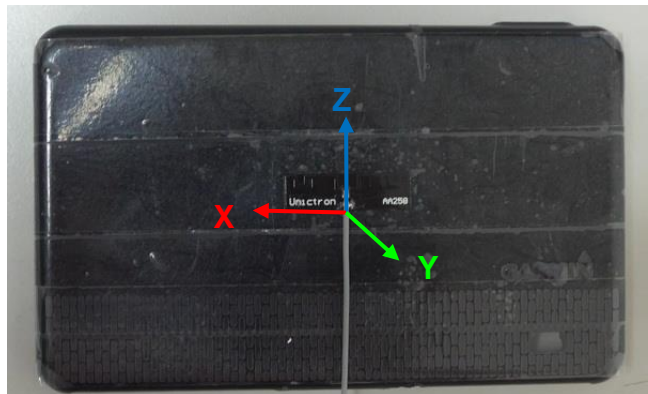
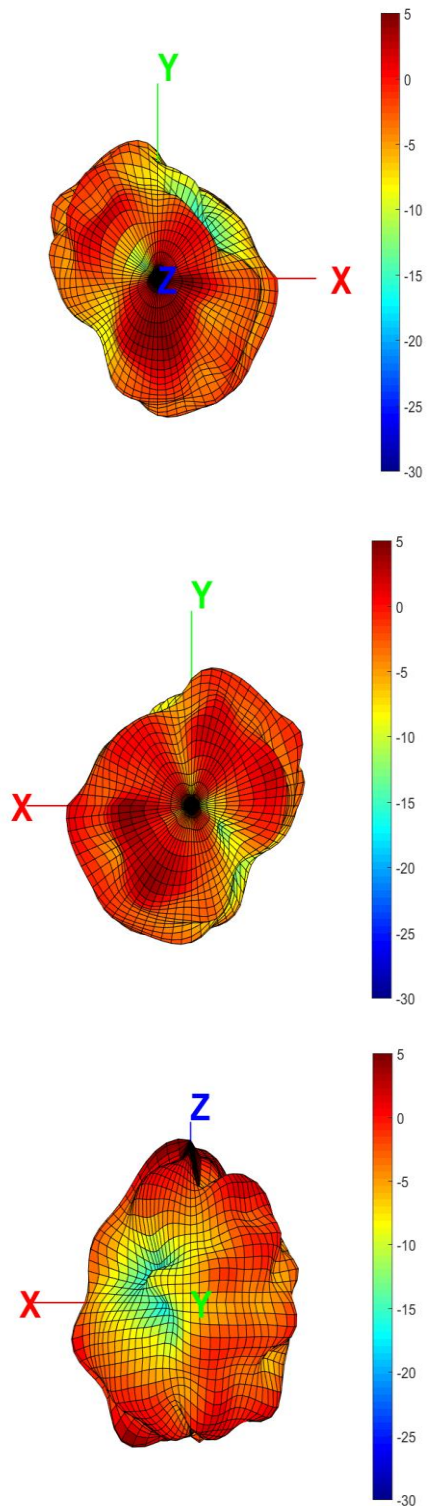

詠業科技股份有限公司
 Unictron Technologies Corporation
 Website: www.unictron.com

THIS DRAWINGS AND SPECIFICATIONS ARE THE PROPERTY OF UNICTRON TECHNOLOGIES CORPORATION AND SHALL NOT BE REPRODUCED OR USED AS THE BASIS FOR THE MANUFACTURE OR SALE OF APPARATUS OR DEVICES WITHOUT PERMISSION

Prepared by : Sandy

Designed by : Gavin

Checked by : Mike Yang

Approved by : Herbert

TITLE : 25.0 x 7.0 x 0.5 (mm) Wi-Fi Dual Band PCB Antenna with Cable (AA258) Engineering Specification

DOCUMENT NO.

H2B1PC1A1Cxxxx

REV.
A

12.10. 6875~7125 MHz Band (L=100mm)

12-10-1.3D Gain Pattern @ 7000 MHz (unit: dBi)

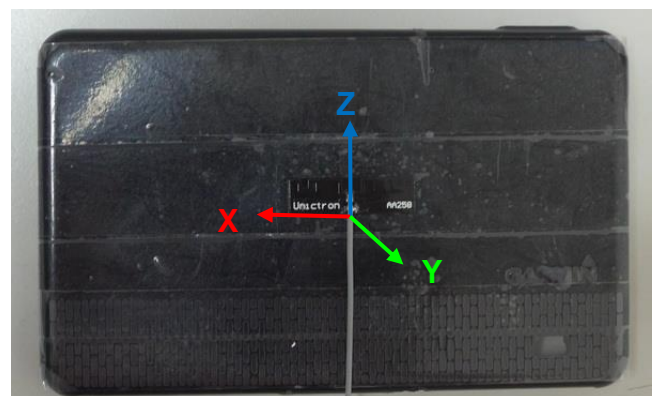
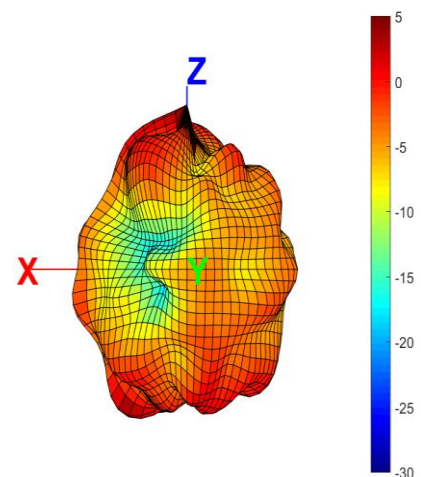
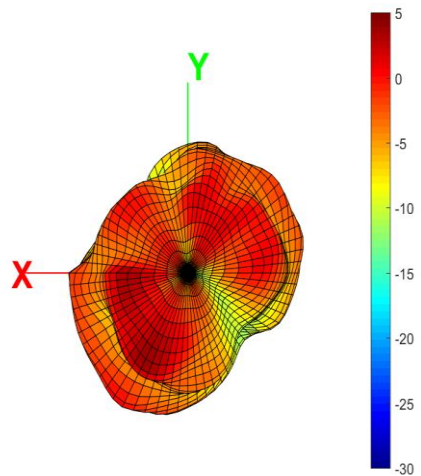
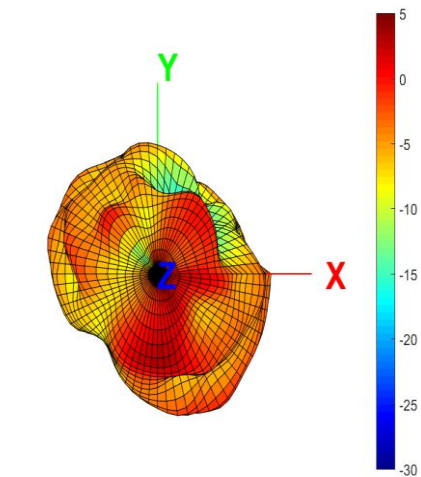

詠業科技股份有限公司
 Unictron Technologies Corporation
 Website:www.unictron.com

THIS DRAWINGS AND SPECIFICATIONS ARE THE PROPERTY OF UNICTRON TECHNOLOGIES CORPORATION AND SHALL NOT BE REPRODUCED OR USED AS THE BASIS FOR THE MANUFACTURE OR SALE OF APPARATUS OR DEVICES WITHOUT PERMISSION

Prepared by : Sandy

Designed by : Gavin

Checked by : Mike Yang

Approved by : Herbert

TITLE : 25.0 x 7.0 x 0.5 (mm) Wi-Fi Dual Band PCB Antenna with Cable (AA258) Engineering Specification

DOCUMENT NO.

H2B1PC1A1Cxxxx

REV.

A