

ELECTROMAGNETIC EMISSIONS COMPLIANCE REPORT

INTENTIONAL RADIATOR CERTIFICATION TO CLASS II PERMISSIVE CHANGE TEST REPORT

OF

Product Name: Embedded wireless module
Brand Name: Silex
Model No.: SX-SDMAC-2832S, SX-SDMAC-2832S+
Model Difference: For market segmentation
FCC ID: N6C-PMACS
Report No.: ER/2017/70041-01
Issue Date: Sep. 29, 2017
FCC Rule Part: §15.247, Cat: DTS
Prepared for: silex technology, Inc
 2-3-1Hikaridai, Seika-cho, Souraku-gun, Kyoto
 619-0237
Prepared by: SGS Taiwan Ltd.
 Electronics & Communication Laboratory
 No.134, Wu Kung Road, New Taipei Industrial
 Park, Wuku District, New Taipei City, Tai-
 wan 24803

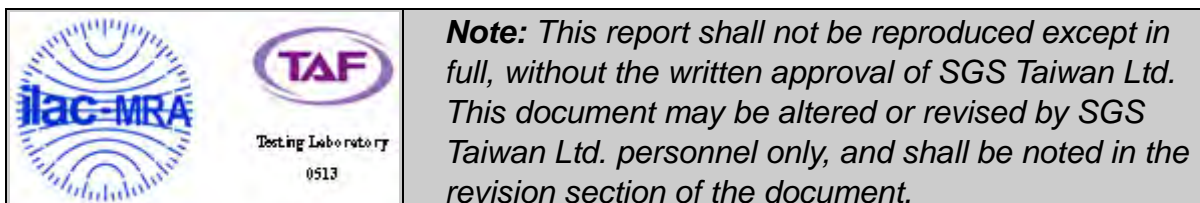

Unless otherwise stated the results shown in this test report refer only to the sample(s) tested and such sample(s) are retained for 90 days only.

除非另有說明，此報告結果僅對測試之樣品負責，同時此樣品僅保留90天。本報告未經本公司書面許可，不可部份複製。

This document is issued by the Company subject to its General Conditions of Service printed overleaf, available on request or accessible at www.sgs.com/terms_and_conditions.htm and, for electronic format documents, subject to Terms and Conditions for Electronic Documents at www.sgs.com/terms_e-document.htm. Attention is drawn to the limitation of liability, indemnification and jurisdiction issues defined therein. Any holder of this document is advised that information contained hereon reflects the Company's findings at the time of its intervention only and within the limits of Client's instructions, if any. The Company's sole responsibility is to its Client and this document does not exonerate parties to a transaction from exercising all their rights and obligations under the transaction documents. This document cannot be reproduced except in full, without prior written approval of the Company. Any unauthorized alteration, forgery or falsification of the content or appearance of this document is unlawful and offenders may be prosecuted to the fullest extent of the law.

SGS Taiwan Ltd.

No.134,WuKungRoad,NewTaipeiIndustrialPark,WukuDistrict,NewTaipeiCity,Taiwan24803/新北市五股區新北產業園區五工路134號

台灣檢驗科技股份有限公司

t (886-2) 2299-3279

f (886-2) 2298-0488

www.tw.sgs.com

Member of SGS Group

VERIFICATION OF COMPLIANCE

Applicant: silex technology,Inc
2-3-1Hikaridai,Seika-cho,Souraku-gun,Kyoto 619-0237

Product Name: Embedded wireless module

Brand Name: Silex

Model No.: SX-SDMAC-2832S, SX-SDMAC-2832S+

Model Difference: For market segmentation

FCC ID: N6C-PMACS

Report Number: ER/2017/70041-01

Date of test: Sep. 11, 2017

Date of EUT Received: Sep. 06, 2017

We hereby certify that:

The above equipment was tested by SGS Taiwan Ltd. Electronics & Communication Laboratory The test data, data evaluation, test procedures, and equipment configurations shown in this report were made in accordance with the procedures given in ANSI C63.10:2013 and the energy emitted by the sample EUT tested as described in this report is in compliance with conducted and radiated emission limits.

The test results of this report relate only to the tested sample identified in this report.

Test By:

Cooper Hsu

Date

Sep. 29, 2017

Cooper Hsu / Engineer

Prepared By:

Allen Tsai

Date

Sep. 29, 2017

Allen Tsai / Engineer

Approved By:

Jim Chang

Date

Sep. 29, 2017

Jim Chang / Asst. Manager

Unless otherwise stated the results shown in this test report refer only to the sample(s) tested and such sample(s) are retained for 90 days only.

除非另有說明，此報告結果僅對測試之樣品負責，同時此樣品僅保留90天。本報告未經本公司書面許可，不可部份複製。

This document is issued by the Company subject to its General Conditions of Service printed overleaf, available on request or accessible at www.sgs.com/terms_and_conditions.htm and, for electronic format documents, subject to Terms and Conditions for Electronic Documents at www.sgs.com/terms_e-document.htm. Attention is drawn to the limitation of liability, indemnification and jurisdiction issues defined therein. Any holder of this document is advised that information contained hereon reflects the Company's findings at the time of its intervention only and within the limits of Client's instructions, if any. The Company's sole responsibility is to its Client and this document does not exonerate parties to a transaction from exercising all their rights and obligations under the transaction documents. This document cannot be reproduced except in full, without prior written approval of the Company. Any unauthorized alteration, forgery or falsification of the content or appearance of this document is unlawful and offenders may be prosecuted to the fullest extent of the law.

SGS Taiwan Ltd.

No.134,WuKungRoad,NewTaipeiIndustrialPark,WukuDistrict,NewTaipeiCity,Taiwan24803/新北市五股區新北產業園區五工路 134 號

台灣檢驗科技股份有限公司

t (886-2) 2299-3279

f (886-2) 2298-0488

www.tw.sgs.com

Member of SGS Group

Revision History

| Report Number | Revision | Description | Issue Date |
|------------------|----------|------------------------------|---------------|
| ER/2017/70041-01 | Rev.00 | Initial creation of document | Sep. 29, 2017 |
| | | | |
| | | | |
| | | | |

Unless otherwise stated the results shown in this test report refer only to the sample(s) tested and such sample(s) are retained for 90 days only.

除非另有說明，此報告結果僅對測試之樣品負責，同時此樣品僅保留90天。本報告未經本公司書面許可，不可部份複製。

This document is issued by the Company subject to its General Conditions of Service printed overleaf, available on request or accessible at www.sgs.com/terms_and_conditions.htm and, for electronic format documents, subject to Terms and Conditions for Electronic Documents at www.sgs.com/terms_e-document.htm. Attention is drawn to the limitation of liability, indemnification and jurisdiction issues defined therein. Any holder of this document is advised that information contained hereon reflects the Company's findings at the time of its intervention only and within the limits of Client's instructions, if any. The Company's sole responsibility is to its Client and this document does not exonerate parties to a transaction from exercising all their rights and obligations under the transaction documents. This document cannot be reproduced except in full, without prior written approval of the Company. Any unauthorized alteration, forgery or falsification of the content or appearance of this document is unlawful and offenders may be prosecuted to the fullest extent of the law.

SGS Taiwan Ltd.

No.134,WuKungRoad,NewTaipeiIndustrialPark,WukuDistrict,NewTaipeiCity,Taiwan24803/新北市五股區新北產業園區五工路 134 號

台灣檢驗科技股份有限公司

t (886-2) 2299-3279

f (886-2) 2298-0488

www.tw.sgs.com

Member of SGS Group

Table of Contents

| | | |
|---|--|----|
| 1 | GENERAL INFORMATION | 5 |
| 2 | SYSTEM TEST CONFIGURATION | 8 |
| 3 | SUMMARY OF TEST RESULTS | 10 |
| 4 | DESCRIPTION OF TEST MODES..... | 10 |
| 5 | MEASUREMENT UNCERTAINTY | 12 |
| 6 | RADIATED BANDEDGE AND SPURIOUS EMISSION MEASUREMENT..... | 13 |
| 7 | ANTENNA REQUIREMENT..... | 34 |

Unless otherwise stated the results shown in this test report refer only to the sample(s) tested and such sample(s) are retained for 90 days only.

除非另有說明，此報告結果僅對測試之樣品負責，同時此樣品僅保留90天。本報告未經本公司書面許可，不可部份複製。

This document is issued by the Company subject to its General Conditions of Service printed overleaf, available on request or accessible at www.sgs.com/terms_and_conditions.htm and, for electronic format documents, subject to Terms and Conditions for Electronic Documents at www.sgs.com/terms_e-document.htm. Attention is drawn to the limitation of liability, indemnification and jurisdiction issues defined therein. Any holder of this document is advised that information contained hereon reflects the Company's findings at the time of its intervention only and within the limits of Client's instructions, if any. The Company's sole responsibility is to its Client and this document does not exonerate parties to a transaction from exercising all their rights and obligations under the transaction documents. This document cannot be reproduced except in full, without prior written approval of the Company. Any unauthorized alteration, forgery or falsification of the content or appearance of this document is unlawful and offenders may be prosecuted to the fullest extent of the law.

SGS Taiwan Ltd.

No. 134, WuKungRoad, New Taipei Industrial Park, Wuku District, New Taipei City, Taiwan 24803/新北市五股區新北產業園區五工路 134 號

台灣檢驗科技股份有限公司

t (886-2) 2299-3279

f (886-2) 2298-0488

www.tw.sgs.com

Member of SGS Group

1 GENERAL INFORMATION

1.1 Product Description

General:

| | |
|-------------------|---------------------------------|
| Product Name: | Embedded wireless module |
| Brand Name: | Silex |
| Model No.: | SX-SDMAC-2832S, SX-SDMAC-2832S+ |
| Model Difference: | For market segmentation |
| Software version: | N/A |
| Hardware version: | N/A |
| Power Supply: | 3.3Vdc from Power supply |

Bluetooth Low Energy:

| | |
|--------------------|-------------------------------------|
| Frequency Range: | 2402 – 2480MHz |
| Bluetooth Version: | BT 4.2 Dual mode |
| Channel number: | 40 channels |
| Modulation type: | GFSK |
| Transmit Power: | 2.03 dBm (Peak) -0.04 dBm (Avg.) |

Class II Pmissive Change

| | |
|-----------------------------|--|
| Scope: | The test report covers the radiated emissions requirements of the standards referenced in the report to allow new antennas to be included in this authorization. |
| Class II Permissive change: | Adding New antennas to this certified module under FCC ID: N6C-PMACS |

Unless otherwise stated the results shown in this test report refer only to the sample(s) tested and such sample(s) are retained for 90 days only.

除非另有說明，此報告結果僅對測試之樣品負責，同時此樣品僅保留90天。本報告未經本公司書面許可，不可部份複製。

This document is issued by the Company subject to its General Conditions of Service printed overleaf, available on request or accessible at www.sgs.com/terms_and_conditions.htm and, for electronic format documents, subject to Terms and Conditions for Electronic Documents at www.sgs.com/terms_e-document.htm. Attention is drawn to the limitation of liability, indemnification and jurisdiction issues defined therein. Any holder of this document is advised that information contained hereon reflects the Company's findings at the time of its intervention only and within the limits of Client's instructions, if any. The Company's sole responsibility is to its Client and this document does not exonerate parties to a transaction from exercising all their rights and obligations under the transaction documents. This document cannot be reproduced except in full, without prior written approval of the Company. Any unauthorized alteration, forgery or falsification of the content or appearance of this document is unlawful and offenders may be prosecuted to the fullest extent of the law.

SGS Taiwan Ltd.

台灣檢驗科技股份有限公司

No. 134, WuKungRoad, New Taipei Industrial Park, Wuku District, New Taipei City, Taiwan 24803/新北市五股區新北產業園區五工路 134 號

t (886-2) 2299-3279

f (886-2) 2298-0488

www.tw.sgs.com

Member of SGS Group

| Antenna Type | Supplier | Antenna Part No. | Freq. | Peak Antenna Gain (dBi) | Worst Antenna Gain |
|--------------|--------------|------------------|--------|-------------------------|--------------------|
| ROD antenna | Sansei Denki | ANTB98-061A0 | 2.4GHz | 1.50 | |
| | | ANTDP-027A0 | | 1.50 | |
| | | ANTDP-039A0 | | 1.50 | |
| | | ANTDC-081A0 | | 2.00 | V |
| | | ANTDC-081B0 | | 2.00 | V |
| | VSO | GRF1763 | | 1.50 | |
| | | GRF1765 | | 1.50 | |
| | | GRF1762 | | 2.00 | V |
| | | GRF1802 | | 2.00 | V |

Note: Pre-scanned was done on the above 9 antennas, the ANTDC-081A0 results higher emission at 2.4GHz. Therefore, the completed set of measurement was done on the antenna to be presented on this test report.

Unless otherwise stated the results shown in this test report refer only to the sample(s) tested and such sample(s) are retained for 90 days only.

除非另有說明，此報告結果僅對測試之樣品負責，同時此樣品僅保留90天。本報告未經本公司書面許可，不可部份複製。

This document is issued by the Company subject to its General Conditions of Service printed overleaf, available on request or accessible at www.sgs.com/terms_and_conditions.htm and, for electronic format documents, subject to Terms and Conditions for Electronic Documents at www.sgs.com/terms_e-document.htm. Attention is drawn to the limitation of liability, indemnification and jurisdiction issues defined therein. Any holder of this document is advised that information contained hereon reflects the Company's findings at the time of its intervention only and within the limits of Client's instructions, if any. The Company's sole responsibility is to its Client and this document does not exonerate parties to a transaction from exercising all their rights and obligations under the transaction documents. This document cannot be reproduced except in full, without prior written approval of the Company. Any unauthorized alteration, forgery or falsification of the content or appearance of this document is unlawful and offenders may be prosecuted to the fullest extent of the law.

SGS Taiwan Ltd.

No. 134, WuKungRoad, NewTaipeiIndustrialPark, WukuDistrict, New Taipei City, Taiwan 24803/新北市五股區新北產業園區五工路 134 號

台灣檢驗科技股份有限公司

t (886-2) 2299-3279

f (886-2) 2298-0488

www.tw.sgs.com

Member of SGS Group

1.2 Test Methodology of Applied Standards

FCC Part 15, Subpart C §15.247

FCC KDB 558074 D01 DTS Meas. Guidance.

ANSI C63.10:2013

Note: All test items have been performed and record as per the above standards.

1.3 Test Facility

SGS Taiwan Ltd. Electronics & Communication Laboratory No.134, Wu Kung Road, New Taipei Industrial Park, Wuku District, New Taipei City, Taiwan 24803 (TAF code 0513)

FCC Registration Number and Designation number are: 509634 / TW0001

1.4 Special Accessories

There are no special accessories used while test was conducted.

1.5 Equipment Modifications

There was no modification incorporated into the EUT.

Unless otherwise stated the results shown in this test report refer only to the sample(s) tested and such sample(s) are retained for 90 days only.

除非另有說明，此報告結果僅對測試之樣品負責，同時此樣品僅保留90天。本報告未經本公司書面許可，不可部份複製。

This document is issued by the Company subject to its General Conditions of Service printed overleaf, available on request or accessible at www.sgs.com/terms_and_conditions.htm and, for electronic format documents, subject to Terms and Conditions for Electronic Documents at www.sgs.com/terms_e-document.htm. Attention is drawn to the limitation of liability, indemnification and jurisdiction issues defined therein. Any holder of this document is advised that information contained hereon reflects the Company's findings at the time of its intervention only and within the limits of Client's instructions, if any. The Company's sole responsibility is to its Client and this document does not exonerate parties to a transaction from exercising all their rights and obligations under the transaction documents. This document cannot be reproduced except in full, without prior written approval of the Company. Any unauthorized alteration, forgery or falsification of the content or appearance of this document is unlawful and offenders may be prosecuted to the fullest extent of the law.

SGS Taiwan Ltd.

No.134,WuKungRoad,NewTaipeiIndustrialPark,WukuDistrict,NewTaipeiCity,Taiwan24803/新北市五股區新北產業園區五工路 134 號

台灣檢驗科技股份有限公司

t (886-2) 2299-3279

f (886-2) 2298-0488

www.tw.sgs.com

Member of SGS Group

2 SYSTEM TEST CONFIGURATION

2.1 EUT Configuration

The EUT configuration for testing is installed on RF field strength measurement to meet the Commissions requirement and operating in a manner which intends to maximize its emission characteristics in a continuous normal application.

2.2 EUT Exercise

An engineering test mode (software/firmware) that applicant provided was utilized to manipulate the EUT into transmit, selection of the test channel, and modulation scheme.

2.3 Test Procedure

2.3.1 Radiated Emissions

The EUT is placed on a turn table. For emissions testing at or below 1 GHz, the table height shall be 0.8 m above the reference ground plane. For emission measurements above 1 GHz, the table height shall be 1.5 m. The turn table shall rotate 360 degrees to determine the position of maximum emission level. EUT is set 3m away from the receiving antenna which varied from 1m to 4m to find out the highest emission. And also, each emission was to be maximized by changing the polarization of receiving antenna both horizontal and vertical. In order to find out the max. emission, the relative positions of this transmitter (EUT) was rotated through three orthogonal axes and measurement procedures for electric field radiated emissions above 1 GHz the EUT measurement is to be made "while keeping the antenna in the 'cone of radiation' from that area and pointed at the area both in azimuth and elevation, with polarization oriented for maximum response." is still within the 3dB illumination BW of the measurement antenna.

Unless otherwise stated the results shown in this test report refer only to the sample(s) tested and such sample(s) are retained for 90 days only.

除非另有說明，此報告結果僅對測試之樣品負責，同時此樣品僅保留90天。本報告未經本公司書面許可，不可部份複製。

This document is issued by the Company subject to its General Conditions of Service printed overleaf, available on request or accessible at www.sgs.com/terms_and_conditions.htm and, for electronic format documents, subject to Terms and Conditions for Electronic Documents at www.sgs.com/terms_e-document.htm. Attention is drawn to the limitation of liability, indemnification and jurisdiction issues defined therein. Any holder of this document is advised that information contained hereon reflects the Company's findings at the time of its intervention only and within the limits of Client's instructions, if any. The Company's sole responsibility is to its Client and this document does not exonerate parties to a transaction from exercising all their rights and obligations under the transaction documents. This document cannot be reproduced except in full, without prior written approval of the Company. Any unauthorized alteration, forgery or falsification of the content or appearance of this document is unlawful and offenders may be prosecuted to the fullest extent of the law.

SGS Taiwan Ltd.

台灣檢驗科技股份有限公司

No. 134, WuKungRoad, New Taipei Industrial Park, Wuku District, New Taipei City, Taiwan 24803/新北市五股區新北產業園區五工路 134 號

t (886-2) 2299-3279

f (886-2) 2298-0488

www.tw.sgs.com

Member of SGS Group

2.4 Configuration of Tested System

Fig. 2-2 Radiated Emission Configuration



Table 2-1 Equipment Used in Tested System

| Item | Equipment | Mfr/Brand | Model/Type No. | Series No. | Data Cable | Power Cord |
|------|-------------------------|-----------|----------------|------------|------------|------------|
| 1 | Notebook | DELL | E5400 | 3704625136 | Shielded | Unshielded |
| 2 | Bluetooth Test Software | N/A | N/A | N/A | N/A | N/A |

Unless otherwise stated the results shown in this test report refer only to the sample(s) tested and such sample(s) are retained for 90 days only.

除非另有說明，此報告結果僅對測試之樣品負責，同時此樣品僅保留90天。本報告未經本公司書面許可，不可部份複製。

This document is issued by the Company subject to its General Conditions of Service printed overleaf, available on request or accessible at www.sgs.com/terms_and_conditions.htm and, for electronic format documents, subject to Terms and Conditions for Electronic Documents at www.sgs.com/terms_e-document.htm. Attention is drawn to the limitation of liability, indemnification and jurisdiction issues defined therein. Any holder of this document is advised that information contained hereon reflects the Company's findings at the time of its intervention only and within the limits of Client's instructions, if any. The Company's sole responsibility is to its Client and this document does not exonerate parties to a transaction from exercising all their rights and obligations under the transaction documents. This document cannot be reproduced except in full, without prior written approval of the Company. Any unauthorized alteration, forgery or falsification of the content or appearance of this document is unlawful and offenders may be prosecuted to the fullest extent of the law.

SGS Taiwan Ltd.

No.134,WuKungRoad,NewTaipeiIndustrialPark,WukuDistrict,NewTaipeiCity,Taiwan24803/新北市五股區新北產業園區五工路 134 號

台灣檢驗科技股份有限公司

t (886-2) 2299-3279

f (886-2) 2298-0488

www.tw.sgs.com

Member of SGS Group

3 SUMMARY OF TEST RESULTS

| FCC Rules | Description Of Test | Result |
|-----------------------|--|-----------|
| §15.247(d) | Radiated Band Edge and Spurious Emission | Compliant |
| §15.203 §15.247(b) | Antenna Requirement | Compliant |

4 DESCRIPTION OF TEST MODES

4.1 Operated in 2400 ~ 2483.5MHz Band

40 channels are provided for Bluetooth LE

| CHANNEL | FREQUENCY | CHANNEL | FREQUENCY | CHANNEL | FREQUENCY |
|---------|-----------|---------|-----------|---------|-----------|
| 0 | 2402 MHz | 14 | 2430 MHz | 28 | 2458 MHz |
| 1 | 2404 MHz | 15 | 2432 MHz | 29 | 2460 MHz |
| 2 | 2406 MHz | 16 | 2434 MHz | 30 | 2462 MHz |
| 3 | 2408 MHz | 17 | 2436 MHz | 31 | 2464 MHz |
| 4 | 2410 MHz | 18 | 2438 MHz | 32 | 2466 MHz |
| 5 | 2412 MHz | 19 | 2440 MHz | 33 | 2468 MHz |
| 6 | 2414 MHz | 20 | 2442 MHz | 34 | 2470 MHz |
| 7 | 2416MHz | 21 | 2444 MHz | 35 | 2472 MHz |
| 8 | 2418 MHz | 22 | 2446 MHz | 36 | 2474 MHz |
| 9 | 2420 MHz | 23 | 2448 MHz | 37 | 2476 MHz |
| 10 | 2422 MHz | 24 | 2450 MHz | 38 | 2478 MHz |
| 11 | 2424 MHz | 25 | 2452 MHz | 39 | 2480 MHz |
| 12 | 2426 MHz | 26 | 2454 MHz | | |
| 13 | 2428 MHz | 27 | 2456 MHz | | |

Unless otherwise stated the results shown in this test report refer only to the sample(s) tested and such sample(s) are retained for 90 days only.

除非另有說明，此報告結果僅對測試之樣品負責，同時此樣品僅保留90天。本報告未經本公司書面許可，不可部份複製。

This document is issued by the Company subject to its General Conditions of Service printed overleaf, available on request or accessible at www.sgs.com/terms_and_conditions.htm and, for electronic format documents, subject to Terms and Conditions for Electronic Documents at www.sgs.com/terms_e-document.htm. Attention is drawn to the limitation of liability, indemnification and jurisdiction issues defined therein. Any holder of this document is advised that information contained hereon reflects the Company's findings at the time of its intervention only and within the limits of Client's instructions, if any. The Company's sole responsibility is to its Client and this document does not exonerate parties to a transaction from exercising all their rights and obligations under the transaction documents. This document cannot be reproduced except in full, without prior written approval of the Company. Any unauthorized alteration, forgery or falsification of the content or appearance of this document is unlawful and offenders may be prosecuted to the fullest extent of the law.

SGS Taiwan Ltd.

No.134,WuKungRoad,NewTaipeiIndustrialPark,WukuDistrict,NewTaipeiCity,Taiwan24803/新北市五股區新北產業園區五工路134號

台灣檢驗科技股份有限公司

t (886-2) 2299-3279

f (886-2) 2298-0488

www.tw.sgs.com

Member of SGS Group

4.2 The Worst Test Modes and Channel Details

1. The EUT has been tested under operating condition.
2. Test program used to control the EUT for staying in continuous transmitting and receiving mode is programmed.

RADIATED EMISSION TEST:

| RADIATED EMISSION TEST (BELOW 1 GHz) | | | | |
|--------------------------------------|-------------------|----------------|------------|------------------|
| MODE | AVAILABLE CHANNEL | TESTED CHANNEL | MODULATION | DATA RATE (Mbps) |
| Bluetooth LE | 0 to 39 | 0,19,39 | GFSK | 1 |
| RADIATED EMISSION TEST (ABOVE 1 GHz) | | | | |
| MODE | AVAILABLE CHANNEL | TESTED CHANNEL | MODULATION | DATA RATE (Mbps) |
| Bluetooth LE | 0 to 39 | 0,19,39 | GFSK | 1 |

Note:

The field strength of radiation emission was measured as EUT stand-up position (H mode) and lie down position (E1, E2 mode) for Bluetooth LE Transmitter for channel Low, Mid and High, the worst case E2 position was reported.

Unless otherwise stated the results shown in this test report refer only to the sample(s) tested and such sample(s) are retained for 90 days only.

除非另有說明，此報告結果僅對測試之樣品負責，同時此樣品僅保留90天。本報告未經本公司書面許可，不可部份複製。

This document is issued by the Company subject to its General Conditions of Service printed overleaf, available on request or accessible at www.sgs.com/terms_and_conditions.htm and, for electronic format documents, subject to Terms and Conditions for Electronic Documents at www.sgs.com/terms_e-document.htm. Attention is drawn to the limitation of liability, indemnification and jurisdiction issues defined therein. Any holder of this document is advised that information contained hereon reflects the Company's findings at the time of its intervention only and within the limits of Client's instructions, if any. The Company's sole responsibility is to its Client and this document does not exonerate parties to a transaction from exercising all their rights and obligations under the transaction documents. This document cannot be reproduced except in full, without prior written approval of the Company. Any unauthorized alteration, forgery or falsification of the content or appearance of this document is unlawful and offenders may be prosecuted to the fullest extent of the law.

SGS Taiwan Ltd.

台灣檢驗科技股份有限公司

No.134,WuKungRoad,NewTaipeiIndustrialPark,WukuDistrict,NewTaipeiCity,Taiwan24803/新北市五股區新北產業園區五工路 134 號

t (886-2) 2299-3279

f (886-2) 2298-0488

www.tw.sgs.com

Member of SGS Group

5 MEASUREMENT UNCERTAINTY

Radiated Spurious Emission:

| | |
|--|----------------------------|
| Measurement uncertainty (Polarization : Vertical) | 9kHz – 30MHz: +/- 2.87 dB |
| | 30MHz - 180MHz: +/- 3.37dB |
| | 180MHz -417MHz: +/- 3.19dB |
| | 0.417GHz-1GHz: +/- 3.19dB |
| | 1GHz - 18GHz: +/- 4.04dB |
| | 18GHz - 40GHz: +/- 4.04dB |

| | |
|--|----------------------------|
| Measurement uncertainty (Polarization : Horizontal) | 9kHz – 30MHz: +/- 2.87 dB |
| | 30MHz - 167MHz: +/- 4.22dB |
| | 167MHz -500MHz: +/- 3.44dB |
| | 0.5GHz-1GHz: +/- 3.39dB |
| | 1GHz - 18GHz: +/- 4.08dB |
| | 18GHz - 40GHz: +/- 4.08dB |

This uncertainty represents an expanded uncertainty expressed at approximately the 95% confidence level using a coverage factor of k=2.

Unless otherwise stated the results shown in this test report refer only to the sample(s) tested and such sample(s) are retained for 90 days only.

除非另有說明，此報告結果僅對測試之樣品負責，同時此樣品僅保留90天。本報告未經本公司書面許可，不可部份複製。

This document is issued by the Company subject to its General Conditions of Service printed overleaf, available on request or accessible at www.sgs.com/terms_and_conditions.htm and, for electronic format documents, subject to Terms and Conditions for Electronic Documents at www.sgs.com/terms_e-document.htm. Attention is drawn to the limitation of liability, indemnification and jurisdiction issues defined therein. Any holder of this document is advised that information contained hereon reflects the Company's findings at the time of its intervention only and within the limits of Client's instructions, if any. The Company's sole responsibility is to its Client and this document does not exonerate parties to a transaction from exercising all their rights and obligations under the transaction documents. This document cannot be reproduced except in full, without prior written approval of the Company. Any unauthorized alteration, forgery or falsification of the content or appearance of this document is unlawful and offenders may be prosecuted to the fullest extent of the law.

SGS Taiwan Ltd.

No.134,WuKungRoad,NewTaipeiIndustrialPark,WukuDistrict,NewTaipeiCity,Taiwan24803/新北市五股區新北產業園區五工路 134 號

台灣檢驗科技股份有限公司

t (886-2) 2299-3279

f (886-2) 2298-0488

www.tw.sgs.com

Member of SGS Group

6 RADIATED BANDEDGE AND SPURIOUS EMISSION MEASUREMENT

6.1 Standard Applicable

In any 100 kHz bandwidth outside the frequency band in which the spread spectrum or digitally modulated intentional radiator is operating, the radio frequency power that is produced by the intentional radiator shall be at least 20 dB below that in the 100 kHz bandwidth within the band that contains the highest level of the desired power, based on either an RF conducted or a radiated measurement, provided the transmitter demonstrates compliance with the peak conducted power limits. In addition, radiated emissions which fall in the restricted bands must also comply with the §15.209 limit as below.

And according to §15.33(a) (1), for an intentional radiator operates below 10GHz, the frequency range of measurements: to the tenth harmonic of the highest fundamental frequency or to 40GHz, whichever is lower.

| Frequency (MHz) | Field strength (microvolts/meter) | Distance (meters) |
|-----------------|-----------------------------------|-------------------|
| 0.009-0.490 | 2400/F(kHz) | 300 |
| 0.490-1.705 | 24000/F(kHz) | 30 |
| 1.705-30 | 30 | 30 |
| 30-88 | 100 | 3 |
| 88-216 | 150 | 3 |
| 216-960 | 200 | 3 |
| Above 960 | 500 | 3 |

Note:

1. The lower limit shall apply at the transition frequencies.
2. Emission level (dBµV/m) = 20 log Emission level (dBµV/m)

Unless otherwise stated the results shown in this test report refer only to the sample(s) tested and such sample(s) are retained for 90 days only.

除非另有說明，此報告結果僅對測試之樣品負責，同時此樣品僅保留90天。本報告未經本公司書面許可，不可部份複製。

This document is issued by the Company subject to its General Conditions of Service printed overleaf, available on request or accessible at www.sgs.com/terms_and_conditions.htm and, for electronic format documents, subject to Terms and Conditions for Electronic Documents at www.sgs.com/terms_e-document.htm. Attention is drawn to the limitation of liability, indemnification and jurisdiction issues defined therein. Any holder of this document is advised that information contained hereon reflects the Company's findings at the time of its intervention only and within the limits of Client's instructions, if any. The Company's sole responsibility is to its Client and this document does not exonerate parties to a transaction from exercising all their rights and obligations under the transaction documents. This document cannot be reproduced except in full, without prior written approval of the Company. Any unauthorized alteration, forgery or falsification of the content or appearance of this document is unlawful and offenders may be prosecuted to the fullest extent of the law.

6.2 Measurement Equipment Used

| 966 Chamber | | | | | |
|-------------------|-----------------------|--------------|---------------|------------|------------|
| EQUIPMENT TYPE | MFR | MODEL NUMBER | SERIAL NUMBER | LAST CAL. | CAL DUE. |
| EMI Test Receiver | R&S | ESC17 | 100760 | 05/11/2017 | 05/10/2018 |
| Spectrum Analyzer | Agilent | E4446A | MY51100003 | 04/25/2017 | 04/24/2018 |
| Loop Antenna | ETS-Lindgren | 6502 | 148045 | 09/20/2016 | 09/19/2017 |
| Bilog Antenna | SCHWAZBECK | VULB9168 | 378 | 12/19/2016 | 12/18/2017 |
| Horn Antenna | Schwarzbeck | BBHA9120D | 1441 | 08/04/2017 | 08/03/2018 |
| Pre-Amplifier | Agilent | 8447D | 2944A07676 | 01/05/2017 | 01/04/2018 |
| Pre-Amplifier | EMC Instruments Corp. | EMC0126530 | 980038 | 01/05/2017 | 01/04/2018 |
| Turn Table | HD | DT420 | N/A | N.C.R | N.C.R |
| Antenna Tower | ChamPro | AM-BS-4500-B | 060776-ABS | N.C.R | N.C.R |
| Controller | ChamPro | EM1000 | 60776 | N.C.R | N.C.R |
| Low Loss Cable | Huber Suhner | 966_RX | 9 | 01/05/2017 | 01/04/2018 |
| 3m Site NSA | SGS | 966 chamber | N/A | 07/01/2017 | 06/30/2018 |
| Low Loss Cable | Huber Suhner | 966 TX | 1 | 01/05/2017 | 01/04/2018 |
| Horn Antenna | Schwarzbeck | BBHA9170 | 184 | 12/12/2016 | 12/11/2017 |
| Pre-Amplifier | EMC Instruments Corp. | EMC184045 | 980135 | 01/05/2017 | 01/04/2018 |

Unless otherwise stated the results shown in this test report refer only to the sample(s) tested and such sample(s) are retained for 90 days only.

除非另有說明，此報告結果僅對測試之樣品負責，同時此樣品僅保留90天。本報告未經本公司書面許可，不可部份複製。

This document is issued by the Company subject to its General Conditions of Service printed overleaf, available on request or accessible at www.sgs.com/terms_and_conditions.htm and, for electronic format documents, subject to Terms and Conditions for Electronic Documents at www.sgs.com/terms_e-document.htm. Attention is drawn to the limitation of liability, indemnification and jurisdiction issues defined therein. Any holder of this document is advised that information contained hereon reflects the Company's findings at the time of its intervention only and within the limits of Client's instructions, if any. The Company's sole responsibility is to its Client and this document does not exonerate parties to a transaction from exercising all their rights and obligations under the transaction documents. This document cannot be reproduced except in full, without prior written approval of the Company. Any unauthorized alteration, forgery or falsification of the content or appearance of this document is unlawful and offenders may be prosecuted to the fullest extent of the law.

SGS Taiwan Ltd.

No. 134, WuKungRoad, New Taipei Industrial Park, Wuku District, New Taipei City, Taiwan 24803/新北市五股區新北產業園區五工路 134 號

台灣檢驗科技股份有限公司

t (886-2) 2299-3279

f (886-2) 2298-0488

www.tw.sgs.com

Member of SGS Group

6.3 Test SET-UP

(A) Radiated Emission Test Set-UP Frequency Below 30MHz.

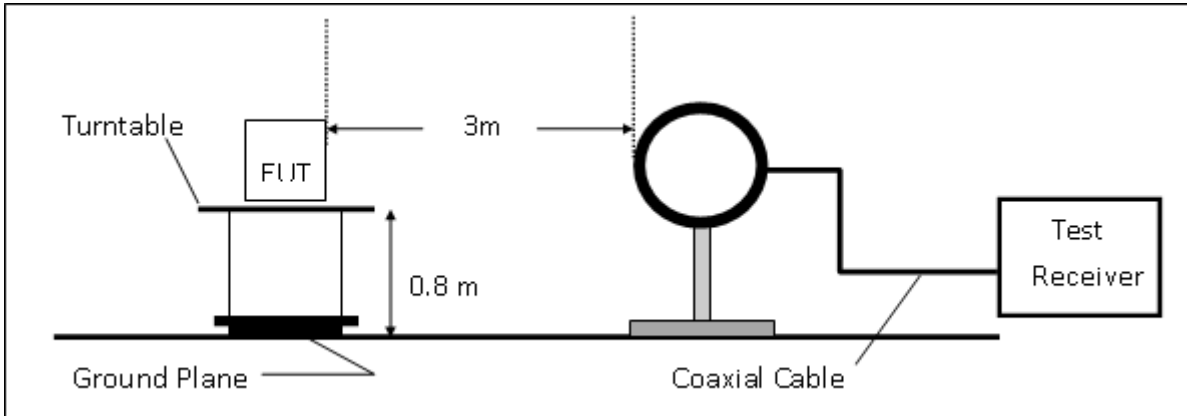

(B) Radiated Emission Test Set-UP, Frequency form 30MHz to 1000MHz

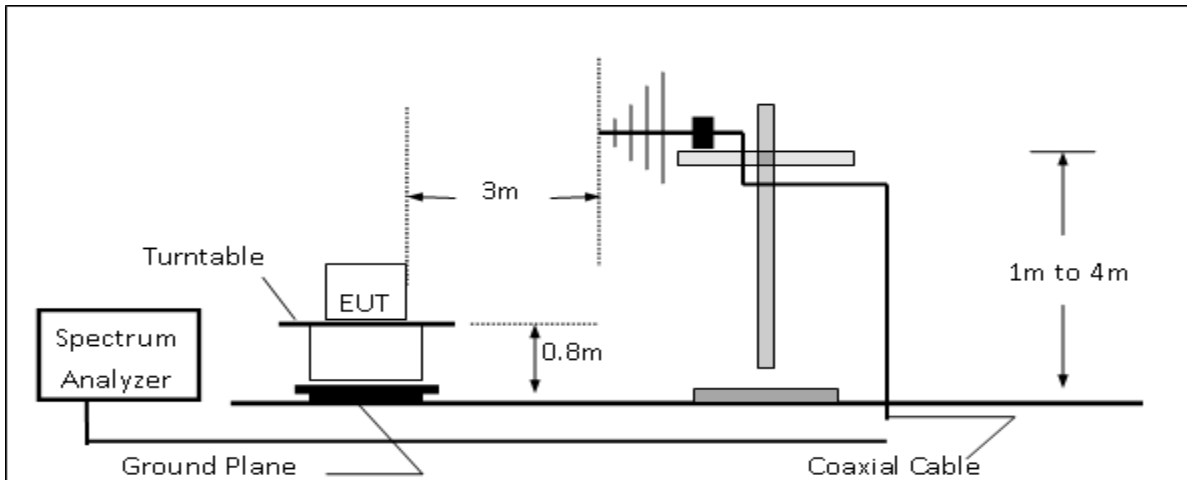

(C) Radiated Emission Test Set-UP Frequency Over 1 GHz

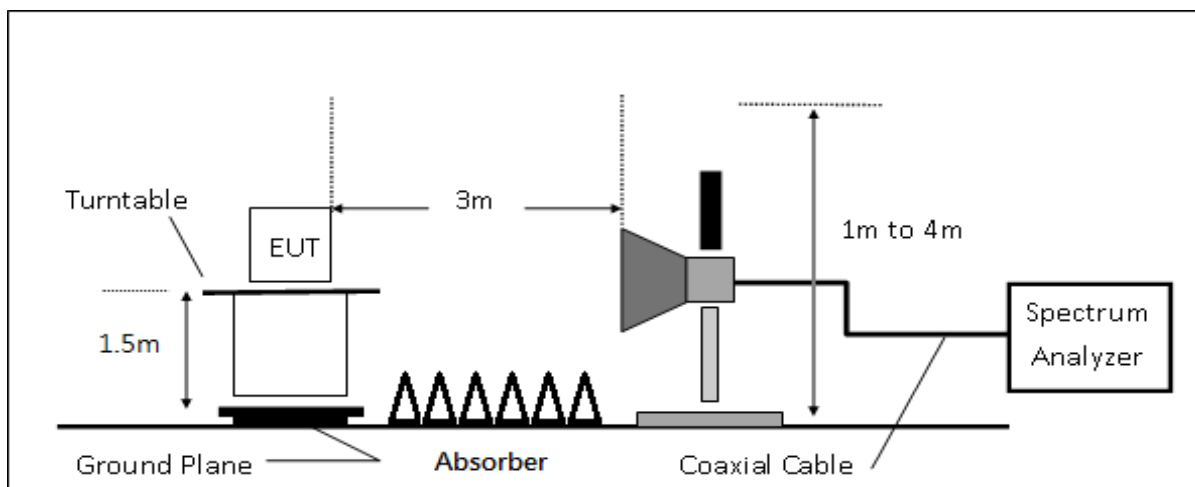

Unless otherwise stated the results shown in this test report refer only to the sample(s) tested and such sample(s) are retained for 90 days only.

除非另有說明，此報告結果僅對測試之樣品負責，同時此樣品僅保留90天。本報告未經本公司書面許可，不可部份複製。

This document is issued by the Company subject to its General Conditions of Service printed overleaf, available on request or accessible at www.sgs.com/terms_and_conditions.htm and, for electronic format documents, subject to Terms and Conditions for Electronic Documents at www.sgs.com/terms_e-document.htm. Attention is drawn to the limitation of liability, indemnification and jurisdiction issues defined therein. Any holder of this document is advised that information contained hereon reflects the Company's findings at the time of its intervention only and within the limits of Client's instructions, if any. The Company's sole responsibility is to its Client and this document does not exonerate parties to a transaction from exercising all their rights and obligations under the transaction documents. This document cannot be reproduced except in full, without prior written approval of the Company. Any unauthorized alteration, forgery or falsification of the content or appearance of this document is unlawful and offenders may be prosecuted to the fullest extent of the law.

6.4 Measurement Procedure

1. The testing follows the Measurement Procedure of FCC KDB 558074 D01 DTS Meas. Guidance.
2. The EUT was placed on a turn table with 0.8m for frequency < 1GHz and 1.5m for frequency > 1GHz above ground plan.
3. The turn table shall rotate 360 degrees to determine the position of maximum emission level.
4. EUT is set 3m away from the receiving antenna which varied from 1m to 4m to find out the highest emissions.
5. Set the spectrum analyzer as RBW=120 kHz and VBW=300 kHz for Peak Detector (PK) and Quasi-peak (QP) at frequency below 1 GHz.
6. Set the spectrum analyzer as RBW=1 MHz, VBW=3 MHz for Peak Detector at frequency above 1 GHz.
7. Set the spectrum analyzer as RBW=1 MHz, VBW=10 Hz (Duty cycle > 98%) or VBW ≥ 1/T (Duty cycle < 98%) for Average Detector at frequency above 1 GHz.
8. When measurement procedures for electric field radiated emissions above 1 GHz the EUT measurement is to be made “while keeping the antenna in the ‘cone of radiation’ from that area and pointed at the area both in azimuth and elevation, with polarization oriented for maximum response.” is still within the 3dB illumination BW of the measurement antenna.
9. Maximum procedure was performed on the six highest emissions to ensure EUT compliance.
10. And also, each emission was to be maximized by changing the polarization of receiving antenna both horizontal and vertical. On spectrum, change spectrum mode in linear display mode, and reduce VBW = 10Hz if average reading is measured.
11. Repeat above procedures until all default test channel measured were complete.

Unless otherwise stated the results shown in this test report refer only to the sample(s) tested and such sample(s) are retained for 90 days only.

除非另有說明，此報告結果僅對測試之樣品負責，同時此樣品僅保留90天。本報告未經本公司書面許可，不可部份複製。

This document is issued by the Company subject to its General Conditions of Service printed overleaf, available on request or accessible at www.sgs.com/terms_and_conditions.htm and, for electronic format documents, subject to Terms and Conditions for Electronic Documents at www.sgs.com/terms_e-document.htm. Attention is drawn to the limitation of liability, indemnification and jurisdiction issues defined therein. Any holder of this document is advised that information contained hereon reflects the Company's findings at the time of its intervention only and within the limits of Client's instructions, if any. The Company's sole responsibility is to its Client and this document does not exonerate parties to a transaction from exercising all their rights and obligations under the transaction documents. This document cannot be reproduced except in full, without prior written approval of the Company. Any unauthorized alteration, forgery or falsification of the content or appearance of this document is unlawful and offenders may be prosecuted to the fullest extent of the law.

SGS Taiwan Ltd.

台灣檢驗科技股份有限公司

No.134,WuKungRoad,NewTaipeiIndustrialPark,WukuDistrict,NewTaipeiCity,Taiwan24803/新北市五股區新北產業園區五工路134號

t (886-2) 2299-3279

f (886-2) 2298-0488

www.tw.sgs.com

Member of SGS Group

6.5 Field Strength Calculation

The field strength is calculated by adding the Antenna Factor and Cable Factor and subtracting the Amplifier Gain and Duty Cycle Correction Factor (if any) from the measured reading. The basic equation with a sample calculation is as follows:

$$FS = RA + AF + CL - AG$$

| | |
|---------------------------|--|
| Where FS = Field Strength | CL = Cable Attenuation Factor (Cable Loss) |
| RA = Reading Amplitude | AG = Amplifier Gain |
| AF = Antenna Factor | |

Actual FS(dBμV/m) = SPA. Reading level(dBμV) + Factor(dB)

Factor(dB) = Antenna Factor(dBμV/m) + Cable Loss(dB) – Pre_Amplifier Gain(dB)

Note :

“F” : denotes Fundamental Frequency. ; “H” : denotes Harmonic Frequency.

“E” : denotes Band Edge Frequency. ; “S” : denotes Spurious Frequency.

6.6 Test Results of Radiated Spurious Emissions form 9 kHz to 30 MHz

The low frequency, which started from 9 kHz to 30MHz, was pre-scanned and the result which was 20dB lower than the limit per 15.31(o) was not reported.

6.7 Measurement Result:

Note: Refer to next page spectrum analyzer data chart and tabular data sheets.

Unless otherwise stated the results shown in this test report refer only to the sample(s) tested and such sample(s) are retained for 90 days only.

除非另有說明，此報告結果僅對測試之樣品負責，同時此樣品僅保留90天。本報告未經本公司書面許可，不可部份複製。

This document is issued by the Company subject to its General Conditions of Service printed overleaf, available on request or accessible at www.sgs.com/terms_and_conditions.htm and, for electronic format documents, subject to Terms and Conditions for Electronic Documents at www.sgs.com/terms_e-document.htm. Attention is drawn to the limitation of liability, indemnification and jurisdiction issues defined therein. Any holder of this document is advised that information contained hereon reflects the Company's findings at the time of its intervention only and within the limits of Client's instructions, if any. The Company's sole responsibility is to its Client and this document does not exonerate parties to a transaction from exercising all their rights and obligations under the transaction documents. This document cannot be reproduced except in full, without prior written approval of the Company. Any unauthorized alteration, forgery or falsification of the content or appearance of this document is unlawful and offenders may be prosecuted to the fullest extent of the law.

Radiated Band Edge Measurement Result

| | | | |
|-----------------------|------------------|--------------------------|-------------------|
| Operation Band | :BLE | Test Date | :2017-09-11 |
| Fundamental Frequency | :2402 MHz | Temp./Humi. | :21 deg_C / 61 RH |
| Operation Mode | :Bandedge CH LOW | Engineer | :Tin |
| EUT Pol. | :E2 Plane | Measurement Antenna Pol. | :VERTICAL |

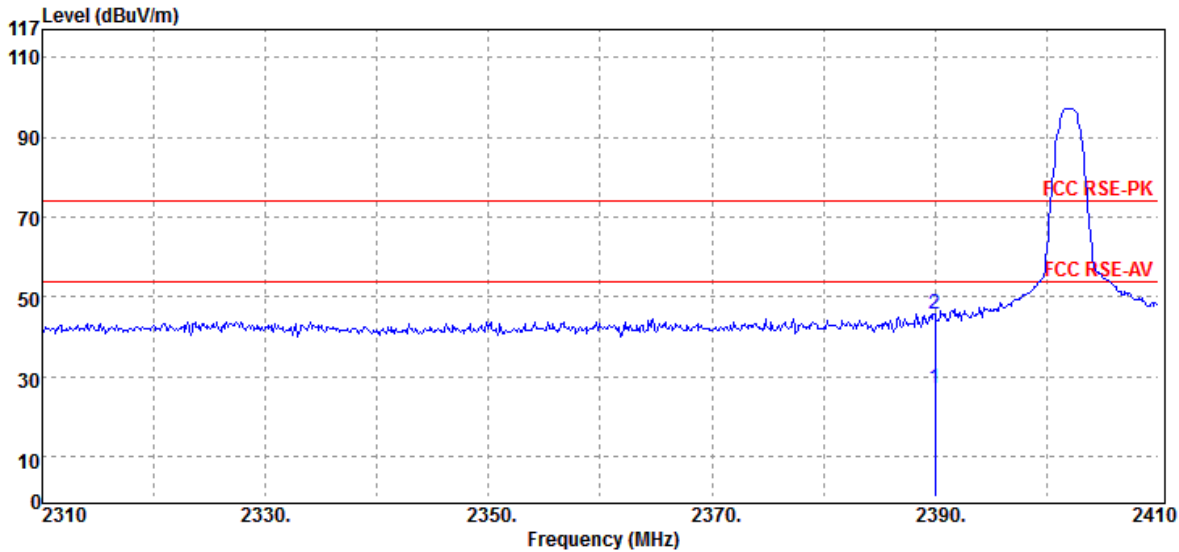

| Freq. MHz | Note F/H/E/S | Detector Mode PK/QP/AV | Spectrum Reading Level dB μ V | Factor dB | Actual FS dB μ V/m | Limit @3m dB μ V/m | Margin dB |
|--------------|-----------------|------------------------------|---|--------------|------------------------------|------------------------------|--------------|
| 2390.00 | E | Average | 28.74 | -1.74 | 27.00 | 54.00 | -27.00 |
| 2390.00 | E | Peak | 47.46 | -1.74 | 45.72 | 74.00 | -28.28 |

Unless otherwise stated the results shown in this test report refer only to the sample(s) tested and such sample(s) are retained for 90 days only.

除非另有說明，此報告結果僅對測試之樣品負責，同時此樣品僅保留90天。本報告未經本公司書面許可，不可部份複製。

This document is issued by the Company subject to its General Conditions of Service printed overleaf, available on request or accessible at www.sgs.com/terms_and_conditions.htm and, for electronic format documents, subject to Terms and Conditions for Electronic Documents at www.sgs.com/terms_e-document.htm. Attention is drawn to the limitation of liability, indemnification and jurisdiction issues defined therein. Any holder of this document is advised that information contained hereon reflects the Company's findings at the time of its intervention only and within the limits of Client's instructions, if any. The Company's sole responsibility is to its Client and this document does not exonerate parties to a transaction from exercising all their rights and obligations under the transaction documents. This document cannot be reproduced except in full, without prior written approval of the Company. Any unauthorized alteration, forgery or falsification of the content or appearance of this document is unlawful and offenders may be prosecuted to the fullest extent of the law.

| | | | |
|-----------------------|------------------|--------------------------|-------------------|
| Operation Band | :BLE | Test Date | :2017-09-11 |
| Fundamental Frequency | :2402 MHz | Temp./Humi. | :21 deg_C / 61 RH |
| Operation Mode | :Bandedge CH LOW | Engineer | :Tin |
| EUT Pol. | :E2 Plane | Measurement Antenna Pol. | :HORIZONTAL |

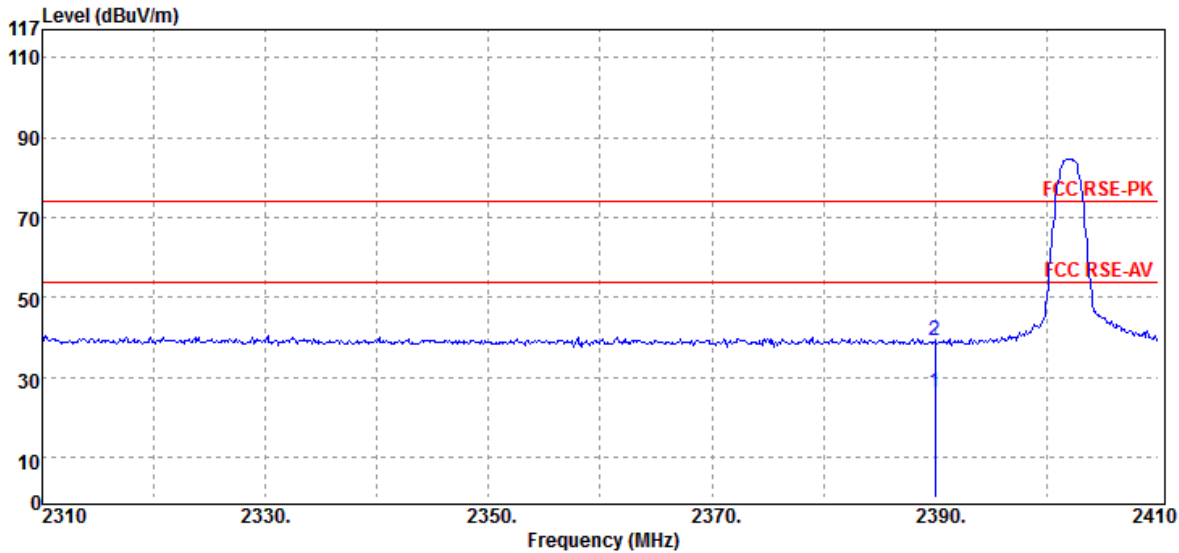

| Freq. | Note | Detector Mode | Spectrum Reading Level | Factor | Actual FS | Limit @3m | Margin |
|---------|---------|---------------|------------------------|--------|--------------|--------------|--------|
| MHz | F/H/E/S | PK/QP/AV | dB μ V | dB | dB μ V/m | dB μ V/m | dB |
| 2390.00 | E | Average | 27.86 | -1.74 | 26.12 | 54.00 | -27.88 |
| 2390.00 | E | Peak | 41.13 | -1.74 | 39.39 | 74.00 | -34.61 |

Unless otherwise stated the results shown in this test report refer only to the sample(s) tested and such sample(s) are retained for 90 days only.

除非另有說明，此報告結果僅對測試之樣品負責，同時此樣品僅保留90天。本報告未經本公司書面許可，不可部份複製。

This document is issued by the Company subject to its General Conditions of Service printed overleaf, available on request or accessible at www.sgs.com/terms_and_conditions.htm and, for electronic format documents, subject to Terms and Conditions for Electronic Documents at www.sgs.com/terms_e-document.htm. Attention is drawn to the limitation of liability, indemnification and jurisdiction issues defined therein. Any holder of this document is advised that information contained hereon reflects the Company's findings at the time of its intervention only and within the limits of Client's instructions, if any. The Company's sole responsibility is to its Client and this document does not exonerate parties to a transaction from exercising all their rights and obligations under the transaction documents. This document cannot be reproduced except in full, without prior written approval of the Company. Any unauthorized alteration, forgery or falsification of the content or appearance of this document is unlawful and offenders may be prosecuted to the fullest extent of the law.

SGS Taiwan Ltd.

No.134,WuKungRoad,NewTaipeiIndustrialPark,WukuDistrict,NewTaipeiCity,Taiwan24803/新北市五股區新北產業園區五工路 134 號

台灣檢驗科技股份有限公司

t (886-2) 2299-3279

f (886-2) 2298-0488

www.tw.sgs.com

Member of SGS Group

| | | | |
|-----------------------|-------------------|--------------------------|-------------------|
| Operation Band | :BLE | Test Date | :2017-09-11 |
| Fundamental Frequency | :2480 MHz | Temp./Humi. | :21 deg_C / 61 RH |
| Operation Mode | :Bandedge CH HIGH | Engineer | :Tin |
| EUT Pol. | :E2 Plane | Measurement Antenna Pol. | :VERTICAL |

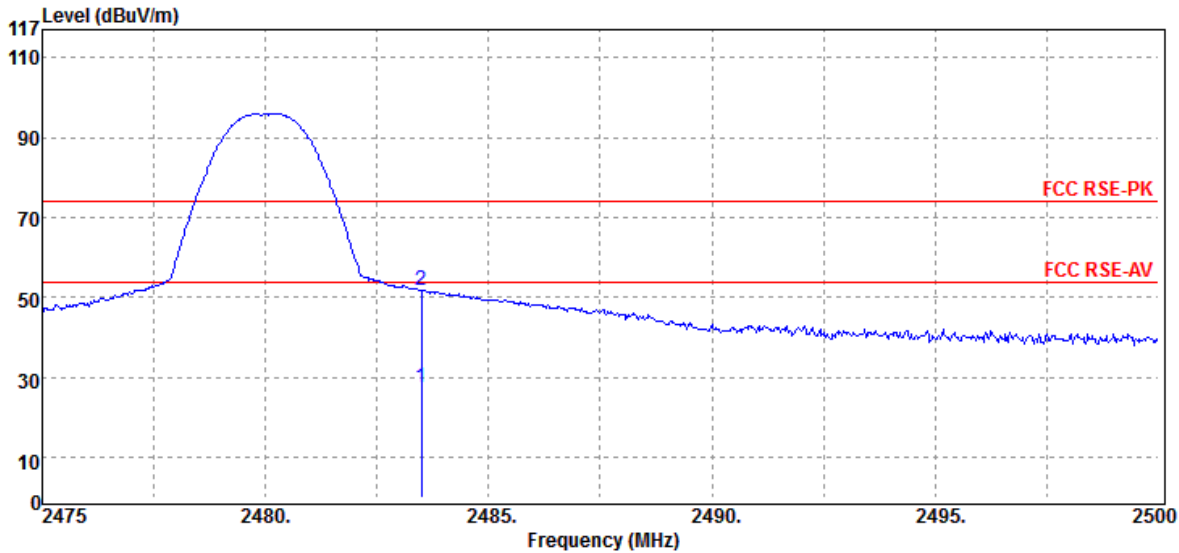

| Freq. MHz | Note F/H/E/S | Detector Mode PK/QP/AV | Spectrum Reading Level dB μ V | Factor dB | Actual FS dB μ V/m | Limit @3m dB μ V/m | Margin dB |
|--------------|-----------------|------------------------------|---|--------------|------------------------------|------------------------------|--------------|
| 2483.50 | E | Average | 29.33 | -1.62 | 27.71 | 54.00 | -26.29 |
| 2483.50 | E | Peak | 53.44 | -1.62 | 51.82 | 74.00 | -22.18 |

Unless otherwise stated the results shown in this test report refer only to the sample(s) tested and such sample(s) are retained for 90 days only.

除非另有說明，此報告結果僅對測試之樣品負責，同時此樣品僅保留90天。本報告未經本公司書面許可，不可部份複製。

This document is issued by the Company subject to its General Conditions of Service printed overleaf, available on request or accessible at www.sgs.com/terms_and_conditions.htm and, for electronic format documents, subject to Terms and Conditions for Electronic Documents at www.sgs.com/terms_e-document.htm. Attention is drawn to the limitation of liability, indemnification and jurisdiction issues defined therein. Any holder of this document is advised that information contained hereon reflects the Company's findings at the time of its intervention only and within the limits of Client's instructions, if any. The Company's sole responsibility is to its Client and this document does not exonerate parties to a transaction from exercising all their rights and obligations under the transaction documents. This document cannot be reproduced except in full, without prior written approval of the Company. Any unauthorized alteration, forgery or falsification of the content or appearance of this document is unlawful and offenders may be prosecuted to the fullest extent of the law.

SGS Taiwan Ltd.

No.134,WuKungRoad,NewTaipeiIndustrialPark,WukuDistrict,NewTaipeiCity,Taiwan24803/新北市五股區新北產業園區五工路 134 號

台灣檢驗科技股份有限公司

t (886-2) 2299-3279

f (886-2) 2298-0488

www.tw.sgs.com

Member of SGS Group

| | | | |
|-----------------------|-------------------|--------------------------|-------------------|
| Operation Band | :BLE | Test Date | :2017-09-11 |
| Fundamental Frequency | :2480 MHz | Temp./Humi. | :21 deg_C / 61 RH |
| Operation Mode | :Bandedge CH HIGH | Engineer | :Tin |
| EUT Pol. | :E2 Plane | Measurement Antenna Pol. | :HORIZONTAL |

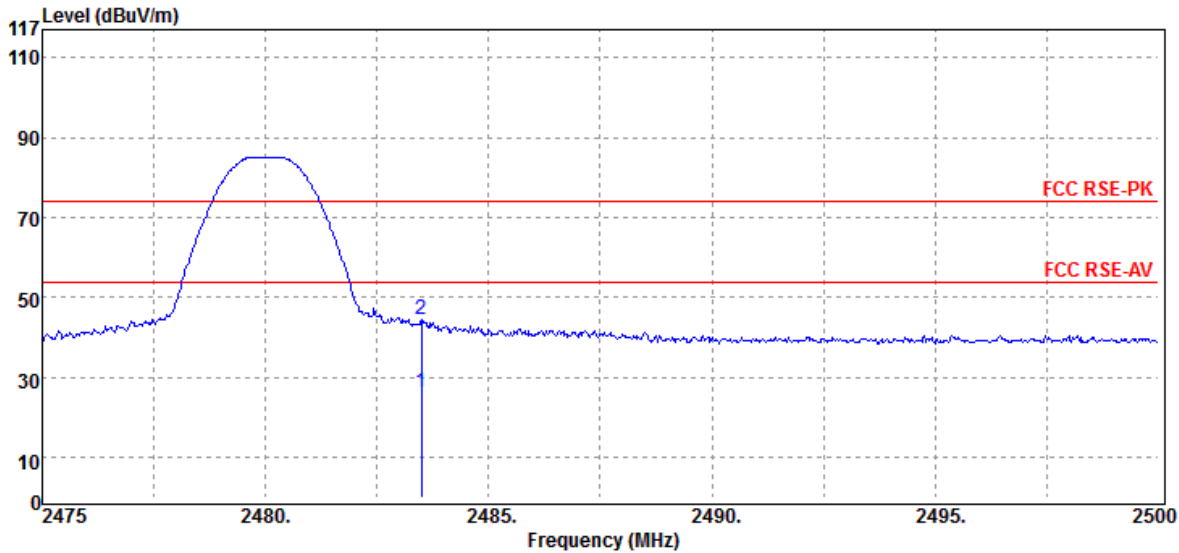

| Freq. MHz | Note F/H/E/S | Detector Mode PK/QP/AV | Spectrum Reading Level dB μ V | Factor dB | Actual FS dB μ V/m | Limit @3m dB μ V/m | Margin dB |
|--------------|-----------------|------------------------------|---|--------------|------------------------------|------------------------------|--------------|
| 2483.50 | E | Average | 27.74 | -1.62 | 26.12 | 54.00 | -27.88 |
| 2483.50 | E | Peak | 46.01 | -1.62 | 44.39 | 74.00 | -29.61 |

Unless otherwise stated the results shown in this test report refer only to the sample(s) tested and such sample(s) are retained for 90 days only.

除非另有說明，此報告結果僅對測試之樣品負責，同時此樣品僅保留90天。本報告未經本公司書面許可，不可部份複製。

This document is issued by the Company subject to its General Conditions of Service printed overleaf, available on request or accessible at www.sgs.com/terms_and_conditions.htm and, for electronic format documents, subject to Terms and Conditions for Electronic Documents at www.sgs.com/terms_e-document.htm. Attention is drawn to the limitation of liability, indemnification and jurisdiction issues defined therein. Any holder of this document is advised that information contained hereon reflects the Company's findings at the time of its intervention only and within the limits of Client's instructions, if any. The Company's sole responsibility is to its Client and this document does not exonerate parties to a transaction from exercising all their rights and obligations under the transaction documents. This document cannot be reproduced except in full, without prior written approval of the Company. Any unauthorized alteration, forgery or falsification of the content or appearance of this document is unlawful and offenders may be prosecuted to the fullest extent of the law.

SGS Taiwan Ltd.

No.134,WuKungRoad,NewTaipeiIndustrialPark,WukuDistrict,NewTaipeiCity,Taiwan24803/新北市五股區新北產業園區五工路 134 號

台灣檢驗科技股份有限公司

t (886-2) 2299-3279

f (886-2) 2298-0488

www.tw.sgs.com

Member of SGS Group

Radiated Spurious Emission Measurement Result For Frequency form 30MHz to 1000MHz

| | | | |
|-----------------------|------------|--------------------------|-------------------|
| Operation Band | :BLE | Test Date | :2017-09-11 |
| Fundamental Frequency | :2402 MHz | Temp./Humi. | :21 deg_C / 61 RH |
| Operation Mode | :Tx CH LOW | Engineer | :Tin |
| EUT Pol. | :E2 Plane | Measurement Antenna Pol. | :VERTICAL |

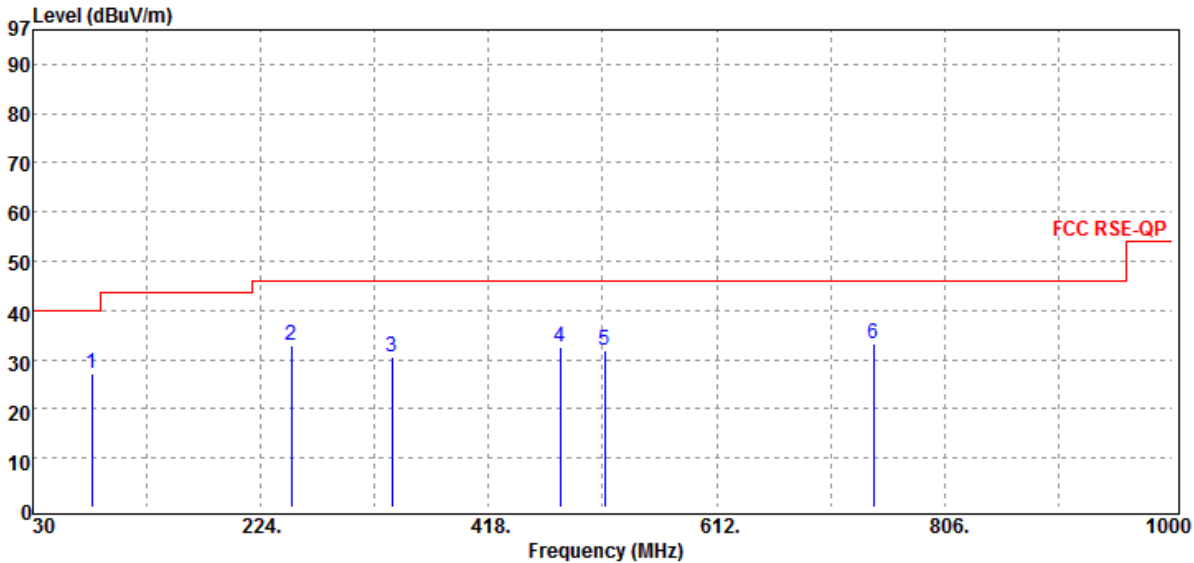

| Freq. MHz | Note F/H/E/S | Detector Mode PK/QP/AV | Spectrum Reading Level dBμV | Factor dB | Actual FS dBμV/m | Limit @3m dBμV/m | Margin dB |
|--------------|-----------------|------------------------------|-----------------------------------|--------------|------------------------|------------------------|--------------|
| 80.44 | S | Peak | 39.59 | -12.37 | 27.22 | 40.00 | -12.78 |
| 250.19 | S | Peak | 40.77 | -7.93 | 32.84 | 46.00 | -13.16 |
| 335.55 | S | Peak | 36.00 | -5.32 | 30.68 | 46.00 | -15.32 |
| 479.11 | S | Peak | 34.99 | -2.39 | 32.60 | 46.00 | -13.40 |
| 516.94 | S | Peak | 33.83 | -1.94 | 31.89 | 46.00 | -14.11 |
| 745.86 | S | Peak | 30.94 | 2.30 | 33.24 | 46.00 | -12.76 |

Unless otherwise stated the results shown in this test report refer only to the sample(s) tested and such sample(s) are retained for 90 days only.

除非另有說明，此報告結果僅對測試之樣品負責，同時此樣品僅保留90天。本報告未經本公司書面許可，不可部份複製。

This document is issued by the Company subject to its General Conditions of Service printed overleaf, available on request or accessible at www.sgs.com/terms_and_conditions.htm and, for electronic format documents, subject to Terms and Conditions for Electronic Documents at www.sgs.com/terms_e-document.htm. Attention is drawn to the limitation of liability, indemnification and jurisdiction issues defined therein. Any holder of this document is advised that information contained hereon reflects the Company's findings at the time of its intervention only and within the limits of Client's instructions, if any. The Company's sole responsibility is to its Client and this document does not exonerate parties to a transaction from exercising all their rights and obligations under the transaction documents. This document cannot be reproduced except in full, without prior written approval of the Company. Any unauthorized alteration, forgery or falsification of the content or appearance of this document is unlawful and offenders may be prosecuted to the fullest extent of the law.

SGS Taiwan Ltd.

No.134,WuKungRoad,NewTaipeiIndustrialPark,WukuDistrict,NewTaipeiCity,Taiwan24803/新北市五股區新北產業園區五工路 134 號

台灣檢驗科技股份有限公司

t (886-2) 2299-3279

f (886-2) 2298-0488

www.tw.sgs.com

Member of SGS Group

| | | | |
|-----------------------|------------|--------------------------|-------------------|
| Operation Band | :BLE | Test Date | :2017-09-11 |
| Fundamental Frequency | :2402 MHz | Temp./Humi. | :21 deg_C / 61 RH |
| Operation Mode | :Tx CH LOW | Engineer | :Tin |
| EUT Pol. | :E2 Plane | Measurement Antenna Pol. | :HORIZONTAL |

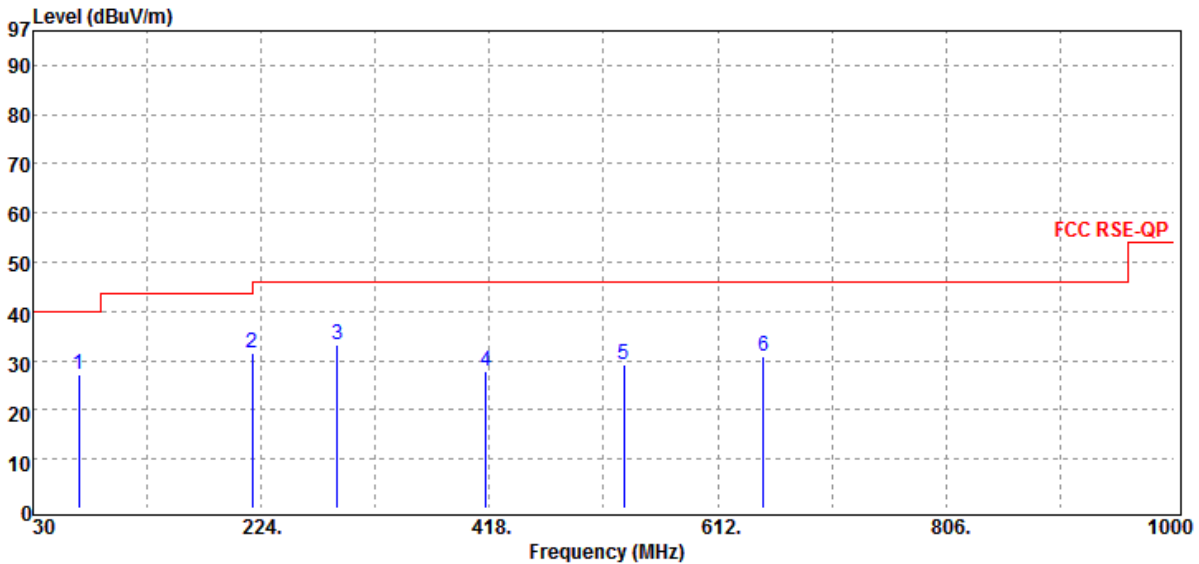

| Freq. MHz | Note F/H/E/S | Detector Mode PK/QP/AV | Spectrum Reading Level dB μ V | Factor dB | Actual FS dB μ V/m | Limit @3m dB μ V/m | Margin dB |
|--------------|-----------------|------------------------------|---|--------------|------------------------------|------------------------------|--------------|
| 68.80 | S | Peak | 37.14 | -9.98 | 27.16 | 40.00 | -12.84 |
| 216.24 | S | Peak | 40.94 | -9.43 | 31.51 | 46.00 | -14.49 |
| 288.99 | S | Peak | 39.22 | -6.09 | 33.13 | 46.00 | -12.87 |
| 415.09 | S | Peak | 30.96 | -3.21 | 27.75 | 46.00 | -18.25 |
| 532.46 | S | Peak | 30.90 | -1.68 | 29.22 | 46.00 | -16.78 |
| 650.80 | S | Peak | 30.45 | 0.49 | 30.94 | 46.00 | -15.06 |

Unless otherwise stated the results shown in this test report refer only to the sample(s) tested and such sample(s) are retained for 90 days only.

除非另有說明，此報告結果僅對測試之樣品負責，同時此樣品僅保留90天。本報告未經本公司書面許可，不可部份複製。

This document is issued by the Company subject to its General Conditions of Service printed overleaf, available on request or accessible at www.sgs.com/terms_and_conditions.htm and, for electronic format documents, subject to Terms and Conditions for Electronic Documents at www.sgs.com/terms_e-document.htm. Attention is drawn to the limitation of liability, indemnification and jurisdiction issues defined therein. Any holder of this document is advised that information contained hereon reflects the Company's findings at the time of its intervention only and within the limits of Client's instructions, if any. The Company's sole responsibility is to its Client and this document does not exonerate parties to a transaction from exercising all their rights and obligations under the transaction documents. This document cannot be reproduced except in full, without prior written approval of the Company. Any unauthorized alteration, forgery or falsification of the content or appearance of this document is unlawful and offenders may be prosecuted to the fullest extent of the law.

SGS Taiwan Ltd.

No.134,WuKungRoad,NewTaipeiIndustrialPark,WukuDistrict,NewTaipeiCity,Taiwan24803/新北市五股區新北產業園區五工路 134 號

台灣檢驗科技股份有限公司

t (886-2) 2299-3279

f (886-2) 2298-0488

www.tw.sgs.com

Member of SGS Group

| | | | |
|-----------------------|------------|--------------------------|-------------------|
| Operation Band | :BLE | Test Date | :2017-09-11 |
| Fundamental Frequency | :2442 MHz | Temp./Humi. | :21 deg_C / 61 RH |
| Operation Mode | :Tx CH MID | Engineer | :Tin |
| EUT Pol. | :E2 Plane | Measurement Antenna Pol. | :VERTICAL |

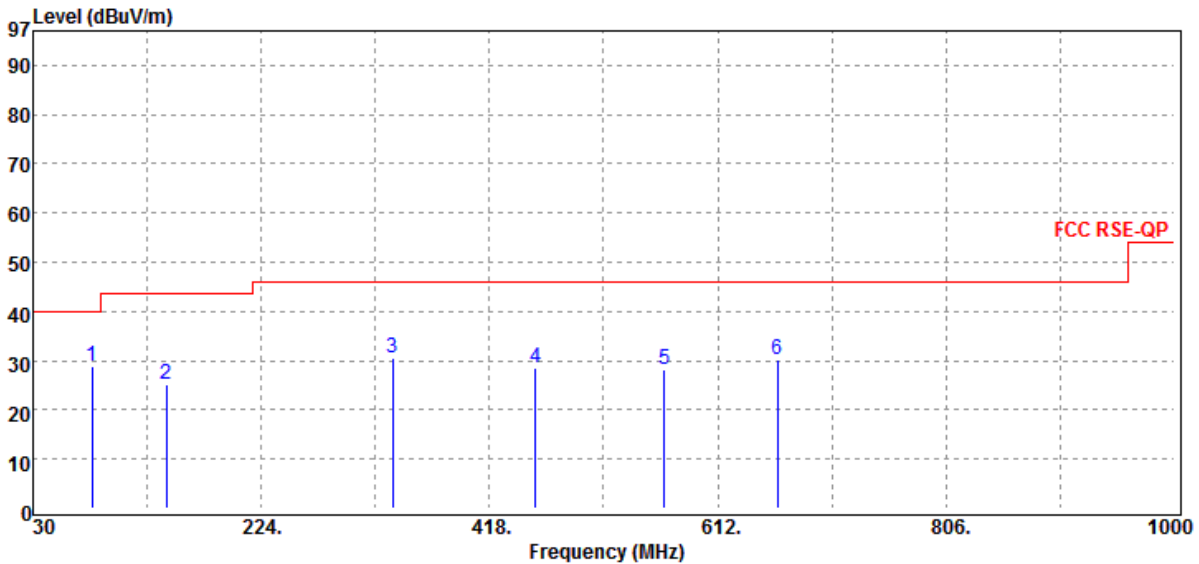

| Freq. MHz | Note F/H/E/S | Detector Mode PK/QP/AV | Spectrum Reading Level dBμV | Factor dB | Actual FS dBμV/m | Limit @3m dBμV/m | Margin dB |
|--------------|-----------------|------------------------------|-----------------------------------|--------------|------------------------|------------------------|--------------|
| 80.44 | S | Peak | 41.11 | -12.37 | 28.74 | 40.00 | -11.26 |
| 143.49 | S | Peak | 33.39 | -8.09 | 25.30 | 43.50 | -18.20 |
| 335.55 | S | Peak | 35.77 | -5.32 | 30.45 | 46.00 | -15.55 |
| 456.80 | S | Peak | 31.29 | -2.65 | 28.64 | 46.00 | -17.36 |
| 566.41 | S | Peak | 29.21 | -1.09 | 28.12 | 46.00 | -17.88 |
| 662.44 | S | Peak | 29.99 | 0.31 | 30.30 | 46.00 | -15.70 |

Unless otherwise stated the results shown in this test report refer only to the sample(s) tested and such sample(s) are retained for 90 days only.

除非另有說明，此報告結果僅對測試之樣品負責，同時此樣品僅保留90天。本報告未經本公司書面許可，不可部份複製。

This document is issued by the Company subject to its General Conditions of Service printed overleaf, available on request or accessible at www.sgs.com/terms_and_conditions.htm and, for electronic format documents, subject to Terms and Conditions for Electronic Documents at www.sgs.com/terms_e-document.htm. Attention is drawn to the limitation of liability, indemnification and jurisdiction issues defined therein. Any holder of this document is advised that information contained hereon reflects the Company's findings at the time of its intervention only and within the limits of Client's instructions, if any. The Company's sole responsibility is to its Client and this document does not exonerate parties to a transaction from exercising all their rights and obligations under the transaction documents. This document cannot be reproduced except in full, without prior written approval of the Company. Any unauthorized alteration, forgery or falsification of the content or appearance of this document is unlawful and offenders may be prosecuted to the fullest extent of the law.

| | | | |
|-----------------------|------------|--------------------------|-------------------|
| Operation Band | :BLE | Test Date | :2017-09-11 |
| Fundamental Frequency | :2442 MHz | Temp./Humi. | :21 deg_C / 61 RH |
| Operation Mode | :Tx CH MID | Engineer | :Tin |
| EUT Pol. | :E2 Plane | Measurement Antenna Pol. | :HORIZONTAL |

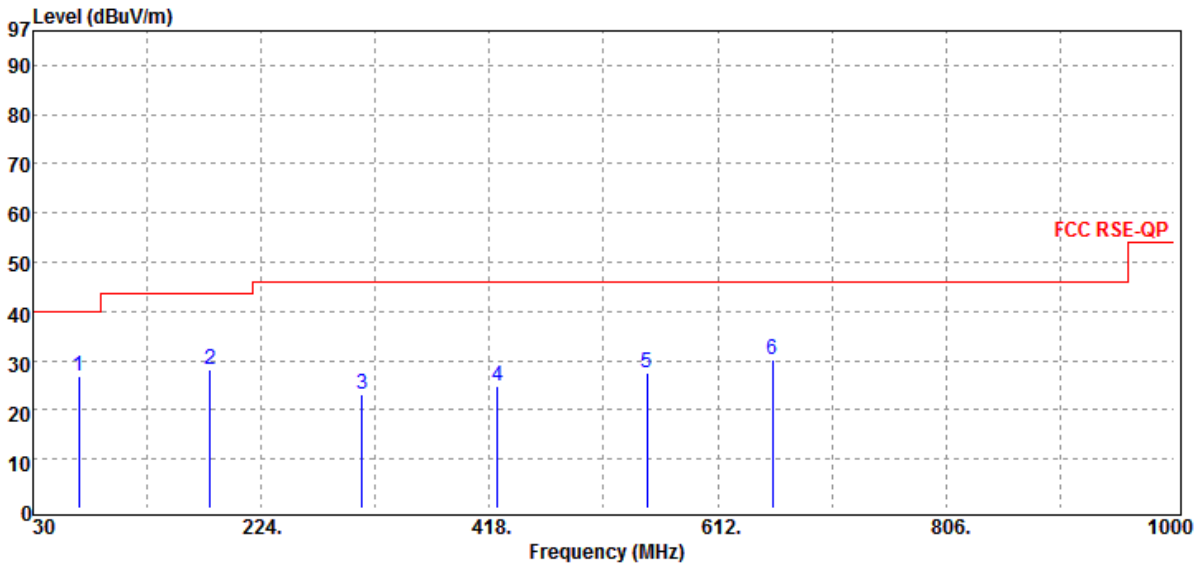

| Freq. MHz | Note F/H/E/S | Detector Mode PK/QP/AV | Spectrum Reading Level dB μ V | Factor dB | Actual FS dB μ V/m | Limit @3m dB μ V/m | Margin dB |
|--------------|-----------------|------------------------------|---|--------------|------------------------------|------------------------------|--------------|
| 68.80 | S | Peak | 36.91 | -9.98 | 26.93 | 40.00 | -13.07 |
| 180.35 | S | Peak | 36.95 | -8.69 | 28.26 | 43.50 | -15.24 |
| 309.36 | S | Peak | 28.68 | -5.49 | 23.19 | 46.00 | -22.81 |
| 424.79 | S | Peak | 28.13 | -3.33 | 24.80 | 46.00 | -21.20 |
| 551.86 | S | Peak | 29.28 | -1.62 | 27.66 | 46.00 | -18.34 |
| 658.56 | S | Peak | 29.82 | 0.41 | 30.23 | 46.00 | -15.77 |

Unless otherwise stated the results shown in this test report refer only to the sample(s) tested and such sample(s) are retained for 90 days only.

除非另有說明，此報告結果僅對測試之樣品負責，同時此樣品僅保留90天。本報告未經本公司書面許可，不可部份複製。

This document is issued by the Company subject to its General Conditions of Service printed overleaf, available on request or accessible at www.sgs.com/terms_and_conditions.htm and, for electronic format documents, subject to Terms and Conditions for Electronic Documents at www.sgs.com/terms_e-document.htm. Attention is drawn to the limitation of liability, indemnification and jurisdiction issues defined therein. Any holder of this document is advised that information contained hereon reflects the Company's findings at the time of its intervention only and within the limits of Client's instructions, if any. The Company's sole responsibility is to its Client and this document does not exonerate parties to a transaction from exercising all their rights and obligations under the transaction documents. This document cannot be reproduced except in full, without prior written approval of the Company. Any unauthorized alteration, forgery or falsification of the content or appearance of this document is unlawful and offenders may be prosecuted to the fullest extent of the law.

SGS Taiwan Ltd.

No.134,WuKungRoad,NewTaipeiIndustrialPark,WukuDistrict,NewTaipeiCity,Taiwan24803/新北市五股區新北產業園區五工路 134 號

台灣檢驗科技股份有限公司

t (886-2) 2299-3279

f (886-2) 2298-0488

www.tw.sgs.com

Member of SGS Group

| | | | |
|-----------------------|-------------|--------------------------|-------------------|
| Operation Band | :BLE | Test Date | :2017-09-11 |
| Fundamental Frequency | :2480 MHz | Temp./Humi. | :21 deg_C / 61 RH |
| Operation Mode | :Tx CH HIGH | Engineer | :Tin |
| EUT Pol. | :E2 Plane | Measurement Antenna Pol. | :VERTICAL |

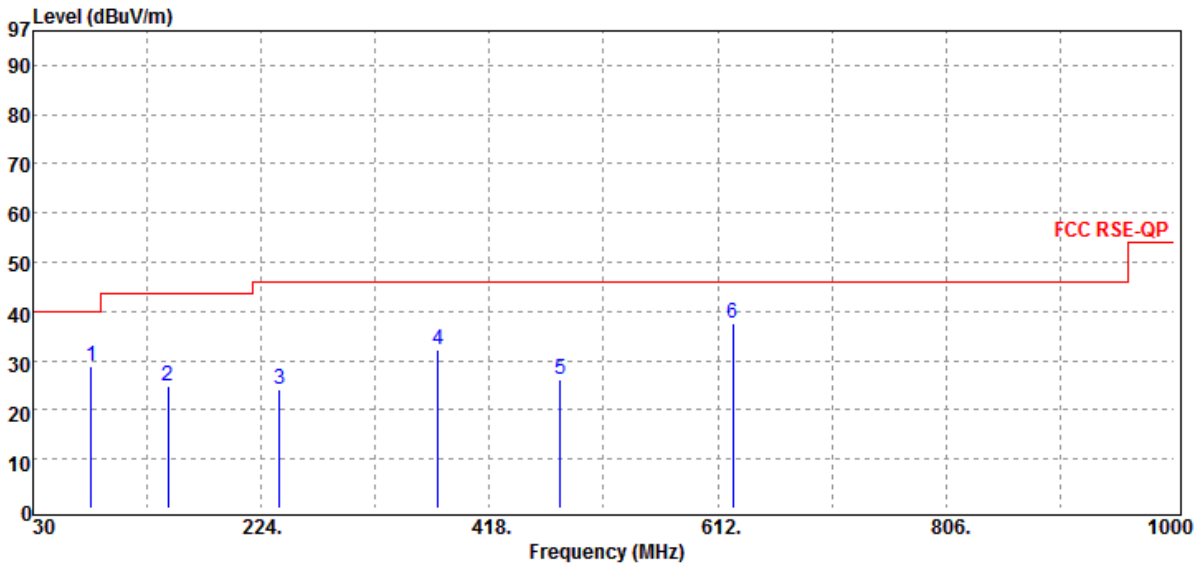

| Freq. MHz | Note F/H/E/S | Detector Mode PK/QP/AV | Spectrum Reading Level dB μ V | Factor dB | Actual FS dB μ V/m | Limit @3m dB μ V/m | Margin dB |
|--------------|-----------------|------------------------------|---|--------------|------------------------------|------------------------------|--------------|
| 79.47 | S | Peak | 41.01 | -12.22 | 28.79 | 40.00 | -11.21 |
| 144.46 | S | Peak | 32.88 | -8.07 | 24.81 | 43.50 | -18.69 |
| 239.52 | S | Peak | 32.21 | -8.12 | 24.09 | 46.00 | -21.91 |
| 374.35 | S | Peak | 36.67 | -4.54 | 32.13 | 46.00 | -13.87 |
| 478.14 | S | Peak | 28.55 | -2.43 | 26.12 | 46.00 | -19.88 |
| 624.61 | S | Peak | 37.44 | 0.15 | 37.59 | 46.00 | -8.41 |

Unless otherwise stated the results shown in this test report refer only to the sample(s) tested and such sample(s) are retained for 90 days only.

除非另有說明，此報告結果僅對測試之樣品負責，同時此樣品僅保留90天。本報告未經本公司書面許可，不可部份複製。

This document is issued by the Company subject to its General Conditions of Service printed overleaf, available on request or accessible at www.sgs.com/terms_and_conditions.htm and, for electronic format documents, subject to Terms and Conditions for Electronic Documents at www.sgs.com/terms_e-document.htm. Attention is drawn to the limitation of liability, indemnification and jurisdiction issues defined therein. Any holder of this document is advised that information contained hereon reflects the Company's findings at the time of its intervention only and within the limits of Client's instructions, if any. The Company's sole responsibility is to its Client and this document does not exonerate parties to a transaction from exercising all their rights and obligations under the transaction documents. This document cannot be reproduced except in full, without prior written approval of the Company. Any unauthorized alteration, forgery or falsification of the content or appearance of this document is unlawful and offenders may be prosecuted to the fullest extent of the law.

SGS Taiwan Ltd.

No.134,WuKungRoad,NewTaipeiIndustrialPark,WukuDistrict,NewTaipeiCity,Taiwan24803/新北市五股區新北產業園區五工路 134 號

台灣檢驗科技股份有限公司

t (886-2) 2299-3279

f (886-2) 2298-0488

www.tw.sgs.com

Member of SGS Group

| | | | |
|-----------------------|-------------|--------------------------|-------------------|
| Operation Band | :BLE | Test Date | :2017-09-11 |
| Fundamental Frequency | :2480 MHz | Temp./Humi. | :21 deg_C / 61 RH |
| Operation Mode | :Tx CH HIGH | Engineer | :Tin |
| EUT Pol. | :E2 Plane | Measurement Antenna Pol. | :HORIZONTAL |

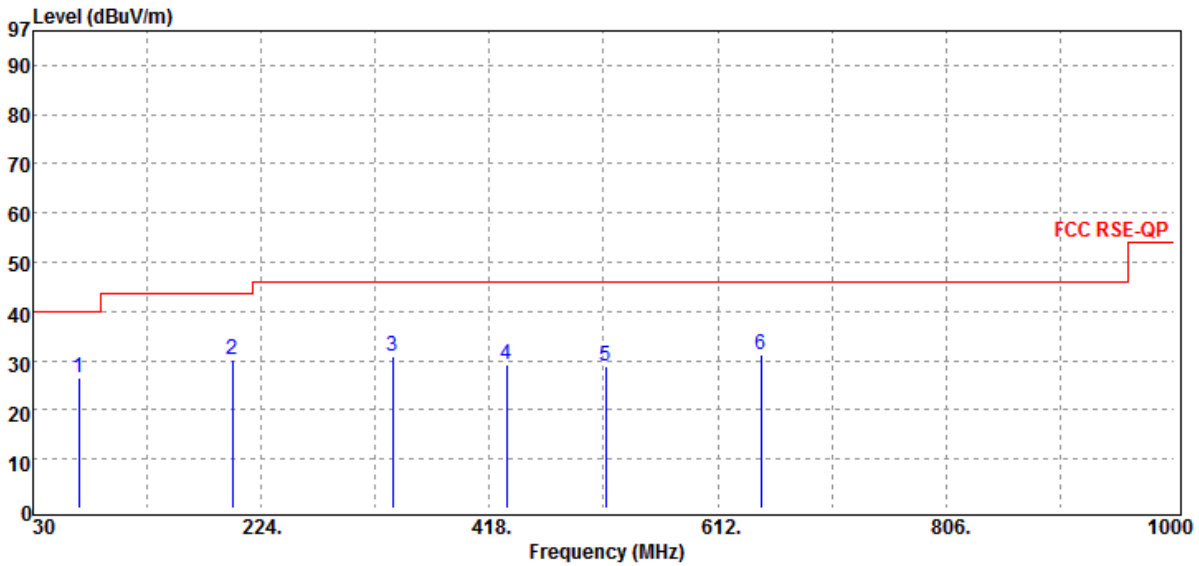

| Freq. MHz | Note F/H/E/S | Detector Mode PK/QP/AV | Spectrum Reading Level dB μ V | Factor dB | Actual FS dB μ V/m | Limit @3m dB μ V/m | Margin dB |
|--------------|-----------------|------------------------------|---|--------------|------------------------------|------------------------------|--------------|
| 68.80 | S | Peak | 36.60 | -9.98 | 26.62 | 40.00 | -13.38 |
| 199.75 | S | Peak | 39.85 | -9.61 | 30.24 | 43.50 | -13.26 |
| 335.55 | S | Peak | 36.09 | -5.32 | 30.77 | 46.00 | -15.23 |
| 432.55 | S | Peak | 32.66 | -3.43 | 29.23 | 46.00 | -16.77 |
| 516.94 | S | Peak | 30.96 | -1.94 | 29.02 | 46.00 | -16.98 |
| 648.86 | S | Peak | 30.85 | 0.40 | 31.25 | 46.00 | -14.75 |

Unless otherwise stated the results shown in this test report refer only to the sample(s) tested and such sample(s) are retained for 90 days only.

除非另有說明，此報告結果僅對測試之樣品負責，同時此樣品僅保留90天。本報告未經本公司書面許可，不可部份複製。

This document is issued by the Company subject to its General Conditions of Service printed overleaf, available on request or accessible at www.sgs.com/terms_and_conditions.htm and, for electronic format documents, subject to Terms and Conditions for Electronic Documents at www.sgs.com/terms_e-document.htm. Attention is drawn to the limitation of liability, indemnification and jurisdiction issues defined therein. Any holder of this document is advised that information contained hereon reflects the Company's findings at the time of its intervention only and within the limits of Client's instructions, if any. The Company's sole responsibility is to its Client and this document does not exonerate parties to a transaction from exercising all their rights and obligations under the transaction documents. This document cannot be reproduced except in full, without prior written approval of the Company. Any unauthorized alteration, forgery or falsification of the content or appearance of this document is unlawful and offenders may be prosecuted to the fullest extent of the law.

Radiated Spurious Emission Measurement Result For Frequency above 1GHz

| | | | |
|-----------------------|------------|--------------------------|-------------------|
| Operation Band | :BLE | Test Date | :2017-09-11 |
| Fundamental Frequency | :2402 MHz | Temp./Humi. | :21 deg_C / 61 RH |
| Operation Mode | :Tx CH LOW | Engineer | :Tin |
| EUT Pol. | :E2 Plane | Measurement Antenna Pol. | :VERTICAL |

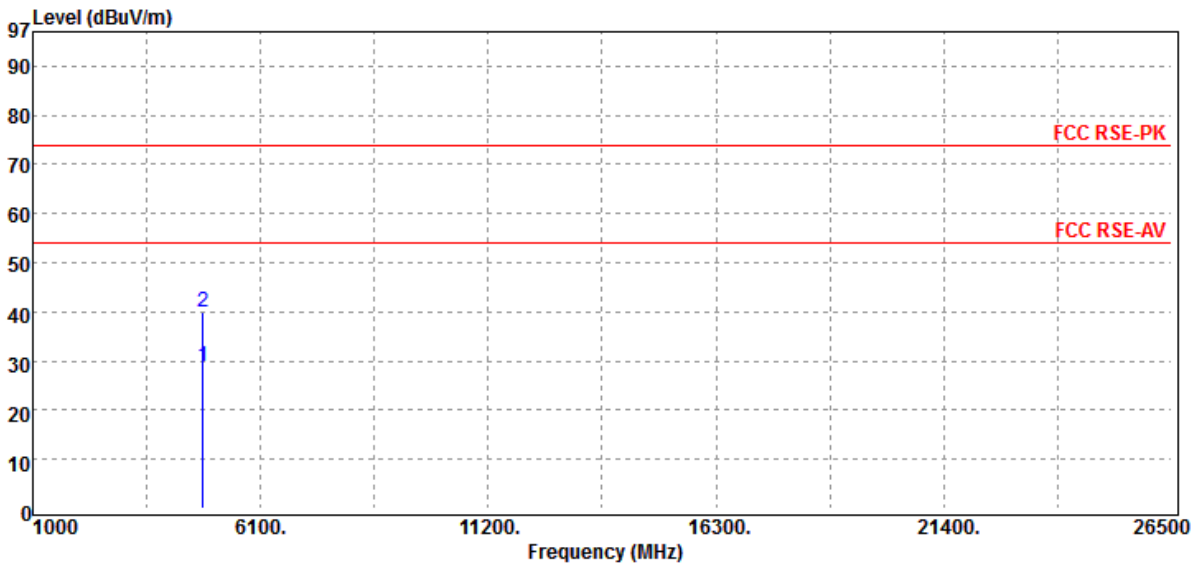

| Freq. MHz | Note F/H/E/S | Detector Mode PK/QP/AV | Spectrum Reading Level dB μ V | Factor dB | Actual FS dB μ V/m | Limit @3m dB μ V/m | Safe Margin dB |
|--------------|-----------------|------------------------------|---|--------------|------------------------------|------------------------------|----------------------|
| 4804.00 | H | Average | 24.02 | 4.92 | 28.94 | 54.00 | -25.06 |
| 4804.00 | H | Peak | 35.11 | 4.92 | 40.03 | 74.00 | -33.97 |

Unless otherwise stated the results shown in this test report refer only to the sample(s) tested and such sample(s) are retained for 90 days only.

除非另有說明，此報告結果僅對測試之樣品負責，同時此樣品僅保留90天。本報告未經本公司書面許可，不可部份複製。

This document is issued by the Company subject to its General Conditions of Service printed overleaf, available on request or accessible at www.sgs.com/terms_and_conditions.htm and, for electronic format documents, subject to Terms and Conditions for Electronic Documents at www.sgs.com/terms_e-document.htm. Attention is drawn to the limitation of liability, indemnification and jurisdiction issues defined therein. Any holder of this document is advised that information contained hereon reflects the Company's findings at the time of its intervention only and within the limits of Client's instructions, if any. The Company's sole responsibility is to its Client and this document does not exonerate parties to a transaction from exercising all their rights and obligations under the transaction documents. This document cannot be reproduced except in full, without prior written approval of the Company. Any unauthorized alteration, forgery or falsification of the content or appearance of this document is unlawful and offenders may be prosecuted to the fullest extent of the law.

SGS Taiwan Ltd.

No.134,WuKungRoad,NewTaipeiIndustrialPark,WukuDistrict,NewTaipeiCity,Taiwan24803/新北市五股區新北產業園區五工路 134 號

台灣檢驗科技股份有限公司

t (886-2) 2299-3279

f (886-2) 2298-0488

www.tw.sgs.com

Member of SGS Group

| | | | |
|-----------------------|------------|--------------------------|-------------------|
| Operation Band | :BLE | Test Date | :2017-09-11 |
| Fundamental Frequency | :2402 MHz | Temp./Humi. | :21 deg_C / 61 RH |
| Operation Mode | :Tx CH LOW | Engineer | :Tin |
| EUT Pol. | :E2 Plane | Measurement Antenna Pol. | :HORIZONTAL |

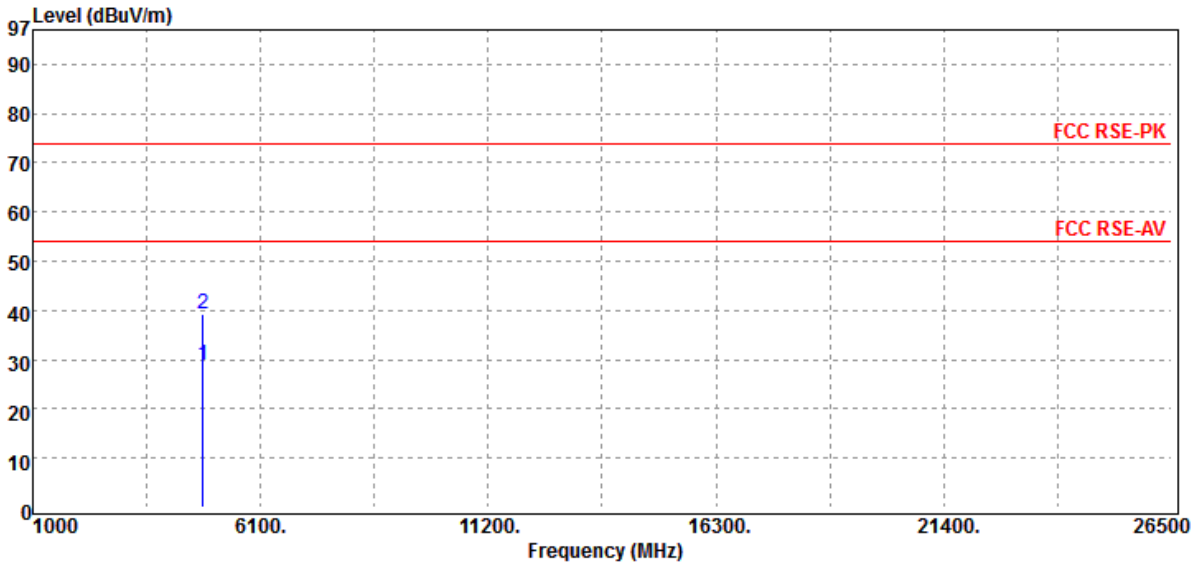

| Freq. MHz | Note F/H/E/S | Detector Mode PK/QP/AV | Spectrum Reading Level dB μ V | Factor dB | Actual FS dB μ V/m | Limit @3m dB μ V/m | Safe Margin dB |
|--------------|-----------------|------------------------------|---|--------------|------------------------------|------------------------------|----------------------|
| 4804.00 | H | Average | 23.79 | 4.92 | 28.71 | 54.00 | -25.29 |
| 4804.00 | H | Peak | 34.33 | 4.92 | 39.25 | 74.00 | -34.75 |

Unless otherwise stated the results shown in this test report refer only to the sample(s) tested and such sample(s) are retained for 90 days only.

除非另有說明，此報告結果僅對測試之樣品負責，同時此樣品僅保留90天。本報告未經本公司書面許可，不可部份複製。

This document is issued by the Company subject to its General Conditions of Service printed overleaf, available on request or accessible at www.sgs.com/terms_and_conditions.htm and, for electronic format documents, subject to Terms and Conditions for Electronic Documents at www.sgs.com/terms_e-document.htm. Attention is drawn to the limitation of liability, indemnification and jurisdiction issues defined therein. Any holder of this document is advised that information contained hereon reflects the Company's findings at the time of its intervention only and within the limits of Client's instructions, if any. The Company's sole responsibility is to its Client and this document does not exonerate parties to a transaction from exercising all their rights and obligations under the transaction documents. This document cannot be reproduced except in full, without prior written approval of the Company. Any unauthorized alteration, forgery or falsification of the content or appearance of this document is unlawful and offenders may be prosecuted to the fullest extent of the law.

SGS Taiwan Ltd.

No.134,WuKungRoad,NewTaipeiIndustrialPark,WukuDistrict,NewTaipeiCity,Taiwan24803/新北市五股區新北產業園區五工路 134 號

台灣檢驗科技股份有限公司

t (886-2) 2299-3279

f (886-2) 2298-0488

www.tw.sgs.com

Member of SGS Group

| | | | |
|-----------------------|------------|--------------------------|-------------------|
| Operation Band | :BLE | Test Date | :2017-09-11 |
| Fundamental Frequency | :2442 MHz | Temp./Humi. | :21 deg_C / 61 RH |
| Operation Mode | :Tx CH MID | Engineer | :Tin |
| EUT Pol. | :E2 Plane | Measurement Antenna Pol. | :VERTICAL |

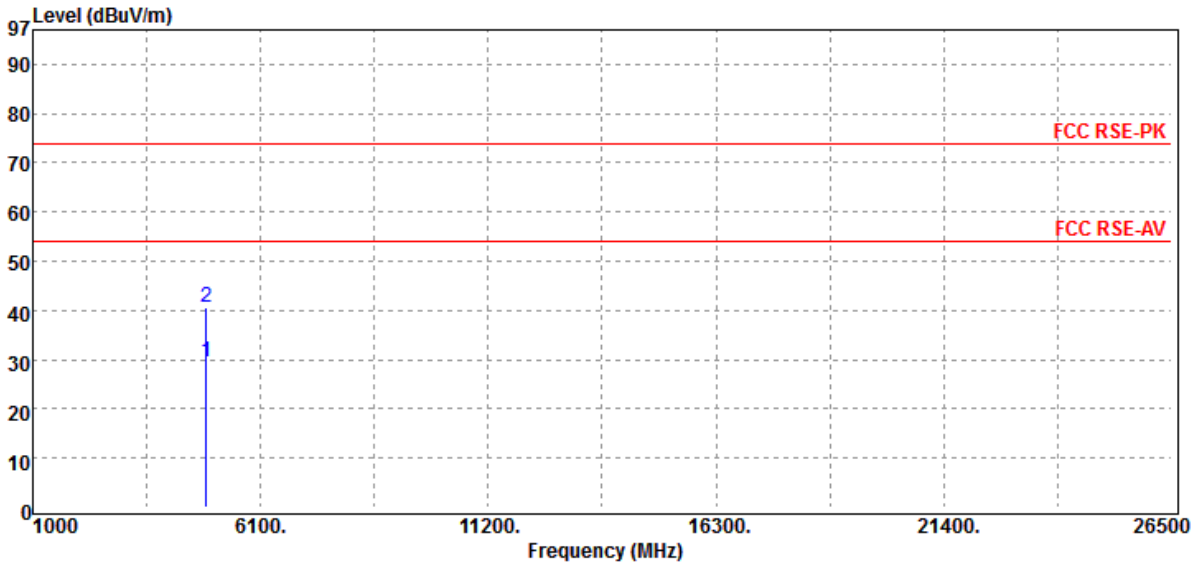

| Freq. MHz | Note F/H/E/S | Detector Mode PK/QP/AV | Spectrum Reading Level dBμV | Factor dB | Actual FS dBμV/m | Limit @3m dBμV/m | Safe Margin dB |
|--------------|-----------------|------------------------------|-----------------------------------|--------------|------------------------|------------------------|----------------------|
| 4884.00 | H | Average | 24.21 | 5.20 | 29.41 | 54.00 | -24.59 |
| 4884.00 | H | Peak | 35.48 | 5.20 | 40.68 | 74.00 | -33.32 |

Unless otherwise stated the results shown in this test report refer only to the sample(s) tested and such sample(s) are retained for 90 days only.

除非另有說明，此報告結果僅對測試之樣品負責，同時此樣品僅保留90天。本報告未經本公司書面許可，不可部份複製。

This document is issued by the Company subject to its General Conditions of Service printed overleaf, available on request or accessible at www.sgs.com/terms_and_conditions.htm and, for electronic format documents, subject to Terms and Conditions for Electronic Documents at www.sgs.com/terms_e-document.htm. Attention is drawn to the limitation of liability, indemnification and jurisdiction issues defined therein. Any holder of this document is advised that information contained hereon reflects the Company's findings at the time of its intervention only and within the limits of Client's instructions, if any. The Company's sole responsibility is to its Client and this document does not exonerate parties to a transaction from exercising all their rights and obligations under the transaction documents. This document cannot be reproduced except in full, without prior written approval of the Company. Any unauthorized alteration, forgery or falsification of the content or appearance of this document is unlawful and offenders may be prosecuted to the fullest extent of the law.

SGS Taiwan Ltd.

No.134,WuKungRoad,NewTaipeiIndustrialPark,WukuDistrict,NewTaipeiCity,Taiwan24803/新北市五股區新北產業園區五工路 134 號

台灣檢驗科技股份有限公司

t (886-2) 2299-3279

f (886-2) 2298-0488

www.tw.sgs.com

Member of SGS Group

| | | | |
|-----------------------|------------|--------------------------|-------------------|
| Operation Band | :BLE | Test Date | :2017-09-11 |
| Fundamental Frequency | :2442 MHz | Temp./Humi. | :21 deg_C / 61 RH |
| Operation Mode | :Tx CH MID | Engineer | :Tin |
| EUT Pol. | :E2 Plane | Measurement Antenna Pol. | :HORIZONTAL |

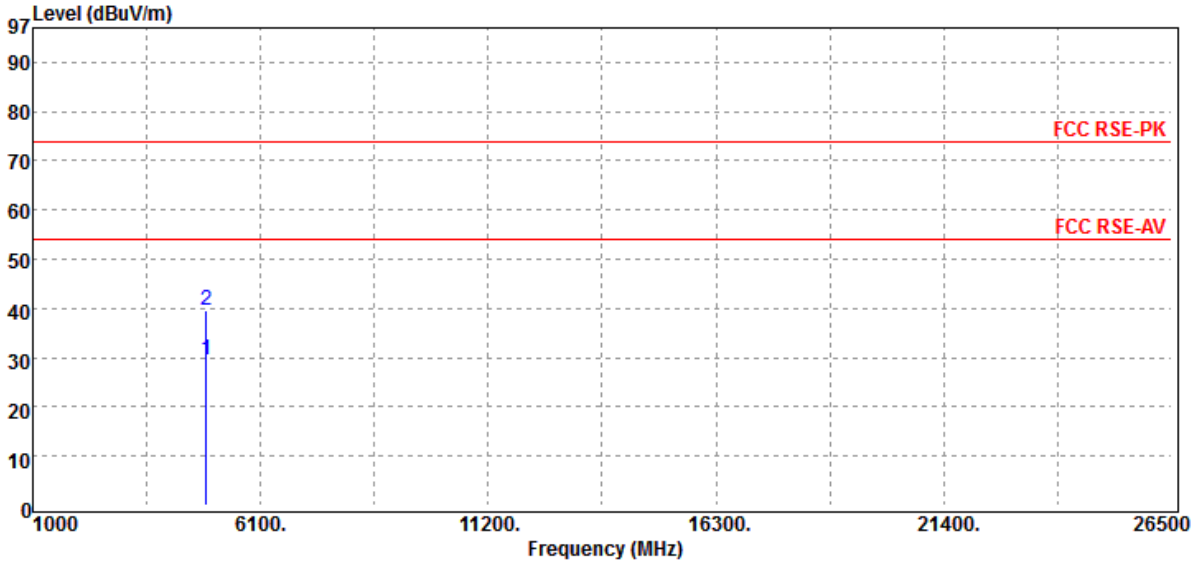

| Freq. MHz | Note F/H/E/S | Detector Mode PK/QP/AV | Spectrum Reading Level dBμV | Factor dB | Actual FS dBμV/m | Limit @3m dBμV/m | Safe Margin dB |
|--------------|-----------------|------------------------------|-----------------------------------|--------------|------------------------|------------------------|----------------------|
| 4884.00 | H | Average | 24.30 | 5.20 | 29.50 | 54.00 | -24.50 |
| 4884.00 | H | Peak | 34.56 | 5.20 | 39.76 | 74.00 | -34.24 |

Unless otherwise stated the results shown in this test report refer only to the sample(s) tested and such sample(s) are retained for 90 days only.

除非另有說明，此報告結果僅對測試之樣品負責，同時此樣品僅保留90天。本報告未經本公司書面許可，不可部份複製。

This document is issued by the Company subject to its General Conditions of Service printed overleaf, available on request or accessible at www.sgs.com/terms_and_conditions.htm and, for electronic format documents, subject to Terms and Conditions for Electronic Documents at www.sgs.com/terms_e-document.htm. Attention is drawn to the limitation of liability, indemnification and jurisdiction issues defined therein. Any holder of this document is advised that information contained hereon reflects the Company's findings at the time of its intervention only and within the limits of Client's instructions, if any. The Company's sole responsibility is to its Client and this document does not exonerate parties to a transaction from exercising all their rights and obligations under the transaction documents. This document cannot be reproduced except in full, without prior written approval of the Company. Any unauthorized alteration, forgery or falsification of the content or appearance of this document is unlawful and offenders may be prosecuted to the fullest extent of the law.

SGS Taiwan Ltd.

No.134,WuKungRoad,NewTaipeiIndustrialPark,WukuDistrict,NewTaipeiCity,Taiwan24803/新北市五股區新北產業園區五工路 134 號

台灣檢驗科技股份有限公司

t (886-2) 2299-3279

f (886-2) 2298-0488

www.tw.sgs.com

Member of SGS Group

| | | | |
|-----------------------|-------------|--------------------------|-------------------|
| Operation Band | :BLE | Test Date | :2017-09-11 |
| Fundamental Frequency | :2480 MHz | Temp./Humi. | :21 deg_C / 61 RH |
| Operation Mode | :Tx CH HIGH | Engineer | :Tin |
| EUT Pol. | :E2 Plane | Measurement Antenna Pol. | :VERTICAL |

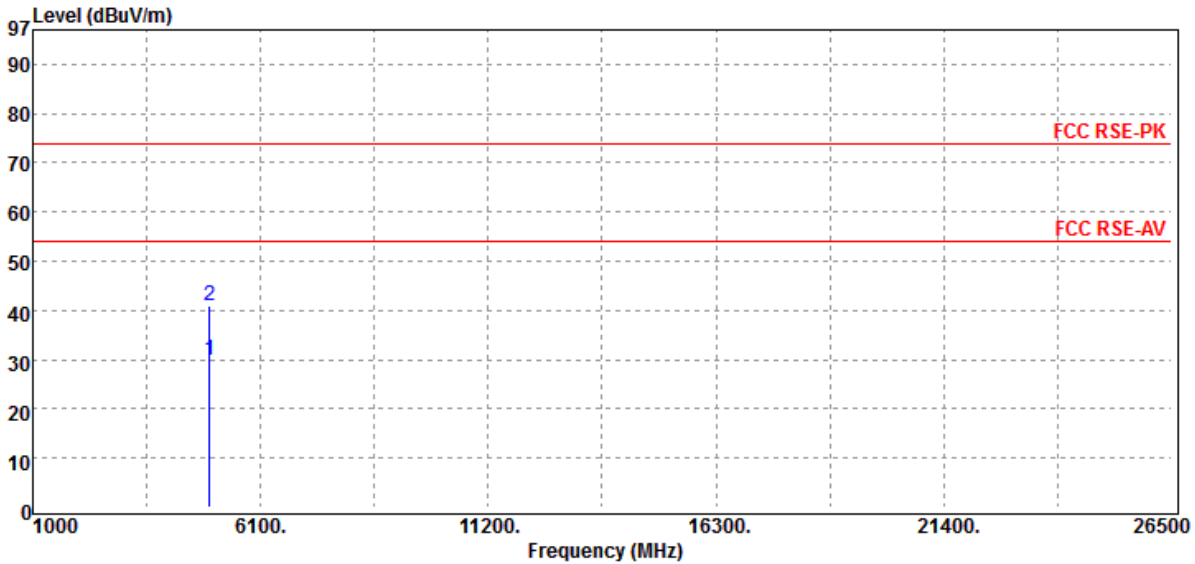

| Freq. MHz | Note F/H/E/S | Detector Mode PK/QP/AV | Spectrum Reading Level d μ V | Factor dB | Actual FS d μ V/m | Limit @3m d μ V/m | Safe Margin dB |
|--------------|-----------------|------------------------------|--|--------------|-----------------------------|-----------------------------|----------------------|
| 4960.00 | H | Average | 24.63 | 5.29 | 29.92 | 54.00 | -24.08 |
| 4960.00 | H | Peak | 35.55 | 5.29 | 40.84 | 74.00 | -33.16 |

Unless otherwise stated the results shown in this test report refer only to the sample(s) tested and such sample(s) are retained for 90 days only.

除非另有說明，此報告結果僅對測試之樣品負責，同時此樣品僅保留90天。本報告未經本公司書面許可，不可部份複製。

This document is issued by the Company subject to its General Conditions of Service printed overleaf, available on request or accessible at www.sgs.com/terms_and_conditions.htm and, for electronic format documents, subject to Terms and Conditions for Electronic Documents at www.sgs.com/terms_e-document.htm. Attention is drawn to the limitation of liability, indemnification and jurisdiction issues defined therein. Any holder of this document is advised that information contained hereon reflects the Company's findings at the time of its intervention only and within the limits of Client's instructions, if any. The Company's sole responsibility is to its Client and this document does not exonerate parties to a transaction from exercising all their rights and obligations under the transaction documents. This document cannot be reproduced except in full, without prior written approval of the Company. Any unauthorized alteration, forgery or falsification of the content or appearance of this document is unlawful and offenders may be prosecuted to the fullest extent of the law.

SGS Taiwan Ltd.

No.134,WuKungRoad,NewTaipeiIndustrialPark,WukuDistrict,NewTaipeiCity,Taiwan24803/新北市五股區新北產業園區五工路 134 號

台灣檢驗科技股份有限公司

t (886-2) 2299-3279

f (886-2) 2298-0488

www.tw.sgs.com

Member of SGS Group

| | | | |
|-----------------------|-------------|--------------------------|-------------------|
| Operation Band | :BLE | Test Date | :2017-09-11 |
| Fundamental Frequency | :2480 MHz | Temp./Humi. | :21 deg_C / 61 RH |
| Operation Mode | :Tx CH HIGH | Engineer | :Tin |
| EUT Pol. | :E2 Plane | Measurement Antenna Pol. | :HORIZONTAL |

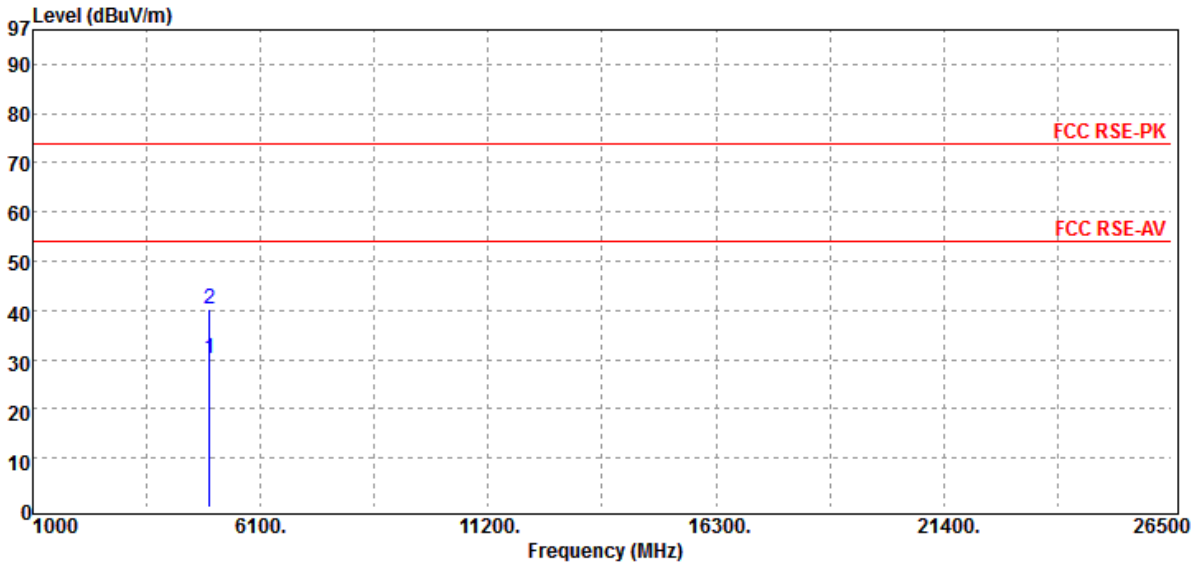

| Freq. MHz | Note F/H/E/S | Detector Mode PK/QP/AV | Spectrum Reading Level d μ V | Factor dB | Actual FS d μ V/m | Limit @3m d μ V/m | Safe Margin dB |
|--------------|-----------------|------------------------------|--|--------------|-----------------------------|-----------------------------|----------------------|
| 4960.00 | H | Average | 25.03 | 5.29 | 30.32 | 54.00 | -23.68 |
| 4960.00 | H | Peak | 34.91 | 5.29 | 40.20 | 74.00 | -33.80 |

Unless otherwise stated the results shown in this test report refer only to the sample(s) tested and such sample(s) are retained for 90 days only.

除非另有說明，此報告結果僅對測試之樣品負責，同時此樣品僅保留90天。本報告未經本公司書面許可，不可部份複製。

This document is issued by the Company subject to its General Conditions of Service printed overleaf, available on request or accessible at www.sgs.com/terms_and_conditions.htm and, for electronic format documents, subject to Terms and Conditions for Electronic Documents at www.sgs.com/terms_e-document.htm. Attention is drawn to the limitation of liability, indemnification and jurisdiction issues defined therein. Any holder of this document is advised that information contained hereon reflects the Company's findings at the time of its intervention only and within the limits of Client's instructions, if any. The Company's sole responsibility is to its Client and this document does not exonerate parties to a transaction from exercising all their rights and obligations under the transaction documents. This document cannot be reproduced except in full, without prior written approval of the Company. Any unauthorized alteration, forgery or falsification of the content or appearance of this document is unlawful and offenders may be prosecuted to the fullest extent of the law.

SGS Taiwan Ltd.

No.134,WuKungRoad,NewTaipeiIndustrialPark,WukuDistrict,NewTaipeiCity,Taiwan24803/新北市五股區新北產業園區五工路 134 號

台灣檢驗科技股份有限公司

t (886-2) 2299-3279

f (886-2) 2298-0488

www.tw.sgs.com

Member of SGS Group

7 ANTENNA REQUIREMENT

7.1 Standard Applicable:

For intentional device, according to §15.203, an intentional radiator shall be designed to ensure that no antenna other than furnished by the responsible party shall be used with the device.

If the transmitting antenna is greater than 6dBi, the power shall be reduced by the same level in dB comparing to gain minus 6dBi.

In case of point-to-point operation, the power shall be reduced by the one dB for every 3 dB that the directional gain of antenna exceeds 6dBi.

7.2 Antenna Connected Construction:

The antenna is designed with unique type RF connector and no consideration of replacement. Please see EUT photo and antenna spec. for details.

~ End of Report ~

Unless otherwise stated the results shown in this test report refer only to the sample(s) tested and such sample(s) are retained for 90 days only.

除非另有說明，此報告結果僅對測試之樣品負責，同時此樣品僅保留90天。本報告未經本公司書面許可，不可部份複製。

This document is issued by the Company subject to its General Conditions of Service printed overleaf, available on request or accessible at www.sgs.com/terms_and_conditions.htm and, for electronic format documents, subject to Terms and Conditions for Electronic Documents at www.sgs.com/terms_e-document.htm. Attention is drawn to the limitation of liability, indemnification and jurisdiction issues defined therein. Any holder of this document is advised that information contained hereon reflects the Company's findings at the time of its intervention only and within the limits of Client's instructions, if any. The Company's sole responsibility is to its Client and this document does not exonerate parties to a transaction from exercising all their rights and obligations under the transaction documents. This document cannot be reproduced except in full, without prior written approval of the Company. Any unauthorized alteration, forgery or falsification of the content or appearance of this document is unlawful and offenders may be prosecuted to the fullest extent of the law.

SGS Taiwan Ltd.

台灣檢驗科技股份有限公司

No.134,WuKungRoad,NewTaipeiIndustrialPark,WukuDistrict,NewTaipeiCity,Taiwan24803/新北市五股區新北產業園區五工路134號

t (886-2) 2299-3279

f (886-2) 2298-0488

www.tw.sgs.com

Member of SGS Group