



# RADIO TEST REPORT

**Test Report No. : 32FE0146-HO-01-A-R1**

**Applicant** : silex technology, Inc.  
**Type of Equipment** : SDIO Wireless Module  
**Model No.** : PF-SDMGN  
**FCC ID** : N6C-PFSDMGN  
**Test regulation** : FCC Part 15 Subpart C: 2012  
**Test Result** : Complied

1. This test report shall not be reproduced in full or partial, without the written approval of UL Japan, Inc.
2. The results in this report apply only to the sample tested.
3. This sample tested is in compliance with the above regulation.
4. The test results in this report are traceable to the national or international standards.
5. This test report must not be used by the customer to claim product certification, approval, or endorsement by NVLAP, NIST, or any agency of the Federal Government.
6. This report is a revised version of 32FE0146-HO-01-A. 32FE0146-HO-01-A is replaced with this report.

**Date of test:** April 26 to May 31, 2012

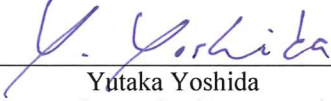
**Representative test engineer:**   
Yutaka Yoshida  
Engineer of WiSE Japan,  
UL Verification Service

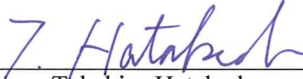
**Approved by:**   
Takahiro Hatakeda  
Leader of WiSE Japan,  
UL Verification Service

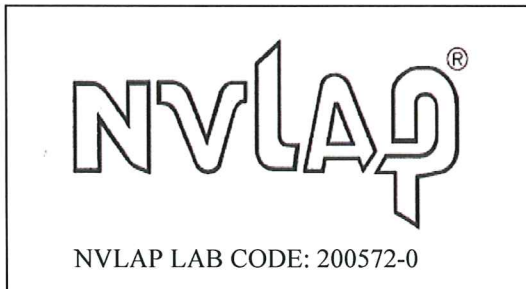

This laboratory is accredited by the NVLAP LAB CODE 200572-0, U.S.A. The tests reported herein have been performed in accordance with its terms of accreditation. \*As for the range of Accreditation in NVLAP, you may refer to the WEB address, <http://www.ul.com/japan/jpn/pages/services/emc/about/mark1/index.jsp#nvlap>

<b>CONTENTS</b>	<b>PAGE</b>
<b>SECTION 1: Customer information.....</b>	<b>3</b>
<b>SECTION 2: Equipment under test (E.U.T.).....</b>	<b>3</b>
<b>SECTION 3: Test specification, procedures &amp; results.....</b>	<b>4</b>
<b>SECTION 4: Operation of E.U.T. during testing.....</b>	<b>7</b>
<b>SECTION 5: Conducted Emission.....</b>	<b>9</b>
<b>SECTION 6: Radiated Spurious Emission .....</b>	<b>10</b>
<b>SECTION 7: Antenna Terminal Conducted Tests.....</b>	<b>11</b>
<b>APPENDIX 1: Data of EMI test.....</b>	<b>12</b>
Conducted Emission .....	12
6dB Bandwidth .....	13
Maximum Peak Output Power .....	16
Radiated Spurious Emission .....	19
Conducted Spurious Emission .....	30
Conducted Emission Band Edge compliance .....	42
Power Density .....	43
99% Occupied Bandwidth .....	45
<b>APPENDIX 2: Test instruments .....</b>	<b>47</b>
<b>APPENDIX 3: Photographs of test setup .....</b>	<b>49</b>
Conducted Emission .....	49
Radiated Spurious Emission .....	50
Worst Case Position .....	51

## **SECTION 1: Customer information**

Company Name : silex technology, Inc.  
Address : 2-3-1 Hikaridai, Seika-cho, Kyoto 619-0237, Japan  
Telephone Number : +81-774-98-3878  
Facsimile Number : +81-774-98-3758  
Contact Person : Toshiro Kometani

## **SECTION 2: Equipment under test (E.U.T.)**

### **2.1 Identification of E.U.T.**

Type of Equipment : SDIO Wireless Module  
Model No. : PF-SDMGN  
Serial No. : Refer to Clause 4.2  
Rating : DC3.3V  
Receipt Date of Sample : April 11, 2012  
Country of Mass-production : Japan  
Condition of EUT : Production prototype  
(Not for Sale: This sample is equivalent to mass-produced items.)  
Modification of EUT : No Modification by the test lab

### **2.2 Product Description**

Model No: PF-SDMGN (referred to as the EUT in this report) is the SDIO Wireless Module.

#### **General Specification**

Clock frequency(ies) in the system : 26MHz

#### **Radio Specification**

Radio Type : Transceiver  
Method of Frequency Generation : Synthesizer  
Power Supply (inner) : DC1.8V, 1.2V  
Antenna Gain : 1.5dBi

	<b>IEEE802.11b</b>	<b>IEEE802.11g</b>	<b>IEEE802.11n (20 M band)</b>
Frequency of operation	2412-2462MHz	2412-2462MHz	2412 - 2462MHz
Type of modulation	DSSS (CCK, DQPSK, DBPSK)	OFDM-CCK (64QAM, 16QAM, QPSK, BPSK)	OFDM (64QAM, 16QAM, QPSK, BPSK)
Channel spacing	5MHz		5MHz
Antenna type	Dipole antenna		
Antenna Connector type	U.FL Alternative connector		

**UL Japan, Inc.**

**Head Office EMC Lab.**

4383-326 Asama-cho, Ise-shi, Mie-ken 516-0021 JAPAN

Telephone : +81 596 24 8116

Facsimile : +81 596 24 8124

**SECTION 3: Test specification, procedures & results**

**3.1 Test Specification**

Test Specification : FCC Part 15 Subpart C: 2012, final revised on May 17, 2012 and effective June 18, 2012

Title : FCC 47CFR Part 15 Radio Frequency Device Subpart C Intentional Radiators Section 15.207 Conducted limits Section 15.247 Operation within the bands 902-928MHz, 2400-2483.5MHz, and 5725-5850MHz

\*The revision on May 17, 2012 does not affect the test specification applied to the EUT.

**3.2 Procedures and results**

Item	Test Procedure	Specification	Worst margin	Results	Remarks
Conducted Emission	FCC: ANSI C63.4:2003 7. AC powerline Conducted Emission measurements ----- IC: RSS-Gen 7.2.4	FCC: Section 15.207 ----- IC: RSS-Gen 7.2.4	QP 12.9dB, 5.54864MHz, L AV 10.1dB, 5.54864MHz, L	Complied	-
6dB Bandwidth	FCC: "Guidance on Measurement of Digital Transmission Systems Operating under Section 15.247" ----- IC: RSS-Gen 4.6.2	FCC: Section 15.247(a)(2) ----- IC: RSS-210 A8.2(a)	See data.	Complied	Conducted
Maximum Peak Output Power	FCC: "Guidance on Measurement of Digital Transmission Systems Operating under Section 15.247" ----- IC: RSS-Gen 4.8	FCC: Section 15.247(b)(3) ----- IC: RSS-210 A8.4(4)		Complied	Conducted
Power Density	FCC: "Guidance on Measurement of Digital Transmission Systems Operating under Section 15.247" ----- IC: -	FCC: Section 15.247 (e) ----- IC: RSS-210 A8.2(b)		Complied	Conducted
Spurious Emission Restricted Band Edges	FCC: "Guidance on Measurement of Digital Transmission Systems Operating under Section 15.247" ----- IC: RSS-Gen 4.9	FCC: Section 15.247(d) ----- IC: RSS-210 A8.5 RSS-Gen 7.2.3	0.9dB 2390.000MHz, AV, Vert.	Complied	Conducted/ Radiated

Note: UL Japan, Inc.'s EMI Work Procedures No. 13-EM-W0420 and 13-EM-W0422.

\* In case any questions arise about test procedure, ANSI C63.4: 2003 is also referred.

**FCC 15.31 (e)**

The RF Module has own regulator.  
The RF Module is constantly provided voltage through own regulator regardless of input voltage (DC3.3V).  
Therefore, this EUT complies with the requirement.

**FCC Part 15.203/212 Antenna requirement**

The EUT has a unique antenna connector (U.FL on the Module).  
Therefore the equipment complies with the requirement of 15.203/212.

### 3.3 Addition to standard

Item	Test Procedure	Specification	Worst margin	Results	Remarks
99% Occupied Bandwidth	IC: RSS-Gen 4.6.1	IC: RSS-Gen 4.6.1	N/A	-	Conducted

Other than above, no addition, exclusion nor deviation has been made from the standard.

### 3.4 Uncertainty

#### EMI

The following uncertainties have been calculated to provide a confidence level of 95% using a coverage factor k=2.

Test room (semi-anechoic chamber)	Conducted emission (+dB)
	150kHz-30MHz
No.1	3.5dB
No.2	3.6dB
No.3	3.6dB
No.4	3.6dB

Test room (semi-anechoic chamber)	Radiated emission						
	(3m*)(+dB)				(1m*)(+dB)		(0.5m*)(+dB)
	9kHz -30MHz	30MHz -300MHz	300MHz -1GHz	1GHz -10GHz	10GHz -18GHz	18GHz -26.5GHz	26.5GHz -40GHz
No.1	4.2dB	5.0dB	5.1dB	4.7dB	5.7dB	4.4dB	4.3dB
No.2	4.1dB	5.2dB	5.1dB	4.8dB	5.6dB	4.3dB	4.2dB
No.3	4.5dB	5.0dB	5.2dB	4.8dB	5.6dB	4.5dB	4.2dB
No.4	4.7dB	5.2dB	5.2dB	4.8dB	5.6dB	5.1dB	4.2dB

\*3m/1m/0.5m = Measurement distance

Power meter (+dB)	
Below 1GHz	Above 1GHz
1.0dB	1.0dB

Antenna terminal conducted emission and Power density (+dB)			Antenna terminal conducted emission (+dB)		Channel power (+dB)
Below 1GHz	1GHz-3GHz	3GHz-18GHz	18GHz-26.5GHz	26.5GHz-40GHz	
1.0dB	1.1dB	2.7dB	3.2dB	3.3dB	1.5dB

#### Conducted Emission test

The data listed in this test report has enough margin, more than the site margin.

#### Radiated emission test (3m)

The data listed in this report meets the limits unless the uncertainty is taken into consideration.

**UL Japan, Inc.**

**Head Office EMC Lab.**

4383-326 Asama-cho, Ise-shi, Mie-ken 516-0021 JAPAN

Telephone : +81 596 24 8116

Facsimile : +81 596 24 8124

### 3.5 Test Location

UL Japan, Inc. Head Office EMC Lab. \*NVLAP Lab. code: 200572-0  
 4383-326 Asama-cho, Ise-shi, Mie-ken 516-0021 JAPAN  
 Telephone : +81 596 24 8116 Facsimile : +81 596 24 8124

	FCC Registration Number	IC Registration Number	Width x Depth x Height (m)	Size of reference ground plane (m) / horizontal conducting plane	Other rooms
No.1 semi-anechoic chamber	313583	2973C-1	19.2 x 11.2 x 7.7m	7.0 x 6.0m	No.1 Power source room
No.2 semi-anechoic chamber	655103	2973C-2	7.5 x 5.8 x 5.2m	4.0 x 4.0m	-
No.3 semi-anechoic chamber	148738	2973C-3	12.0 x 8.5 x 5.9m	6.8 x 5.75m	No.3 Preparation room
No.3 shielded room	-	-	4.0 x 6.0 x 2.7m	N/A	-
No.4 semi-anechoic chamber	134570	2973C-4	12.0 x 8.5 x 5.9m	6.8 x 5.75m	No.4 Preparation room
No.4 shielded room	-	-	4.0 x 6.0 x 2.7m	N/A	-
No.5 semi-anechoic chamber	-	-	6.0 x 6.0 x 3.9m	6.0 x 6.0m	-
No.6 shielded room	-	-	4.0 x 4.5 x 2.7m	4.75 x 5.4 m	-
No.6 measurement room	-	-	4.75 x 5.4 x 3.0m	4.75 x 4.15 m	-
No.7 shielded room	-	-	4.7 x 7.5 x 2.7m	4.7 x 7.5m	-
No.8 measurement room	-	-	3.1 x 5.0 x 2.7m	N/A	-
No.9 measurement room	-	-	8.0 x 4.5 x 2.8m	2.0 x 2.0m	-
No.10 measurement room	-	-	2.6 x 2.8 x 2.5m	2.4 x 2.4m	-
No.11 measurement room	-	-	3.1 x 3.4 x 3.0m	2.4 x 3.4m	-

\* Size of vertical conducting plane (for Conducted Emission test) : 2.0 x 2.0m for No.1, No.2, No.3, and No.4 semi-anechoic chambers and No.3 and No.4 shielded rooms.

### 3.6 Data of EMI, Test instruments, and Test set up

Refer to APPENDIX.

## **SECTION 4: Operation of E.U.T. during testing**

### **4.1 Operating Mode(s)**

Test operating mode was determined as follows according to “Section 1 of 6 802.11 a/b/g/n testing- Managing Complex Regulatory Approvals - ” of TCB Council Workshop October 2009.

<b>Mode</b>	<b>Remarks*</b>
IEEE 802.11b (11b)	11Mbps (Long GI), PN9
IEEE 802.11g (11g)	24Mbps (Long GI), PN9
IEEE 802.11n 20MHz BW (11n-20)	MCS 4 (Long GI), PN9
*Transmitting duty was close to 100% on all tests.	
*The worst condition was determined based on the test result of Maximum Peak Output Power (Mid Channel)	
*EUT has the power settings by the software as follows; Power settings: 11b 11Mbps(Long GI): 13.0 dBm 11g 24Mbps(Long GI): 2412MHz: 10.5 dBm, 2437MHz: 14.5 dBm, 2462MHz: 10.5 dBm 11n-20 MCS 4(Long GI): 2412MHz: 10.0 dBm, 2437MHz: 14.5 dBm, 2462MHz: 10.0 dBm Software: Atheros Radio Test (ART) - Revision 0.2 BUILD #33 ART_11n - Customer Version (ANWI BUILD)	
*Any conditions under the normal use do not exceed the condition of setting. In addition, end users cannot change the settings of the output power of the product.	

\*The details of Operating mode(s)

<b>Test Item</b>	<b>Operating Mode</b>	<b>Tested Antenna</b>	<b>Tested frequency</b>
Conducted Emission	11g Tx *1)	CN1 *3)	2437MHz
Spurious Emission (Radiated), 6dB Bandwidth, 99% Occupied Bandwidth	11b Tx 11g Tx 11n-20 Tx	CN1 *3)	2412MHz 2437MHz 2462MHz
Spurious Emission (Conducted), Power Density	11b Tx 11g Tx *2)	CN1 *3)	2412MHz 2437MHz 2462MHz
Band Edge Compliance (Conducted)	11b Tx 11g Tx 11n-20 Tx	CN1 *3)	2412MHz 2462MHz
Maximum Peak Output Power	11b Tx 11g Tx 11n-20 Tx	CN1, CN2	2412MHz 2437MHz 2462MHz

\*1) The mode was tested as a representative, because it had the highest power at antenna terminal test.

\*2) Since 11g and 11n-20 have the same modulation method and no differences in transmitting specification, test was performed on the representative mode that had the highest peak output power.

\*3) After the comparison between CN1 and CN2, test was performed with the antenna that had higher power as a representative.

**UL Japan, Inc.**

**Head Office EMC Lab.**

4383-326 Asama-cho, Ise-shi, Mie-ken 516-0021 JAPAN

Telephone : +81 596 24 8116

Facsimile : +81 596 24 8124

## 4.2 Configuration and peripherals

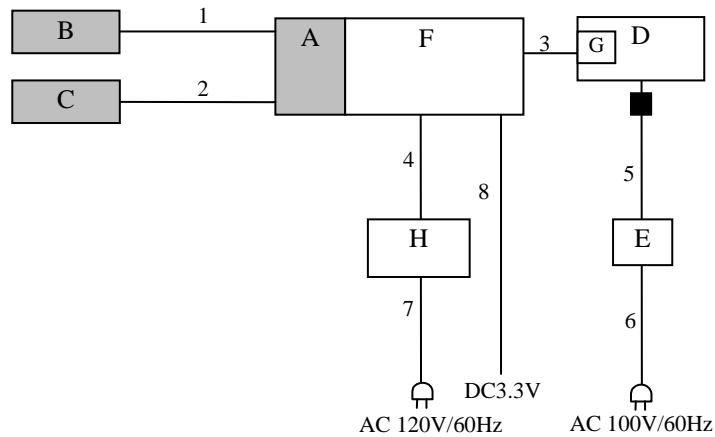

■ : Standard Ferrite Core

\* Cabling and setup were taken into consideration and test data was taken under worse case conditions.

### Description of EUT and Support equipment

No.	Item	Model number	Serial number	Manufacturer	Remark
A	SDIO Wireless Module	PF-SDMGN	008092 012843	silex technology, Inc.	EUT
B	Antenna (CN1)	WHA9400-2001F	001	SMK	EUT
C	Antenna (CN2)	WHA9400-2002F	002	SMK	EUT
D	Laptop PC	E6510	8PJ80M1	DELL	-
E	AC Adaptor	LA90PEO-01	CN-03T6XF-71615-1AK-0927-A01	DELL	-
F	Jig	-	-	silex technology, Inc.	-
G	Express Card Adaptor	-	-	ATHEROS	-
H	DC Power Supply	PMC35-2A	02871	KIKUSUI	*1)

\*1) Used for Conducted emission test only

### List of cables used

No.	Name	Length (m)	Shield		Remark
			Cable	Connector	
1	Antenna Cable	0.44	Shielded	Shielded	-
2	Antenna Cable	0.44	Shielded	Shielded	-
3	MiniPCI Cable	0.3	Shielded	Unshielded	-
4	DC Cable	2.0	Unshielded	Unshielded	*1)
5	DC Cable	1.8	Unshielded	Unshielded	-
6	AC Cable	0.9	Unshielded	Unshielded	-
7	AC Cable	0.9	Unshielded	Unshielded	*1)
8	DC Cable	3.0	Unshielded	Unshielded	*2)

\*1) Used for Conducted emission test only

\*2) Used for all tests except for Conducted emission test

**UL Japan, Inc.**

**Head Office EMC Lab.**

4383-326 Asama-cho, Ise-shi, Mie-ken 516-0021 JAPAN

Telephone : +81 596 24 8116

Facsimile : +81 596 24 8124



## **SECTION 5: Conducted Emission**

### **Test Procedure and conditions**

EUT was placed on a urethane platform of nominal size, 1.0m by 1.5m, raised 0.8m above the conducting ground plane.

The rear of tabletop was located 40cm to the vertical conducting plane. The rear of EUT, including peripherals aligned and flushed with rear of tabletop. All other surfaces of tabletop were at least 80cm from any other grounded conducting surface. EUT was located 80cm from a Line Impedance Stabilization Network (LISN)/ Artificial mains Network (AMN) and excess AC cable was bundled in center.

For the tests on EUT with other peripherals (as a whole system)

I/O cables that were connected to the peripherals were bundled in center. They were folded back and forth forming a bundle 30cm to 40cm long and were hanged at a 40cm height to the ground plane. All unused 50ohm connectors of the LISN(AMN) were resistivity terminated in 50ohm when not connected to the measuring equipment.

The AC Mains Terminal Continuous disturbance Voltage has been measured with the EUT in a Semi Anechoic Chamber.

The EUT was connected to a LISN (AMN).

An overview sweep with peak detection has been performed.

The test results and limit are rounded off to one decimal place, so some differences might be observed.

**Detector** : QP and AV  
**Measurement range** : 0.15-30MHz  
**Test data** : APPENDIX  
**Test result** : Pass

---

**UL Japan, Inc.**

**Head Office EMC Lab.**

4383-326 Asama-cho, Ise-shi, Mie-ken 516-0021 JAPAN

Telephone : +81 596 24 8116

Facsimile : +81 596 24 8124

## **SECTION 6: Radiated Spurious Emission**

### **Test Procedure**

It was measured based on "2. Radiated emission test" of "Guidance on Measurement of Digital Transmission Systems Operating under Section 15.247".

EUT was placed on a urethane platform of nominal size, 1.0m by 1.5m, raised 0.8m above the conducting ground plane.

The Radiated Electric Field Strength has been measured in a Semi Anechoic Chamber with a ground plane.

The height of the measuring antenna varied between 1 and 4m and EUT was rotated a full revolution in order to obtain the maximum value of the electric field strength.

The measurements were performed for both vertical and horizontal antenna polarization with the Test Receiver, or the Spectrum Analyzer.

The measurements were made with the following detector function of the test receiver and the Spectrum analyzer (in linear mode).

The test was made with the detector (RBW/VBW) in the following table.

When using Spectrum analyzer, the test was made with adjusting span to zero by using peak hold.

### **Test Antennas are used as below;**

Frequency	30MHz to 300MHz	300MHz to 1GHz	Above 1GHz
Antenna Type	Biconical	Logperiodic	Horn

In any 100kHz bandwidth outside the restricted band in which the spread spectrum intentional radiator is operating, the radio frequency power that is produced by the intentional radiator confirmed 20dB below that in the 100kHz bandwidth within the band that contains the highest level of the desired power, based on a radiated measurement.

### **20dBc was applied to the frequency over the limit of FCC 15.209 / Table 5 of RSS-Gen 7.2.5(IC) and outside the restricted band of FCC 15.205 / Table 3 of RSS-Gen 7.2.2 (IC).**

Frequency	Below 1GHz	Above 1GHz		20dBc
Instrument used	Test Receiver	Spectrum Analyzer		Spectrum Analyzer
Detector	QP	PK	AV	PK
IF Bandwidth	BW 120kHz(T/R)	RBW: 1MHz VBW: 3MHz	RBW: 1MHz VBW: 10Hz *1)	RBW: 100kHz VBW: 300kHz (S/A)
Test Distance	3m	3m (below 10GHz), 1m*2) (above 10GHz)		3m (below 10GHz), 1m*2) (above 10GHz)

\*1) The test was performed with VBW 10Hz since the EUT had transmitting duty cycle close to 100%. (see Appendix).

\*2) Distance Factor:  $20 \times \log(3.0\text{m}/1.0\text{m}) = 9.5\text{dB}$

- The carrier level and noise levels were confirmed at each position of X, Y and Z axes of EUT (Antenna, Module) to see the position of maximum noise, and the test was made at the position that has the maximum noise.

The test results and limit are rounded off to one decimal place, so some differences might be observed.

**Measurement range** : 30M-26.5GHz  
**Test data** : APPENDIX  
**Test result** : Pass

---

**UL Japan, Inc.**

**Head Office EMC Lab.**

4383-326 Asama-cho, Ise-shi, Mie-ken 516-0021 JAPAN

Telephone : +81 596 24 8116

Facsimile : +81 596 24 8124

## **SECTION 7: Antenna Terminal Conducted Tests**

### **Test Procedure**

The tests were made with below setting connected to the antenna port.

Test	Span	RBW	VBW	Sweep time	Detector	Trace	Instrument used
6dB Bandwidth	20MHz	100kHz	300kHz	Auto	Peak	Max Hold	Spectrum Analyzer
99% Occupied Bandwidth	Enough width to display 20dB Bandwidth	1 to 3% of Span	Three times of RBW	Auto	Peak	Max Hold	Spectrum Analyzer
Maximum Peak Output Power	-	-	-	Auto	Peak	-	Power Meter (Sensor: 50MHz BW)
Peak Power Density	20MHz	30kHz	100kHz	667sec	Peak	Max Hold	Spectrum Analyzer *1) *2)
Conducted Spurious Emission *3)	9kHz to 150kHz	200Hz	620Hz	Auto	Peak	Max Hold	Spectrum Analyzer
	150kHz to 30MHz	9.1kHz	27kHz				
	30MHz to 25GHz (Less or equal to 5GHz)	100kHz	300kHz				

\*1) PSD Option 1 of "Guidance on Measurement of Digital Transmission Systems Operating under Section 15.247".

\*2) The test was not performed at RBW:3kHz however the measurement is to be performed with RBW:3kHz in the regulation, because, the measurement value with RBW:3kHz is less than the value of RBW:30kHz and the test data met the limit with RBW:30kHz.

\*3) In the frequency range below 30MHz, RBW was narrowed to separate the noise contents.

Then, wide-band noise near the limit was checked separately, however the noise was low enough as shown in the chart. (9kHz-150kHz:RBW=200Hz, 150kHz-30MHz:RBW=9.1kHz).

The test results and limit are rounded off to two decimals place, so some differences might be observed.

**Test data** : **APPENDIX**  
**Test result** : **Pass**

**APPENDIX 1: Data of EMI test**

**Conducted Emission**

**DATA OF CONDUCTED EMISSION TEST**

UL Japan, Inc. Head Office EMC Lab. No.3 Semi Anechoic Chamber  
 Date : 2012/05/15

Report No. : 32FE0146-H0-01  
 Temp./Humi. : 25deg. C / 44% RH  
 Engineer : Hironobu Ohnishi

Mode / Remarks : Tx 11g 24Mbps(Long GI) 2437MHz, CN1

LIMIT : FCC15.207 QP  
 FCC15.207 AV

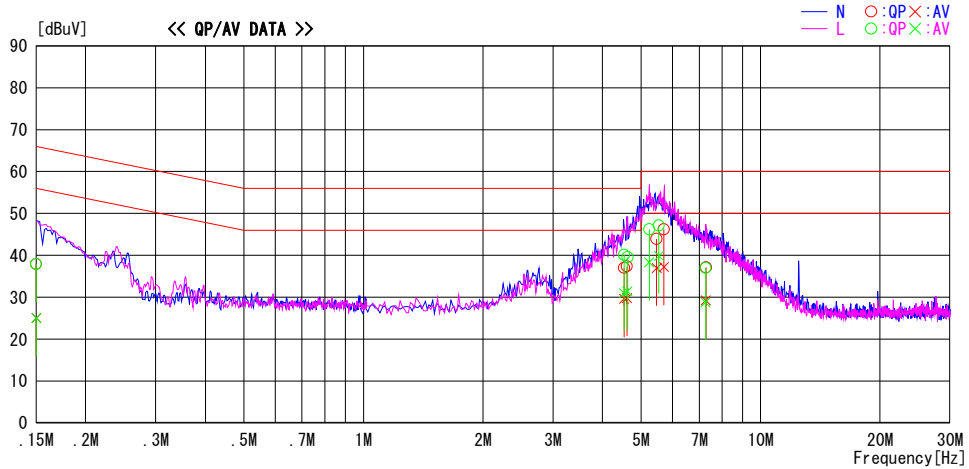

Frequency [MHz]	Reading Level		Corr. Factor [dB]	Results		Limit		Margin		Phase	Comment
	QP [dBuV]	AV [dBuV]		QP [dBuV]	AV [dBuV]	QP [dBuV]	AV [dBuV]	QP [dB]	AV [dB]		
0.15000	24.6	11.8	13.3	37.9	25.1	66.0	56.0	28.1	30.9	N	
4.53242	23.3	15.9	13.7	37.0	29.6	56.0	46.0	19.0	16.4	N	
4.60801	23.7	16.1	13.7	37.4	29.8	56.0	46.0	18.6	16.2	N	
5.47291	30.2	23.3	13.7	43.9	37.0	60.0	50.0	16.1	13.0	N	
5.71152	32.4	23.4	13.8	46.2	37.2	60.0	50.0	13.8	12.8	N	
7.28366	23.2	15.3	13.9	37.1	29.2	60.0	50.0	22.9	20.8	N	
0.15000	24.6	11.8	13.3	37.9	25.1	66.0	56.0	28.1	30.9	L	
4.53242	26.4	17.3	13.7	40.1	31.0	56.0	46.0	15.9	15.0	L	
4.62312	25.9	17.7	13.7	39.6	31.4	56.0	46.0	16.4	14.6	L	
5.24291	32.5	24.6	13.7	46.2	38.3	60.0	50.0	13.8	11.7	L	
5.54864	33.3	26.1	13.8	47.1	39.9	60.0	50.0	12.9	10.1	L	
7.26854	23.1	14.9	13.9	37.0	28.8	60.0	50.0	23.0	21.2	L	

CHART: WITH FACTOR, Peak hold data. CALCULATION: RESULT=READING+C.F(LISN LOSS+ATT LOSS +CABLE LOSS)  
 Except for the above table : adequate margin data below the limits.

## 6dB Bandwidth

Test place Head Office EMC Lab. No.11 Measurement Room  
Report No. 32FE0146-HO-01  
Date 04/27/2012  
Temperature/ Humidity 20deg. C / 59% RH  
Engineer Yutaka Yoshida  
Mode Tx

11b, 11Mbps(Long GI), Antenna CN1

Frequency [MHz]	6dB Bandwidth [MHz]	Limit [kHz]
2412	11.103	>500
2437	11.199	>500
2462	11.240	>500

11g, 24Mbps(Long GI), Antenna CN1

Frequency [MHz]	6dB Bandwidth [MHz]	Limit [kHz]
2412	16.470	>500
2437	16.479	>500
2462	16.478	>500

11n-20, MCS 4(Long GI), Antenna CN1

Frequency [MHz]	6dB Bandwidth [MHz]	Limit [kHz]
2412	17.678	>500
2437	17.700	>500
2462	17.665	>500

### 6dB Bandwidth

#### 11b, 11Mbps(Long GI), Antenna CN1

#### 11g, 24Mbps(Long GI), Antenna CN1

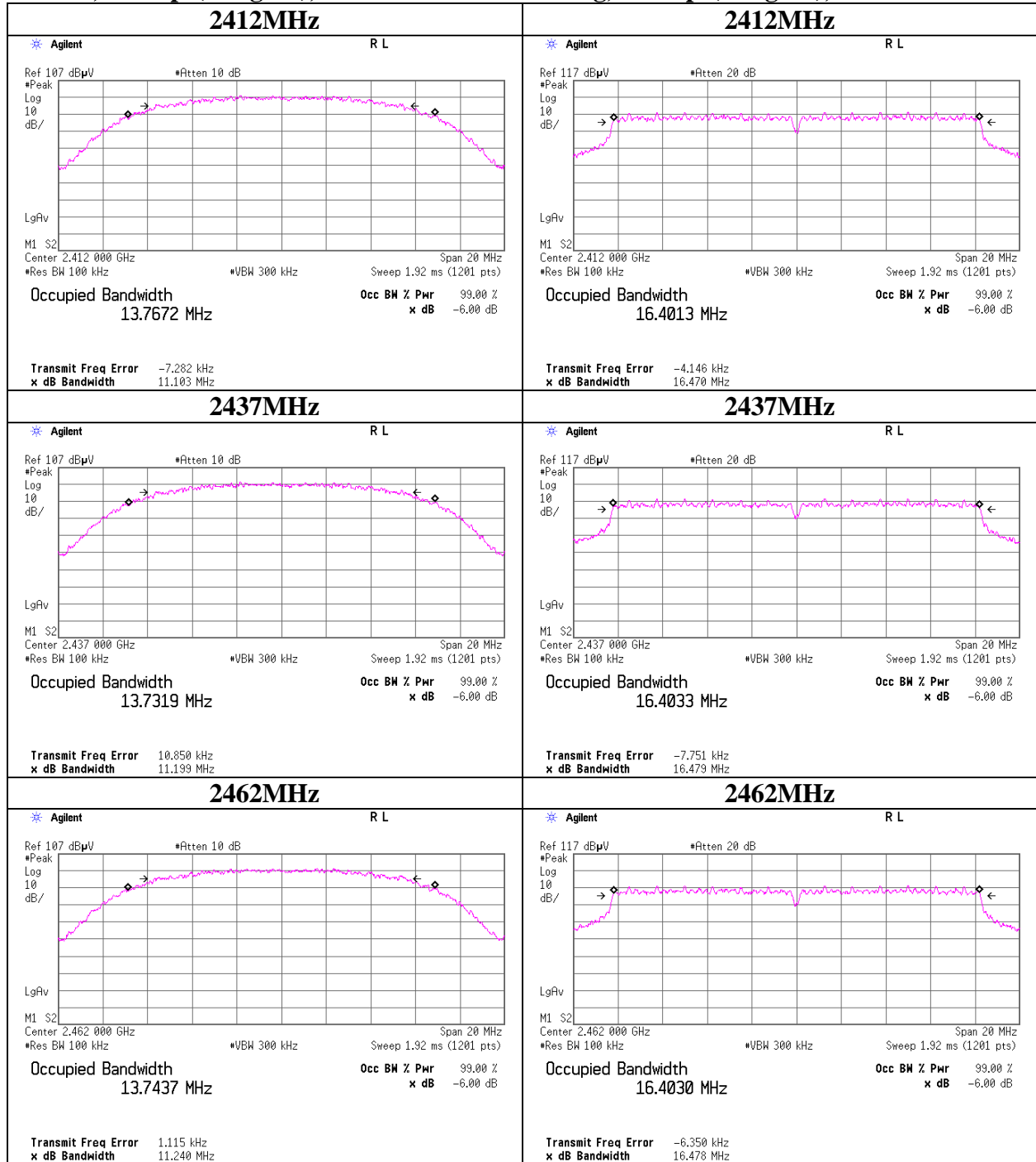

## 6dB Bandwidth

### 11n-20, MCS 4(Long GI), Antenna CN1

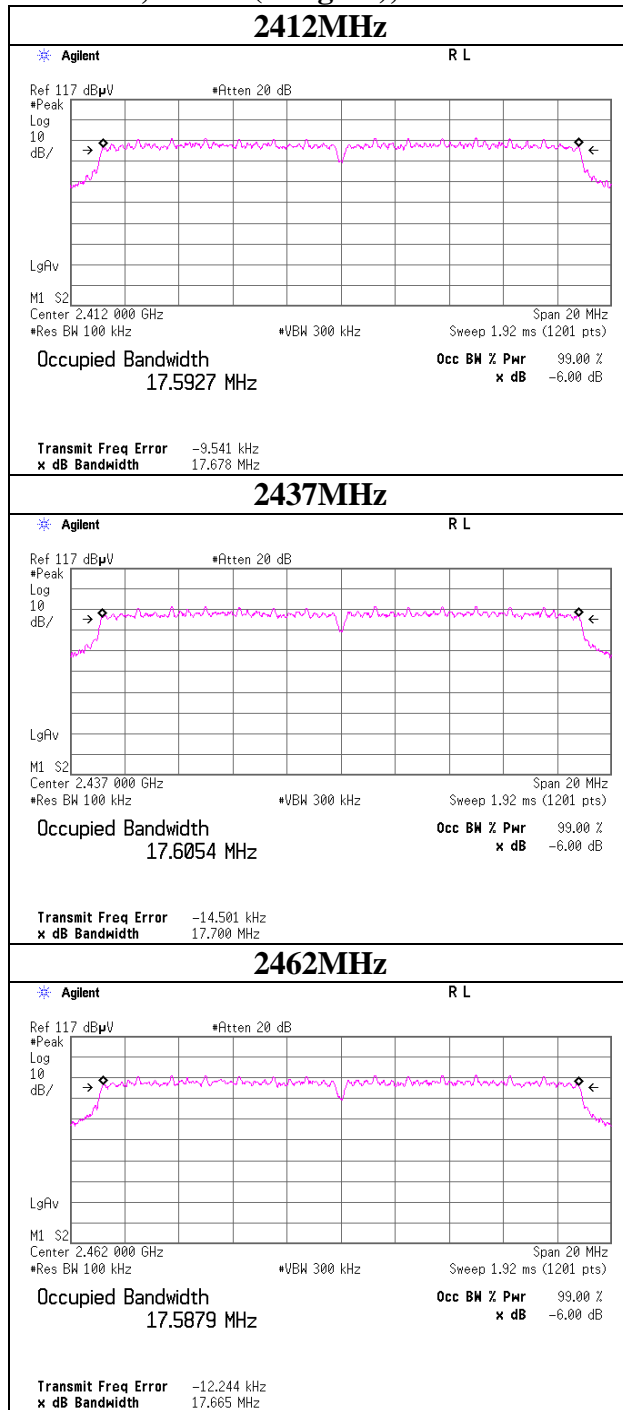

### Maximum Peak Output Power

Test place	Head Office EMC Lab. No.11 Measurement Room
Report No.	32FE0146-HO-01
Date	04/26/2012
Temperature/ Humidity	22 deg. C / 66% RH
Engineer	Hironobu Ohnishi
Mode	11b Tx

11b, 11Mbps(Long GI), Antenna CN1

Freq. [MHz]	Reading [dBm]	Cable Loss [dB]	Atten. [dB]	Result		Limit		Margin [dB]
				[dBm]	[mW]	[dBm]	[mW]	
2412	4.36	0.71	10.01	15.08	32.23	30.00	1000	14.92
2437	4.56	0.71	10.01	15.28	33.76	30.00	1000	14.72
2462	4.77	0.72	10.01	15.50	35.45	30.00	1000	14.50

11b, 11Mbps(Long GI), Antenna CN2

Freq. [MHz]	Reading [dBm]	Cable Loss [dB]	Atten. [dB]	Result		Limit		Margin [dB]
				[dBm]	[mW]	[dBm]	[mW]	
2412	4.33	0.71	10.01	15.05	32.00	30.00	1000	14.95
2437	4.47	0.71	10.01	15.19	33.07	30.00	1000	14.81
2462	4.70	0.72	10.01	15.43	34.89	30.00	1000	14.57

Sample Calculation:

Result = Reading + Cable Loss + Attenuator

Antenna CN1, 2437MHz

Rate Preamble [Mbps]	Reading	
	Long [dBm]	Short [dBm]
1	4.30	-
2	4.36	4.37
5.5	4.55	4.49
11	4.56 *	4.53

\*: Worst Rate

All comparizon were carried out on same frequency and measurement factors.



### Maximum Peak Output Power

Test place	Head Office EMC Lab. No.11 Measurement Room	
Report No.	32FE0146-HO-01	
Date	04/26/2012	05/22/2012
Temperature/ Humidity	22 deg. C / 66% RH	24 deg. C / 56% RH
Engineer	Hironobu Ohnishi	Satofumi Matsuyama
Mode	11g, Tx	

11g, 24Mbps(Long GI), Antenna CN1

Freq. [MHz]	Reading [dBm]	Cable Loss [dB]	Atten. [dB]	Result		Limit		Margin [dB]
				[dBm]	[mW]	[dBm]	[mW]	
2412	10.18	0.71	10.01	20.90	123.08	30.00	1000	9.10
2437	12.17	0.71	10.01	22.89	194.73	30.00	1000	7.11
2462	10.15	0.72	10.01	20.88	122.36	30.00	1000	9.12

11g, 24Mbps(Long GI), Antenna CN2

Freq. [MHz]	Reading [dBm]	Cable Loss [dB]	Atten. [dB]	Result		Limit		Margin [dB]
				[dBm]	[mW]	[dBm]	[mW]	
2412	9.86	0.71	10.01	20.58	114.34	30.00	1000	9.42
2437	11.98	0.71	10.01	22.70	186.39	30.00	1000	7.30
2462	9.88	0.72	10.01	20.61	114.99	30.00	1000	9.39

Sample Calculation:

Result = Reading + Cable Loss + Attenuator

Antenna CN1, 2437MHz

Rate [Mbps]	Reading	
	Long GI [dBm]	Short GI [dBm]
6	11.73	
9	11.86	
12	11.80	
18	11.89	
24	12.17 *	12.16
36	12.00	
48	12.02	
54	10.55	

\*: Worst Rate

GI: Guard Interval

All comparison were carried out on same frequency and measurement factors.

**UL Japan, Inc.**

**Head Office EMC Lab.**

4383-326 Asama-cho, Ise-shi, Mie-ken 516-0021 JAPAN

Telephone : +81 596 24 8116

Facsimile : +81 596 24 8124

## Maximum Peak Output Power

Test place	Head Office EMC Lab. No. 11 Measurement Room	
Report No.	32FE0146-HO-01	
Date	04/27/2012	05/22/2012
Temperature/ Humidity	20deg. C / 59% RH	24 deg. C / 56% RH
Engineer	Yutaka Yoshida	Satofumi Matsuyama
Mode	11n-20 Tx	

11n-20, MCS 4(Long GI), Antenna CN1

Freq. [MHz]	Reading [dBm]	Cable Loss [dB]	Atten. [dB]	Result		Limit		Margin [dB]
				[dBm]	[mW]	[dBm]	[mW]	
2412	9.68	0.71	10.01	20.40	109.70	30.00	1000	9.60
2437	12.05	0.71	10.01	22.77	189.42	30.00	1000	7.23
2462	9.61	0.72	10.01	20.34	108.06	30.00	1000	9.66

11n-20, MCS 4(Long GI), Antenna CN2

Freq. [MHz]	Reading [dBm]	Cable Loss [dB]	Atten. [dB]	Result		Limit		Margin [dB]
				[dBm]	[mW]	[dBm]	[mW]	
2412	9.63	0.71	10.01	20.35	108.44	30.00	1000	9.65
2437	11.91	0.71	10.01	22.63	183.41	30.00	1000	7.37
2462	9.42	0.72	10.01	20.15	103.43	30.00	1000	9.85

Sample Calculation:

Result = Reading + Cable Loss + Attenuator

Antenna CN1, 2437MHz

MCS Number	Reading	
	Long GI [dBm]	Short GI [dBm]
MCS0	11.81	
MCS1	11.73	
MCS2	11.79	
MCS3	12.00	
MCS4	12.05	12.00
MCS5	11.68	
MCS6	10.23	
MCS7	6.02	

\*: Worst Rate

GI: Guard Interval

All comparison were carried out on same frequency and measurement factors.

## Radiated Spurious Emission

Test place Head Office EMC Lab. No.3 Semi Anechoic Chamber  
Report No. 32FE0146-HO-01  
Date 05/02/2012 05/31/2012  
Temperature/ Humidity 22 deg.C./ 63% 24 deg.C./ 52%  
Engineer Takumi Shimada Satofumi Matsuyama  
(1-10GHz) (10-26.5GHz)  
Mode 11b Tx 2412MHz

Polarity	Frequency [MHz]	Detector	Reading [dBuV]	Ant.Fac. [dB/m]	Loss [dB]	Gain [dB]	Result [dBuV/m]	Limit [dBuV/m]	Margin [dB]	Remark
Hori	2390.000	PK	49.5	26.4	2.2	32.4	45.7	73.9	28.3	
Hori	2397.000	PK	68.0	26.4	2.2	32.4	64.2	-	-	- See 20dBc Data Sheet
Hori	2400.000	PK	66.1	26.4	2.2	32.4	62.3	-	-	- See 20dBc Data Sheet
Hori	4824.000	PK	44.2	30.4	4.7	31.4	47.9	73.9	26.0	
Hori	7236.000	PK	41.1	35.2	5.6	32.4	49.5	73.9	24.4	
Hori	9648.000	PK	41.0	38.1	6.7	33.0	52.8	73.9	21.1	
Hori	24120.000	PK	45.2	38.0	-1.7	31.0	50.5	73.9	23.4	NS
Hori	2390.000	AV	37.6	26.4	2.2	32.4	33.8	53.9	20.2	
Hori	2397.000	AV	57.9	26.4	2.2	32.4	54.1	-	-	- See 20dBc Data Sheet
Hori	2400.000	AV	56.6	26.4	2.2	32.4	52.8	-	-	- See 20dBc Data Sheet
Hori	4824.000	AV	30.3	30.4	4.7	31.4	34.0	53.9	19.9	
Hori	7236.000	AV	29.5	35.2	5.6	32.4	37.9	53.9	16.0	
Hori	9648.000	AV	28.7	38.1	6.7	33.0	40.5	53.9	13.4	
Hori	24120.000	AV	34.1	38.0	-1.7	31.0	39.4	53.9	14.5	NS
Vert	2390.000	PK	49.7	26.4	2.2	32.4	45.9	73.9	28.0	
Vert	2397.000	PK	66.9	26.4	2.2	32.4	63.1	-	-	- See 20dBc Data Sheet
Vert	2400.000	PK	65.1	26.4	2.2	32.4	61.3	-	-	- See 20dBc Data Sheet
Vert	4824.000	PK	41.0	30.4	4.7	31.4	44.7	73.9	29.2	
Vert	7236.000	PK	42.4	35.2	5.6	32.4	50.8	73.9	23.1	
Vert	9648.000	PK	41.3	38.1	6.7	33.0	53.1	73.9	20.8	
Vert	24120.000	PK	45.5	38.0	-1.7	31.0	50.8	73.9	23.1	NS
Vert	2390.000	AV	38.1	26.4	2.2	32.4	34.3	53.9	19.6	
Vert	2397.000	AV	58.3	26.4	2.2	32.4	54.5	-	-	- See 20dBc Data Sheet
Vert	2400.000	AV	57.6	26.4	2.2	32.4	53.8	-	-	- See 20dBc Data Sheet
Vert	4824.000	AV	30.8	30.4	4.7	31.4	34.5	53.9	19.4	
Vert	7236.000	AV	29.5	35.2	5.6	32.4	37.9	53.9	16.1	
Vert	9648.000	AV	28.7	38.1	6.7	33.0	40.5	53.9	13.4	
Vert	24120.000	AV	34.1	38.0	-1.7	31.0	39.4	53.9	14.5	NS

Result = Reading + Ant Factor + Loss (Cable+Attenuator+Filter-Distance factor(above 10GHz)) - Gain(Amplifier)

\*Other frequency noises omitted in this report were not seen or had enough margin (more than 20dB).

\*The 10th harmonic was not seen so the result was its base noise level.

Distance factor: 10GHz-26.5GHz 20log(3.0m/1.0m)= 9.5dB

\*NS: No signal detected

### 20dBc Data Sheet

Polarity	Frequency [MHz]	Detector	Reading [dBuV]	Ant Factor [dB/m]	Loss [dB]	Gain [dB]	Result [dBuV/m]	Limit [dBuV/m]	Margin [dB]	Remark
Hori	2412.000	PK	103.6	26.4	2.2	32.4	99.8	-	-	Carrier
Hori	2397.000	PK	61.9	26.4	2.2	32.4	58.1	79.8	21.7	
Hori	2400.000	PK	58.4	26.4	2.2	32.4	54.6	79.8	25.2	
Vert	2412.000	PK	102.2	26.4	2.2	32.4	98.4	-	-	Carrier
Vert	2397.000	PK	61.2	26.4	2.2	32.4	57.4	78.4	21.0	
Vert	2400.000	PK	60.3	26.4	2.2	32.4	56.5	78.4	21.9	

Result = Reading + Ant Factor + Loss (Cable+Attenuator+Filter-Distance factor(above 10GHz)) - Gain(Amplifier)

## Radiated Spurious Emission

Test place Head Office EMC Lab. No.3 Semi Anechoic Chamber  
 Report No. 32FE0146-HO-01  
 Date 05/02/2012 05/31/2012  
 Temperature/ Humidity 22 deg.C./ 63% 24 deg.C./ 52%  
 Engineer Takumi Shimada Satofumi Matsuyama  
 (1-10GHz) (10-26.5GHz)  
 Mode 11b Tx 2437MHz

Polarity	Frequency [MHz]	Detector	Reading [dBuV]	Ant.Fac. [dB/m]	Loss [dB]	Gain [dB]	Result [dBuV/m]	Limit [dBuV/m]	Margin [dB]	Remark
Hori	3456.008	PK	45.2	28.5	2.7	31.9	44.5	73.9	29.4	
Hori	4874.000	PK	41.6	30.5	4.7	31.4	45.4	73.9	28.5	
Hori	7311.000	PK	41.6	35.2	5.6	32.5	49.9	73.9	24.0	
Hori	9748.000	PK	40.8	38.3	6.7	33.0	52.8	73.9	21.1	
Hori	24370.000	PK	45.6	38.0	-1.7	30.9	51.0	73.9	22.9	NS
Hori	3456.008	AV	39.7	28.5	2.7	31.9	39.0	53.9	14.9	
Hori	4874.000	AV	30.6	30.5	4.7	31.4	34.4	53.9	19.5	
Hori	7311.000	AV	29.8	35.2	5.6	32.5	38.1	53.9	15.8	
Hori	9748.000	AV	28.0	38.3	6.7	33.0	40.0	53.9	13.9	
Hori	24370.000	AV	34.4	38.0	-1.7	30.9	39.8	53.9	14.1	NS
Vert	3456.008	PK	47.1	28.5	2.7	31.9	46.4	73.9	27.5	
Vert	4874.000	PK	40.7	30.5	4.7	31.4	44.5	73.9	29.4	
Vert	7311.000	PK	42.6	35.2	5.6	32.5	50.9	73.9	23.0	
Vert	9748.000	PK	40.7	38.3	6.7	33.0	52.7	73.9	21.2	
Vert	24370.000	PK	45.8	38.0	-1.7	30.9	51.2	73.9	22.7	NS
Vert	3456.008	AV	43.0	28.5	2.7	31.9	42.3	53.9	11.6	
Vert	4874.000	AV	29.4	30.5	4.7	31.4	33.2	53.9	20.7	
Vert	7311.000	AV	29.6	35.2	5.6	32.5	37.9	53.9	16.0	
Vert	9748.000	AV	28.7	38.3	6.7	33.0	40.7	53.9	13.2	
Vert	24370.000	AV	34.4	38.0	-1.7	30.9	39.8	53.9	14.1	NS

Result = Reading + Ant Factor + Loss (Cable+Attenuator+Filter-Distance factor(above 10GHz)) - Gain(Amplifier)

\*Other frequency noises omitted in this report were not seen or had enough margin (more than 20dB).

\*The 10th harmonic was not seen so the result was its base noise level.

Distance factor: 10GHz-26.5GHz  $20\log(3.0m/1.0m) = 9.5dB$

\*NS: No signal detected

## Radiated Spurious Emission

Test place Head Office EMC Lab. No.3 Semi Anechoic Chamber  
Report No. 32FE0146-HO-01  
Date 05/02/2012 05/31/2012  
Temperature/ Humidity 22 deg.C./ 63% 24 deg.C./ 52%  
Engineer Takumi Shimada Satofumi Matsuyama  
(1-10GHz) (10-26.5GHz)  
Mode 11b Tx 2462MHz

Polarity	Frequency [MHz]	Detector	Reading [dBuV]	Ant.Fac. [dB/m]	Loss [dB]	Gain [dB]	Result [dBuV/m]	Limit [dBuV/m]	Margin [dB]	Remark
Hori	2483.500	PK	55.5	26.5	2.2	32.3	51.9	73.9	22.0	
Hori	2488.000	PK	56.6	26.5	2.2	32.3	53.0	73.9	20.9	
Hori	4924.000	PK	41.0	30.5	4.6	31.4	44.7	73.9	29.2	
Hori	7386.000	PK	42.3	35.2	5.6	32.5	50.6	73.9	23.3	
Hori	9848.000	PK	41.9	38.5	6.7	33.1	54.0	73.9	19.9	
Hori	24620.000	PK	45.2	38.1	-1.7	30.9	50.7	73.9	23.2	NS
Hori	2483.500	AV	44.7	26.5	2.2	32.3	41.1	53.9	12.8	
Hori	2488.000	AV	46.8	26.5	2.2	32.3	43.2	53.9	10.7	
Hori	4924.000	AV	29.8	30.5	4.6	31.4	33.5	53.9	20.4	
Hori	7386.000	AV	29.7	35.2	5.6	32.5	38.0	53.9	15.9	
Hori	9848.000	AV	29.3	38.5	6.7	33.1	41.4	53.9	12.5	
Hori	24620.000	AV	34.1	38.1	-1.7	30.9	39.6	53.9	14.3	NS
Vert	2483.500	PK	53.8	26.5	2.2	32.3	50.2	73.9	23.8	
Vert	2488.000	PK	55.1	26.5	2.2	32.3	51.5	73.9	22.4	
Vert	4924.000	PK	42.6	30.5	4.6	31.4	46.3	73.9	27.6	
Vert	7386.000	PK	41.9	35.2	5.6	32.5	50.2	73.9	23.7	
Vert	9848.000	PK	41.5	38.5	6.7	33.1	53.6	73.9	20.3	
Vert	24620.000	PK	45.0	38.1	-1.7	30.9	50.5	73.9	23.4	NS
Vert	2483.500	AV	42.2	26.5	2.2	32.3	38.6	53.9	15.3	
Vert	2488.000	AV	44.5	26.5	2.2	32.3	40.9	53.9	13.0	
Vert	4924.000	AV	29.4	30.5	4.6	31.4	33.1	53.9	20.8	
Vert	7386.000	AV	29.7	35.2	5.6	32.5	38.0	53.9	15.9	
Vert	9848.000	AV	29.5	38.5	6.7	33.1	41.6	53.9	12.3	
Vert	24620.000	AV	34.1	38.1	-1.7	30.9	39.6	53.9	14.3	NS

Result = Reading + Ant Factor + Loss (Cable+Attenuator+Filter-Distance factor(above 10GHz)) - Gain(Amplifier)

\*Other frequency noises omitted in this report were not seen or had enough margin (more than 20dB).

\*The 10th harmonic was not seen so the result was its base noise level.

Distance factor: 10GHz-26.5GHz  $20\log(3.0m/1.0m) = 9.5dB$

\*NS: No signal detected

## Radiated Spurious Emission

Test place Head Office EMC Lab. No.4 and 3 Semi Anechoic Chamber  
Report No. 32FE0146-HO-01  
Date 05/13/2012 05/31/2012  
Temperature/ Humidity 21 deg.C./ 43% 24 deg.C./ 52%  
Engineer Takeshi Choda Satofumi Matsuyama  
(1-10GHz) (10-26.5GHz)  
Mode 11g Tx 2412MHz

Polarity	Frequency [MHz]	Detector	Reading [dBuV]	Ant.Fac. [dB/m]	Loss [dB]	Gain [dB]	Result [dBuV/m]	Limit [dBuV/m]	Margin [dB]	Remark
Hori	2390.000	PK	70.2	28.1	2.4	32.3	68.4	73.9	5.5	
Hori	2400.000	PK	85.1	28.1	2.4	32.3	83.3	73.9	-	See 20dBc Data Sheet
Hori	4824.000	PK	46.4	31.2	5.1	31.5	51.2	73.9	22.7	
Hori	7236.000	PK	43.0	35.6	5.9	32.5	52.0	73.9	21.9	NS
Hori	9648.000	PK	43.2	38.3	7.1	32.9	55.7	73.9	18.2	NS
Hori	24120.000	PK	45.9	38.0	-1.7	31.0	51.2	73.9	22.7	NS
Hori	2390.000	AV	54.3	28.1	2.4	32.3	52.5	53.9	1.4	
Hori	2400.000	AV	67.8	28.1	2.4	32.3	66.0	53.9	-	See 20dBc Data Sheet
Hori	4824.000	AV	32.5	31.2	5.1	31.5	37.3	53.9	16.6	
Hori	7236.000	AV	30.3	35.6	5.9	32.5	39.3	53.9	14.6	NS
Hori	9648.000	AV	30.0	38.3	7.1	32.9	42.5	53.9	11.4	NS
Hori	24120.000	AV	34.1	38.0	-1.7	31.0	39.4	53.9	14.5	NS
Vert	2390.000	PK	70.8	28.1	2.4	32.3	69.0	73.9	4.9	
Vert	2400.000	PK	86.5	28.1	2.4	32.3	84.7	73.9	-	See 20dBc Data Sheet
Vert	4824.000	PK	43.0	31.2	5.1	31.5	47.8	73.9	26.1	
Vert	7236.000	PK	42.9	35.6	5.9	32.5	51.9	73.9	22.0	NS
Vert	9648.000	PK	43.3	38.3	7.1	32.9	55.8	73.9	18.1	NS
Vert	24120.000	PK	45.3	38.0	-1.7	31.0	50.6	73.9	23.3	NS
Vert	2390.000	AV	54.7	28.1	2.4	32.3	52.9	53.9	1.0	
Vert	2400.000	AV	69.3	28.1	2.4	32.3	67.5	53.9	-	See 20dBc Data Sheet
Vert	4824.000	AV	32.9	31.2	5.1	31.5	37.7	53.9	16.2	
Vert	7236.000	AV	30.0	35.6	5.9	32.5	39.0	53.9	14.9	NS
Vert	9648.000	AV	30.1	38.3	7.1	32.9	42.6	53.9	11.3	NS
Vert	24120.000	AV	34.1	38.0	-1.7	31.0	39.4	53.9	14.5	NS

Result = Reading + Ant Factor + Loss (Cable+Attenuator+Filter-Distance factor(above 10GHz)) - Gain(Ant

\*Other frequency noises omitted in this report were not seen or had enough margin (more than 20dB).

\*The 10th harmonic was not seen so the result was its base noise level.

Distance factor: 10GHz-26.5GHz 20log(3.0m/1.0m)= 9.5dB

\*NS: No signal detected

## Radiated Spurious Emission

Test place : Head Office EMC Lab. No.4 Semi Anechoic Chamber  
Report No. : 32FE0146-HO-01  
Date : 05/13/2012  
Temperature/ Humidity : 21 deg.C./ 43%  
Engineer : Takeshi Choda  
(1-10GHz)  
Mode : 11g Tx 2412MHz

**20dBc Data Sheet**

Polarity	Frequency [MHz]	Detector	Reading [dBuV]	Ant Factor [dB/m]	Loss [dB]	Gain [dB]	Result [dBuV/m]	Limit [dBuV/m]	Margin [dB]	Remark
Hori	2412.000	PK	109.0	28.2	2.4	32.3	107.3	-	-	Carrier
Hori	2400.000	PK	71.2	28.1	2.4	32.3	69.4	87.3	17.9	
Vert	2412.000	PK	102.8	28.2	2.4	32.3	101.1	-	-	Carrier
Vert	2400.000	PK	72.6	28.1	2.4	32.3	70.8	81.1	10.3	

Result = Reading + Ant Factor + Loss (Cable+Attenuator+Filter-Distance factor(above 10GHz)) - Gain(Amplifier)

## Radiated Spurious Emission

Test place Head Office EMC Lab. No.4 and 3 Semi Anechoic Chamber  
Report No. 32FE0146-HO-01  
Date 05/13/2012 05/20/2012 05/31/2012  
Temperature/ Humidity 21 deg.C./ 43% 23 deg.C./ 53% 24 deg.C./ 52%  
Engineer Takeshi Choda Katsunori Okai Satofumi Matsuyama  
(1-10GHz) (30-1000MHz) (10-26.5GHz)  
Mode 11g Tx 2437MHz

Polarity	Frequency [MHz]	Detector	Reading [dBuV]	Ant.Fac. [dB/m]	Loss [dB]	Gain [dB]	Result [dBuV/m]	Limit [dBuV/m]	Margin [dB]	Remark
Hori	87.176	QP	53.9	7.8	7.9	32.1	37.5	40.0	2.5	
Hori	99.172	QP	53.3	10.0	8.1	32.1	39.3	43.5	4.2	
Hori	112.068	QP	49.1	11.9	8.2	32.0	37.2	43.5	6.3	
Hori	211.681	QP	37.4	16.8	8.9	32.0	31.1	43.5	12.4	
Hori	237.266	QP	48.1	17.1	9.1	32.0	42.3	46.0	3.7	
Hori	360.012	QP	42.9	17.0	10.0	32.0	37.9	46.0	8.1	
Hori	362.156	QP	48.8	17.1	10.0	32.0	43.9	46.0	2.1	
Hori	387.121	QP	46.3	17.4	10.2	32.0	41.9	46.0	4.1	
Hori	4874.000	PK	46.3	31.4	5.2	31.5	51.4	73.9	22.5	
Hori	7311.000	PK	42.9	35.7	5.9	32.5	52.0	73.9	21.9	NS
Hori	9748.000	PK	43.1	38.4	7.4	32.9	56.0	73.9	17.9	NS
Hori	24370.000	PK	45.9	38.0	-1.7	30.9	51.3	73.9	22.6	NS
Hori	4874.000	AV	33.6	31.4	5.2	31.5	38.7	53.9	15.2	
Hori	7311.000	AV	30.2	35.7	5.9	32.5	39.3	53.9	14.6	NS
Hori	9748.000	AV	30.0	38.4	7.4	32.9	42.9	53.9	11.0	NS
Hori	24370.000	AV	34.4	38.0	-1.7	30.9	39.8	53.9	14.1	NS
Vert	87.386	QP	50.7	7.8	7.9	32.1	34.3	40.0	5.7	
Vert	99.196	QP	44.5	10.0	8.1	32.1	30.5	43.5	13.0	
Vert	112.066	QP	40.3	11.9	8.2	32.0	28.4	43.5	15.1	
Vert	237.267	QP	34.0	17.1	9.1	32.0	28.2	46.0	17.8	
Vert	336.152	QP	37.9	16.7	9.8	32.0	32.4	46.0	13.6	
Vert	362.152	QP	38.1	17.1	10.0	32.0	33.2	46.0	12.8	
Vert	600.001	QP	35.4	20.6	11.4	32.1	35.3	46.0	10.7	
Vert	4874.000	PK	43.1	31.4	5.2	31.5	48.2	73.9	25.7	
Vert	7311.000	PK	43.0	35.7	5.9	32.5	52.1	73.9	21.8	NS
Vert	9748.000	PK	43.2	38.4	7.4	32.9	56.1	73.9	17.8	NS
Vert	24370.000	PK	46.0	38.0	-1.7	30.9	51.4	73.9	22.5	NS
Vert	4874.000	AV	32.0	31.4	5.2	31.5	37.1	53.9	16.8	
Vert	7311.000	AV	30.1	35.7	5.9	32.5	39.2	53.9	14.7	NS
Vert	9748.000	AV	29.9	38.4	7.4	32.9	42.8	53.9	11.1	NS
Vert	24370.000	AV	34.4	38.0	-1.7	30.9	39.8	53.9	14.1	NS

Result = Reading + Ant Factor + Loss (Cable+Attenuator+Filter-Distance factor(above 10GHz)) - Gain(Ant)

\*Other frequency noises omitted in this report were not seen or had enough margin (more than 20dB).

\*The 10th harmonic was not seen so the result was its base noise level.

Distance factor: 10GHz-26.5GHz 20log(3.0m/1.0m)= 9.5dB

\*NS: No signal detected



## Radiated Spurious Emission

Test place Head Office EMC Lab. No.4 and 3 Semi Anechoic Chamber  
Report No. 32FE0146-HO-01  
Date 05/13/2012 05/31/2012  
Temperature/ Humidity 21 deg.C./ 43% 24 deg.C./ 52%  
Engineer Takeshi Choda Satofumi Matsuyama  
(1-10GHz) (10-26.5GHz)  
Mode 11g Tx 2462MHz

Polarity	Frequency [MHz]	Detector	Reading [dBuV]	Ant.Fac. [dB/m]	Loss [dB]	Gain [dB]	Result [dBuV/m]	Limit [dBuV/m]	Margin [dB]	Remark
Hori	2483.500	PK	68.6	28.5	2.4	32.2	67.3	73.9	6.6	
Hori	4924.000	PK	45.8	31.5	5.2	31.5	51.0	73.9	22.9	
Hori	7386.000	PK	42.7	35.8	6.0	32.6	51.9	73.9	22.0	NS
Hori	9848.000	PK	43.0	38.5	7.5	33.0	56.0	73.9	17.9	NS
Hori	24620.000	PK	45.0	38.1	-1.7	30.9	50.5	73.9	23.4	NS
Hori	2483.500	AV	52.5	28.5	2.4	32.2	51.2	53.9	2.7	
Hori	4924.000	AV	33.7	31.5	5.2	31.5	38.9	53.9	15.0	
Hori	7386.000	AV	30.0	35.8	6.0	32.6	39.2	53.9	14.7	NS
Hori	9848.000	AV	30.3	38.5	7.5	33.0	43.3	53.9	10.6	NS
Hori	24620.000	AV	34.1	38.1	-1.7	30.9	39.6	53.9	14.3	NS
Vert	2483.500	PK	69.3	28.5	2.4	32.2	68.0	73.9	5.9	
Vert	4924.000	PK	43.6	31.5	5.2	31.5	48.8	73.9	25.1	
Vert	7386.000	PK	42.9	35.8	6.0	32.6	52.1	73.9	21.8	NS
Vert	9848.000	PK	43.2	38.5	7.5	33.0	56.2	73.9	17.7	NS
Vert	24620.000	PK	45.1	38.1	-1.7	30.9	50.6	73.9	23.3	NS
Vert	2483.500	AV	53.2	28.5	2.4	32.2	51.9	53.9	2.0	
Vert	4924.000	AV	34.0	31.5	5.2	31.5	39.2	53.9	14.7	
Vert	7386.000	AV	30.1	35.8	6.0	32.6	39.3	53.9	14.6	NS
Vert	9848.000	AV	30.3	38.5	7.5	33.0	43.3	53.9	10.6	NS
Vert	24620.000	AV	34.1	38.1	-1.7	30.9	39.6	53.9	14.3	NS

Result = Reading + Ant Factor + Loss (Cable+Attenuator+Filter-Distance factor(above 10GHz)) - Gain(Ant

\*Other frequency noises omitted in this report were not seen or had enough margin (more than 20dB).

\*The 10th harmonic was not seen so the result was its base noise level.

Distance factor: 10GHz-26.5GHz  $20\log(3.0m/1.0m) = 9.5dB$

\*NS: No signal detected

## Radiated Spurious Emission

Test place Head Office EMC Lab. No.4 and 3 Semi Anechoic Chamber  
Report No. 32FE0146-HO-01  
Date 05/13/2012 05/31/2012  
Temperature/ Humidity 21 deg.C./ 43% 24 deg.C./ 52%  
Engineer Takeshi Choda Satofumi Matsuyama  
(1-10GHz) (10-26.5GHz)  
Mode 1n20 Tx 2412MHz

Polarity	Frequency [MHz]	Detector	Reading [dBuV]	Ant.Fac. [dB/m]	Loss [dB]	Gain [dB]	Result [dBuV/m]	Limit [dBuV/m]	Margin [dB]	Remark
Hori	2390.000	PK	70.1	28.1	2.4	32.3	68.3	73.9	5.6	
Hori	2400.000	PK	85.4	28.1	2.4	32.3	83.6	73.9	-	See 20dBc Data Sheet
Hori	4824.000	PK	46.6	31.2	5.1	31.5	51.4	73.9	22.5	
Hori	7236.000	PK	43.0	35.6	5.9	32.5	52.0	73.9	21.9	NS
Hori	9648.000	PK	43.4	38.3	7.1	32.9	55.9	73.9	18.0	NS
Hori	24120.000	PK	45.4	38.0	-1.7	31.0	50.7	73.9	23.2	NS
Hori	2390.000	AV	53.8	28.1	2.4	32.3	52.0	53.9	1.9	
Hori	2400.000	AV	66.5	28.1	2.4	32.3	64.7	53.9	-	See 20dBc Data Sheet
Hori	4824.000	AV	33.0	31.2	5.1	31.5	37.8	53.9	16.1	
Hori	7236.000	AV	30.0	35.6	5.9	32.5	39.0	53.9	14.9	NS
Hori	9648.000	AV	30.1	38.3	7.1	32.9	42.6	53.9	11.3	NS
Hori	24120.000	AV	34.1	38.0	-1.7	31.0	39.4	53.9	14.5	NS
Vert	2390.000	PK	71.6	28.1	2.4	32.3	69.8	73.9	4.1	
Vert	2400.000	PK	87.4	28.1	2.4	32.3	85.6	73.9	-	See 20dBc Data Sheet
Vert	4824.000	PK	45.2	31.2	5.1	31.5	50.0	73.9	23.9	
Vert	7236.000	PK	42.9	35.6	5.9	32.5	51.9	73.9	22.0	NS
Vert	9648.000	PK	43.2	38.3	7.1	32.9	55.7	73.9	18.2	NS
Vert	24120.000	PK	45.7	38.0	-1.7	31.0	51.0	73.9	22.9	NS
Vert	2390.000	AV	54.8	28.1	2.4	32.3	53.0	53.9	0.9	
Vert	2400.000	AV	68.6	28.1	2.4	32.3	66.8	53.9	-	See 20dBc Data Sheet
Vert	4824.000	AV	32.5	31.2	5.1	31.5	37.3	53.9	16.6	
Vert	7236.000	AV	29.8	35.6	5.9	32.5	38.8	53.9	15.1	NS
Vert	9648.000	AV	30.3	38.3	7.1	32.9	42.8	53.9	11.1	NS
Vert	24120.000	AV	34.1	38.0	-1.7	31.0	39.4	53.9	14.5	NS

Result = Reading + Ant Factor + Loss (Cable+Attenuator+Filter-Distance factor(above 10GHz)) - Gain(Ant

\*Other frequency noises omitted in this report were not seen or had enough margin (more than 20dB).

\*The 10th harmonic was not seen so the result was its base noise level.

Distance factor: 10GHz-26.5GHz 20log(3.0m/1.0m)= 9.5dB

\*NS: No signal detected

## Radiated Spurious Emission

Test place Head Office EMC Lab. No.4 and 3Semi Anechoic Chamber  
Report No. 32FE0146-HO-01  
Date 05/13/2012 05/31/2012  
Temperature/ Humidity 21 deg.C./ 43% 24 deg.C./ 52%  
Engineer Takeshi Choda Satofumi Matsuyama  
(1-10GHz) (10-26.5GHz)  
Mode 11n20 Tx 2437MHz

Polarity	Frequency [MHz]	Detector	Reading [dBuV]	Ant.Fac. [dB/m]	Loss [dB]	Gain [dB]	Result [dBuV/m]	Limit [dBuV/m]	Margin [dB]	Remark
Hori	4874.000	PK	46.2	31.4	5.2	31.5	51.3	73.9	22.6	
Hori	7311.000	PK	42.8	35.7	5.9	32.5	51.9	73.9	22.0	NS
Hori	9748.000	PK	43.1	38.4	7.4	32.9	56.0	73.9	17.9	NS
Hori	24370.000	PK	45.6	38.0	-1.7	30.9	51.0	73.9	22.9	NS
Hori	4874.000	AV	34.2	31.4	5.2	31.5	39.3	53.9	14.6	
Hori	7311.000	AV	30.1	35.7	5.9	32.5	39.2	53.9	14.7	NS
Hori	9748.000	AV	30.2	38.4	7.4	32.9	43.1	53.9	10.8	NS
Hori	24370.000	AV	34.4	38.0	-1.7	30.9	39.8	53.9	14.1	NS
Vert	4874.000	PK	44.1	31.4	5.2	31.5	49.2	73.9	24.7	
Vert	7311.000	PK	42.9	35.7	5.9	32.5	52.0	73.9	21.9	NS
Vert	9748.000	PK	43.2	38.4	7.4	32.9	56.1	73.9	17.8	NS
Vert	24370.000	PK	46.2	38.0	-1.7	30.9	51.6	73.9	22.3	NS
Vert	4874.000	AV	33.7	31.4	5.2	31.5	38.8	53.9	15.1	
Vert	7311.000	AV	30.0	35.7	5.9	32.5	39.1	53.9	14.8	NS
Vert	9748.000	AV	30.3	38.4	7.4	32.9	43.2	53.9	10.7	NS
Vert	24370.000	AV	34.4	38.0	-1.7	30.9	39.8	53.9	14.1	NS

Result = Reading + Ant Factor + Loss (Cable+Attenuator+Filter-Distance factor(above 10GHz)) - Gain(Ampr)

\*Other frequency noises omitted in this report were not seen or had enough margin (more than 20dB).

\*The 10th harmonic was not seen so the result was its base noise level.

Distance factor: 10GHz-26.5GHz 20log(3.0m/1.0m)= 9.5dB

\*NS: No signal detected

## Radiated Spurious Emission

Test place Head Office EMC Lab. No.4 and 3 Semi Anechoic Chamber  
Report No. 32FE0146-HO-01  
Date 05/13/2012 05/31/2012  
Temperature/ Humidity 21 deg.C./ 43% 24 deg.C./ 52%  
Engineer Takeshi Choda Satofumi Matsuyama  
(1-10GHz) (10-26.5GHz)  
Mode 11n20 Tx 2462MHz

Polarity	Frequency [MHz]	Detector	Reading [dBuV]	Ant.Fac. [dB/m]	Loss [dB]	Gain [dB]	Result [dBuV/m]	Limit [dBuV/m]	Margin [dB]	Remark
Hori	2483.500	PK	68.4	28.5	2.4	32.2	67.1	73.9	6.8	
Hori	4924.000	PK	45.9	31.5	5.2	31.5	51.1	73.9	22.8	
Hori	7386.000	PK	43.0	35.8	6.0	32.6	52.2	73.9	21.7	NS
Hori	9848.000	PK	43.2	38.5	7.5	33.0	56.2	73.9	17.7	NS
Hori	24620.000	PK	45.2	38.1	-1.7	30.9	50.7	73.9	23.2	NS
Hori	2483.500	AV	51.9	28.5	2.4	32.2	50.6	53.9	3.3	
Hori	4924.000	AV	33.7	31.5	5.2	31.5	38.9	53.9	15.0	
Hori	7386.000	AV	29.9	35.8	6.0	32.6	39.1	53.9	14.8	NS
Hori	9848.000	AV	30.1	38.5	7.5	33.0	43.1	53.9	10.8	NS
Hori	24620.000	AV	34.1	38.1	-1.7	30.9	39.6	53.9	14.3	NS
Vert	2483.500	PK	69.8	28.5	2.4	32.2	68.5	73.9	5.4	
Vert	4924.000	PK	43.7	31.5	5.2	31.5	48.9	73.9	25.0	
Vert	7386.000	PK	42.8	35.8	6.0	32.6	52.0	73.9	21.9	NS
Vert	9848.000	PK	43.0	38.5	5.2	33.0	53.7	73.9	20.2	NS
Vert	24620.000	PK	44.9	38.1	-1.7	30.9	50.4	73.9	23.5	NS
Vert	2483.500	AV	53.1	28.5	2.4	32.2	51.8	53.9	2.1	
Vert	4924.000	AV	34.1	31.5	5.2	31.5	39.3	53.9	14.6	
Vert	7386.000	AV	29.9	35.8	6.0	32.6	39.1	53.9	14.8	NS
Vert	9848.000	AV	30.2	38.5	5.2	33.0	40.9	53.9	13.0	NS
Vert	24620.000	AV	34.1	38.1	-1.7	30.9	39.6	53.9	14.3	NS

Result = Reading + Ant Factor + Loss (Cable+Attenuator+Filter-Distance factor(above 10GHz)) - Gain(Ant

\*Other frequency noises omitted in this report were not seen or had enough margin (more than 20dB).

\*The 10th harmonic was not seen so the result was its base noise level.

Distance factor: 10GHz-26.5GHz 20log(3.0m/1.0m)= 9.5dB

\*NS: No signal detected

**Burst rate confirmation**

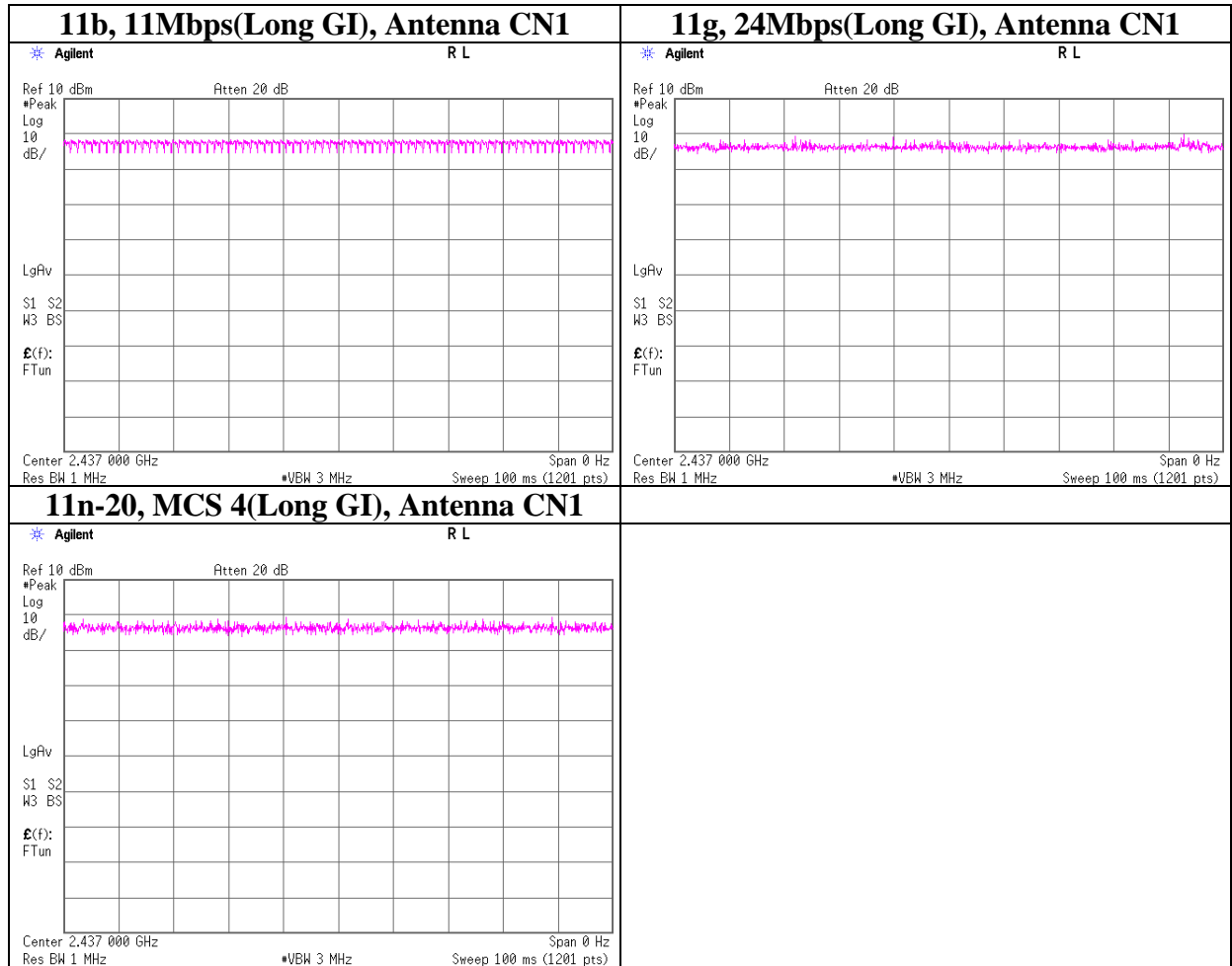

**Conducted Spurious Emission**

**11b, 11Mbps(Long GI), Antenna CN1, Tx 2412MHz**

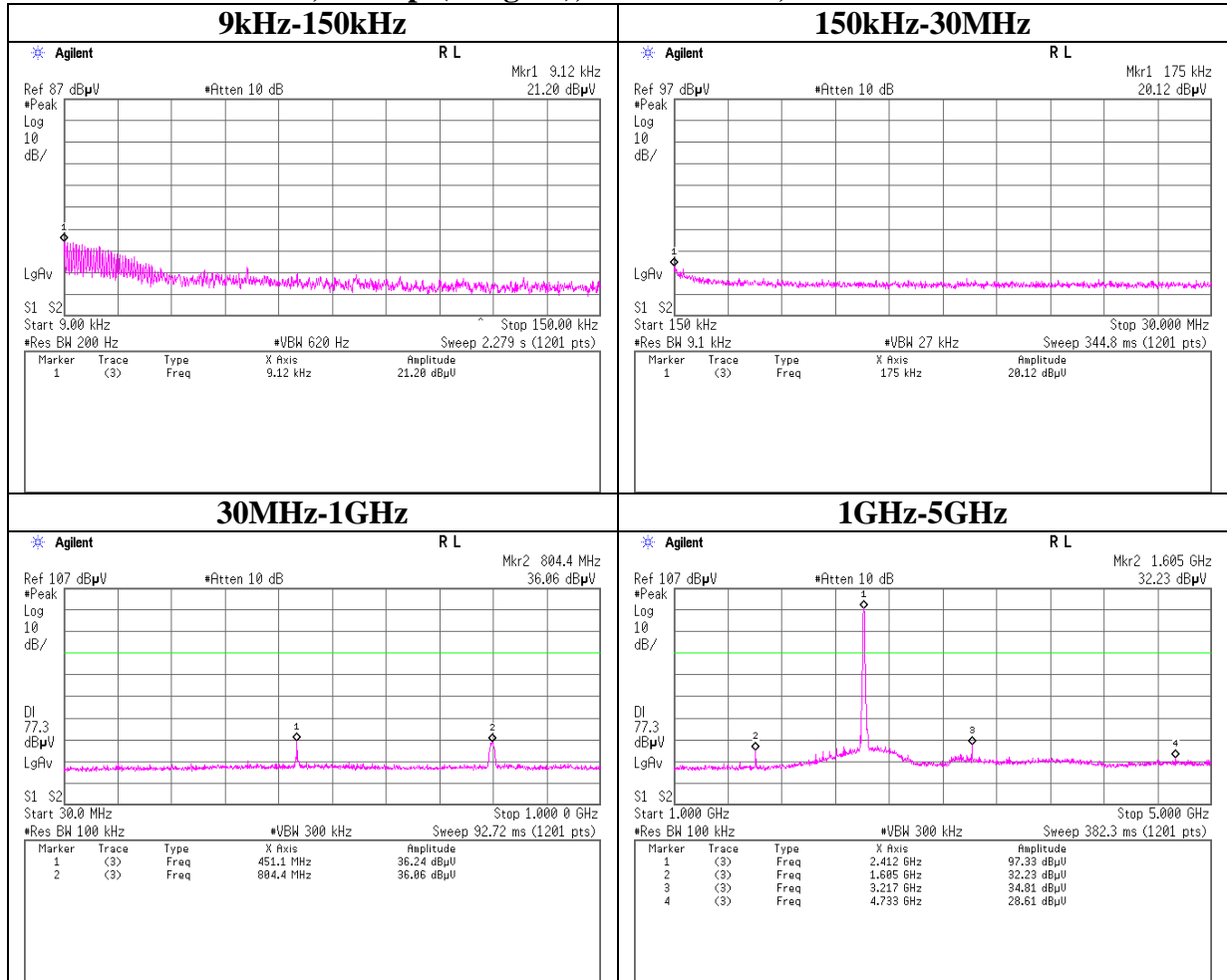

**Conducted Spurious Emission**

**11b, 11Mbps(Long GI), Antenna CN1, Tx 2412MHz**

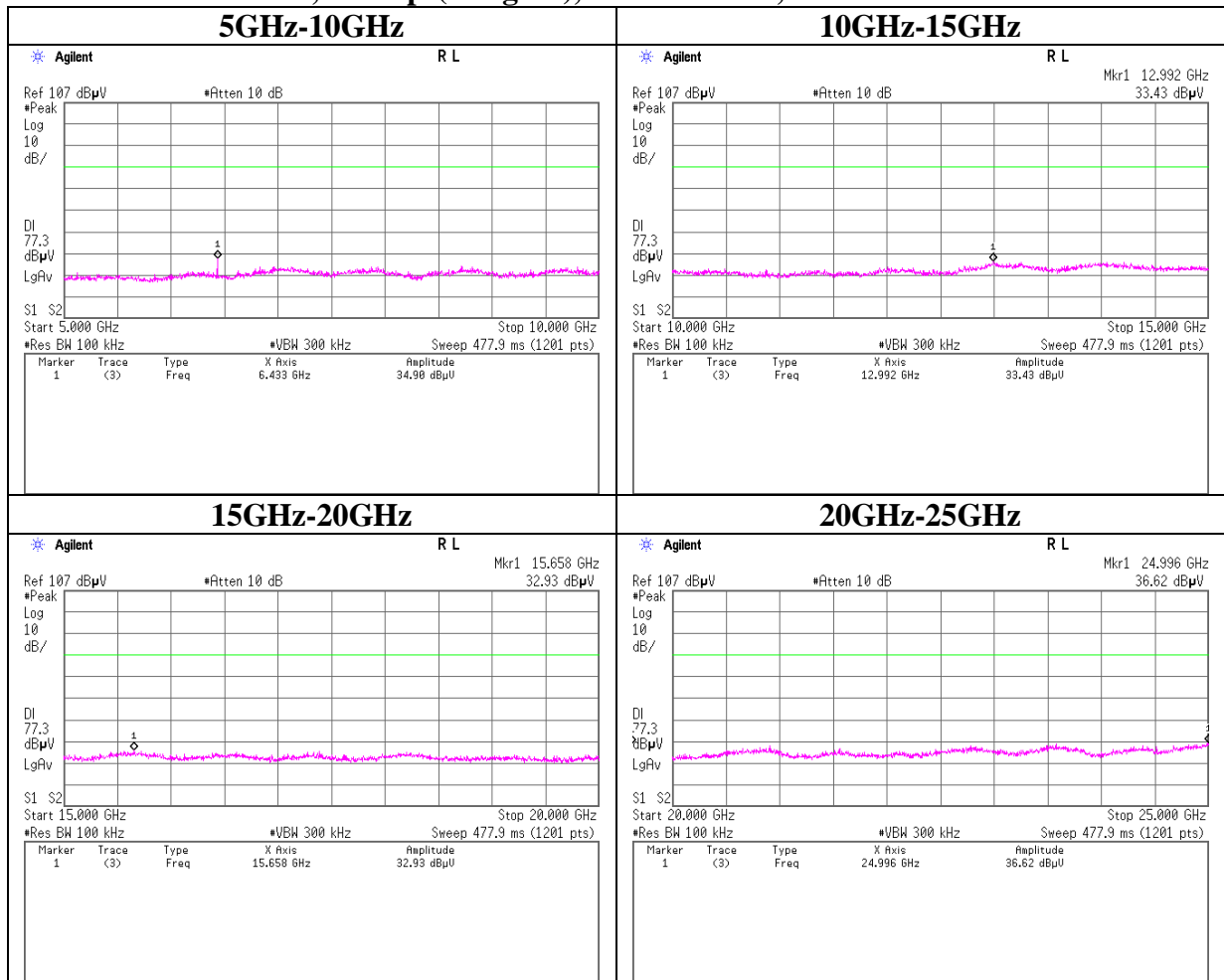

### Conducted Spurious Emission

#### 11b, 11Mbps(Long GI), Antenna CN1, Tx 2437MHz

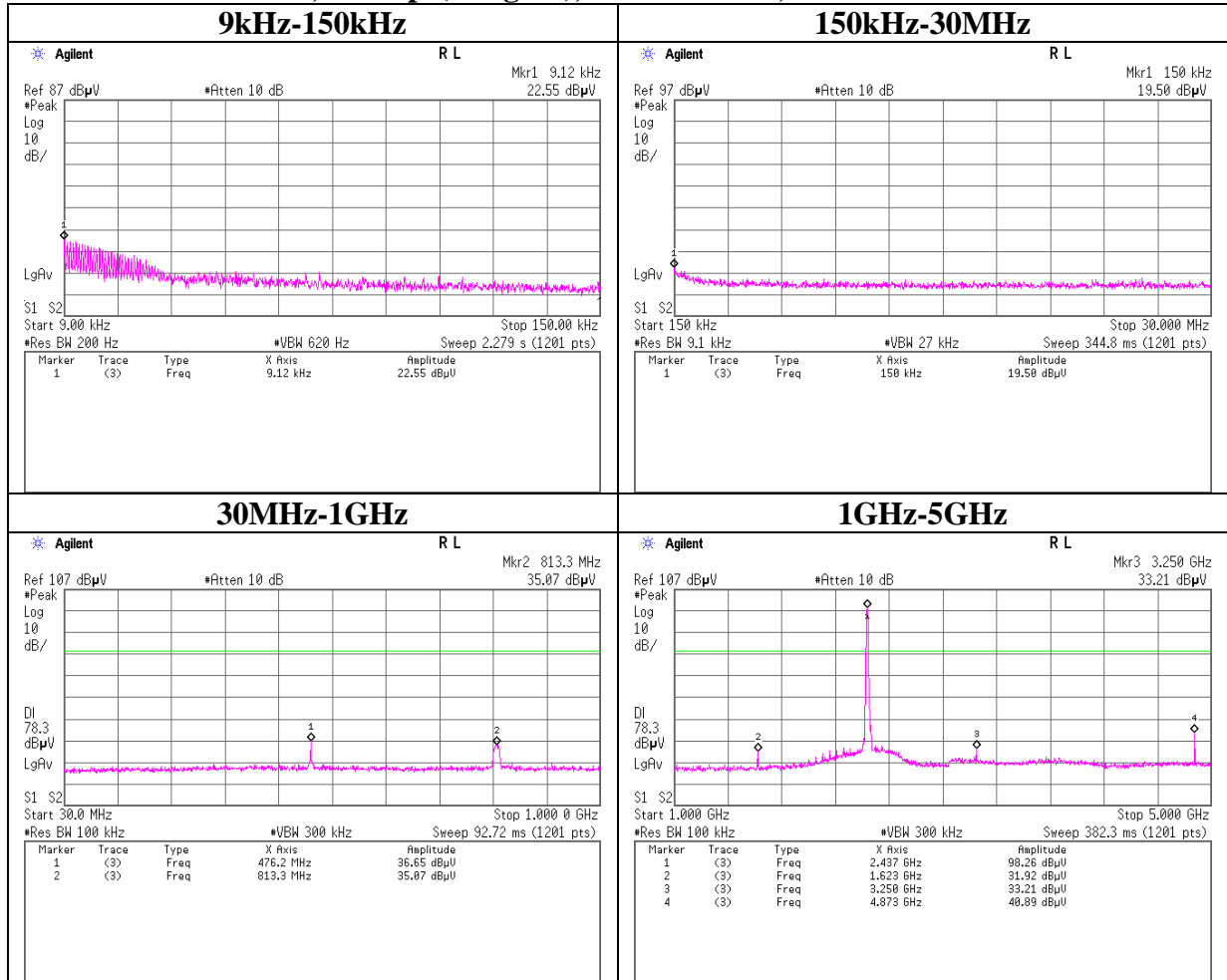



**Conducted Spurious Emission**

**11b, 11Mbps(Long GI), Antenna CN1, Tx 2437MHz**

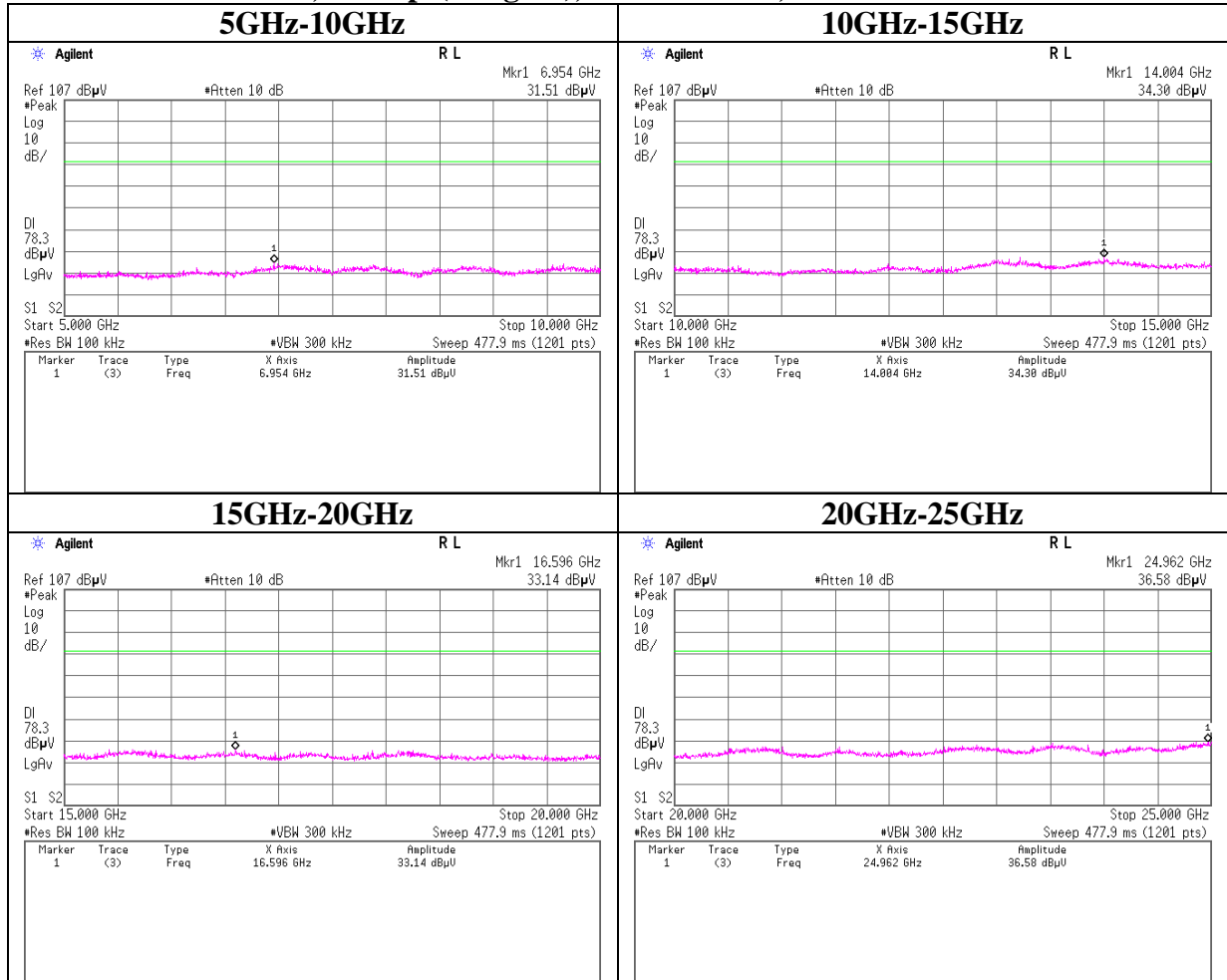

### Conducted Spurious Emission

#### 11b, 11Mbps(Long GI), Antenna CN1, Tx 2462MHz

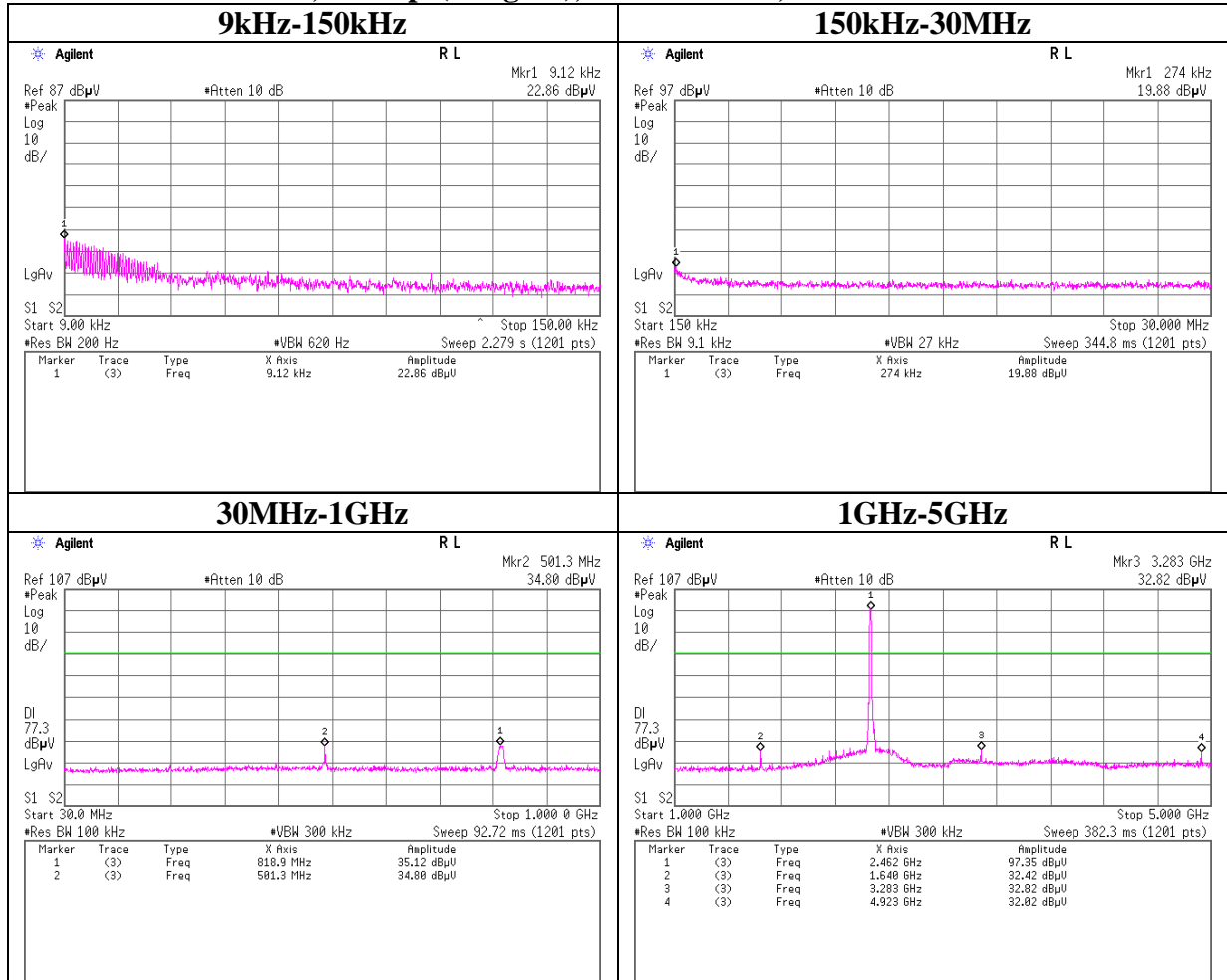

**Conducted Spurious Emission**

**11b, 11Mbps(Long GI), Antenna CN1, Tx 2462MHz**

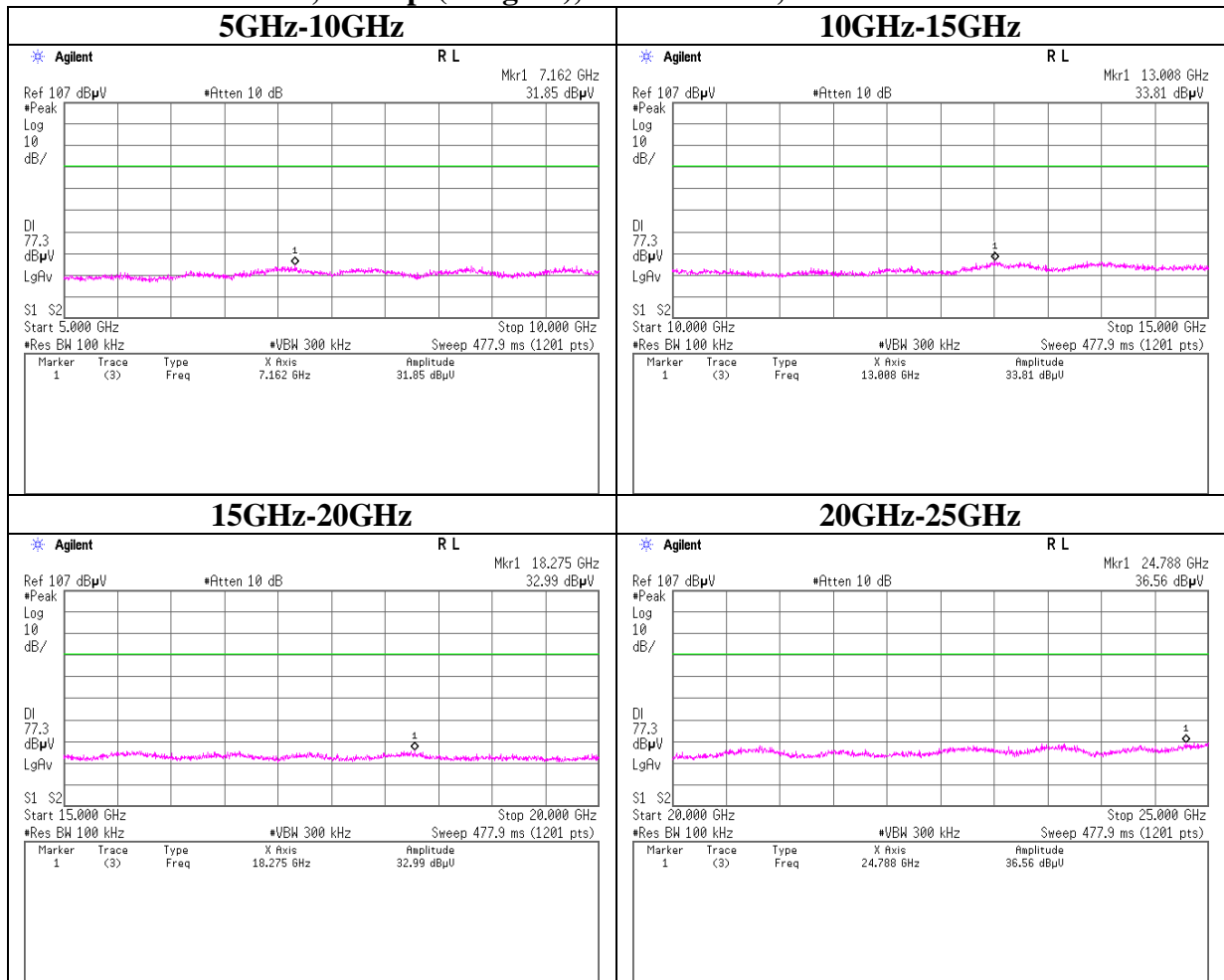

### Conducted Spurious Emission

#### 11g, 24Mbps(Long GI), Antenna CN1, Tx 2412MHz

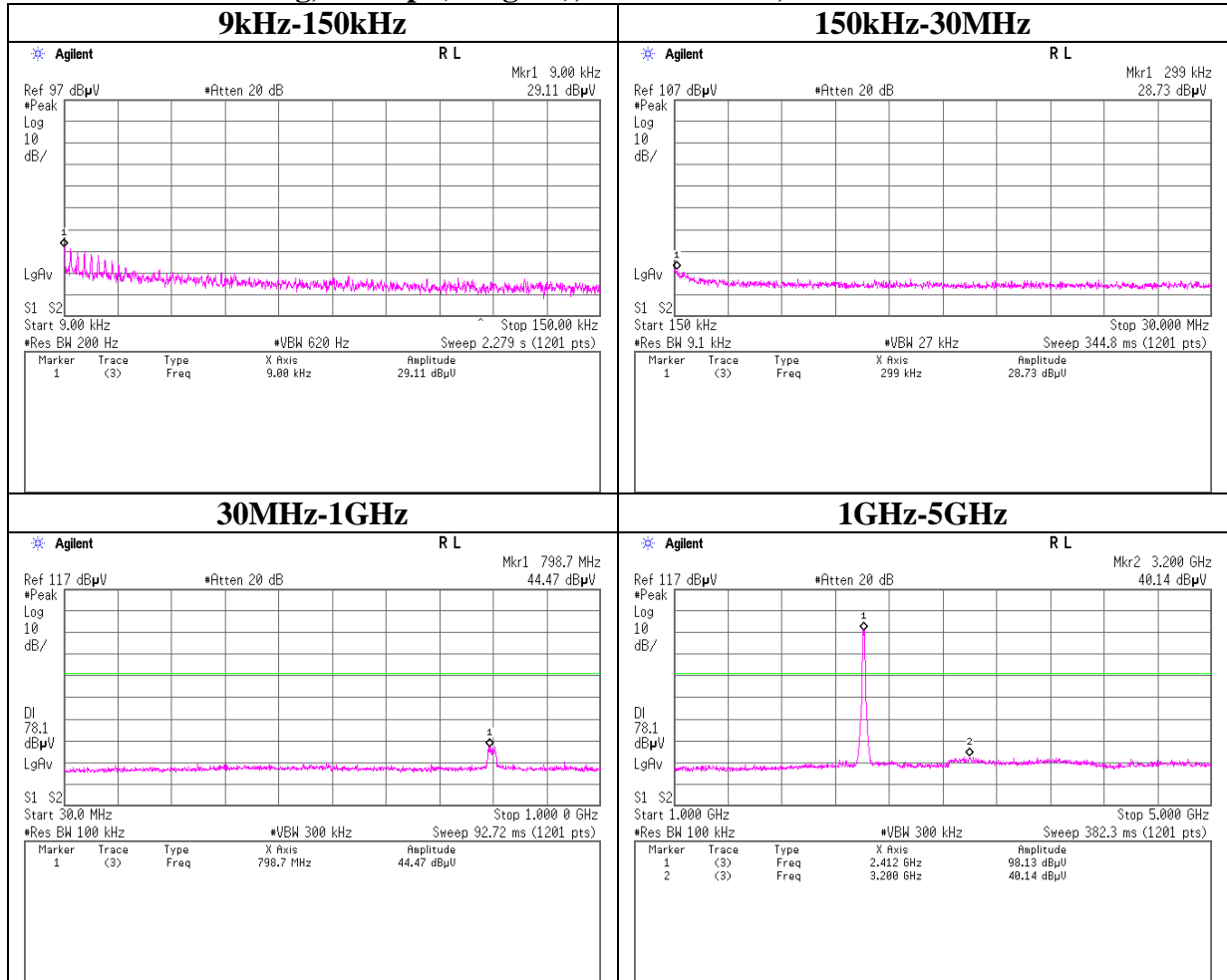

**Conducted Spurious Emission**

**11g, 24Mbps(Long GI), Antenna CN1, Tx 2412MHz**

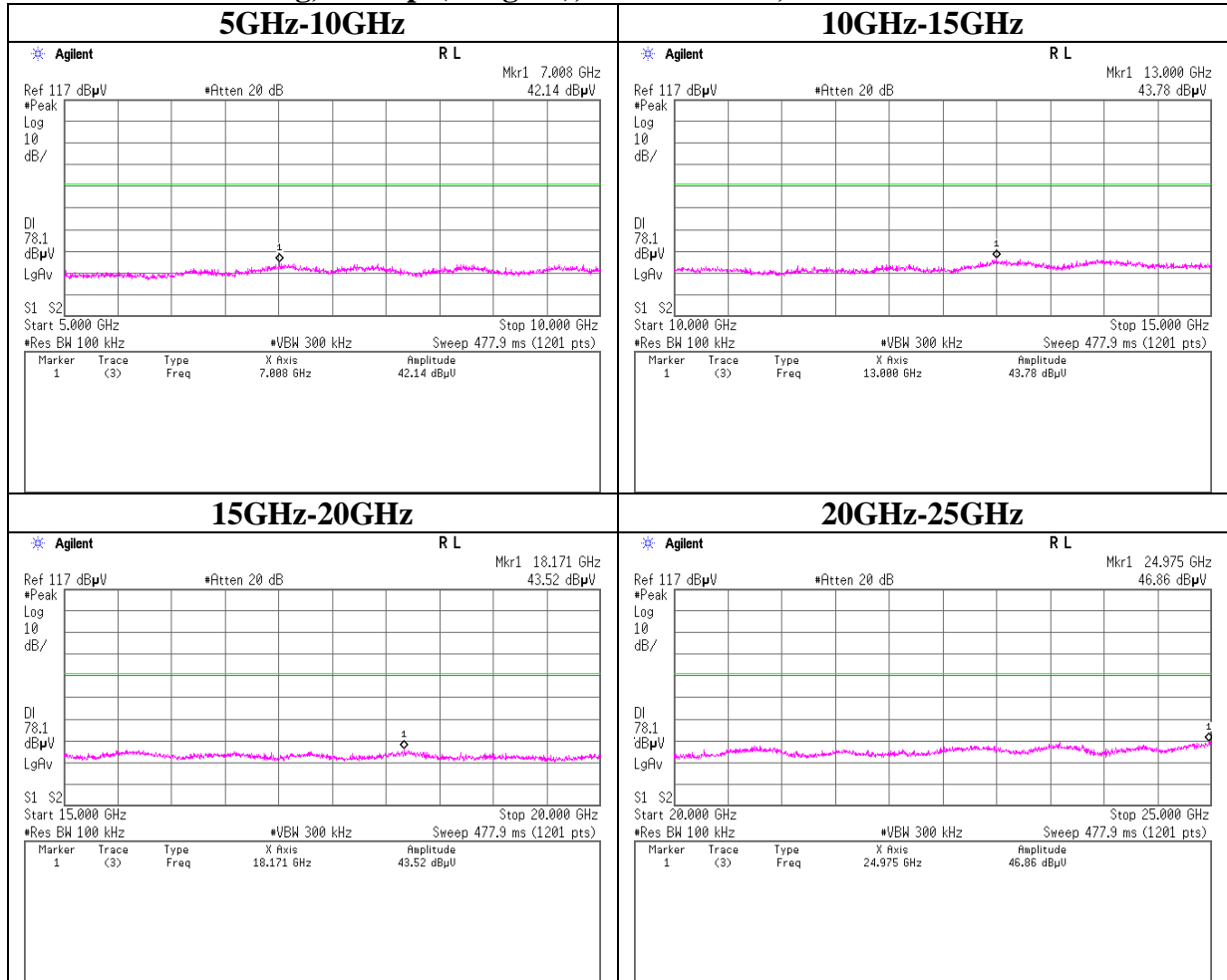

**Conducted Spurious Emission**

**11g, 24Mbps(Long GI), Antenna CN1, Tx 2437MHz**

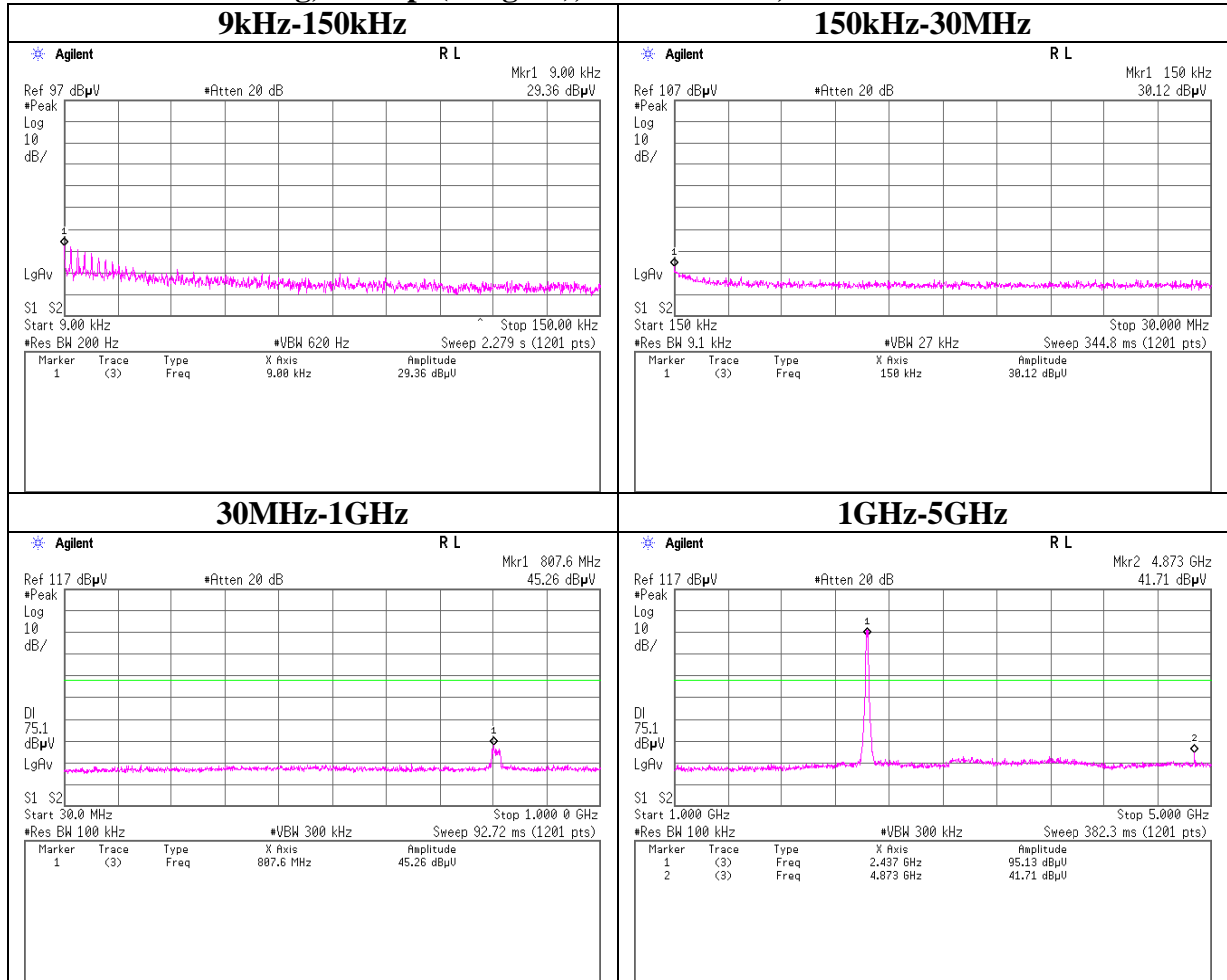

**Conducted Spurious Emission**

**11g, 24Mbps(Long GI), Antenna CN1, Tx 2437MHz**

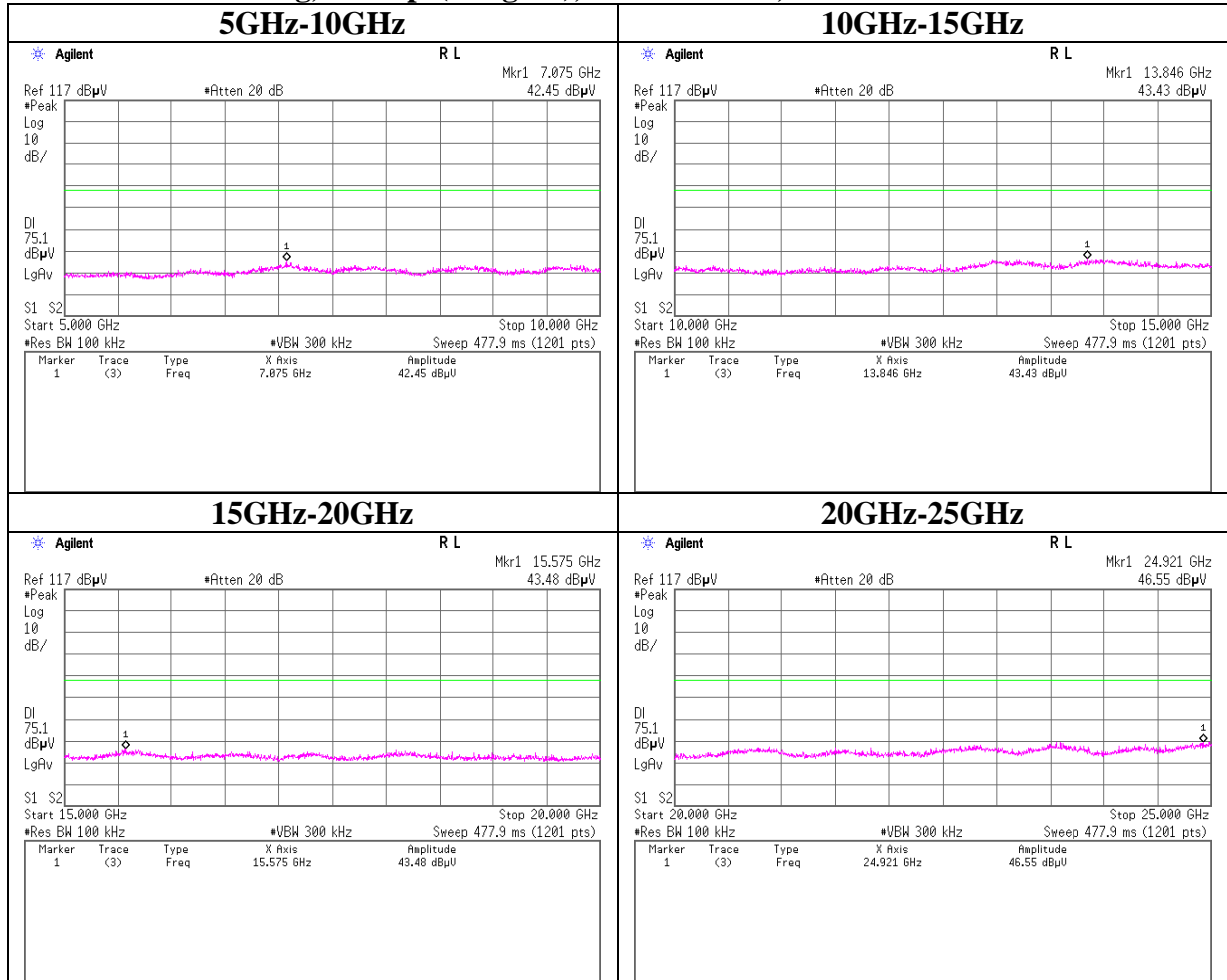

**Conducted Spurious Emission**

**11g, 24Mbps(Long GI), Antenna CN1, Tx 2462MHz**

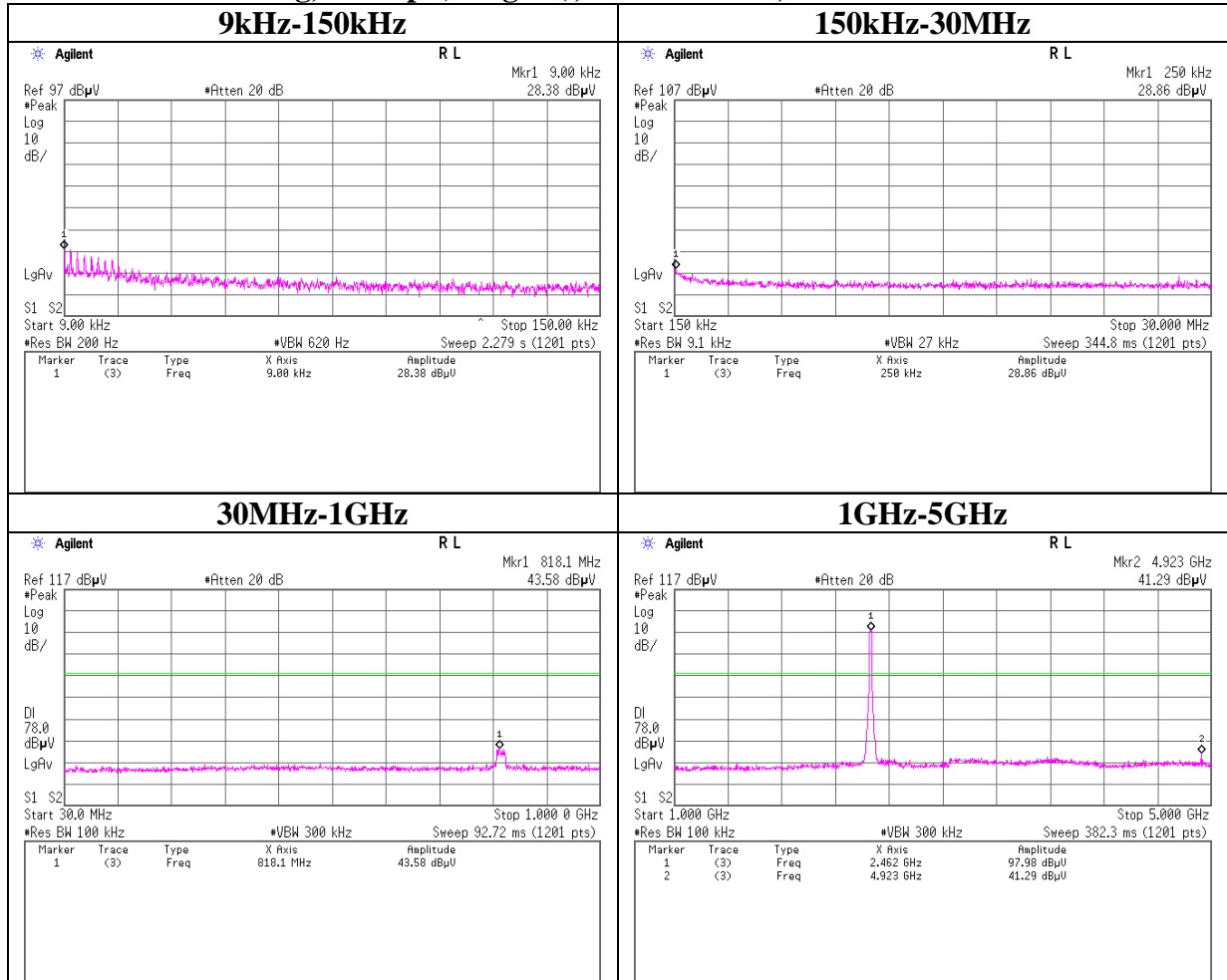



**Conducted Spurious Emission**

**11g, 24Mbps(Long GI), Antenna CN1, Tx 2462MHz**

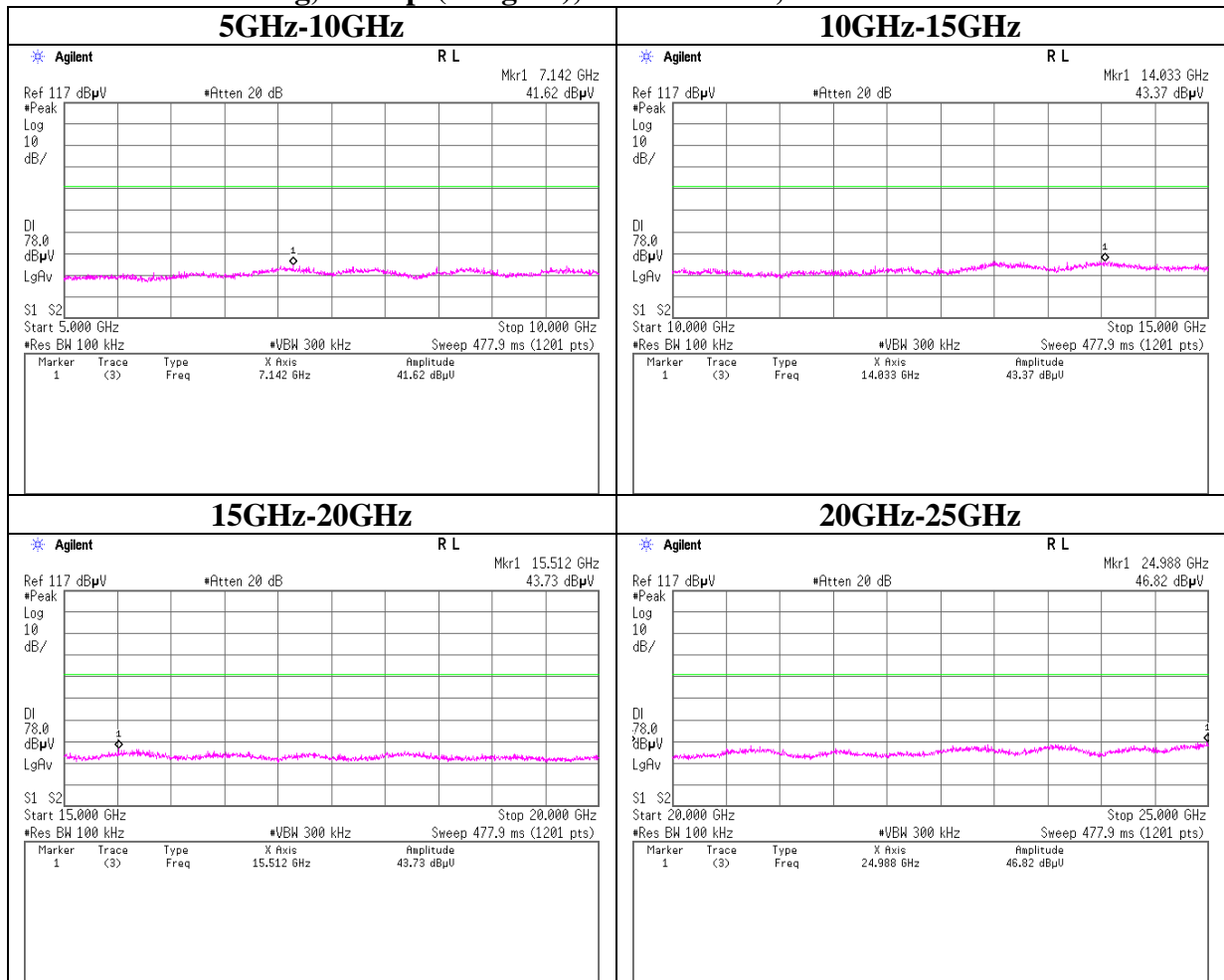

## Conducted Emission Band Edge compliance

### 11b, 11Mbps(Long GI), Antenna CN1, Tx

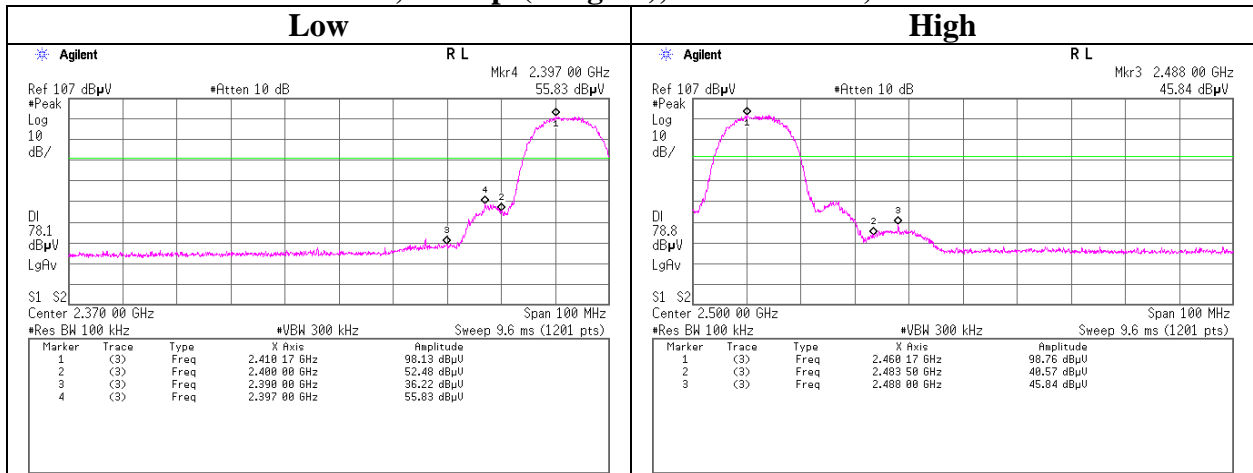

### 11g, 24Mbps(Long GI), Antenna CN1, Tx

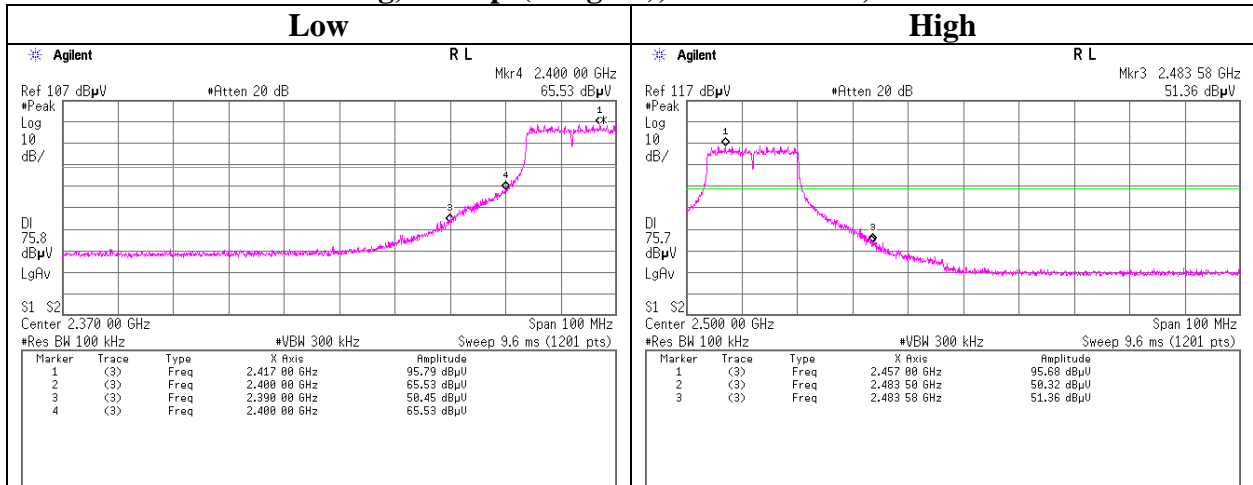

### 11n-20, MCS 4(Long GI), Antenna CN1, Tx

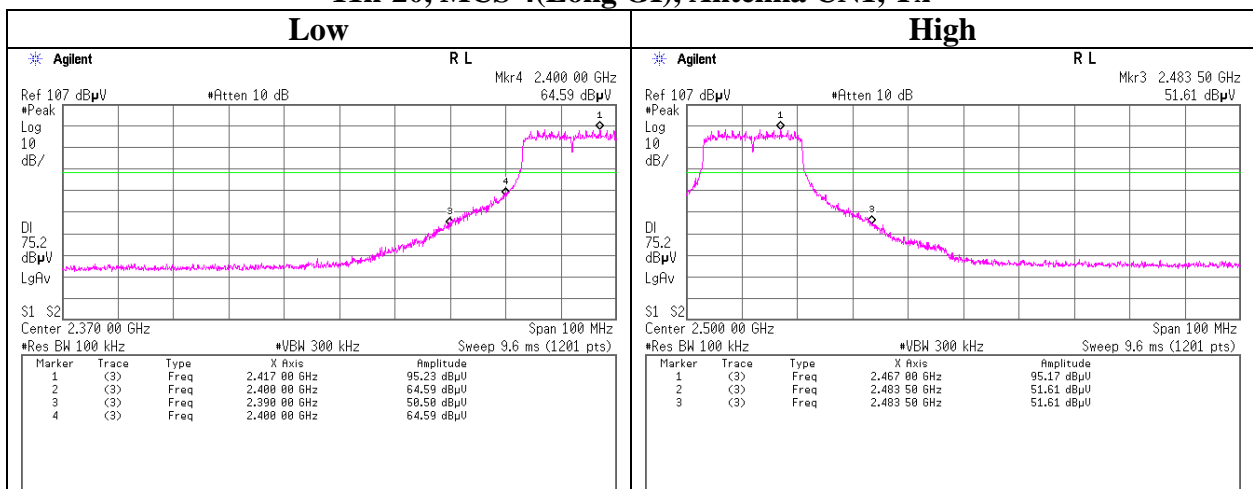

### Power Density

Test place Head Office EMC Lab. No.11 Measurement Room  
Report No. 32FE0146-HO-01  
Date 04/27/2012  
Temperature/ Humidity 20deg. C / 59% RH  
Engineer Yutaka Yoshida  
Mode 11b Tx, 11g Tx

11b 11Mbps(Long GI), Antenna CN1

Freq.	Reading	Cable Loss	Atten.	Result	Limit	Margin
[MHz]	[dBm]	[dB]	[dB]	[dBm]	[dBm]	[dB]
2412.00	-13.62	2.05	10.01	-1.56	8.00	9.56
2437.00	-13.36	2.05	10.01	-1.30	8.00	9.30
2462.00	-13.20	2.07	10.01	-1.12	8.00	9.12

11g 24Mbps(Long GI), Antenna CN1

Freq.	Reading	Cable Loss	Atten.	Result	Limit	Margin
[MHz]	[dBm]	[dB]	[dB]	[dBm]	[dBm]	[dB]
2412.00	-15.33	2.05	10.01	-3.27	8.00	11.27
2437.00	-12.69	2.05	10.01	-0.63	8.00	8.63
2462.00	-15.53	2.07	10.01	-3.45	8.00	11.45

Sample Calculation:

Result = Reading + Cable Loss + Attenuator

**Power Density**

**11b, 11Mbps(Long GI), Antenna CN1**

**11g, 24Mbps(Long GI), Antenna CN1**

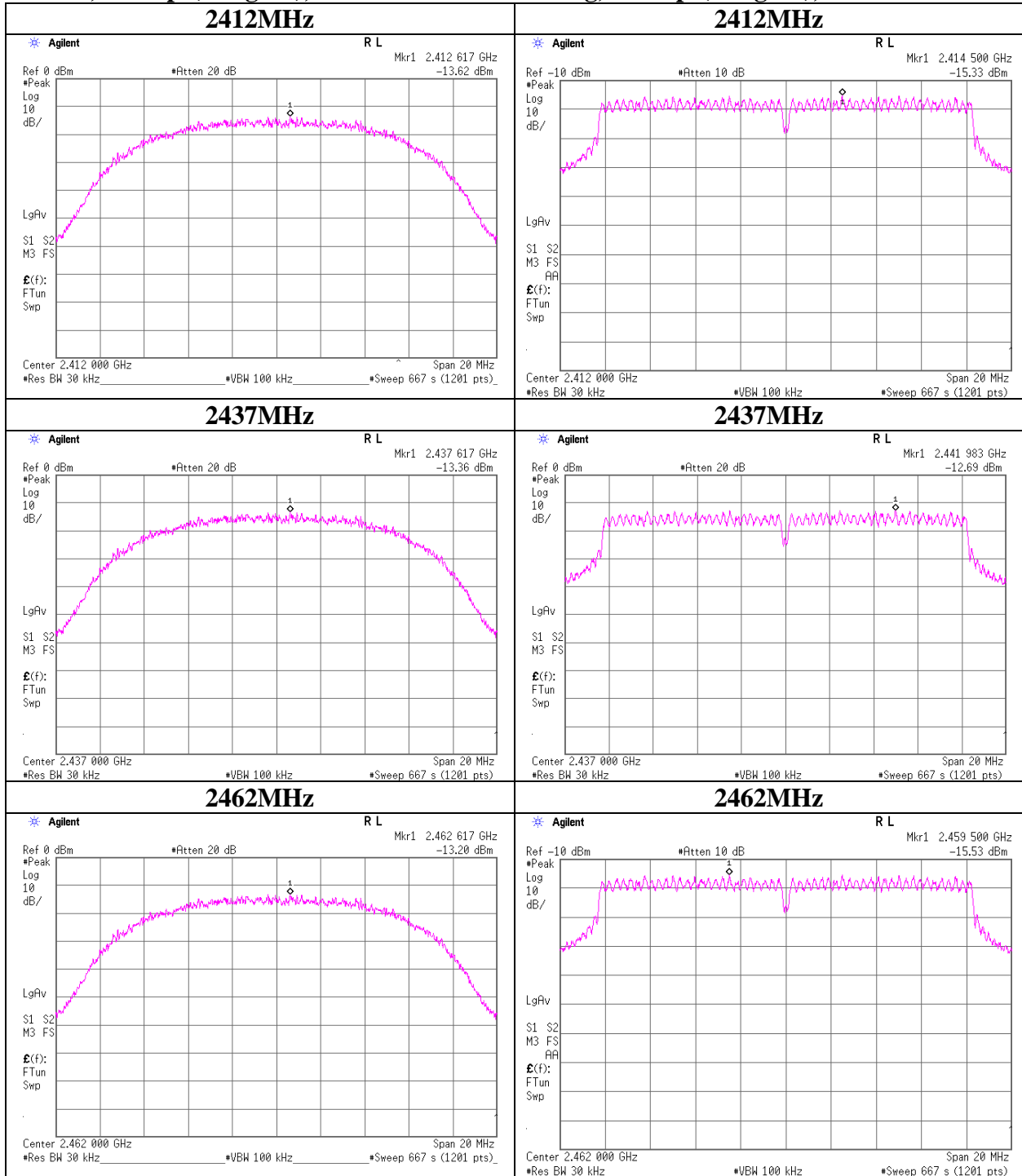

**99% Occupied Bandwidth**

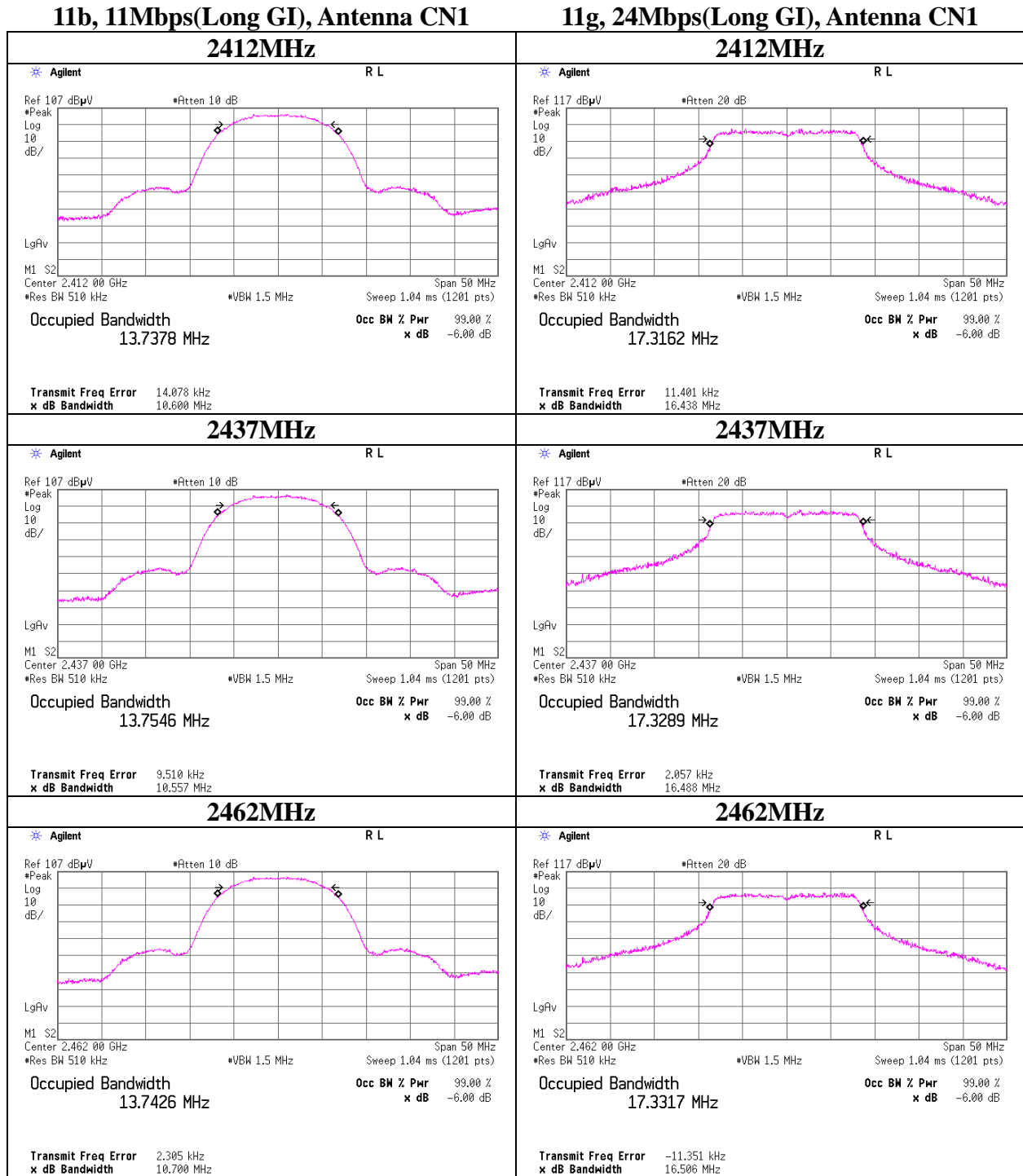

## 99% Occupied Bandwidth

### 11n-20, MCS 4(Long GI), Antenna CN1

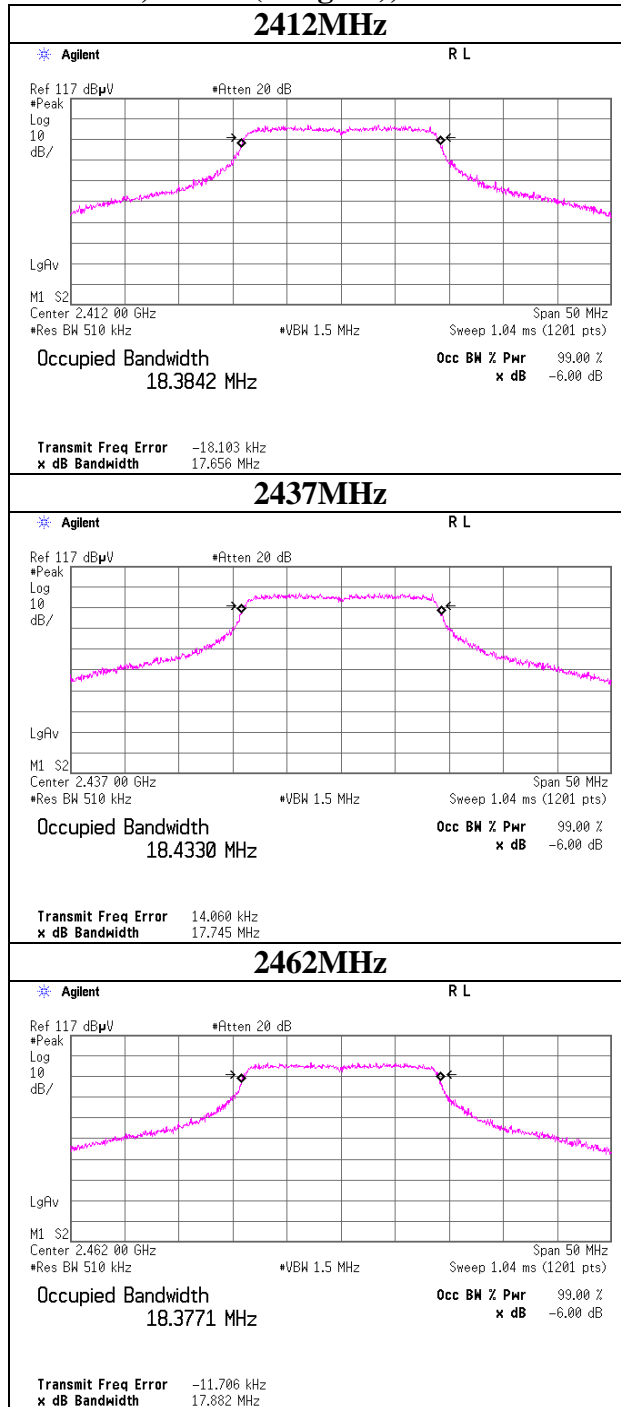

## APPENDIX 2: Test instruments

### EMI test equipment

Control No.	Instrument	Manufacturer	Model No	Serial No	Test Item	Calibration Date * Interval(month)
AT-38	Attenuator	Anritsu	MP721B	6200961025	RE	2011/12/08 * 12
MAEC-03	Semi Anechoic Chamber(NSA)	TDK	Semi Anechoic Chamber 3m	DA-10005	RE/CE	2012/02/24 * 12
MAEC-04	Semi Anechoic Chamber(NSA)	TDK	Semi Anechoic Chamber 3m	DA-10005	RE	2012/02/29 * 12
MBA-05	Biconical Antenna	Schwarzbeck	BBA9106	1302	RE	2011/11/16 * 12
MCC-112	Coaxial cable	Fujikura/Suhner/TSJ	5D-2W(10m)/SFM141(3m)/suciform141-PE(1m)/421-010(1.5m)/RFM-E321(Switcher)	-/00640	CE	2011/07/15 * 12
MLS-06	LISN(AMN)	Schwarzbeck	NSLK8127	8127363	CE(AE)	2012/02/06 * 12
MLS-07	LISN(AMN)	Schwarzbeck	NSLK8127	8127364	CE(EUT)	2012/02/09 * 12
MTA-31	Terminator	TME	CT-01	-	CE	2012/01/11 * 12
MTR-07	Test Receiver	Rohde & Schwarz	ESCI	100635	CE	2012/04/05 * 12
MCC-133	Microwave Cable	HUBER+SUHNER	SUCOFLEX104	336164/4(1m) / 340640(5m)	RE	2011/09/07 * 12
MCC-141	Microwave Cable	Junkosha	MWX221	1203S212(1m) / 1204S062(5m)	RE	2012/04/23 * 12
MCC-36	Microwave Cable	Hirose Electric	U.FL-2LP-066-A-(200)	-	AT	2011/09/30 * 12
MCC-50	Coaxial Cable	UL Japan	-	-	RE	2012/03/15 * 12
MCC-76	Microwave Cable 1G-26.5GHz	Suhner	SUCOFLEX104	278967/4	RE	2011/12/08 * 12
MCC-79	Microwave Cable 1G-26.5GHz	Suhner	SUCOFLEX104	278923/4	RE	2011/12/08 * 12
MHA-16	Horn Antenna 15-40GHz	Schwarzbeck	BBHA9170	BBHA9170306	RE	2012/05/21 * 12
MHA-20	Horn Antenna 1-18GHz	Schwarzbeck	BBHA9120D	258	RE	2012/05/25 * 12
MHA-21	Horn Antenna 1-18GHz	Schwarzbeck	BBHA9120D	9120D-557	RE	2011/08/11 * 12
MHF-19	High Pass Filter 3.5-18.0GHz	TOKIMEC	TF323DCA	602	RE	2011/09/07 * 12
MHF-20	High Pass Filter 3.5-18.0GHz	TOKIMEC	TF323DCC	607	RE	2011/09/08 * 12
MJM-06	Measure	PROMART	SEN1955	-	RE/CE	
MJM-07	Measure	PROMART	SEN1955	-	RE	-
MLA-08	Logperiodic Antenna	Schwarzbeck	UKLP9140-A	N/A	RE	2011/11/16 * 12
MMM-10	DIGITAL HiTESTER	Hioki	3805	051201148	AT	2012/01/13 * 12
MAT-25	Attenuator(10dB)(above 1GHz)	Agilent	8493C	71642	AT	2011/06/23 * 12
MOS-19	Thermo-Hygrometer	Custom	CTH-201	0001	AT	2011/12/09 * 12
MPM-12	Power Meter	Anritsu	ML2495A	0825002	AT	2011/08/09 * 12
MPSE-17	Power sensor	Anritsu	MA2411B	0738285	AT	2011/08/09 * 12
MSA-03	Spectrum Analyzer	Agilent	E4448A	MY44020357	AT	2011/11/23 * 12
MTA-09	Terminator	HP	HP 909D	03745	AT	2012/01/20 * 12
MOS-13	Thermo-Hygrometer	Custom	CTH-180	-	RE/CE	2012/02/06 * 12
MOS-15	Thermo-Hygrometer	Custom	CTH-180	-	RE	2012/02/06 * 12
MPA-11	MicroWave System Amplifier	Agilent	83017A	MY39500779	RE	2012/03/29 * 12
MPA-12	MicroWave System Amplifier	Agilent	83017A	MY39500780	RE	2012/03/28 * 12
MPA-14	Pre Amplifier	SONOMA INSTRUMENT	310	260833	RE	2012/03/05 * 12
MSA-04	Spectrum Analyzer	Agilent	E4448A	US44300523	RE	2012/04/06 * 12
MSA-10	Spectrum Analyzer	Agilent	E4448A	MY46180655	RE/CE	2012/02/03 * 12

**The expiration date of the calibration is the end of the expired month.**

**All equipment is calibrated with valid calibrations. Each measurement data is traceable to the national or international standards.**

**As for some calibrations performed after the tested dates, those test equipment have been controlled by means of an unbroken chains of calibrations.**

**Test Item: CE: Conducted Emission  
RE: Radiated Emission  
AT: Antenna Terminal Conducted test**