

**ELECTROMAGNETIC EMISSIONS
COMPLIANCE REPORT**

Applicant: silex technology, Inc.
2-3-1 Hikaridai, Seika-cho, Soraku-gun, Kyoto 619-0237,
Japan

Manufacturer: silex technology, Inc.
2-3-1 Hikaridai, Seika-cho, Soraku-gun, Kyoto 619-0237,
Japan

Product Name: SX-PCEAX-AP

Brand Name: Silex Technology

Model No.: SX-PCEAX-AP

Model Difference: N/A

Report Number: TERF2310002606ER

FCC ID N6C-PCEAXAP

IC: 4908A-PCEAXAP

Date of EUT Received: October 17, 2023

Date of Test: October 17, 2023~January 10, 2024

Issue Date: February 7, 2024

Approved By _____

Blue Yang

We hereby certify that:

The above equipment was tested by SGS Taiwan Ltd. Central RF Lab The test data, data evaluation, test procedures, and equipment configurations shown in this report were made in accordance with the procedures given in ANSI C63.10:2013 and the energy emitted by the sample EUT comply with FCC rule part §15.407, ISED RSS-247.

The results of this report relate only to the sample identified in this report.

Unless otherwise stated the results shown in this test report refer only to the sample(s) tested and such sample(s) are retained for 90 days only.

除非另有說明，此報告結果僅對測試之樣品負責，同時此樣品僅保留90天。本報告未經本公司書面許可，不可部份複製。

This document is issued by the Company subject to its General Conditions of Service printed overleaf, available on request or accessible at <http://www.sgs.com.tw/Terms-and-Conditions> and for electronic format documents, subject to Terms and Conditions for Electronic Documents at <http://www.sgs.com.tw/Terms-and-Conditions>. Attention is drawn to the limitation of liability, indemnification and jurisdiction issues defined therein. Any holder of this document is advised that information contained hereon reflects the Company's findings at the time of its intervention only and within the limits of Client's instructions, if any. The Company's sole responsibility is to its Client and this document does not exonerate parties to a transaction from exercising all their rights and obligations under the transaction documents. This document cannot be reproduced except in full, without prior written approval of the Company. Any unauthorized alteration, forgery or falsification of the content or appearance of this document is unlawful and offenders may be prosecuted to the fullest extent of the law.

Revision History

Report Number	Revision	Description	Issue Date	Revised By	Remark
TERF2310002606ER	00	Original.	February 7, 2024	Susan Lin	

Note:

- 1、The remark "*" indicates modification of the report upon requests from certification body.

Unless otherwise stated the results shown in this test report refer only to the sample(s) tested and such sample(s) are retained for 90 days only.

除非另有說明，此報告結果僅對測試之樣品負責，同時此樣品僅保留90天。本報告未經本公司書面許可，不可部份複製。

This document is issued by the Company subject to its General Conditions of Service printed overleaf, available on request or accessible at <http://www.sgs.com.tw/Terms-and-Conditions> and for electronic format documents, subject to Terms and Conditions for Electronic Documents at <http://www.sgs.com.tw/Terms-and-Conditions>. Attention is drawn to the limitation of liability, indemnification and jurisdiction issues defined therein. Any holder of this document is advised that information contained hereon reflects the Company's findings at the time of its intervention only and within the limits of Client's instructions, if any. The Company's sole responsibility is to its Client and this document does not exonerate parties to a transaction from exercising all their rights and obligations under the transaction documents. This document cannot be reproduced except in full, without prior written approval of the Company. Any unauthorized alteration, forgery or falsification of the content or appearance of this document is unlawful and offenders may be prosecuted to the fullest extent of the law.

SGS Taiwan Ltd.

No.134,Wu Kung Road, New Taipei Industrial Park, Wuku District, New Taipei City, Taiwan/新北市五股區新北產業園區五工路 134 號

台灣檢驗科技股份有限公司

t (886-2) 2299-3279

f (886-2) 2298-0488

www.sgs.com.tw

Member of SGS Group

Contents

1	GENERAL INFORMATION	4
2	SUMMARY OF TEST RESULT	8
3	MEASUREMENT UNCERTAINTY.....	8
4	TPC AND DFS MEASUREMENT	9
5	APPLICABLE STANDARDS.....	11
6	TEST SETUP.....	14
7	TEST EQUIPMENT USED:.....	15
8	DESCRIPTION OF EUT:	16
9	RADAR TYPE WAVEFORM CALIBRATION AT DFS DETECTION THRESHOLD.....	17
10	CHANNEL CLOSING TRANSMISSION AND CHANNEL MOVE TIME MEASUREMENT (RADAR TYPE 0)	28
11	DUTY CYCLE	30
12	NON-OCCUPANCY PERIOD MEASUREMENT.....	32
13	UNII DETECTION BANDWIDTH MEASUREMENT	33
14	CHANNEL AVAILABILITY CHECK MEASUREMENT.....	43
15	IN SERVICE MONITORING.....	44

Unless otherwise stated the results shown in this test report refer only to the sample(s) tested and such sample(s) are retained for 90 days only.
 除非另有說明，此報告結果僅對測試之樣品負責，同時此樣品僅保留90天。本報告未經本公司書面許可，不可部份複製。

This document is issued by the Company subject to its General Conditions of Service printed overleaf, available on request or accessible at <http://www.sgs.com.tw/Terms-and-Conditions> and for electronic format documents, subject to Terms and Conditions for Electronic Documents at <http://www.sgs.com.tw/Terms-and-Conditions>. Attention is drawn to the limitation of liability, indemnification and jurisdiction issues defined therein. Any holder of this document is advised that information contained hereon reflects the Company's findings at the time of its intervention only and within the limits of Client's instructions, if any. The Company's sole responsibility is to its Client and this document does not exonerate parties to a transaction from exercising all their rights and obligations under the transaction documents. This document cannot be reproduced except in full, without prior written approval of the Company. Any unauthorized alteration, forgery or falsification of the content or appearance of this document is unlawful and offenders may be prosecuted to the fullest extent of the law.

1 GENERAL INFORMATION

1.1 Product Description

Product Name:	SX-PCEAX-AP
Brand Name:	Silex Technology
Model No.:	SX-PCEAX-AP
Model Difference:	N/A
Hardware Version:	N/A
Firmware Version:	N/A
Major Version:	QSDK.12
EUT Series No.:	ES4-26
Power Supply:	3.3Vdc

1.2 DFS Firmware version:

```

COM85 - Tera Term VT
File Edit Setup Control Window Help
[ 57.608823] wlan: [418:I:ANY] wlan_scan_update_channel_list: num_chan: 25
[ 57.616028] wlan: [418:E:ANY] dfs_init_chan_state_array: channel state array
initialized
[ 57.633926] wlan: [418:I:ANY] wlan_scan_update_channel_list: num_chan: 25
[ 57.641073] wlan: [418:I:ANY] ieee80211_setcountry_tryretaining_curchan: [472] S
kipping current channel retention during set_country operation
[ 57.653650] wlan: [418:I:ANY] number of channels: 2G = 0 5G = 25, 6G = 0
Setmode 11AHE160
Selected interface 'global'
[ 59.891549] 8021q: adding VLAN 0 to HW filter on device ath0
[ 59.934722] wlan: [436:I:ANY] DES SSID SET=dfs-test
[ 59.939638] wlan: [436:I:ANY] desired hw mode: 31
[ 59.944849] wlan: [436:E:MBSSID] ieee80211_ucfg_set_txvap: MBSSID is not enab
led
OK
root@imx8mqevk:~# [ 59.983931] wlan: [0:I:ANY] ol_ath_vap_start_response_event
handler: Update max allowed tx power 75 -> 14
[ 59.983931]
[ 60.996816] wlan: [0:E:ANY] Smart Antenna functions are not registered !!!

root@imx8mqevk:~# dmesg | grep sx
[ 48.246581] wlan: [384:I:ANY] init_umac: wlan-12.x Host Driver version: QSDK.
12 0-01287-P-1 sx 1.0.0a23
root@imx8mqevk:~#
    
```

Unless otherwise stated the results shown in this test report refer only to the sample(s) tested and such sample(s) are retained for 90 days only.

除非另有說明，此報告結果僅對測試之樣品負責，同時此樣品僅保留90天。本報告未經本公司書面許可，不可部份複製。

This document is issued by the Company subject to its General Conditions of Service printed overleaf, available on request or accessible at <http://www.sgs.com.tw/Terms-and-Conditions> and for electronic format documents, subject to Terms and Conditions for Electronic Documents at <http://www.sgs.com.tw/Terms-and-Conditions>. Attention is drawn to the limitation of liability, indemnification and jurisdiction issues defined therein. Any holder of this document is advised that information contained hereon reflects the Company's findings at the time of its intervention only and within the limits of Client's instructions, if any. The Company's sole responsibility is to its Client and this document does not exonerate parties to a transaction from exercising all their rights and obligations under the transaction documents. This document cannot be reproduced except in full, without prior written approval of the Company. Any unauthorized alteration, forgery or falsification of the content or appearance of this document is unlawful and offenders may be prosecuted to the fullest extent of the law.

1.3 WLAN 5GHz:

Wi-Fi	Frequency Range	Channels	Modulation Technology
a/ n_HT/ ac_VHT/ ax_HE 20M	5180~5240	4	OFDM
	5260~5320	4	OFDM
	5500~5720	12	OFDM
	5745-5825	5	OFDM
n_HT ac_VHT/ ax_HE 40M	5190~5230	2	OFDMA
	5270~5310	2	OFDMA
	5510~5710	6	OFDMA
	5755-5795	2	OFDMA
ac_VHT/ ax_HE 80M	5210	1	OFDMA
	5290	1	OFDM
	5530~5690	3	OFDMA
	5775	1	OFDMA
ac_VHT/ ax_HE 160M	5250	1	OFDMA
	5570	1	OFDMA

Unless otherwise stated the results shown in this test report refer only to the sample(s) tested and such sample(s) are retained for 90 days only.
 除非另有說明，此報告結果僅對測試之樣品負責，同時此樣品僅保留90天。本報告未經本公司書面許可，不可部份複製。

This document is issued by the Company subject to its General Conditions of Service printed overleaf, available on request or accessible at <http://www.sgs.com.tw/Terms-and-Conditions> and for electronic format documents, subject to Terms and Conditions for Electronic Documents at <http://www.sgs.com.tw/Terms-and-Conditions>. Attention is drawn to the limitation of liability, indemnification and jurisdiction issues defined therein. Any holder of this document is advised that information contained hereon reflects the Company's findings at the time of its intervention only and within the limits of Client's instructions, if any. The Company's sole responsibility is to its Client and this document does not exonerate parties to a transaction from exercising all their rights and obligations under the transaction documents. This document cannot be reproduced except in full, without prior written approval of the Company. Any unauthorized alteration, forgery or falsification of the content or appearance of this document is unlawful and offenders may be prosecuted to the fullest extent of the law.

1.4 Antenna Designation

Antenna Type	Supplier	Antenna Part No.	Freq. (MHz)	Peak Antenna Gain (dBi)	Directional Gain (dBi)
Dipole	Molex	146153	5150~5250	3.175	6.185
			5250~5350	2.975	5.985
			5470~5725	4.275	7.285
			5725~5850	3.775	6.785
Dipole	Unictron Technologies Corporation	AA258	5150~5250	3.22	6.23
			5250~5350	3.91	6.92
			5470~5725	2.77	5.78
			5725~5850	3.92	6.93

Note:

1. Pre-scanned was done on the above antennas, measurements were demonstrated by using the antenna with the highest gain as the worst case scenarios.
2. Antenna information is provided by the applicant.

Unless otherwise stated the results shown in this test report refer only to the sample(s) tested and such sample(s) are retained for 90 days only.

除非另有說明，此報告結果僅對測試之樣品負責，同時此樣品僅保留90天。本報告未經本公司書面許可，不可部份複製。

This document is issued by the Company subject to its General Conditions of Service printed overleaf, available on request or accessible at <http://www.sgs.com.tw/Terms-and-Conditions> and for electronic format documents, subject to Terms and Conditions for Electronic Documents at <http://www.sgs.com.tw/Terms-and-Conditions>. Attention is drawn to the limitation of liability, indemnification and jurisdiction issues defined therein. Any holder of this document is advised that information contained hereon reflects the Company's findings at the time of its intervention only and within the limits of Client's instructions, if any. The Company's sole responsibility is to its Client and this document does not exonerate parties to a transaction from exercising all their rights and obligations under the transaction documents. This document cannot be reproduced except in full, without prior written approval of the Company. Any unauthorized alteration, forgery or falsification of the content or appearance of this document is unlawful and offenders may be prosecuted to the fullest extent of the law.

1.5 Test Methodology of Applied Standards

FCC Part 15, Subpart E §15.407

FCC KDB 905462 D02 UNII DFS Compliance Procedures New Rules v02
RSS-247 issue 3 Aug. 2023

1.6 Test Facility

Laboratory	Test Site Address	Test Site Name	FCC Designation number	IC CAB identifier
SGS Taiwan Ltd. Central RF Lab. (TAF code 3702)	No.134, Wu Kung Road, New Taipei Industrial Park, Wuku District, New Taipei City, Taiwan.	SAC 1	TW0027	TW3702
		SAC 2		
		SAC 3		
		Conduction 1		
		Conducted 1		
		Conducted 2		
		Conducted 3		
		Conducted 4		
		Conducted 5		
	Conducted 6			
	No.2, Keji 1st Rd., Guishan District, Taoyuan City, Taiwan 333	Conduction C	TW0028	
		SAC C		
		SAC D		
		SAC G		
		Conducted A		
		Conducted B		
		Conducted C		
		Conducted D		
		Conducted E		
Conducted F				
Conducted G				

Note: Test site name is remarked on the equipment list in each section of this report as an indication where measurements occurred in specific test site and address.

1.7 Special Accessories

There are no special accessories used while test was conducted.

1.8 Equipment Modifications

There was no modification incorporated into the EUT.

Unless otherwise stated the results shown in this test report refer only to the sample(s) tested and such sample(s) are retained for 90 days only.

除非另有說明，此報告結果僅對測試之樣品負責，同時此樣品僅保留90天。本報告未經本公司書面許可，不可部份複製。

This document is issued by the Company subject to its General Conditions of Service printed overleaf, available on request or accessible at <http://www.sgs.com.tw/Terms-and-Conditions>, and for electronic format documents, subject to Terms and Conditions for Electronic Documents at <http://www.sgs.com.tw/Terms-and-Conditions>. Attention is drawn to the limitation of liability, indemnification and jurisdiction issues defined therein. Any holder of this document is advised that information contained hereon reflects the Company's findings at the time of its intervention only and within the limits of Client's instructions, if any. The Company's sole responsibility is to its Client and this document does not exonerate parties to a transaction from exercising all their rights and obligations under the transaction documents. This document cannot be reproduced except in full, without prior written approval of the Company. Any unauthorized alteration, forgery or falsification of the content or appearance of this document is unlawful and offenders may be prosecuted to the fullest extent of the law.

2 SUMMARY OF TEST RESULT

FCC and ISED Rules	Description Of Test	Result
§15.407(h) FCC KDB 905462 D02 IC RSS-247 issue 3 §6.3	TPC and DFS Measurement	Compliant

3 MEASUREMENT UNCERTAINTY

Test Items	Uncertainty
TPC and DFS Measurement	+/- 1.04 Hz
Temperature	+/- 0.7 °C
Humidity	+/- 3 %
DC / AC Power Source	+/- 1 %

This uncertainty represents an expanded uncertainty expressed at approximately the 95% confidence level using a coverage factor of k=2.

The conformity assessment statement in this report is based solely on the test results, measurement uncertainty is excluded.

Unless otherwise stated the results shown in this test report refer only to the sample(s) tested and such sample(s) are retained for 90 days only.

除非另有說明，此報告結果僅對測試之樣品負責，同時此樣品僅保留90天。本報告未經本公司書面許可，不可部份複製。

This document is issued by the Company subject to its General Conditions of Service printed overleaf, available on request or accessible at <http://www.sgs.com.tw/Terms-and-Conditions> and for electronic format documents, subject to Terms and Conditions for Electronic Documents at <http://www.sgs.com.tw/Terms-and-Conditions>. Attention is drawn to the limitation of liability, indemnification and jurisdiction issues defined therein. Any holder of this document is advised that information contained hereon reflects the Company's findings at the time of its intervention only and within the limits of Client's instructions, if any. The Company's sole responsibility is to its Client and this document does not exonerate parties to a transaction from exercising all their rights and obligations under the transaction documents. This document cannot be reproduced except in full, without prior written approval of the Company. Any unauthorized alteration, forgery or falsification of the content or appearance of this document is unlawful and offenders may be prosecuted to the fullest extent of the law.

4 TPC AND DFS MEASUREMENT

4.1 TPC Requirements

According to Part 15.407 (h)(1) Transmit power control (TPC). U-NII devices operating in the 5.25-5.35 GHz band and the 5.47-5.725 GHz band shall employ a TPC mechanism. The U-NII device is required to have the capability to operate at least 6 dB below the mean EIRP value of 30 dBm. A TPC mechanism is not required for systems with an e.i.r.p. of less than 500 mW.

Result:

N/A, e.i.r.p is less then 500 mW, TPC is not required.

4.2 DFS: Standard Applicable

According to §15.407(h)(2) and FCC KDB 905462 D02 , Radar Detection Function of Dynamic Frequency Selection (DFS).

Radar Detection Function of Dynamic Frequency Selection (DFS). U-NII devices operating with any part of its 26 dB emission bandwidth in the 5.25-5.35 GHz and 5.47-5.725 GHz bands shall employ a DFS radar detection mechanism to detect the presence of radar systems and to avoid co-channel operation with radar systems. Operators shall only use equipment with a DFS mechanism that is turned on when operating in these bands. The device must sense for radar signals at 100 percent of its emission bandwidth. The minimum DFS detection threshold for devices with a maximum e.i.r.p. of 200 mW to 1 W is -64 dBm. For devices that operate with less than 200 mW e.i.r.p. and a power spectral density of less than 10 dBm in a 1 MHz band, the minimum detection threshold is -62 dBm. The detection threshold is the received power averaged over 1 microsecond referenced to a 0 dBi antenna. For the initial channel setting, the manufacturers shall be permitted to provide for either random channel selection or manual channel selection.

- (i) Operational Modes. The DFS requirement applies to the following operational modes:
 - (a) The requirement for channel availability check time applies in the master operational mode.
 - (b) The requirement for channel move time applies in both the master and slave operational modes.
- (ii) Channel Availability Check Time. A U-NII device shall check if there is a radar system already operating on the channel before it can initiate a transmission on a channel and when it has to move to a new channel. The U-NII device may start using the channel if no radar signal with a power level greater than the interference threshold values listed in paragraph (h)(2) of this section, is detected within 60 seconds.
- (iii) Channel Move Time. After a radar's presence is detected, all transmissions shall cease on the operating channel within 10 seconds. Transmissions during this period shall consist of normal traffic for a maximum of 200 ms after detection of the radar signal. In addition, intermittent management and control signals can be sent during the remaining time to facilitate vacating the operating channel.

Non-occupancy Period. A channel that has been flagged as containing a radar system,

Unless otherwise stated the results shown in this test report refer only to the sample(s) tested and such sample(s) are retained for 90 days only.

除非另有說明，此報告結果僅對測試之樣品負責，同時此樣品僅保留90天。本報告未經本公司書面許可，不可部份複製。

This document is issued by the Company subject to its General Conditions of Service printed overleaf, available on request or accessible at <http://www.sgs.com.tw/Terms-and-Conditions> and for electronic format documents, subject to Terms and Conditions for Electronic Documents at <http://www.sgs.com.tw/Terms-and-Conditions>. Attention is drawn to the limitation of liability, indemnification and jurisdiction issues defined therein. Any holder of this document is advised that information contained hereon reflects the Company's findings at the time of its intervention only and within the limits of Client's instructions, if any. The Company's sole responsibility is to its Client and this document does not exonerate parties to a transaction from exercising all their rights and obligations under the transaction documents. This document cannot be reproduced except in full, without prior written approval of the Company. Any unauthorized alteration, forgery or falsification of the content or appearance of this document is unlawful and offenders may be prosecuted to the fullest extent of the law.

either by a channel availability check or in-service monitoring, is subject to a non-occupancy period of at least 30 minutes. The non-occupancy period starts at the time when the radar system is detected.

Unless otherwise stated the results shown in this test report refer only to the sample(s) tested and such sample(s) are retained for 90 days only.

除非另有說明，此報告結果僅對測試之樣品負責，同時此樣品僅保留90天。本報告未經本公司書面許可，不可部份複製。

This document is issued by the Company subject to its General Conditions of Service printed overleaf, available on request or accessible at <http://www.sgs.com.tw/Terms-and-Conditions> and for electronic format documents, subject to Terms and Conditions for Electronic Documents at <http://www.sgs.com.tw/Terms-and-Conditions>. Attention is drawn to the limitation of liability, indemnification and jurisdiction issues defined therein. Any holder of this document is advised that information contained hereon reflects the Company's findings at the time of its intervention only and within the limits of Client's instructions, if any. The Company's sole responsibility is to its Client and this document does not exonerate parties to a transaction from exercising all their rights and obligations under the transaction documents. This document cannot be reproduced except in full, without prior written approval of the Company. Any unauthorized alteration, forgery or falsification of the content or appearance of this document is unlawful and offenders may be prosecuted to the fullest extent of the law.

SGS Taiwan Ltd.

No.134,Wu Kung Road, New Taipei Industrial Park, Wuku District, New Taipei City, Taiwan/新北市五股區新北產業園區五工路 134 號

台灣檢驗科技股份有限公司

t (886-2) 2299-3279

f (886-2) 2298-0488

www.sgs.com.tw

Member of SGS Group

5 APPLICABLE STANDARDS

Table 1: Applicability of DFS requirements prior to use of a channel

Requirement	Operational Mode	
	<input checked="" type="checkbox"/> Master	<input type="checkbox"/> Client (with radar detection)
Non-occupancy Period	Yes	Yes
DFS Detection Threshold	Yes	Yes
Channel Availability Check Time	Yes	Not required
U-NII Detection Bandwidth	Yes	Yes

Table 2: Applicability of DFS requirements during normal operation

Requirement	Operational Mode
	Master Device or Client with Radar Detection
DFS Detection Threshold	Yes
Channel Closing Transmission time	Yes
Channel Move time	Yes
U-NII Detection Bandwidth	Yes

Additional requirements for devices with multiple bandwidth mode	Master Device or Client with Radar Detection
U-NII Detection Bandwidth and Statistical Performance Check	All BW modes must be tested
Channel Move Time and Channel Closing Transmission Time	Test using widest BW mode available
All other tests	Any single BW mode

Note: Frequencies selected for statistical performance check (Section 7.8.4) should include several frequencies within the radar detection bandwidth and frequencies near the edge of the radar detection bandwidth. For 802.11 devices it is suggested to select frequencies in each of the bonded 20 MHz channels and the channel center frequency.

Unless otherwise stated the results shown in this test report refer only to the sample(s) tested and such sample(s) are retained for 90 days only.

除非另有說明，此報告結果僅對測試之樣品負責，同時此樣品僅保留90天。本報告未經本公司書面許可，不可部份複製。

This document is issued by the Company subject to its General Conditions of Service printed overleaf, available on request or accessible at <http://www.sgs.com.tw/Terms-and-Conditions> and for electronic format documents, subject to Terms and Conditions for Electronic Documents at <http://www.sgs.com.tw/Terms-and-Conditions>. Attention is drawn to the limitation of liability, indemnification and jurisdiction issues defined therein. Any holder of this document is advised that information contained hereon reflects the Company's findings at the time of its intervention only and within the limits of Client's instructions, if any. The Company's sole responsibility is to its Client and this document does not exonerate parties to a transaction from exercising all their rights and obligations under the transaction documents. This document cannot be reproduced except in full, without prior written approval of the Company. Any unauthorized alteration, forgery or falsification of the content or appearance of this document is unlawful and offenders may be prosecuted to the fullest extent of the law.

Table 3: Interference Threshold values, Master or Client incorporating In-Service Monitoring

Maximum Transmit Power	Value (See Notes 1, 2, and 3)
EIRP \geq 200 milliwatt	-64 dBm
EIRP $<$ 200 milliwatt and power spectral density $<$ 10 dBm/MHz	-62 dBm
EIRP $<$ 200 milliwatt that do not meet the power spectral density requirement	-64 dBm
<p>Note 1: This is the level at the input of the receiver assuming a 0 dBi receive antenna.</p> <p>Note 2: Throughout these test procedures an additional 1 dB has been added to the amplitude of the test transmission waveforms to account for variations in measurement equipment. This will ensure that the test signal is at or above the detection threshold level to trigger a DFS response.</p> <p>Note 3: EIRP is based on the highest antenna gain. For MIMO devices refer to KDB Publication 662911 D01.</p>	

Table 4: DFS Response requirement values

Parameter	Value
Non-occupancy period	Minimum 30 minutes
Channel Availability Check Time	60 seconds
Channel Move Time	10 seconds See Note 1.
Channel Closing Transmission Time	200 milliseconds + an aggregate of 60 milliseconds over remaining 10 second period. See Notes 1 and 2.
U-NII Detection Bandwidth	Minimum 100% of the U-NII 99% transmission power bandwidth. See Note 3.
<p>Note 1: Channel Move Time and the Channel Closing Transmission Time should be performed with Radar Type 0. The measurement timing begins at the end of the Radar Type 0 burst.</p> <p>Note 2: The Channel Closing Transmission Time is comprised of 200 milliseconds starting at the beginning of the Channel Move Time plus any additional intermittent control signals required to facilitate a Channel move (an aggregate of 60 milliseconds) during the remainder of the 10 second period. The aggregate duration of control signals will not count quiet periods in between transmissions.</p> <p>Note 3: During the U-NII Detection Bandwidth detection test, radar type 0 should be used. For each frequency step the minimum percentage of detection is 90 percent. Measurements are performed with no data traffic.</p>	

Unless otherwise stated the results shown in this test report refer only to the sample(s) tested and such sample(s) are retained for 90 days only.

除非另有說明，此報告結果僅對測試之樣品負責，同時此樣品僅保留90天。本報告未經本公司書面許可，不可部份複製。

This document is issued by the Company subject to its General Conditions of Service printed overleaf, available on request or accessible at <http://www.sgs.com.tw/Terms-and-Conditions> and for electronic format documents, subject to Terms and Conditions for Electronic Documents at <http://www.sgs.com.tw/Terms-and-Conditions>. Attention is drawn to the limitation of liability, indemnification and jurisdiction issues defined therein. Any holder of this document is advised that information contained hereon reflects the Company's findings at the time of its intervention only and within the limits of Client's instructions, if any. The Company's sole responsibility is to its Client and this document does not exonerate parties to a transaction from exercising all their rights and obligations under the transaction documents. This document cannot be reproduced except in full, without prior written approval of the Company. Any unauthorized alteration, forgery or falsification of the content or appearance of this document is unlawful and offenders may be prosecuted to the fullest extent of the law.

**Table 5: Radar Test Waveforms
Short Pulse Radar**

Radar Type	Pulse Width (μsec)	PRI (μsec)	Number of Pulses	Minimum Percentage of Successful Detection	Minimum Number of Trials
0	1	1428	18	See Note 1	See Note 1
1	1	Test A: 15 unique PRI values randomly selected from the list of 23 PRI values in Table 5a Test B: 15 unique PRI values randomly selected within the range of 518-3066 μsec, with a minimum increment of 1 μsec, excluding PRI values selected in Test A	$\text{Roundup} \left\{ \begin{array}{l} \left(\frac{1}{360} \right) \cdot \\ \left(\frac{19 \cdot 10^6}{\text{PRI}_{\mu\text{sec}}} \right) \end{array} \right\}$	60%	30
2	1-5	150-230	23-29	60%	30
3	6-10	200-500	16-18	60%	30
4	11-20	200-500	12-16	60%	30
Aggregate (Radar Types 1-4)				80%	120
Note 1: Short Pulse Radar Type 0 should be used for the detection bandwidth test, channel move time, and channel closing time tests.					

Long Pulse Radar

Radar Type	Pulse Width (μsec)	Chirp Width (MHz)	PRI (μsec)	Number of Pulses per Burst	Number of Bursts	Minimum Percentage of Successful Detection	Minimum Number of Trials
5	50-100	5-20	1000-2000	1-3	8-20	80%	30

Frequency Hopping Radar

Radar Type	Pulse Width (μsec)	PRI (μsec)	Pulses per Hop	Hopping Rate (kHz)	Hopping Sequence Length (msec)	Minimum Percentage of Successful Detection	Minimum Number of Trials
6	1	333	9	0.333	300	70%	30

The applicant of this given application confirms that information regarding the parameters of the detected Radar Waveforms is not available to the end user.

Unless otherwise stated the results shown in this test report refer only to the sample(s) tested and such sample(s) are retained for 90 days only.

除非另有說明，此報告結果僅對測試之樣品負責，同時此樣品僅保留90天。本報告未經本公司書面許可，不可部份複製。

This document is issued by the Company subject to its General Conditions of Service printed overleaf, available on request or accessible at <http://www.sgs.com.tw/Terms-and-Conditions>, and for electronic format documents, subject to Terms and Conditions for Electronic Documents at <http://www.sgs.com.tw/Terms-and-Conditions>. Attention is drawn to the limitation of liability, indemnification and jurisdiction issues defined therein. Any holder of this document is advised that information contained hereon reflects the Company's findings at the time of its intervention only and within the limits of Client's instructions, if any. The Company's sole responsibility is to its Client and this document does not exonerate parties to a transaction from exercising all their rights and obligations under the transaction documents. This document cannot be reproduced except in full, without prior written approval of the Company. Any unauthorized alteration, forgery or falsification of the content or appearance of this document is unlawful and offenders may be prosecuted to the fullest extent of the law.

6 TEST SETUP

Setup for Master with injection at the Master

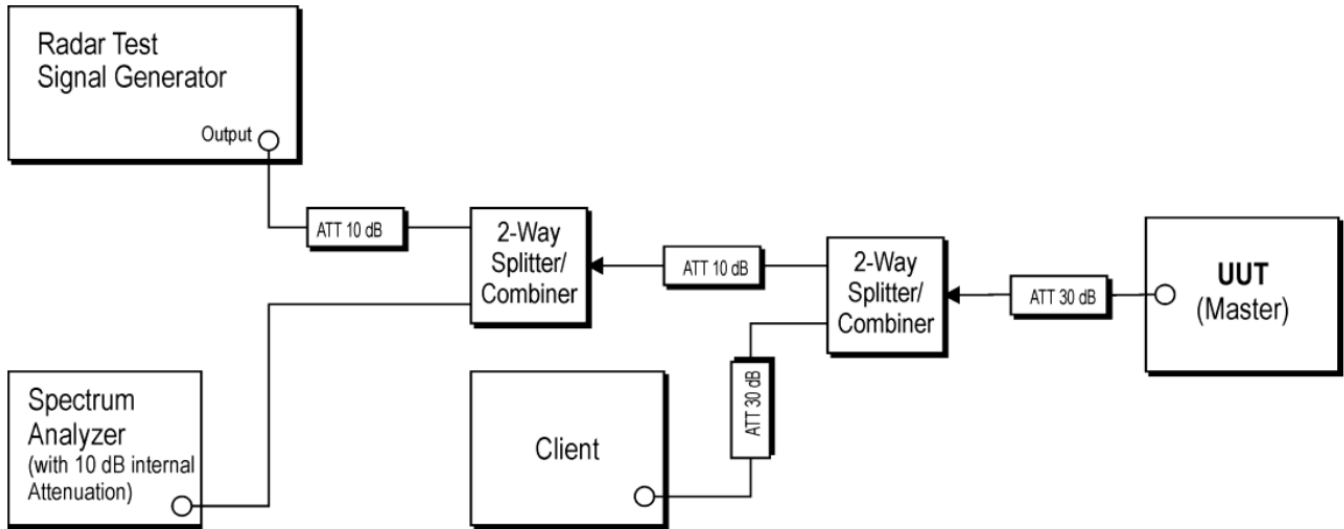

Unless otherwise stated the results shown in this test report refer only to the sample(s) tested and such sample(s) are retained for 90 days only.

除非另有說明，此報告結果僅對測試之樣品負責，同時此樣品僅保留90天。本報告未經本公司書面許可，不可部份複製。
 This document is issued by the Company subject to its General Conditions of Service printed overleaf, available on request or accessible at <http://www.sgs.com.tw/Terms-and-Conditions> and for electronic format documents, subject to Terms and Conditions for Electronic Documents at <http://www.sgs.com.tw/Terms-and-Conditions>. Attention is drawn to the limitation of liability, indemnification and jurisdiction issues defined therein. Any holder of this document is advised that information contained hereon reflects the Company's findings at the time of its intervention only and within the limits of Client's instructions, if any. The Company's sole responsibility is to its Client and this document does not exonerate parties to a transaction from exercising all their rights and obligations under the transaction documents. This document cannot be reproduced except in full, without prior written approval of the Company. Any unauthorized alteration, forgery or falsification of the content or appearance of this document is unlawful and offenders may be prosecuted to the fullest extent of the law.

7 TEST EQUIPMENT USED:

Conducted Emission Test Site: Conducted 6					
EQUIPMENT TYPE	MFR	MODEL NUMBER	SERIAL NUMBER	LAST CAL.	CAL DUE.
EXA Spectrum Analyzer	KEYSIGHT	N9010B	MY60240503	12/18/2023	12/17/2024
Signal Generator	KEYSIGHT	N5182B	MY61252553	09/23/2023	09/22/2024
Test Software	KEYSIGHT	N7607B Signal Stdio for DFS Radar profile	Ver. 3.2.0.0	N.C.R	N.C.R
DC Block	Mini-Circuits	BLK-18-S+	31129	12/12/2023	12/11/2024
Splitter	RF-LAMBDA	RFLT2W1G18G	11-JSPF412-017	12/12/2023	12/11/2024
Splitter	RF-LAMBDA	RFLT2W1G18G	11-JSPF412-018	12/12/2023	12/11/2024
Splitter	RF-LAMBDA	RFLT2W1G18G	11-JSPF412-020	12/12/2023	12/11/2024
Splitter	Titan	T0510E2W118Q	22015157	12/12/2023	12/11/2024
Manual Attenuator	Agilent	8496B + 8494B	MY42147434 + MY42152151	12/12/2023	12/11/2024

Unless otherwise stated the results shown in this test report refer only to the sample(s) tested and such sample(s) are retained for 90 days only.

除非另有說明，此報告結果僅對測試之樣品負責，同時此樣品僅保留90天。本報告未經本公司書面許可，不可部份複製。

This document is issued by the Company subject to its General Conditions of Service printed overleaf, available on request or accessible at <http://www.sgs.com.tw/Terms-and-Conditions> and for electronic format documents, subject to Terms and Conditions for Electronic Documents at <http://www.sgs.com.tw/Terms-and-Conditions>. Attention is drawn to the limitation of liability, indemnification and jurisdiction issues defined therein. Any holder of this document is advised that information contained hereon reflects the Company's findings at the time of its intervention only and within the limits of Client's instructions, if any. The Company's sole responsibility is to its Client and this document does not exonerate parties to a transaction from exercising all their rights and obligations under the transaction documents. This document cannot be reproduced except in full, without prior written approval of the Company. Any unauthorized alteration, forgery or falsification of the content or appearance of this document is unlawful and offenders may be prosecuted to the fullest extent of the law.

8 DESCRIPTION OF EUT:

EUT is a Master device with radar detection and DFS capability.

Timing plots are required with calculations demonstrating a minimum channel loading of approximately 17% or greater.

The rated output power of the master unit is ≥ 23 dBm(EIRP).therefore the required interference threshold level is -64dBm.after correction for antenna gain and procedural adjustments, the required conducted threshold at the antenna port is -64dBm.

The rated output power of the master unit is < 23 dBm(EIRP).therefore the required interference threshold level is -62dBm.after correction for antenna gain and procedural adjustments, the required threshold at the antenna port is -62dBm.

DFS Detection Threshold (dBm) = -64 + G (dBi), for conducted test.

DFS Detection Threshold (dBm)	Minimum of Peak Antenna Gain (dBi)	Threshold for test (dBm)
-64	2.77	-61.23

While calibrate the path on antenna port of DFS test equipment (master), measurements equipments (spectrum) is ensured to be 50 Ohms, and therefore verification on antenna gain measurement can be ignored.

The EUT uses one transmitter/receiver chains and one receive only chain, each connected to an antenna to perform radiated tests.

The Slave device associated with the EUT during these tests does not have radar detection capability.

Unless otherwise stated the results shown in this test report refer only to the sample(s) tested and such sample(s) are retained for 90 days only.
 除非另有說明，此報告結果僅對測試之樣品負責，同時此樣品僅保留90天。本報告未經本公司書面許可，不可部份複製。

This document is issued by the Company subject to its General Conditions of Service printed overleaf, available on request or accessible at <http://www.sgs.com.tw/Terms-and-Conditions>, and for electronic format documents, subject to Terms and Conditions for Electronic Documents at <http://www.sgs.com.tw/Terms-and-Conditions>. Attention is drawn to the limitation of liability, indemnification and jurisdiction issues defined therein. Any holder of this document is advised that information contained hereon reflects the Company's findings at the time of its intervention only and within the limits of Client's instructions, if any. The Company's sole responsibility is to its Client and this document does not exonerate parties to a transaction from exercising all their rights and obligations under the transaction documents. This document cannot be reproduced except in full, without prior written approval of the Company. Any unauthorized alteration, forgery or falsification of the content or appearance of this document is unlawful and offenders may be prosecuted to the fullest extent of the law.

9 RADAR TYPE WAVEFORM CALIBRATION AT DFS DETECTION THRESHOLD

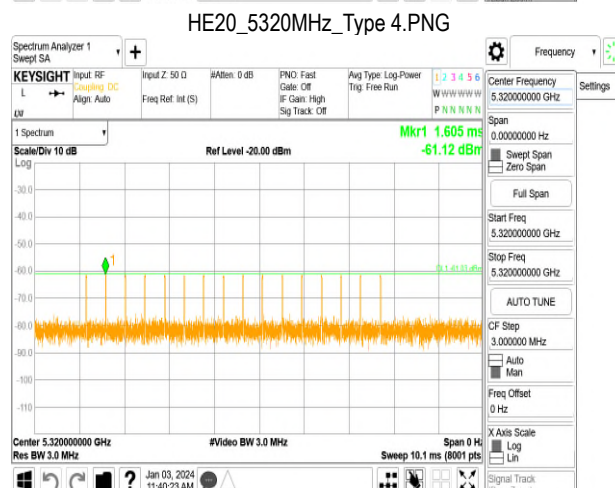
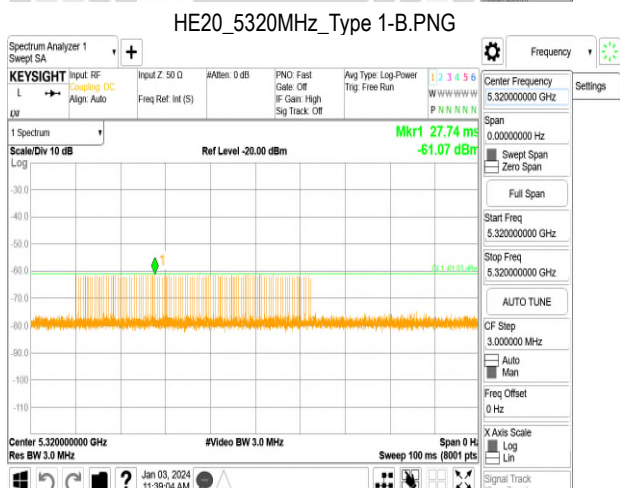
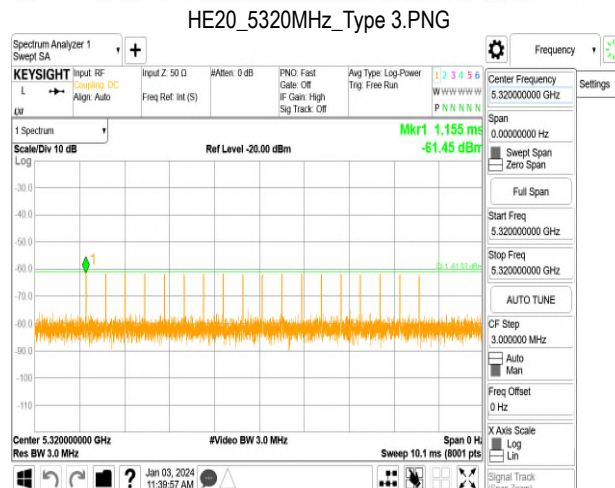
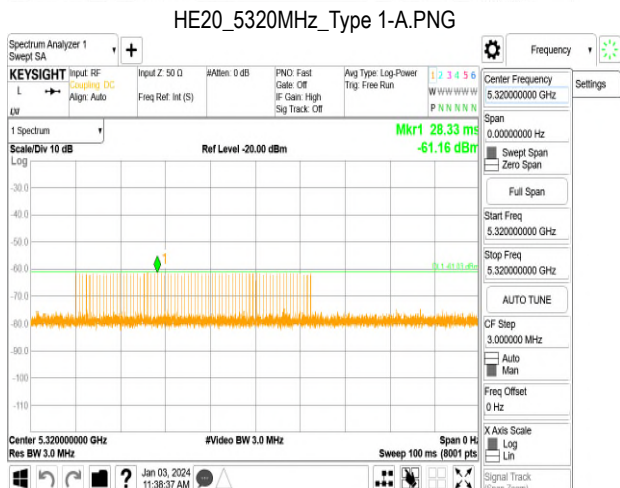
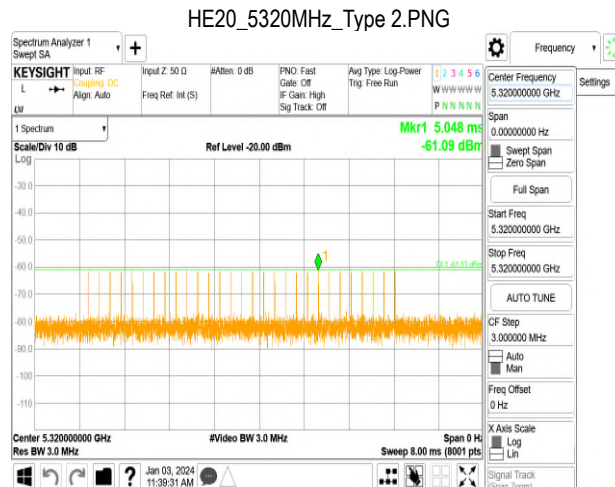
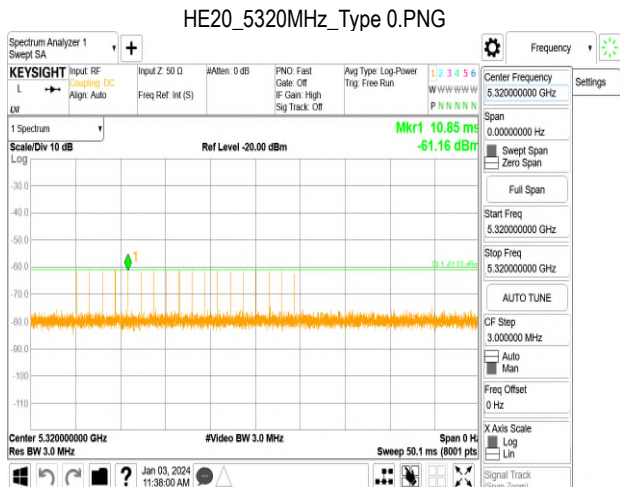

Unless otherwise stated the results shown in this test report refer only to the sample(s) tested and such sample(s) are retained for 90 days only.

除非另有說明，此報告結果僅對測試之樣品負責，同時此樣品僅保留90天。本報告未經本公司書面許可，不可部份複製。

This document is issued by the Company subject to its General Conditions of Service printed overleaf, available on request or accessible at <http://www.sgs.com.tw/Terms-and-Conditions> and for electronic format documents, subject to Terms and Conditions for Electronic Documents at <http://www.sgs.com.tw/Terms-and-Conditions>. Attention is drawn to the limitation of liability, indemnification and jurisdiction issues defined therein. Any holder of this document is advised that information contained hereon reflects the Company's findings at the time of its intervention only and within the limits of Client's instructions, if any. The Company's sole responsibility is to its Client and this document does not exonerate parties to a transaction from exercising all their rights and obligations under the transaction documents. This document cannot be reproduced except in full, without prior written approval of the Company. Any unauthorized alteration, forgery or falsification of the content or appearance of this document is unlawful and offenders may be prosecuted to the fullest extent of the law.

HE20_5320MHz_Type 5.PNG



HE20_5500MHz_Type 1-A.PNG

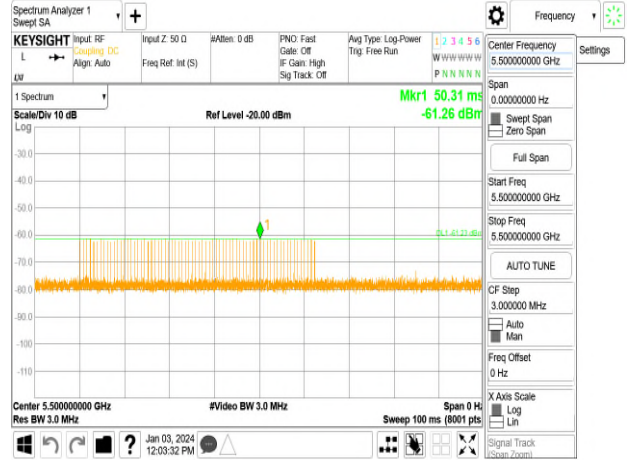

HE20_5320MHz_Type 6.PNG

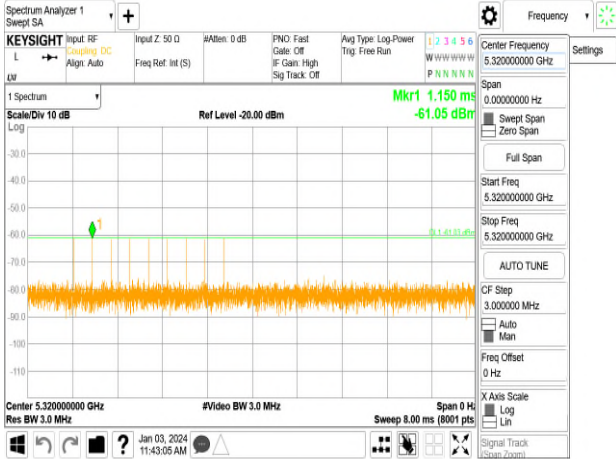

HE20_5500MHz_Type 1-B.PNG

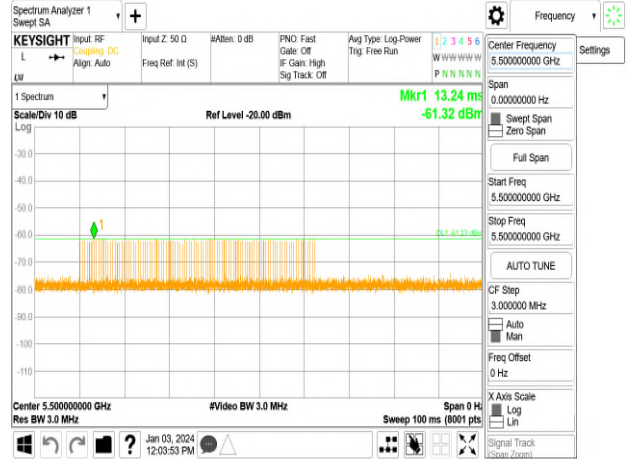

HE20_5500MHz_Type 0.PNG

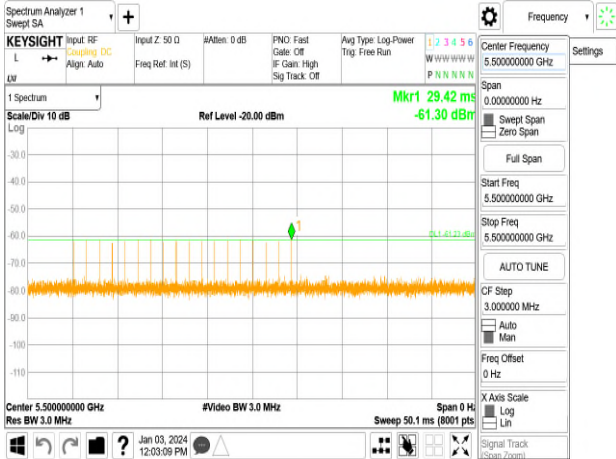

HE20_5500MHz_Type 2.PNG

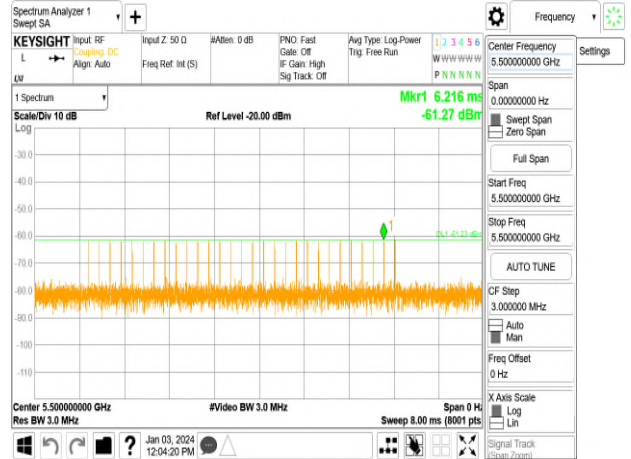

Unless otherwise stated the results shown in this test report refer only to the sample(s) tested and such sample(s) are retained for 90 days only.

除非另有說明，此報告結果僅對測試之樣品負責，同時此樣品僅保留90天。本報告未經本公司書面許可，不可部份複製。

This document is issued by the Company subject to its General Conditions of Service printed overleaf, available on request or accessible at <http://www.sgs.com.tw/Terms-and-Conditions>, and for electronic format documents, subject to Terms and Conditions for Electronic Documents at <http://www.sgs.com.tw/Terms-and-Conditions>. Attention is drawn to the limitation of liability, indemnification and jurisdiction issues defined therein. Any holder of this document is advised that information contained hereon reflects the Company's findings at the time of its intervention only and within the limits of Client's instructions, if any. The Company's sole responsibility is to its Client and this document does not exonerate parties to a transaction from exercising all their rights and obligations under the transaction documents. This document cannot be reproduced except in full, without prior written approval of the Company. Any unauthorized alteration, forgery or falsification of the content or appearance of this document is unlawful and offenders may be prosecuted to the fullest extent of the law.

HE20_5500MHz_Type 3.PNG

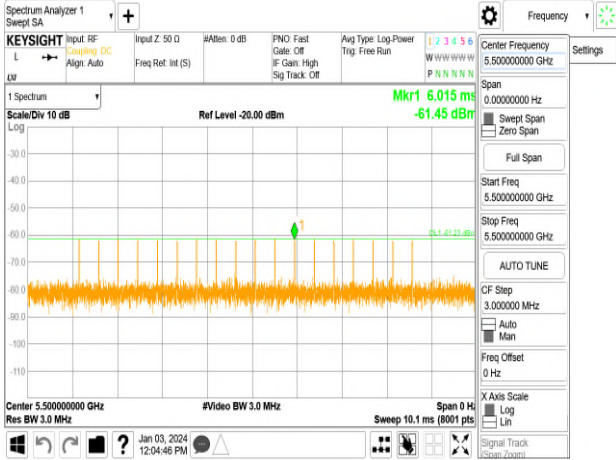

HE20_5500MHz_Type 6.PNG

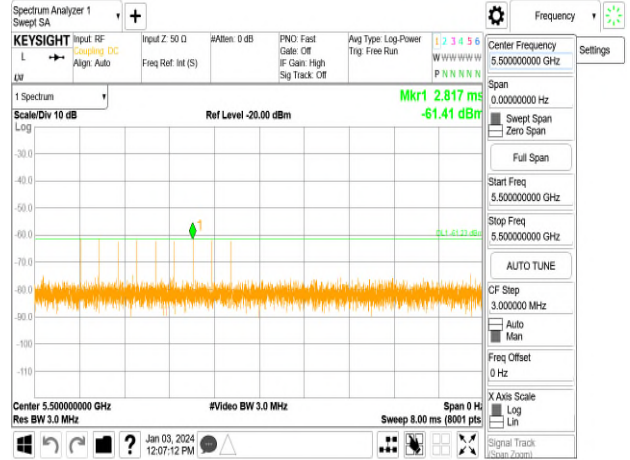

HE20_5500MHz_Type 4.PNG

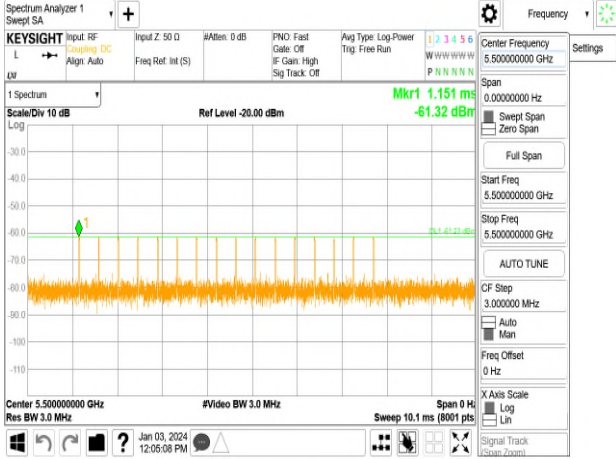

HE40_5310MHz_Type 0.PNG

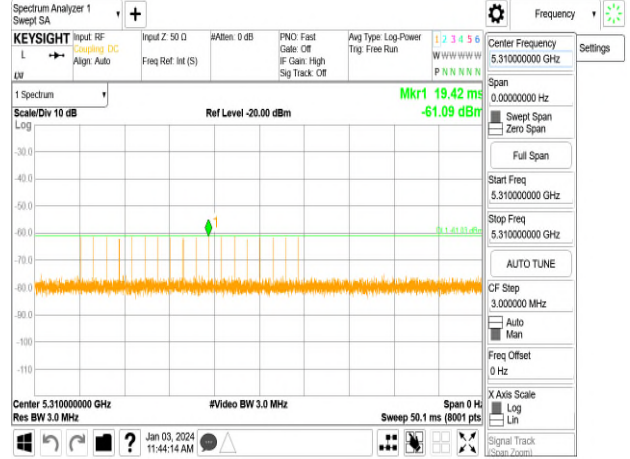

HE20_5500MHz_Type 5.PNG



HE40_5310MHz_Type 1-A.PNG

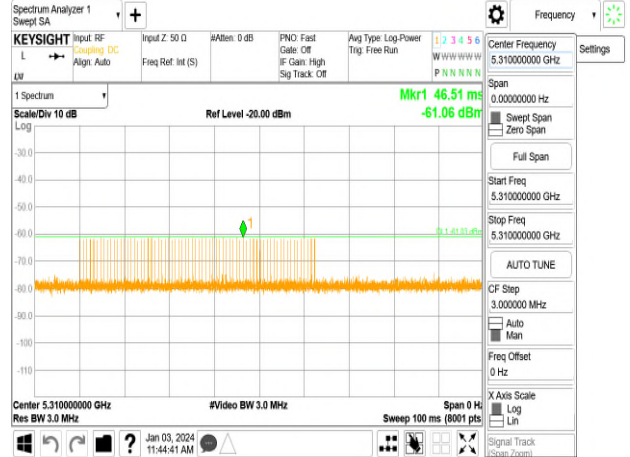

Unless otherwise stated the results shown in this test report refer only to the sample(s) tested and such sample(s) are retained for 90 days only.

除非另有說明，此報告結果僅對測試之樣品負責，同時此樣品僅保留90天。本報告未經本公司書面許可，不可部份複製。

This document is issued by the Company subject to its General Conditions of Service printed overleaf, available on request or accessible at <http://www.sgs.com.tw/Terms-and-Conditions>, and for electronic format documents, subject to Terms and Conditions for Electronic Documents at <http://www.sgs.com.tw/Terms-and-Conditions>. Attention is drawn to the limitation of liability, indemnification and jurisdiction issues defined therein. Any holder of this document is advised that information contained hereon reflects the Company's findings at the time of its intervention only and within the limits of Client's instructions, if any. The Company's sole responsibility is to its Client and this document does not exonerate parties to a transaction from exercising all their rights and obligations under the transaction documents. This document cannot be reproduced except in full, without prior written approval of the Company. Any unauthorized alteration, forgery or falsification of the content or appearance of this document is unlawful and offenders may be prosecuted to the fullest extent of the law.

HE40_5310MHz_Type 1-B.PNG

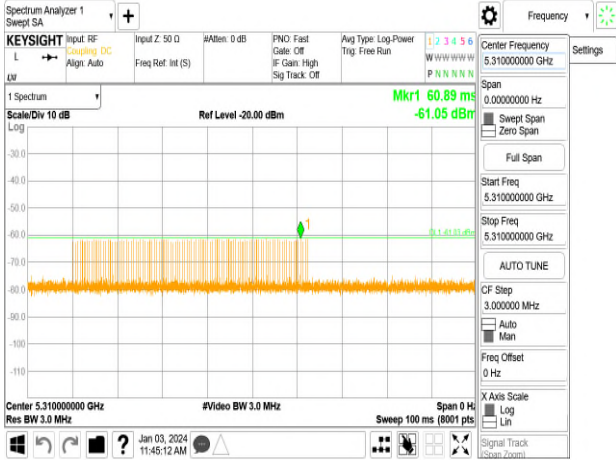

HE40_5310MHz_Type 4.PNG

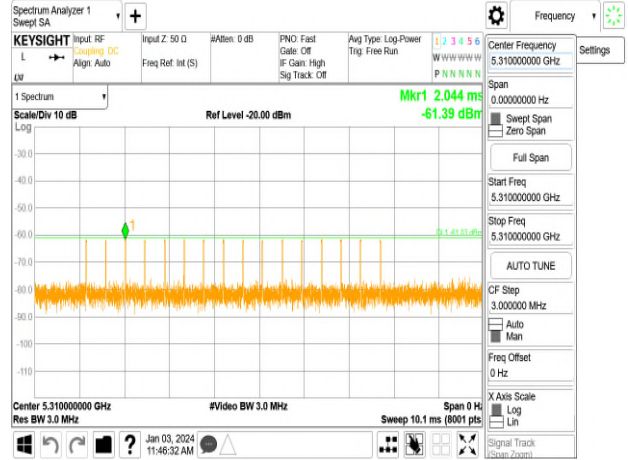

HE40_5310MHz_Type 2.PNG

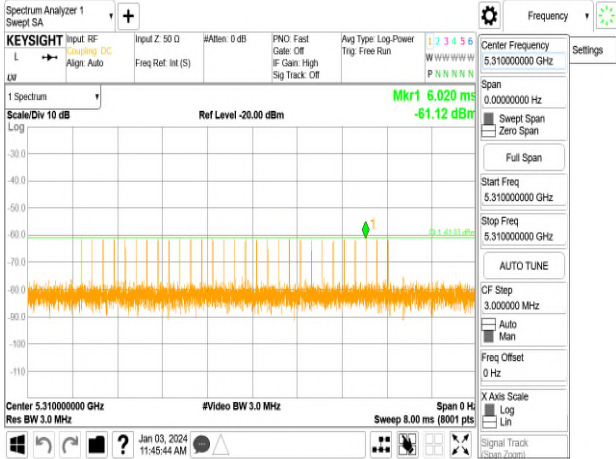

HE40_5310MHz_Type 5.PNG



HE40_5310MHz_Type 3.PNG

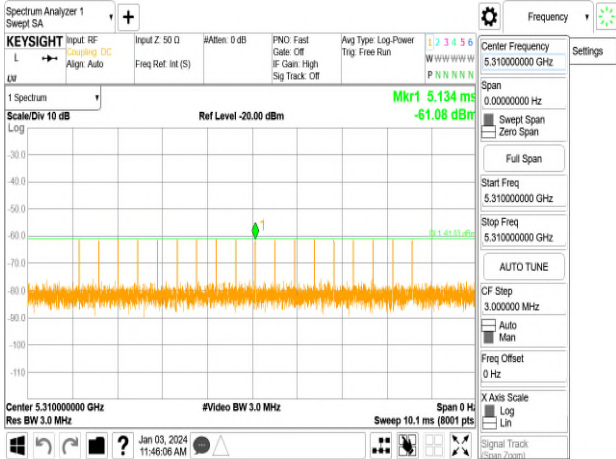

HE40_5310MHz_Type 6.PNG

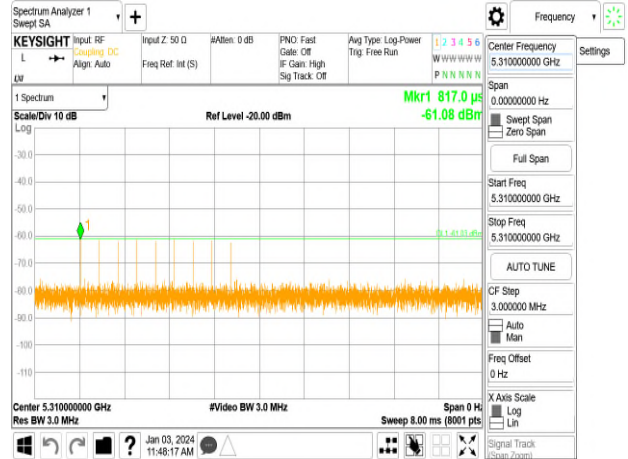

Unless otherwise stated the results shown in this test report refer only to the sample(s) tested and such sample(s) are retained for 90 days only.

除非另有說明，此報告結果僅對測試之樣品負責，同時此樣品僅保留90天。本報告未經本公司書面許可，不可部份複製。

This document is issued by the Company subject to its General Conditions of Service printed overleaf, available on request or accessible at <http://www.sgs.com.tw/Terms-and-Conditions>, and for electronic format documents, subject to Terms and Conditions for Electronic Documents at <http://www.sgs.com.tw/Terms-and-Conditions>. Attention is drawn to the limitation of liability, indemnification and jurisdiction issues defined therein. Any holder of this document is advised that information contained hereon reflects the Company's findings at the time of its intervention only and within the limits of Client's instructions, if any. The Company's sole responsibility is to its Client and this document does not exonerate parties to a transaction from exercising all their rights and obligations under the transaction documents. This document cannot be reproduced except in full, without prior written approval of the Company. Any unauthorized alteration, forgery or falsification of the content or appearance of this document is unlawful and offenders may be prosecuted to the fullest extent of the law.

HE40_5510MHz_Type 0.PNG

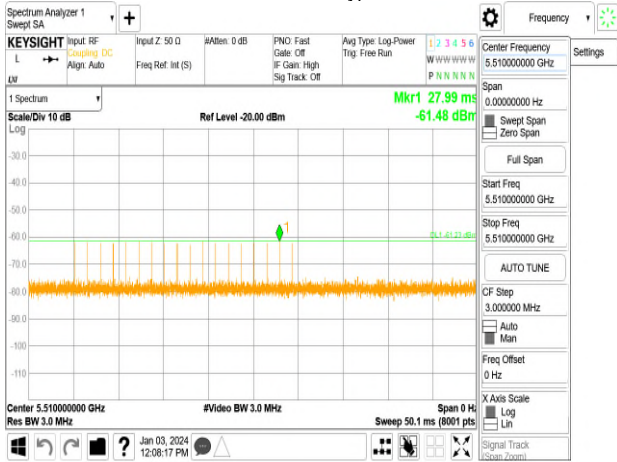

HE40_5510MHz_Type 2.PNG

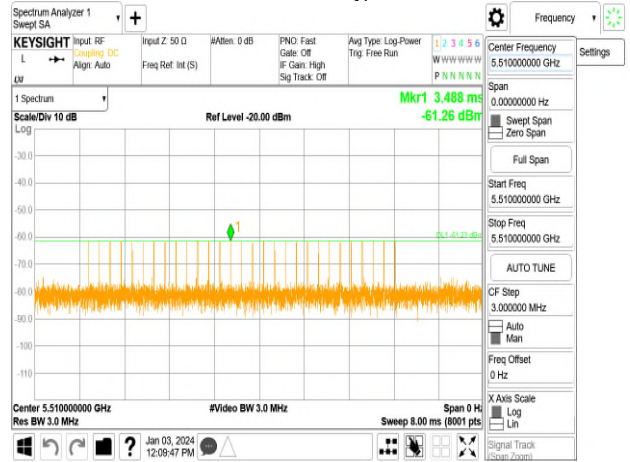

HE40_5510MHz_Type 1-A.PNG

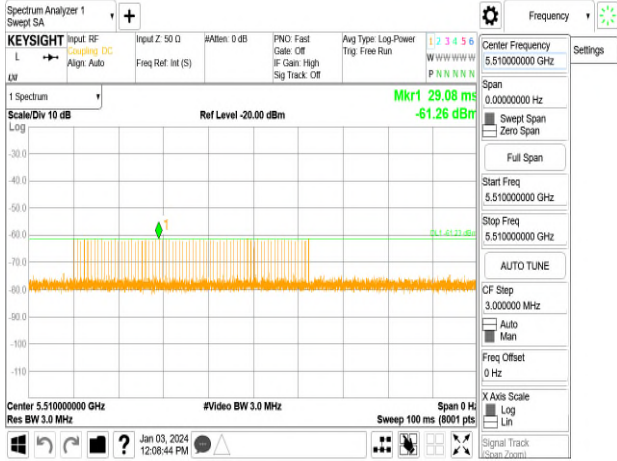

HE40_5510MHz_Type 3.PNG

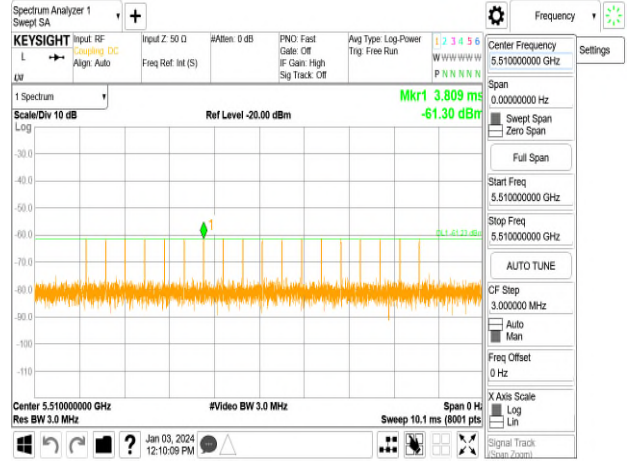

HE40_5510MHz_Type 1-B.PNG

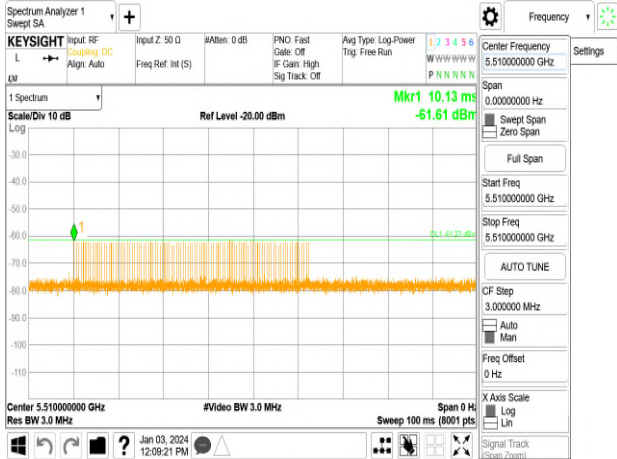

HE40_5510MHz_Type 4.PNG

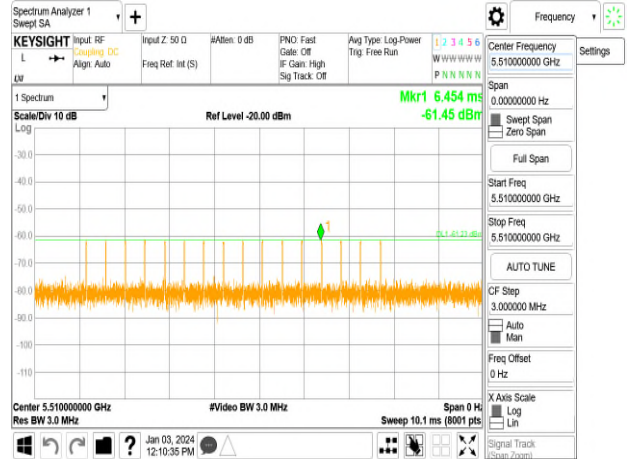

Unless otherwise stated the results shown in this test report refer only to the sample(s) tested and such sample(s) are retained for 90 days only.

除非另有說明，此報告結果僅對測試之樣品負責，同時此樣品僅保留90天。本報告未經本公司書面許可，不可部份複製。

This document is issued by the Company subject to its General Conditions of Service printed overleaf, available on request or accessible at <http://www.sgs.com.tw/Terms-and-Conditions>, and for electronic format documents, subject to Terms and Conditions for Electronic Documents at <http://www.sgs.com.tw/Terms-and-Conditions>. Attention is drawn to the limitation of liability, indemnification and jurisdiction issues defined therein. Any holder of this document is advised that information contained hereon reflects the Company's findings at the time of its intervention only and within the limits of Client's instructions, if any. The Company's sole responsibility is to its Client and this document does not exonerate parties to a transaction from exercising all their rights and obligations under the transaction documents. This document cannot be reproduced except in full, without prior written approval of the Company. Any unauthorized alteration, forgery or falsification of the content or appearance of this document is unlawful and offenders may be prosecuted to the fullest extent of the law.

HE40_5510MHz_Type 5.PNG



HE80_5290MHz_Type 1-A.PNG

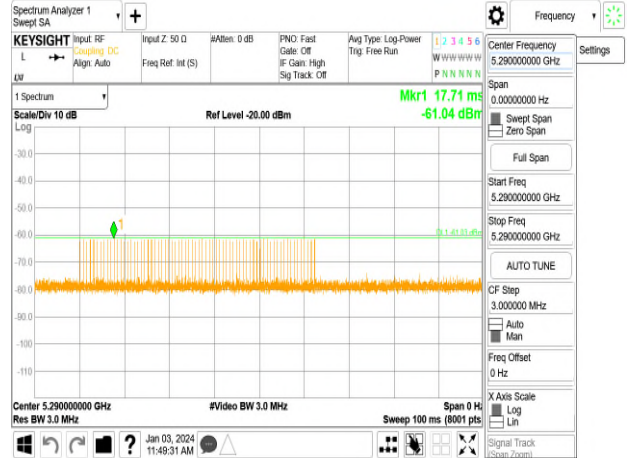

HE40_5510MHz_Type 6.PNG

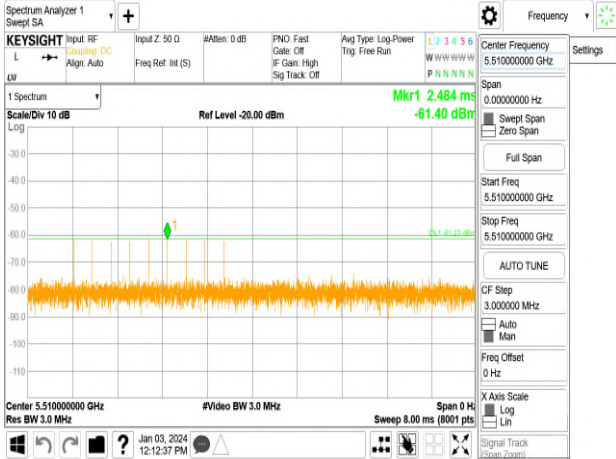

HE80_5290MHz_Type 1-B.PNG

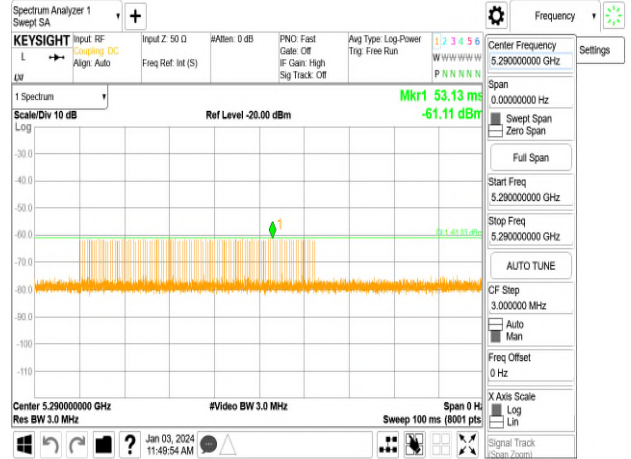

HE80_5290MHz_Type 0.PNG

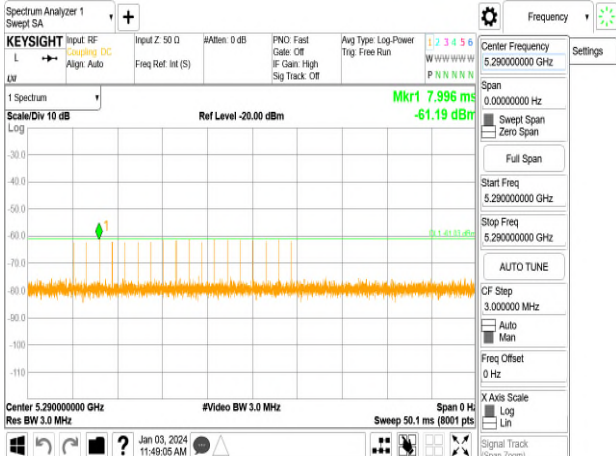

HE80_5290MHz_Type 2.PNG

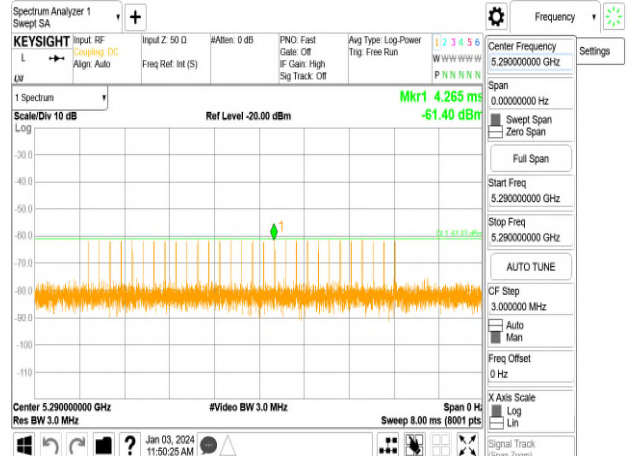

Unless otherwise stated the results shown in this test report refer only to the sample(s) tested and such sample(s) are retained for 90 days only.

除非另有說明，此報告結果僅對測試之樣品負責，同時此樣品僅保留90天。本報告未經本公司書面許可，不可部份複製。

This document is issued by the Company subject to its General Conditions of Service printed overleaf, available on request or accessible at <http://www.sgs.com.tw/Terms-and-Conditions>, and for electronic format documents, subject to Terms and Conditions for Electronic Documents at <http://www.sgs.com.tw/Terms-and-Conditions>. Attention is drawn to the limitation of liability, indemnification and jurisdiction issues defined therein. Any holder of this document is advised that information contained hereon reflects the Company's findings at the time of its intervention only and within the limits of Client's instructions, if any. The Company's sole responsibility is to its Client and this document does not exonerate parties to a transaction from exercising all their rights and obligations under the transaction documents. This document cannot be reproduced except in full, without prior written approval of the Company. Any unauthorized alteration, forgery or falsification of the content or appearance of this document is unlawful and offenders may be prosecuted to the fullest extent of the law.

HE80_5290MHz_Type 3.PNG

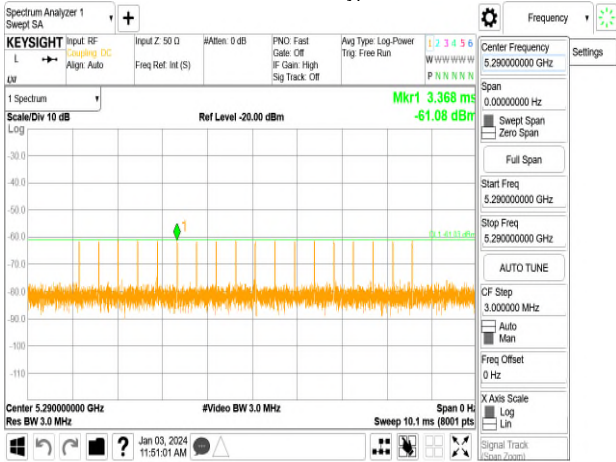

HE80_5290MHz_Type 6.PNG

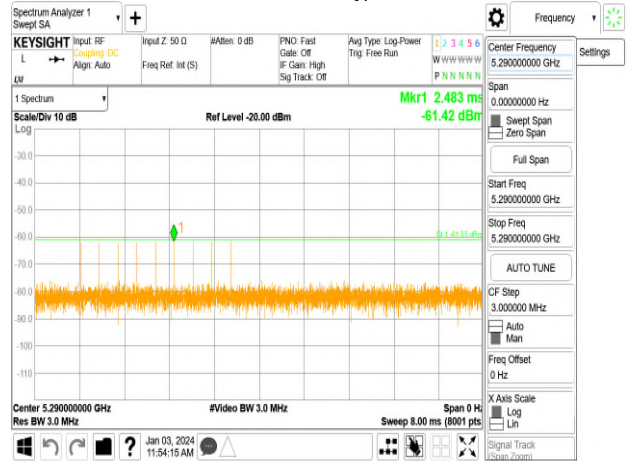

HE80_5290MHz_Type 4.PNG

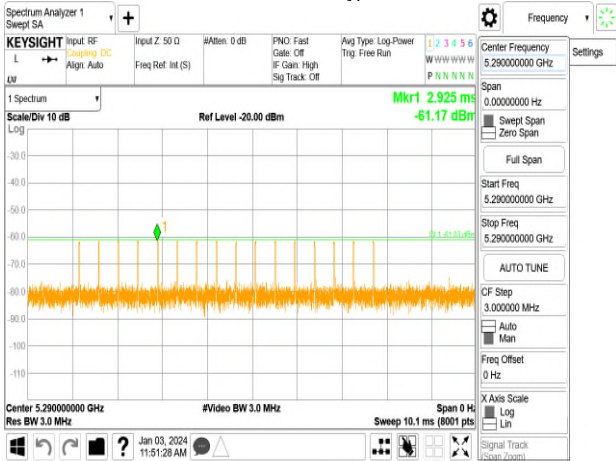

HE80_5530MHz_Type 0.PNG

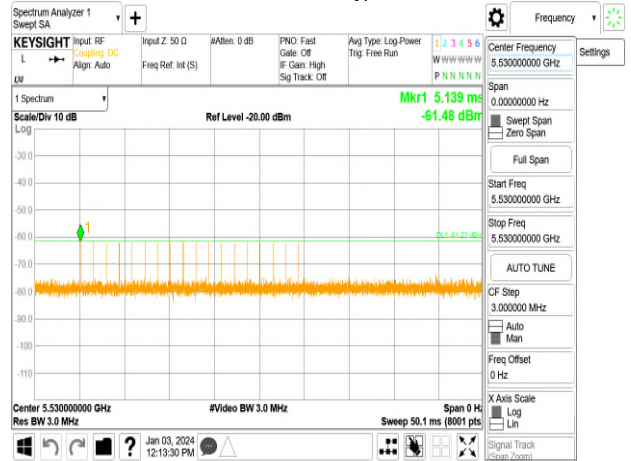

HE80_5290MHz_Type 5.PNG



HE80_5530MHz_Type 1-A.PNG

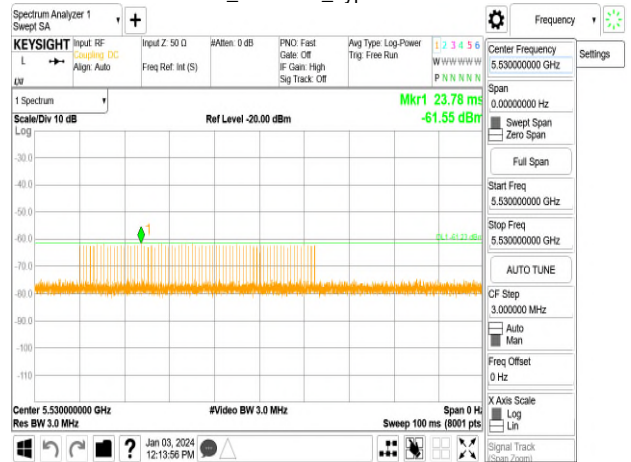

Unless otherwise stated the results shown in this test report refer only to the sample(s) tested and such sample(s) are retained for 90 days only.

除非另有說明，此報告結果僅對測試之樣品負責，同時此樣品僅保留90天。本報告未經本公司書面許可，不可部份複製。

This document is issued by the Company subject to its General Conditions of Service printed overleaf, available on request or accessible at <http://www.sgs.com.tw/Terms-and-Conditions>, and for electronic format documents, subject to Terms and Conditions for Electronic Documents at <http://www.sgs.com.tw/Terms-and-Conditions>. Attention is drawn to the limitation of liability, indemnification and jurisdiction issues defined therein. Any holder of this document is advised that information contained hereon reflects the Company's findings at the time of its intervention only and within the limits of Client's instructions, if any. The Company's sole responsibility is to its Client and this document does not exonerate parties to a transaction from exercising all their rights and obligations under the transaction documents. This document cannot be reproduced except in full, without prior written approval of the Company. Any unauthorized alteration, forgery or falsification of the content or appearance of this document is unlawful and offenders may be prosecuted to the fullest extent of the law.

HE80_5530MHz_Type 1-B.PNG

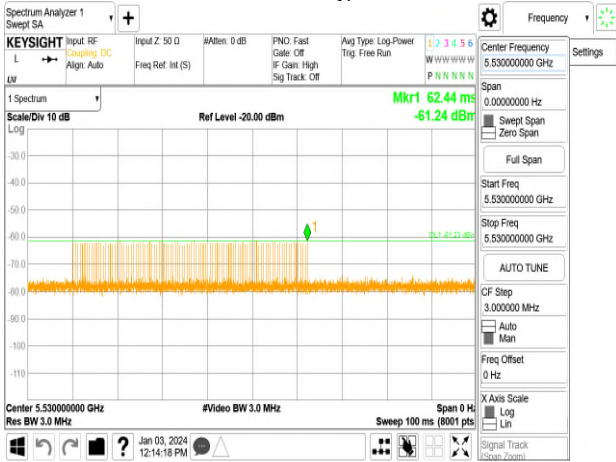

HE80_5530MHz_Type 4.PNG

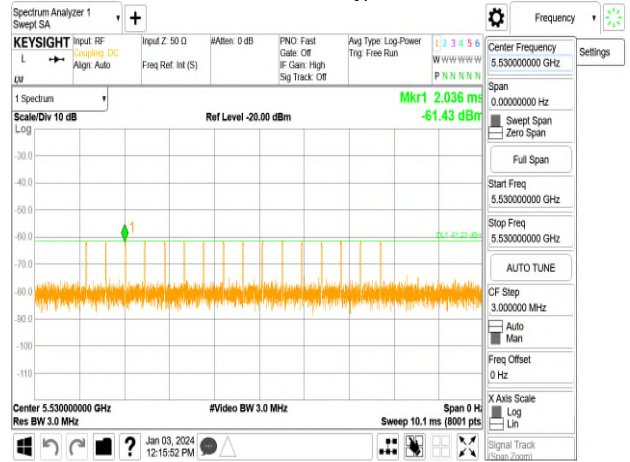

HE80_5530MHz_Type 2.PNG

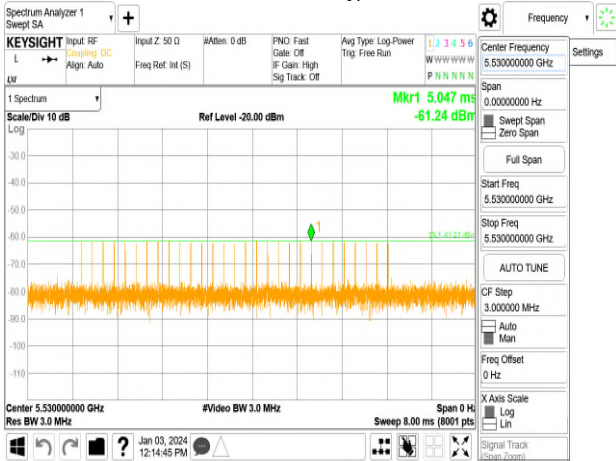

HE80_5530MHz_Type 5.PNG



HE80_5530MHz_Type 3.PNG

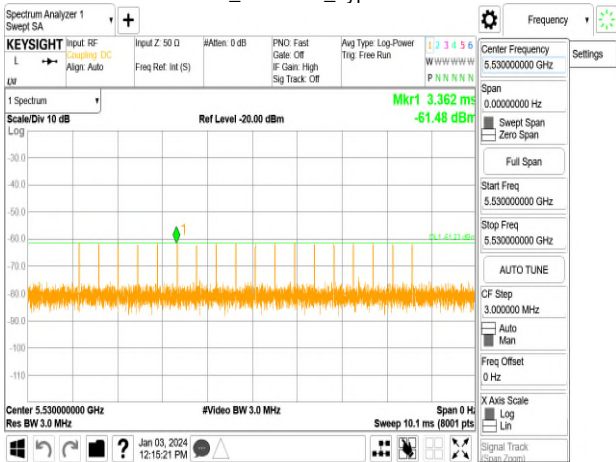

HE80_5530MHz_Type 6.PNG

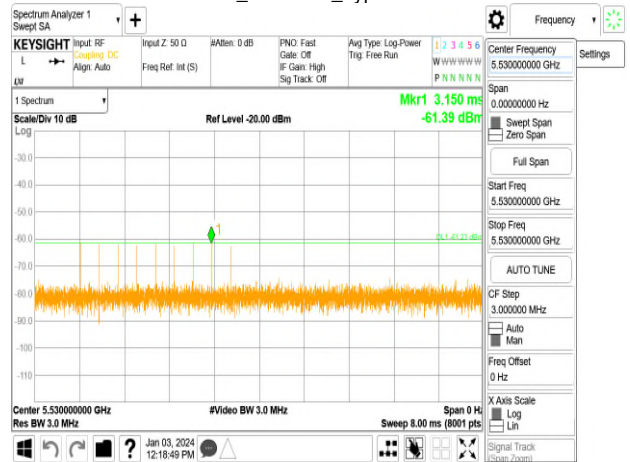

Unless otherwise stated the results shown in this test report refer only to the sample(s) tested and such sample(s) are retained for 90 days only.

除非另有說明，此報告結果僅對測試之樣品負責，同時此樣品僅保留90天。本報告未經本公司書面許可，不可部份複製。

This document is issued by the Company subject to its General Conditions of Service printed overleaf, available on request or accessible at <http://www.sgs.com.tw/Terms-and-Conditions>, and for electronic format documents, subject to Terms and Conditions for Electronic Documents at <http://www.sgs.com.tw/Terms-and-Conditions>. Attention is drawn to the limitation of liability, indemnification and jurisdiction issues defined therein. Any holder of this document is advised that information contained hereon reflects the Company's findings at the time of its intervention only and within the limits of Client's instructions, if any. The Company's sole responsibility is to its Client and this document does not exonerate parties to a transaction from exercising all their rights and obligations under the transaction documents. This document cannot be reproduced except in full, without prior written approval of the Company. Any unauthorized alteration, forgery or falsification of the content or appearance of this document is unlawful and offenders may be prosecuted to the fullest extent of the law.

HE160_5250MHz_Type 0.PNG

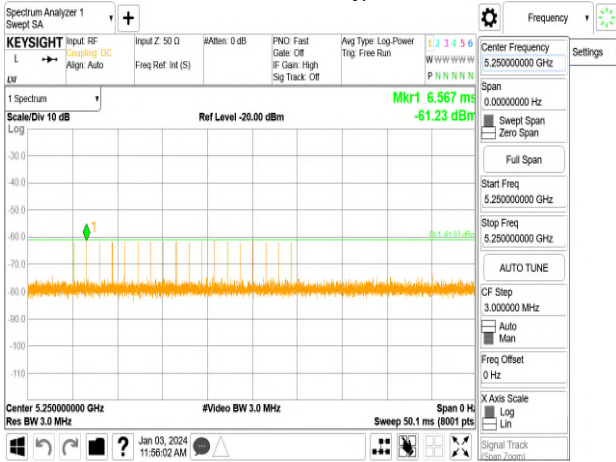

HE160_5250MHz_Type 2.PNG

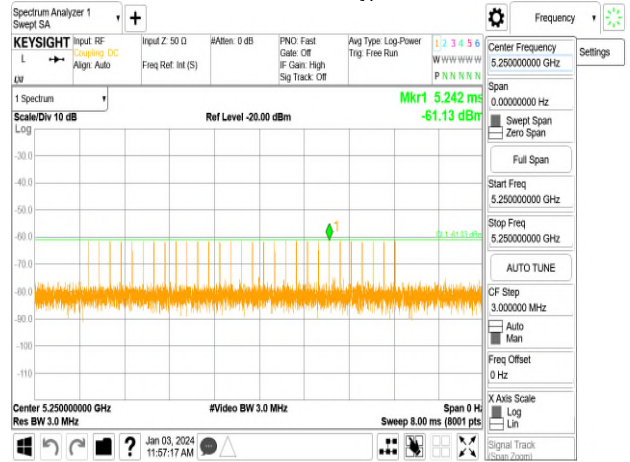

HE160_5250MHz_Type 1-A.PNG

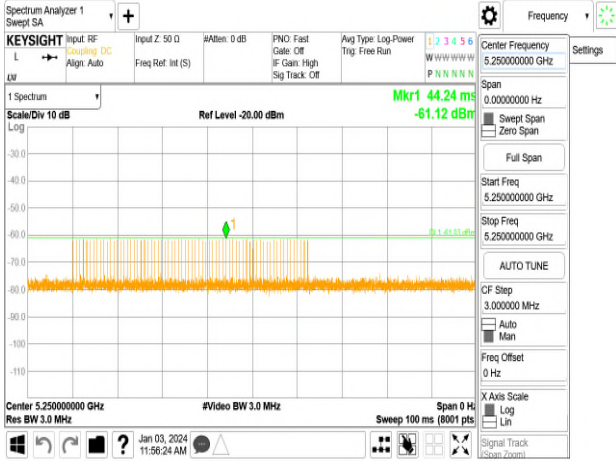

HE160_5250MHz_Type 3.PNG

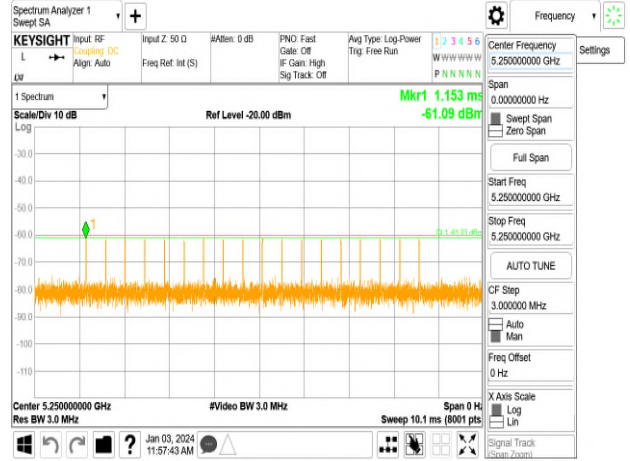

HE160_5250MHz_Type 1-B.PNG

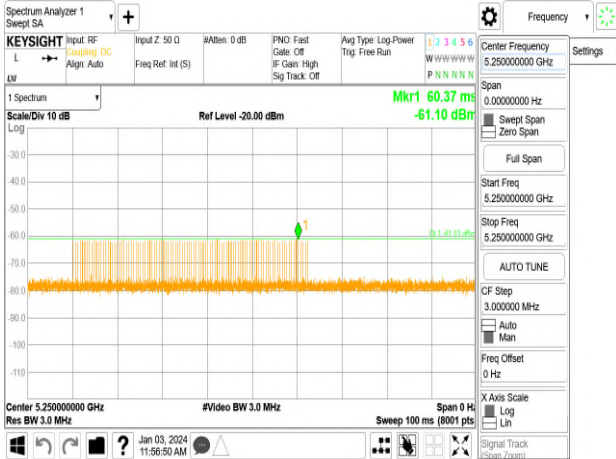

HE160_5250MHz_Type 4.PNG

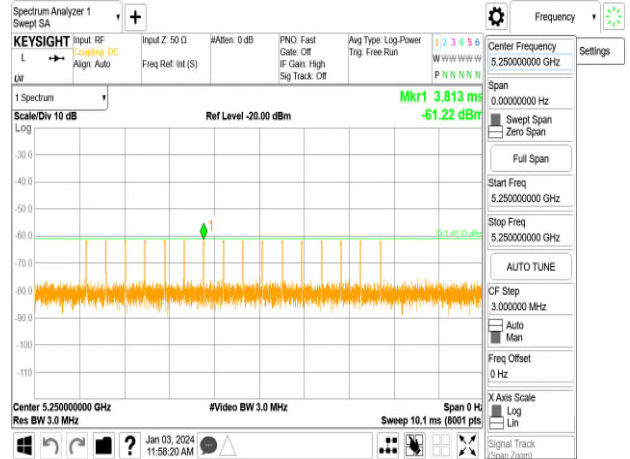

Unless otherwise stated the results shown in this test report refer only to the sample(s) tested and such sample(s) are retained for 90 days only.

除非另有說明，此報告結果僅對測試之樣品負責，同時此樣品僅保留90天。本報告未經本公司書面許可，不可部份複製。

This document is issued by the Company subject to its General Conditions of Service printed overleaf, available on request or accessible at <http://www.sgs.com.tw/Terms-and-Conditions>, and for electronic format documents, subject to Terms and Conditions for Electronic Documents at <http://www.sgs.com.tw/Terms-and-Conditions>. Attention is drawn to the limitation of liability, indemnification and jurisdiction issues defined therein. Any holder of this document is advised that information contained hereon reflects the Company's findings at the time of its intervention only and within the limits of Client's instructions, if any. The Company's sole responsibility is to its Client and this document does not exonerate parties to a transaction from exercising all their rights and obligations under the transaction documents. This document cannot be reproduced except in full, without prior written approval of the Company. Any unauthorized alteration, forgery or falsification of the content or appearance of this document is unlawful and offenders may be prosecuted to the fullest extent of the law.

HE160_5250MHz_Type 5.PNG



HE160_5570MHz_Type 1-A.PNG

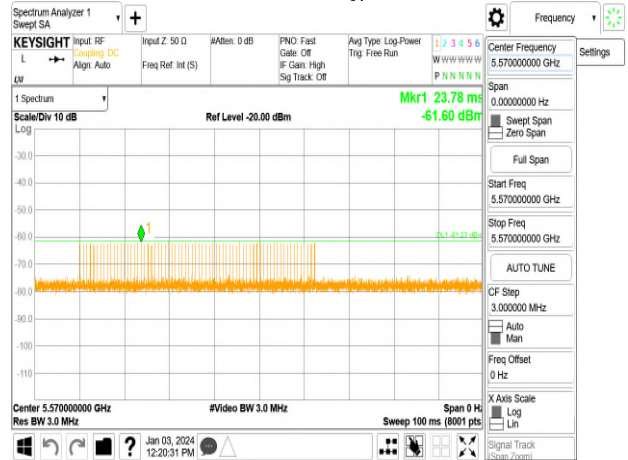

HE160_5250MHz_Type 6.PNG

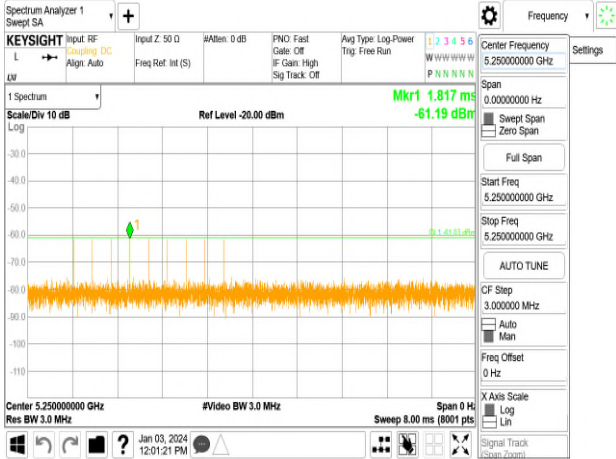

HE160_5570MHz_Type 1-B.PNG

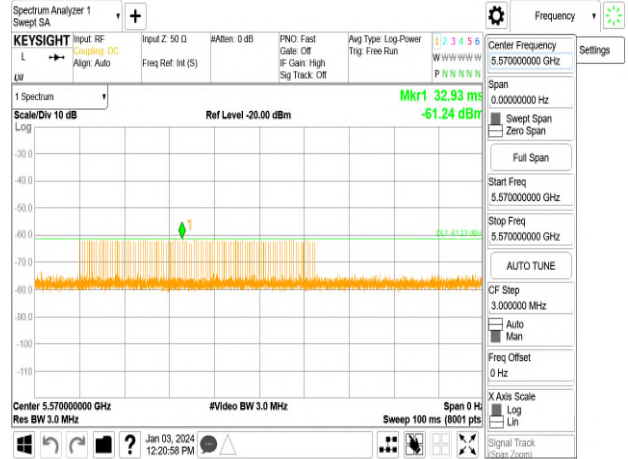

HE160_5570MHz_Type 0.PNG

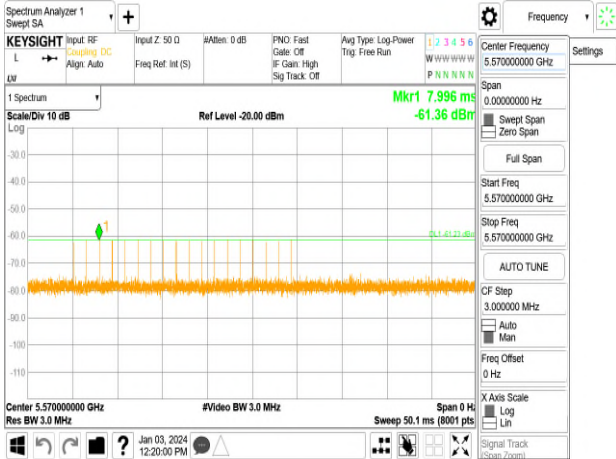

HE160_5570MHz_Type 2.PNG

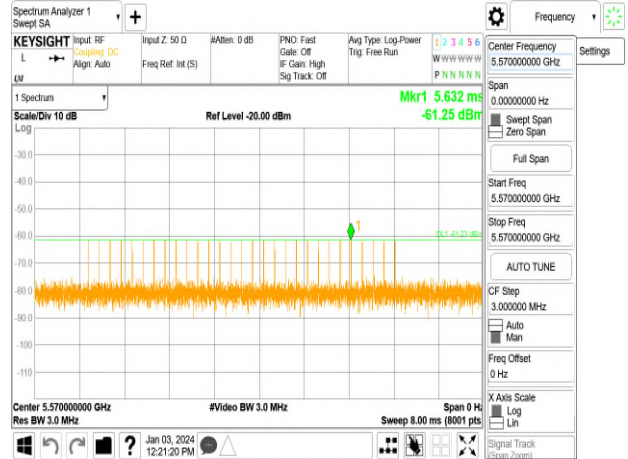

Unless otherwise stated the results shown in this test report refer only to the sample(s) tested and such sample(s) are retained for 90 days only.

除非另有說明，此報告結果僅對測試之樣品負責，同時此樣品僅保留90天。本報告未經本公司書面許可，不可部份複製。

This document is issued by the Company subject to its General Conditions of Service printed overleaf, available on request or accessible at <http://www.sgs.com.tw/Terms-and-Conditions>, and for electronic format documents, subject to Terms and Conditions for Electronic Documents at <http://www.sgs.com.tw/Terms-and-Conditions>. Attention is drawn to the limitation of liability, indemnification and jurisdiction issues defined therein. Any holder of this document is advised that information contained hereon reflects the Company's findings at the time of its intervention only and within the limits of Client's instructions, if any. The Company's sole responsibility is to its Client and this document does not exonerate parties to a transaction from exercising all their rights and obligations under the transaction documents. This document cannot be reproduced except in full, without prior written approval of the Company. Any unauthorized alteration, forgery or falsification of the content or appearance of this document is unlawful and offenders may be prosecuted to the fullest extent of the law.

HE160_5570MHz_Type 3.PNG

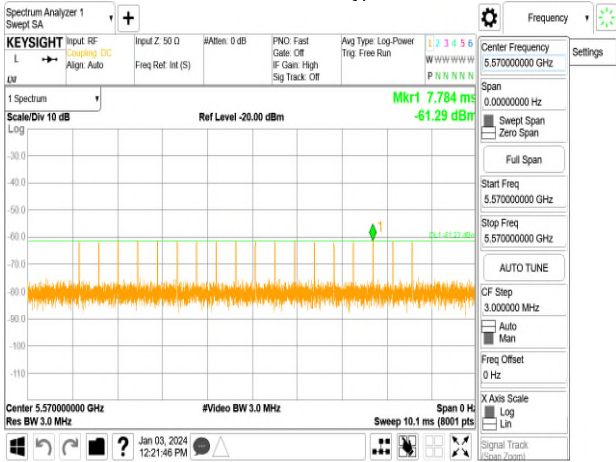

HE160_5570MHz_Type 6.PNG

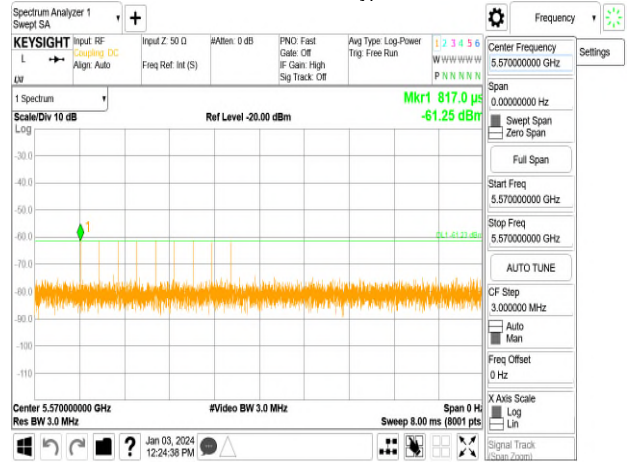

HE160_5570MHz_Type 4.PNG

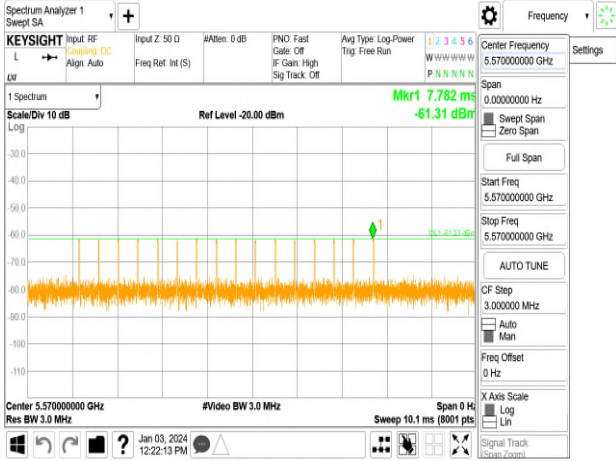

HE160_5570MHz_Type 5.PNG



Unless otherwise stated the results shown in this test report refer only to the sample(s) tested and such sample(s) are retained for 90 days only.

除非另有說明，此報告結果僅對測試之樣品負責，同時此樣品僅保留90天。本報告未經本公司書面許可，不可部份複製。

This document is issued by the Company subject to its General Conditions of Service printed overleaf, available on request or accessible at <http://www.sgs.com.tw/Terms-and-Conditions>, and for electronic format documents, subject to Terms and Conditions for Electronic Documents at <http://www.sgs.com.tw/Terms-and-Conditions>. Attention is drawn to the limitation of liability, indemnification and jurisdiction issues defined therein. Any holder of this document is advised that information contained hereon reflects the Company's findings at the time of its intervention only and within the limits of Client's instructions, if any. The Company's sole responsibility is to its Client and this document does not exonerate parties to a transaction from exercising all their rights and obligations under the transaction documents. This document cannot be reproduced except in full, without prior written approval of the Company. Any unauthorized alteration, forgery or falsification of the content or appearance of this document is unlawful and offenders may be prosecuted to the fullest extent of the law.

10 CHANNEL CLOSING TRANSMISSION AND CHANNEL MOVE TIME MEASUREMENT (RADAR TYPE 0)

Channel Shutdown Result				
Detection Threshold Level (dBm)			-61.23	
Modulation Mode	Freq. (MHz)	Radar Test Signal	Channel Closing Transmission Time(ms) 200ms~10sec	Channel Move Time(s)
HE160	5250	Type 0	0	0.042
HE160	5570	Type 0	2	0.208
Limit			60	ms
Result			Complied	

Unless otherwise stated the results shown in this test report refer only to the sample(s) tested and such sample(s) are retained for 90 days only.

除非另有說明，此報告結果僅對測試之樣品負責，同時此樣品僅保留90天。本報告未經本公司書面許可，不可部份複製。

This document is issued by the Company subject to its General Conditions of Service printed overleaf, available on request or accessible at <http://www.sgs.com.tw/Terms-and-Conditions> and for electronic format documents, subject to Terms and Conditions for Electronic Documents at <http://www.sgs.com.tw/Terms-and-Conditions>. Attention is drawn to the limitation of liability, indemnification and jurisdiction issues defined therein. Any holder of this document is advised that information contained hereon reflects the Company's findings at the time of its intervention only and within the limits of Client's instructions, if any. The Company's sole responsibility is to its Client and this document does not exonerate parties to a transaction from exercising all their rights and obligations under the transaction documents. This document cannot be reproduced except in full, without prior written approval of the Company. Any unauthorized alteration, forgery or falsification of the content or appearance of this document is unlawful and offenders may be prosecuted to the fullest extent of the law.

HE160_5250MHz_Channel Close Time

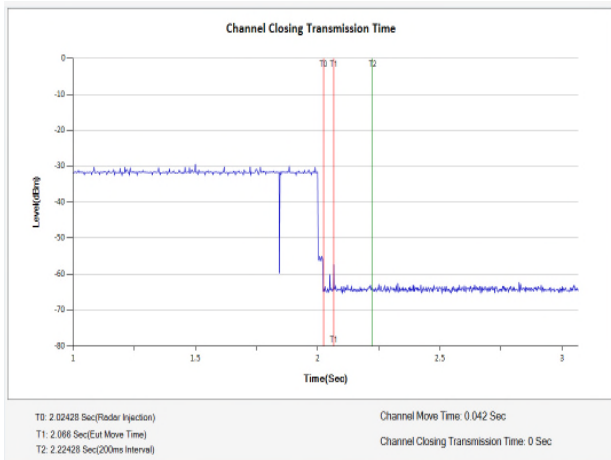

HE160_5570MHz_Channel Move Time

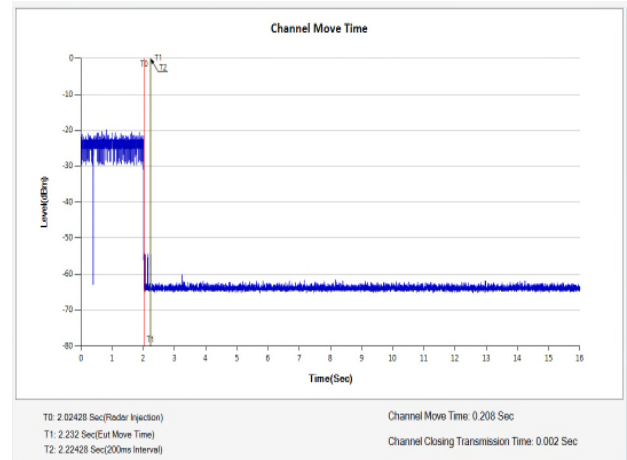

HE160_5250MHz_Channel Move Time

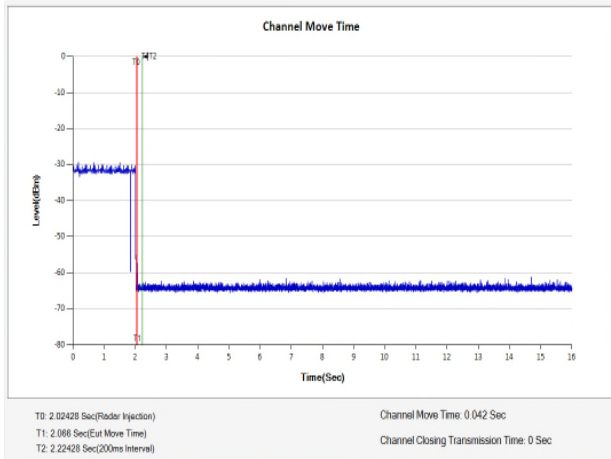

HE160_5570MHz_Channel Close Time

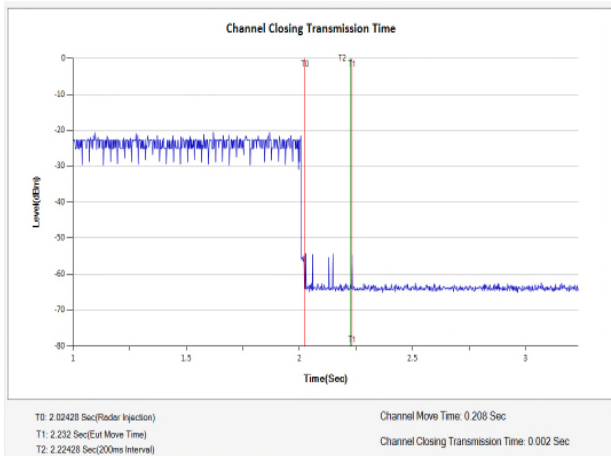

Unless otherwise stated the results shown in this test report refer only to the sample(s) tested and such sample(s) are retained for 90 days only.

除非另有說明，此報告結果僅對測試之樣品負責，同時此樣品僅保留90天。本報告未經本公司書面許可，不可部份複製。

This document is issued by the Company subject to its General Conditions of Service printed overleaf, available on request or accessible at <http://www.sgs.com.tw/Terms-and-Conditions> and for electronic format documents, subject to Terms and Conditions for Electronic Documents at <http://www.sgs.com.tw/Terms-and-Conditions>. Attention is drawn to the limitation of liability, indemnification and jurisdiction issues defined therein. Any holder of this document is advised that information contained hereon reflects the Company's findings at the time of its intervention only and within the limits of Client's instructions, if any. The Company's sole responsibility is to its Client and this document does not exonerate parties to a transaction from exercising all their rights and obligations under the transaction documents. This document cannot be reproduced except in full, without prior written approval of the Company. Any unauthorized alteration, forgery or falsification of the content or appearance of this document is unlawful and offenders may be prosecuted to the fullest extent of the law.

11 DUTY CYCLE

HE20_5320MHz_Duty Cycle

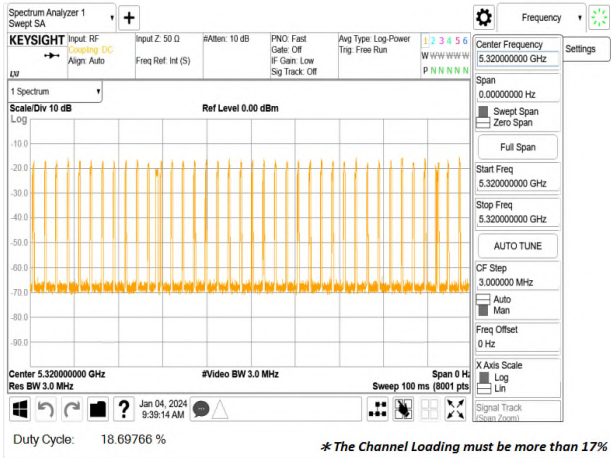

HE40_5510MHz_Duty Cycle



HE20_5500MHz_Duty Cycle



HE80_5290MHz_Duty Cycle

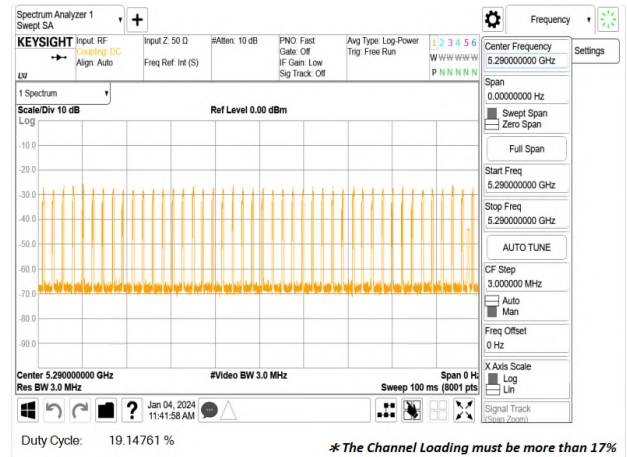

HE40_5310MHz_Duty Cycle



HE80_5530MHz_Duty Cycle



Unless otherwise stated the results shown in this test report refer only to the sample(s) tested and such sample(s) are retained for 90 days only.

除非另有說明，此報告結果僅對測試之樣品負責，同時此樣品僅保留90天。本報告未經本公司書面許可，不可部份複製。

This document is issued by the Company subject to its General Conditions of Service printed overleaf, available on request or accessible at <http://www.sgs.com.tw/Terms-and-Conditions> and for electronic format documents, subject to Terms and Conditions for Electronic Documents at <http://www.sgs.com.tw/Terms-and-Conditions>. Attention is drawn to the limitation of liability, indemnification and jurisdiction issues defined therein. Any holder of this document is advised that information contained hereon reflects the Company's findings at the time of its intervention only and within the limits of Client's instructions, if any. The Company's sole responsibility is to its Client and this document does not exonerate parties to a transaction from exercising all their rights and obligations under the transaction documents. This document cannot be reproduced except in full, without prior written approval of the Company. Any unauthorized alteration, forgery or falsification of the content or appearance of this document is unlawful and offenders may be prosecuted to the fullest extent of the law.

HE160_5250MHz_Duty Cycle

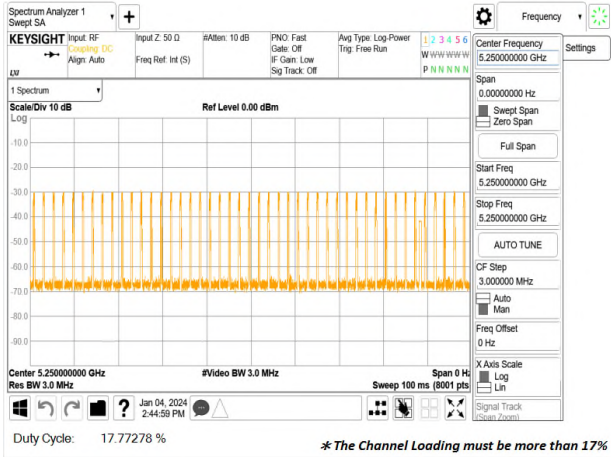

HE160_5570MHz_Duty Cycle

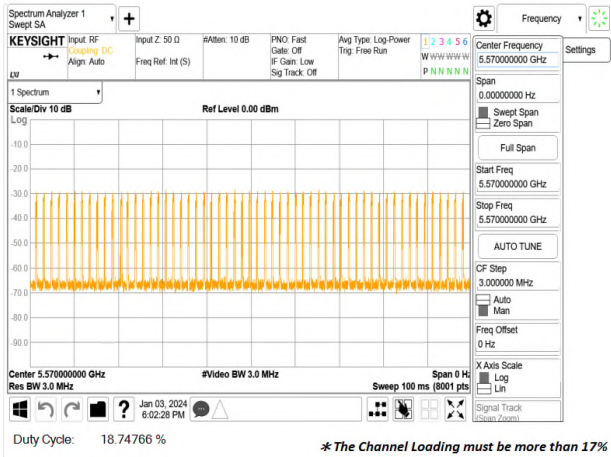

Unless otherwise stated the results shown in this test report refer only to the sample(s) tested and such sample(s) are retained for 90 days only.

除非另有說明，此報告結果僅對測試之樣品負責，同時此樣品僅保留90天。本報告未經本公司書面許可，不可部份複製。

This document is issued by the Company subject to its General Conditions of Service printed overleaf, available on request or accessible at <http://www.sgs.com.tw/Terms-and-Conditions>, and for electronic format documents, subject to Terms and Conditions for Electronic Documents at <http://www.sgs.com.tw/Terms-and-Conditions>. Attention is drawn to the limitation of liability, indemnification and jurisdiction issues defined therein. Any holder of this document is advised that information contained hereon reflects the Company's findings at the time of its intervention only and within the limits of Client's instructions, if any. The Company's sole responsibility is to its Client and this document does not exonerate parties to a transaction from exercising all their rights and obligations under the transaction documents. This document cannot be reproduced except in full, without prior written approval of the Company. Any unauthorized alteration, forgery or falsification of the content or appearance of this document is unlawful and offenders may be prosecuted to the fullest extent of the law.

12 NON-OCCUPANCY PERIOD MEASUREMENT

To verify whether channel is unavailable to be operated in 30 minutes.
 $1.8\text{ks} = 1800\text{s} = 1800\text{ s/min} / 60 = 30\text{minute}$

HE160_5250MHz



HE160_5570MHz

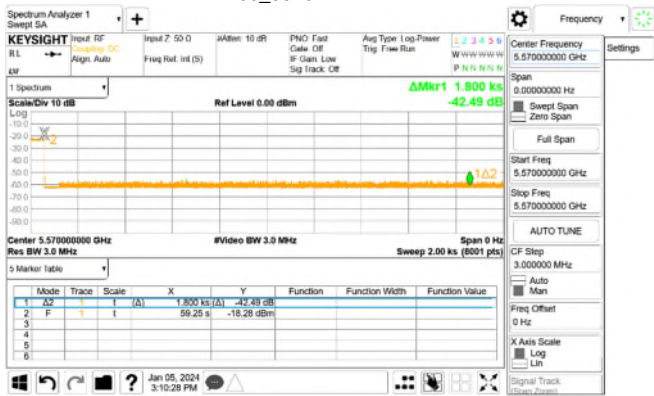

Unless otherwise stated the results shown in this test report refer only to the sample(s) tested and such sample(s) are retained for 90 days only.

除非另有說明，此報告結果僅對測試之樣品負責，同時此樣品僅保留90天。本報告未經本公司書面許可，不可部份複製。

This document is issued by the Company subject to its General Conditions of Service printed overleaf, available on request or accessible at <http://www.sgs.com.tw/Terms-and-Conditions>, and for electronic format documents, subject to Terms and Conditions for Electronic Documents at <http://www.sgs.com.tw/Terms-and-Conditions>. Attention is drawn to the limitation of liability, indemnification and jurisdiction issues defined therein. Any holder of this document is advised that information contained hereon reflects the Company's findings at the time of its intervention only and within the limits of Client's instructions, if any. The Company's sole responsibility is to its Client and this document does not exonerate parties to a transaction from exercising all their rights and obligations under the transaction documents. This document cannot be reproduced except in full, without prior written approval of the Company. Any unauthorized alteration, forgery or falsification of the content or appearance of this document is unlawful and offenders may be prosecuted to the fullest extent of the law.

13 UNII DETECTION BANDWIDTH MEASUREMENT

13.1 Test Result

EUT operating Frequency(MHz)	: 5320	EUT 99% Bandwidth(MHz)	: 18.755
Radar Type	: Type 0	Detction BW(MHz)	: 20
Test Result	: Pass	※ FH: 5330	FL: 5310

Radio Frequency (MHz)	DFS Detection Trials (1=Detection, 0= No Detection)										Detection Rate (%)
	1	2	3	4	5	6	7	8	9	10	
5310	1	1	1	1	1	1	1	1	1	1	100
5315	1	1	1	1	1	1	1	1	1	1	100
5320	1	1	1	1	1	1	1	1	1	1	100
5325	1	1	1	1	1	1	1	1	1	1	100
5330	1	1	1	1	1	1	1	1	1	1	100

Unless otherwise stated the results shown in this test report refer only to the sample(s) tested and such sample(s) are retained for 90 days only.
 除非另有說明，此報告結果僅對測試之樣品負責，同時此樣品僅保留90天。本報告未經本公司書面許可，不可部份複製。
 This document is issued by the Company subject to its General Conditions of Service printed overleaf, available on request or accessible at <http://www.sgs.com.tw/Terms-and-Conditions>, and for electronic format documents, subject to Terms and Conditions for Electronic Documents at <http://www.sgs.com.tw/Terms-and-Conditions>. Attention is drawn to the limitation of liability, indemnification and jurisdiction issues defined therein. Any holder of this document is advised that information contained hereon reflects the Company's findings at the time of its intervention only and within the limits of Client's instructions, if any. The Company's sole responsibility is to its Client and this document does not exonerate parties to a transaction from exercising all their rights and obligations under the transaction documents. This document cannot be reproduced except in full, without prior written approval of the Company. Any unauthorized alteration, forgery or falsification of the content or appearance of this document is unlawful and offenders may be prosecuted to the fullest extent of the law.

EUT operating Frequency(MHz)	: 5500	EUT 99% Bandwidth(MHz)	: 18.489								
Radar Type	: Type 0	Detction BW(MHz)	: 20								
Test Result	: Pass	※ FH: 5510	FL: 5490								
Radio Frequency (MHz)	DFS Detection Trials (1=Detection, 0= No Detection)										Detection Rate (%)
	1	2	3	4	5	6	7	8	9	10	
5490	1	1	1	1	1	1	1	1	1	1	100
5495	1	1	1	1	1	1	1	1	1	1	100
5500	1	1	1	1	1	1	1	1	1	1	100
5505	1	1	1	1	1	1	1	1	1	1	100
5510	1	1	1	1	1	1	1	1	1	1	100

Unless otherwise stated the results shown in this test report refer only to the sample(s) tested and such sample(s) are retained for 90 days only.
 除非另有說明，此報告結果僅對測試之樣品負責，同時此樣品僅保留90天。本報告未經本公司書面許可，不可部份複製。
 This document is issued by the Company subject to its General Conditions of Service printed overleaf, available on request or accessible at <http://www.sgs.com.tw/Terms-and-Conditions>, and for electronic format documents, subject to Terms and Conditions for Electronic Documents at <http://www.sgs.com.tw/Terms-and-Conditions>. Attention is drawn to the limitation of liability, indemnification and jurisdiction issues defined therein. Any holder of this document is advised that information contained hereon reflects the Company's findings at the time of its intervention only and within the limits of Client's instructions, if any. The Company's sole responsibility is to its Client and this document does not exonerate parties to a transaction from exercising all their rights and obligations under the transaction documents. This document cannot be reproduced except in full, without prior written approval of the Company. Any unauthorized alteration, forgery or falsification of the content or appearance of this document is unlawful and offenders may be prosecuted to the fullest extent of the law.

EUT operating Frequency(MHz)	: 5310	EUT 99% Bandwidth(MHz)	: 38.005
Radar Type	: Type 0	Detction BW(MHz)	: 40
Test Result	: Pass	※ FH: 5330	FL: 5290

Radio Frequency (MHz)	DFS Detection Trials (1=Detection, 0= No Detection)										Detection Rate (%)
	1	2	3	4	5	6	7	8	9	10	
5290	1	1	1	1	1	1	1	1	1	1	100
5295	1	1	1	1	1	1	1	1	1	1	100
5300	1	1	1	1	1	1	1	1	1	1	100
5305	1	1	1	1	1	1	1	1	1	1	100
5310	1	1	1	1	1	1	1	1	1	1	100
5315	1	1	1	1	1	1	1	1	1	1	100
5320	1	1	1	1	1	1	1	1	1	1	100
5325	1	1	1	1	1	1	1	1	1	1	100
5330	1	1	1	1	1	1	1	1	1	1	100

Unless otherwise stated the results shown in this test report refer only to the sample(s) tested and such sample(s) are retained for 90 days only.
 除非另有說明，此報告結果僅對測試之樣品負責，同時此樣品僅保留90天。本報告未經本公司書面許可，不可部份複製。
 This document is issued by the Company subject to its General Conditions of Service printed overleaf, available on request or accessible at <http://www.sgs.com.tw/Terms-and-Conditions> and for electronic format documents, subject to Terms and Conditions for Electronic Documents at <http://www.sgs.com.tw/Terms-and-Conditions>. Attention is drawn to the limitation of liability, indemnification and jurisdiction issues defined therein. Any holder of this document is advised that information contained hereon reflects the Company's findings at the time of its intervention only and within the limits of Client's instructions, if any. The Company's sole responsibility is to its Client and this document does not exonerate parties to a transaction from exercising all their rights and obligations under the transaction documents. This document cannot be reproduced except in full, without prior written approval of the Company. Any unauthorized alteration, forgery or falsification of the content or appearance of this document is unlawful and offenders may be prosecuted to the fullest extent of the law.

EUT operating Frequency(MHz)	: 5510	EUT 99% Bandwidth(MHz)	: 37.726
Radar Type	: Type 0	Detection BW(MHz)	: 40
Test Result	: Pass	※ FH: 5530	FL: 5490

Radio Frequency (MHz)	DFS Detection Trials (1=Detection, 0= No Detection)										Detection Rate (%)
	1	2	3	4	5	6	7	8	9	10	
5490	1	1	1	1	1	1	1	1	1	1	100
5495	1	1	1	1	1	1	1	1	1	1	100
5500	1	1	1	1	1	1	1	1	1	1	100
5505	1	1	1	1	1	1	1	1	1	1	100
5510	1	1	1	1	1	1	1	1	1	1	100
5515	1	1	1	1	1	1	1	1	1	1	100
5520	1	1	1	1	1	1	1	1	1	1	100
5525	1	1	1	1	1	1	1	1	1	1	100
5530	1	1	1	1	1	1	1	1	1	1	100

Unless otherwise stated the results shown in this test report refer only to the sample(s) tested and such sample(s) are retained for 90 days only.
 除非另有說明，此報告結果僅對測試之樣品負責，同時此樣品僅保留90天。本報告未經本公司書面許可，不可部份複製。
 This document is issued by the Company subject to its General Conditions of Service printed overleaf, available on request or accessible at <http://www.sgs.com.tw/Terms-and-Conditions>, and for electronic format documents, subject to Terms and Conditions for Electronic Documents at <http://www.sgs.com.tw/Terms-and-Conditions>. Attention is drawn to the limitation of liability, indemnification and jurisdiction issues defined therein. Any holder of this document is advised that information contained hereon reflects the Company's findings at the time of its intervention only and within the limits of Client's instructions, if any. The Company's sole responsibility is to its Client and this document does not exonerate parties to a transaction from exercising all their rights and obligations under the transaction documents. This document cannot be reproduced except in full, without prior written approval of the Company. Any unauthorized alteration, forgery or falsification of the content or appearance of this document is unlawful and offenders may be prosecuted to the fullest extent of the law.

SGS Taiwan Ltd.
No.134,Wu Kung Road, New Taipei Industrial Park, Wuku District, New Taipei City, Taiwan/新北市五股區新北產業園區五工路 134 號

台灣檢驗科技股份有限公司
t (886-2) 2299-3279
f (886-2) 2298-0488
www.sgs.com.tw

Member of SGS Group

EUT operating Frequency(MHz)	:	5290	EUT 99% Bandwidth(MHz)	:	75.082
Radar Type	:	Type 0	Detction BW(MHz)	:	80
Test Result	:	Pass	※ FH: 5330	FL: 5250	

Radio Frequency (MHz)	DFS Detection Trials (1=Detection, 0= No Detection)										Detection Rate (%)
	1	2	3	4	5	6	7	8	9	10	
5250	1	1	1	1	1	1	1	1	1	1	100
5255	1	1	1	1	1	1	1	1	1	1	100
5260	1	1	1	1	1	1	1	1	1	1	100
5265	1	1	1	1	1	1	1	1	1	1	100
5270	1	1	1	1	1	1	1	1	1	1	100
5275	1	1	1	1	1	1	1	1	1	1	100
5280	1	1	1	1	1	1	1	1	1	1	100
5285	1	1	1	1	1	1	1	1	1	1	100
5290	1	1	1	1	1	1	1	1	1	1	100
5295	1	1	1	1	1	1	1	1	1	1	100
5300	1	1	1	1	1	1	1	1	1	1	100
5305	1	1	1	1	1	1	1	1	1	1	100
5310	1	1	1	1	1	1	1	1	1	1	100
5315	1	1	1	1	1	1	1	1	1	1	100
5320	1	1	1	1	1	1	1	1	1	1	100
5325	1	1	1	1	1	1	1	1	1	1	100
5330	1	1	1	1	1	1	1	1	1	1	100

Unless otherwise stated the results shown in this test report refer only to the sample(s) tested and such sample(s) are retained for 90 days only.
 除非另有說明，此報告結果僅對測試之樣品負責，同時此樣品僅保留90天。本報告未經本公司書面許可，不可部份複製。
 This document is issued by the Company subject to its General Conditions of Service printed overleaf, available on request or accessible at <http://www.sgs.com.tw/Terms-and-Conditions> and for electronic format documents, subject to Terms and Conditions for Electronic Documents at <http://www.sgs.com.tw/Terms-and-Conditions>. Attention is drawn to the limitation of liability, indemnification and jurisdiction issues defined therein. Any holder of this document is advised that information contained hereon reflects the Company's findings at the time of its intervention only and within the limits of Client's instructions, if any. The Company's sole responsibility is to its Client and this document does not exonerate parties to a transaction from exercising all their rights and obligations under the transaction documents. This document cannot be reproduced except in full, without prior written approval of the Company. Any unauthorized alteration, forgery or falsification of the content or appearance of this document is unlawful and offenders may be prosecuted to the fullest extent of the law.

EUT operating Frequency(MHz)	: 5530	EUT 99% Bandwidth(MHz)	: 77.398
Radar Type	: Type 0	Detection BW(MHz)	: 80
Test Result	: Pass	※ FH: 5570	FL: 5490

Radio Frequency (MHz)	DFS Detection Trials (1=Detection, 0= No Detection)										Detection Rate (%)
	1	2	3	4	5	6	7	8	9	10	
5490	1	1	1	1	1	1	1	1	1	1	100
5495	1	1	1	1	1	1	1	1	1	1	100
5500	1	1	1	1	1	1	1	1	1	1	100
5505	1	1	1	1	1	1	1	1	1	1	100
5510	1	1	1	1	1	1	1	1	1	1	100
5515	1	1	1	1	1	1	1	1	1	1	100
5520	1	1	1	1	1	1	1	1	1	1	100
5525	1	1	1	1	1	1	1	1	1	1	100
5530	1	1	1	1	1	1	1	1	1	1	100
5535	1	1	1	1	1	1	1	1	1	1	100
5540	1	1	1	1	1	1	1	1	1	1	100
5545	1	1	1	1	1	1	1	1	1	1	100
5550	1	1	1	1	1	1	1	1	1	1	100
5555	1	1	1	1	1	1	1	1	1	1	100
5560	1	1	1	1	1	1	1	1	1	1	100
5565	1	1	1	1	1	1	1	1	1	1	100
5570	1	1	1	1	1	1	1	1	1	1	100

Unless otherwise stated the results shown in this test report refer only to the sample(s) tested and such sample(s) are retained for 90 days only.
 除非另有說明，此報告結果僅對測試之樣品負責，同時此樣品僅保留90天。本報告未經本公司書面許可，不可部份複製。
 This document is issued by the Company subject to its General Conditions of Service printed overleaf, available on request or accessible at <http://www.sgs.com.tw/Terms-and-Conditions> and for electronic format documents, subject to Terms and Conditions for Electronic Documents at <http://www.sgs.com.tw/Terms-and-Conditions>. Attention is drawn to the limitation of liability, indemnification and jurisdiction issues defined therein. Any holder of this document is advised that information contained hereon reflects the Company's findings at the time of its intervention only and within the limits of Client's instructions, if any. The Company's sole responsibility is to its Client and this document does not exonerate parties to a transaction from exercising all their rights and obligations under the transaction documents. This document cannot be reproduced except in full, without prior written approval of the Company. Any unauthorized alteration, forgery or falsification of the content or appearance of this document is unlawful and offenders may be prosecuted to the fullest extent of the law.

EUT operating Frequency(MHz)	: 5250	U-NII 2	: 77.670
Radar Type	: Type 0	EUT 99% Bandwidth(MHz)	: 80
Test Result	: Pass	※ FH: 5330	FL: 5250

Radio Frequency (MHz)	DFS Detection Trials (1=Detection, 0= No Detection)										Detection Rate (%)
	1	2	3	4	5	6	7	8	9	10	
5250	1	1	1	1	1	1	1	1	1	1	100
5255	1	1	1	1	1	1	1	1	1	1	100
5260	1	1	1	1	1	1	1	1	1	1	100
5265	1	1	1	1	1	1	1	1	1	1	100
5270	1	1	1	1	1	1	1	1	1	1	100
5275	1	1	1	1	1	1	1	1	1	1	100
5280	1	1	1	1	1	1	1	1	1	1	100
5285	1	1	1	1	1	1	1	1	1	1	100
5290	1	1	1	1	1	1	1	1	1	1	100
5295	1	1	1	1	1	1	1	1	1	1	100
5300	1	1	1	1	1	1	1	1	1	1	100
5305	1	1	1	1	1	1	1	1	1	1	100
5310	1	1	1	1	1	1	1	1	1	1	100
5315	1	1	1	1	1	1	1	1	1	1	100
5320	1	1	1	1	1	1	1	1	1	1	100
5325	1	1	1	1	1	1	1	1	1	1	100
5330	1	1	1	1	1	1	1	1	1	1	100

Unless otherwise stated the results shown in this test report refer only to the sample(s) tested and such sample(s) are retained for 90 days only.
 除非另有說明，此報告結果僅對測試之樣品負責，同時此樣品僅保留90天。本報告未經本公司書面許可，不可部份複製。
 This document is issued by the Company subject to its General Conditions of Service printed overleaf, available on request or accessible at <http://www.sgs.com.tw/Terms-and-Conditions> and for electronic format documents, subject to Terms and Conditions for Electronic Documents at <http://www.sgs.com.tw/Terms-and-Conditions>. Attention is drawn to the limitation of liability, indemnification and jurisdiction issues defined therein. Any holder of this document is advised that information contained hereon reflects the Company's findings at the time of its intervention only and within the limits of Client's instructions, if any. The Company's sole responsibility is to its Client and this document does not exonerate parties to a transaction from exercising all their rights and obligations under the transaction documents. This document cannot be reproduced except in full, without prior written approval of the Company. Any unauthorized alteration, forgery or falsification of the content or appearance of this document is unlawful and offenders may be prosecuted to the fullest extent of the law.

EUT operating Frequency(MHz)	: 5570	EUT 99% Bandwidth(MHz)	: 153.420
Radar Type	: Radar Type 0	Detction BW(MHz)	: 160
Test Result	: Pass	※ FH: 5650	FL: 5490

Radio Frequency (MHz)	DFS Detection Trials (1=Detection, 0= No Detection)										Detection Rate (%)
	1	2	3	4	5	6	7	8	9	10	
5490	1	1	1	1	1	1	1	1	1	1	100
5495	1	1	1	1	1	1	1	1	1	1	100
5500	1	1	1	1	1	1	1	1	1	1	100
5505	1	1	1	1	1	1	1	1	1	1	100
5510	1	1	1	1	1	1	1	1	1	1	100
5515	1	1	1	1	1	1	1	1	1	1	100
5520	1	1	1	1	1	1	1	1	1	1	100
5525	1	1	1	1	1	1	1	1	1	1	100
5530	1	1	1	1	1	1	1	1	1	1	100
5535	1	1	1	1	1	1	1	1	1	1	100
5540	1	1	1	1	1	1	1	1	1	1	100
5545	1	1	1	1	1	1	1	1	1	1	100
5550	1	1	1	1	1	1	1	1	1	1	100
5555	1	1	1	1	1	1	1	1	1	1	100
5560	1	1	1	1	1	1	1	1	1	1	100
5565	1	1	1	1	1	1	1	1	1	1	100
5570	1	1	1	1	1	1	1	1	1	1	100
5575	1	1	1	1	1	1	1	1	1	1	100
5580	1	1	1	1	1	1	1	1	1	1	100
5585	1	1	1	1	1	1	1	1	1	1	100
5590	1	1	1	1	1	1	1	1	1	1	100
5595	1	1	1	1	1	1	1	1	1	1	100
5600	1	1	1	1	1	1	1	1	1	1	100
5605	1	1	1	1	1	1	1	1	1	1	100
5610	1	1	1	1	1	1	1	1	1	1	100
5615	1	1	1	1	1	1	1	1	1	1	100
5620	1	1	1	1	1	1	1	1	1	1	100
5625	1	1	1	1	1	1	1	1	1	1	100
5630	1	1	1	1	1	1	1	1	1	1	100
5635	1	1	1	1	1	1	1	1	1	1	100
5640	1	1	1	1	1	1	1	1	1	1	100
5645	1	1	1	1	1	1	1	1	1	1	100
5650	1	1	1	1	1	1	1	1	1	1	100

Unless otherwise stated the results shown in this test report refer only to the sample(s) tested and such sample(s) are retained for 90 days only.

除非另有說明，此報告結果僅對測試之樣品負責，同時此樣品僅保留90天。本報告未經本公司書面許可，不可部份複製。

This document is issued by the Company subject to its General Conditions of Service printed overleaf, available on request or accessible at <http://www.sgs.com.tw/Terms-and-Conditions>, and for electronic format documents, subject to Terms and Conditions for Electronic Documents at <http://www.sgs.com.tw/Terms-and-Conditions>. Attention is drawn to the limitation of liability, indemnification and jurisdiction issues defined therein. Any holder of this document is advised that information contained hereon reflects the Company's findings at the time of its intervention only and within the limits of Client's instructions, if any. The Company's sole responsibility is to its Client and this document does not exonerate parties to a transaction from exercising all their rights and obligations under the transaction documents. This document cannot be reproduced except in full, without prior written approval of the Company. Any unauthorized alteration, forgery or falsification of the content or appearance of this document is unlawful and offenders may be prosecuted to the fullest extent of the law.

HE20_5320MHz

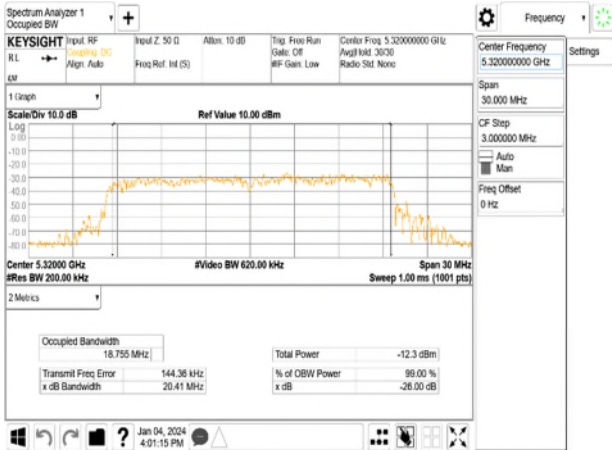

HE40_5510MHz

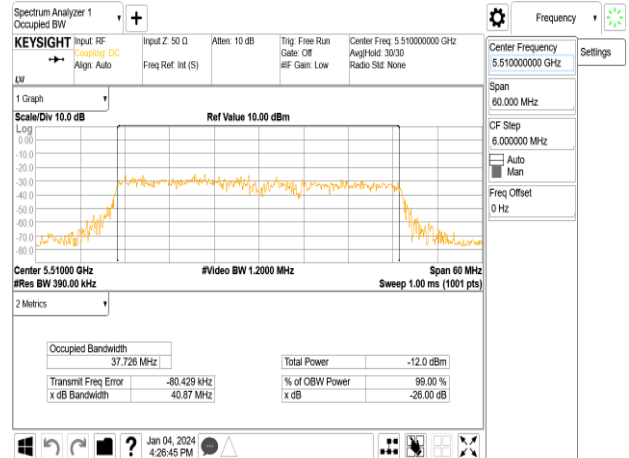

HE20_5500MHz

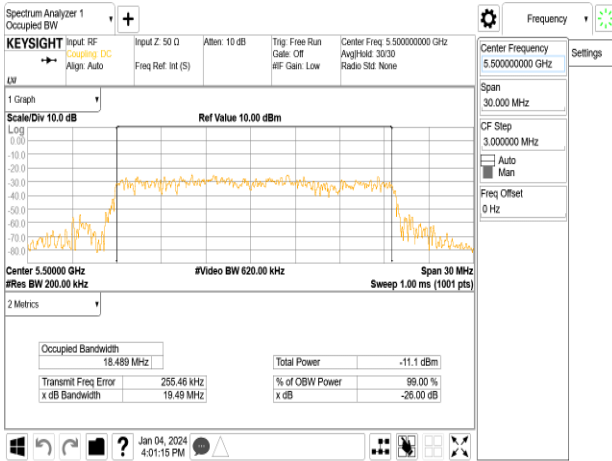

HE80_5290MHz

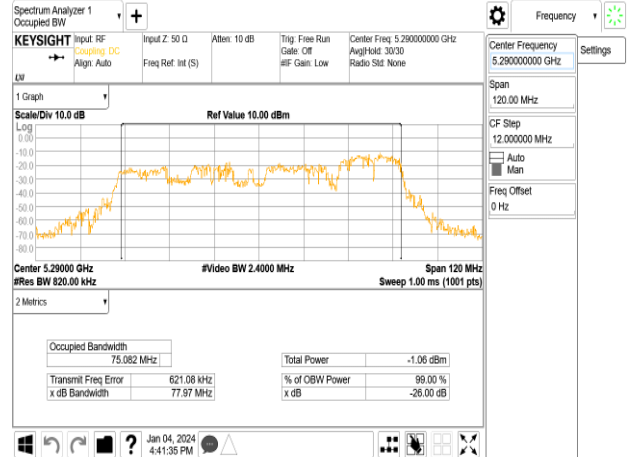

HE40_5310MHz

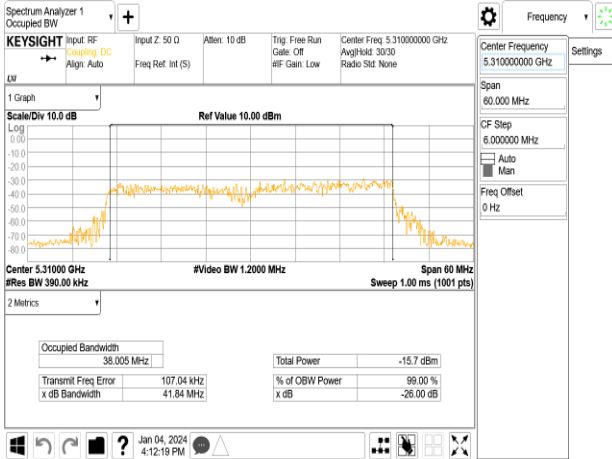

HE80_5530MHz

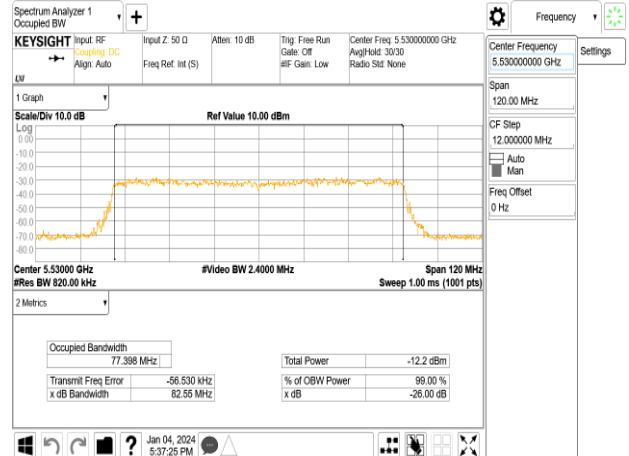

Unless otherwise stated the results shown in this test report refer only to the sample(s) tested and such sample(s) are retained for 90 days only.

除非另有說明，此報告結果僅對測試之樣品負責，同時此樣品僅保留90天。本報告未經本公司書面許可，不可部份複製。

This document is issued by the Company subject to its General Conditions of Service printed overleaf, available on request or accessible at <http://www.sgs.com.tw/Terms-and-Conditions> and for electronic format documents, subject to Terms and Conditions for Electronic Documents at <http://www.sgs.com.tw/Terms-and-Conditions>. Attention is drawn to the limitation of liability, indemnification and jurisdiction issues defined therein. Any holder of this document is advised that information contained hereon reflects the Company's findings at the time of its intervention only and within the limits of Client's instructions, if any. The Company's sole responsibility is to its Client and this document does not exonerate parties to a transaction from exercising all their rights and obligations under the transaction documents. This document cannot be reproduced except in full, without prior written approval of the Company. Any unauthorized alteration, forgery or falsification of the content or appearance of this document is unlawful and offenders may be prosecuted to the fullest extent of the law.

HE160_5250MHz

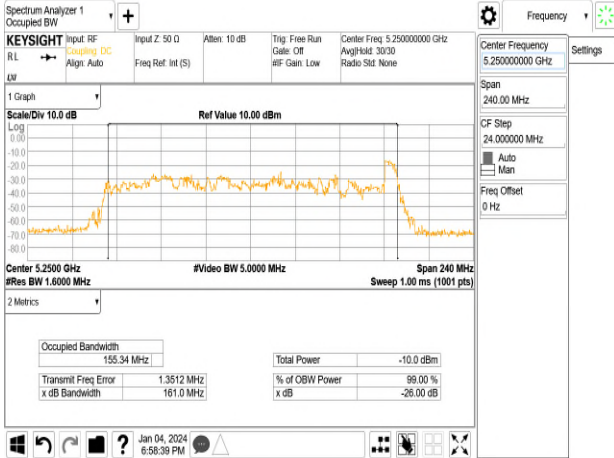

HE160_5570MHz

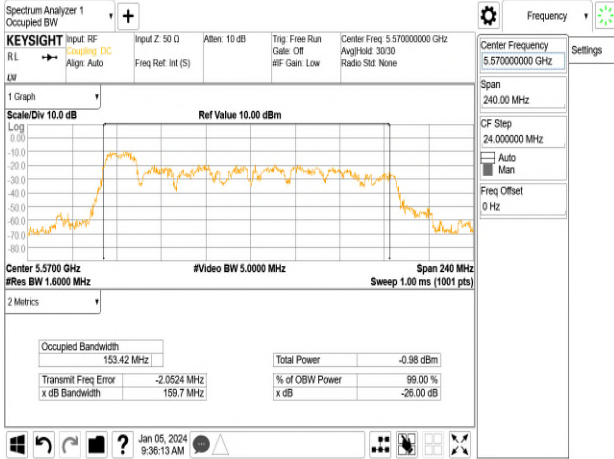

Unless otherwise stated the results shown in this test report refer only to the sample(s) tested and such sample(s) are retained for 90 days only.

除非另有說明，此報告結果僅對測試之樣品負責，同時此樣品僅保留90天。本報告未經本公司書面許可，不可部份複製。

This document is issued by the Company subject to its General Conditions of Service printed overleaf, available on request or accessible at <http://www.sgs.com.tw/Terms-and-Conditions> and for electronic format documents, subject to Terms and Conditions for Electronic Documents at <http://www.sgs.com.tw/Terms-and-Conditions>. Attention is drawn to the limitation of liability, indemnification and jurisdiction issues defined therein. Any holder of this document is advised that information contained hereon reflects the Company's findings at the time of its intervention only and within the limits of Client's instructions, if any. The Company's sole responsibility is to its Client and this document does not exonerate parties to a transaction from exercising all their rights and obligations under the transaction documents. This document cannot be reproduced except in full, without prior written approval of the Company. Any unauthorized alteration, forgery or falsification of the content or appearance of this document is unlawful and offenders may be prosecuted to the fullest extent of the law.

14 CHANNEL AVAILABILITY CHECK MEASUREMENT

HE160_5250MHz_Radar Time



HE160_5570MHz_Radar Time

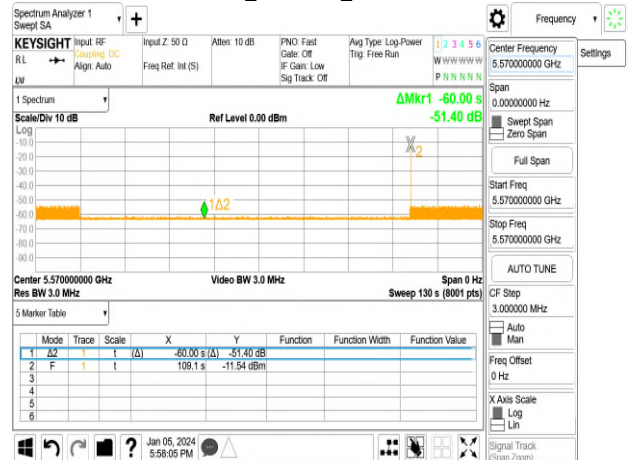

HE160_5250MHz_Radar Type 0-1



HE160_5570MHz_Radar Type 0-1



HE160_5250MHz_Radar Type 0-2

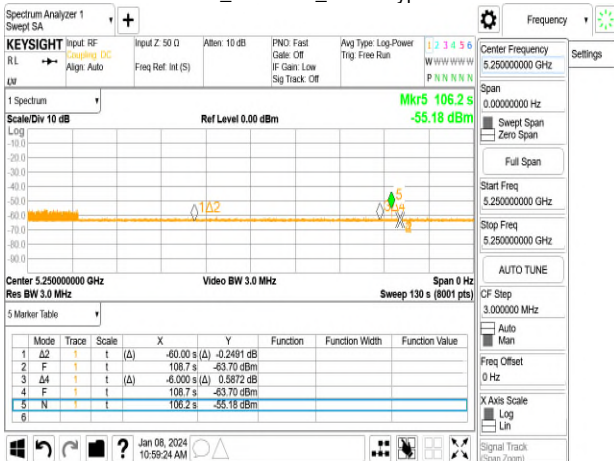

HE160_5570MHz_Radar Type 0-2

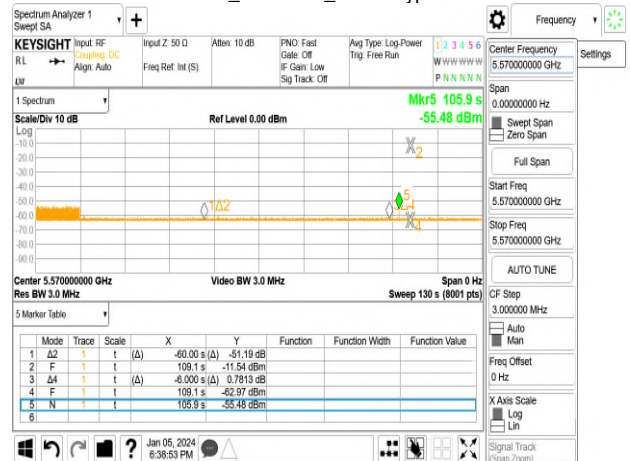

Unless otherwise stated the results shown in this test report refer only to the sample(s) tested and such sample(s) are retained for 90 days only.

除非另有說明，此報告結果僅對測試之樣品負責，同時此樣品僅保留90天。本報告未經本公司書面許可，不可部份複製。

This document is issued by the Company subject to its General Conditions of Service printed overleaf, available on request or accessible at <http://www.sgs.com.tw/Terms-and-Conditions> and for electronic format documents, subject to Terms and Conditions for Electronic Documents at <http://www.sgs.com.tw/Terms-and-Conditions>. Attention is drawn to the limitation of liability, indemnification and jurisdiction issues defined therein. Any holder of this document is advised that information contained hereon reflects the Company's findings at the time of its intervention only and within the limits of Client's instructions, if any. The Company's sole responsibility is to its Client and this document does not exonerate parties to a transaction from exercising all their rights and obligations under the transaction documents. This document cannot be reproduced except in full, without prior written approval of the Company. Any unauthorized alteration, forgery or falsification of the content or appearance of this document is unlawful and offenders may be prosecuted to the fullest extent of the law.

15 IN SERVICE MONITORING

HE20_5320MHz

Short Pulse Radar Type	Minimum Number of Trials	Detection(%)		Minimum Percentage of Successful Detection(%)	Pass/Fail
1	30	100		60	Pass
2	30	100		60	Pass
3	30	100		60	Pass
4	30	100		60	Pass
Aggregate (Radar Types 1-4)	120	100		80	Pass
Long Pulse Radar Type	Minimum Number of Trials	Each Detection(%)	Total Detection(%)	Minimum Percentage of Successful Detection(%)	Pass/Fail
5	Center:10	100	100	80	Pass
	Low Edge:10	100			
	High Edge:10	100			
Frequency Hopping Radar Type	Minimum Number of Trials	Detection(%)		Minimum Percentage of Successful Detection(%)	Pass/Fail
6	30	100		70	Pass

Unless otherwise stated the results shown in this test report refer only to the sample(s) tested and such sample(s) are retained for 90 days only.

除非另有說明，此報告結果僅對測試之樣品負責，同時此樣品僅保留90天。本報告未經本公司書面許可，不可部份複製。

This document is issued by the Company subject to its General Conditions of Service printed overleaf, available on request or accessible at <http://www.sgs.com.tw/Terms-and-Conditions> and for electronic format documents, subject to Terms and Conditions for Electronic Documents at <http://www.sgs.com.tw/Terms-and-Conditions>. Attention is drawn to the limitation of liability, indemnification and jurisdiction issues defined therein. Any holder of this document is advised that information contained hereon reflects the Company's findings at the time of its intervention only and within the limits of Client's instructions, if any. The Company's sole responsibility is to its Client and this document does not exonerate parties to a transaction from exercising all their rights and obligations under the transaction documents. This document cannot be reproduced except in full, without prior written approval of the Company. Any unauthorized alteration, forgery or falsification of the content or appearance of this document is unlawful and offenders may be prosecuted to the fullest extent of the law.

Radar Type1 for 5320MHz

Data Sheet for FCC Radar Type 1

Trial	VSG Frequency (MHz)	Pulse Repetition Frequency Number (1 to 23)	Pulse Repetition Frequency	PRI	Test A/B	Successful Detection
			(Pulses Per Second)	(msec)	A/B	(Yes/No)
1	5320	13	1319.3	758	A	Yes
2	5320	21	1089.3	918	A	Yes
3	5320	8	1519.8	658	A	Yes
4	5320	19	1139	878	A	Yes
5	5320	18	1165.5	858	A	Yes
6	5320	11	1392.8	718	A	Yes
7	5320	6	1618.1	618	A	Yes
8	5320	10	1432.7	698	A	Yes
9	5320	16	1222.5	818	A	Yes
10	5320	17	1193.3	838	A	Yes
11	5320	23	326.2	3066	A	Yes
12	5320	9	1474.9	678	A	Yes
13	5320	4	1730.1	578	A	Yes
14	5320	5	1672.2	598	A	Yes
15	5320	1	1930.5	518	A	Yes
16	5320	-	533.6	1874	B	Yes
17	5320	-	471.7	2120	B	Yes
18	5320	-	342.2	2922	B	Yes
19	5320	-	993	1007	B	Yes
20	5320	-	1257.9	795	B	Yes
21	5320	-	742.9	1346	B	Yes
22	5320	-	814.3	1228	B	Yes
23	5320	-	403.1	2481	B	Yes
24	5320	-	700.8	1427	B	Yes
25	5320	-	1831.5	546	B	Yes
26	5320	-	1251.6	799	B	Yes
27	5320	-	483.6	2068	B	Yes
28	5320	-	970.9	1030	B	Yes
29	5320	-	449.6	2224	B	Yes
30	5320	-	687.8	1454	B	Yes

Unless otherwise stated the results shown in this test report refer only to the sample(s) tested and such sample(s) are retained for 90 days only.

除非另有說明，此報告結果僅對測試之樣品負責，同時此樣品僅保留90天。本報告未經本公司書面許可，不可部份複製。

This document is issued by the Company subject to its General Conditions of Service printed overleaf, available on request or accessible at <http://www.sgs.com.tw/Terms-and-Conditions> and for electronic format documents, subject to Terms and Conditions for Electronic Documents at <http://www.sgs.com.tw/Terms-and-Conditions>. Attention is drawn to the limitation of liability, indemnification and jurisdiction issues defined therein. Any holder of this document is advised that information contained hereon reflects the Company's findings at the time of its intervention only and within the limits of Client's instructions, if any. The Company's sole responsibility is to its Client and this document does not exonerate parties to a transaction from exercising all their rights and obligations under the transaction documents. This document cannot be reproduced except in full, without prior written approval of the Company. Any unauthorized alteration, forgery or falsification of the content or appearance of this document is unlawful and offenders may be prosecuted to the fullest extent of the law.

SGS Taiwan Ltd.

No.134,Wu Kung Road, New Taipei Industrial Park, Wuku District, New Taipei City, Taiwan/新北市五股區新北產業園區五工路 134 號

台灣檢驗科技股份有限公司

t (886-2) 2299-3279

f (886-2) 2298-0488

www.sgs.com.tw

Member of SGS Group

Radar Type2 for 5320MHz

Data Sheet for FCC Radar Type 2

Trial	VSG Frequency (MHz)	Number Pulses per Burst (23-29)	Pulse Width (1-5)	PRI (150-230)	Successful Detection
			(μ s)	(μ s)	(Yes/No)
1	5320	29	4.9	195	Yes
2	5320	28	4.1	153	Yes
3	5320	26	3.2	151	Yes
4	5320	23	1.2	227	Yes
5	5320	23	1.1	179	Yes
6	5320	26	2.9	166	Yes
7	5320	26	2.7	174	Yes
8	5320	24	2.1	230	Yes
9	5320	24	1.9	180	Yes
10	5320	29	4.8	223	Yes
11	5320	26	3.2	193	Yes
12	5320	24	1.9	155	Yes
13	5320	28	4	187	Yes
14	5320	29	5	206	Yes
15	5320	27	3.6	220	Yes
16	5320	29	4.7	175	Yes
17	5320	24	1.7	204	Yes
18	5320	26	3.1	181	Yes
19	5320	25	2.2	228	Yes
20	5320	28	4	182	Yes
21	5320	23	1.4	198	Yes
22	5320	26	3	199	Yes
23	5320	27	3.3	152	Yes
24	5320	23	1.3	178	Yes
25	5320	25	2.2	207	Yes
26	5320	27	3.4	159	Yes
27	5320	28	3.9	225	Yes
28	5320	27	3.6	168	Yes
29	5320	25	2.3	177	Yes
30	5320	29	4.7	205	Yes

Unless otherwise stated the results shown in this test report refer only to the sample(s) tested and such sample(s) are retained for 90 days only.

除非另有說明，此報告結果僅對測試之樣品負責，同時此樣品僅保留90天。本報告未經本公司書面許可，不可部份複製。

This document is issued by the Company subject to its General Conditions of Service printed overleaf, available on request or accessible at <http://www.sgs.com.tw/Terms-and-Conditions> and for electronic format documents, subject to Terms and Conditions for Electronic Documents at <http://www.sgs.com.tw/Terms-and-Conditions>. Attention is drawn to the limitation of liability, indemnification and jurisdiction issues defined therein. Any holder of this document is advised that information contained hereon reflects the Company's findings at the time of its intervention only and within the limits of Client's instructions, if any. The Company's sole responsibility is to its Client and this document does not exonerate parties to a transaction from exercising all their rights and obligations under the transaction documents. This document cannot be reproduced except in full, without prior written approval of the Company. Any unauthorized alteration, forgery or falsification of the content or appearance of this document is unlawful and offenders may be prosecuted to the fullest extent of the law.

Radar Type3 for 5320MHz

Data Sheet for FCC Radar Type 3

Trial	VSG Frequency (MHz)	Number Pulses per Burst (16-18)	Pulse Width (6-10)	PRI (200-500)	Successful Detection
			(μ s)	(μ s)	(Yes/No)
1	5320	18	9.9	442	Yes
2	5320	18	9.1	499	Yes
3	5320	17	8.2	273	Yes
4	5320	16	6.2	338	Yes
5	5320	16	6.1	487	Yes
6	5320	17	7.9	420	Yes
7	5320	17	7.7	450	Yes
8	5320	16	7.1	339	Yes
9	5320	16	6.9	405	Yes
10	5320	18	9.8	223	Yes
11	5320	17	8.2	453	Yes
12	5320	16	6.9	417	Yes
13	5320	18	9	400	Yes
14	5320	18	10	498	Yes
15	5320	17	8.6	274	Yes
16	5320	18	9.7	431	Yes
17	5320	16	6.7	294	Yes
18	5320	17	8.1	203	Yes
19	5320	16	7.2	298	Yes
20	5320	18	9	473	Yes
21	5320	16	6.4	407	Yes
22	5320	17	8	258	Yes
23	5320	17	8.3	249	Yes
24	5320	16	6.3	446	Yes
25	5320	16	7.2	486	Yes
26	5320	17	8.4	480	Yes
27	5320	18	8.9	370	Yes
28	5320	17	8.6	348	Yes
29	5320	16	7.3	401	Yes
30	5320	18	9.7	264	Yes

Unless otherwise stated the results shown in this test report refer only to the sample(s) tested and such sample(s) are retained for 90 days only.

除非另有說明，此報告結果僅對測試之樣品負責，同時此樣品僅保留90天。本報告未經本公司書面許可，不可部份複製。

This document is issued by the Company subject to its General Conditions of Service printed overleaf, available on request or accessible at <http://www.sgs.com.tw/Terms-and-Conditions> and for electronic format documents, subject to Terms and Conditions for Electronic Documents at <http://www.sgs.com.tw/Terms-and-Conditions>. Attention is drawn to the limitation of liability, indemnification and jurisdiction issues defined therein. Any holder of this document is advised that information contained hereon reflects the Company's findings at the time of its intervention only and within the limits of Client's instructions, if any. The Company's sole responsibility is to its Client and this document does not exonerate parties to a transaction from exercising all their rights and obligations under the transaction documents. This document cannot be reproduced except in full, without prior written approval of the Company. Any unauthorized alteration, forgery or falsification of the content or appearance of this document is unlawful and offenders may be prosecuted to the fullest extent of the law.

Radar Type4 for 5320MHz

Data Sheet for FCC Radar Type 4

Trial	VSG Frequency (MHz)	Number Pulses per Burst (12-16)	Pulse Width (11-20)	PRI (200-500)	Successful Detection
			(μ s)	(μ s)	(Yes/No)
1	5320	16	19.6	442	Yes
2	5320	15	17.8	499	Yes
3	5320	14	15.8	273	Yes
4	5320	12	11.4	338	Yes
5	5320	12	11.3	487	Yes
6	5320	14	15.3	420	Yes
7	5320	14	14.9	450	Yes
8	5320	13	13.5	339	Yes
9	5320	13	13.1	405	Yes
10	5320	16	19.5	223	Yes
11	5320	14	16	453	Yes
12	5320	13	13	417	Yes
13	5320	15	17.8	400	Yes
14	5320	16	20	498	Yes
15	5320	15	16.9	274	Yes
16	5320	16	19.2	431	Yes
17	5320	12	12.6	294	Yes
18	5320	14	15.6	203	Yes
19	5320	13	13.6	298	Yes
20	5320	15	17.6	473	Yes
21	5320	12	12.1	407	Yes
22	5320	14	15.5	258	Yes
23	5320	14	16.2	249	Yes
24	5320	12	11.7	446	Yes
25	5320	13	13.8	486	Yes
26	5320	15	16.5	480	Yes
27	5320	15	17.5	370	Yes
28	5320	15	16.8	348	Yes
29	5320	13	13.9	401	Yes
30	5320	16	19.3	264	Yes

Unless otherwise stated the results shown in this test report refer only to the sample(s) tested and such sample(s) are retained for 90 days only.

除非另有說明，此報告結果僅對測試之樣品負責，同時此樣品僅保留90天。本報告未經本公司書面許可，不可部份複製。

This document is issued by the Company subject to its General Conditions of Service printed overleaf, available on request or accessible at <http://www.sgs.com.tw/Terms-and-Conditions> and for electronic format documents, subject to Terms and Conditions for Electronic Documents at <http://www.sgs.com.tw/Terms-and-Conditions>. Attention is drawn to the limitation of liability, indemnification and jurisdiction issues defined therein. Any holder of this document is advised that information contained hereon reflects the Company's findings at the time of its intervention only and within the limits of Client's instructions, if any. The Company's sole responsibility is to its Client and this document does not exonerate parties to a transaction from exercising all their rights and obligations under the transaction documents. This document cannot be reproduced except in full, without prior written approval of the Company. Any unauthorized alteration, forgery or falsification of the content or appearance of this document is unlawful and offenders may be prosecuted to the fullest extent of the law.

Radar Type5_Trial1 for 5320MHz

Data Sheet for FCC Radar Type 5						
Trial Number:			1	VSG Frequency(MHz):		5320
Number of Bursts in Trial:			20	Successful Detection:		Yes
Burst (8-20)	Number Pulses per Burst (1-3)	Pulse Width (50-100)	Chirp Width (5-20)	Pulse 1-to-2 Spacing	Pulse 2-to-3 Spacing	Starting Location Within Interval
		(μ sec)	(MHz)	(μ sec)	(μ sec)	(μ sec)
1	3	97.7	20	1034.3	1421.3	116141
2	3	87.9	20	1634.1	1463.1	260383
3	2	76.9	20	929.1		406435
4	1	52.4	20			552540
5	1	51.8	20			98818
6	2	74	20	1785		243337
7	2	71.7	20	1586.3		388146
8	1	64	20			534217
9	1	61.5	20			80882
10	3	97.3	20	912.7	1544.7	224944
11	2	77.7	20	1096.3		370763
12	1	61.1	20			516312
13	3	87.5	20	1260.5	1441.5	62728
14	3	99.7	20	1776.3	1284.3	207224
15	2	82.7	20	1140.3		352481
16	3	95.2	20	1213.8	1162.8	495985
17	1	59.1	20			45158
18	2	75.6	20	1041.4		189991
19	1	64.7	20			335648
20	3	86.8	20	918.2	1652.2	478439

Unless otherwise stated the results shown in this test report refer only to the sample(s) tested and such sample(s) are retained for 90 days only.

除非另有說明，此報告結果僅對測試之樣品負責，同時此樣品僅保留90天。本報告未經本公司書面許可，不可部份複製。

This document is issued by the Company subject to its General Conditions of Service printed overleaf, available on request or accessible at <http://www.sgs.com.tw/Terms-and-Conditions> and for electronic format documents, subject to Terms and Conditions for Electronic Documents at <http://www.sgs.com.tw/Terms-and-Conditions>. Attention is drawn to the limitation of liability, indemnification and jurisdiction issues defined therein. Any holder of this document is advised that information contained hereon reflects the Company's findings at the time of its intervention only and within the limits of Client's instructions, if any. The Company's sole responsibility is to its Client and this document does not exonerate parties to a transaction from exercising all their rights and obligations under the transaction documents. This document cannot be reproduced except in full, without prior written approval of the Company. Any unauthorized alteration, forgery or falsification of the content or appearance of this document is unlawful and offenders may be prosecuted to the fullest extent of the law.

Radar Type5_Trial2 for 5320MHz

Data Sheet for FCC Radar Type 5						
Trial Number:		2		VSG Frequency(MHz):		5320
Number of Bursts in Trial:			17		Successful Detection: Yes	
Burst (8-20)	Number Pulses per Burst (1-3)	Pulse Width (50-100)	Chirp Width (5-20)	Pulse 1-to-2 Spacing	Pulse 2-to-3 Spacing	Starting Location Within Interval
		(μ sec)	(MHz)	(μ sec)	(μ sec)	(μ sec)
1	1	56	17			32097
2	2	75.2	17	1446.8		202501
3	2	79.1	17	1594.9		372874
4	1	54.1	17			544886
5	1	65.8	17			11064
6	2	80.4	17	1102.6		181560
7	3	86	17	1685	1290	351173
8	2	82.4	17	1445.6		522390
9	1	66.3	17			694725
10	3	95.8	17	970.2	1319.2	160367
11	3	85.6	17	1831.4	1791.4	329885
12	1	51	17			502809
13	1	64.7	17			673232
14	3	90.6	17	1053.4	1866.4	139129
15	1	53.4	17			310563
16	3	96.2	17	1065.8	1773.8	479259
17	1	65.5	17			652703
18						
19						
20						

Unless otherwise stated the results shown in this test report refer only to the sample(s) tested and such sample(s) are retained for 90 days only.

除非另有說明，此報告結果僅對測試之樣品負責，同時此樣品僅保留90天。本報告未經本公司書面許可，不可部份複製。

This document is issued by the Company subject to its General Conditions of Service printed overleaf, available on request or accessible at <http://www.sgs.com.tw/Terms-and-Conditions> and for electronic format documents, subject to Terms and Conditions for Electronic Documents at <http://www.sgs.com.tw/Terms-and-Conditions>. Attention is drawn to the limitation of liability, indemnification and jurisdiction issues defined therein. Any holder of this document is advised that information contained hereon reflects the Company's findings at the time of its intervention only and within the limits of Client's instructions, if any. The Company's sole responsibility is to its Client and this document does not exonerate parties to a transaction from exercising all their rights and obligations under the transaction documents. This document cannot be reproduced except in full, without prior written approval of the Company. Any unauthorized alteration, forgery or falsification of the content or appearance of this document is unlawful and offenders may be prosecuted to the fullest extent of the law.

SGS Taiwan Ltd.

No.134,Wu Kung Road, New Taipei Industrial Park, Wuku District, New Taipei City, Taiwan/新北市五股區新北產業園區五工路 134 號

台灣檢驗科技股份有限公司

t (886-2) 2299-3279

f (886-2) 2298-0488

www.sgs.com.tw

Member of SGS Group

Radar Type5_Trial3 for 5320MHz

Data Sheet for FCC Radar Type 5						
Trial Number:			3	VSG Frequency(MHz):		5320
Number of Bursts in Trial:			14	Successful Detection:		Yes
Burst (8-20)	Number Pulses per Burst (1-3)	Pulse Width (50-100)	Chirp Width (5-20)	Pulse 1-to-2 Spacing	Pulse 2-to-3 Spacing	Starting Location Within Interval
		(μ sec)	(MHz)	(μ sec)	(μ sec)	(μ sec)
1	2	75.2	13	1361.8		143969
2	3	90.7	13	1099.3	988.3	350947
3	3	93.8	13	1045.2	1043.2	557505
4	1	60.8	13			766524
5	3	98.2	13	1508.8	1876.8	118256
6	3	88.5	13	959.5	1339.5	325401
7	3	90.5	13	1857.5	1691.5	531589
8	2	74.6	13	957.4		740731
9	2	74.5	13	1040.5		92978
10	1	53.5	13			300652
11	3	89.7	13	1803.3	1110.3	506183
12	2	80.9	13	1738.1		714128
13	1	51.5	13			67556
14	2	80.4	13	1193.6		274857
15						
16						
17						
18						
19						
20						

Unless otherwise stated the results shown in this test report refer only to the sample(s) tested and such sample(s) are retained for 90 days only.

除非另有說明，此報告結果僅對測試之樣品負責，同時此樣品僅保留90天。本報告未經本公司書面許可，不可部份複製。

This document is issued by the Company subject to its General Conditions of Service printed overleaf, available on request or accessible at <http://www.sgs.com.tw/Terms-and-Conditions> and for electronic format documents, subject to Terms and Conditions for Electronic Documents at <http://www.sgs.com.tw/Terms-and-Conditions>. Attention is drawn to the limitation of liability, indemnification and jurisdiction issues defined therein. Any holder of this document is advised that information contained hereon reflects the Company's findings at the time of its intervention only and within the limits of Client's instructions, if any. The Company's sole responsibility is to its Client and this document does not exonerate parties to a transaction from exercising all their rights and obligations under the transaction documents. This document cannot be reproduced except in full, without prior written approval of the Company. Any unauthorized alteration, forgery or falsification of the content or appearance of this document is unlawful and offenders may be prosecuted to the fullest extent of the law.

Radar Type5_Trial4 for 5320MHz

Data Sheet for FCC Radar Type 5						
Trial Number:			4	VSG Frequency(MHz):		5320
Number of Bursts in Trial:			8	Successful Detection:		Yes
Burst (8-20)	Number Pulses per Burst (1-3)	Pulse Width (50-100)	Chirp Width (5-20)	Pulse 1-to-2 Spacing	Pulse 2-to-3 Spacing	Starting Location Within Interval
		(μ sec)	(MHz)	(μ sec)	(μ sec)	(μ sec)
1	1	59.8	5			845339
2	1	65.7	5			1208624
3	2	70.7	5	1208.3		73525
4	2	72.4	5	1543.6		436604
5	2	72.4	5	961.6		800038
6	1	58.8	5			1164144
7	2	72.8	5	1723.2		28791
8	3	86.7	5	1407.3	1824.3	391341
9						
10						
11						
12						
13						
14						
15						
16						
17						
18						
19						
20						

Unless otherwise stated the results shown in this test report refer only to the sample(s) tested and such sample(s) are retained for 90 days only.

除非另有說明，此報告結果僅對測試之樣品負責，同時此樣品僅保留90天。本報告未經本公司書面許可，不可部份複製。

This document is issued by the Company subject to its General Conditions of Service printed overleaf, available on request or accessible at <http://www.sgs.com.tw/Terms-and-Conditions> and for electronic format documents, subject to Terms and Conditions for Electronic Documents at <http://www.sgs.com.tw/Terms-and-Conditions>. Attention is drawn to the limitation of liability, indemnification and jurisdiction issues defined therein. Any holder of this document is advised that information contained hereon reflects the Company's findings at the time of its intervention only and within the limits of Client's instructions, if any. The Company's sole responsibility is to its Client and this document does not exonerate parties to a transaction from exercising all their rights and obligations under the transaction documents. This document cannot be reproduced except in full, without prior written approval of the Company. Any unauthorized alteration, forgery or falsification of the content or appearance of this document is unlawful and offenders may be prosecuted to the fullest extent of the law.

SGS Taiwan Ltd.

No.134,Wu Kung Road, New Taipei Industrial Park, Wuku District, New Taipei City, Taiwan/新北市五股區新北產業園區五工路 134 號

台灣檢驗科技股份有限公司

t (886-2) 2299-3279

f (886-2) 2298-0488

www.sgs.com.tw

Member of SGS Group

Radar Type5_Trial5 for 5320MHz

Data Sheet for FCC Radar Type 5						
Trial Number:			5	VSG Frequency(MHz):		5320
Number of Bursts in Trial:			8	Successful Detection:		Yes
Burst (8-20)	Number Pulses per Burst (1-3)	Pulse Width (50-100)	Chirp Width (5-20)	Pulse 1-to-2 Spacing	Pulse 2-to-3 Spacing	Starting Location Within Interval
		(μ sec)	(MHz)	(μ sec)	(μ sec)	(μ sec)
1	2	71.5	5	1024.5		755079
2	3	88	5	1905	1547	1116130
3	3	89.4	5	1595.6	1232.6	1479179
4	3	97.7	5	1549.3	1090.3	346877
5	1	65.8	5			710997
6	1	61.7	5			1074422
7	2	76.6	5	1387.4		1436084
8	3	96.5	5	1571.5	925.5	302135
9						
10						
11						
12						
13						
14						
15						
16						
17						
18						
19						
20						

Unless otherwise stated the results shown in this test report refer only to the sample(s) tested and such sample(s) are retained for 90 days only.

除非另有說明，此報告結果僅對測試之樣品負責，同時此樣品僅保留90天。本報告未經本公司書面許可，不可部份複製。

This document is issued by the Company subject to its General Conditions of Service printed overleaf, available on request or accessible at <http://www.sgs.com.tw/Terms-and-Conditions> and for electronic format documents, subject to Terms and Conditions for Electronic Documents at <http://www.sgs.com.tw/Terms-and-Conditions>. Attention is drawn to the limitation of liability, indemnification and jurisdiction issues defined therein. Any holder of this document is advised that information contained hereon reflects the Company's findings at the time of its intervention only and within the limits of Client's instructions, if any. The Company's sole responsibility is to its Client and this document does not exonerate parties to a transaction from exercising all their rights and obligations under the transaction documents. This document cannot be reproduced except in full, without prior written approval of the Company. Any unauthorized alteration, forgery or falsification of the content or appearance of this document is unlawful and offenders may be prosecuted to the fullest extent of the law.

Radar Type5_Trial6 for 5320MHz

Data Sheet for FCC Radar Type 5						
Trial Number:			6	VSG Frequency(MHz):		5320
Number of Bursts in Trial:			14	Successful Detection:		Yes
Burst (8-20)	Number Pulses per Burst (1-3)	Pulse Width (50-100)	Chirp Width (5-20)	Pulse 1-to-2 Spacing	Pulse 2-to-3 Spacing	Starting Location Within Interval
		(μ sec)	(MHz)	(μ sec)	(μ sec)	(μ sec)
1	3	97	12	1506	1903	378573
2	3	96.3	12	926.7	1064.7	586348
3	3	86.5	12	1416.5	964.5	793292
4	2	79.6	12	1505.4		146992
5	3	84	12	1459	1858	353209
6	3	85	12	1028	1539	560501
7	2	71	12	1692		767848
8	2	76	12	1081		121542
9	1	57.9	12			329085
10	3	86.7	12	1679.3	1245.3	535068
11	3	88.6	12	1154.4	1637.4	741864
12	2	79.5	12	1696.5		95986
13	3	91.3	12	1797.7	1841.7	302190
14	2	76.8	12	1755.2		510022
15						
16						
17						
18						
19						
20						

Unless otherwise stated the results shown in this test report refer only to the sample(s) tested and such sample(s) are retained for 90 days only.

除非另有說明，此報告結果僅對測試之樣品負責，同時此樣品僅保留90天。本報告未經本公司書面許可，不可部份複製。

This document is issued by the Company subject to its General Conditions of Service printed overleaf, available on request or accessible at <http://www.sgs.com.tw/Terms-and-Conditions> and for electronic format documents, subject to Terms and Conditions for Electronic Documents at <http://www.sgs.com.tw/Terms-and-Conditions>. Attention is drawn to the limitation of liability, indemnification and jurisdiction issues defined therein. Any holder of this document is advised that information contained hereon reflects the Company's findings at the time of its intervention only and within the limits of Client's instructions, if any. The Company's sole responsibility is to its Client and this document does not exonerate parties to a transaction from exercising all their rights and obligations under the transaction documents. This document cannot be reproduced except in full, without prior written approval of the Company. Any unauthorized alteration, forgery or falsification of the content or appearance of this document is unlawful and offenders may be prosecuted to the fullest extent of the law.

Radar Type5_Trial7 for 5320MHz

Data Sheet for FCC Radar Type 5						
Trial Number:			7		VSG Frequency(MHz): 5320	
Number of Bursts in Trial:			13		Successful Detection: Yes	
Burst (8-20)	Number Pulses per Burst (1-3)	Pulse Width (50-100)	Chirp Width (5-20)	Pulse 1-to-2 Spacing	Pulse 2-to-3 Spacing	Starting Location Within Interval
		(μ sec)	(MHz)	(μ sec)	(μ sec)	(μ sec)
1	3	96.4	11	1752.6	1109.6	771194
2	1	51.4	11			76092
3	1	64.8	11			299489
4	1	65.3	11			522832
5	2	75.7	11	1670.3		745337
6	3	85.4	11	1250.6	979.6	48408
7	3	94	11	1772	1352	270970
8	2	68.1	11	1265.9		494746
9	2	81	11	1161		717983
10	3	87.4	11	1328.6	1906.6	20904
11	3	92.8	11	1267.2	1676.2	243688
12	3	88.6	11	1875.4	1638.4	465906
13	2	69.2	11	1282.8		690603
14						
15						
16						
17						
18						
19						
20						

Unless otherwise stated the results shown in this test report refer only to the sample(s) tested and such sample(s) are retained for 90 days only.

除非另有說明，此報告結果僅對測試之樣品負責，同時此樣品僅保留90天。本報告未經本公司書面許可，不可部份複製。

This document is issued by the Company subject to its General Conditions of Service printed overleaf, available on request or accessible at <http://www.sgs.com.tw/Terms-and-Conditions> and for electronic format documents, subject to Terms and Conditions for Electronic Documents at <http://www.sgs.com.tw/Terms-and-Conditions>. Attention is drawn to the limitation of liability, indemnification and jurisdiction issues defined therein. Any holder of this document is advised that information contained hereon reflects the Company's findings at the time of its intervention only and within the limits of Client's instructions, if any. The Company's sole responsibility is to its Client and this document does not exonerate parties to a transaction from exercising all their rights and obligations under the transaction documents. This document cannot be reproduced except in full, without prior written approval of the Company. Any unauthorized alteration, forgery or falsification of the content or appearance of this document is unlawful and offenders may be prosecuted to the fullest extent of the law.

Radar Type5_Trial8 for 5320MHz

Data Sheet for FCC Radar Type 5						
Trial Number:		8		VSG Frequency(MHz):		5320
Number of Bursts in Trial:			11		Successful Detection: Yes	
Burst (8-20)	Number Pulses per Burst (1-3)	Pulse Width (50-100)	Chirp Width (5-20)	Pulse 1-to-2 Spacing	Pulse 2-to-3 Spacing	Starting Location Within Interval
		(μ sec)	(MHz)	(μ sec)	(μ sec)	(μ sec)
1	1	55.7	9			1081971
2	2	71.5	9	1428.5		256209
3	1	50.4	9			520922
4	2	72.7	9	1676.3		783872
5	2	78.8	9	1564.2		1047535
6	3	98	9	1686	1848	223101
7	2	78.1	9	1319.9		487378
8	1	56.6	9			752190
9	3	93.4	9	1339.6	1120.6	1013747
10	3	94.4	9	1471.6	1168.6	190967
11	2	71.9	9	1853.1		454777
12						
13						
14						
15						
16						
17						
18						
19						
20						

Unless otherwise stated the results shown in this test report refer only to the sample(s) tested and such sample(s) are retained for 90 days only.

除非另有說明，此報告結果僅對測試之樣品負責，同時此樣品僅保留90天。本報告未經本公司書面許可，不可部份複製。

This document is issued by the Company subject to its General Conditions of Service printed overleaf, available on request or accessible at <http://www.sgs.com.tw/Terms-and-Conditions> and for electronic format documents, subject to Terms and Conditions for Electronic Documents at <http://www.sgs.com.tw/Terms-and-Conditions>. Attention is drawn to the limitation of liability, indemnification and jurisdiction issues defined therein. Any holder of this document is advised that information contained hereon reflects the Company's findings at the time of its intervention only and within the limits of Client's instructions, if any. The Company's sole responsibility is to its Client and this document does not exonerate parties to a transaction from exercising all their rights and obligations under the transaction documents. This document cannot be reproduced except in full, without prior written approval of the Company. Any unauthorized alteration, forgery or falsification of the content or appearance of this document is unlawful and offenders may be prosecuted to the fullest extent of the law.

SGS Taiwan Ltd.

No.134,Wu Kung Road, New Taipei Industrial Park, Wuku District, New Taipei City, Taiwan/新北市五股區新北產業園區五工路 134 號

台灣檢驗科技股份有限公司

t (886-2) 2299-3279

f (886-2) 2298-0488

www.sgs.com.tw

Member of SGS Group

Radar Type5_Trial9 for 5320MHz

Data Sheet for FCC Radar Type 5						
Trial Number:			9	VSG Frequency(MHz):		5320
Number of Bursts in Trial:			11	Successful Detection:		Yes
Burst (8-20)	Number Pulses per Burst (1-3)	Pulse Width (50-100)	Chirp Width (5-20)	Pulse 1-to-2 Spacing	Pulse 2-to-3 Spacing	Starting Location Within Interval
		(μ sec)	(MHz)	(μ sec)	(μ sec)	(μ sec)
1	3	96.5	8	1238.5	1767.5	717802
2	2	74.9	8	1820.1		982334
3	3	94.7	8	1012.3	1446.3	158509
4	3	94.8	8	1520.2	1653.2	421684
5	1	64.4	8			687423
6	3	85.8	8	960.2	1385.2	949648
7	2	70.2	8	1167.8		126134
8	3	93.3	8	943.7	1289.7	389725
9	3	95.4	8	1101.6	1896.6	652936
10	3	94.7	8	1841.3	1060.3	916384
11	3	91.7	8	1816.3	1181.3	93458
12						
13						
14						
15						
16						
17						
18						
19						
20						

Unless otherwise stated the results shown in this test report refer only to the sample(s) tested and such sample(s) are retained for 90 days only.

除非另有說明，此報告結果僅對測試之樣品負責，同時此樣品僅保留90天。本報告未經本公司書面許可，不可部份複製。

This document is issued by the Company subject to its General Conditions of Service printed overleaf, available on request or accessible at <http://www.sgs.com.tw/Terms-and-Conditions> and for electronic format documents, subject to Terms and Conditions for Electronic Documents at <http://www.sgs.com.tw/Terms-and-Conditions>. Attention is drawn to the limitation of liability, indemnification and jurisdiction issues defined therein. Any holder of this document is advised that information contained hereon reflects the Company's findings at the time of its intervention only and within the limits of Client's instructions, if any. The Company's sole responsibility is to its Client and this document does not exonerate parties to a transaction from exercising all their rights and obligations under the transaction documents. This document cannot be reproduced except in full, without prior written approval of the Company. Any unauthorized alteration, forgery or falsification of the content or appearance of this document is unlawful and offenders may be prosecuted to the fullest extent of the law.

Radar Type5_Trial10 for 5320MHz

Data Sheet for FCC Radar Type 5						
Trial Number:		10		VSG Frequency(MHz):		5320
Number of Bursts in Trial:			20		Successful Detection: Yes	
Burst (8-20)	Number Pulses per Burst (1-3)	Pulse Width (50-100)	Chirp Width (5-20)	Pulse 1-to-2 Spacing	Pulse 2-to-3 Spacing	Starting Location Within Interval
		(μ sec)	(MHz)	(μ sec)	(μ sec)	(μ sec)
1	3	87.9	20	1065.1	1054.1	195845
2	2	82.9	20	1649.1		340735
3	1	50.4	20			487164
4	3	86.1	20	1511.9	1327.9	33463
5	3	91.3	20	1333.7	1629.7	177985
6	1	52.4	20			324139
7	2	78.8	20	964.2		468273
8	1	65.2	20			15748
9	3	99.2	20	1105.8	1472.8	160137
10	3	86.9	20	1715.1	1671.1	304464
11	3	95.4	20	1764.6	1171.6	448919
12	1	65.8	20			596028
13	1	65.2	20			142978
14	1	54.5	20			287964
15	1	57.4	20			433443
16	1	64	20			578958
17	1	59.8	20			125123
18	2	81.5	20	1113.5		269660
19	1	63.1	20			415298
20	2	70.1	20	1113.9		559053

Unless otherwise stated the results shown in this test report refer only to the sample(s) tested and such sample(s) are retained for 90 days only.

除非另有說明，此報告結果僅對測試之樣品負責，同時此樣品僅保留90天。本報告未經本公司書面許可，不可部份複製。

This document is issued by the Company subject to its General Conditions of Service printed overleaf, available on request or accessible at <http://www.sgs.com.tw/Terms-and-Conditions> and for electronic format documents, subject to Terms and Conditions for Electronic Documents at <http://www.sgs.com.tw/Terms-and-Conditions>. Attention is drawn to the limitation of liability, indemnification and jurisdiction issues defined therein. Any holder of this document is advised that information contained hereon reflects the Company's findings at the time of its intervention only and within the limits of Client's instructions, if any. The Company's sole responsibility is to its Client and this document does not exonerate parties to a transaction from exercising all their rights and obligations under the transaction documents. This document cannot be reproduced except in full, without prior written approval of the Company. Any unauthorized alteration, forgery or falsification of the content or appearance of this document is unlawful and offenders may be prosecuted to the fullest extent of the law.

Radar Type5_Trial11 for 5320MHz

Data Sheet for FCC Radar Type 5						
Trial Number:		11		VSG Frequency(MHz):		5315.6695
Number of Bursts in Trial:			15		Successful Detection: Yes	
Burst (8-20)	Number Pulses per Burst (1-3)	Pulse Width (50-100)	Chirp Width (5-20)	Pulse 1-to-2 Spacing	Pulse 2-to-3 Spacing	Starting Location Within Interval
		(μ sec)	(MHz)	(μ sec)	(μ sec)	(μ sec)
1	1	52.9	13			143103
2	1	57	13			336633
3	3	93	13	1786	1375	528454
4	2	68.8	13	1796.2		722576
5	1	50.7	13			119259
6	3	90.7	13	1150.3	1478.3	311911
7	3	99.3	13	1551.7	1326.7	504351
8	1	53.6	13			700354
9	3	95.3	13	1600.7	1466.7	95028
10	2	67.1	13	1419.9		288667
11	3	99.5	13	1883.5	1753.5	480592
12	3	93.2	13	1087.8	1551.8	673584
13	2	74.5	13	1562.5		71396
14	1	64.1	13			265211
15	3	83.6	13	1622.4	1038.4	457007
16						
17						
18						
19						
20						

Unless otherwise stated the results shown in this test report refer only to the sample(s) tested and such sample(s) are retained for 90 days only.

除非另有說明，此報告結果僅對測試之樣品負責，同時此樣品僅保留90天。本報告未經本公司書面許可，不可部份複製。

This document is issued by the Company subject to its General Conditions of Service printed overleaf, available on request or accessible at <http://www.sgs.com.tw/Terms-and-Conditions> and for electronic format documents, subject to Terms and Conditions for Electronic Documents at <http://www.sgs.com.tw/Terms-and-Conditions>. Attention is drawn to the limitation of liability, indemnification and jurisdiction issues defined therein. Any holder of this document is advised that information contained hereon reflects the Company's findings at the time of its intervention only and within the limits of Client's instructions, if any. The Company's sole responsibility is to its Client and this document does not exonerate parties to a transaction from exercising all their rights and obligations under the transaction documents. This document cannot be reproduced except in full, without prior written approval of the Company. Any unauthorized alteration, forgery or falsification of the content or appearance of this document is unlawful and offenders may be prosecuted to the fullest extent of the law.

Radar Type5_Trial12 for 5320MHz

Data Sheet for FCC Radar Type 5						
Trial Number:		12		VSG Frequency(MHz):		5313.6695
Number of Bursts in Trial:			10		Successful Detection: Yes	
Burst (8-20)	Number Pulses per Burst (1-3)	Pulse Width (50-100)	Chirp Width (5-20)	Pulse 1-to-2 Spacing	Pulse 2-to-3 Spacing	Starting Location Within Interval
		(μ sec)	(MHz)	(μ sec)	(μ sec)	(μ sec)
1	2	67.5	8	1366.5		978633
2	2	72.3	8	1722.7		71453
3	3	92.8	8	1745.2	1601.2	361200
4	1	56.7	8			653086
5	2	75.7	8	1346.3		942117
6	2	77.9	8	1602.1		35724
7	2	78.1	8	933.9		326175
8	3	95.3	8	1766.7	1165.7	615613
9	3	85.1	8	1363.9	1704.9	905273
10	1	51.1	8			1198252
11						
12						
13						
14						
15						
16						
17						
18						
19						
20						

Unless otherwise stated the results shown in this test report refer only to the sample(s) tested and such sample(s) are retained for 90 days only.

除非另有說明，此報告結果僅對測試之樣品負責，同時此樣品僅保留90天。本報告未經本公司書面許可，不可部份複製。

This document is issued by the Company subject to its General Conditions of Service printed overleaf, available on request or accessible at <http://www.sgs.com.tw/Terms-and-Conditions> and for electronic format documents, subject to Terms and Conditions for Electronic Documents at <http://www.sgs.com.tw/Terms-and-Conditions>. Attention is drawn to the limitation of liability, indemnification and jurisdiction issues defined therein. Any holder of this document is advised that information contained hereon reflects the Company's findings at the time of its intervention only and within the limits of Client's instructions, if any. The Company's sole responsibility is to its Client and this document does not exonerate parties to a transaction from exercising all their rights and obligations under the transaction documents. This document cannot be reproduced except in full, without prior written approval of the Company. Any unauthorized alteration, forgery or falsification of the content or appearance of this document is unlawful and offenders may be prosecuted to the fullest extent of the law.

SGS Taiwan Ltd.

No.134,Wu Kung Road, New Taipei Industrial Park, Wuku District, New Taipei City, Taiwan/新北市五股區新北產業園區五工路 134 號

台灣檢驗科技股份有限公司

t (886-2) 2299-3279

f (886-2) 2298-0488

www.sgs.com.tw

Member of SGS Group

Radar Type5_Trial13 for 5320MHz

Data Sheet for FCC Radar Type 5						
Trial Number:		13		VSG Frequency(MHz):		5316.8695
Number of Bursts in Trial:			17		Successful Detection: Yes	
Burst (8-20)	Number Pulses per Burst (1-3)	Pulse Width (50-100)	Chirp Width (5-20)	Pulse 1-to-2 Spacing	Pulse 2-to-3 Spacing	Starting Location Within Interval
		(μ sec)	(MHz)	(μ sec)	(μ sec)	(μ sec)
1	1	59	16			170817
2	2	79.5	16	990.5		341357
3	3	90.3	16	1075.7	1220.7	510526
4	1	57	16			683467
5	2	71.8	16	1218.2		149404
6	1	60.4	16			320410
7	1	61.8	16			491519
8	2	82.3	16	1727.7		660636
9	2	74.5	16	1601.5		128495
10	3	88.7	16	975.3	1412.3	298307
11	2	80.8	16	1746.2		469475
12	3	90	16	1030	1551	638300
13	2	81.6	16	1088.4		107469
14	3	85.3	16	1827.7	1324.7	277145
15	1	50.6	16			449387
16	1	53.2	16			620125
17	2	75.1	16	1843.9		86364
18						
19						
20						

Unless otherwise stated the results shown in this test report refer only to the sample(s) tested and such sample(s) are retained for 90 days only.

除非另有說明，此報告結果僅對測試之樣品負責，同時此樣品僅保留90天。本報告未經本公司書面許可，不可部份複製。

This document is issued by the Company subject to its General Conditions of Service printed overleaf, available on request or accessible at <http://www.sgs.com.tw/Terms-and-Conditions> and for electronic format documents, subject to Terms and Conditions for Electronic Documents at <http://www.sgs.com.tw/Terms-and-Conditions>. Attention is drawn to the limitation of liability, indemnification and jurisdiction issues defined therein. Any holder of this document is advised that information contained hereon reflects the Company's findings at the time of its intervention only and within the limits of Client's instructions, if any. The Company's sole responsibility is to its Client and this document does not exonerate parties to a transaction from exercising all their rights and obligations under the transaction documents. This document cannot be reproduced except in full, without prior written approval of the Company. Any unauthorized alteration, forgery or falsification of the content or appearance of this document is unlawful and offenders may be prosecuted to the fullest extent of the law.

SGS Taiwan Ltd.

No.134,Wu Kung Road, New Taipei Industrial Park, Wuku District, New Taipei City, Taiwan/新北市五股區新北產業園區五工路 134 號

台灣檢驗科技股份有限公司

t (886-2) 2299-3279

f (886-2) 2298-0488

www.sgs.com.tw

Member of SGS Group

Radar Type5_Trial14 for 5320MHz

Data Sheet for FCC Radar Type 5						
Trial Number:		14		VSG Frequency(MHz):		5318.4695
Number of Bursts in Trial:			20		Successful Detection: Yes	
Burst (8-20)	Number Pulses per Burst (1-3)	Pulse Width (50-100)	Chirp Width (5-20)	Pulse 1-to-2 Spacing	Pulse 2-to-3 Spacing	Starting Location Within Interval
		(μ sec)	(MHz)	(μ sec)	(μ sec)	(μ sec)
1	2	70	20	1015		218197
2	2	82	20	1063		363178
3	3	87.4	20	1016.6	1573.6	506900
4	1	52.2	20			55765
5	3	91.3	20	1392.7	1490.7	199823
6	1	51	20			346092
7	2	70.9	20	1197.1		490061
8	3	89.9	20	1240.1	1198.1	37702
9	3	91.8	20	1314.2	999.2	182230
10	2	67.1	20	1850.9		326990
11	2	74.7	20	1018.3		472340
12	3	87.5	20	916.5	1912.5	19883
13	3	92.3	20	1126.7	1650.7	164207
14	2	74.8	20	1634.2		309633
15	1	61.7	20			455707
16	1	57.8	20			2102
17	2	67.7	20	1674.3		146931
18	3	91.8	20	1452.2	1631.2	290728
19	1	61.1	20			437450
20	1	58.9	20			582293

Unless otherwise stated the results shown in this test report refer only to the sample(s) tested and such sample(s) are retained for 90 days only.

除非另有說明，此報告結果僅對測試之樣品負責，同時此樣品僅保留90天。本報告未經本公司書面許可，不可部份複製。

This document is issued by the Company subject to its General Conditions of Service printed overleaf, available on request or accessible at <http://www.sgs.com.tw/Terms-and-Conditions> and for electronic format documents, subject to Terms and Conditions for Electronic Documents at <http://www.sgs.com.tw/Terms-and-Conditions>. Attention is drawn to the limitation of liability, indemnification and jurisdiction issues defined therein. Any holder of this document is advised that information contained hereon reflects the Company's findings at the time of its intervention only and within the limits of Client's instructions, if any. The Company's sole responsibility is to its Client and this document does not exonerate parties to a transaction from exercising all their rights and obligations under the transaction documents. This document cannot be reproduced except in full, without prior written approval of the Company. Any unauthorized alteration, forgery or falsification of the content or appearance of this document is unlawful and offenders may be prosecuted to the fullest extent of the law.

SGS Taiwan Ltd.

No.134,Wu Kung Road, New Taipei Industrial Park, Wuku District, New Taipei City, Taiwan/新北市五股區新北產業園區五工路 134 號

台灣檢驗科技股份有限公司

t (886-2) 2299-3279

f (886-2) 2298-0488

www.sgs.com.tw

Member of SGS Group

Radar Type5_Trial15 for 5320MHz

Data Sheet for FCC Radar Type 5						
Trial Number:		15		VSG Frequency(MHz):		5316.4695
Number of Bursts in Trial:			16		Successful Detection: Yes	
Burst (8-20)	Number Pulses per Burst (1-3)	Pulse Width (50-100)	Chirp Width (5-20)	Pulse 1-to-2 Spacing	Pulse 2-to-3 Spacing	Starting Location Within Interval
		(μ sec)	(MHz)	(μ sec)	(μ sec)	(μ sec)
1	3	96.7	15	1581.3	1271.3	161051
2	2	73.5	15	1917.5		342354
3	1	56.7	15			524731
4	3	87.7	15	1898.3	1496.3	703120
5	1	60.8	15			139360
6	3	100	15	1513	1072	319792
7	2	75.5	15	1704.5		501115
8	1	52.7	15			683650
9	2	77.6	15	1511.4		116904
10	3	90.7	15	1515.3	1368.3	297489
11	1	57.4	15			480050
12	1	56.1	15			661425
13	2	72.5	15	1240.5		94607
14	1	52.8	15			276358
15	1	58.1	15			458076
16	1	63.3	15			639282
17						
18						
19						
20						

Unless otherwise stated the results shown in this test report refer only to the sample(s) tested and such sample(s) are retained for 90 days only.

除非另有說明，此報告結果僅對測試之樣品負責，同時此樣品僅保留90天。本報告未經本公司書面許可，不可部份複製。

This document is issued by the Company subject to its General Conditions of Service printed overleaf, available on request or accessible at <http://www.sgs.com.tw/Terms-and-Conditions> and for electronic format documents, subject to Terms and Conditions for Electronic Documents at <http://www.sgs.com.tw/Terms-and-Conditions>. Attention is drawn to the limitation of liability, indemnification and jurisdiction issues defined therein. Any holder of this document is advised that information contained hereon reflects the Company's findings at the time of its intervention only and within the limits of Client's instructions, if any. The Company's sole responsibility is to its Client and this document does not exonerate parties to a transaction from exercising all their rights and obligations under the transaction documents. This document cannot be reproduced except in full, without prior written approval of the Company. Any unauthorized alteration, forgery or falsification of the content or appearance of this document is unlawful and offenders may be prosecuted to the fullest extent of the law.

Radar Type5_Trial16 for 5320MHz

Data Sheet for FCC Radar Type 5						
Trial Number:		16		VSG Frequency(MHz):		5318.0695
Number of Bursts in Trial:			19		Successful Detection: Yes	
Burst (8-20)	Number Pulses per Burst (1-3)	Pulse Width (50-100)	Chirp Width (5-20)	Pulse 1-to-2 Spacing	Pulse 2-to-3 Spacing	Starting Location Within Interval
		(μ sec)	(MHz)	(μ sec)	(μ sec)	(μ sec)
1	3	97.8	19	1035.2	1109.2	60664
2	3	98.9	19	1349.1	1179.1	212758
3	2	67.7	19	1877.3		365185
4	2	78.4	19	1897.6		517638
5	2	69.3	19	1353.7		42020
6	2	67.1	19	1256.9		194546
7	2	80.1	19	1704.9		346961
8	3	93.4	19	935.6	1527.6	498702
9	3	87.1	19	1769.9	1303.9	23150
10	3	94.9	19	1043.1	1752.1	175148
11	2	82.3	19	1429.7		328193
12	1	63.8	19			481836
13	2	69	19	1717		4428
14	2	82.1	19	1509.9		156800
15	1	63.9	19			310290
16	3	93.6	19	1131.4	1715.4	460941
17	3	89.5	19	1035.5	927.5	613436
18	3	94.3	19	1285.7	1082.7	137818
19	2	78.4	19	1681.6		290315
20						

Unless otherwise stated the results shown in this test report refer only to the sample(s) tested and such sample(s) are retained for 90 days only.

除非另有說明，此報告結果僅對測試之樣品負責，同時此樣品僅保留90天。本報告未經本公司書面許可，不可部份複製。

This document is issued by the Company subject to its General Conditions of Service printed overleaf, available on request or accessible at <http://www.sgs.com.tw/Terms-and-Conditions> and for electronic format documents, subject to Terms and Conditions for Electronic Documents at <http://www.sgs.com.tw/Terms-and-Conditions>. Attention is drawn to the limitation of liability, indemnification and jurisdiction issues defined therein. Any holder of this document is advised that information contained hereon reflects the Company's findings at the time of its intervention only and within the limits of Client's instructions, if any. The Company's sole responsibility is to its Client and this document does not exonerate parties to a transaction from exercising all their rights and obligations under the transaction documents. This document cannot be reproduced except in full, without prior written approval of the Company. Any unauthorized alteration, forgery or falsification of the content or appearance of this document is unlawful and offenders may be prosecuted to the fullest extent of the law.

Radar Type5_Trial17 for 5320MHz

Data Sheet for FCC Radar Type 5						
Trial Number:		17		VSG Frequency(MHz):		5313.2695
Number of Bursts in Trial:			10		Successful Detection: Yes	
Burst (8-20)	Number Pulses per Burst (1-3)	Pulse Width (50-100)	Chirp Width (5-20)	Pulse 1-to-2 Spacing	Pulse 2-to-3 Spacing	Starting Location Within Interval
		(μ sec)	(MHz)	(μ sec)	(μ sec)	(μ sec)
1	3	96.6	7	1648.4	1865.4	841832
2	2	75.3	7	1301.7		1134370
3	3	99.8	7	1691.2	928.2	226986
4	3	91.4	7	1351.6	1845.6	516768
5	3	91.3	7	1507.7	1109.7	806793
6	2	75.6	7	1497.4		1097643
7	2	68.2	7	1628.8		191388
8	1	62.3	7			482197
9	1	51	7			773239
10	1	59.6	7			1063311
11						
12						
13						
14						
15						
16						
17						
18						
19						
20						

Unless otherwise stated the results shown in this test report refer only to the sample(s) tested and such sample(s) are retained for 90 days only.

除非另有說明，此報告結果僅對測試之樣品負責，同時此樣品僅保留90天。本報告未經本公司書面許可，不可部份複製。

This document is issued by the Company subject to its General Conditions of Service printed overleaf, available on request or accessible at <http://www.sgs.com.tw/Terms-and-Conditions> and for electronic format documents, subject to Terms and Conditions for Electronic Documents at <http://www.sgs.com.tw/Terms-and-Conditions>. Attention is drawn to the limitation of liability, indemnification and jurisdiction issues defined therein. Any holder of this document is advised that information contained hereon reflects the Company's findings at the time of its intervention only and within the limits of Client's instructions, if any. The Company's sole responsibility is to its Client and this document does not exonerate parties to a transaction from exercising all their rights and obligations under the transaction documents. This document cannot be reproduced except in full, without prior written approval of the Company. Any unauthorized alteration, forgery or falsification of the content or appearance of this document is unlawful and offenders may be prosecuted to the fullest extent of the law.

Radar Type5_Trial18 for 5320MHz

Data Sheet for FCC Radar Type 5						
Trial Number:		18		VSG Frequency(MHz):		5315.6695
Number of Bursts in Trial:			14		Successful Detection: Yes	
Burst (8-20)	Number Pulses per Burst (1-3)	Pulse Width (50-100)	Chirp Width (5-20)	Pulse 1-to-2 Spacing	Pulse 2-to-3 Spacing	Starting Location Within Interval
		(μ sec)	(MHz)	(μ sec)	(μ sec)	(μ sec)
1	2	68.6	13	1499.4		111159
2	1	64.9	13			318639
3	3	89.4	13	1225.6	1206.6	525016
4	2	66.7	13	1407.3		732895
5	3	98.5	13	1094.5	1290.5	85461
6	1	60.1	13			293098
7	2	68.9	13	1207.1		499889
8	2	74	13	1650		706709
9	2	82.7	13	937.3		60119
10	3	89.7	13	913.3	1511.3	266981
11	2	79.6	13	1323.4		474208
12	3	93.4	13	1709.6	922.6	680794
13	1	63.3	13			34618
14	1	50.5	13			242067
15						
16						
17						
18						
19						
20						

Unless otherwise stated the results shown in this test report refer only to the sample(s) tested and such sample(s) are retained for 90 days only.

除非另有說明，此報告結果僅對測試之樣品負責，同時此樣品僅保留90天。本報告未經本公司書面許可，不可部份複製。

This document is issued by the Company subject to its General Conditions of Service printed overleaf, available on request or accessible at <http://www.sgs.com.tw/Terms-and-Conditions> and for electronic format documents, subject to Terms and Conditions for Electronic Documents at <http://www.sgs.com.tw/Terms-and-Conditions>. Attention is drawn to the limitation of liability, indemnification and jurisdiction issues defined therein. Any holder of this document is advised that information contained hereon reflects the Company's findings at the time of its intervention only and within the limits of Client's instructions, if any. The Company's sole responsibility is to its Client and this document does not exonerate parties to a transaction from exercising all their rights and obligations under the transaction documents. This document cannot be reproduced except in full, without prior written approval of the Company. Any unauthorized alteration, forgery or falsification of the content or appearance of this document is unlawful and offenders may be prosecuted to the fullest extent of the law.

Radar Type5_Trial19 for 5320MHz

Data Sheet for FCC Radar Type 5						
Trial Number:		19		VSG Frequency(MHz):		5314.0695
Number of Bursts in Trial:			11		Successful Detection: Yes	
Burst (8-20)	Number Pulses per Burst (1-3)	Pulse Width (50-100)	Chirp Width (5-20)	Pulse 1-to-2 Spacing	Pulse 2-to-3 Spacing	Starting Location Within Interval
		(μ sec)	(MHz)	(μ sec)	(μ sec)	(μ sec)
1	1	66	9			572486
2	2	67.7	9	1512.3		835382
3	1	61.6	9			11536
4	3	83.7	9	963.3	1336.3	275055
5	3	95.5	9	1832.5	1354.5	538089
6	2	76.8	9	1049.2		803017
7	1	63.9	9			1068197
8	2	66.7	9	1203.3		242891
9	2	78.3	9	998.7		507034
10	2	74.4	9	1755.6		770438
11	1	61.5	9			1035902
12						
13						
14						
15						
16						
17						
18						
19						
20						

Unless otherwise stated the results shown in this test report refer only to the sample(s) tested and such sample(s) are retained for 90 days only.

除非另有說明，此報告結果僅對測試之樣品負責，同時此樣品僅保留90天。本報告未經本公司書面許可，不可部份複製。

This document is issued by the Company subject to its General Conditions of Service printed overleaf, available on request or accessible at <http://www.sgs.com.tw/Terms-and-Conditions> and for electronic format documents, subject to Terms and Conditions for Electronic Documents at <http://www.sgs.com.tw/Terms-and-Conditions>. Attention is drawn to the limitation of liability, indemnification and jurisdiction issues defined therein. Any holder of this document is advised that information contained hereon reflects the Company's findings at the time of its intervention only and within the limits of Client's instructions, if any. The Company's sole responsibility is to its Client and this document does not exonerate parties to a transaction from exercising all their rights and obligations under the transaction documents. This document cannot be reproduced except in full, without prior written approval of the Company. Any unauthorized alteration, forgery or falsification of the content or appearance of this document is unlawful and offenders may be prosecuted to the fullest extent of the law.

SGS Taiwan Ltd.

No.134,Wu Kung Road, New Taipei Industrial Park, Wuku District, New Taipei City, Taiwan/新北市五股區新北產業園區五工路 134 號

台灣檢驗科技股份有限公司

t (886-2) 2299-3279

f (886-2) 2298-0488

www.sgs.com.tw

Member of SGS Group

Radar Type5_Trial20 for 5320MHz

Data Sheet for FCC Radar Type 5						
Trial Number:		20		VSG Frequency(MHz):		5316.8695
Number of Bursts in Trial:			17		Successful Detection: Yes	
Burst (8-20)	Number Pulses per Burst (1-3)	Pulse Width (50-100)	Chirp Width (5-20)	Pulse 1-to-2 Spacing	Pulse 2-to-3 Spacing	Starting Location Within Interval
		(μ sec)	(MHz)	(μ sec)	(μ sec)	(μ sec)
1	3	88	16	1256	919	135783
2	3	98	16	1506	1371	305527
3	1	57.4	16			478186
4	2	76.4	16	1773.6		646724
5	1	52.8	16			115148
6	1	51	16			285926
7	1	54.8	16			456935
8	2	79	16	1222		626758
9	3	83.8	16	1125.2	1487.2	93692
10	2	68.5	16	1802.5		264129
11	2	79.9	16	1904.1		434598
12	3	92.9	16	1398.1	1123.1	604219
13	3	97.1	16	1045.9	1166.9	72856
14	2	70.6	16	1757.4		243445
15	2	72	16	1359		413877
16	3	95	16	1255	1652	582964
17	2	69.5	16	1837.5		51895
18						
19						
20						

Unless otherwise stated the results shown in this test report refer only to the sample(s) tested and such sample(s) are retained for 90 days only.

除非另有說明，此報告結果僅對測試之樣品負責，同時此樣品僅保留90天。本報告未經本公司書面許可，不可部份複製。

This document is issued by the Company subject to its General Conditions of Service printed overleaf, available on request or accessible at <http://www.sgs.com.tw/Terms-and-Conditions> and for electronic format documents, subject to Terms and Conditions for Electronic Documents at <http://www.sgs.com.tw/Terms-and-Conditions>. Attention is drawn to the limitation of liability, indemnification and jurisdiction issues defined therein. Any holder of this document is advised that information contained hereon reflects the Company's findings at the time of its intervention only and within the limits of Client's instructions, if any. The Company's sole responsibility is to its Client and this document does not exonerate parties to a transaction from exercising all their rights and obligations under the transaction documents. This document cannot be reproduced except in full, without prior written approval of the Company. Any unauthorized alteration, forgery or falsification of the content or appearance of this document is unlawful and offenders may be prosecuted to the fullest extent of the law.

Radar Type5_Trial21 for 5320MHz

Data Sheet for FCC Radar Type 5						
Trial Number:		21		VSG Frequency(MHz):		5327.1305
Number of Bursts in Trial:			9		Successful Detection: Yes	
Burst (8-20)	Number Pulses per Burst (1-3)	Pulse Width (50-100)	Chirp Width (5-20)	Pulse 1-to-2 Spacing	Pulse 2-to-3 Spacing	Starting Location Within Interval
		(μ sec)	(MHz)	(μ sec)	(μ sec)	(μ sec)
1	1	56.7	6			421551
2	1	54.5	6			744478
3	3	98.9	6	1286.1	1719.1	1064529
4	1	53.1	6			58608
5	1	61.9	6			381621
6	3	99.2	6	1156.8	1217.8	703403
7	2	75.4	6	1653.6		1026298
8	2	73.6	6	1185.4		18794
9	1	64	6			341945
10						
11						
12						
13						
14						
15						
16						
17						
18						
19						
20						

Unless otherwise stated the results shown in this test report refer only to the sample(s) tested and such sample(s) are retained for 90 days only.

除非另有說明，此報告結果僅對測試之樣品負責，同時此樣品僅保留90天。本報告未經本公司書面許可，不可部份複製。

This document is issued by the Company subject to its General Conditions of Service printed overleaf, available on request or accessible at <http://www.sgs.com.tw/Terms-and-Conditions> and for electronic format documents, subject to Terms and Conditions for Electronic Documents at <http://www.sgs.com.tw/Terms-and-Conditions>. Attention is drawn to the limitation of liability, indemnification and jurisdiction issues defined therein. Any holder of this document is advised that information contained hereon reflects the Company's findings at the time of its intervention only and within the limits of Client's instructions, if any. The Company's sole responsibility is to its Client and this document does not exonerate parties to a transaction from exercising all their rights and obligations under the transaction documents. This document cannot be reproduced except in full, without prior written approval of the Company. Any unauthorized alteration, forgery or falsification of the content or appearance of this document is unlawful and offenders may be prosecuted to the fullest extent of the law.

Radar Type5_Trial22 for 5320MHz

Data Sheet for FCC Radar Type 5						
Trial Number:		22		VSG Frequency(MHz):		5324.3305
Number of Bursts in Trial:			14		Successful Detection: Yes	
Burst (8-20)	Number Pulses per Burst (1-3)	Pulse Width (50-100)	Chirp Width (5-20)	Pulse 1-to-2 Spacing	Pulse 2-to-3 Spacing	Starting Location Within Interval
		(μ sec)	(MHz)	(μ sec)	(μ sec)	(μ sec)
1	3	84.5	13	1021.5	1628.5	425699
2	2	66.8	13	1144.2		633700
3	2	74.3	13	1140.7		840682
4	3	95.7	13	904.3	958.3	193640
5	1	51.9	13			401335
6	3	86.7	13	1253.3	1160.3	607151
7	1	64.9	13			816306
8	1	55.2	13			168523
9	1	60.5	13			376178
10	1	62.1	13			583300
11	1	61.4	13			791044
12	3	97.6	13	1516.4	1265.4	142362
13	2	79.9	13	1880.1		349568
14	3	88.6	13	1675.4	1030.4	556281
15						
16						
17						
18						
19						
20						

Unless otherwise stated the results shown in this test report refer only to the sample(s) tested and such sample(s) are retained for 90 days only.

除非另有說明，此報告結果僅對測試之樣品負責，同時此樣品僅保留90天。本報告未經本公司書面許可，不可部份複製。

This document is issued by the Company subject to its General Conditions of Service printed overleaf, available on request or accessible at <http://www.sgs.com.tw/Terms-and-Conditions> and for electronic format documents, subject to Terms and Conditions for Electronic Documents at <http://www.sgs.com.tw/Terms-and-Conditions>. Attention is drawn to the limitation of liability, indemnification and jurisdiction issues defined therein. Any holder of this document is advised that information contained hereon reflects the Company's findings at the time of its intervention only and within the limits of Client's instructions, if any. The Company's sole responsibility is to its Client and this document does not exonerate parties to a transaction from exercising all their rights and obligations under the transaction documents. This document cannot be reproduced except in full, without prior written approval of the Company. Any unauthorized alteration, forgery or falsification of the content or appearance of this document is unlawful and offenders may be prosecuted to the fullest extent of the law.

Radar Type5_Trial23 for 5320MHz

Data Sheet for FCC Radar Type 5						
Trial Number:		23		VSG Frequency(MHz):		5323.9305
Number of Bursts in Trial:			15		Successful Detection: Yes	
Burst (8-20)	Number Pulses per Burst (1-3)	Pulse Width (50-100)	Chirp Width (5-20)	Pulse 1-to-2 Spacing	Pulse 2-to-3 Spacing	Starting Location Within Interval
		(μ sec)	(MHz)	(μ sec)	(μ sec)	(μ sec)
1	2	74.8	14	1903.2		712954
2	1	64.4	14			109577
3	2	79.6	14	947.4		302690
4	2	82.1	14	1141.9		496146
5	3	86.2	14	1236.8	989.8	688037
6	2	74.8	14	1243.2		85509
7	1	64.5	14			279236
8	1	63.1	14			472748
9	2	73.5	14	1362.5		665464
10	2	81.8	14	1385.2		61664
11	3	94.4	14	1855.6	961.6	254652
12	1	59.9	14			449055
13	2	73.7	14	1136.3		641555
14	2	75.6	14	1761.4		37890
15	1	58.4	14			231571
16						
17						
18						
19						
20						

Unless otherwise stated the results shown in this test report refer only to the sample(s) tested and such sample(s) are retained for 90 days only.

除非另有說明，此報告結果僅對測試之樣品負責，同時此樣品僅保留90天。本報告未經本公司書面許可，不可部份複製。

This document is issued by the Company subject to its General Conditions of Service printed overleaf, available on request or accessible at <http://www.sgs.com.tw/Terms-and-Conditions> and for electronic format documents, subject to Terms and Conditions for Electronic Documents at <http://www.sgs.com.tw/Terms-and-Conditions>. Attention is drawn to the limitation of liability, indemnification and jurisdiction issues defined therein. Any holder of this document is advised that information contained hereon reflects the Company's findings at the time of its intervention only and within the limits of Client's instructions, if any. The Company's sole responsibility is to its Client and this document does not exonerate parties to a transaction from exercising all their rights and obligations under the transaction documents. This document cannot be reproduced except in full, without prior written approval of the Company. Any unauthorized alteration, forgery or falsification of the content or appearance of this document is unlawful and offenders may be prosecuted to the fullest extent of the law.

Radar Type5_Trial24 for 5320MHz

Data Sheet for FCC Radar Type 5						
Trial Number:		24		VSG Frequency(MHz):		5327.1305
Number of Bursts in Trial:			9		Successful Detection: Yes	
Burst (8-20)	Number Pulses per Burst (1-3)	Pulse Width (50-100)	Chirp Width (5-20)	Pulse 1-to-2 Spacing	Pulse 2-to-3 Spacing	Starting Location Within Interval
		(μ sec)	(MHz)	(μ sec)	(μ sec)	(μ sec)
1	2	76.1	6	1613.9		708682
2	3	98.8	6	973.2	1563.2	1030464
3	2	82.1	6	1484.9		23490
4	1	52.8	6			346421
5	3	88.9	6	1759.1	1530.1	667789
6	1	66.6	6			992268
7	3	88	6	1717	1899	1311409
8	1	54.6	6			306766
9	3	88.1	6	1901.9	1340.9	628217
10						
11						
12						
13						
14						
15						
16						
17						
18						
19						
20						

Unless otherwise stated the results shown in this test report refer only to the sample(s) tested and such sample(s) are retained for 90 days only.

除非另有說明，此報告結果僅對測試之樣品負責，同時此樣品僅保留90天。本報告未經本公司書面許可，不可部份複製。

This document is issued by the Company subject to its General Conditions of Service printed overleaf, available on request or accessible at <http://www.sgs.com.tw/Terms-and-Conditions> and for electronic format documents, subject to Terms and Conditions for Electronic Documents at <http://www.sgs.com.tw/Terms-and-Conditions>. Attention is drawn to the limitation of liability, indemnification and jurisdiction issues defined therein. Any holder of this document is advised that information contained hereon reflects the Company's findings at the time of its intervention only and within the limits of Client's instructions, if any. The Company's sole responsibility is to its Client and this document does not exonerate parties to a transaction from exercising all their rights and obligations under the transaction documents. This document cannot be reproduced except in full, without prior written approval of the Company. Any unauthorized alteration, forgery or falsification of the content or appearance of this document is unlawful and offenders may be prosecuted to the fullest extent of the law.

Radar Type5_Trial25 for 5320MHz

Data Sheet for FCC Radar Type 5						
Trial Number:		25		VSG Frequency(MHz):		5325.5305
Number of Bursts in Trial:			12		Successful Detection: Yes	
Burst (8-20)	Number Pulses per Burst (1-3)	Pulse Width (50-100)	Chirp Width (5-20)	Pulse 1-to-2 Spacing	Pulse 2-to-3 Spacing	Starting Location Within Interval
		(μ sec)	(MHz)	(μ sec)	(μ sec)	(μ sec)
1	1	66.5	10			713981
2	3	93.2	10	1318.8	1383.8	954060
3	2	77.9	10	1604.1		199837
4	3	91.9	10	1294.1	1759.1	440713
5	1	60	10			684224
6	1	59.8	10			926991
7	3	83.6	10	1361.4	1524.4	169870
8	2	72	10	1008		411973
9	2	76.9	10	1546.1		653647
10	1	65.9	10			896784
11	2	74	10	1743		140278
12	3	88.8	10	1123.2	978.2	381664
13						
14						
15						
16						
17						
18						
19						
20						

Unless otherwise stated the results shown in this test report refer only to the sample(s) tested and such sample(s) are retained for 90 days only.

除非另有說明，此報告結果僅對測試之樣品負責，同時此樣品僅保留90天。本報告未經本公司書面許可，不可部份複製。

This document is issued by the Company subject to its General Conditions of Service printed overleaf, available on request or accessible at <http://www.sgs.com.tw/Terms-and-Conditions> and for electronic format documents, subject to Terms and Conditions for Electronic Documents at <http://www.sgs.com.tw/Terms-and-Conditions>. Attention is drawn to the limitation of liability, indemnification and jurisdiction issues defined therein. Any holder of this document is advised that information contained hereon reflects the Company's findings at the time of its intervention only and within the limits of Client's instructions, if any. The Company's sole responsibility is to its Client and this document does not exonerate parties to a transaction from exercising all their rights and obligations under the transaction documents. This document cannot be reproduced except in full, without prior written approval of the Company. Any unauthorized alteration, forgery or falsification of the content or appearance of this document is unlawful and offenders may be prosecuted to the fullest extent of the law.

Radar Type5_Trial26 for 5320MHz

Data Sheet for FCC Radar Type 5						
Trial Number:		26		VSG Frequency(MHz):		5323.9305
Number of Bursts in Trial:			15		Successful Detection: Yes	
Burst (8-20)	Number Pulses per Burst (1-3)	Pulse Width (50-100)	Chirp Width (5-20)	Pulse 1-to-2 Spacing	Pulse 2-to-3 Spacing	Starting Location Within Interval
		(μ sec)	(MHz)	(μ sec)	(μ sec)	(μ sec)
1	2	82.4	14	1229.6		498536
2	2	67.1	14	1773.9		692019
3	3	89.3	14	1756.7	1617.7	88107
4	3	98.9	14	1600.1	1443.1	281127
5	3	99.5	14	1867.5	1028.5	474098
6	2	71.4	14	1023.6		668574
7	3	93.3	14	1751.7	1007.7	64396
8	3	92.6	14	1705.4	1299.4	257232
9	1	51.2	14			451923
10	3	92	14	1685	1843	642653
11	1	63	14			40796
12	3	89.4	14	1839.6	1564.6	233502
13	3	96.9	14	1282.1	1638.1	426399
14	3	84.5	14	1494.5	1024.5	619777
15	1	63.3	14			16934
16						
17						
18						
19						
20						

Unless otherwise stated the results shown in this test report refer only to the sample(s) tested and such sample(s) are retained for 90 days only.

除非另有說明，此報告結果僅對測試之樣品負責，同時此樣品僅保留90天。本報告未經本公司書面許可，不可部份複製。

This document is issued by the Company subject to its General Conditions of Service printed overleaf, available on request or accessible at <http://www.sgs.com.tw/Terms-and-Conditions> and for electronic format documents, subject to Terms and Conditions for Electronic Documents at <http://www.sgs.com.tw/Terms-and-Conditions>. Attention is drawn to the limitation of liability, indemnification and jurisdiction issues defined therein. Any holder of this document is advised that information contained hereon reflects the Company's findings at the time of its intervention only and within the limits of Client's instructions, if any. The Company's sole responsibility is to its Client and this document does not exonerate parties to a transaction from exercising all their rights and obligations under the transaction documents. This document cannot be reproduced except in full, without prior written approval of the Company. Any unauthorized alteration, forgery or falsification of the content or appearance of this document is unlawful and offenders may be prosecuted to the fullest extent of the law.

Radar Type5_Trial27 for 5320MHz

Data Sheet for FCC Radar Type 5						
Trial Number:		27		VSG Frequency(MHz):		5323.1305
Number of Bursts in Trial:			17		Successful Detection: Yes	
Burst (8-20)	Number Pulses per Burst (1-3)	Pulse Width (50-100)	Chirp Width (5-20)	Pulse 1-to-2 Spacing	Pulse 2-to-3 Spacing	Starting Location Within Interval
		(μ sec)	(MHz)	(μ sec)	(μ sec)	(μ sec)
1	2	79.4	16	1554.6		185404
2	3	94.8	16	1571.2	1078.2	355243
3	3	91.1	16	1445.9	1467.9	524957
4	2	72	16	1706		696602
5	3	86.8	16	1170.2	1767.2	164009
6	1	59.7	16			335368
7	3	91.5	16	1447.5	1197.5	504553
8	1	65.5	16			677665
9	3	93	16	978	1696	143140
10	3	96.9	16	1185.1	1071.1	313396
11	2	72.6	16	976.4		484806
12	1	53	16			655886
13	1	63.7	16			122700
14	3	98.2	16	939.8	1156.8	292699
15	2	72.4	16	1661.6		463032
16	2	83.1	16	955.9		633961
17	1	57.7	16			101592
18						
19						
20						

Unless otherwise stated the results shown in this test report refer only to the sample(s) tested and such sample(s) are retained for 90 days only.

除非另有說明，此報告結果僅對測試之樣品負責，同時此樣品僅保留90天。本報告未經本公司書面許可，不可部份複製。

This document is issued by the Company subject to its General Conditions of Service printed overleaf, available on request or accessible at <http://www.sgs.com.tw/Terms-and-Conditions> and for electronic format documents, subject to Terms and Conditions for Electronic Documents at <http://www.sgs.com.tw/Terms-and-Conditions>. Attention is drawn to the limitation of liability, indemnification and jurisdiction issues defined therein. Any holder of this document is advised that information contained hereon reflects the Company's findings at the time of its intervention only and within the limits of Client's instructions, if any. The Company's sole responsibility is to its Client and this document does not exonerate parties to a transaction from exercising all their rights and obligations under the transaction documents. This document cannot be reproduced except in full, without prior written approval of the Company. Any unauthorized alteration, forgery or falsification of the content or appearance of this document is unlawful and offenders may be prosecuted to the fullest extent of the law.

Radar Type5_Trial28 for 5320MHz

Data Sheet for FCC Radar Type 5						
Trial Number:		28		VSG Frequency(MHz):		5323.5305
Number of Bursts in Trial:			16		Successful Detection: Yes	
Burst (8-20)	Number Pulses per Burst (1-3)	Pulse Width (50-100)	Chirp Width (5-20)	Pulse 1-to-2 Spacing	Pulse 2-to-3 Spacing	Starting Location Within Interval
		(μ sec)	(MHz)	(μ sec)	(μ sec)	(μ sec)
1	1	51.6	15			289349
2	2	69.6	15	1249.4		470024
3	3	93.7	15	1041.3	1150.3	650118
4	2	81.7	15	1884.3		85378
5	3	92.9	15	1015.1	1041.1	266411
6	1	54	15			448486
7	3	89.4	15	1661.6	1625.6	627280
8	3	95.2	15	1199.8	1312.8	63036
9	3	94.8	15	1874.2	1264.2	243526
10	1	62	15			426457
11	3	86.8	15	1765.2	1300.2	605400
12	2	74.6	15	1030.4		40835
13	2	80.2	15	1433.8		221894
14	3	88.6	15	1584.4	1204.4	402325
15	3	95.1	15	1364.9	1513.9	582845
16	2	75.6	15	1550.4		18465
17						
18						
19						
20						

Unless otherwise stated the results shown in this test report refer only to the sample(s) tested and such sample(s) are retained for 90 days only.

除非另有說明，此報告結果僅對測試之樣品負責，同時此樣品僅保留90天。本報告未經本公司書面許可，不可部份複製。

This document is issued by the Company subject to its General Conditions of Service printed overleaf, available on request or accessible at <http://www.sgs.com.tw/Terms-and-Conditions> and for electronic format documents, subject to Terms and Conditions for Electronic Documents at <http://www.sgs.com.tw/Terms-and-Conditions>. Attention is drawn to the limitation of liability, indemnification and jurisdiction issues defined therein. Any holder of this document is advised that information contained hereon reflects the Company's findings at the time of its intervention only and within the limits of Client's instructions, if any. The Company's sole responsibility is to its Client and this document does not exonerate parties to a transaction from exercising all their rights and obligations under the transaction documents. This document cannot be reproduced except in full, without prior written approval of the Company. Any unauthorized alteration, forgery or falsification of the content or appearance of this document is unlawful and offenders may be prosecuted to the fullest extent of the law.

Radar Type5_Trial29 for 5320MHz

Data Sheet for FCC Radar Type 5						
Trial Number:		29		VSG Frequency(MHz):		5325.5305
Number of Bursts in Trial:			12		Successful Detection: Yes	
Burst (8-20)	Number Pulses per Burst (1-3)	Pulse Width (50-100)	Chirp Width (5-20)	Pulse 1-to-2 Spacing	Pulse 2-to-3 Spacing	Starting Location Within Interval
		(μ sec)	(MHz)	(μ sec)	(μ sec)	(μ sec)
1	3	96.5	10	1604.5	1082.5	265973
2	1	54.2	10			509016
3	2	77.3	10	1263.7		749934
4	3	85.8	10	1593.2	1151.2	990734
5	3	93.9	10	920.1	1876.1	236405
6	3	87.2	10	999.8	1300.8	477860
7	2	79	10	980		720257
8	3	91	10	977	918	961256
9	1	51.6	10			207126
10	3	96.3	10	1180.7	1203.7	448163
11	1	51.9	10			691269
12	2	76.9	10	1126.1		932778
13						
14						
15						
16						
17						
18						
19						
20						

Unless otherwise stated the results shown in this test report refer only to the sample(s) tested and such sample(s) are retained for 90 days only.

除非另有說明，此報告結果僅對測試之樣品負責，同時此樣品僅保留90天。本報告未經本公司書面許可，不可部份複製。

This document is issued by the Company subject to its General Conditions of Service printed overleaf, available on request or accessible at <http://www.sgs.com.tw/Terms-and-Conditions> and for electronic format documents, subject to Terms and Conditions for Electronic Documents at <http://www.sgs.com.tw/Terms-and-Conditions>. Attention is drawn to the limitation of liability, indemnification and jurisdiction issues defined therein. Any holder of this document is advised that information contained hereon reflects the Company's findings at the time of its intervention only and within the limits of Client's instructions, if any. The Company's sole responsibility is to its Client and this document does not exonerate parties to a transaction from exercising all their rights and obligations under the transaction documents. This document cannot be reproduced except in full, without prior written approval of the Company. Any unauthorized alteration, forgery or falsification of the content or appearance of this document is unlawful and offenders may be prosecuted to the fullest extent of the law.

Radar Type5_Trial30 for 5320MHz

Data Sheet for FCC Radar Type 5						
Trial Number:		30		VSG Frequency(MHz):		5321.9305
Number of Bursts in Trial:			19	Successful Detection:		Yes
Burst (8-20)	Number Pulses per Burst (1-3)	Pulse Width (50-100)	Chirp Width (5-20)	Pulse 1-to-2 Spacing	Pulse 2-to-3 Spacing	Starting Location Within Interval
		(μ sec)	(MHz)	(μ sec)	(μ sec)	(μ sec)
1	2	68.3	19	1287.7		111742
2	2	79.5	19	1375.5		263974
3	3	94.4	19	1371.6	1809.6	415412
4	2	78.9	19	1033.1		569750
5	1	58.9	19			93035
6	1	55.2	19			245758
7	3	87.8	19	1741.2	931.2	396617
8	2	77.2	19	1149.8		550426
9	3	90.8	19	1320.2	1427.2	73959
10	2	81.7	19	1204.3		226712
11	3	86.5	19	1320.5	1309.5	378328
12	3	90.7	19	1303.3	1374.3	530663
13	1	51.6	19			55500
14	2	76.9	19	1169.1		207885
15	3	92.1	19	1109.9	1723.9	359389
16	3	97.8	19	1590.2	1052.2	511380
17	1	54.6	19			36611
18	3	91	19	1234	1848	188355
19	1	62.7	19			342053
20						

Unless otherwise stated the results shown in this test report refer only to the sample(s) tested and such sample(s) are retained for 90 days only.

除非另有說明，此報告結果僅對測試之樣品負責，同時此樣品僅保留90天。本報告未經本公司書面許可，不可部份複製。

This document is issued by the Company subject to its General Conditions of Service printed overleaf, available on request or accessible at <http://www.sgs.com.tw/Terms-and-Conditions> and for electronic format documents, subject to Terms and Conditions for Electronic Documents at <http://www.sgs.com.tw/Terms-and-Conditions>. Attention is drawn to the limitation of liability, indemnification and jurisdiction issues defined therein. Any holder of this document is advised that information contained hereon reflects the Company's findings at the time of its intervention only and within the limits of Client's instructions, if any. The Company's sole responsibility is to its Client and this document does not exonerate parties to a transaction from exercising all their rights and obligations under the transaction documents. This document cannot be reproduced except in full, without prior written approval of the Company. Any unauthorized alteration, forgery or falsification of the content or appearance of this document is unlawful and offenders may be prosecuted to the fullest extent of the law.

Radar Type6 for 5320MHz

Data Sheet for FCC Radar Type 6

Trial	Pulse Width	PRI	Pulses per Hop	Hopping Rate	Hopping Sequence Length	Successful Detection
	(μ sec)	(μ sec)		(kHz)	(msec)	(Yes/No)
1	1	333	9	0.333	300	Yes
2	1	333	9	0.333	300	Yes
3	1	333	9	0.333	300	Yes
4	1	333	9	0.333	300	Yes
5	1	333	9	0.333	300	Yes
6	1	333	9	0.333	300	Yes
7	1	333	9	0.333	300	Yes
8	1	333	9	0.333	300	Yes
9	1	333	9	0.333	300	Yes
10	1	333	9	0.333	300	Yes
11	1	333	9	0.333	300	Yes
12	1	333	9	0.333	300	Yes
13	1	333	9	0.333	300	Yes
14	1	333	9	0.333	300	Yes
15	1	333	9	0.333	300	Yes
16	1	333	9	0.333	300	Yes
17	1	333	9	0.333	300	Yes
18	1	333	9	0.333	300	Yes
19	1	333	9	0.333	300	Yes
20	1	333	9	0.333	300	Yes
21	1	333	9	0.333	300	Yes
22	1	333	9	0.333	300	Yes
23	1	333	9	0.333	300	Yes
24	1	333	9	0.333	300	Yes
25	1	333	9	0.333	300	Yes
26	1	333	9	0.333	300	Yes
27	1	333	9	0.333	300	Yes
28	1	333	9	0.333	300	Yes
29	1	333	9	0.333	300	Yes
30	1	333	9	0.333	300	Yes

Unless otherwise stated the results shown in this test report refer only to the sample(s) tested and such sample(s) are retained for 90 days only.

除非另有說明，此報告結果僅對測試之樣品負責，同時此樣品僅保留90天。本報告未經本公司書面許可，不可部份複製。

This document is issued by the Company subject to its General Conditions of Service printed overleaf, available on request or accessible at <http://www.sgs.com.tw/Terms-and-Conditions> and for electronic format documents, subject to Terms and Conditions for Electronic Documents at <http://www.sgs.com.tw/Terms-and-Conditions>. Attention is drawn to the limitation of liability, indemnification and jurisdiction issues defined therein. Any holder of this document is advised that information contained hereon reflects the Company's findings at the time of its intervention only and within the limits of Client's instructions, if any. The Company's sole responsibility is to its Client and this document does not exonerate parties to a transaction from exercising all their rights and obligations under the transaction documents. This document cannot be reproduced except in full, without prior written approval of the Company. Any unauthorized alteration, forgery or falsification of the content or appearance of this document is unlawful and offenders may be prosecuted to the fullest extent of the law.

HE20_5500MHz

Short Pulse Radar Type	Minimum Number of Trials	Detection(%)		Minmum Percentage of Successful Detection(%)	Pass/Fail
1	30	100		60	Pass
2	30	96.67		60	Pass
3	30	86.67		60	Pass
4	30	96.67		60	Pass
Aggregate (Radar Types 1-4)	120	95.0025		80	Pass
Long Pulse Radar Type	Minimum Number of Trials	Each Detection(%)	Total Detection(%)	Minmum Percentage of Successful Detection(%)	Pass/Fail
5	Center:10	100	100	80	Pass
	Low Edge:10	100			
	High Edge:10	100			
Frequency Hopping Radar Type	Minimum Number of Trials	Detection(%)		Minmum Percentage of Successful Detection(%)	Pass/Fail
6	30	100		70	Pass

Unless otherwise stated the results shown in this test report refer only to the sample(s) tested and such sample(s) are retained for 90 days only.

除非另有說明，此報告結果僅對測試之樣品負責，同時此樣品僅保留90天。本報告未經本公司書面許可，不可部份複製。

This document is issued by the Company subject to its General Conditions of Service printed overleaf, available on request or accessible at <http://www.sgs.com.tw/Terms-and-Conditions> and for electronic format documents, subject to Terms and Conditions for Electronic Documents at <http://www.sgs.com.tw/Terms-and-Conditions>. Attention is drawn to the limitation of liability, indemnification and jurisdiction issues defined therein. Any holder of this document is advised that information contained hereon reflects the Company's findings at the time of its intervention only and within the limits of Client's instructions, if any. The Company's sole responsibility is to its Client and this document does not exonerate parties to a transaction from exercising all their rights and obligations under the transaction documents. This document cannot be reproduced except in full, without prior written approval of the Company. Any unauthorized alteration, forgery or falsification of the content or appearance of this document is unlawful and offenders may be prosecuted to the fullest extent of the law.

Radar Type1 for 5500MHz

Data Sheet for FCC Radar Type 1

Trial	VSG Frequency (MHz)	Pulse Repetition Frequency Number (1 to 23)	Pulse Repetition Frequency	PRI	Test A/B	Successful Detection
			(Pulses Per Second)	(msec)	A/B	(Yes/No)
1	5500	13	1319.3	758	A	Yes
2	5500	21	1089.3	918	A	Yes
3	5500	8	1519.8	658	A	Yes
4	5500	19	1139	878	A	Yes
5	5500	18	1165.5	858	A	Yes
6	5500	11	1392.8	718	A	Yes
7	5500	6	1618.1	618	A	Yes
8	5500	10	1432.7	698	A	Yes
9	5500	16	1222.5	818	A	Yes
10	5500	17	1193.3	838	A	Yes
11	5500	23	326.2	3066	A	Yes
12	5500	9	1474.9	678	A	Yes
13	5500	4	1730.1	578	A	Yes
14	5500	5	1672.2	598	A	Yes
15	5500	1	1930.5	518	A	Yes
16	5500	-	533.6	1874	B	Yes
17	5500	-	471.7	2120	B	Yes
18	5500	-	342.2	2922	B	Yes
19	5500	-	993	1007	B	Yes
20	5500	-	1257.9	795	B	Yes
21	5500	-	742.9	1346	B	Yes
22	5500	-	814.3	1228	B	Yes
23	5500	-	403.1	2481	B	Yes
24	5500	-	700.8	1427	B	Yes
25	5500	-	1831.5	546	B	Yes
26	5500	-	1251.6	799	B	Yes
27	5500	-	483.6	2068	B	Yes
28	5500	-	970.9	1030	B	Yes
29	5500	-	449.6	2224	B	Yes
30	5500	-	687.8	1454	B	Yes

Unless otherwise stated the results shown in this test report refer only to the sample(s) tested and such sample(s) are retained for 90 days only.

除非另有說明，此報告結果僅對測試之樣品負責，同時此樣品僅保留90天。本報告未經本公司書面許可，不可部份複製。

This document is issued by the Company subject to its General Conditions of Service printed overleaf, available on request or accessible at <http://www.sgs.com.tw/Terms-and-Conditions> and for electronic format documents, subject to Terms and Conditions for Electronic Documents at <http://www.sgs.com.tw/Terms-and-Conditions>. Attention is drawn to the limitation of liability, indemnification and jurisdiction issues defined therein. Any holder of this document is advised that information contained hereon reflects the Company's findings at the time of its intervention only and within the limits of Client's instructions, if any. The Company's sole responsibility is to its Client and this document does not exonerate parties to a transaction from exercising all their rights and obligations under the transaction documents. This document cannot be reproduced except in full, without prior written approval of the Company. Any unauthorized alteration, forgery or falsification of the content or appearance of this document is unlawful and offenders may be prosecuted to the fullest extent of the law.

SGS Taiwan Ltd.

No.134,Wu Kung Road, New Taipei Industrial Park, Wuku District, New Taipei City, Taiwan/新北市五股區新北產業園區五工路 134 號

台灣檢驗科技股份有限公司

t (886-2) 2299-3279

f (886-2) 2298-0488

www.sgs.com.tw

Member of SGS Group

Radar Type2 for 5500MHz

Data Sheet for FCC Radar Type 2

Trial	VSG Frequency (MHz)	Number Pulses per Burst (23-29)	Pulse Width (1-5)	PRI (150-230)	Successful Detection
			(μ s)	(μ s)	(Yes/No)
1	5500	29	4.9	195	Yes
2	5500	28	4.1	153	Yes
3	5500	26	3.2	151	Yes
4	5500	23	1.2	227	Yes
5	5500	23	1.1	179	Yes
6	5500	26	2.9	166	Yes
7	5500	26	2.7	174	Yes
8	5500	24	2.1	230	Yes
9	5500	24	1.9	180	Yes
10	5500	29	4.8	223	Yes
11	5500	26	3.2	193	Yes
12	5500	24	1.9	155	Yes
13	5500	28	4	187	Yes
14	5500	29	5	206	Yes
15	5500	27	3.6	220	Yes
16	5500	29	4.7	175	Yes
17	5500	24	1.7	204	Yes
18	5500	26	3.1	181	Yes
19	5500	25	2.2	228	Yes
20	5500	28	4	182	Yes
21	5500	23	1.4	198	Yes
22	5500	26	3	199	Yes
23	5500	27	3.3	152	Yes
24	5500	23	1.3	178	Yes
25	5500	25	2.2	207	Yes
26	5500	27	3.4	159	Yes
27	5500	28	3.9	225	Yes
28	5500	27	3.6	168	Yes
29	5500	25	2.3	177	Yes
30	5500	29	4.7	205	No

Unless otherwise stated the results shown in this test report refer only to the sample(s) tested and such sample(s) are retained for 90 days only.

除非另有說明，此報告結果僅對測試之樣品負責，同時此樣品僅保留90天。本報告未經本公司書面許可，不可部份複製。

This document is issued by the Company subject to its General Conditions of Service printed overleaf, available on request or accessible at <http://www.sgs.com.tw/Terms-and-Conditions> and for electronic format documents, subject to Terms and Conditions for Electronic Documents at <http://www.sgs.com.tw/Terms-and-Conditions>. Attention is drawn to the limitation of liability, indemnification and jurisdiction issues defined therein. Any holder of this document is advised that information contained hereon reflects the Company's findings at the time of its intervention only and within the limits of Client's instructions, if any. The Company's sole responsibility is to its Client and this document does not exonerate parties to a transaction from exercising all their rights and obligations under the transaction documents. This document cannot be reproduced except in full, without prior written approval of the Company. Any unauthorized alteration, forgery or falsification of the content or appearance of this document is unlawful and offenders may be prosecuted to the fullest extent of the law.

Radar Type3 for 5500MHz

Data Sheet for FCC Radar Type 3

Trial	VSG Frequency (MHz)	Number Pulses per Burst (16-18)	Pulse Width (6-10)	PRI (200-500)	Successful Detection
			(μ s)	(μ s)	(Yes/No)
1	5500	18	9.9	442	Yes
2	5500	18	9.1	499	Yes
3	5500	17	8.2	273	Yes
4	5500	16	6.2	338	No
5	5500	16	6.1	487	Yes
6	5500	17	7.9	420	Yes
7	5500	17	7.7	450	No
8	5500	16	7.1	339	Yes
9	5500	16	6.9	405	Yes
10	5500	18	9.8	223	Yes
11	5500	17	8.2	453	Yes
12	5500	16	6.9	417	Yes
13	5500	18	9	400	Yes
14	5500	18	10	498	Yes
15	5500	17	8.6	274	Yes
16	5500	18	9.7	431	Yes
17	5500	16	6.7	294	Yes
18	5500	17	8.1	203	Yes
19	5500	16	7.2	298	Yes
20	5500	18	9	473	Yes
21	5500	16	6.4	407	Yes
22	5500	17	8	258	Yes
23	5500	17	8.3	249	Yes
24	5500	16	6.3	446	Yes
25	5500	16	7.2	486	Yes
26	5500	17	8.4	480	No
27	5500	18	8.9	370	No
28	5500	17	8.6	348	Yes
29	5500	16	7.3	401	Yes
30	5500	18	9.7	264	Yes

Unless otherwise stated the results shown in this test report refer only to the sample(s) tested and such sample(s) are retained for 90 days only.

除非另有說明，此報告結果僅對測試之樣品負責，同時此樣品僅保留90天。本報告未經本公司書面許可，不可部份複製。

This document is issued by the Company subject to its General Conditions of Service printed overleaf, available on request or accessible at <http://www.sgs.com.tw/Terms-and-Conditions> and for electronic format documents, subject to Terms and Conditions for Electronic Documents at <http://www.sgs.com.tw/Terms-and-Conditions>. Attention is drawn to the limitation of liability, indemnification and jurisdiction issues defined therein. Any holder of this document is advised that information contained hereon reflects the Company's findings at the time of its intervention only and within the limits of Client's instructions, if any. The Company's sole responsibility is to its Client and this document does not exonerate parties to a transaction from exercising all their rights and obligations under the transaction documents. This document cannot be reproduced except in full, without prior written approval of the Company. Any unauthorized alteration, forgery or falsification of the content or appearance of this document is unlawful and offenders may be prosecuted to the fullest extent of the law.

Radar Type4 for 5500MHz

Data Sheet for FCC Radar Type 4

Trial	VSG Frequency (MHz)	Number Pulses per Burst (12-16)	Pulse Width (11-20)	PRI (200-500)	Successful Detection
			(μ s)	(μ s)	(Yes/No)
1	5500	16	19.6	442	Yes
2	5500	15	17.8	499	Yes
3	5500	14	15.8	273	Yes
4	5500	12	11.4	338	Yes
5	5500	12	11.3	487	Yes
6	5500	14	15.3	420	Yes
7	5500	14	14.9	450	Yes
8	5500	13	13.5	339	Yes
9	5500	13	13.1	405	Yes
10	5500	16	19.5	223	Yes
11	5500	14	16	453	Yes
12	5500	13	13	417	Yes
13	5500	15	17.8	400	Yes
14	5500	16	20	498	Yes
15	5500	15	16.9	274	Yes
16	5500	16	19.2	431	Yes
17	5500	12	12.6	294	Yes
18	5500	14	15.6	203	Yes
19	5500	13	13.6	298	Yes
20	5500	15	17.6	473	Yes
21	5500	12	12.1	407	Yes
22	5500	14	15.5	258	Yes
23	5500	14	16.2	249	Yes
24	5500	12	11.7	446	Yes
25	5500	13	13.8	486	Yes
26	5500	15	16.5	480	Yes
27	5500	15	17.5	370	Yes
28	5500	15	16.8	348	Yes
29	5500	13	13.9	401	No
30	5500	16	19.3	264	Yes

Unless otherwise stated the results shown in this test report refer only to the sample(s) tested and such sample(s) are retained for 90 days only.

除非另有說明，此報告結果僅對測試之樣品負責，同時此樣品僅保留90天。本報告未經本公司書面許可，不可部份複製。

This document is issued by the Company subject to its General Conditions of Service printed overleaf, available on request or accessible at <http://www.sgs.com.tw/Terms-and-Conditions> and for electronic format documents, subject to Terms and Conditions for Electronic Documents at <http://www.sgs.com.tw/Terms-and-Conditions>. Attention is drawn to the limitation of liability, indemnification and jurisdiction issues defined therein. Any holder of this document is advised that information contained hereon reflects the Company's findings at the time of its intervention only and within the limits of Client's instructions, if any. The Company's sole responsibility is to its Client and this document does not exonerate parties to a transaction from exercising all their rights and obligations under the transaction documents. This document cannot be reproduced except in full, without prior written approval of the Company. Any unauthorized alteration, forgery or falsification of the content or appearance of this document is unlawful and offenders may be prosecuted to the fullest extent of the law.

Radar Type5_Trial1 for 5500MHz

Data Sheet for FCC Radar Type 5						
Trial Number:			1	VSG Frequency(MHz):		5500
Number of Bursts in Trial:			20	Successful Detection:		Yes
Burst (8-20)	Number Pulses per Burst (1-3)	Pulse Width (50-100)	Chirp Width (5-20)	Pulse 1-to-2 Spacing	Pulse 2-to-3 Spacing	Starting Location Within Interval
		(μ sec)	(MHz)	(μ sec)	(μ sec)	(μ sec)
1	3	97.7	20	1034.3	1421.3	116141
2	3	87.9	20	1634.1	1463.1	260383
3	2	76.9	20	929.1		406435
4	1	52.4	20			552540
5	1	51.8	20			98818
6	2	74	20	1785		243337
7	2	71.7	20	1586.3		388146
8	1	64	20			534217
9	1	61.5	20			80882
10	3	97.3	20	912.7	1544.7	224944
11	2	77.7	20	1096.3		370763
12	1	61.1	20			516312
13	3	87.5	20	1260.5	1441.5	62728
14	3	99.7	20	1776.3	1284.3	207224
15	2	82.7	20	1140.3		352481
16	3	95.2	20	1213.8	1162.8	495985
17	1	59.1	20			45158
18	2	75.6	20	1041.4		189991
19	1	64.7	20			335648
20	3	86.8	20	918.2	1652.2	478439

Unless otherwise stated the results shown in this test report refer only to the sample(s) tested and such sample(s) are retained for 90 days only.

除非另有說明，此報告結果僅對測試之樣品負責，同時此樣品僅保留90天。本報告未經本公司書面許可，不可部份複製。

This document is issued by the Company subject to its General Conditions of Service printed overleaf, available on request or accessible at <http://www.sgs.com.tw/Terms-and-Conditions> and for electronic format documents, subject to Terms and Conditions for Electronic Documents at <http://www.sgs.com.tw/Terms-and-Conditions>. Attention is drawn to the limitation of liability, indemnification and jurisdiction issues defined therein. Any holder of this document is advised that information contained hereon reflects the Company's findings at the time of its intervention only and within the limits of Client's instructions, if any. The Company's sole responsibility is to its Client and this document does not exonerate parties to a transaction from exercising all their rights and obligations under the transaction documents. This document cannot be reproduced except in full, without prior written approval of the Company. Any unauthorized alteration, forgery or falsification of the content or appearance of this document is unlawful and offenders may be prosecuted to the fullest extent of the law.

Radar Type5_Trial2 for 5500MHz

Data Sheet for FCC Radar Type 5						
Trial Number:		2		VSG Frequency(MHz):		5500
Number of Bursts in Trial:			17		Successful Detection: Yes	
Burst (8-20)	Number Pulses per Burst (1-3)	Pulse Width (50-100)	Chirp Width (5-20)	Pulse 1-to-2 Spacing	Pulse 2-to-3 Spacing	Starting Location Within Interval
		(μ sec)	(MHz)	(μ sec)	(μ sec)	(μ sec)
1	1	56	17			32097
2	2	75.2	17	1446.8		202501
3	2	79.1	17	1594.9		372874
4	1	54.1	17			544886
5	1	65.8	17			11064
6	2	80.4	17	1102.6		181560
7	3	86	17	1685	1290	351173
8	2	82.4	17	1445.6		522390
9	1	66.3	17			694725
10	3	95.8	17	970.2	1319.2	160367
11	3	85.6	17	1831.4	1791.4	329885
12	1	51	17			502809
13	1	64.7	17			673232
14	3	90.6	17	1053.4	1866.4	139129
15	1	53.4	17			310563
16	3	96.2	17	1065.8	1773.8	479259
17	1	65.5	17			652703
18						
19						
20						

Unless otherwise stated the results shown in this test report refer only to the sample(s) tested and such sample(s) are retained for 90 days only.

除非另有說明，此報告結果僅對測試之樣品負責，同時此樣品僅保留90天。本報告未經本公司書面許可，不可部份複製。

This document is issued by the Company subject to its General Conditions of Service printed overleaf, available on request or accessible at <http://www.sgs.com.tw/Terms-and-Conditions> and for electronic format documents, subject to Terms and Conditions for Electronic Documents at <http://www.sgs.com.tw/Terms-and-Conditions>. Attention is drawn to the limitation of liability, indemnification and jurisdiction issues defined therein. Any holder of this document is advised that information contained hereon reflects the Company's findings at the time of its intervention only and within the limits of Client's instructions, if any. The Company's sole responsibility is to its Client and this document does not exonerate parties to a transaction from exercising all their rights and obligations under the transaction documents. This document cannot be reproduced except in full, without prior written approval of the Company. Any unauthorized alteration, forgery or falsification of the content or appearance of this document is unlawful and offenders may be prosecuted to the fullest extent of the law.

Radar Type5_Trial3 for 5500MHz

Data Sheet for FCC Radar Type 5						
Trial Number:			3	VSG Frequency(MHz):		5500
Number of Bursts in Trial:			14	Successful Detection:		Yes
Burst (8-20)	Number Pulses per Burst (1-3)	Pulse Width (50-100)	Chirp Width (5-20)	Pulse 1-to-2 Spacing	Pulse 2-to-3 Spacing	Starting Location Within Interval
		(μ sec)	(MHz)	(μ sec)	(μ sec)	(μ sec)
1	2	75.2	13	1361.8		143969
2	3	90.7	13	1099.3	988.3	350947
3	3	93.8	13	1045.2	1043.2	557505
4	1	60.8	13			766524
5	3	98.2	13	1508.8	1876.8	118256
6	3	88.5	13	959.5	1339.5	325401
7	3	90.5	13	1857.5	1691.5	531589
8	2	74.6	13	957.4		740731
9	2	74.5	13	1040.5		92978
10	1	53.5	13			300652
11	3	89.7	13	1803.3	1110.3	506183
12	2	80.9	13	1738.1		714128
13	1	51.5	13			67556
14	2	80.4	13	1193.6		274857
15						
16						
17						
18						
19						
20						

Unless otherwise stated the results shown in this test report refer only to the sample(s) tested and such sample(s) are retained for 90 days only.

除非另有說明，此報告結果僅對測試之樣品負責，同時此樣品僅保留90天。本報告未經本公司書面許可，不可部份複製。

This document is issued by the Company subject to its General Conditions of Service printed overleaf, available on request or accessible at <http://www.sgs.com.tw/Terms-and-Conditions> and for electronic format documents, subject to Terms and Conditions for Electronic Documents at <http://www.sgs.com.tw/Terms-and-Conditions>. Attention is drawn to the limitation of liability, indemnification and jurisdiction issues defined therein. Any holder of this document is advised that information contained hereon reflects the Company's findings at the time of its intervention only and within the limits of Client's instructions, if any. The Company's sole responsibility is to its Client and this document does not exonerate parties to a transaction from exercising all their rights and obligations under the transaction documents. This document cannot be reproduced except in full, without prior written approval of the Company. Any unauthorized alteration, forgery or falsification of the content or appearance of this document is unlawful and offenders may be prosecuted to the fullest extent of the law.

Radar Type5_Trial4 for 5500MHz

Data Sheet for FCC Radar Type 5						
Trial Number:			4	VSG Frequency(MHz):		5500
Number of Bursts in Trial:			8	Successful Detection:		Yes
Burst (8-20)	Number Pulses per Burst (1-3)	Pulse Width (50-100)	Chirp Width (5-20)	Pulse 1-to-2 Spacing	Pulse 2-to-3 Spacing	Starting Location Within Interval
		(μ sec)	(MHz)	(μ sec)	(μ sec)	(μ sec)
1	1	59.8	5			845339
2	1	65.7	5			1208624
3	2	70.7	5	1208.3		73525
4	2	72.4	5	1543.6		436604
5	2	72.4	5	961.6		800038
6	1	58.8	5			1164144
7	2	72.8	5	1723.2		28791
8	3	86.7	5	1407.3	1824.3	391341
9						
10						
11						
12						
13						
14						
15						
16						
17						
18						
19						
20						

Unless otherwise stated the results shown in this test report refer only to the sample(s) tested and such sample(s) are retained for 90 days only.

除非另有說明，此報告結果僅對測試之樣品負責，同時此樣品僅保留90天。本報告未經本公司書面許可，不可部份複製。

This document is issued by the Company subject to its General Conditions of Service printed overleaf, available on request or accessible at <http://www.sgs.com.tw/Terms-and-Conditions> and for electronic format documents, subject to Terms and Conditions for Electronic Documents at <http://www.sgs.com.tw/Terms-and-Conditions>. Attention is drawn to the limitation of liability, indemnification and jurisdiction issues defined therein. Any holder of this document is advised that information contained hereon reflects the Company's findings at the time of its intervention only and within the limits of Client's instructions, if any. The Company's sole responsibility is to its Client and this document does not exonerate parties to a transaction from exercising all their rights and obligations under the transaction documents. This document cannot be reproduced except in full, without prior written approval of the Company. Any unauthorized alteration, forgery or falsification of the content or appearance of this document is unlawful and offenders may be prosecuted to the fullest extent of the law.

SGS Taiwan Ltd.

No.134,Wu Kung Road, New Taipei Industrial Park, Wuku District, New Taipei City, Taiwan/新北市五股區新北產業園區五工路 134 號

台灣檢驗科技股份有限公司

t (886-2) 2299-3279

f (886-2) 2298-0488

www.sgs.com.tw

Member of SGS Group

Radar Type5_Trial5 for 5500MHz

Data Sheet for FCC Radar Type 5						
Trial Number:			5	VSG Frequency(MHz):		5500
Number of Bursts in Trial:			8	Successful Detection:		Yes
Burst (8-20)	Number Pulses per Burst (1-3)	Pulse Width (50-100)	Chirp Width (5-20)	Pulse 1-to-2 Spacing	Pulse 2-to-3 Spacing	Starting Location Within Interval
		(μ sec)	(MHz)	(μ sec)	(μ sec)	(μ sec)
1	2	71.5	5	1024.5		755079
2	3	88	5	1905	1547	1116130
3	3	89.4	5	1595.6	1232.6	1479179
4	3	97.7	5	1549.3	1090.3	346877
5	1	65.8	5			710997
6	1	61.7	5			1074422
7	2	76.6	5	1387.4		1436084
8	3	96.5	5	1571.5	925.5	302135
9						
10						
11						
12						
13						
14						
15						
16						
17						
18						
19						
20						

Unless otherwise stated the results shown in this test report refer only to the sample(s) tested and such sample(s) are retained for 90 days only.

除非另有說明，此報告結果僅對測試之樣品負責，同時此樣品僅保留90天。本報告未經本公司書面許可，不可部份複製。

This document is issued by the Company subject to its General Conditions of Service printed overleaf, available on request or accessible at <http://www.sgs.com.tw/Terms-and-Conditions> and for electronic format documents, subject to Terms and Conditions for Electronic Documents at <http://www.sgs.com.tw/Terms-and-Conditions>. Attention is drawn to the limitation of liability, indemnification and jurisdiction issues defined therein. Any holder of this document is advised that information contained hereon reflects the Company's findings at the time of its intervention only and within the limits of Client's instructions, if any. The Company's sole responsibility is to its Client and this document does not exonerate parties to a transaction from exercising all their rights and obligations under the transaction documents. This document cannot be reproduced except in full, without prior written approval of the Company. Any unauthorized alteration, forgery or falsification of the content or appearance of this document is unlawful and offenders may be prosecuted to the fullest extent of the law.

Radar Type5_Trial6 for 5500MHz

Data Sheet for FCC Radar Type 5						
Trial Number:			6	VSG Frequency(MHz):		5500
Number of Bursts in Trial:			14	Successful Detection:		Yes
Burst (8-20)	Number Pulses per Burst (1-3)	Pulse Width (50-100)	Chirp Width (5-20)	Pulse 1-to-2 Spacing	Pulse 2-to-3 Spacing	Starting Location Within Interval
		(μ sec)	(MHz)	(μ sec)	(μ sec)	(μ sec)
1	3	97	12	1506	1903	378573
2	3	96.3	12	926.7	1064.7	586348
3	3	86.5	12	1416.5	964.5	793292
4	2	79.6	12	1505.4		146992
5	3	84	12	1459	1858	353209
6	3	85	12	1028	1539	560501
7	2	71	12	1692		767848
8	2	76	12	1081		121542
9	1	57.9	12			329085
10	3	86.7	12	1679.3	1245.3	535068
11	3	88.6	12	1154.4	1637.4	741864
12	2	79.5	12	1696.5		95986
13	3	91.3	12	1797.7	1841.7	302190
14	2	76.8	12	1755.2		510022
15						
16						
17						
18						
19						
20						

Unless otherwise stated the results shown in this test report refer only to the sample(s) tested and such sample(s) are retained for 90 days only.

除非另有說明，此報告結果僅對測試之樣品負責，同時此樣品僅保留90天。本報告未經本公司書面許可，不可部份複製。

This document is issued by the Company subject to its General Conditions of Service printed overleaf, available on request or accessible at <http://www.sgs.com.tw/Terms-and-Conditions> and for electronic format documents, subject to Terms and Conditions for Electronic Documents at <http://www.sgs.com.tw/Terms-and-Conditions>. Attention is drawn to the limitation of liability, indemnification and jurisdiction issues defined therein. Any holder of this document is advised that information contained hereon reflects the Company's findings at the time of its intervention only and within the limits of Client's instructions, if any. The Company's sole responsibility is to its Client and this document does not exonerate parties to a transaction from exercising all their rights and obligations under the transaction documents. This document cannot be reproduced except in full, without prior written approval of the Company. Any unauthorized alteration, forgery or falsification of the content or appearance of this document is unlawful and offenders may be prosecuted to the fullest extent of the law.

Radar Type5_Trial7 for 5500MHz

Data Sheet for FCC Radar Type 5						
Trial Number:			7	VSG Frequency(MHz):		5500
Number of Bursts in Trial:			13	Successful Detection:		Yes
Burst (8-20)	Number Pulses per Burst (1-3)	Pulse Width (50-100)	Chirp Width (5-20)	Pulse 1-to-2 Spacing	Pulse 2-to-3 Spacing	Starting Location Within Interval
		(μ sec)	(MHz)	(μ sec)	(μ sec)	(μ sec)
1	3	96.4	11	1752.6	1109.6	771194
2	1	51.4	11			76092
3	1	64.8	11			299489
4	1	65.3	11			522832
5	2	75.7	11	1670.3		745337
6	3	85.4	11	1250.6	979.6	48408
7	3	94	11	1772	1352	270970
8	2	68.1	11	1265.9		494746
9	2	81	11	1161		717983
10	3	87.4	11	1328.6	1906.6	20904
11	3	92.8	11	1267.2	1676.2	243688
12	3	88.6	11	1875.4	1638.4	465906
13	2	69.2	11	1282.8		690603
14						
15						
16						
17						
18						
19						
20						

Unless otherwise stated the results shown in this test report refer only to the sample(s) tested and such sample(s) are retained for 90 days only.

除非另有說明，此報告結果僅對測試之樣品負責，同時此樣品僅保留90天。本報告未經本公司書面許可，不可部份複製。

This document is issued by the Company subject to its General Conditions of Service printed overleaf, available on request or accessible at <http://www.sgs.com.tw/Terms-and-Conditions> and for electronic format documents, subject to Terms and Conditions for Electronic Documents at <http://www.sgs.com.tw/Terms-and-Conditions>. Attention is drawn to the limitation of liability, indemnification and jurisdiction issues defined therein. Any holder of this document is advised that information contained hereon reflects the Company's findings at the time of its intervention only and within the limits of Client's instructions, if any. The Company's sole responsibility is to its Client and this document does not exonerate parties to a transaction from exercising all their rights and obligations under the transaction documents. This document cannot be reproduced except in full, without prior written approval of the Company. Any unauthorized alteration, forgery or falsification of the content or appearance of this document is unlawful and offenders may be prosecuted to the fullest extent of the law.

Radar Type5_Trial8 for 5500MHz

Data Sheet for FCC Radar Type 5						
Trial Number:		8		VSG Frequency(MHz):		5500
Number of Bursts in Trial:			11		Successful Detection: Yes	
Burst (8-20)	Number Pulses per Burst (1-3)	Pulse Width (50-100)	Chirp Width (5-20)	Pulse 1-to-2 Spacing	Pulse 2-to-3 Spacing	Starting Location Within Interval
		(μ sec)	(MHz)	(μ sec)	(μ sec)	(μ sec)
1	1	55.7	9			1081971
2	2	71.5	9	1428.5		256209
3	1	50.4	9			520922
4	2	72.7	9	1676.3		783872
5	2	78.8	9	1564.2		1047535
6	3	98	9	1686	1848	223101
7	2	78.1	9	1319.9		487378
8	1	56.6	9			752190
9	3	93.4	9	1339.6	1120.6	1013747
10	3	94.4	9	1471.6	1168.6	190967
11	2	71.9	9	1853.1		454777
12						
13						
14						
15						
16						
17						
18						
19						
20						

Unless otherwise stated the results shown in this test report refer only to the sample(s) tested and such sample(s) are retained for 90 days only.

除非另有說明，此報告結果僅對測試之樣品負責，同時此樣品僅保留90天。本報告未經本公司書面許可，不可部份複製。

This document is issued by the Company subject to its General Conditions of Service printed overleaf, available on request or accessible at <http://www.sgs.com.tw/Terms-and-Conditions> and for electronic format documents, subject to Terms and Conditions for Electronic Documents at <http://www.sgs.com.tw/Terms-and-Conditions>. Attention is drawn to the limitation of liability, indemnification and jurisdiction issues defined therein. Any holder of this document is advised that information contained hereon reflects the Company's findings at the time of its intervention only and within the limits of Client's instructions, if any. The Company's sole responsibility is to its Client and this document does not exonerate parties to a transaction from exercising all their rights and obligations under the transaction documents. This document cannot be reproduced except in full, without prior written approval of the Company. Any unauthorized alteration, forgery or falsification of the content or appearance of this document is unlawful and offenders may be prosecuted to the fullest extent of the law.

SGS Taiwan Ltd.

No.134,Wu Kung Road, New Taipei Industrial Park, Wuku District, New Taipei City, Taiwan/新北市五股區新北產業園區五工路 134 號

台灣檢驗科技股份有限公司

t (886-2) 2299-3279

f (886-2) 2298-0488

www.sgs.com.tw

Member of SGS Group

Radar Type5_Trial9 for 5500MHz

Data Sheet for FCC Radar Type 5						
Trial Number:			9		VSG Frequency(MHz): 5500	
Number of Bursts in Trial:			11		Successful Detection: Yes	
Burst (8-20)	Number Pulses per Burst (1-3)	Pulse Width (50-100)	Chirp Width (5-20)	Pulse 1-to-2 Spacing	Pulse 2-to-3 Spacing	Starting Location Within Interval
		(μ sec)	(MHz)	(μ sec)	(μ sec)	(μ sec)
1	3	96.5	8	1238.5	1767.5	717802
2	2	74.9	8	1820.1		982334
3	3	94.7	8	1012.3	1446.3	158509
4	3	94.8	8	1520.2	1653.2	421684
5	1	64.4	8			687423
6	3	85.8	8	960.2	1385.2	949648
7	2	70.2	8	1167.8		126134
8	3	93.3	8	943.7	1289.7	389725
9	3	95.4	8	1101.6	1896.6	652936
10	3	94.7	8	1841.3	1060.3	916384
11	3	91.7	8	1816.3	1181.3	93458
12						
13						
14						
15						
16						
17						
18						
19						
20						

Unless otherwise stated the results shown in this test report refer only to the sample(s) tested and such sample(s) are retained for 90 days only.

除非另有說明，此報告結果僅對測試之樣品負責，同時此樣品僅保留90天。本報告未經本公司書面許可，不可部份複製。

This document is issued by the Company subject to its General Conditions of Service printed overleaf, available on request or accessible at <http://www.sgs.com.tw/Terms-and-Conditions> and for electronic format documents, subject to Terms and Conditions for Electronic Documents at <http://www.sgs.com.tw/Terms-and-Conditions>. Attention is drawn to the limitation of liability, indemnification and jurisdiction issues defined therein. Any holder of this document is advised that information contained hereon reflects the Company's findings at the time of its intervention only and within the limits of Client's instructions, if any. The Company's sole responsibility is to its Client and this document does not exonerate parties to a transaction from exercising all their rights and obligations under the transaction documents. This document cannot be reproduced except in full, without prior written approval of the Company. Any unauthorized alteration, forgery or falsification of the content or appearance of this document is unlawful and offenders may be prosecuted to the fullest extent of the law.

SGS Taiwan Ltd.

No.134,Wu Kung Road, New Taipei Industrial Park, Wuku District, New Taipei City, Taiwan/新北市五股區新北產業園區五工路 134 號

台灣檢驗科技股份有限公司

t (886-2) 2299-3279

f (886-2) 2298-0488

www.sgs.com.tw

Member of SGS Group

Radar Type5_Trial10 for 5500MHz

Data Sheet for FCC Radar Type 5						
Trial Number:		10		VSG Frequency(MHz):		5500
Number of Bursts in Trial:			20		Successful Detection: Yes	
Burst (8-20)	Number Pulses per Burst (1-3)	Pulse Width (50-100)	Chirp Width (5-20)	Pulse 1-to-2 Spacing	Pulse 2-to-3 Spacing	Starting Location Within Interval
		(μ sec)	(MHz)	(μ sec)	(μ sec)	(μ sec)
1	3	87.9	20	1065.1	1054.1	195845
2	2	82.9	20	1649.1		340735
3	1	50.4	20			487164
4	3	86.1	20	1511.9	1327.9	33463
5	3	91.3	20	1333.7	1629.7	177985
6	1	52.4	20			324139
7	2	78.8	20	964.2		468273
8	1	65.2	20			15748
9	3	99.2	20	1105.8	1472.8	160137
10	3	86.9	20	1715.1	1671.1	304464
11	3	95.4	20	1764.6	1171.6	448919
12	1	65.8	20			596028
13	1	65.2	20			142978
14	1	54.5	20			287964
15	1	57.4	20			433443
16	1	64	20			578958
17	1	59.8	20			125123
18	2	81.5	20	1113.5		269660
19	1	63.1	20			415298
20	2	70.1	20	1113.9		559053

Unless otherwise stated the results shown in this test report refer only to the sample(s) tested and such sample(s) are retained for 90 days only.

除非另有說明，此報告結果僅對測試之樣品負責，同時此樣品僅保留90天。本報告未經本公司書面許可，不可部份複製。

This document is issued by the Company subject to its General Conditions of Service printed overleaf, available on request or accessible at <http://www.sgs.com.tw/Terms-and-Conditions> and for electronic format documents, subject to Terms and Conditions for Electronic Documents at <http://www.sgs.com.tw/Terms-and-Conditions>. Attention is drawn to the limitation of liability, indemnification and jurisdiction issues defined therein. Any holder of this document is advised that information contained hereon reflects the Company's findings at the time of its intervention only and within the limits of Client's instructions, if any. The Company's sole responsibility is to its Client and this document does not exonerate parties to a transaction from exercising all their rights and obligations under the transaction documents. This document cannot be reproduced except in full, without prior written approval of the Company. Any unauthorized alteration, forgery or falsification of the content or appearance of this document is unlawful and offenders may be prosecuted to the fullest extent of the law.

SGS Taiwan Ltd.

No.134,Wu Kung Road, New Taipei Industrial Park, Wuku District, New Taipei City, Taiwan/新北市五股區新北產業園區五工路 134 號

台灣檢驗科技股份有限公司

t (886-2) 2299-3279

f (886-2) 2298-0488

www.sgs.com.tw

Member of SGS Group

Radar Type5_Trial11 for 5500MHz

Data Sheet for FCC Radar Type 5						
Trial Number:		11		VSG Frequency(MHz):		5495.9555
Number of Bursts in Trial:			15		Successful Detection: Yes	
Burst (8-20)	Number Pulses per Burst (1-3)	Pulse Width (50-100)	Chirp Width (5-20)	Pulse 1-to-2 Spacing	Pulse 2-to-3 Spacing	Starting Location Within Interval
		(μ sec)	(MHz)	(μ sec)	(μ sec)	(μ sec)
1	1	52.9	13			143103
2	1	57	13			336633
3	3	93	13	1786	1375	528454
4	2	68.8	13	1796.2		722576
5	1	50.7	13			119259
6	3	90.7	13	1150.3	1478.3	311911
7	3	99.3	13	1551.7	1326.7	504351
8	1	53.6	13			700354
9	3	95.3	13	1600.7	1466.7	95028
10	2	67.1	13	1419.9		288667
11	3	99.5	13	1883.5	1753.5	480592
12	3	93.2	13	1087.8	1551.8	673584
13	2	74.5	13	1562.5		71396
14	1	64.1	13			265211
15	3	83.6	13	1622.4	1038.4	457007
16						
17						
18						
19						
20						

Unless otherwise stated the results shown in this test report refer only to the sample(s) tested and such sample(s) are retained for 90 days only.

除非另有說明，此報告結果僅對測試之樣品負責，同時此樣品僅保留90天。本報告未經本公司書面許可，不可部份複製。

This document is issued by the Company subject to its General Conditions of Service printed overleaf, available on request or accessible at <http://www.sgs.com.tw/Terms-and-Conditions> and for electronic format documents, subject to Terms and Conditions for Electronic Documents at <http://www.sgs.com.tw/Terms-and-Conditions>. Attention is drawn to the limitation of liability, indemnification and jurisdiction issues defined therein. Any holder of this document is advised that information contained hereon reflects the Company's findings at the time of its intervention only and within the limits of Client's instructions, if any. The Company's sole responsibility is to its Client and this document does not exonerate parties to a transaction from exercising all their rights and obligations under the transaction documents. This document cannot be reproduced except in full, without prior written approval of the Company. Any unauthorized alteration, forgery or falsification of the content or appearance of this document is unlawful and offenders may be prosecuted to the fullest extent of the law.

SGS Taiwan Ltd.

No.134,Wu Kung Road, New Taipei Industrial Park, Wuku District, New Taipei City, Taiwan/新北市五股區新北產業園區五工路 134 號

台灣檢驗科技股份有限公司

t (886-2) 2299-3279

f (886-2) 2298-0488

www.sgs.com.tw

Member of SGS Group

Radar Type5_Trial12 for 5500MHz

Data Sheet for FCC Radar Type 5						
Trial Number:		12		VSG Frequency(MHz):		5493.9555
Number of Bursts in Trial:			10		Successful Detection: Yes	
Burst (8-20)	Number Pulses per Burst (1-3)	Pulse Width (50-100)	Chirp Width (5-20)	Pulse 1-to-2 Spacing	Pulse 2-to-3 Spacing	Starting Location Within Interval
		(μ sec)	(MHz)	(μ sec)	(μ sec)	(μ sec)
1	2	67.5	8	1366.5		978633
2	2	72.3	8	1722.7		71453
3	3	92.8	8	1745.2	1601.2	361200
4	1	56.7	8			653086
5	2	75.7	8	1346.3		942117
6	2	77.9	8	1602.1		35724
7	2	78.1	8	933.9		326175
8	3	95.3	8	1766.7	1165.7	615613
9	3	85.1	8	1363.9	1704.9	905273
10	1	51.1	8			1198252
11						
12						
13						
14						
15						
16						
17						
18						
19						
20						

Unless otherwise stated the results shown in this test report refer only to the sample(s) tested and such sample(s) are retained for 90 days only.

除非另有說明，此報告結果僅對測試之樣品負責，同時此樣品僅保留90天。本報告未經本公司書面許可，不可部份複製。

This document is issued by the Company subject to its General Conditions of Service printed overleaf, available on request or accessible at <http://www.sgs.com.tw/Terms-and-Conditions> and for electronic format documents, subject to Terms and Conditions for Electronic Documents at <http://www.sgs.com.tw/Terms-and-Conditions>. Attention is drawn to the limitation of liability, indemnification and jurisdiction issues defined therein. Any holder of this document is advised that information contained hereon reflects the Company's findings at the time of its intervention only and within the limits of Client's instructions, if any. The Company's sole responsibility is to its Client and this document does not exonerate parties to a transaction from exercising all their rights and obligations under the transaction documents. This document cannot be reproduced except in full, without prior written approval of the Company. Any unauthorized alteration, forgery or falsification of the content or appearance of this document is unlawful and offenders may be prosecuted to the fullest extent of the law.

Radar Type5_Trial13 for 5500MHz

Data Sheet for FCC Radar Type 5						
Trial Number:		13		VSG Frequency(MHz):		5497.1555
Number of Bursts in Trial:			17		Successful Detection: Yes	
Burst (8-20)	Number Pulses per Burst (1-3)	Pulse Width (50-100)	Chirp Width (5-20)	Pulse 1-to-2 Spacing	Pulse 2-to-3 Spacing	Starting Location Within Interval
		(μ sec)	(MHz)	(μ sec)	(μ sec)	(μ sec)
1	1	59	16			170817
2	2	79.5	16	990.5		341357
3	3	90.3	16	1075.7	1220.7	510526
4	1	57	16			683467
5	2	71.8	16	1218.2		149404
6	1	60.4	16			320410
7	1	61.8	16			491519
8	2	82.3	16	1727.7		660636
9	2	74.5	16	1601.5		128495
10	3	88.7	16	975.3	1412.3	298307
11	2	80.8	16	1746.2		469475
12	3	90	16	1030	1551	638300
13	2	81.6	16	1088.4		107469
14	3	85.3	16	1827.7	1324.7	277145
15	1	50.6	16			449387
16	1	53.2	16			620125
17	2	75.1	16	1843.9		86364
18						
19						
20						

Unless otherwise stated the results shown in this test report refer only to the sample(s) tested and such sample(s) are retained for 90 days only.

除非另有說明，此報告結果僅對測試之樣品負責，同時此樣品僅保留90天。本報告未經本公司書面許可，不可部份複製。

This document is issued by the Company subject to its General Conditions of Service printed overleaf, available on request or accessible at <http://www.sgs.com.tw/Terms-and-Conditions> and for electronic format documents, subject to Terms and Conditions for Electronic Documents at <http://www.sgs.com.tw/Terms-and-Conditions>. Attention is drawn to the limitation of liability, indemnification and jurisdiction issues defined therein. Any holder of this document is advised that information contained hereon reflects the Company's findings at the time of its intervention only and within the limits of Client's instructions, if any. The Company's sole responsibility is to its Client and this document does not exonerate parties to a transaction from exercising all their rights and obligations under the transaction documents. This document cannot be reproduced except in full, without prior written approval of the Company. Any unauthorized alteration, forgery or falsification of the content or appearance of this document is unlawful and offenders may be prosecuted to the fullest extent of the law.

Radar Type5_Trial14 for 5500MHz

Data Sheet for FCC Radar Type 5						
Trial Number:		14		VSG Frequency(MHz):		5498.7555
Number of Bursts in Trial:			20		Successful Detection: Yes	
Burst (8-20)	Number Pulses per Burst (1-3)	Pulse Width (50-100)	Chirp Width (5-20)	Pulse 1-to-2 Spacing	Pulse 2-to-3 Spacing	Starting Location Within Interval
		(μ sec)	(MHz)	(μ sec)	(μ sec)	(μ sec)
1	2	70	20	1015		218197
2	2	82	20	1063		363178
3	3	87.4	20	1016.6	1573.6	506900
4	1	52.2	20			55765
5	3	91.3	20	1392.7	1490.7	199823
6	1	51	20			346092
7	2	70.9	20	1197.1		490061
8	3	89.9	20	1240.1	1198.1	37702
9	3	91.8	20	1314.2	999.2	182230
10	2	67.1	20	1850.9		326990
11	2	74.7	20	1018.3		472340
12	3	87.5	20	916.5	1912.5	19883
13	3	92.3	20	1126.7	1650.7	164207
14	2	74.8	20	1634.2		309633
15	1	61.7	20			455707
16	1	57.8	20			2102
17	2	67.7	20	1674.3		146931
18	3	91.8	20	1452.2	1631.2	290728
19	1	61.1	20			437450
20	1	58.9	20			582293

Unless otherwise stated the results shown in this test report refer only to the sample(s) tested and such sample(s) are retained for 90 days only.

除非另有說明，此報告結果僅對測試之樣品負責，同時此樣品僅保留90天。本報告未經本公司書面許可，不可部份複製。

This document is issued by the Company subject to its General Conditions of Service printed overleaf, available on request or accessible at <http://www.sgs.com.tw/Terms-and-Conditions> and for electronic format documents, subject to Terms and Conditions for Electronic Documents at <http://www.sgs.com.tw/Terms-and-Conditions>. Attention is drawn to the limitation of liability, indemnification and jurisdiction issues defined therein. Any holder of this document is advised that information contained hereon reflects the Company's findings at the time of its intervention only and within the limits of Client's instructions, if any. The Company's sole responsibility is to its Client and this document does not exonerate parties to a transaction from exercising all their rights and obligations under the transaction documents. This document cannot be reproduced except in full, without prior written approval of the Company. Any unauthorized alteration, forgery or falsification of the content or appearance of this document is unlawful and offenders may be prosecuted to the fullest extent of the law.

SGS Taiwan Ltd.

No.134,Wu Kung Road, New Taipei Industrial Park, Wuku District, New Taipei City, Taiwan/新北市五股區新北產業園區五工路 134 號

台灣檢驗科技股份有限公司

t (886-2) 2299-3279

f (886-2) 2298-0488

www.sgs.com.tw

Member of SGS Group

Radar Type5_Trial15 for 5500MHz

Data Sheet for FCC Radar Type 5						
Trial Number:		15		VSG Frequency(MHz):		5496.7555
Number of Bursts in Trial:			16		Successful Detection: Yes	
Burst (8-20)	Number Pulses per Burst (1-3)	Pulse Width (50-100)	Chirp Width (5-20)	Pulse 1-to-2 Spacing	Pulse 2-to-3 Spacing	Starting Location Within Interval
		(μ sec)	(MHz)	(μ sec)	(μ sec)	(μ sec)
1	3	96.7	15	1581.3	1271.3	161051
2	2	73.5	15	1917.5		342354
3	1	56.7	15			524731
4	3	87.7	15	1898.3	1496.3	703120
5	1	60.8	15			139360
6	3	100	15	1513	1072	319792
7	2	75.5	15	1704.5		501115
8	1	52.7	15			683650
9	2	77.6	15	1511.4		116904
10	3	90.7	15	1515.3	1368.3	297489
11	1	57.4	15			480050
12	1	56.1	15			661425
13	2	72.5	15	1240.5		94607
14	1	52.8	15			276358
15	1	58.1	15			458076
16	1	63.3	15			639282
17						
18						
19						
20						

Unless otherwise stated the results shown in this test report refer only to the sample(s) tested and such sample(s) are retained for 90 days only.

除非另有說明，此報告結果僅對測試之樣品負責，同時此樣品僅保留90天。本報告未經本公司書面許可，不可部份複製。

This document is issued by the Company subject to its General Conditions of Service printed overleaf, available on request or accessible at <http://www.sgs.com.tw/Terms-and-Conditions> and for electronic format documents, subject to Terms and Conditions for Electronic Documents at <http://www.sgs.com.tw/Terms-and-Conditions>. Attention is drawn to the limitation of liability, indemnification and jurisdiction issues defined therein. Any holder of this document is advised that information contained hereon reflects the Company's findings at the time of its intervention only and within the limits of Client's instructions, if any. The Company's sole responsibility is to its Client and this document does not exonerate parties to a transaction from exercising all their rights and obligations under the transaction documents. This document cannot be reproduced except in full, without prior written approval of the Company. Any unauthorized alteration, forgery or falsification of the content or appearance of this document is unlawful and offenders may be prosecuted to the fullest extent of the law.

Radar Type5_Trial16 for 5500MHz

Data Sheet for FCC Radar Type 5						
Trial Number:		16		VSG Frequency(MHz):		5498.3555
Number of Bursts in Trial:			19		Successful Detection: Yes	
Burst (8-20)	Number Pulses per Burst (1-3)	Pulse Width (50-100)	Chirp Width (5-20)	Pulse 1-to-2 Spacing	Pulse 2-to-3 Spacing	Starting Location Within Interval
		(μ sec)	(MHz)	(μ sec)	(μ sec)	(μ sec)
1	3	97.8	19	1035.2	1109.2	60664
2	3	98.9	19	1349.1	1179.1	212758
3	2	67.7	19	1877.3		365185
4	2	78.4	19	1897.6		517638
5	2	69.3	19	1353.7		42020
6	2	67.1	19	1256.9		194546
7	2	80.1	19	1704.9		346961
8	3	93.4	19	935.6	1527.6	498702
9	3	87.1	19	1769.9	1303.9	23150
10	3	94.9	19	1043.1	1752.1	175148
11	2	82.3	19	1429.7		328193
12	1	63.8	19			481836
13	2	69	19	1717		4428
14	2	82.1	19	1509.9		156800
15	1	63.9	19			310290
16	3	93.6	19	1131.4	1715.4	460941
17	3	89.5	19	1035.5	927.5	613436
18	3	94.3	19	1285.7	1082.7	137818
19	2	78.4	19	1681.6		290315
20						

Unless otherwise stated the results shown in this test report refer only to the sample(s) tested and such sample(s) are retained for 90 days only.

除非另有說明，此報告結果僅對測試之樣品負責，同時此樣品僅保留90天。本報告未經本公司書面許可，不可部份複製。

This document is issued by the Company subject to its General Conditions of Service printed overleaf, available on request or accessible at <http://www.sgs.com.tw/Terms-and-Conditions> and for electronic format documents, subject to Terms and Conditions for Electronic Documents at <http://www.sgs.com.tw/Terms-and-Conditions>. Attention is drawn to the limitation of liability, indemnification and jurisdiction issues defined therein. Any holder of this document is advised that information contained hereon reflects the Company's findings at the time of its intervention only and within the limits of Client's instructions, if any. The Company's sole responsibility is to its Client and this document does not exonerate parties to a transaction from exercising all their rights and obligations under the transaction documents. This document cannot be reproduced except in full, without prior written approval of the Company. Any unauthorized alteration, forgery or falsification of the content or appearance of this document is unlawful and offenders may be prosecuted to the fullest extent of the law.

SGS Taiwan Ltd.

No.134,Wu Kung Road, New Taipei Industrial Park, Wuku District, New Taipei City, Taiwan/新北市五股區新北產業園區五工路 134 號

台灣檢驗科技股份有限公司

t (886-2) 2299-3279

f (886-2) 2298-0488

www.sgs.com.tw

Member of SGS Group

Radar Type5_Trial17 for 5500MHz

Data Sheet for FCC Radar Type 5						
Trial Number:		17		VSG Frequency(MHz):		5493.5555
Number of Bursts in Trial:			10		Successful Detection: Yes	
Burst (8-20)	Number Pulses per Burst (1-3)	Pulse Width (50-100)	Chirp Width (5-20)	Pulse 1-to-2 Spacing	Pulse 2-to-3 Spacing	Starting Location Within Interval
		(μ sec)	(MHz)	(μ sec)	(μ sec)	(μ sec)
1	3	96.6	7	1648.4	1865.4	841832
2	2	75.3	7	1301.7		1134370
3	3	99.8	7	1691.2	928.2	226986
4	3	91.4	7	1351.6	1845.6	516768
5	3	91.3	7	1507.7	1109.7	806793
6	2	75.6	7	1497.4		1097643
7	2	68.2	7	1628.8		191388
8	1	62.3	7			482197
9	1	51	7			773239
10	1	59.6	7			1063311
11						
12						
13						
14						
15						
16						
17						
18						
19						
20						

Unless otherwise stated the results shown in this test report refer only to the sample(s) tested and such sample(s) are retained for 90 days only.

除非另有說明，此報告結果僅對測試之樣品負責，同時此樣品僅保留90天。本報告未經本公司書面許可，不可部份複製。

This document is issued by the Company subject to its General Conditions of Service printed overleaf, available on request or accessible at <http://www.sgs.com.tw/Terms-and-Conditions> and for electronic format documents, subject to Terms and Conditions for Electronic Documents at <http://www.sgs.com.tw/Terms-and-Conditions>. Attention is drawn to the limitation of liability, indemnification and jurisdiction issues defined therein. Any holder of this document is advised that information contained hereon reflects the Company's findings at the time of its intervention only and within the limits of Client's instructions, if any. The Company's sole responsibility is to its Client and this document does not exonerate parties to a transaction from exercising all their rights and obligations under the transaction documents. This document cannot be reproduced except in full, without prior written approval of the Company. Any unauthorized alteration, forgery or falsification of the content or appearance of this document is unlawful and offenders may be prosecuted to the fullest extent of the law.

Radar Type5_Trial18 for 5500MHz

Data Sheet for FCC Radar Type 5						
Trial Number:		18		VSG Frequency(MHz):		5495.9555
Number of Bursts in Trial:			14		Successful Detection: Yes	
Burst (8-20)	Number Pulses per Burst (1-3)	Pulse Width (50-100)	Chirp Width (5-20)	Pulse 1-to-2 Spacing	Pulse 2-to-3 Spacing	Starting Location Within Interval
		(μ sec)	(MHz)	(μ sec)	(μ sec)	(μ sec)
1	2	68.6	13	1499.4		111159
2	1	64.9	13			318639
3	3	89.4	13	1225.6	1206.6	525016
4	2	66.7	13	1407.3		732895
5	3	98.5	13	1094.5	1290.5	85461
6	1	60.1	13			293098
7	2	68.9	13	1207.1		499889
8	2	74	13	1650		706709
9	2	82.7	13	937.3		60119
10	3	89.7	13	913.3	1511.3	266981
11	2	79.6	13	1323.4		474208
12	3	93.4	13	1709.6	922.6	680794
13	1	63.3	13			34618
14	1	50.5	13			242067
15						
16						
17						
18						
19						
20						

Unless otherwise stated the results shown in this test report refer only to the sample(s) tested and such sample(s) are retained for 90 days only.

除非另有說明，此報告結果僅對測試之樣品負責，同時此樣品僅保留90天。本報告未經本公司書面許可，不可部份複製。

This document is issued by the Company subject to its General Conditions of Service printed overleaf, available on request or accessible at <http://www.sgs.com.tw/Terms-and-Conditions> and for electronic format documents, subject to Terms and Conditions for Electronic Documents at <http://www.sgs.com.tw/Terms-and-Conditions>. Attention is drawn to the limitation of liability, indemnification and jurisdiction issues defined therein. Any holder of this document is advised that information contained hereon reflects the Company's findings at the time of its intervention only and within the limits of Client's instructions, if any. The Company's sole responsibility is to its Client and this document does not exonerate parties to a transaction from exercising all their rights and obligations under the transaction documents. This document cannot be reproduced except in full, without prior written approval of the Company. Any unauthorized alteration, forgery or falsification of the content or appearance of this document is unlawful and offenders may be prosecuted to the fullest extent of the law.

Radar Type5_Trial19 for 5500MHz

Data Sheet for FCC Radar Type 5						
Trial Number:		19		VSG Frequency(MHz):		5494.3555
Number of Bursts in Trial:			11		Successful Detection: Yes	
Burst (8-20)	Number Pulses per Burst (1-3)	Pulse Width (50-100)	Chirp Width (5-20)	Pulse 1-to-2 Spacing	Pulse 2-to-3 Spacing	Starting Location Within Interval
		(μ sec)	(MHz)	(μ sec)	(μ sec)	(μ sec)
1	1	66	9			572486
2	2	67.7	9	1512.3		835382
3	1	61.6	9			11536
4	3	83.7	9	963.3	1336.3	275055
5	3	95.5	9	1832.5	1354.5	538089
6	2	76.8	9	1049.2		803017
7	1	63.9	9			1068197
8	2	66.7	9	1203.3		242891
9	2	78.3	9	998.7		507034
10	2	74.4	9	1755.6		770438
11	1	61.5	9			1035902
12						
13						
14						
15						
16						
17						
18						
19						
20						

Unless otherwise stated the results shown in this test report refer only to the sample(s) tested and such sample(s) are retained for 90 days only.

除非另有說明，此報告結果僅對測試之樣品負責，同時此樣品僅保留90天。本報告未經本公司書面許可，不可部份複製。

This document is issued by the Company subject to its General Conditions of Service printed overleaf, available on request or accessible at <http://www.sgs.com.tw/Terms-and-Conditions> and for electronic format documents, subject to Terms and Conditions for Electronic Documents at <http://www.sgs.com.tw/Terms-and-Conditions>. Attention is drawn to the limitation of liability, indemnification and jurisdiction issues defined therein. Any holder of this document is advised that information contained hereon reflects the Company's findings at the time of its intervention only and within the limits of Client's instructions, if any. The Company's sole responsibility is to its Client and this document does not exonerate parties to a transaction from exercising all their rights and obligations under the transaction documents. This document cannot be reproduced except in full, without prior written approval of the Company. Any unauthorized alteration, forgery or falsification of the content or appearance of this document is unlawful and offenders may be prosecuted to the fullest extent of the law.

SGS Taiwan Ltd.

No.134,Wu Kung Road, New Taipei Industrial Park, Wuku District, New Taipei City, Taiwan/新北市五股區新北產業園區五工路 134 號

台灣檢驗科技股份有限公司

t (886-2) 2299-3279

f (886-2) 2298-0488

www.sgs.com.tw

Member of SGS Group

Radar Type5_Trial20 for 5500MHz

Data Sheet for FCC Radar Type 5						
Trial Number:		20		VSG Frequency(MHz):		5497.1555
Number of Bursts in Trial:			17		Successful Detection: Yes	
Burst (8-20)	Number Pulses per Burst (1-3)	Pulse Width (50-100)	Chirp Width (5-20)	Pulse 1-to-2 Spacing	Pulse 2-to-3 Spacing	Starting Location Within Interval
		(μ sec)	(MHz)	(μ sec)	(μ sec)	(μ sec)
1	3	88	16	1256	919	135783
2	3	98	16	1506	1371	305527
3	1	57.4	16			478186
4	2	76.4	16	1773.6		646724
5	1	52.8	16			115148
6	1	51	16			285926
7	1	54.8	16			456935
8	2	79	16	1222		626758
9	3	83.8	16	1125.2	1487.2	93692
10	2	68.5	16	1802.5		264129
11	2	79.9	16	1904.1		434598
12	3	92.9	16	1398.1	1123.1	604219
13	3	97.1	16	1045.9	1166.9	72856
14	2	70.6	16	1757.4		243445
15	2	72	16	1359		413877
16	3	95	16	1255	1652	582964
17	2	69.5	16	1837.5		51895
18						
19						
20						

Unless otherwise stated the results shown in this test report refer only to the sample(s) tested and such sample(s) are retained for 90 days only.

除非另有說明，此報告結果僅對測試之樣品負責，同時此樣品僅保留90天。本報告未經本公司書面許可，不可部份複製。

This document is issued by the Company subject to its General Conditions of Service printed overleaf, available on request or accessible at <http://www.sgs.com.tw/Terms-and-Conditions> and for electronic format documents, subject to Terms and Conditions for Electronic Documents at <http://www.sgs.com.tw/Terms-and-Conditions>. Attention is drawn to the limitation of liability, indemnification and jurisdiction issues defined therein. Any holder of this document is advised that information contained hereon reflects the Company's findings at the time of its intervention only and within the limits of Client's instructions, if any. The Company's sole responsibility is to its Client and this document does not exonerate parties to a transaction from exercising all their rights and obligations under the transaction documents. This document cannot be reproduced except in full, without prior written approval of the Company. Any unauthorized alteration, forgery or falsification of the content or appearance of this document is unlawful and offenders may be prosecuted to the fullest extent of the law.

Radar Type5_Trial21 for 5500MHz

Data Sheet for FCC Radar Type 5						
Trial Number:		21		VSG Frequency(MHz):		5506.8445
Number of Bursts in Trial:			9		Successful Detection: Yes	
Burst (8-20)	Number Pulses per Burst (1-3)	Pulse Width (50-100)	Chirp Width (5-20)	Pulse 1-to-2 Spacing	Pulse 2-to-3 Spacing	Starting Location Within Interval
		(μ sec)	(MHz)	(μ sec)	(μ sec)	(μ sec)
1	1	56.7	6			421551
2	1	54.5	6			744478
3	3	98.9	6	1286.1	1719.1	1064529
4	1	53.1	6			58608
5	1	61.9	6			381621
6	3	99.2	6	1156.8	1217.8	703403
7	2	75.4	6	1653.6		1026298
8	2	73.6	6	1185.4		18794
9	1	64	6			341945
10						
11						
12						
13						
14						
15						
16						
17						
18						
19						
20						

Unless otherwise stated the results shown in this test report refer only to the sample(s) tested and such sample(s) are retained for 90 days only.

除非另有說明，此報告結果僅對測試之樣品負責，同時此樣品僅保留90天。本報告未經本公司書面許可，不可部份複製。

This document is issued by the Company subject to its General Conditions of Service printed overleaf, available on request or accessible at <http://www.sgs.com.tw/Terms-and-Conditions> and for electronic format documents, subject to Terms and Conditions for Electronic Documents at <http://www.sgs.com.tw/Terms-and-Conditions>. Attention is drawn to the limitation of liability, indemnification and jurisdiction issues defined therein. Any holder of this document is advised that information contained hereon reflects the Company's findings at the time of its intervention only and within the limits of Client's instructions, if any. The Company's sole responsibility is to its Client and this document does not exonerate parties to a transaction from exercising all their rights and obligations under the transaction documents. This document cannot be reproduced except in full, without prior written approval of the Company. Any unauthorized alteration, forgery or falsification of the content or appearance of this document is unlawful and offenders may be prosecuted to the fullest extent of the law.

SGS Taiwan Ltd.

No.134,Wu Kung Road, New Taipei Industrial Park, Wuku District, New Taipei City, Taiwan/新北市五股區新北產業園區五工路 134 號

台灣檢驗科技股份有限公司

t (886-2) 2299-3279

f (886-2) 2298-0488

www.sgs.com.tw

Member of SGS Group

Radar Type5_Trial22 for 5500MHz

Data Sheet for FCC Radar Type 5						
Trial Number:		22		VSG Frequency(MHz):		5504.0445
Number of Bursts in Trial:			14		Successful Detection: Yes	
Burst (8-20)	Number Pulses per Burst (1-3)	Pulse Width (50-100)	Chirp Width (5-20)	Pulse 1-to-2 Spacing	Pulse 2-to-3 Spacing	Starting Location Within Interval
		(μ sec)	(MHz)	(μ sec)	(μ sec)	(μ sec)
1	3	84.5	13	1021.5	1628.5	425699
2	2	66.8	13	1144.2		633700
3	2	74.3	13	1140.7		840682
4	3	95.7	13	904.3	958.3	193640
5	1	51.9	13			401335
6	3	86.7	13	1253.3	1160.3	607151
7	1	64.9	13			816306
8	1	55.2	13			168523
9	1	60.5	13			376178
10	1	62.1	13			583300
11	1	61.4	13			791044
12	3	97.6	13	1516.4	1265.4	142362
13	2	79.9	13	1880.1		349568
14	3	88.6	13	1675.4	1030.4	556281
15						
16						
17						
18						
19						
20						

Unless otherwise stated the results shown in this test report refer only to the sample(s) tested and such sample(s) are retained for 90 days only.

除非另有說明，此報告結果僅對測試之樣品負責，同時此樣品僅保留90天。本報告未經本公司書面許可，不可部份複製。

This document is issued by the Company subject to its General Conditions of Service printed overleaf, available on request or accessible at <http://www.sgs.com.tw/Terms-and-Conditions> and for electronic format documents, subject to Terms and Conditions for Electronic Documents at <http://www.sgs.com.tw/Terms-and-Conditions>. Attention is drawn to the limitation of liability, indemnification and jurisdiction issues defined therein. Any holder of this document is advised that information contained hereon reflects the Company's findings at the time of its intervention only and within the limits of Client's instructions, if any. The Company's sole responsibility is to its Client and this document does not exonerate parties to a transaction from exercising all their rights and obligations under the transaction documents. This document cannot be reproduced except in full, without prior written approval of the Company. Any unauthorized alteration, forgery or falsification of the content or appearance of this document is unlawful and offenders may be prosecuted to the fullest extent of the law.

SGS Taiwan Ltd.

No.134,Wu Kung Road, New Taipei Industrial Park, Wuku District, New Taipei City, Taiwan/新北市五股區新北產業園區五工路 134 號

台灣檢驗科技股份有限公司

t (886-2) 2299-3279

f (886-2) 2298-0488

www.sgs.com.tw

Member of SGS Group

Radar Type5_Trial23 for 5500MHz

Data Sheet for FCC Radar Type 5						
Trial Number:		23		VSG Frequency(MHz):		5503.6445
Number of Bursts in Trial:			15		Successful Detection: Yes	
Burst (8-20)	Number Pulses per Burst (1-3)	Pulse Width (50-100)	Chirp Width (5-20)	Pulse 1-to-2 Spacing	Pulse 2-to-3 Spacing	Starting Location Within Interval
		(μ sec)	(MHz)	(μ sec)	(μ sec)	(μ sec)
1	2	74.8	14	1903.2		712954
2	1	64.4	14			109577
3	2	79.6	14	947.4		302690
4	2	82.1	14	1141.9		496146
5	3	86.2	14	1236.8	989.8	688037
6	2	74.8	14	1243.2		85509
7	1	64.5	14			279236
8	1	63.1	14			472748
9	2	73.5	14	1362.5		665464
10	2	81.8	14	1385.2		61664
11	3	94.4	14	1855.6	961.6	254652
12	1	59.9	14			449055
13	2	73.7	14	1136.3		641555
14	2	75.6	14	1761.4		37890
15	1	58.4	14			231571
16						
17						
18						
19						
20						

Unless otherwise stated the results shown in this test report refer only to the sample(s) tested and such sample(s) are retained for 90 days only.

除非另有說明，此報告結果僅對測試之樣品負責，同時此樣品僅保留90天。本報告未經本公司書面許可，不可部份複製。

This document is issued by the Company subject to its General Conditions of Service printed overleaf, available on request or accessible at <http://www.sgs.com.tw/Terms-and-Conditions> and for electronic format documents, subject to Terms and Conditions for Electronic Documents at <http://www.sgs.com.tw/Terms-and-Conditions>. Attention is drawn to the limitation of liability, indemnification and jurisdiction issues defined therein. Any holder of this document is advised that information contained hereon reflects the Company's findings at the time of its intervention only and within the limits of Client's instructions, if any. The Company's sole responsibility is to its Client and this document does not exonerate parties to a transaction from exercising all their rights and obligations under the transaction documents. This document cannot be reproduced except in full, without prior written approval of the Company. Any unauthorized alteration, forgery or falsification of the content or appearance of this document is unlawful and offenders may be prosecuted to the fullest extent of the law.

Radar Type5_Trial24 for 5500MHz

Data Sheet for FCC Radar Type 5						
Trial Number:		24		VSG Frequency(MHz):		5506.8445
Number of Bursts in Trial:			9		Successful Detection: Yes	
Burst (8-20)	Number Pulses per Burst (1-3)	Pulse Width (50-100)	Chirp Width (5-20)	Pulse 1-to-2 Spacing	Pulse 2-to-3 Spacing	Starting Location Within Interval
		(μ sec)	(MHz)	(μ sec)	(μ sec)	(μ sec)
1	2	76.1	6	1613.9		708682
2	3	98.8	6	973.2	1563.2	1030464
3	2	82.1	6	1484.9		23490
4	1	52.8	6			346421
5	3	88.9	6	1759.1	1530.1	667789
6	1	66.6	6			992268
7	3	88	6	1717	1899	1311409
8	1	54.6	6			306766
9	3	88.1	6	1901.9	1340.9	628217
10						
11						
12						
13						
14						
15						
16						
17						
18						
19						
20						

Unless otherwise stated the results shown in this test report refer only to the sample(s) tested and such sample(s) are retained for 90 days only.

除非另有說明，此報告結果僅對測試之樣品負責，同時此樣品僅保留90天。本報告未經本公司書面許可，不可部份複製。

This document is issued by the Company subject to its General Conditions of Service printed overleaf, available on request or accessible at <http://www.sgs.com.tw/Terms-and-Conditions> and for electronic format documents, subject to Terms and Conditions for Electronic Documents at <http://www.sgs.com.tw/Terms-and-Conditions>. Attention is drawn to the limitation of liability, indemnification and jurisdiction issues defined therein. Any holder of this document is advised that information contained hereon reflects the Company's findings at the time of its intervention only and within the limits of Client's instructions, if any. The Company's sole responsibility is to its Client and this document does not exonerate parties to a transaction from exercising all their rights and obligations under the transaction documents. This document cannot be reproduced except in full, without prior written approval of the Company. Any unauthorized alteration, forgery or falsification of the content or appearance of this document is unlawful and offenders may be prosecuted to the fullest extent of the law.

SGS Taiwan Ltd.

No.134,Wu Kung Road, New Taipei Industrial Park, Wuku District, New Taipei City, Taiwan/新北市五股區新北產業園區五工路 134 號

台灣檢驗科技股份有限公司

t (886-2) 2299-3279

f (886-2) 2298-0488

www.sgs.com.tw

Member of SGS Group

Radar Type5_Trial25 for 5500MHz

Data Sheet for FCC Radar Type 5						
Trial Number:		25		VSG Frequency(MHz):		5505.2445
Number of Bursts in Trial:			12		Successful Detection: Yes	
Burst (8-20)	Number Pulses per Burst (1-3)	Pulse Width (50-100)	Chirp Width (5-20)	Pulse 1-to-2 Spacing	Pulse 2-to-3 Spacing	Starting Location Within Interval
		(μ sec)	(MHz)	(μ sec)	(μ sec)	(μ sec)
1	1	66.5	10			713981
2	3	93.2	10	1318.8	1383.8	954060
3	2	77.9	10	1604.1		199837
4	3	91.9	10	1294.1	1759.1	440713
5	1	60	10			684224
6	1	59.8	10			926991
7	3	83.6	10	1361.4	1524.4	169870
8	2	72	10	1008		411973
9	2	76.9	10	1546.1		653647
10	1	65.9	10			896784
11	2	74	10	1743		140278
12	3	88.8	10	1123.2	978.2	381664
13						
14						
15						
16						
17						
18						
19						
20						

Unless otherwise stated the results shown in this test report refer only to the sample(s) tested and such sample(s) are retained for 90 days only.

除非另有說明，此報告結果僅對測試之樣品負責，同時此樣品僅保留90天。本報告未經本公司書面許可，不可部份複製。

This document is issued by the Company subject to its General Conditions of Service printed overleaf, available on request or accessible at <http://www.sgs.com.tw/Terms-and-Conditions> and for electronic format documents, subject to Terms and Conditions for Electronic Documents at <http://www.sgs.com.tw/Terms-and-Conditions>. Attention is drawn to the limitation of liability, indemnification and jurisdiction issues defined therein. Any holder of this document is advised that information contained hereon reflects the Company's findings at the time of its intervention only and within the limits of Client's instructions, if any. The Company's sole responsibility is to its Client and this document does not exonerate parties to a transaction from exercising all their rights and obligations under the transaction documents. This document cannot be reproduced except in full, without prior written approval of the Company. Any unauthorized alteration, forgery or falsification of the content or appearance of this document is unlawful and offenders may be prosecuted to the fullest extent of the law.

Radar Type5_Trial26 for 5500MHz

Data Sheet for FCC Radar Type 5						
Trial Number:		26		VSG Frequency(MHz):		5503.6445
Number of Bursts in Trial:			15		Successful Detection: Yes	
Burst (8-20)	Number Pulses per Burst (1-3)	Pulse Width (50-100)	Chirp Width (5-20)	Pulse 1-to-2 Spacing	Pulse 2-to-3 Spacing	Starting Location Within Interval
		(μ sec)	(MHz)	(μ sec)	(μ sec)	(μ sec)
1	2	82.4	14	1229.6		498536
2	2	67.1	14	1773.9		692019
3	3	89.3	14	1756.7	1617.7	88107
4	3	98.9	14	1600.1	1443.1	281127
5	3	99.5	14	1867.5	1028.5	474098
6	2	71.4	14	1023.6		668574
7	3	93.3	14	1751.7	1007.7	64396
8	3	92.6	14	1705.4	1299.4	257232
9	1	51.2	14			451923
10	3	92	14	1685	1843	642653
11	1	63	14			40796
12	3	89.4	14	1839.6	1564.6	233502
13	3	96.9	14	1282.1	1638.1	426399
14	3	84.5	14	1494.5	1024.5	619777
15	1	63.3	14			16934
16						
17						
18						
19						
20						

Unless otherwise stated the results shown in this test report refer only to the sample(s) tested and such sample(s) are retained for 90 days only.

除非另有說明，此報告結果僅對測試之樣品負責，同時此樣品僅保留90天。本報告未經本公司書面許可，不可部份複製。

This document is issued by the Company subject to its General Conditions of Service printed overleaf, available on request or accessible at <http://www.sgs.com.tw/Terms-and-Conditions> and for electronic format documents, subject to Terms and Conditions for Electronic Documents at <http://www.sgs.com.tw/Terms-and-Conditions>. Attention is drawn to the limitation of liability, indemnification and jurisdiction issues defined therein. Any holder of this document is advised that information contained hereon reflects the Company's findings at the time of its intervention only and within the limits of Client's instructions, if any. The Company's sole responsibility is to its Client and this document does not exonerate parties to a transaction from exercising all their rights and obligations under the transaction documents. This document cannot be reproduced except in full, without prior written approval of the Company. Any unauthorized alteration, forgery or falsification of the content or appearance of this document is unlawful and offenders may be prosecuted to the fullest extent of the law.

Radar Type5_Trial27 for 5500MHz

Data Sheet for FCC Radar Type 5						
Trial Number:		27		VSG Frequency(MHz):		5502.8445
Number of Bursts in Trial:			17		Successful Detection: Yes	
Burst (8-20)	Number Pulses per Burst (1-3)	Pulse Width (50-100)	Chirp Width (5-20)	Pulse 1-to-2 Spacing	Pulse 2-to-3 Spacing	Starting Location Within Interval
		(μ sec)	(MHz)	(μ sec)	(μ sec)	(μ sec)
1	2	79.4	16	1554.6		185404
2	3	94.8	16	1571.2	1078.2	355243
3	3	91.1	16	1445.9	1467.9	524957
4	2	72	16	1706		696602
5	3	86.8	16	1170.2	1767.2	164009
6	1	59.7	16			335368
7	3	91.5	16	1447.5	1197.5	504553
8	1	65.5	16			677665
9	3	93	16	978	1696	143140
10	3	96.9	16	1185.1	1071.1	313396
11	2	72.6	16	976.4		484806
12	1	53	16			655886
13	1	63.7	16			122700
14	3	98.2	16	939.8	1156.8	292699
15	2	72.4	16	1661.6		463032
16	2	83.1	16	955.9		633961
17	1	57.7	16			101592
18						
19						
20						

Unless otherwise stated the results shown in this test report refer only to the sample(s) tested and such sample(s) are retained for 90 days only.

除非另有說明，此報告結果僅對測試之樣品負責，同時此樣品僅保留90天。本報告未經本公司書面許可，不可部份複製。

This document is issued by the Company subject to its General Conditions of Service printed overleaf, available on request or accessible at <http://www.sgs.com.tw/Terms-and-Conditions> and for electronic format documents, subject to Terms and Conditions for Electronic Documents at <http://www.sgs.com.tw/Terms-and-Conditions>. Attention is drawn to the limitation of liability, indemnification and jurisdiction issues defined therein. Any holder of this document is advised that information contained hereon reflects the Company's findings at the time of its intervention only and within the limits of Client's instructions, if any. The Company's sole responsibility is to its Client and this document does not exonerate parties to a transaction from exercising all their rights and obligations under the transaction documents. This document cannot be reproduced except in full, without prior written approval of the Company. Any unauthorized alteration, forgery or falsification of the content or appearance of this document is unlawful and offenders may be prosecuted to the fullest extent of the law.

Radar Type5_Trial28 for 5500MHz

Data Sheet for FCC Radar Type 5						
Trial Number:		28		VSG Frequency(MHz):		5503.2445
Number of Bursts in Trial:			16		Successful Detection: Yes	
Burst (8-20)	Number Pulses per Burst (1-3)	Pulse Width (50-100)	Chirp Width (5-20)	Pulse 1-to-2 Spacing	Pulse 2-to-3 Spacing	Starting Location Within Interval
		(μ sec)	(MHz)	(μ sec)	(μ sec)	(μ sec)
1	1	51.6	15			289349
2	2	69.6	15	1249.4		470024
3	3	93.7	15	1041.3	1150.3	650118
4	2	81.7	15	1884.3		85378
5	3	92.9	15	1015.1	1041.1	266411
6	1	54	15			448486
7	3	89.4	15	1661.6	1625.6	627280
8	3	95.2	15	1199.8	1312.8	63036
9	3	94.8	15	1874.2	1264.2	243526
10	1	62	15			426457
11	3	86.8	15	1765.2	1300.2	605400
12	2	74.6	15	1030.4		40835
13	2	80.2	15	1433.8		221894
14	3	88.6	15	1584.4	1204.4	402325
15	3	95.1	15	1364.9	1513.9	582845
16	2	75.6	15	1550.4		18465
17						
18						
19						
20						

Unless otherwise stated the results shown in this test report refer only to the sample(s) tested and such sample(s) are retained for 90 days only.

除非另有說明，此報告結果僅對測試之樣品負責，同時此樣品僅保留90天。本報告未經本公司書面許可，不可部份複製。

This document is issued by the Company subject to its General Conditions of Service printed overleaf, available on request or accessible at <http://www.sgs.com.tw/Terms-and-Conditions> and for electronic format documents, subject to Terms and Conditions for Electronic Documents at <http://www.sgs.com.tw/Terms-and-Conditions>. Attention is drawn to the limitation of liability, indemnification and jurisdiction issues defined therein. Any holder of this document is advised that information contained hereon reflects the Company's findings at the time of its intervention only and within the limits of Client's instructions, if any. The Company's sole responsibility is to its Client and this document does not exonerate parties to a transaction from exercising all their rights and obligations under the transaction documents. This document cannot be reproduced except in full, without prior written approval of the Company. Any unauthorized alteration, forgery or falsification of the content or appearance of this document is unlawful and offenders may be prosecuted to the fullest extent of the law.

Radar Type5_Trial29 for 5500MHz

Data Sheet for FCC Radar Type 5						
Trial Number:		29		VSG Frequency(MHz):		5505.2445
Number of Bursts in Trial:			12		Successful Detection: Yes	
Burst (8-20)	Number Pulses per Burst (1-3)	Pulse Width (50-100)	Chirp Width (5-20)	Pulse 1-to-2 Spacing	Pulse 2-to-3 Spacing	Starting Location Within Interval
		(μ sec)	(MHz)	(μ sec)	(μ sec)	(μ sec)
1	3	96.5	10	1604.5	1082.5	265973
2	1	54.2	10			509016
3	2	77.3	10	1263.7		749934
4	3	85.8	10	1593.2	1151.2	990734
5	3	93.9	10	920.1	1876.1	236405
6	3	87.2	10	999.8	1300.8	477860
7	2	79	10	980		720257
8	3	91	10	977	918	961256
9	1	51.6	10			207126
10	3	96.3	10	1180.7	1203.7	448163
11	1	51.9	10			691269
12	2	76.9	10	1126.1		932778
13						
14						
15						
16						
17						
18						
19						
20						

Unless otherwise stated the results shown in this test report refer only to the sample(s) tested and such sample(s) are retained for 90 days only.

除非另有說明，此報告結果僅對測試之樣品負責，同時此樣品僅保留90天。本報告未經本公司書面許可，不可部份複製。

This document is issued by the Company subject to its General Conditions of Service printed overleaf, available on request or accessible at <http://www.sgs.com.tw/Terms-and-Conditions> and for electronic format documents, subject to Terms and Conditions for Electronic Documents at <http://www.sgs.com.tw/Terms-and-Conditions>. Attention is drawn to the limitation of liability, indemnification and jurisdiction issues defined therein. Any holder of this document is advised that information contained hereon reflects the Company's findings at the time of its intervention only and within the limits of Client's instructions, if any. The Company's sole responsibility is to its Client and this document does not exonerate parties to a transaction from exercising all their rights and obligations under the transaction documents. This document cannot be reproduced except in full, without prior written approval of the Company. Any unauthorized alteration, forgery or falsification of the content or appearance of this document is unlawful and offenders may be prosecuted to the fullest extent of the law.

SGS Taiwan Ltd.

No.134,Wu Kung Road, New Taipei Industrial Park, Wuku District, New Taipei City, Taiwan/新北市五股區新北產業園區五工路 134 號

台灣檢驗科技股份有限公司

t (886-2) 2299-3279

f (886-2) 2298-0488

www.sgs.com.tw

Member of SGS Group

Radar Type5_Trial30 for 5500MHz

Data Sheet for FCC Radar Type 5						
Trial Number:		30		VSG Frequency(MHz):		5501.6445
Number of Bursts in Trial:			19	Successful Detection:		Yes
Burst (8-20)	Number Pulses per Burst (1-3)	Pulse Width (50-100)	Chirp Width (5-20)	Pulse 1-to-2 Spacing	Pulse 2-to-3 Spacing	Starting Location Within Interval
		(μ sec)	(MHz)	(μ sec)	(μ sec)	(μ sec)
1	2	68.3	19	1287.7		111742
2	2	79.5	19	1375.5		263974
3	3	94.4	19	1371.6	1809.6	415412
4	2	78.9	19	1033.1		569750
5	1	58.9	19			93035
6	1	55.2	19			245758
7	3	87.8	19	1741.2	931.2	396617
8	2	77.2	19	1149.8		550426
9	3	90.8	19	1320.2	1427.2	73959
10	2	81.7	19	1204.3		226712
11	3	86.5	19	1320.5	1309.5	378328
12	3	90.7	19	1303.3	1374.3	530663
13	1	51.6	19			55500
14	2	76.9	19	1169.1		207885
15	3	92.1	19	1109.9	1723.9	359389
16	3	97.8	19	1590.2	1052.2	511380
17	1	54.6	19			36611
18	3	91	19	1234	1848	188355
19	1	62.7	19			342053
20						

Unless otherwise stated the results shown in this test report refer only to the sample(s) tested and such sample(s) are retained for 90 days only.

除非另有說明，此報告結果僅對測試之樣品負責，同時此樣品僅保留90天。本報告未經本公司書面許可，不可部份複製。

This document is issued by the Company subject to its General Conditions of Service printed overleaf, available on request or accessible at <http://www.sgs.com.tw/Terms-and-Conditions> and for electronic format documents, subject to Terms and Conditions for Electronic Documents at <http://www.sgs.com.tw/Terms-and-Conditions>. Attention is drawn to the limitation of liability, indemnification and jurisdiction issues defined therein. Any holder of this document is advised that information contained hereon reflects the Company's findings at the time of its intervention only and within the limits of Client's instructions, if any. The Company's sole responsibility is to its Client and this document does not exonerate parties to a transaction from exercising all their rights and obligations under the transaction documents. This document cannot be reproduced except in full, without prior written approval of the Company. Any unauthorized alteration, forgery or falsification of the content or appearance of this document is unlawful and offenders may be prosecuted to the fullest extent of the law.

Radar Type6 for 5500MHz

Data Sheet for FCC Radar Type 6

Trial	Pulse Width	PRI	Pulses per Hop	Hopping Rate	Hopping Sequence Length	Successful Detection
	(μ sec)	(μ sec)		(kHz)	(msec)	(Yes/No)
1	1	333	9	0.333	300	Yes
2	1	333	9	0.333	300	Yes
3	1	333	9	0.333	300	Yes
4	1	333	9	0.333	300	Yes
5	1	333	9	0.333	300	Yes
6	1	333	9	0.333	300	Yes
7	1	333	9	0.333	300	Yes
8	1	333	9	0.333	300	Yes
9	1	333	9	0.333	300	Yes
10	1	333	9	0.333	300	Yes
11	1	333	9	0.333	300	Yes
12	1	333	9	0.333	300	Yes
13	1	333	9	0.333	300	Yes
14	1	333	9	0.333	300	Yes
15	1	333	9	0.333	300	Yes
16	1	333	9	0.333	300	Yes
17	1	333	9	0.333	300	Yes
18	1	333	9	0.333	300	Yes
19	1	333	9	0.333	300	Yes
20	1	333	9	0.333	300	Yes
21	1	333	9	0.333	300	Yes
22	1	333	9	0.333	300	Yes
23	1	333	9	0.333	300	Yes
24	1	333	9	0.333	300	Yes
25	1	333	9	0.333	300	Yes
26	1	333	9	0.333	300	Yes
27	1	333	9	0.333	300	Yes
28	1	333	9	0.333	300	Yes
29	1	333	9	0.333	300	Yes
30	1	333	9	0.333	300	Yes

Unless otherwise stated the results shown in this test report refer only to the sample(s) tested and such sample(s) are retained for 90 days only.

除非另有說明，此報告結果僅對測試之樣品負責，同時此樣品僅保留90天。本報告未經本公司書面許可，不可部份複製。

This document is issued by the Company subject to its General Conditions of Service printed overleaf, available on request or accessible at <http://www.sgs.com.tw/Terms-and-Conditions> and for electronic format documents, subject to Terms and Conditions for Electronic Documents at <http://www.sgs.com.tw/Terms-and-Conditions>. Attention is drawn to the limitation of liability, indemnification and jurisdiction issues defined therein. Any holder of this document is advised that information contained hereon reflects the Company's findings at the time of its intervention only and within the limits of Client's instructions, if any. The Company's sole responsibility is to its Client and this document does not exonerate parties to a transaction from exercising all their rights and obligations under the transaction documents. This document cannot be reproduced except in full, without prior written approval of the Company. Any unauthorized alteration, forgery or falsification of the content or appearance of this document is unlawful and offenders may be prosecuted to the fullest extent of the law.

HE40_5310MHz

Short Pulse Radar Type	Minimum Number of Trials	Detection(%)		Minmum Percentage of Successful Detection(%)	Pass/Fail
1	30	100		60	Pass
2	30	100		60	Pass
3	30	100		60	Pass
4	30	100		60	Pass
Aggregate (Radar Types 1-4)	120	100		80	Pass
Long Pulse Radar Type	Minimum Number of Trials	Each Detection(%)	Total Detection(%)	Minmum Percentage of Successful Detection(%)	Pass/Fail
5	Center:10	100	100	80	Pass
	Low Edge:10	100			
	High Edge:10	100			
Frequency Hopping Radar Type	Minimum Number of Trials	Detection(%)		Minmum Percentage of Successful Detection(%)	Pass/Fail
6	30	96.66666667		70	Pass

Unless otherwise stated the results shown in this test report refer only to the sample(s) tested and such sample(s) are retained for 90 days only.

除非另有說明，此報告結果僅對測試之樣品負責，同時此樣品僅保留90天。本報告未經本公司書面許可，不可部份複製。

This document is issued by the Company subject to its General Conditions of Service printed overleaf, available on request or accessible at <http://www.sgs.com.tw/Terms-and-Conditions> and for electronic format documents, subject to Terms and Conditions for Electronic Documents at <http://www.sgs.com.tw/Terms-and-Conditions>. Attention is drawn to the limitation of liability, indemnification and jurisdiction issues defined therein. Any holder of this document is advised that information contained hereon reflects the Company's findings at the time of its intervention only and within the limits of Client's instructions, if any. The Company's sole responsibility is to its Client and this document does not exonerate parties to a transaction from exercising all their rights and obligations under the transaction documents. This document cannot be reproduced except in full, without prior written approval of the Company. Any unauthorized alteration, forgery or falsification of the content or appearance of this document is unlawful and offenders may be prosecuted to the fullest extent of the law.

Radar Type1 for 5310MHz

Data Sheet for FCC Radar Type 1

Trial	VSG Frequency (MHz)	Pulse Repetition Frequency Number (1 to 23)	Pulse Repetition Frequency	PRI	Test A/B	Successful Detection
			(Pulses Per Second)	(msec)	A/B	(Yes/No)
1	5310	13	1319.3	758	A	Yes
2	5310	21	1089.3	918	A	Yes
3	5310	8	1519.8	658	A	Yes
4	5310	19	1139	878	A	Yes
5	5310	18	1165.5	858	A	Yes
6	5310	11	1392.8	718	A	Yes
7	5310	6	1618.1	618	A	Yes
8	5310	10	1432.7	698	A	Yes
9	5310	16	1222.5	818	A	Yes
10	5310	17	1193.3	838	A	Yes
11	5310	23	326.2	3066	A	Yes
12	5310	9	1474.9	678	A	Yes
13	5310	4	1730.1	578	A	Yes
14	5310	5	1672.2	598	A	Yes
15	5310	1	1930.5	518	A	Yes
16	5310	-	533.6	1874	B	Yes
17	5310	-	471.7	2120	B	Yes
18	5310	-	342.2	2922	B	Yes
19	5310	-	993	1007	B	Yes
20	5310	-	1257.9	795	B	Yes
21	5310	-	742.9	1346	B	Yes
22	5310	-	814.3	1228	B	Yes
23	5310	-	403.1	2481	B	Yes
24	5310	-	700.8	1427	B	Yes
25	5310	-	1831.5	546	B	Yes
26	5310	-	1251.6	799	B	Yes
27	5310	-	483.6	2068	B	Yes
28	5310	-	970.9	1030	B	Yes
29	5310	-	449.6	2224	B	Yes
30	5310	-	687.8	1454	B	Yes

Unless otherwise stated the results shown in this test report refer only to the sample(s) tested and such sample(s) are retained for 90 days only.

除非另有說明，此報告結果僅對測試之樣品負責，同時此樣品僅保留90天。本報告未經本公司書面許可，不可部份複製。

This document is issued by the Company subject to its General Conditions of Service printed overleaf, available on request or accessible at <http://www.sgs.com.tw/Terms-and-Conditions> and for electronic format documents, subject to Terms and Conditions for Electronic Documents at <http://www.sgs.com.tw/Terms-and-Conditions>. Attention is drawn to the limitation of liability, indemnification and jurisdiction issues defined therein. Any holder of this document is advised that information contained hereon reflects the Company's findings at the time of its intervention only and within the limits of Client's instructions, if any. The Company's sole responsibility is to its Client and this document does not exonerate parties to a transaction from exercising all their rights and obligations under the transaction documents. This document cannot be reproduced except in full, without prior written approval of the Company. Any unauthorized alteration, forgery or falsification of the content or appearance of this document is unlawful and offenders may be prosecuted to the fullest extent of the law.

SGS Taiwan Ltd.

No.134,Wu Kung Road, New Taipei Industrial Park, Wuku District, New Taipei City, Taiwan/新北市五股區新北產業園區五工路 134 號

台灣檢驗科技股份有限公司

t (886-2) 2299-3279

f (886-2) 2298-0488

www.sgs.com.tw

Member of SGS Group

Radar Type2 for 5310MHz

Data Sheet for FCC Radar Type 2

Trial	VSG Frequency (MHz)	Number Pulses per Burst (23-29)	Pulse Width (1-5)	PRI (150-230)	Successful Detection
			(μ s)	(μ s)	(Yes/No)
1	5310	29	4.9	195	Yes
2	5310	28	4.1	153	Yes
3	5310	26	3.2	151	Yes
4	5310	23	1.2	227	Yes
5	5310	23	1.1	179	Yes
6	5310	26	2.9	166	Yes
7	5310	26	2.7	174	Yes
8	5310	24	2.1	230	Yes
9	5310	24	1.9	180	Yes
10	5310	29	4.8	223	Yes
11	5310	26	3.2	193	Yes
12	5310	24	1.9	155	Yes
13	5310	28	4	187	Yes
14	5310	29	5	206	Yes
15	5310	27	3.6	220	Yes
16	5310	29	4.7	175	Yes
17	5310	24	1.7	204	Yes
18	5310	26	3.1	181	Yes
19	5310	25	2.2	228	Yes
20	5310	28	4	182	Yes
21	5310	23	1.4	198	Yes
22	5310	26	3	199	Yes
23	5310	27	3.3	152	Yes
24	5310	23	1.3	178	Yes
25	5310	25	2.2	207	Yes
26	5310	27	3.4	159	Yes
27	5310	28	3.9	225	Yes
28	5310	27	3.6	168	Yes
29	5310	25	2.3	177	Yes
30	5310	29	4.7	205	Yes

Unless otherwise stated the results shown in this test report refer only to the sample(s) tested and such sample(s) are retained for 90 days only.

除非另有說明，此報告結果僅對測試之樣品負責，同時此樣品僅保留90天。本報告未經本公司書面許可，不可部份複製。

This document is issued by the Company subject to its General Conditions of Service printed overleaf, available on request or accessible at <http://www.sgs.com.tw/Terms-and-Conditions> and for electronic format documents, subject to Terms and Conditions for Electronic Documents at <http://www.sgs.com.tw/Terms-and-Conditions>. Attention is drawn to the limitation of liability, indemnification and jurisdiction issues defined therein. Any holder of this document is advised that information contained hereon reflects the Company's findings at the time of its intervention only and within the limits of Client's instructions, if any. The Company's sole responsibility is to its Client and this document does not exonerate parties to a transaction from exercising all their rights and obligations under the transaction documents. This document cannot be reproduced except in full, without prior written approval of the Company. Any unauthorized alteration, forgery or falsification of the content or appearance of this document is unlawful and offenders may be prosecuted to the fullest extent of the law.

Radar Type3 for 5310MHz

Data Sheet for FCC Radar Type 3

Trial	VSG Frequency (MHz)	Number Pulses per Burst (16-18)	Pulse Width (6-10)	PRI (200-500)	Successful Detection
			(μ s)	(μ s)	(Yes/No)
1	5310	18	9.9	442	Yes
2	5310	18	9.1	499	Yes
3	5310	17	8.2	273	Yes
4	5310	16	6.2	338	Yes
5	5310	16	6.1	487	Yes
6	5310	17	7.9	420	Yes
7	5310	17	7.7	450	Yes
8	5310	16	7.1	339	Yes
9	5310	16	6.9	405	Yes
10	5310	18	9.8	223	Yes
11	5310	17	8.2	453	Yes
12	5310	16	6.9	417	Yes
13	5310	18	9	400	Yes
14	5310	18	10	498	Yes
15	5310	17	8.6	274	Yes
16	5310	18	9.7	431	Yes
17	5310	16	6.7	294	Yes
18	5310	17	8.1	203	Yes
19	5310	16	7.2	298	Yes
20	5310	18	9	473	Yes
21	5310	16	6.4	407	Yes
22	5310	17	8	258	Yes
23	5310	17	8.3	249	Yes
24	5310	16	6.3	446	Yes
25	5310	16	7.2	486	Yes
26	5310	17	8.4	480	Yes
27	5310	18	8.9	370	Yes
28	5310	17	8.6	348	Yes
29	5310	16	7.3	401	Yes
30	5310	18	9.7	264	Yes

Unless otherwise stated the results shown in this test report refer only to the sample(s) tested and such sample(s) are retained for 90 days only.

除非另有說明，此報告結果僅對測試之樣品負責，同時此樣品僅保留90天。本報告未經本公司書面許可，不可部份複製。

This document is issued by the Company subject to its General Conditions of Service printed overleaf, available on request or accessible at <http://www.sgs.com.tw/Terms-and-Conditions> and for electronic format documents, subject to Terms and Conditions for Electronic Documents at <http://www.sgs.com.tw/Terms-and-Conditions>. Attention is drawn to the limitation of liability, indemnification and jurisdiction issues defined therein. Any holder of this document is advised that information contained hereon reflects the Company's findings at the time of its intervention only and within the limits of Client's instructions, if any. The Company's sole responsibility is to its Client and this document does not exonerate parties to a transaction from exercising all their rights and obligations under the transaction documents. This document cannot be reproduced except in full, without prior written approval of the Company. Any unauthorized alteration, forgery or falsification of the content or appearance of this document is unlawful and offenders may be prosecuted to the fullest extent of the law.

Radar Type4 for 5310MHz

Data Sheet for FCC Radar Type 4

Trial	VSG Frequency (MHz)	Number Pulses per Burst (12-16)	Pulse Width (11-20)	PRI (200-500)	Successful Detection
			(μ s)	(μ s)	(Yes/No)
1	5310	16	19.6	442	Yes
2	5310	15	17.8	499	Yes
3	5310	14	15.8	273	Yes
4	5310	12	11.4	338	Yes
5	5310	12	11.3	487	Yes
6	5310	14	15.3	420	Yes
7	5310	14	14.9	450	Yes
8	5310	13	13.5	339	Yes
9	5310	13	13.1	405	Yes
10	5310	16	19.5	223	Yes
11	5310	14	16	453	Yes
12	5310	13	13	417	Yes
13	5310	15	17.8	400	Yes
14	5310	16	20	498	Yes
15	5310	15	16.9	274	Yes
16	5310	16	19.2	431	Yes
17	5310	12	12.6	294	Yes
18	5310	14	15.6	203	Yes
19	5310	13	13.6	298	Yes
20	5310	15	17.6	473	Yes
21	5310	12	12.1	407	Yes
22	5310	14	15.5	258	Yes
23	5310	14	16.2	249	Yes
24	5310	12	11.7	446	Yes
25	5310	13	13.8	486	Yes
26	5310	15	16.5	480	Yes
27	5310	15	17.5	370	Yes
28	5310	15	16.8	348	Yes
29	5310	13	13.9	401	Yes
30	5310	16	19.3	264	Yes

Unless otherwise stated the results shown in this test report refer only to the sample(s) tested and such sample(s) are retained for 90 days only.

除非另有說明，此報告結果僅對測試之樣品負責，同時此樣品僅保留90天。本報告未經本公司書面許可，不可部份複製。

This document is issued by the Company subject to its General Conditions of Service printed overleaf, available on request or accessible at <http://www.sgs.com.tw/Terms-and-Conditions> and for electronic format documents, subject to Terms and Conditions for Electronic Documents at <http://www.sgs.com.tw/Terms-and-Conditions>. Attention is drawn to the limitation of liability, indemnification and jurisdiction issues defined therein. Any holder of this document is advised that information contained hereon reflects the Company's findings at the time of its intervention only and within the limits of Client's instructions, if any. The Company's sole responsibility is to its Client and this document does not exonerate parties to a transaction from exercising all their rights and obligations under the transaction documents. This document cannot be reproduced except in full, without prior written approval of the Company. Any unauthorized alteration, forgery or falsification of the content or appearance of this document is unlawful and offenders may be prosecuted to the fullest extent of the law.

Radar Type5_Trial1 for 5310MHz

Data Sheet for FCC Radar Type 5						
Trial Number:			1	VSG Frequency(MHz):		5310
Number of Bursts in Trial:			20	Successful Detection:		Yes
Burst (8-20)	Number Pulses per Burst (1-3)	Pulse Width (50-100)	Chirp Width (5-20)	Pulse 1-to-2 Spacing	Pulse 2-to-3 Spacing	Starting Location Within Interval
		(μ sec)	(MHz)	(μ sec)	(μ sec)	(μ sec)
1	3	97.7	20	1034.3	1421.3	116141
2	3	87.9	20	1634.1	1463.1	260383
3	2	76.9	20	929.1		406435
4	1	52.4	20			552540
5	1	51.8	20			98818
6	2	74	20	1785		243337
7	2	71.7	20	1586.3		388146
8	1	64	20			534217
9	1	61.5	20			80882
10	3	97.3	20	912.7	1544.7	224944
11	2	77.7	20	1096.3		370763
12	1	61.1	20			516312
13	3	87.5	20	1260.5	1441.5	62728
14	3	99.7	20	1776.3	1284.3	207224
15	2	82.7	20	1140.3		352481
16	3	95.2	20	1213.8	1162.8	495985
17	1	59.1	20			45158
18	2	75.6	20	1041.4		189991
19	1	64.7	20			335648
20	3	86.8	20	918.2	1652.2	478439

Unless otherwise stated the results shown in this test report refer only to the sample(s) tested and such sample(s) are retained for 90 days only.

除非另有說明，此報告結果僅對測試之樣品負責，同時此樣品僅保留90天。本報告未經本公司書面許可，不可部份複製。

This document is issued by the Company subject to its General Conditions of Service printed overleaf, available on request or accessible at <http://www.sgs.com.tw/Terms-and-Conditions> and for electronic format documents, subject to Terms and Conditions for Electronic Documents at <http://www.sgs.com.tw/Terms-and-Conditions>. Attention is drawn to the limitation of liability, indemnification and jurisdiction issues defined therein. Any holder of this document is advised that information contained hereon reflects the Company's findings at the time of its intervention only and within the limits of Client's instructions, if any. The Company's sole responsibility is to its Client and this document does not exonerate parties to a transaction from exercising all their rights and obligations under the transaction documents. This document cannot be reproduced except in full, without prior written approval of the Company. Any unauthorized alteration, forgery or falsification of the content or appearance of this document is unlawful and offenders may be prosecuted to the fullest extent of the law.

Radar Type5_Trial2 for 5310MHz

Data Sheet for FCC Radar Type 5						
Trial Number:		2		VSG Frequency(MHz):		5310
Number of Bursts in Trial:			17		Successful Detection: Yes	
Burst (8-20)	Number Pulses per Burst (1-3)	Pulse Width (50-100)	Chirp Width (5-20)	Pulse 1-to-2 Spacing	Pulse 2-to-3 Spacing	Starting Location Within Interval
		(μ sec)	(MHz)	(μ sec)	(μ sec)	(μ sec)
1	1	56	17			32097
2	2	75.2	17	1446.8		202501
3	2	79.1	17	1594.9		372874
4	1	54.1	17			544886
5	1	65.8	17			11064
6	2	80.4	17	1102.6		181560
7	3	86	17	1685	1290	351173
8	2	82.4	17	1445.6		522390
9	1	66.3	17			694725
10	3	95.8	17	970.2	1319.2	160367
11	3	85.6	17	1831.4	1791.4	329885
12	1	51	17			502809
13	1	64.7	17			673232
14	3	90.6	17	1053.4	1866.4	139129
15	1	53.4	17			310563
16	3	96.2	17	1065.8	1773.8	479259
17	1	65.5	17			652703
18						
19						
20						

Unless otherwise stated the results shown in this test report refer only to the sample(s) tested and such sample(s) are retained for 90 days only.

除非另有說明，此報告結果僅對測試之樣品負責，同時此樣品僅保留90天。本報告未經本公司書面許可，不可部份複製。

This document is issued by the Company subject to its General Conditions of Service printed overleaf, available on request or accessible at <http://www.sgs.com.tw/Terms-and-Conditions> and for electronic format documents, subject to Terms and Conditions for Electronic Documents at <http://www.sgs.com.tw/Terms-and-Conditions>. Attention is drawn to the limitation of liability, indemnification and jurisdiction issues defined therein. Any holder of this document is advised that information contained hereon reflects the Company's findings at the time of its intervention only and within the limits of Client's instructions, if any. The Company's sole responsibility is to its Client and this document does not exonerate parties to a transaction from exercising all their rights and obligations under the transaction documents. This document cannot be reproduced except in full, without prior written approval of the Company. Any unauthorized alteration, forgery or falsification of the content or appearance of this document is unlawful and offenders may be prosecuted to the fullest extent of the law.

Radar Type5_Trial3 for 5310MHz

Data Sheet for FCC Radar Type 5						
Trial Number:			3	VSG Frequency(MHz):		5310
Number of Bursts in Trial:			14	Successful Detection:		Yes
Burst (8-20)	Number Pulses per Burst (1-3)	Pulse Width (50-100)	Chirp Width (5-20)	Pulse 1-to-2 Spacing	Pulse 2-to-3 Spacing	Starting Location Within Interval
		(μ sec)	(MHz)	(μ sec)	(μ sec)	(μ sec)
1	2	75.2	13	1361.8		143969
2	3	90.7	13	1099.3	988.3	350947
3	3	93.8	13	1045.2	1043.2	557505
4	1	60.8	13			766524
5	3	98.2	13	1508.8	1876.8	118256
6	3	88.5	13	959.5	1339.5	325401
7	3	90.5	13	1857.5	1691.5	531589
8	2	74.6	13	957.4		740731
9	2	74.5	13	1040.5		92978
10	1	53.5	13			300652
11	3	89.7	13	1803.3	1110.3	506183
12	2	80.9	13	1738.1		714128
13	1	51.5	13			67556
14	2	80.4	13	1193.6		274857
15						
16						
17						
18						
19						
20						

Unless otherwise stated the results shown in this test report refer only to the sample(s) tested and such sample(s) are retained for 90 days only.

除非另有說明，此報告結果僅對測試之樣品負責，同時此樣品僅保留90天。本報告未經本公司書面許可，不可部份複製。

This document is issued by the Company subject to its General Conditions of Service printed overleaf, available on request or accessible at <http://www.sgs.com.tw/Terms-and-Conditions> and for electronic format documents, subject to Terms and Conditions for Electronic Documents at <http://www.sgs.com.tw/Terms-and-Conditions>. Attention is drawn to the limitation of liability, indemnification and jurisdiction issues defined therein. Any holder of this document is advised that information contained hereon reflects the Company's findings at the time of its intervention only and within the limits of Client's instructions, if any. The Company's sole responsibility is to its Client and this document does not exonerate parties to a transaction from exercising all their rights and obligations under the transaction documents. This document cannot be reproduced except in full, without prior written approval of the Company. Any unauthorized alteration, forgery or falsification of the content or appearance of this document is unlawful and offenders may be prosecuted to the fullest extent of the law.

SGS Taiwan Ltd.

No.134,Wu Kung Road, New Taipei Industrial Park, Wuku District, New Taipei City, Taiwan/新北市五股區新北產業園區五工路 134 號

台灣檢驗科技股份有限公司

t (886-2) 2299-3279

f (886-2) 2298-0488

www.sgs.com.tw

Member of SGS Group

Radar Type5_Trial4 for 5310MHz

Data Sheet for FCC Radar Type 5						
Trial Number:			4		VSG Frequency(MHz): 5310	
Number of Bursts in Trial:			8		Successful Detection: Yes	
Burst (8-20)	Number Pulses per Burst (1-3)	Pulse Width (50-100)	Chirp Width (5-20)	Pulse 1-to-2 Spacing	Pulse 2-to-3 Spacing	Starting Location Within Interval
		(μ sec)	(MHz)	(μ sec)	(μ sec)	(μ sec)
1	1	59.8	5			845339
2	1	65.7	5			1208624
3	2	70.7	5	1208.3		73525
4	2	72.4	5	1543.6		436604
5	2	72.4	5	961.6		800038
6	1	58.8	5			1164144
7	2	72.8	5	1723.2		28791
8	3	86.7	5	1407.3	1824.3	391341
9						
10						
11						
12						
13						
14						
15						
16						
17						
18						
19						
20						

Unless otherwise stated the results shown in this test report refer only to the sample(s) tested and such sample(s) are retained for 90 days only.

除非另有說明，此報告結果僅對測試之樣品負責，同時此樣品僅保留90天。本報告未經本公司書面許可，不可部份複製。

This document is issued by the Company subject to its General Conditions of Service printed overleaf, available on request or accessible at <http://www.sgs.com.tw/Terms-and-Conditions> and for electronic format documents, subject to Terms and Conditions for Electronic Documents at <http://www.sgs.com.tw/Terms-and-Conditions>. Attention is drawn to the limitation of liability, indemnification and jurisdiction issues defined therein. Any holder of this document is advised that information contained hereon reflects the Company's findings at the time of its intervention only and within the limits of Client's instructions, if any. The Company's sole responsibility is to its Client and this document does not exonerate parties to a transaction from exercising all their rights and obligations under the transaction documents. This document cannot be reproduced except in full, without prior written approval of the Company. Any unauthorized alteration, forgery or falsification of the content or appearance of this document is unlawful and offenders may be prosecuted to the fullest extent of the law.

SGS Taiwan Ltd.

No.134,Wu Kung Road, New Taipei Industrial Park, Wuku District, New Taipei City, Taiwan/新北市五股區新北產業園區五工路 134 號

台灣檢驗科技股份有限公司

t (886-2) 2299-3279

f (886-2) 2298-0488

www.sgs.com.tw

Member of SGS Group

Radar Type5_Trial5 for 5310MHz

Data Sheet for FCC Radar Type 5						
Trial Number:			5	VSG Frequency(MHz):		5310
Number of Bursts in Trial:			8	Successful Detection:		Yes
Burst (8-20)	Number Pulses per Burst (1-3)	Pulse Width (50-100)	Chirp Width (5-20)	Pulse 1-to-2 Spacing	Pulse 2-to-3 Spacing	Starting Location Within Interval
		(μ sec)	(MHz)	(μ sec)	(μ sec)	(μ sec)
1	2	71.5	5	1024.5		755079
2	3	88	5	1905	1547	1116130
3	3	89.4	5	1595.6	1232.6	1479179
4	3	97.7	5	1549.3	1090.3	346877
5	1	65.8	5			710997
6	1	61.7	5			1074422
7	2	76.6	5	1387.4		1436084
8	3	96.5	5	1571.5	925.5	302135
9						
10						
11						
12						
13						
14						
15						
16						
17						
18						
19						
20						

Unless otherwise stated the results shown in this test report refer only to the sample(s) tested and such sample(s) are retained for 90 days only.

除非另有說明，此報告結果僅對測試之樣品負責，同時此樣品僅保留90天。本報告未經本公司書面許可，不可部份複製。

This document is issued by the Company subject to its General Conditions of Service printed overleaf, available on request or accessible at <http://www.sgs.com.tw/Terms-and-Conditions> and for electronic format documents, subject to Terms and Conditions for Electronic Documents at <http://www.sgs.com.tw/Terms-and-Conditions>. Attention is drawn to the limitation of liability, indemnification and jurisdiction issues defined therein. Any holder of this document is advised that information contained hereon reflects the Company's findings at the time of its intervention only and within the limits of Client's instructions, if any. The Company's sole responsibility is to its Client and this document does not exonerate parties to a transaction from exercising all their rights and obligations under the transaction documents. This document cannot be reproduced except in full, without prior written approval of the Company. Any unauthorized alteration, forgery or falsification of the content or appearance of this document is unlawful and offenders may be prosecuted to the fullest extent of the law.

SGS Taiwan Ltd.

No.134,Wu Kung Road, New Taipei Industrial Park, Wuku District, New Taipei City, Taiwan/新北市五股區新北產業園區五工路 134 號

台灣檢驗科技股份有限公司

t (886-2) 2299-3279

f (886-2) 2298-0488

www.sgs.com.tw

Member of SGS Group

Radar Type5_Trial6 for 5310MHz

Data Sheet for FCC Radar Type 5						
Trial Number:		6		VSG Frequency(MHz):		5310
Number of Bursts in Trial:			14		Successful Detection: Yes	
Burst (8-20)	Number Pulses per Burst (1-3)	Pulse Width (50-100)	Chirp Width (5-20)	Pulse 1-to-2 Spacing	Pulse 2-to-3 Spacing	Starting Location Within Interval
		(μ sec)	(MHz)	(μ sec)	(μ sec)	(μ sec)
1	3	97	12	1506	1903	378573
2	3	96.3	12	926.7	1064.7	586348
3	3	86.5	12	1416.5	964.5	793292
4	2	79.6	12	1505.4		146992
5	3	84	12	1459	1858	353209
6	3	85	12	1028	1539	560501
7	2	71	12	1692		767848
8	2	76	12	1081		121542
9	1	57.9	12			329085
10	3	86.7	12	1679.3	1245.3	535068
11	3	88.6	12	1154.4	1637.4	741864
12	2	79.5	12	1696.5		95986
13	3	91.3	12	1797.7	1841.7	302190
14	2	76.8	12	1755.2		510022
15						
16						
17						
18						
19						
20						

Unless otherwise stated the results shown in this test report refer only to the sample(s) tested and such sample(s) are retained for 90 days only.

除非另有說明，此報告結果僅對測試之樣品負責，同時此樣品僅保留90天。本報告未經本公司書面許可，不可部份複製。

This document is issued by the Company subject to its General Conditions of Service printed overleaf, available on request or accessible at <http://www.sgs.com.tw/Terms-and-Conditions> and for electronic format documents, subject to Terms and Conditions for Electronic Documents at <http://www.sgs.com.tw/Terms-and-Conditions>. Attention is drawn to the limitation of liability, indemnification and jurisdiction issues defined therein. Any holder of this document is advised that information contained hereon reflects the Company's findings at the time of its intervention only and within the limits of Client's instructions, if any. The Company's sole responsibility is to its Client and this document does not exonerate parties to a transaction from exercising all their rights and obligations under the transaction documents. This document cannot be reproduced except in full, without prior written approval of the Company. Any unauthorized alteration, forgery or falsification of the content or appearance of this document is unlawful and offenders may be prosecuted to the fullest extent of the law.

Radar Type5_Trial7 for 5310MHz

Data Sheet for FCC Radar Type 5						
Trial Number:			7		VSG Frequency(MHz): 5310	
Number of Bursts in Trial:			13		Successful Detection: Yes	
Burst (8-20)	Number Pulses per Burst (1-3)	Pulse Width (50-100)	Chirp Width (5-20)	Pulse 1-to-2 Spacing	Pulse 2-to-3 Spacing	Starting Location Within Interval
		(μ sec)	(MHz)	(μ sec)	(μ sec)	(μ sec)
1	3	96.4	11	1752.6	1109.6	771194
2	1	51.4	11			76092
3	1	64.8	11			299489
4	1	65.3	11			522832
5	2	75.7	11	1670.3		745337
6	3	85.4	11	1250.6	979.6	48408
7	3	94	11	1772	1352	270970
8	2	68.1	11	1265.9		494746
9	2	81	11	1161		717983
10	3	87.4	11	1328.6	1906.6	20904
11	3	92.8	11	1267.2	1676.2	243688
12	3	88.6	11	1875.4	1638.4	465906
13	2	69.2	11	1282.8		690603
14						
15						
16						
17						
18						
19						
20						

Unless otherwise stated the results shown in this test report refer only to the sample(s) tested and such sample(s) are retained for 90 days only.

除非另有說明，此報告結果僅對測試之樣品負責，同時此樣品僅保留90天。本報告未經本公司書面許可，不可部份複製。

This document is issued by the Company subject to its General Conditions of Service printed overleaf, available on request or accessible at <http://www.sgs.com.tw/Terms-and-Conditions> and for electronic format documents, subject to Terms and Conditions for Electronic Documents at <http://www.sgs.com.tw/Terms-and-Conditions>. Attention is drawn to the limitation of liability, indemnification and jurisdiction issues defined therein. Any holder of this document is advised that information contained hereon reflects the Company's findings at the time of its intervention only and within the limits of Client's instructions, if any. The Company's sole responsibility is to its Client and this document does not exonerate parties to a transaction from exercising all their rights and obligations under the transaction documents. This document cannot be reproduced except in full, without prior written approval of the Company. Any unauthorized alteration, forgery or falsification of the content or appearance of this document is unlawful and offenders may be prosecuted to the fullest extent of the law.

SGS Taiwan Ltd.

No.134,Wu Kung Road, New Taipei Industrial Park, Wuku District, New Taipei City, Taiwan/新北市五股區新北產業園區五工路 134 號

台灣檢驗科技股份有限公司

t (886-2) 2299-3279

f (886-2) 2298-0488

www.sgs.com.tw

Member of SGS Group

Radar Type5_Trial8 for 5310MHz

Data Sheet for FCC Radar Type 5						
Trial Number:		8		VSG Frequency(MHz):		5310
Number of Bursts in Trial:			11		Successful Detection: Yes	
Burst (8-20)	Number Pulses per Burst (1-3)	Pulse Width (50-100)	Chirp Width (5-20)	Pulse 1-to-2 Spacing	Pulse 2-to-3 Spacing	Starting Location Within Interval
		(μ sec)	(MHz)	(μ sec)	(μ sec)	(μ sec)
1	1	55.7	9			1081971
2	2	71.5	9	1428.5		256209
3	1	50.4	9			520922
4	2	72.7	9	1676.3		783872
5	2	78.8	9	1564.2		1047535
6	3	98	9	1686	1848	223101
7	2	78.1	9	1319.9		487378
8	1	56.6	9			752190
9	3	93.4	9	1339.6	1120.6	1013747
10	3	94.4	9	1471.6	1168.6	190967
11	2	71.9	9	1853.1		454777
12						
13						
14						
15						
16						
17						
18						
19						
20						

Unless otherwise stated the results shown in this test report refer only to the sample(s) tested and such sample(s) are retained for 90 days only.

除非另有說明，此報告結果僅對測試之樣品負責，同時此樣品僅保留90天。本報告未經本公司書面許可，不可部份複製。

This document is issued by the Company subject to its General Conditions of Service printed overleaf, available on request or accessible at <http://www.sgs.com.tw/Terms-and-Conditions> and for electronic format documents, subject to Terms and Conditions for Electronic Documents at <http://www.sgs.com.tw/Terms-and-Conditions>. Attention is drawn to the limitation of liability, indemnification and jurisdiction issues defined therein. Any holder of this document is advised that information contained hereon reflects the Company's findings at the time of its intervention only and within the limits of Client's instructions, if any. The Company's sole responsibility is to its Client and this document does not exonerate parties to a transaction from exercising all their rights and obligations under the transaction documents. This document cannot be reproduced except in full, without prior written approval of the Company. Any unauthorized alteration, forgery or falsification of the content or appearance of this document is unlawful and offenders may be prosecuted to the fullest extent of the law.

SGS Taiwan Ltd.

No.134,Wu Kung Road, New Taipei Industrial Park, Wuku District, New Taipei City, Taiwan/新北市五股區新北產業園區五工路 134 號

台灣檢驗科技股份有限公司

t (886-2) 2299-3279

f (886-2) 2298-0488

www.sgs.com.tw

Member of SGS Group

Radar Type5_Trial9 for 5310MHz

Data Sheet for FCC Radar Type 5						
Trial Number:			9	VSG Frequency(MHz):		5310
Number of Bursts in Trial:			11	Successful Detection:		Yes
Burst (8-20)	Number Pulses per Burst (1-3)	Pulse Width (50-100)	Chirp Width (5-20)	Pulse 1-to-2 Spacing	Pulse 2-to-3 Spacing	Starting Location Within Interval
		(μ sec)	(MHz)	(μ sec)	(μ sec)	(μ sec)
1	3	96.5	8	1238.5	1767.5	717802
2	2	74.9	8	1820.1		982334
3	3	94.7	8	1012.3	1446.3	158509
4	3	94.8	8	1520.2	1653.2	421684
5	1	64.4	8			687423
6	3	85.8	8	960.2	1385.2	949648
7	2	70.2	8	1167.8		126134
8	3	93.3	8	943.7	1289.7	389725
9	3	95.4	8	1101.6	1896.6	652936
10	3	94.7	8	1841.3	1060.3	916384
11	3	91.7	8	1816.3	1181.3	93458
12						
13						
14						
15						
16						
17						
18						
19						
20						

Unless otherwise stated the results shown in this test report refer only to the sample(s) tested and such sample(s) are retained for 90 days only.

除非另有說明，此報告結果僅對測試之樣品負責，同時此樣品僅保留90天。本報告未經本公司書面許可，不可部份複製。

This document is issued by the Company subject to its General Conditions of Service printed overleaf, available on request or accessible at <http://www.sgs.com.tw/Terms-and-Conditions> and for electronic format documents, subject to Terms and Conditions for Electronic Documents at <http://www.sgs.com.tw/Terms-and-Conditions>. Attention is drawn to the limitation of liability, indemnification and jurisdiction issues defined therein. Any holder of this document is advised that information contained hereon reflects the Company's findings at the time of its intervention only and within the limits of Client's instructions, if any. The Company's sole responsibility is to its Client and this document does not exonerate parties to a transaction from exercising all their rights and obligations under the transaction documents. This document cannot be reproduced except in full, without prior written approval of the Company. Any unauthorized alteration, forgery or falsification of the content or appearance of this document is unlawful and offenders may be prosecuted to the fullest extent of the law.

Radar Type5_Trial10 for 5310MHz

Data Sheet for FCC Radar Type 5						
Trial Number:		10		VSG Frequency(MHz):		5310
Number of Bursts in Trial:			20		Successful Detection: Yes	
Burst (8-20)	Number Pulses per Burst (1-3)	Pulse Width (50-100)	Chirp Width (5-20)	Pulse 1-to-2 Spacing	Pulse 2-to-3 Spacing	Starting Location Within Interval
		(μ sec)	(MHz)	(μ sec)	(μ sec)	(μ sec)
1	3	87.9	20	1065.1	1054.1	195845
2	2	82.9	20	1649.1		340735
3	1	50.4	20			487164
4	3	86.1	20	1511.9	1327.9	33463
5	3	91.3	20	1333.7	1629.7	177985
6	1	52.4	20			324139
7	2	78.8	20	964.2		468273
8	1	65.2	20			15748
9	3	99.2	20	1105.8	1472.8	160137
10	3	86.9	20	1715.1	1671.1	304464
11	3	95.4	20	1764.6	1171.6	448919
12	1	65.8	20			596028
13	1	65.2	20			142978
14	1	54.5	20			287964
15	1	57.4	20			433443
16	1	64	20			578958
17	1	59.8	20			125123
18	2	81.5	20	1113.5		269660
19	1	63.1	20			415298
20	2	70.1	20	1113.9		559053

Unless otherwise stated the results shown in this test report refer only to the sample(s) tested and such sample(s) are retained for 90 days only.

除非另有說明，此報告結果僅對測試之樣品負責，同時此樣品僅保留90天。本報告未經本公司書面許可，不可部份複製。

This document is issued by the Company subject to its General Conditions of Service printed overleaf, available on request or accessible at <http://www.sgs.com.tw/Terms-and-Conditions> and for electronic format documents, subject to Terms and Conditions for Electronic Documents at <http://www.sgs.com.tw/Terms-and-Conditions>. Attention is drawn to the limitation of liability, indemnification and jurisdiction issues defined therein. Any holder of this document is advised that information contained hereon reflects the Company's findings at the time of its intervention only and within the limits of Client's instructions, if any. The Company's sole responsibility is to its Client and this document does not exonerate parties to a transaction from exercising all their rights and obligations under the transaction documents. This document cannot be reproduced except in full, without prior written approval of the Company. Any unauthorized alteration, forgery or falsification of the content or appearance of this document is unlawful and offenders may be prosecuted to the fullest extent of the law.

SGS Taiwan Ltd.

No.134,Wu Kung Road, New Taipei Industrial Park, Wuku District, New Taipei City, Taiwan/新北市五股區新北產業園區五工路 134 號

台灣檢驗科技股份有限公司

t (886-2) 2299-3279

f (886-2) 2298-0488

www.sgs.com.tw

Member of SGS Group

Radar Type5_Trial11 for 5310MHz

Data Sheet for FCC Radar Type 5						
Trial Number:		11		VSG Frequency(MHz):		5296.1975
Number of Bursts in Trial:			15		Successful Detection: Yes	
Burst (8-20)	Number Pulses per Burst (1-3)	Pulse Width (50-100)	Chirp Width (5-20)	Pulse 1-to-2 Spacing	Pulse 2-to-3 Spacing	Starting Location Within Interval
		(μ sec)	(MHz)	(μ sec)	(μ sec)	(μ sec)
1	1	52.9	13			143103
2	1	57	13			336633
3	3	93	13	1786	1375	528454
4	2	68.8	13	1796.2		722576
5	1	50.7	13			119259
6	3	90.7	13	1150.3	1478.3	311911
7	3	99.3	13	1551.7	1326.7	504351
8	1	53.6	13			700354
9	3	95.3	13	1600.7	1466.7	95028
10	2	67.1	13	1419.9		288667
11	3	99.5	13	1883.5	1753.5	480592
12	3	93.2	13	1087.8	1551.8	673584
13	2	74.5	13	1562.5		71396
14	1	64.1	13			265211
15	3	83.6	13	1622.4	1038.4	457007
16						
17						
18						
19						
20						

Unless otherwise stated the results shown in this test report refer only to the sample(s) tested and such sample(s) are retained for 90 days only.

除非另有說明，此報告結果僅對測試之樣品負責，同時此樣品僅保留90天。本報告未經本公司書面許可，不可部份複製。

This document is issued by the Company subject to its General Conditions of Service printed overleaf, available on request or accessible at <http://www.sgs.com.tw/Terms-and-Conditions> and for electronic format documents, subject to Terms and Conditions for Electronic Documents at <http://www.sgs.com.tw/Terms-and-Conditions>. Attention is drawn to the limitation of liability, indemnification and jurisdiction issues defined therein. Any holder of this document is advised that information contained hereon reflects the Company's findings at the time of its intervention only and within the limits of Client's instructions, if any. The Company's sole responsibility is to its Client and this document does not exonerate parties to a transaction from exercising all their rights and obligations under the transaction documents. This document cannot be reproduced except in full, without prior written approval of the Company. Any unauthorized alteration, forgery or falsification of the content or appearance of this document is unlawful and offenders may be prosecuted to the fullest extent of the law.

Radar Type5_Trial12 for 5310MHz

Data Sheet for FCC Radar Type 5						
Trial Number:		12		VSG Frequency(MHz):		5294.1975
Number of Bursts in Trial:			10		Successful Detection: Yes	
Burst (8-20)	Number Pulses per Burst (1-3)	Pulse Width (50-100)	Chirp Width (5-20)	Pulse 1-to-2 Spacing	Pulse 2-to-3 Spacing	Starting Location Within Interval
		(μ sec)	(MHz)	(μ sec)	(μ sec)	(μ sec)
1	2	67.5	8	1366.5		978633
2	2	72.3	8	1722.7		71453
3	3	92.8	8	1745.2	1601.2	361200
4	1	56.7	8			653086
5	2	75.7	8	1346.3		942117
6	2	77.9	8	1602.1		35724
7	2	78.1	8	933.9		326175
8	3	95.3	8	1766.7	1165.7	615613
9	3	85.1	8	1363.9	1704.9	905273
10	1	51.1	8			1198252
11						
12						
13						
14						
15						
16						
17						
18						
19						
20						

Unless otherwise stated the results shown in this test report refer only to the sample(s) tested and such sample(s) are retained for 90 days only.

除非另有說明，此報告結果僅對測試之樣品負責，同時此樣品僅保留90天。本報告未經本公司書面許可，不可部份複製。

This document is issued by the Company subject to its General Conditions of Service printed overleaf, available on request or accessible at <http://www.sgs.com.tw/Terms-and-Conditions> and for electronic format documents, subject to Terms and Conditions for Electronic Documents at <http://www.sgs.com.tw/Terms-and-Conditions>. Attention is drawn to the limitation of liability, indemnification and jurisdiction issues defined therein. Any holder of this document is advised that information contained hereon reflects the Company's findings at the time of its intervention only and within the limits of Client's instructions, if any. The Company's sole responsibility is to its Client and this document does not exonerate parties to a transaction from exercising all their rights and obligations under the transaction documents. This document cannot be reproduced except in full, without prior written approval of the Company. Any unauthorized alteration, forgery or falsification of the content or appearance of this document is unlawful and offenders may be prosecuted to the fullest extent of the law.

Radar Type5_Trial13 for 5310MHz

Data Sheet for FCC Radar Type 5						
Trial Number:		13		VSG Frequency(MHz):		5297.3975
Number of Bursts in Trial:			17		Successful Detection: Yes	
Burst (8-20)	Number Pulses per Burst (1-3)	Pulse Width (50-100)	Chirp Width (5-20)	Pulse 1-to-2 Spacing	Pulse 2-to-3 Spacing	Starting Location Within Interval
		(μ sec)	(MHz)	(μ sec)	(μ sec)	(μ sec)
1	1	59	16			170817
2	2	79.5	16	990.5		341357
3	3	90.3	16	1075.7	1220.7	510526
4	1	57	16			683467
5	2	71.8	16	1218.2		149404
6	1	60.4	16			320410
7	1	61.8	16			491519
8	2	82.3	16	1727.7		660636
9	2	74.5	16	1601.5		128495
10	3	88.7	16	975.3	1412.3	298307
11	2	80.8	16	1746.2		469475
12	3	90	16	1030	1551	638300
13	2	81.6	16	1088.4		107469
14	3	85.3	16	1827.7	1324.7	277145
15	1	50.6	16			449387
16	1	53.2	16			620125
17	2	75.1	16	1843.9		86364
18						
19						
20						

Unless otherwise stated the results shown in this test report refer only to the sample(s) tested and such sample(s) are retained for 90 days only.

除非另有說明，此報告結果僅對測試之樣品負責，同時此樣品僅保留90天。本報告未經本公司書面許可，不可部份複製。

This document is issued by the Company subject to its General Conditions of Service printed overleaf, available on request or accessible at <http://www.sgs.com.tw/Terms-and-Conditions> and for electronic format documents, subject to Terms and Conditions for Electronic Documents at <http://www.sgs.com.tw/Terms-and-Conditions>. Attention is drawn to the limitation of liability, indemnification and jurisdiction issues defined therein. Any holder of this document is advised that information contained hereon reflects the Company's findings at the time of its intervention only and within the limits of Client's instructions, if any. The Company's sole responsibility is to its Client and this document does not exonerate parties to a transaction from exercising all their rights and obligations under the transaction documents. This document cannot be reproduced except in full, without prior written approval of the Company. Any unauthorized alteration, forgery or falsification of the content or appearance of this document is unlawful and offenders may be prosecuted to the fullest extent of the law.

Radar Type5_Trial14 for 5310MHz

Data Sheet for FCC Radar Type 5						
Trial Number:		14		VSG Frequency(MHz):		5298.9975
Number of Bursts in Trial:			20		Successful Detection: Yes	
Burst (8-20)	Number Pulses per Burst (1-3)	Pulse Width (50-100)	Chirp Width (5-20)	Pulse 1-to-2 Spacing	Pulse 2-to-3 Spacing	Starting Location Within Interval
		(μ sec)	(MHz)	(μ sec)	(μ sec)	(μ sec)
1	2	70	20	1015		218197
2	2	82	20	1063		363178
3	3	87.4	20	1016.6	1573.6	506900
4	1	52.2	20			55765
5	3	91.3	20	1392.7	1490.7	199823
6	1	51	20			346092
7	2	70.9	20	1197.1		490061
8	3	89.9	20	1240.1	1198.1	37702
9	3	91.8	20	1314.2	999.2	182230
10	2	67.1	20	1850.9		326990
11	2	74.7	20	1018.3		472340
12	3	87.5	20	916.5	1912.5	19883
13	3	92.3	20	1126.7	1650.7	164207
14	2	74.8	20	1634.2		309633
15	1	61.7	20			455707
16	1	57.8	20			2102
17	2	67.7	20	1674.3		146931
18	3	91.8	20	1452.2	1631.2	290728
19	1	61.1	20			437450
20	1	58.9	20			582293

Unless otherwise stated the results shown in this test report refer only to the sample(s) tested and such sample(s) are retained for 90 days only.

除非另有說明，此報告結果僅對測試之樣品負責，同時此樣品僅保留90天。本報告未經本公司書面許可，不可部份複製。

This document is issued by the Company subject to its General Conditions of Service printed overleaf, available on request or accessible at <http://www.sgs.com.tw/Terms-and-Conditions> and for electronic format documents, subject to Terms and Conditions for Electronic Documents at <http://www.sgs.com.tw/Terms-and-Conditions>. Attention is drawn to the limitation of liability, indemnification and jurisdiction issues defined therein. Any holder of this document is advised that information contained hereon reflects the Company's findings at the time of its intervention only and within the limits of Client's instructions, if any. The Company's sole responsibility is to its Client and this document does not exonerate parties to a transaction from exercising all their rights and obligations under the transaction documents. This document cannot be reproduced except in full, without prior written approval of the Company. Any unauthorized alteration, forgery or falsification of the content or appearance of this document is unlawful and offenders may be prosecuted to the fullest extent of the law.

SGS Taiwan Ltd.

No.134,Wu Kung Road, New Taipei Industrial Park, Wuku District, New Taipei City, Taiwan/新北市五股區新北產業園區五工路 134 號

台灣檢驗科技股份有限公司

t (886-2) 2299-3279

f (886-2) 2298-0488

www.sgs.com.tw

Member of SGS Group

Radar Type5_Trial15 for 5310MHz

Data Sheet for FCC Radar Type 5						
Trial Number:		15		VSG Frequency(MHz):		5296.9975
Number of Bursts in Trial:			16		Successful Detection: Yes	
Burst (8-20)	Number Pulses per Burst (1-3)	Pulse Width (50-100)	Chirp Width (5-20)	Pulse 1-to-2 Spacing	Pulse 2-to-3 Spacing	Starting Location Within Interval
		(μ sec)	(MHz)	(μ sec)	(μ sec)	(μ sec)
1	3	96.7	15	1581.3	1271.3	161051
2	2	73.5	15	1917.5		342354
3	1	56.7	15			524731
4	3	87.7	15	1898.3	1496.3	703120
5	1	60.8	15			139360
6	3	100	15	1513	1072	319792
7	2	75.5	15	1704.5		501115
8	1	52.7	15			683650
9	2	77.6	15	1511.4		116904
10	3	90.7	15	1515.3	1368.3	297489
11	1	57.4	15			480050
12	1	56.1	15			661425
13	2	72.5	15	1240.5		94607
14	1	52.8	15			276358
15	1	58.1	15			458076
16	1	63.3	15			639282
17						
18						
19						
20						

Unless otherwise stated the results shown in this test report refer only to the sample(s) tested and such sample(s) are retained for 90 days only.

除非另有說明，此報告結果僅對測試之樣品負責，同時此樣品僅保留90天。本報告未經本公司書面許可，不可部份複製。

This document is issued by the Company subject to its General Conditions of Service printed overleaf, available on request or accessible at <http://www.sgs.com.tw/Terms-and-Conditions> and for electronic format documents, subject to Terms and Conditions for Electronic Documents at <http://www.sgs.com.tw/Terms-and-Conditions>. Attention is drawn to the limitation of liability, indemnification and jurisdiction issues defined therein. Any holder of this document is advised that information contained hereon reflects the Company's findings at the time of its intervention only and within the limits of Client's instructions, if any. The Company's sole responsibility is to its Client and this document does not exonerate parties to a transaction from exercising all their rights and obligations under the transaction documents. This document cannot be reproduced except in full, without prior written approval of the Company. Any unauthorized alteration, forgery or falsification of the content or appearance of this document is unlawful and offenders may be prosecuted to the fullest extent of the law.

Radar Type5_Trial16 for 5310MHz

Data Sheet for FCC Radar Type 5						
Trial Number:		16		VSG Frequency(MHz):		5298.5975
Number of Bursts in Trial:			19		Successful Detection: Yes	
Burst (8-20)	Number Pulses per Burst (1-3)	Pulse Width (50-100)	Chirp Width (5-20)	Pulse 1-to-2 Spacing	Pulse 2-to-3 Spacing	Starting Location Within Interval
		(μ sec)	(MHz)	(μ sec)	(μ sec)	(μ sec)
1	3	97.8	19	1035.2	1109.2	60664
2	3	98.9	19	1349.1	1179.1	212758
3	2	67.7	19	1877.3		365185
4	2	78.4	19	1897.6		517638
5	2	69.3	19	1353.7		42020
6	2	67.1	19	1256.9		194546
7	2	80.1	19	1704.9		346961
8	3	93.4	19	935.6	1527.6	498702
9	3	87.1	19	1769.9	1303.9	23150
10	3	94.9	19	1043.1	1752.1	175148
11	2	82.3	19	1429.7		328193
12	1	63.8	19			481836
13	2	69	19	1717		4428
14	2	82.1	19	1509.9		156800
15	1	63.9	19			310290
16	3	93.6	19	1131.4	1715.4	460941
17	3	89.5	19	1035.5	927.5	613436
18	3	94.3	19	1285.7	1082.7	137818
19	2	78.4	19	1681.6		290315
20						

Unless otherwise stated the results shown in this test report refer only to the sample(s) tested and such sample(s) are retained for 90 days only.

除非另有說明，此報告結果僅對測試之樣品負責，同時此樣品僅保留90天。本報告未經本公司書面許可，不可部份複製。

This document is issued by the Company subject to its General Conditions of Service printed overleaf, available on request or accessible at <http://www.sgs.com.tw/Terms-and-Conditions> and for electronic format documents, subject to Terms and Conditions for Electronic Documents at <http://www.sgs.com.tw/Terms-and-Conditions>. Attention is drawn to the limitation of liability, indemnification and jurisdiction issues defined therein. Any holder of this document is advised that information contained hereon reflects the Company's findings at the time of its intervention only and within the limits of Client's instructions, if any. The Company's sole responsibility is to its Client and this document does not exonerate parties to a transaction from exercising all their rights and obligations under the transaction documents. This document cannot be reproduced except in full, without prior written approval of the Company. Any unauthorized alteration, forgery or falsification of the content or appearance of this document is unlawful and offenders may be prosecuted to the fullest extent of the law.

Radar Type5_Trial17 for 5310MHz

Data Sheet for FCC Radar Type 5						
Trial Number:		17		VSG Frequency(MHz):		5293.7975
Number of Bursts in Trial:			10		Successful Detection: Yes	
Burst (8-20)	Number Pulses per Burst (1-3)	Pulse Width (50-100)	Chirp Width (5-20)	Pulse 1-to-2 Spacing	Pulse 2-to-3 Spacing	Starting Location Within Interval
		(μ sec)	(MHz)	(μ sec)	(μ sec)	(μ sec)
1	3	96.6	7	1648.4	1865.4	841832
2	2	75.3	7	1301.7		1134370
3	3	99.8	7	1691.2	928.2	226986
4	3	91.4	7	1351.6	1845.6	516768
5	3	91.3	7	1507.7	1109.7	806793
6	2	75.6	7	1497.4		1097643
7	2	68.2	7	1628.8		191388
8	1	62.3	7			482197
9	1	51	7			773239
10	1	59.6	7			1063311
11						
12						
13						
14						
15						
16						
17						
18						
19						
20						

Unless otherwise stated the results shown in this test report refer only to the sample(s) tested and such sample(s) are retained for 90 days only.

除非另有說明，此報告結果僅對測試之樣品負責，同時此樣品僅保留90天。本報告未經本公司書面許可，不可部份複製。

This document is issued by the Company subject to its General Conditions of Service printed overleaf, available on request or accessible at <http://www.sgs.com.tw/Terms-and-Conditions> and for electronic format documents, subject to Terms and Conditions for Electronic Documents at <http://www.sgs.com.tw/Terms-and-Conditions>. Attention is drawn to the limitation of liability, indemnification and jurisdiction issues defined therein. Any holder of this document is advised that information contained hereon reflects the Company's findings at the time of its intervention only and within the limits of Client's instructions, if any. The Company's sole responsibility is to its Client and this document does not exonerate parties to a transaction from exercising all their rights and obligations under the transaction documents. This document cannot be reproduced except in full, without prior written approval of the Company. Any unauthorized alteration, forgery or falsification of the content or appearance of this document is unlawful and offenders may be prosecuted to the fullest extent of the law.

Radar Type5_Trial18 for 5310MHz

Data Sheet for FCC Radar Type 5						
Trial Number:		18		VSG Frequency(MHz):		5296.1975
Number of Bursts in Trial:			14		Successful Detection: Yes	
Burst (8-20)	Number Pulses per Burst (1-3)	Pulse Width (50-100)	Chirp Width (5-20)	Pulse 1-to-2 Spacing	Pulse 2-to-3 Spacing	Starting Location Within Interval
		(μ sec)	(MHz)	(μ sec)	(μ sec)	(μ sec)
1	2	68.6	13	1499.4		111159
2	1	64.9	13			318639
3	3	89.4	13	1225.6	1206.6	525016
4	2	66.7	13	1407.3		732895
5	3	98.5	13	1094.5	1290.5	85461
6	1	60.1	13			293098
7	2	68.9	13	1207.1		499889
8	2	74	13	1650		706709
9	2	82.7	13	937.3		60119
10	3	89.7	13	913.3	1511.3	266981
11	2	79.6	13	1323.4		474208
12	3	93.4	13	1709.6	922.6	680794
13	1	63.3	13			34618
14	1	50.5	13			242067
15						
16						
17						
18						
19						
20						

Unless otherwise stated the results shown in this test report refer only to the sample(s) tested and such sample(s) are retained for 90 days only.

除非另有說明，此報告結果僅對測試之樣品負責，同時此樣品僅保留90天。本報告未經本公司書面許可，不可部份複製。

This document is issued by the Company subject to its General Conditions of Service printed overleaf, available on request or accessible at <http://www.sgs.com.tw/Terms-and-Conditions> and for electronic format documents, subject to Terms and Conditions for Electronic Documents at <http://www.sgs.com.tw/Terms-and-Conditions>. Attention is drawn to the limitation of liability, indemnification and jurisdiction issues defined therein. Any holder of this document is advised that information contained hereon reflects the Company's findings at the time of its intervention only and within the limits of Client's instructions, if any. The Company's sole responsibility is to its Client and this document does not exonerate parties to a transaction from exercising all their rights and obligations under the transaction documents. This document cannot be reproduced except in full, without prior written approval of the Company. Any unauthorized alteration, forgery or falsification of the content or appearance of this document is unlawful and offenders may be prosecuted to the fullest extent of the law.

Radar Type5_Trial19 for 5310MHz

Data Sheet for FCC Radar Type 5						
Trial Number:		19		VSG Frequency(MHz):		5294.5975
Number of Bursts in Trial:			11		Successful Detection: Yes	
Burst (8-20)	Number Pulses per Burst (1-3)	Pulse Width (50-100)	Chirp Width (5-20)	Pulse 1-to-2 Spacing	Pulse 2-to-3 Spacing	Starting Location Within Interval
		(μ sec)	(MHz)	(μ sec)	(μ sec)	(μ sec)
1	1	66	9			572486
2	2	67.7	9	1512.3		835382
3	1	61.6	9			11536
4	3	83.7	9	963.3	1336.3	275055
5	3	95.5	9	1832.5	1354.5	538089
6	2	76.8	9	1049.2		803017
7	1	63.9	9			1068197
8	2	66.7	9	1203.3		242891
9	2	78.3	9	998.7		507034
10	2	74.4	9	1755.6		770438
11	1	61.5	9			1035902
12						
13						
14						
15						
16						
17						
18						
19						
20						

Unless otherwise stated the results shown in this test report refer only to the sample(s) tested and such sample(s) are retained for 90 days only.

除非另有說明，此報告結果僅對測試之樣品負責，同時此樣品僅保留90天。本報告未經本公司書面許可，不可部份複製。

This document is issued by the Company subject to its General Conditions of Service printed overleaf, available on request or accessible at <http://www.sgs.com.tw/Terms-and-Conditions> and for electronic format documents, subject to Terms and Conditions for Electronic Documents at <http://www.sgs.com.tw/Terms-and-Conditions>. Attention is drawn to the limitation of liability, indemnification and jurisdiction issues defined therein. Any holder of this document is advised that information contained hereon reflects the Company's findings at the time of its intervention only and within the limits of Client's instructions, if any. The Company's sole responsibility is to its Client and this document does not exonerate parties to a transaction from exercising all their rights and obligations under the transaction documents. This document cannot be reproduced except in full, without prior written approval of the Company. Any unauthorized alteration, forgery or falsification of the content or appearance of this document is unlawful and offenders may be prosecuted to the fullest extent of the law.

Radar Type5_Trial20 for 5310MHz

Data Sheet for FCC Radar Type 5						
Trial Number:		20		VSG Frequency(MHz):		5297.3975
Number of Bursts in Trial:			17		Successful Detection: Yes	
Burst (8-20)	Number Pulses per Burst (1-3)	Pulse Width (50-100)	Chirp Width (5-20)	Pulse 1-to-2 Spacing	Pulse 2-to-3 Spacing	Starting Location Within Interval
		(μ sec)	(MHz)	(μ sec)	(μ sec)	(μ sec)
1	3	88	16	1256	919	135783
2	3	98	16	1506	1371	305527
3	1	57.4	16			478186
4	2	76.4	16	1773.6		646724
5	1	52.8	16			115148
6	1	51	16			285926
7	1	54.8	16			456935
8	2	79	16	1222		626758
9	3	83.8	16	1125.2	1487.2	93692
10	2	68.5	16	1802.5		264129
11	2	79.9	16	1904.1		434598
12	3	92.9	16	1398.1	1123.1	604219
13	3	97.1	16	1045.9	1166.9	72856
14	2	70.6	16	1757.4		243445
15	2	72	16	1359		413877
16	3	95	16	1255	1652	582964
17	2	69.5	16	1837.5		51895
18						
19						
20						

Unless otherwise stated the results shown in this test report refer only to the sample(s) tested and such sample(s) are retained for 90 days only.

除非另有說明，此報告結果僅對測試之樣品負責，同時此樣品僅保留90天。本報告未經本公司書面許可，不可部份複製。

This document is issued by the Company subject to its General Conditions of Service printed overleaf, available on request or accessible at <http://www.sgs.com.tw/Terms-and-Conditions> and for electronic format documents, subject to Terms and Conditions for Electronic Documents at <http://www.sgs.com.tw/Terms-and-Conditions>. Attention is drawn to the limitation of liability, indemnification and jurisdiction issues defined therein. Any holder of this document is advised that information contained hereon reflects the Company's findings at the time of its intervention only and within the limits of Client's instructions, if any. The Company's sole responsibility is to its Client and this document does not exonerate parties to a transaction from exercising all their rights and obligations under the transaction documents. This document cannot be reproduced except in full, without prior written approval of the Company. Any unauthorized alteration, forgery or falsification of the content or appearance of this document is unlawful and offenders may be prosecuted to the fullest extent of the law.

Radar Type5_Trial21 for 5310MHz

Data Sheet for FCC Radar Type 5						
Trial Number:		21		VSG Frequency(MHz):		5326.6025
Number of Bursts in Trial:			9		Successful Detection: Yes	
Burst (8-20)	Number Pulses per Burst (1-3)	Pulse Width (50-100)	Chirp Width (5-20)	Pulse 1-to-2 Spacing	Pulse 2-to-3 Spacing	Starting Location Within Interval
		(μ sec)	(MHz)	(μ sec)	(μ sec)	(μ sec)
1	1	56.7	6			421551
2	1	54.5	6			744478
3	3	98.9	6	1286.1	1719.1	1064529
4	1	53.1	6			58608
5	1	61.9	6			381621
6	3	99.2	6	1156.8	1217.8	703403
7	2	75.4	6	1653.6		1026298
8	2	73.6	6	1185.4		18794
9	1	64	6			341945
10						
11						
12						
13						
14						
15						
16						
17						
18						
19						
20						

Unless otherwise stated the results shown in this test report refer only to the sample(s) tested and such sample(s) are retained for 90 days only.

除非另有說明，此報告結果僅對測試之樣品負責，同時此樣品僅保留90天。本報告未經本公司書面許可，不可部份複製。

This document is issued by the Company subject to its General Conditions of Service printed overleaf, available on request or accessible at <http://www.sgs.com.tw/Terms-and-Conditions> and for electronic format documents, subject to Terms and Conditions for Electronic Documents at <http://www.sgs.com.tw/Terms-and-Conditions>. Attention is drawn to the limitation of liability, indemnification and jurisdiction issues defined therein. Any holder of this document is advised that information contained hereon reflects the Company's findings at the time of its intervention only and within the limits of Client's instructions, if any. The Company's sole responsibility is to its Client and this document does not exonerate parties to a transaction from exercising all their rights and obligations under the transaction documents. This document cannot be reproduced except in full, without prior written approval of the Company. Any unauthorized alteration, forgery or falsification of the content or appearance of this document is unlawful and offenders may be prosecuted to the fullest extent of the law.

SGS Taiwan Ltd.

No.134,Wu Kung Road, New Taipei Industrial Park, Wuku District, New Taipei City, Taiwan/新北市五股區新北產業園區五工路 134 號

台灣檢驗科技股份有限公司

t (886-2) 2299-3279

f (886-2) 2298-0488

www.sgs.com.tw

Member of SGS Group

Radar Type5_Trial22 for 5310MHz

Data Sheet for FCC Radar Type 5						
Trial Number:		22		VSG Frequency(MHz):		5323.8025
Number of Bursts in Trial:			14		Successful Detection: Yes	
Burst (8-20)	Number Pulses per Burst (1-3)	Pulse Width (50-100)	Chirp Width (5-20)	Pulse 1-to-2 Spacing	Pulse 2-to-3 Spacing	Starting Location Within Interval
		(μ sec)	(MHz)	(μ sec)	(μ sec)	(μ sec)
1	3	84.5	13	1021.5	1628.5	425699
2	2	66.8	13	1144.2		633700
3	2	74.3	13	1140.7		840682
4	3	95.7	13	904.3	958.3	193640
5	1	51.9	13			401335
6	3	86.7	13	1253.3	1160.3	607151
7	1	64.9	13			816306
8	1	55.2	13			168523
9	1	60.5	13			376178
10	1	62.1	13			583300
11	1	61.4	13			791044
12	3	97.6	13	1516.4	1265.4	142362
13	2	79.9	13	1880.1		349568
14	3	88.6	13	1675.4	1030.4	556281
15						
16						
17						
18						
19						
20						

Unless otherwise stated the results shown in this test report refer only to the sample(s) tested and such sample(s) are retained for 90 days only.

除非另有說明，此報告結果僅對測試之樣品負責，同時此樣品僅保留90天。本報告未經本公司書面許可，不可部份複製。

This document is issued by the Company subject to its General Conditions of Service printed overleaf, available on request or accessible at <http://www.sgs.com.tw/Terms-and-Conditions> and for electronic format documents, subject to Terms and Conditions for Electronic Documents at <http://www.sgs.com.tw/Terms-and-Conditions>. Attention is drawn to the limitation of liability, indemnification and jurisdiction issues defined therein. Any holder of this document is advised that information contained hereon reflects the Company's findings at the time of its intervention only and within the limits of Client's instructions, if any. The Company's sole responsibility is to its Client and this document does not exonerate parties to a transaction from exercising all their rights and obligations under the transaction documents. This document cannot be reproduced except in full, without prior written approval of the Company. Any unauthorized alteration, forgery or falsification of the content or appearance of this document is unlawful and offenders may be prosecuted to the fullest extent of the law.

Radar Type5_Trial23 for 5310MHz

Data Sheet for FCC Radar Type 5						
Trial Number:		23		VSG Frequency(MHz):		5323.4025
Number of Bursts in Trial:			15		Successful Detection: Yes	
Burst (8-20)	Number Pulses per Burst (1-3)	Pulse Width (50-100)	Chirp Width (5-20)	Pulse 1-to-2 Spacing	Pulse 2-to-3 Spacing	Starting Location Within Interval
		(μ sec)	(MHz)	(μ sec)	(μ sec)	(μ sec)
1	2	74.8	14	1903.2		712954
2	1	64.4	14			109577
3	2	79.6	14	947.4		302690
4	2	82.1	14	1141.9		496146
5	3	86.2	14	1236.8	989.8	688037
6	2	74.8	14	1243.2		85509
7	1	64.5	14			279236
8	1	63.1	14			472748
9	2	73.5	14	1362.5		665464
10	2	81.8	14	1385.2		61664
11	3	94.4	14	1855.6	961.6	254652
12	1	59.9	14			449055
13	2	73.7	14	1136.3		641555
14	2	75.6	14	1761.4		37890
15	1	58.4	14			231571
16						
17						
18						
19						
20						

Unless otherwise stated the results shown in this test report refer only to the sample(s) tested and such sample(s) are retained for 90 days only.

除非另有說明，此報告結果僅對測試之樣品負責，同時此樣品僅保留90天。本報告未經本公司書面許可，不可部份複製。

This document is issued by the Company subject to its General Conditions of Service printed overleaf, available on request or accessible at <http://www.sgs.com.tw/Terms-and-Conditions> and for electronic format documents, subject to Terms and Conditions for Electronic Documents at <http://www.sgs.com.tw/Terms-and-Conditions>. Attention is drawn to the limitation of liability, indemnification and jurisdiction issues defined therein. Any holder of this document is advised that information contained hereon reflects the Company's findings at the time of its intervention only and within the limits of Client's instructions, if any. The Company's sole responsibility is to its Client and this document does not exonerate parties to a transaction from exercising all their rights and obligations under the transaction documents. This document cannot be reproduced except in full, without prior written approval of the Company. Any unauthorized alteration, forgery or falsification of the content or appearance of this document is unlawful and offenders may be prosecuted to the fullest extent of the law.

SGS Taiwan Ltd.

No.134,Wu Kung Road, New Taipei Industrial Park, Wuku District, New Taipei City, Taiwan/新北市五股區新北產業園區五工路 134 號

台灣檢驗科技股份有限公司

t (886-2) 2299-3279

f (886-2) 2298-0488

www.sgs.com.tw

Member of SGS Group

Radar Type5_Trial24 for 5310MHz

Data Sheet for FCC Radar Type 5						
Trial Number:		24		VSG Frequency(MHz):		5326.6025
Number of Bursts in Trial:			9		Successful Detection: Yes	
Burst (8-20)	Number Pulses per Burst (1-3)	Pulse Width (50-100)	Chirp Width (5-20)	Pulse 1-to-2 Spacing	Pulse 2-to-3 Spacing	Starting Location Within Interval
		(μ sec)	(MHz)	(μ sec)	(μ sec)	(μ sec)
1	2	76.1	6	1613.9		708682
2	3	98.8	6	973.2	1563.2	1030464
3	2	82.1	6	1484.9		23490
4	1	52.8	6			346421
5	3	88.9	6	1759.1	1530.1	667789
6	1	66.6	6			992268
7	3	88	6	1717	1899	1311409
8	1	54.6	6			306766
9	3	88.1	6	1901.9	1340.9	628217
10						
11						
12						
13						
14						
15						
16						
17						
18						
19						
20						

Unless otherwise stated the results shown in this test report refer only to the sample(s) tested and such sample(s) are retained for 90 days only.

除非另有說明，此報告結果僅對測試之樣品負責，同時此樣品僅保留90天。本報告未經本公司書面許可，不可部份複製。

This document is issued by the Company subject to its General Conditions of Service printed overleaf, available on request or accessible at <http://www.sgs.com.tw/Terms-and-Conditions> and for electronic format documents, subject to Terms and Conditions for Electronic Documents at <http://www.sgs.com.tw/Terms-and-Conditions>. Attention is drawn to the limitation of liability, indemnification and jurisdiction issues defined therein. Any holder of this document is advised that information contained hereon reflects the Company's findings at the time of its intervention only and within the limits of Client's instructions, if any. The Company's sole responsibility is to its Client and this document does not exonerate parties to a transaction from exercising all their rights and obligations under the transaction documents. This document cannot be reproduced except in full, without prior written approval of the Company. Any unauthorized alteration, forgery or falsification of the content or appearance of this document is unlawful and offenders may be prosecuted to the fullest extent of the law.

SGS Taiwan Ltd.

No.134,Wu Kung Road, New Taipei Industrial Park, Wuku District, New Taipei City, Taiwan/新北市五股區新北產業園區五工路 134 號

台灣檢驗科技股份有限公司

t (886-2) 2299-3279

f (886-2) 2298-0488

www.sgs.com.tw

Member of SGS Group

Radar Type5_Trial25 for 5310MHz

Data Sheet for FCC Radar Type 5						
Trial Number:		25		VSG Frequency(MHz):		5325.0025
Number of Bursts in Trial:			12		Successful Detection: Yes	
Burst (8-20)	Number Pulses per Burst (1-3)	Pulse Width (50-100)	Chirp Width (5-20)	Pulse 1-to-2 Spacing	Pulse 2-to-3 Spacing	Starting Location Within Interval
		(μ sec)	(MHz)	(μ sec)	(μ sec)	(μ sec)
1	1	66.5	10			713981
2	3	93.2	10	1318.8	1383.8	954060
3	2	77.9	10	1604.1		199837
4	3	91.9	10	1294.1	1759.1	440713
5	1	60	10			684224
6	1	59.8	10			926991
7	3	83.6	10	1361.4	1524.4	169870
8	2	72	10	1008		411973
9	2	76.9	10	1546.1		653647
10	1	65.9	10			896784
11	2	74	10	1743		140278
12	3	88.8	10	1123.2	978.2	381664
13						
14						
15						
16						
17						
18						
19						
20						

Unless otherwise stated the results shown in this test report refer only to the sample(s) tested and such sample(s) are retained for 90 days only.

除非另有說明，此報告結果僅對測試之樣品負責，同時此樣品僅保留90天。本報告未經本公司書面許可，不可部份複製。

This document is issued by the Company subject to its General Conditions of Service printed overleaf, available on request or accessible at <http://www.sgs.com.tw/Terms-and-Conditions> and for electronic format documents, subject to Terms and Conditions for Electronic Documents at <http://www.sgs.com.tw/Terms-and-Conditions>. Attention is drawn to the limitation of liability, indemnification and jurisdiction issues defined therein. Any holder of this document is advised that information contained hereon reflects the Company's findings at the time of its intervention only and within the limits of Client's instructions, if any. The Company's sole responsibility is to its Client and this document does not exonerate parties to a transaction from exercising all their rights and obligations under the transaction documents. This document cannot be reproduced except in full, without prior written approval of the Company. Any unauthorized alteration, forgery or falsification of the content or appearance of this document is unlawful and offenders may be prosecuted to the fullest extent of the law.

Radar Type5_Trial26 for 5310MHz

Data Sheet for FCC Radar Type 5						
Trial Number:		26		VSG Frequency(MHz):		5323.4025
Number of Bursts in Trial:			15		Successful Detection: Yes	
Burst (8-20)	Number Pulses per Burst (1-3)	Pulse Width (50-100)	Chirp Width (5-20)	Pulse 1-to-2 Spacing	Pulse 2-to-3 Spacing	Starting Location Within Interval
		(μ sec)	(MHz)	(μ sec)	(μ sec)	(μ sec)
1	2	82.4	14	1229.6		498536
2	2	67.1	14	1773.9		692019
3	3	89.3	14	1756.7	1617.7	88107
4	3	98.9	14	1600.1	1443.1	281127
5	3	99.5	14	1867.5	1028.5	474098
6	2	71.4	14	1023.6		668574
7	3	93.3	14	1751.7	1007.7	64396
8	3	92.6	14	1705.4	1299.4	257232
9	1	51.2	14			451923
10	3	92	14	1685	1843	642653
11	1	63	14			40796
12	3	89.4	14	1839.6	1564.6	233502
13	3	96.9	14	1282.1	1638.1	426399
14	3	84.5	14	1494.5	1024.5	619777
15	1	63.3	14			16934
16						
17						
18						
19						
20						

Unless otherwise stated the results shown in this test report refer only to the sample(s) tested and such sample(s) are retained for 90 days only.

除非另有說明，此報告結果僅對測試之樣品負責，同時此樣品僅保留90天。本報告未經本公司書面許可，不可部份複製。

This document is issued by the Company subject to its General Conditions of Service printed overleaf, available on request or accessible at <http://www.sgs.com.tw/Terms-and-Conditions> and for electronic format documents, subject to Terms and Conditions for Electronic Documents at <http://www.sgs.com.tw/Terms-and-Conditions>. Attention is drawn to the limitation of liability, indemnification and jurisdiction issues defined therein. Any holder of this document is advised that information contained hereon reflects the Company's findings at the time of its intervention only and within the limits of Client's instructions, if any. The Company's sole responsibility is to its Client and this document does not exonerate parties to a transaction from exercising all their rights and obligations under the transaction documents. This document cannot be reproduced except in full, without prior written approval of the Company. Any unauthorized alteration, forgery or falsification of the content or appearance of this document is unlawful and offenders may be prosecuted to the fullest extent of the law.

Radar Type5_Trial27 for 5310MHz

Data Sheet for FCC Radar Type 5						
Trial Number:		27		VSG Frequency(MHz):		5322.6025
Number of Bursts in Trial:			17		Successful Detection: Yes	
Burst (8-20)	Number Pulses per Burst (1-3)	Pulse Width (50-100)	Chirp Width (5-20)	Pulse 1-to-2 Spacing	Pulse 2-to-3 Spacing	Starting Location Within Interval
		(μ sec)	(MHz)	(μ sec)	(μ sec)	(μ sec)
1	2	79.4	16	1554.6		185404
2	3	94.8	16	1571.2	1078.2	355243
3	3	91.1	16	1445.9	1467.9	524957
4	2	72	16	1706		696602
5	3	86.8	16	1170.2	1767.2	164009
6	1	59.7	16			335368
7	3	91.5	16	1447.5	1197.5	504553
8	1	65.5	16			677665
9	3	93	16	978	1696	143140
10	3	96.9	16	1185.1	1071.1	313396
11	2	72.6	16	976.4		484806
12	1	53	16			655886
13	1	63.7	16			122700
14	3	98.2	16	939.8	1156.8	292699
15	2	72.4	16	1661.6		463032
16	2	83.1	16	955.9		633961
17	1	57.7	16			101592
18						
19						
20						

Unless otherwise stated the results shown in this test report refer only to the sample(s) tested and such sample(s) are retained for 90 days only.

除非另有說明，此報告結果僅對測試之樣品負責，同時此樣品僅保留90天。本報告未經本公司書面許可，不可部份複製。

This document is issued by the Company subject to its General Conditions of Service printed overleaf, available on request or accessible at <http://www.sgs.com.tw/Terms-and-Conditions> and for electronic format documents, subject to Terms and Conditions for Electronic Documents at <http://www.sgs.com.tw/Terms-and-Conditions>. Attention is drawn to the limitation of liability, indemnification and jurisdiction issues defined therein. Any holder of this document is advised that information contained hereon reflects the Company's findings at the time of its intervention only and within the limits of Client's instructions, if any. The Company's sole responsibility is to its Client and this document does not exonerate parties to a transaction from exercising all their rights and obligations under the transaction documents. This document cannot be reproduced except in full, without prior written approval of the Company. Any unauthorized alteration, forgery or falsification of the content or appearance of this document is unlawful and offenders may be prosecuted to the fullest extent of the law.

Radar Type5_Trial28 for 5310MHz

Data Sheet for FCC Radar Type 5						
Trial Number:		28		VSG Frequency(MHz):		5323.0025
Number of Bursts in Trial:			16		Successful Detection: Yes	
Burst (8-20)	Number Pulses per Burst (1-3)	Pulse Width (50-100)	Chirp Width (5-20)	Pulse 1-to-2 Spacing	Pulse 2-to-3 Spacing	Starting Location Within Interval
		(μ sec)	(MHz)	(μ sec)	(μ sec)	(μ sec)
1	1	51.6	15			289349
2	2	69.6	15	1249.4		470024
3	3	93.7	15	1041.3	1150.3	650118
4	2	81.7	15	1884.3		85378
5	3	92.9	15	1015.1	1041.1	266411
6	1	54	15			448486
7	3	89.4	15	1661.6	1625.6	627280
8	3	95.2	15	1199.8	1312.8	63036
9	3	94.8	15	1874.2	1264.2	243526
10	1	62	15			426457
11	3	86.8	15	1765.2	1300.2	605400
12	2	74.6	15	1030.4		40835
13	2	80.2	15	1433.8		221894
14	3	88.6	15	1584.4	1204.4	402325
15	3	95.1	15	1364.9	1513.9	582845
16	2	75.6	15	1550.4		18465
17						
18						
19						
20						

Unless otherwise stated the results shown in this test report refer only to the sample(s) tested and such sample(s) are retained for 90 days only.

除非另有說明，此報告結果僅對測試之樣品負責，同時此樣品僅保留90天。本報告未經本公司書面許可，不可部份複製。

This document is issued by the Company subject to its General Conditions of Service printed overleaf, available on request or accessible at <http://www.sgs.com.tw/Terms-and-Conditions> and for electronic format documents, subject to Terms and Conditions for Electronic Documents at <http://www.sgs.com.tw/Terms-and-Conditions>. Attention is drawn to the limitation of liability, indemnification and jurisdiction issues defined therein. Any holder of this document is advised that information contained hereon reflects the Company's findings at the time of its intervention only and within the limits of Client's instructions, if any. The Company's sole responsibility is to its Client and this document does not exonerate parties to a transaction from exercising all their rights and obligations under the transaction documents. This document cannot be reproduced except in full, without prior written approval of the Company. Any unauthorized alteration, forgery or falsification of the content or appearance of this document is unlawful and offenders may be prosecuted to the fullest extent of the law.

SGS Taiwan Ltd.

No.134,Wu Kung Road, New Taipei Industrial Park, Wuku District, New Taipei City, Taiwan/新北市五股區新北產業園區五工路 134 號

台灣檢驗科技股份有限公司

t (886-2) 2299-3279

f (886-2) 2298-0488

www.sgs.com.tw

Member of SGS Group

Radar Type5_Trial29 for 5310MHz

Data Sheet for FCC Radar Type 5						
Trial Number:		29		VSG Frequency(MHz):		5325.0025
Number of Bursts in Trial:			12		Successful Detection: Yes	
Burst (8-20)	Number Pulses per Burst (1-3)	Pulse Width (50-100)	Chirp Width (5-20)	Pulse 1-to-2 Spacing	Pulse 2-to-3 Spacing	Starting Location Within Interval
		(μ sec)	(MHz)	(μ sec)	(μ sec)	(μ sec)
1	3	96.5	10	1604.5	1082.5	265973
2	1	54.2	10			509016
3	2	77.3	10	1263.7		749934
4	3	85.8	10	1593.2	1151.2	990734
5	3	93.9	10	920.1	1876.1	236405
6	3	87.2	10	999.8	1300.8	477860
7	2	79	10	980		720257
8	3	91	10	977	918	961256
9	1	51.6	10			207126
10	3	96.3	10	1180.7	1203.7	448163
11	1	51.9	10			691269
12	2	76.9	10	1126.1		932778
13						
14						
15						
16						
17						
18						
19						
20						

Unless otherwise stated the results shown in this test report refer only to the sample(s) tested and such sample(s) are retained for 90 days only.

除非另有說明，此報告結果僅對測試之樣品負責，同時此樣品僅保留90天。本報告未經本公司書面許可，不可部份複製。

This document is issued by the Company subject to its General Conditions of Service printed overleaf, available on request or accessible at <http://www.sgs.com.tw/Terms-and-Conditions> and for electronic format documents, subject to Terms and Conditions for Electronic Documents at <http://www.sgs.com.tw/Terms-and-Conditions>. Attention is drawn to the limitation of liability, indemnification and jurisdiction issues defined therein. Any holder of this document is advised that information contained hereon reflects the Company's findings at the time of its intervention only and within the limits of Client's instructions, if any. The Company's sole responsibility is to its Client and this document does not exonerate parties to a transaction from exercising all their rights and obligations under the transaction documents. This document cannot be reproduced except in full, without prior written approval of the Company. Any unauthorized alteration, forgery or falsification of the content or appearance of this document is unlawful and offenders may be prosecuted to the fullest extent of the law.

Radar Type5_Trial30 for 5310MHz

Data Sheet for FCC Radar Type 5						
Trial Number:		30		VSG Frequency(MHz):		5321.4025
Number of Bursts in Trial:			19	Successful Detection:		Yes
Burst (8-20)	Number Pulses per Burst (1-3)	Pulse Width (50-100)	Chirp Width (5-20)	Pulse 1-to-2 Spacing	Pulse 2-to-3 Spacing	Starting Location Within Interval
		(μ sec)	(MHz)	(μ sec)	(μ sec)	(μ sec)
1	2	68.3	19	1287.7		111742
2	2	79.5	19	1375.5		263974
3	3	94.4	19	1371.6	1809.6	415412
4	2	78.9	19	1033.1		569750
5	1	58.9	19			93035
6	1	55.2	19			245758
7	3	87.8	19	1741.2	931.2	396617
8	2	77.2	19	1149.8		550426
9	3	90.8	19	1320.2	1427.2	73959
10	2	81.7	19	1204.3		226712
11	3	86.5	19	1320.5	1309.5	378328
12	3	90.7	19	1303.3	1374.3	530663
13	1	51.6	19			55500
14	2	76.9	19	1169.1		207885
15	3	92.1	19	1109.9	1723.9	359389
16	3	97.8	19	1590.2	1052.2	511380
17	1	54.6	19			36611
18	3	91	19	1234	1848	188355
19	1	62.7	19			342053
20						

Unless otherwise stated the results shown in this test report refer only to the sample(s) tested and such sample(s) are retained for 90 days only.

除非另有說明，此報告結果僅對測試之樣品負責，同時此樣品僅保留90天。本報告未經本公司書面許可，不可部份複製。

This document is issued by the Company subject to its General Conditions of Service printed overleaf, available on request or accessible at <http://www.sgs.com.tw/Terms-and-Conditions> and for electronic format documents, subject to Terms and Conditions for Electronic Documents at <http://www.sgs.com.tw/Terms-and-Conditions>. Attention is drawn to the limitation of liability, indemnification and jurisdiction issues defined therein. Any holder of this document is advised that information contained hereon reflects the Company's findings at the time of its intervention only and within the limits of Client's instructions, if any. The Company's sole responsibility is to its Client and this document does not exonerate parties to a transaction from exercising all their rights and obligations under the transaction documents. This document cannot be reproduced except in full, without prior written approval of the Company. Any unauthorized alteration, forgery or falsification of the content or appearance of this document is unlawful and offenders may be prosecuted to the fullest extent of the law.

Radar Type6 for 5310MHz

Data Sheet for FCC Radar Type 6

Trial	Pulse Width	PRI	Pulses per Hop	Hopping Rate	Hopping Sequence Length	Successful Detection
	(μ sec)	(μ sec)		(kHz)	(msec)	(Yes/No)
1	1	333	9	0.333	300	Yes
2	1	333	9	0.333	300	Yes
3	1	333	9	0.333	300	Yes
4	1	333	9	0.333	300	Yes
5	1	333	9	0.333	300	Yes
6	1	333	9	0.333	300	Yes
7	1	333	9	0.333	300	Yes
8	1	333	9	0.333	300	Yes
9	1	333	9	0.333	300	Yes
10	1	333	9	0.333	300	Yes
11	1	333	9	0.333	300	Yes
12	1	333	9	0.333	300	Yes
13	1	333	9	0.333	300	Yes
14	1	333	9	0.333	300	Yes
15	1	333	9	0.333	300	Yes
16	1	333	9	0.333	300	Yes
17	1	333	9	0.333	300	Yes
18	1	333	9	0.333	300	Yes
19	1	333	9	0.333	300	Yes
20	1	333	9	0.333	300	Yes
21	1	333	9	0.333	300	Yes
22	1	333	9	0.333	300	Yes
23	1	333	9	0.333	300	Yes
24	1	333	9	0.333	300	Yes
25	1	333	9	0.333	300	Yes
26	1	333	9	0.333	300	Yes
27	1	333	9	0.333	300	Yes
28	1	333	9	0.333	300	Yes
29	1	333	9	0.333	300	Yes
30	1	333	9	0.333	300	No

Unless otherwise stated the results shown in this test report refer only to the sample(s) tested and such sample(s) are retained for 90 days only.

除非另有說明，此報告結果僅對測試之樣品負責，同時此樣品僅保留90天。本報告未經本公司書面許可，不可部份複製。

This document is issued by the Company subject to its General Conditions of Service printed overleaf, available on request or accessible at <http://www.sgs.com.tw/Terms-and-Conditions> and for electronic format documents, subject to Terms and Conditions for Electronic Documents at <http://www.sgs.com.tw/Terms-and-Conditions>. Attention is drawn to the limitation of liability, indemnification and jurisdiction issues defined therein. Any holder of this document is advised that information contained hereon reflects the Company's findings at the time of its intervention only and within the limits of Client's instructions, if any. The Company's sole responsibility is to its Client and this document does not exonerate parties to a transaction from exercising all their rights and obligations under the transaction documents. This document cannot be reproduced except in full, without prior written approval of the Company. Any unauthorized alteration, forgery or falsification of the content or appearance of this document is unlawful and offenders may be prosecuted to the fullest extent of the law.

HE40_5510MHz

Short Pulse Radar Type	Minimum Number of Trials	Detection(%)		Minmum Percentage of Successful Detection(%)	Pass/Fail
1	30	100		60	Pass
2	30	100		60	Pass
3	30	96.67		60	Pass
4	30	100		60	Pass
Aggregate (Radar Types 1-4)	120	99.1675		80	Pass
Long Pulse Radar Type	Minimum Number of Trials	Each Detection(%)	Total Detection(%)	Minmum Percentage of Successful Detection(%)	Pass/Fail
5	Center:10	100	100	80	Pass
	Low Edge:10	100			
	High Edge:10	100			
Frequency Hopping Radar Type	Minimum Number of Trials	Detection(%)		Minmum Percentage of Successful Detection(%)	Pass/Fail
6	30	100		70	Pass

Unless otherwise stated the results shown in this test report refer only to the sample(s) tested and such sample(s) are retained for 90 days only.

除非另有說明，此報告結果僅對測試之樣品負責，同時此樣品僅保留90天。本報告未經本公司書面許可，不可部份複製。

This document is issued by the Company subject to its General Conditions of Service printed overleaf, available on request or accessible at <http://www.sgs.com.tw/Terms-and-Conditions> and for electronic format documents, subject to Terms and Conditions for Electronic Documents at <http://www.sgs.com.tw/Terms-and-Conditions>. Attention is drawn to the limitation of liability, indemnification and jurisdiction issues defined therein. Any holder of this document is advised that information contained hereon reflects the Company's findings at the time of its intervention only and within the limits of Client's instructions, if any. The Company's sole responsibility is to its Client and this document does not exonerate parties to a transaction from exercising all their rights and obligations under the transaction documents. This document cannot be reproduced except in full, without prior written approval of the Company. Any unauthorized alteration, forgery or falsification of the content or appearance of this document is unlawful and offenders may be prosecuted to the fullest extent of the law.

Radar Type1 for 5510MHz

Data Sheet for FCC Radar Type 1

Trial	VSG Frequency (MHz)	Pulse Repetition Frequency Number (1 to 23)	Pulse Repetition Frequency	PRI	Test A/B	Successful Detection
			(Pulses Per Second)	(msec)	A/B	(Yes/No)
1	5510	13	1319.3	758	A	Yes
2	5510	21	1089.3	918	A	Yes
3	5510	8	1519.8	658	A	Yes
4	5510	19	1139	878	A	Yes
5	5510	18	1165.5	858	A	Yes
6	5510	11	1392.8	718	A	Yes
7	5510	6	1618.1	618	A	Yes
8	5510	10	1432.7	698	A	Yes
9	5510	16	1222.5	818	A	Yes
10	5510	17	1193.3	838	A	Yes
11	5510	23	326.2	3066	A	Yes
12	5510	9	1474.9	678	A	Yes
13	5510	4	1730.1	578	A	Yes
14	5510	5	1672.2	598	A	Yes
15	5510	1	1930.5	518	A	Yes
16	5510	-	533.6	1874	B	Yes
17	5510	-	471.7	2120	B	Yes
18	5510	-	342.2	2922	B	Yes
19	5510	-	993	1007	B	Yes
20	5510	-	1257.9	795	B	Yes
21	5510	-	742.9	1346	B	Yes
22	5510	-	814.3	1228	B	Yes
23	5510	-	403.1	2481	B	Yes
24	5510	-	700.8	1427	B	Yes
25	5510	-	1831.5	546	B	Yes
26	5510	-	1251.6	799	B	Yes
27	5510	-	483.6	2068	B	Yes
28	5510	-	970.9	1030	B	Yes
29	5510	-	449.6	2224	B	Yes
30	5510	-	687.8	1454	B	Yes

Unless otherwise stated the results shown in this test report refer only to the sample(s) tested and such sample(s) are retained for 90 days only.

除非另有說明，此報告結果僅對測試之樣品負責，同時此樣品僅保留90天。本報告未經本公司書面許可，不可部份複製。

This document is issued by the Company subject to its General Conditions of Service printed overleaf, available on request or accessible at <http://www.sgs.com.tw/Terms-and-Conditions> and for electronic format documents, subject to Terms and Conditions for Electronic Documents at <http://www.sgs.com.tw/Terms-and-Conditions>. Attention is drawn to the limitation of liability, indemnification and jurisdiction issues defined therein. Any holder of this document is advised that information contained hereon reflects the Company's findings at the time of its intervention only and within the limits of Client's instructions, if any. The Company's sole responsibility is to its Client and this document does not exonerate parties to a transaction from exercising all their rights and obligations under the transaction documents. This document cannot be reproduced except in full, without prior written approval of the Company. Any unauthorized alteration, forgery or falsification of the content or appearance of this document is unlawful and offenders may be prosecuted to the fullest extent of the law.

SGS Taiwan Ltd.

No.134,Wu Kung Road, New Taipei Industrial Park, Wuku District, New Taipei City, Taiwan/新北市五股區新北產業園區五工路 134 號

台灣檢驗科技股份有限公司

t (886-2) 2299-3279

f (886-2) 2298-0488

www.sgs.com.tw

Member of SGS Group

Radar Type2 for 5510MHz

Data Sheet for FCC Radar Type 2

Trial	VSG Frequency (MHz)	Number Pulses per Burst (23-29)	Pulse Width (1-5)	PRI (150-230)	Successful Detection
			(μ s)	(μ s)	(Yes/No)
1	5510	29	4.9	195	Yes
2	5510	28	4.1	153	Yes
3	5510	26	3.2	151	Yes
4	5510	23	1.2	227	Yes
5	5510	23	1.1	179	Yes
6	5510	26	2.9	166	Yes
7	5510	26	2.7	174	Yes
8	5510	24	2.1	230	Yes
9	5510	24	1.9	180	Yes
10	5510	29	4.8	223	Yes
11	5510	26	3.2	193	Yes
12	5510	24	1.9	155	Yes
13	5510	28	4	187	Yes
14	5510	29	5	206	Yes
15	5510	27	3.6	220	Yes
16	5510	29	4.7	175	Yes
17	5510	24	1.7	204	Yes
18	5510	26	3.1	181	Yes
19	5510	25	2.2	228	Yes
20	5510	28	4	182	Yes
21	5510	23	1.4	198	Yes
22	5510	26	3	199	Yes
23	5510	27	3.3	152	Yes
24	5510	23	1.3	178	Yes
25	5510	25	2.2	207	Yes
26	5510	27	3.4	159	Yes
27	5510	28	3.9	225	Yes
28	5510	27	3.6	168	Yes
29	5510	25	2.3	177	Yes
30	5510	29	4.7	205	Yes

Unless otherwise stated the results shown in this test report refer only to the sample(s) tested and such sample(s) are retained for 90 days only.

除非另有說明，此報告結果僅對測試之樣品負責，同時此樣品僅保留90天。本報告未經本公司書面許可，不可部份複製。

This document is issued by the Company subject to its General Conditions of Service printed overleaf, available on request or accessible at <http://www.sgs.com.tw/Terms-and-Conditions> and for electronic format documents, subject to Terms and Conditions for Electronic Documents at <http://www.sgs.com.tw/Terms-and-Conditions>. Attention is drawn to the limitation of liability, indemnification and jurisdiction issues defined therein. Any holder of this document is advised that information contained hereon reflects the Company's findings at the time of its intervention only and within the limits of Client's instructions, if any. The Company's sole responsibility is to its Client and this document does not exonerate parties to a transaction from exercising all their rights and obligations under the transaction documents. This document cannot be reproduced except in full, without prior written approval of the Company. Any unauthorized alteration, forgery or falsification of the content or appearance of this document is unlawful and offenders may be prosecuted to the fullest extent of the law.

Radar Type3 for 5510MHz

Data Sheet for FCC Radar Type 3

Trial	VSG Frequency (MHz)	Number Pulses per Burst (16-18)	Pulse Width (6-10)	PRI (200-500)	Successful Detection
			(μ s)	(μ s)	(Yes/No)
1	5510	18	9.9	442	Yes
2	5510	18	9.1	499	Yes
3	5510	17	8.2	273	Yes
4	5510	16	6.2	338	Yes
5	5510	16	6.1	487	Yes
6	5510	17	7.9	420	Yes
7	5510	17	7.7	450	Yes
8	5510	16	7.1	339	Yes
9	5510	16	6.9	405	Yes
10	5510	18	9.8	223	Yes
11	5510	17	8.2	453	Yes
12	5510	16	6.9	417	Yes
13	5510	18	9	400	Yes
14	5510	18	10	498	Yes
15	5510	17	8.6	274	Yes
16	5510	18	9.7	431	Yes
17	5510	16	6.7	294	Yes
18	5510	17	8.1	203	Yes
19	5510	16	7.2	298	Yes
20	5510	18	9	473	Yes
21	5510	16	6.4	407	Yes
22	5510	17	8	258	Yes
23	5510	17	8.3	249	Yes
24	5510	16	6.3	446	No
25	5510	16	7.2	486	Yes
26	5510	17	8.4	480	Yes
27	5510	18	8.9	370	Yes
28	5510	17	8.6	348	Yes
29	5510	16	7.3	401	Yes
30	5510	18	9.7	264	Yes

Unless otherwise stated the results shown in this test report refer only to the sample(s) tested and such sample(s) are retained for 90 days only.

除非另有說明，此報告結果僅對測試之樣品負責，同時此樣品僅保留90天。本報告未經本公司書面許可，不可部份複製。

This document is issued by the Company subject to its General Conditions of Service printed overleaf, available on request or accessible at <http://www.sgs.com.tw/Terms-and-Conditions> and for electronic format documents, subject to Terms and Conditions for Electronic Documents at <http://www.sgs.com.tw/Terms-and-Conditions>. Attention is drawn to the limitation of liability, indemnification and jurisdiction issues defined therein. Any holder of this document is advised that information contained hereon reflects the Company's findings at the time of its intervention only and within the limits of Client's instructions, if any. The Company's sole responsibility is to its Client and this document does not exonerate parties to a transaction from exercising all their rights and obligations under the transaction documents. This document cannot be reproduced except in full, without prior written approval of the Company. Any unauthorized alteration, forgery or falsification of the content or appearance of this document is unlawful and offenders may be prosecuted to the fullest extent of the law.

Radar Type4 for 5510MHz

Data Sheet for FCC Radar Type 4

Trial	VSG Frequency (MHz)	Number Pulses per Burst (12-16)	Pulse Width (11-20)	PRI (200-500)	Successful Detection
			(μ s)	(μ s)	(Yes/No)
1	5510	16	19.6	442	Yes
2	5510	15	17.8	499	Yes
3	5510	14	15.8	273	Yes
4	5510	12	11.4	338	Yes
5	5510	12	11.3	487	Yes
6	5510	14	15.3	420	Yes
7	5510	14	14.9	450	Yes
8	5510	13	13.5	339	Yes
9	5510	13	13.1	405	Yes
10	5510	16	19.5	223	Yes
11	5510	14	16	453	Yes
12	5510	13	13	417	Yes
13	5510	15	17.8	400	Yes
14	5510	16	20	498	Yes
15	5510	15	16.9	274	Yes
16	5510	16	19.2	431	Yes
17	5510	12	12.6	294	Yes
18	5510	14	15.6	203	Yes
19	5510	13	13.6	298	Yes
20	5510	15	17.6	473	Yes
21	5510	12	12.1	407	Yes
22	5510	14	15.5	258	Yes
23	5510	14	16.2	249	Yes
24	5510	12	11.7	446	Yes
25	5510	13	13.8	486	Yes
26	5510	15	16.5	480	Yes
27	5510	15	17.5	370	Yes
28	5510	15	16.8	348	Yes
29	5510	13	13.9	401	Yes
30	5510	16	19.3	264	Yes

Unless otherwise stated the results shown in this test report refer only to the sample(s) tested and such sample(s) are retained for 90 days only.

除非另有說明，此報告結果僅對測試之樣品負責，同時此樣品僅保留90天。本報告未經本公司書面許可，不可部份複製。

This document is issued by the Company subject to its General Conditions of Service printed overleaf, available on request or accessible at <http://www.sgs.com.tw/Terms-and-Conditions> and for electronic format documents, subject to Terms and Conditions for Electronic Documents at <http://www.sgs.com.tw/Terms-and-Conditions>. Attention is drawn to the limitation of liability, indemnification and jurisdiction issues defined therein. Any holder of this document is advised that information contained hereon reflects the Company's findings at the time of its intervention only and within the limits of Client's instructions, if any. The Company's sole responsibility is to its Client and this document does not exonerate parties to a transaction from exercising all their rights and obligations under the transaction documents. This document cannot be reproduced except in full, without prior written approval of the Company. Any unauthorized alteration, forgery or falsification of the content or appearance of this document is unlawful and offenders may be prosecuted to the fullest extent of the law.

Radar Type5_Trial1 for 5510MHz

Data Sheet for FCC Radar Type 5						
Trial Number:			1	VSG Frequency(MHz):		5510
Number of Bursts in Trial:			20	Successful Detection:		Yes
Burst (8-20)	Number Pulses per Burst (1-3)	Pulse Width (50-100)	Chirp Width (5-20)	Pulse 1-to-2 Spacing	Pulse 2-to-3 Spacing	Starting Location Within Interval
		(μ sec)	(MHz)	(μ sec)	(μ sec)	(μ sec)
1	3	97.7	20	1034.3	1421.3	116141
2	3	87.9	20	1634.1	1463.1	260383
3	2	76.9	20	929.1		406435
4	1	52.4	20			552540
5	1	51.8	20			98818
6	2	74	20	1785		243337
7	2	71.7	20	1586.3		388146
8	1	64	20			534217
9	1	61.5	20			80882
10	3	97.3	20	912.7	1544.7	224944
11	2	77.7	20	1096.3		370763
12	1	61.1	20			516312
13	3	87.5	20	1260.5	1441.5	62728
14	3	99.7	20	1776.3	1284.3	207224
15	2	82.7	20	1140.3		352481
16	3	95.2	20	1213.8	1162.8	495985
17	1	59.1	20			45158
18	2	75.6	20	1041.4		189991
19	1	64.7	20			335648
20	3	86.8	20	918.2	1652.2	478439

Unless otherwise stated the results shown in this test report refer only to the sample(s) tested and such sample(s) are retained for 90 days only.

除非另有說明，此報告結果僅對測試之樣品負責，同時此樣品僅保留90天。本報告未經本公司書面許可，不可部份複製。

This document is issued by the Company subject to its General Conditions of Service printed overleaf, available on request or accessible at <http://www.sgs.com.tw/Terms-and-Conditions> and for electronic format documents, subject to Terms and Conditions for Electronic Documents at <http://www.sgs.com.tw/Terms-and-Conditions>. Attention is drawn to the limitation of liability, indemnification and jurisdiction issues defined therein. Any holder of this document is advised that information contained hereon reflects the Company's findings at the time of its intervention only and within the limits of Client's instructions, if any. The Company's sole responsibility is to its Client and this document does not exonerate parties to a transaction from exercising all their rights and obligations under the transaction documents. This document cannot be reproduced except in full, without prior written approval of the Company. Any unauthorized alteration, forgery or falsification of the content or appearance of this document is unlawful and offenders may be prosecuted to the fullest extent of the law.

SGS Taiwan Ltd.

No.134,Wu Kung Road, New Taipei Industrial Park, Wuku District, New Taipei City, Taiwan/新北市五股區新北產業園區五工路 134 號

台灣檢驗科技股份有限公司

t (886-2) 2299-3279

f (886-2) 2298-0488

www.sgs.com.tw

Member of SGS Group

Radar Type5_Trial2 for 5510MHz

Data Sheet for FCC Radar Type 5						
Trial Number:		2		VSG Frequency(MHz):		5510
Number of Bursts in Trial:			17		Successful Detection: Yes	
Burst (8-20)	Number Pulses per Burst (1-3)	Pulse Width (50-100)	Chirp Width (5-20)	Pulse 1-to-2 Spacing	Pulse 2-to-3 Spacing	Starting Location Within Interval
		(μ sec)	(MHz)	(μ sec)	(μ sec)	(μ sec)
1	1	56	17			32097
2	2	75.2	17	1446.8		202501
3	2	79.1	17	1594.9		372874
4	1	54.1	17			544886
5	1	65.8	17			11064
6	2	80.4	17	1102.6		181560
7	3	86	17	1685	1290	351173
8	2	82.4	17	1445.6		522390
9	1	66.3	17			694725
10	3	95.8	17	970.2	1319.2	160367
11	3	85.6	17	1831.4	1791.4	329885
12	1	51	17			502809
13	1	64.7	17			673232
14	3	90.6	17	1053.4	1866.4	139129
15	1	53.4	17			310563
16	3	96.2	17	1065.8	1773.8	479259
17	1	65.5	17			652703
18						
19						
20						

Unless otherwise stated the results shown in this test report refer only to the sample(s) tested and such sample(s) are retained for 90 days only.

除非另有說明，此報告結果僅對測試之樣品負責，同時此樣品僅保留90天。本報告未經本公司書面許可，不可部份複製。

This document is issued by the Company subject to its General Conditions of Service printed overleaf, available on request or accessible at <http://www.sgs.com.tw/Terms-and-Conditions> and for electronic format documents, subject to Terms and Conditions for Electronic Documents at <http://www.sgs.com.tw/Terms-and-Conditions>. Attention is drawn to the limitation of liability, indemnification and jurisdiction issues defined therein. Any holder of this document is advised that information contained hereon reflects the Company's findings at the time of its intervention only and within the limits of Client's instructions, if any. The Company's sole responsibility is to its Client and this document does not exonerate parties to a transaction from exercising all their rights and obligations under the transaction documents. This document cannot be reproduced except in full, without prior written approval of the Company. Any unauthorized alteration, forgery or falsification of the content or appearance of this document is unlawful and offenders may be prosecuted to the fullest extent of the law.

SGS Taiwan Ltd. No.134,Wu Kung Road, New Taipei Industrial Park, Wuku District, New Taipei City, Taiwan/新北市五股區新北產業園區五工路 134 號

Radar Type5_Trial3 for 5510MHz

Data Sheet for FCC Radar Type 5						
Trial Number:			3	VSG Frequency(MHz):		5510
Number of Bursts in Trial:			14	Successful Detection:		Yes
Burst (8-20)	Number Pulses per Burst (1-3)	Pulse Width (50-100)	Chirp Width (5-20)	Pulse 1-to-2 Spacing	Pulse 2-to-3 Spacing	Starting Location Within Interval
		(μ sec)	(MHz)	(μ sec)	(μ sec)	(μ sec)
1	2	75.2	13	1361.8		143969
2	3	90.7	13	1099.3	988.3	350947
3	3	93.8	13	1045.2	1043.2	557505
4	1	60.8	13			766524
5	3	98.2	13	1508.8	1876.8	118256
6	3	88.5	13	959.5	1339.5	325401
7	3	90.5	13	1857.5	1691.5	531589
8	2	74.6	13	957.4		740731
9	2	74.5	13	1040.5		92978
10	1	53.5	13			300652
11	3	89.7	13	1803.3	1110.3	506183
12	2	80.9	13	1738.1		714128
13	1	51.5	13			67556
14	2	80.4	13	1193.6		274857
15						
16						
17						
18						
19						
20						

Unless otherwise stated the results shown in this test report refer only to the sample(s) tested and such sample(s) are retained for 90 days only.

除非另有說明，此報告結果僅對測試之樣品負責，同時此樣品僅保留90天。本報告未經本公司書面許可，不可部份複製。

This document is issued by the Company subject to its General Conditions of Service printed overleaf, available on request or accessible at <http://www.sgs.com.tw/Terms-and-Conditions> and for electronic format documents, subject to Terms and Conditions for Electronic Documents at <http://www.sgs.com.tw/Terms-and-Conditions>. Attention is drawn to the limitation of liability, indemnification and jurisdiction issues defined therein. Any holder of this document is advised that information contained hereon reflects the Company's findings at the time of its intervention only and within the limits of Client's instructions, if any. The Company's sole responsibility is to its Client and this document does not exonerate parties to a transaction from exercising all their rights and obligations under the transaction documents. This document cannot be reproduced except in full, without prior written approval of the Company. Any unauthorized alteration, forgery or falsification of the content or appearance of this document is unlawful and offenders may be prosecuted to the fullest extent of the law.

Radar Type5_Trial4 for 5510MHz

Data Sheet for FCC Radar Type 5						
Trial Number:			4	VSG Frequency(MHz):		5510
Number of Bursts in Trial:			8	Successful Detection:		Yes
Burst (8-20)	Number Pulses per Burst (1-3)	Pulse Width (50-100)	Chirp Width (5-20)	Pulse 1-to-2 Spacing	Pulse 2-to-3 Spacing	Starting Location Within Interval
		(μ sec)	(MHz)	(μ sec)	(μ sec)	(μ sec)
1	1	59.8	5			845339
2	1	65.7	5			1208624
3	2	70.7	5	1208.3		73525
4	2	72.4	5	1543.6		436604
5	2	72.4	5	961.6		800038
6	1	58.8	5			1164144
7	2	72.8	5	1723.2		28791
8	3	86.7	5	1407.3	1824.3	391341
9						
10						
11						
12						
13						
14						
15						
16						
17						
18						
19						
20						

Unless otherwise stated the results shown in this test report refer only to the sample(s) tested and such sample(s) are retained for 90 days only.

除非另有說明，此報告結果僅對測試之樣品負責，同時此樣品僅保留90天。本報告未經本公司書面許可，不可部份複製。

This document is issued by the Company subject to its General Conditions of Service printed overleaf, available on request or accessible at <http://www.sgs.com.tw/Terms-and-Conditions> and for electronic format documents, subject to Terms and Conditions for Electronic Documents at <http://www.sgs.com.tw/Terms-and-Conditions>. Attention is drawn to the limitation of liability, indemnification and jurisdiction issues defined therein. Any holder of this document is advised that information contained hereon reflects the Company's findings at the time of its intervention only and within the limits of Client's instructions, if any. The Company's sole responsibility is to its Client and this document does not exonerate parties to a transaction from exercising all their rights and obligations under the transaction documents. This document cannot be reproduced except in full, without prior written approval of the Company. Any unauthorized alteration, forgery or falsification of the content or appearance of this document is unlawful and offenders may be prosecuted to the fullest extent of the law.

SGS Taiwan Ltd.

No.134,Wu Kung Road, New Taipei Industrial Park, Wuku District, New Taipei City, Taiwan/新北市五股區新北產業園區五工路 134 號

台灣檢驗科技股份有限公司

t (886-2) 2299-3279

f (886-2) 2298-0488

www.sgs.com.tw

Member of SGS Group

Radar Type5_Trial5 for 5510MHz

Data Sheet for FCC Radar Type 5						
Trial Number:			5	VSG Frequency(MHz):		5510
Number of Bursts in Trial:			8	Successful Detection:		Yes
Burst (8-20)	Number Pulses per Burst (1-3)	Pulse Width (50-100)	Chirp Width (5-20)	Pulse 1-to-2 Spacing	Pulse 2-to-3 Spacing	Starting Location Within Interval
		(μ sec)	(MHz)	(μ sec)	(μ sec)	(μ sec)
1	2	71.5	5	1024.5		755079
2	3	88	5	1905	1547	1116130
3	3	89.4	5	1595.6	1232.6	1479179
4	3	97.7	5	1549.3	1090.3	346877
5	1	65.8	5			710997
6	1	61.7	5			1074422
7	2	76.6	5	1387.4		1436084
8	3	96.5	5	1571.5	925.5	302135
9						
10						
11						
12						
13						
14						
15						
16						
17						
18						
19						
20						

Unless otherwise stated the results shown in this test report refer only to the sample(s) tested and such sample(s) are retained for 90 days only.

除非另有說明，此報告結果僅對測試之樣品負責，同時此樣品僅保留90天。本報告未經本公司書面許可，不可部份複製。

This document is issued by the Company subject to its General Conditions of Service printed overleaf, available on request or accessible at <http://www.sgs.com.tw/Terms-and-Conditions> and for electronic format documents, subject to Terms and Conditions for Electronic Documents at <http://www.sgs.com.tw/Terms-and-Conditions>. Attention is drawn to the limitation of liability, indemnification and jurisdiction issues defined therein. Any holder of this document is advised that information contained hereon reflects the Company's findings at the time of its intervention only and within the limits of Client's instructions, if any. The Company's sole responsibility is to its Client and this document does not exonerate parties to a transaction from exercising all their rights and obligations under the transaction documents. This document cannot be reproduced except in full, without prior written approval of the Company. Any unauthorized alteration, forgery or falsification of the content or appearance of this document is unlawful and offenders may be prosecuted to the fullest extent of the law.

Radar Type5_Trial6 for 5510MHz

Data Sheet for FCC Radar Type 5						
Trial Number:			6	VSG Frequency(MHz):		5510
Number of Bursts in Trial:			14	Successful Detection:		Yes
Burst (8-20)	Number Pulses per Burst (1-3)	Pulse Width (50-100)	Chirp Width (5-20)	Pulse 1-to-2 Spacing	Pulse 2-to-3 Spacing	Starting Location Within Interval
		(μ sec)	(MHz)	(μ sec)	(μ sec)	(μ sec)
1	3	97	12	1506	1903	378573
2	3	96.3	12	926.7	1064.7	586348
3	3	86.5	12	1416.5	964.5	793292
4	2	79.6	12	1505.4		146992
5	3	84	12	1459	1858	353209
6	3	85	12	1028	1539	560501
7	2	71	12	1692		767848
8	2	76	12	1081		121542
9	1	57.9	12			329085
10	3	86.7	12	1679.3	1245.3	535068
11	3	88.6	12	1154.4	1637.4	741864
12	2	79.5	12	1696.5		95986
13	3	91.3	12	1797.7	1841.7	302190
14	2	76.8	12	1755.2		510022
15						
16						
17						
18						
19						
20						

Unless otherwise stated the results shown in this test report refer only to the sample(s) tested and such sample(s) are retained for 90 days only.

除非另有說明，此報告結果僅對測試之樣品負責，同時此樣品僅保留90天。本報告未經本公司書面許可，不可部份複製。

This document is issued by the Company subject to its General Conditions of Service printed overleaf, available on request or accessible at <http://www.sgs.com.tw/Terms-and-Conditions> and for electronic format documents, subject to Terms and Conditions for Electronic Documents at <http://www.sgs.com.tw/Terms-and-Conditions>. Attention is drawn to the limitation of liability, indemnification and jurisdiction issues defined therein. Any holder of this document is advised that information contained hereon reflects the Company's findings at the time of its intervention only and within the limits of Client's instructions, if any. The Company's sole responsibility is to its Client and this document does not exonerate parties to a transaction from exercising all their rights and obligations under the transaction documents. This document cannot be reproduced except in full, without prior written approval of the Company. Any unauthorized alteration, forgery or falsification of the content or appearance of this document is unlawful and offenders may be prosecuted to the fullest extent of the law.

Radar Type5_Trial7 for 5510MHz

Data Sheet for FCC Radar Type 5						
Trial Number:			7	VSG Frequency(MHz):		5510
Number of Bursts in Trial:			13	Successful Detection:		Yes
Burst (8-20)	Number Pulses per Burst (1-3)	Pulse Width (50-100)	Chirp Width (5-20)	Pulse 1-to-2 Spacing	Pulse 2-to-3 Spacing	Starting Location Within Interval
		(μ sec)	(MHz)	(μ sec)	(μ sec)	(μ sec)
1	3	96.4	11	1752.6	1109.6	771194
2	1	51.4	11			76092
3	1	64.8	11			299489
4	1	65.3	11			522832
5	2	75.7	11	1670.3		745337
6	3	85.4	11	1250.6	979.6	48408
7	3	94	11	1772	1352	270970
8	2	68.1	11	1265.9		494746
9	2	81	11	1161		717983
10	3	87.4	11	1328.6	1906.6	20904
11	3	92.8	11	1267.2	1676.2	243688
12	3	88.6	11	1875.4	1638.4	465906
13	2	69.2	11	1282.8		690603
14						
15						
16						
17						
18						
19						
20						

Unless otherwise stated the results shown in this test report refer only to the sample(s) tested and such sample(s) are retained for 90 days only.

除非另有說明，此報告結果僅對測試之樣品負責，同時此樣品僅保留90天。本報告未經本公司書面許可，不可部份複製。

This document is issued by the Company subject to its General Conditions of Service printed overleaf, available on request or accessible at <http://www.sgs.com.tw/Terms-and-Conditions> and for electronic format documents, subject to Terms and Conditions for Electronic Documents at <http://www.sgs.com.tw/Terms-and-Conditions>. Attention is drawn to the limitation of liability, indemnification and jurisdiction issues defined therein. Any holder of this document is advised that information contained hereon reflects the Company's findings at the time of its intervention only and within the limits of Client's instructions, if any. The Company's sole responsibility is to its Client and this document does not exonerate parties to a transaction from exercising all their rights and obligations under the transaction documents. This document cannot be reproduced except in full, without prior written approval of the Company. Any unauthorized alteration, forgery or falsification of the content or appearance of this document is unlawful and offenders may be prosecuted to the fullest extent of the law.

Radar Type5_Trial8 for 5510MHz

Data Sheet for FCC Radar Type 5						
Trial Number:		8		VSG Frequency(MHz):		5510
Number of Bursts in Trial:			11		Successful Detection: Yes	
Burst (8-20)	Number Pulses per Burst (1-3)	Pulse Width (50-100)	Chirp Width (5-20)	Pulse 1-to-2 Spacing	Pulse 2-to-3 Spacing	Starting Location Within Interval
		(μ sec)	(MHz)	(μ sec)	(μ sec)	(μ sec)
1	1	55.7	9			1081971
2	2	71.5	9	1428.5		256209
3	1	50.4	9			520922
4	2	72.7	9	1676.3		783872
5	2	78.8	9	1564.2		1047535
6	3	98	9	1686	1848	223101
7	2	78.1	9	1319.9		487378
8	1	56.6	9			752190
9	3	93.4	9	1339.6	1120.6	1013747
10	3	94.4	9	1471.6	1168.6	190967
11	2	71.9	9	1853.1		454777
12						
13						
14						
15						
16						
17						
18						
19						
20						

Unless otherwise stated the results shown in this test report refer only to the sample(s) tested and such sample(s) are retained for 90 days only.

除非另有說明，此報告結果僅對測試之樣品負責，同時此樣品僅保留90天。本報告未經本公司書面許可，不可部份複製。

This document is issued by the Company subject to its General Conditions of Service printed overleaf, available on request or accessible at <http://www.sgs.com.tw/Terms-and-Conditions> and for electronic format documents, subject to Terms and Conditions for Electronic Documents at <http://www.sgs.com.tw/Terms-and-Conditions>. Attention is drawn to the limitation of liability, indemnification and jurisdiction issues defined therein. Any holder of this document is advised that information contained hereon reflects the Company's findings at the time of its intervention only and within the limits of Client's instructions, if any. The Company's sole responsibility is to its Client and this document does not exonerate parties to a transaction from exercising all their rights and obligations under the transaction documents. This document cannot be reproduced except in full, without prior written approval of the Company. Any unauthorized alteration, forgery or falsification of the content or appearance of this document is unlawful and offenders may be prosecuted to the fullest extent of the law.

SGS Taiwan Ltd.

No.134,Wu Kung Road, New Taipei Industrial Park, Wuku District, New Taipei City, Taiwan/新北市五股區新北產業園區五工路 134 號

台灣檢驗科技股份有限公司

t (886-2) 2299-3279

f (886-2) 2298-0488

www.sgs.com.tw

Member of SGS Group

Radar Type5_Trial9 for 5510MHz

Data Sheet for FCC Radar Type 5						
Trial Number:			9	VSG Frequency(MHz):		5510
Number of Bursts in Trial:			11	Successful Detection:		Yes
Burst (8-20)	Number Pulses per Burst (1-3)	Pulse Width (50-100)	Chirp Width (5-20)	Pulse 1-to-2 Spacing	Pulse 2-to-3 Spacing	Starting Location Within Interval
		(μ sec)	(MHz)	(μ sec)	(μ sec)	(μ sec)
1	3	96.5	8	1238.5	1767.5	717802
2	2	74.9	8	1820.1		982334
3	3	94.7	8	1012.3	1446.3	158509
4	3	94.8	8	1520.2	1653.2	421684
5	1	64.4	8			687423
6	3	85.8	8	960.2	1385.2	949648
7	2	70.2	8	1167.8		126134
8	3	93.3	8	943.7	1289.7	389725
9	3	95.4	8	1101.6	1896.6	652936
10	3	94.7	8	1841.3	1060.3	916384
11	3	91.7	8	1816.3	1181.3	93458
12						
13						
14						
15						
16						
17						
18						
19						
20						

Unless otherwise stated the results shown in this test report refer only to the sample(s) tested and such sample(s) are retained for 90 days only.

除非另有說明，此報告結果僅對測試之樣品負責，同時此樣品僅保留90天。本報告未經本公司書面許可，不可部份複製。

This document is issued by the Company subject to its General Conditions of Service printed overleaf, available on request or accessible at <http://www.sgs.com.tw/Terms-and-Conditions> and for electronic format documents, subject to Terms and Conditions for Electronic Documents at <http://www.sgs.com.tw/Terms-and-Conditions>. Attention is drawn to the limitation of liability, indemnification and jurisdiction issues defined therein. Any holder of this document is advised that information contained hereon reflects the Company's findings at the time of its intervention only and within the limits of Client's instructions, if any. The Company's sole responsibility is to its Client and this document does not exonerate parties to a transaction from exercising all their rights and obligations under the transaction documents. This document cannot be reproduced except in full, without prior written approval of the Company. Any unauthorized alteration, forgery or falsification of the content or appearance of this document is unlawful and offenders may be prosecuted to the fullest extent of the law.

Radar Type5_Trial10 for 5510MHz

Data Sheet for FCC Radar Type 5						
Trial Number:		10		VSG Frequency(MHz):		5510
Number of Bursts in Trial:			20		Successful Detection: Yes	
Burst (8-20)	Number Pulses per Burst (1-3)	Pulse Width (50-100)	Chirp Width (5-20)	Pulse 1-to-2 Spacing	Pulse 2-to-3 Spacing	Starting Location Within Interval
		(μ sec)	(MHz)	(μ sec)	(μ sec)	(μ sec)
1	3	87.9	20	1065.1	1054.1	195845
2	2	82.9	20	1649.1		340735
3	1	50.4	20			487164
4	3	86.1	20	1511.9	1327.9	33463
5	3	91.3	20	1333.7	1629.7	177985
6	1	52.4	20			324139
7	2	78.8	20	964.2		468273
8	1	65.2	20			15748
9	3	99.2	20	1105.8	1472.8	160137
10	3	86.9	20	1715.1	1671.1	304464
11	3	95.4	20	1764.6	1171.6	448919
12	1	65.8	20			596028
13	1	65.2	20			142978
14	1	54.5	20			287964
15	1	57.4	20			433443
16	1	64	20			578958
17	1	59.8	20			125123
18	2	81.5	20	1113.5		269660
19	1	63.1	20			415298
20	2	70.1	20	1113.9		559053

Unless otherwise stated the results shown in this test report refer only to the sample(s) tested and such sample(s) are retained for 90 days only.

除非另有說明，此報告結果僅對測試之樣品負責，同時此樣品僅保留90天。本報告未經本公司書面許可，不可部份複製。

This document is issued by the Company subject to its General Conditions of Service printed overleaf, available on request or accessible at <http://www.sgs.com.tw/Terms-and-Conditions> and for electronic format documents, subject to Terms and Conditions for Electronic Documents at <http://www.sgs.com.tw/Terms-and-Conditions>. Attention is drawn to the limitation of liability, indemnification and jurisdiction issues defined therein. Any holder of this document is advised that information contained hereon reflects the Company's findings at the time of its intervention only and within the limits of Client's instructions, if any. The Company's sole responsibility is to its Client and this document does not exonerate parties to a transaction from exercising all their rights and obligations under the transaction documents. This document cannot be reproduced except in full, without prior written approval of the Company. Any unauthorized alteration, forgery or falsification of the content or appearance of this document is unlawful and offenders may be prosecuted to the fullest extent of the law.

Radar Type5_Trial11 for 5510MHz

Data Sheet for FCC Radar Type 5						
Trial Number:		11		VSG Frequency(MHz):		5496.337
Number of Bursts in Trial:			15		Successful Detection: Yes	
Burst (8-20)	Number Pulses per Burst (1-3)	Pulse Width (50-100)	Chirp Width (5-20)	Pulse 1-to-2 Spacing	Pulse 2-to-3 Spacing	Starting Location Within Interval
		(μ sec)	(MHz)	(μ sec)	(μ sec)	(μ sec)
1	1	52.9	13			143103
2	1	57	13			336633
3	3	93	13	1786	1375	528454
4	2	68.8	13	1796.2		722576
5	1	50.7	13			119259
6	3	90.7	13	1150.3	1478.3	311911
7	3	99.3	13	1551.7	1326.7	504351
8	1	53.6	13			700354
9	3	95.3	13	1600.7	1466.7	95028
10	2	67.1	13	1419.9		288667
11	3	99.5	13	1883.5	1753.5	480592
12	3	93.2	13	1087.8	1551.8	673584
13	2	74.5	13	1562.5		71396
14	1	64.1	13			265211
15	3	83.6	13	1622.4	1038.4	457007
16						
17						
18						
19						
20						

Unless otherwise stated the results shown in this test report refer only to the sample(s) tested and such sample(s) are retained for 90 days only.

除非另有說明，此報告結果僅對測試之樣品負責，同時此樣品僅保留90天。本報告未經本公司書面許可，不可部份複製。

This document is issued by the Company subject to its General Conditions of Service printed overleaf, available on request or accessible at <http://www.sgs.com.tw/Terms-and-Conditions> and for electronic format documents, subject to Terms and Conditions for Electronic Documents at <http://www.sgs.com.tw/Terms-and-Conditions>. Attention is drawn to the limitation of liability, indemnification and jurisdiction issues defined therein. Any holder of this document is advised that information contained hereon reflects the Company's findings at the time of its intervention only and within the limits of Client's instructions, if any. The Company's sole responsibility is to its Client and this document does not exonerate parties to a transaction from exercising all their rights and obligations under the transaction documents. This document cannot be reproduced except in full, without prior written approval of the Company. Any unauthorized alteration, forgery or falsification of the content or appearance of this document is unlawful and offenders may be prosecuted to the fullest extent of the law.

SGS Taiwan Ltd.

No.134,Wu Kung Road, New Taipei Industrial Park, Wuku District, New Taipei City, Taiwan/新北市五股區新北產業園區五工路 134 號

台灣檢驗科技股份有限公司

t (886-2) 2299-3279

f (886-2) 2298-0488

www.sgs.com.tw

Member of SGS Group

Radar Type5_Trial12 for 5510MHz

Data Sheet for FCC Radar Type 5						
Trial Number:		12		VSG Frequency(MHz):		5494.337
Number of Bursts in Trial:			10		Successful Detection: Yes	
Burst (8-20)	Number Pulses per Burst (1-3)	Pulse Width (50-100)	Chirp Width (5-20)	Pulse 1-to-2 Spacing	Pulse 2-to-3 Spacing	Starting Location Within Interval
		(μ sec)	(MHz)	(μ sec)	(μ sec)	(μ sec)
1	2	67.5	8	1366.5		978633
2	2	72.3	8	1722.7		71453
3	3	92.8	8	1745.2	1601.2	361200
4	1	56.7	8			653086
5	2	75.7	8	1346.3		942117
6	2	77.9	8	1602.1		35724
7	2	78.1	8	933.9		326175
8	3	95.3	8	1766.7	1165.7	615613
9	3	85.1	8	1363.9	1704.9	905273
10	1	51.1	8			1198252
11						
12						
13						
14						
15						
16						
17						
18						
19						
20						

Unless otherwise stated the results shown in this test report refer only to the sample(s) tested and such sample(s) are retained for 90 days only.

除非另有說明，此報告結果僅對測試之樣品負責，同時此樣品僅保留90天。本報告未經本公司書面許可，不可部份複製。

This document is issued by the Company subject to its General Conditions of Service printed overleaf, available on request or accessible at <http://www.sgs.com.tw/Terms-and-Conditions> and for electronic format documents, subject to Terms and Conditions for Electronic Documents at <http://www.sgs.com.tw/Terms-and-Conditions>. Attention is drawn to the limitation of liability, indemnification and jurisdiction issues defined therein. Any holder of this document is advised that information contained hereon reflects the Company's findings at the time of its intervention only and within the limits of Client's instructions, if any. The Company's sole responsibility is to its Client and this document does not exonerate parties to a transaction from exercising all their rights and obligations under the transaction documents. This document cannot be reproduced except in full, without prior written approval of the Company. Any unauthorized alteration, forgery or falsification of the content or appearance of this document is unlawful and offenders may be prosecuted to the fullest extent of the law.

Radar Type5_Trial13 for 5510MHz

Data Sheet for FCC Radar Type 5						
Trial Number:		13		VSG Frequency(MHz):		5497.537
Number of Bursts in Trial:			17		Successful Detection: Yes	
Burst (8-20)	Number Pulses per Burst (1-3)	Pulse Width (50-100)	Chirp Width (5-20)	Pulse 1-to-2 Spacing	Pulse 2-to-3 Spacing	Starting Location Within Interval
		(μ sec)	(MHz)	(μ sec)	(μ sec)	(μ sec)
1	1	59	16			170817
2	2	79.5	16	990.5		341357
3	3	90.3	16	1075.7	1220.7	510526
4	1	57	16			683467
5	2	71.8	16	1218.2		149404
6	1	60.4	16			320410
7	1	61.8	16			491519
8	2	82.3	16	1727.7		660636
9	2	74.5	16	1601.5		128495
10	3	88.7	16	975.3	1412.3	298307
11	2	80.8	16	1746.2		469475
12	3	90	16	1030	1551	638300
13	2	81.6	16	1088.4		107469
14	3	85.3	16	1827.7	1324.7	277145
15	1	50.6	16			449387
16	1	53.2	16			620125
17	2	75.1	16	1843.9		86364
18						
19						
20						

Unless otherwise stated the results shown in this test report refer only to the sample(s) tested and such sample(s) are retained for 90 days only.

除非另有說明，此報告結果僅對測試之樣品負責，同時此樣品僅保留90天。本報告未經本公司書面許可，不可部份複製。

This document is issued by the Company subject to its General Conditions of Service printed overleaf, available on request or accessible at <http://www.sgs.com.tw/Terms-and-Conditions> and for electronic format documents, subject to Terms and Conditions for Electronic Documents at <http://www.sgs.com.tw/Terms-and-Conditions>. Attention is drawn to the limitation of liability, indemnification and jurisdiction issues defined therein. Any holder of this document is advised that information contained hereon reflects the Company's findings at the time of its intervention only and within the limits of Client's instructions, if any. The Company's sole responsibility is to its Client and this document does not exonerate parties to a transaction from exercising all their rights and obligations under the transaction documents. This document cannot be reproduced except in full, without prior written approval of the Company. Any unauthorized alteration, forgery or falsification of the content or appearance of this document is unlawful and offenders may be prosecuted to the fullest extent of the law.

SGS Taiwan Ltd.

No.134,Wu Kung Road, New Taipei Industrial Park, Wuku District, New Taipei City, Taiwan/新北市五股區新北產業園區五工路 134 號

台灣檢驗科技股份有限公司

t (886-2) 2299-3279

f (886-2) 2298-0488

www.sgs.com.tw

Member of SGS Group

Radar Type5_Trial14 for 5510MHz

Data Sheet for FCC Radar Type 5						
Trial Number:		14		VSG Frequency(MHz):		5499.137
Number of Bursts in Trial:			20		Successful Detection: Yes	
Burst (8-20)	Number Pulses per Burst (1-3)	Pulse Width (50-100)	Chirp Width (5-20)	Pulse 1-to-2 Spacing	Pulse 2-to-3 Spacing	Starting Location Within Interval
		(μ sec)	(MHz)	(μ sec)	(μ sec)	(μ sec)
1	2	70	20	1015		218197
2	2	82	20	1063		363178
3	3	87.4	20	1016.6	1573.6	506900
4	1	52.2	20			55765
5	3	91.3	20	1392.7	1490.7	199823
6	1	51	20			346092
7	2	70.9	20	1197.1		490061
8	3	89.9	20	1240.1	1198.1	37702
9	3	91.8	20	1314.2	999.2	182230
10	2	67.1	20	1850.9		326990
11	2	74.7	20	1018.3		472340
12	3	87.5	20	916.5	1912.5	19883
13	3	92.3	20	1126.7	1650.7	164207
14	2	74.8	20	1634.2		309633
15	1	61.7	20			455707
16	1	57.8	20			2102
17	2	67.7	20	1674.3		146931
18	3	91.8	20	1452.2	1631.2	290728
19	1	61.1	20			437450
20	1	58.9	20			582293

Unless otherwise stated the results shown in this test report refer only to the sample(s) tested and such sample(s) are retained for 90 days only.

除非另有說明，此報告結果僅對測試之樣品負責，同時此樣品僅保留90天。本報告未經本公司書面許可，不可部份複製。

This document is issued by the Company subject to its General Conditions of Service printed overleaf, available on request or accessible at <http://www.sgs.com.tw/Terms-and-Conditions> and for electronic format documents, subject to Terms and Conditions for Electronic Documents at <http://www.sgs.com.tw/Terms-and-Conditions>. Attention is drawn to the limitation of liability, indemnification and jurisdiction issues defined therein. Any holder of this document is advised that information contained hereon reflects the Company's findings at the time of its intervention only and within the limits of Client's instructions, if any. The Company's sole responsibility is to its Client and this document does not exonerate parties to a transaction from exercising all their rights and obligations under the transaction documents. This document cannot be reproduced except in full, without prior written approval of the Company. Any unauthorized alteration, forgery or falsification of the content or appearance of this document is unlawful and offenders may be prosecuted to the fullest extent of the law.

SGS Taiwan Ltd.

No.134,Wu Kung Road, New Taipei Industrial Park, Wuku District, New Taipei City, Taiwan/新北市五股區新北產業園區五工路 134 號

台灣檢驗科技股份有限公司

t (886-2) 2299-3279

f (886-2) 2298-0488

www.sgs.com.tw

Member of SGS Group

Radar Type5_Trial15 for 5510MHz

Data Sheet for FCC Radar Type 5						
Trial Number:		15		VSG Frequency(MHz):		5497.137
Number of Bursts in Trial:			16		Successful Detection: Yes	
Burst (8-20)	Number Pulses per Burst (1-3)	Pulse Width (50-100)	Chirp Width (5-20)	Pulse 1-to-2 Spacing	Pulse 2-to-3 Spacing	Starting Location Within Interval
		(μ sec)	(MHz)	(μ sec)	(μ sec)	(μ sec)
1	3	96.7	15	1581.3	1271.3	161051
2	2	73.5	15	1917.5		342354
3	1	56.7	15			524731
4	3	87.7	15	1898.3	1496.3	703120
5	1	60.8	15			139360
6	3	100	15	1513	1072	319792
7	2	75.5	15	1704.5		501115
8	1	52.7	15			683650
9	2	77.6	15	1511.4		116904
10	3	90.7	15	1515.3	1368.3	297489
11	1	57.4	15			480050
12	1	56.1	15			661425
13	2	72.5	15	1240.5		94607
14	1	52.8	15			276358
15	1	58.1	15			458076
16	1	63.3	15			639282
17						
18						
19						
20						

Unless otherwise stated the results shown in this test report refer only to the sample(s) tested and such sample(s) are retained for 90 days only.

除非另有說明，此報告結果僅對測試之樣品負責，同時此樣品僅保留90天。本報告未經本公司書面許可，不可部份複製。

This document is issued by the Company subject to its General Conditions of Service printed overleaf, available on request or accessible at <http://www.sgs.com.tw/Terms-and-Conditions> and for electronic format documents, subject to Terms and Conditions for Electronic Documents at <http://www.sgs.com.tw/Terms-and-Conditions>. Attention is drawn to the limitation of liability, indemnification and jurisdiction issues defined therein. Any holder of this document is advised that information contained hereon reflects the Company's findings at the time of its intervention only and within the limits of Client's instructions, if any. The Company's sole responsibility is to its Client and this document does not exonerate parties to a transaction from exercising all their rights and obligations under the transaction documents. This document cannot be reproduced except in full, without prior written approval of the Company. Any unauthorized alteration, forgery or falsification of the content or appearance of this document is unlawful and offenders may be prosecuted to the fullest extent of the law.

Radar Type5_Trial16 for 5510MHz

Data Sheet for FCC Radar Type 5						
Trial Number:		16		VSG Frequency(MHz):		5498.737
Number of Bursts in Trial:			19		Successful Detection: Yes	
Burst (8-20)	Number Pulses per Burst (1-3)	Pulse Width (50-100)	Chirp Width (5-20)	Pulse 1-to-2 Spacing	Pulse 2-to-3 Spacing	Starting Location Within Interval
		(μ sec)	(MHz)	(μ sec)	(μ sec)	(μ sec)
1	3	97.8	19	1035.2	1109.2	60664
2	3	98.9	19	1349.1	1179.1	212758
3	2	67.7	19	1877.3		365185
4	2	78.4	19	1897.6		517638
5	2	69.3	19	1353.7		42020
6	2	67.1	19	1256.9		194546
7	2	80.1	19	1704.9		346961
8	3	93.4	19	935.6	1527.6	498702
9	3	87.1	19	1769.9	1303.9	23150
10	3	94.9	19	1043.1	1752.1	175148
11	2	82.3	19	1429.7		328193
12	1	63.8	19			481836
13	2	69	19	1717		4428
14	2	82.1	19	1509.9		156800
15	1	63.9	19			310290
16	3	93.6	19	1131.4	1715.4	460941
17	3	89.5	19	1035.5	927.5	613436
18	3	94.3	19	1285.7	1082.7	137818
19	2	78.4	19	1681.6		290315
20						

Unless otherwise stated the results shown in this test report refer only to the sample(s) tested and such sample(s) are retained for 90 days only.

除非另有說明，此報告結果僅對測試之樣品負責，同時此樣品僅保留90天。本報告未經本公司書面許可，不可部份複製。

This document is issued by the Company subject to its General Conditions of Service printed overleaf, available on request or accessible at <http://www.sgs.com.tw/Terms-and-Conditions> and for electronic format documents, subject to Terms and Conditions for Electronic Documents at <http://www.sgs.com.tw/Terms-and-Conditions>. Attention is drawn to the limitation of liability, indemnification and jurisdiction issues defined therein. Any holder of this document is advised that information contained hereon reflects the Company's findings at the time of its intervention only and within the limits of Client's instructions, if any. The Company's sole responsibility is to its Client and this document does not exonerate parties to a transaction from exercising all their rights and obligations under the transaction documents. This document cannot be reproduced except in full, without prior written approval of the Company. Any unauthorized alteration, forgery or falsification of the content or appearance of this document is unlawful and offenders may be prosecuted to the fullest extent of the law.

SGS Taiwan Ltd.

No.134,Wu Kung Road, New Taipei Industrial Park, Wuku District, New Taipei City, Taiwan/新北市五股區新北產業園區五工路 134 號

台灣檢驗科技股份有限公司

t (886-2) 2299-3279

f (886-2) 2298-0488

www.sgs.com.tw

Member of SGS Group

Radar Type5_Trial17 for 5510MHz

Data Sheet for FCC Radar Type 5						
Trial Number:		17		VSG Frequency(MHz):		5493.937
Number of Bursts in Trial:			10		Successful Detection: Yes	
Burst (8-20)	Number Pulses per Burst (1-3)	Pulse Width (50-100)	Chirp Width (5-20)	Pulse 1-to-2 Spacing	Pulse 2-to-3 Spacing	Starting Location Within Interval
		(μ sec)	(MHz)	(μ sec)	(μ sec)	(μ sec)
1	3	96.6	7	1648.4	1865.4	841832
2	2	75.3	7	1301.7		1134370
3	3	99.8	7	1691.2	928.2	226986
4	3	91.4	7	1351.6	1845.6	516768
5	3	91.3	7	1507.7	1109.7	806793
6	2	75.6	7	1497.4		1097643
7	2	68.2	7	1628.8		191388
8	1	62.3	7			482197
9	1	51	7			773239
10	1	59.6	7			1063311
11						
12						
13						
14						
15						
16						
17						
18						
19						
20						

Unless otherwise stated the results shown in this test report refer only to the sample(s) tested and such sample(s) are retained for 90 days only.

除非另有說明，此報告結果僅對測試之樣品負責，同時此樣品僅保留90天。本報告未經本公司書面許可，不可部份複製。

This document is issued by the Company subject to its General Conditions of Service printed overleaf, available on request or accessible at <http://www.sgs.com.tw/Terms-and-Conditions> and for electronic format documents, subject to Terms and Conditions for Electronic Documents at <http://www.sgs.com.tw/Terms-and-Conditions>. Attention is drawn to the limitation of liability, indemnification and jurisdiction issues defined therein. Any holder of this document is advised that information contained hereon reflects the Company's findings at the time of its intervention only and within the limits of Client's instructions, if any. The Company's sole responsibility is to its Client and this document does not exonerate parties to a transaction from exercising all their rights and obligations under the transaction documents. This document cannot be reproduced except in full, without prior written approval of the Company. Any unauthorized alteration, forgery or falsification of the content or appearance of this document is unlawful and offenders may be prosecuted to the fullest extent of the law.

Radar Type5_Trial18 for 5510MHz

Data Sheet for FCC Radar Type 5						
Trial Number:		18		VSG Frequency(MHz):		5496.337
Number of Bursts in Trial:			14		Successful Detection: Yes	
Burst (8-20)	Number Pulses per Burst (1-3)	Pulse Width (50-100)	Chirp Width (5-20)	Pulse 1-to-2 Spacing	Pulse 2-to-3 Spacing	Starting Location Within Interval
		(μ sec)	(MHz)	(μ sec)	(μ sec)	(μ sec)
1	2	68.6	13	1499.4		111159
2	1	64.9	13			318639
3	3	89.4	13	1225.6	1206.6	525016
4	2	66.7	13	1407.3		732895
5	3	98.5	13	1094.5	1290.5	85461
6	1	60.1	13			293098
7	2	68.9	13	1207.1		499889
8	2	74	13	1650		706709
9	2	82.7	13	937.3		60119
10	3	89.7	13	913.3	1511.3	266981
11	2	79.6	13	1323.4		474208
12	3	93.4	13	1709.6	922.6	680794
13	1	63.3	13			34618
14	1	50.5	13			242067
15						
16						
17						
18						
19						
20						

Unless otherwise stated the results shown in this test report refer only to the sample(s) tested and such sample(s) are retained for 90 days only.

除非另有說明，此報告結果僅對測試之樣品負責，同時此樣品僅保留90天。本報告未經本公司書面許可，不可部份複製。

This document is issued by the Company subject to its General Conditions of Service printed overleaf, available on request or accessible at <http://www.sgs.com.tw/Terms-and-Conditions> and for electronic format documents, subject to Terms and Conditions for Electronic Documents at <http://www.sgs.com.tw/Terms-and-Conditions>. Attention is drawn to the limitation of liability, indemnification and jurisdiction issues defined therein. Any holder of this document is advised that information contained hereon reflects the Company's findings at the time of its intervention only and within the limits of Client's instructions, if any. The Company's sole responsibility is to its Client and this document does not exonerate parties to a transaction from exercising all their rights and obligations under the transaction documents. This document cannot be reproduced except in full, without prior written approval of the Company. Any unauthorized alteration, forgery or falsification of the content or appearance of this document is unlawful and offenders may be prosecuted to the fullest extent of the law.

Radar Type5_Trial19 for 5510MHz

Data Sheet for FCC Radar Type 5						
Trial Number:		19		VSG Frequency(MHz):		5494.737
Number of Bursts in Trial:			11		Successful Detection: Yes	
Burst (8-20)	Number Pulses per Burst (1-3)	Pulse Width (50-100)	Chirp Width (5-20)	Pulse 1-to-2 Spacing	Pulse 2-to-3 Spacing	Starting Location Within Interval
		(μ sec)	(MHz)	(μ sec)	(μ sec)	(μ sec)
1	1	66	9			572486
2	2	67.7	9	1512.3		835382
3	1	61.6	9			11536
4	3	83.7	9	963.3	1336.3	275055
5	3	95.5	9	1832.5	1354.5	538089
6	2	76.8	9	1049.2		803017
7	1	63.9	9			1068197
8	2	66.7	9	1203.3		242891
9	2	78.3	9	998.7		507034
10	2	74.4	9	1755.6		770438
11	1	61.5	9			1035902
12						
13						
14						
15						
16						
17						
18						
19						
20						

Unless otherwise stated the results shown in this test report refer only to the sample(s) tested and such sample(s) are retained for 90 days only.

除非另有說明，此報告結果僅對測試之樣品負責，同時此樣品僅保留90天。本報告未經本公司書面許可，不可部份複製。

This document is issued by the Company subject to its General Conditions of Service printed overleaf, available on request or accessible at <http://www.sgs.com.tw/Terms-and-Conditions> and for electronic format documents, subject to Terms and Conditions for Electronic Documents at <http://www.sgs.com.tw/Terms-and-Conditions>. Attention is drawn to the limitation of liability, indemnification and jurisdiction issues defined therein. Any holder of this document is advised that information contained hereon reflects the Company's findings at the time of its intervention only and within the limits of Client's instructions, if any. The Company's sole responsibility is to its Client and this document does not exonerate parties to a transaction from exercising all their rights and obligations under the transaction documents. This document cannot be reproduced except in full, without prior written approval of the Company. Any unauthorized alteration, forgery or falsification of the content or appearance of this document is unlawful and offenders may be prosecuted to the fullest extent of the law.

SGS Taiwan Ltd.

No.134,Wu Kung Road, New Taipei Industrial Park, Wuku District, New Taipei City, Taiwan/新北市五股區新北產業園區五工路 134 號

台灣檢驗科技股份有限公司

t (886-2) 2299-3279

f (886-2) 2298-0488

www.sgs.com.tw

Member of SGS Group

Radar Type5_Trial20 for 5510MHz

Data Sheet for FCC Radar Type 5						
Trial Number:		20		VSG Frequency(MHz):		5497.537
Number of Bursts in Trial:			17		Successful Detection: Yes	
Burst (8-20)	Number Pulses per Burst (1-3)	Pulse Width (50-100)	Chirp Width (5-20)	Pulse 1-to-2 Spacing	Pulse 2-to-3 Spacing	Starting Location Within Interval
		(μ sec)	(MHz)	(μ sec)	(μ sec)	(μ sec)
1	3	88	16	1256	919	135783
2	3	98	16	1506	1371	305527
3	1	57.4	16			478186
4	2	76.4	16	1773.6		646724
5	1	52.8	16			115148
6	1	51	16			285926
7	1	54.8	16			456935
8	2	79	16	1222		626758
9	3	83.8	16	1125.2	1487.2	93692
10	2	68.5	16	1802.5		264129
11	2	79.9	16	1904.1		434598
12	3	92.9	16	1398.1	1123.1	604219
13	3	97.1	16	1045.9	1166.9	72856
14	2	70.6	16	1757.4		243445
15	2	72	16	1359		413877
16	3	95	16	1255	1652	582964
17	2	69.5	16	1837.5		51895
18						
19						
20						

Unless otherwise stated the results shown in this test report refer only to the sample(s) tested and such sample(s) are retained for 90 days only.

除非另有說明，此報告結果僅對測試之樣品負責，同時此樣品僅保留90天。本報告未經本公司書面許可，不可部份複製。

This document is issued by the Company subject to its General Conditions of Service printed overleaf, available on request or accessible at <http://www.sgs.com.tw/Terms-and-Conditions> and for electronic format documents, subject to Terms and Conditions for Electronic Documents at <http://www.sgs.com.tw/Terms-and-Conditions>. Attention is drawn to the limitation of liability, indemnification and jurisdiction issues defined therein. Any holder of this document is advised that information contained hereon reflects the Company's findings at the time of its intervention only and within the limits of Client's instructions, if any. The Company's sole responsibility is to its Client and this document does not exonerate parties to a transaction from exercising all their rights and obligations under the transaction documents. This document cannot be reproduced except in full, without prior written approval of the Company. Any unauthorized alteration, forgery or falsification of the content or appearance of this document is unlawful and offenders may be prosecuted to the fullest extent of the law.

Radar Type5_Trial21 for 5510MHz

Data Sheet for FCC Radar Type 5						
Trial Number:		21		VSG Frequency(MHz):		5526.463
Number of Bursts in Trial:			9		Successful Detection: Yes	
Burst (8-20)	Number Pulses per Burst (1-3)	Pulse Width (50-100)	Chirp Width (5-20)	Pulse 1-to-2 Spacing	Pulse 2-to-3 Spacing	Starting Location Within Interval
		(μ sec)	(MHz)	(μ sec)	(μ sec)	(μ sec)
1	1	56.7	6			421551
2	1	54.5	6			744478
3	3	98.9	6	1286.1	1719.1	1064529
4	1	53.1	6			58608
5	1	61.9	6			381621
6	3	99.2	6	1156.8	1217.8	703403
7	2	75.4	6	1653.6		1026298
8	2	73.6	6	1185.4		18794
9	1	64	6			341945
10						
11						
12						
13						
14						
15						
16						
17						
18						
19						
20						

Unless otherwise stated the results shown in this test report refer only to the sample(s) tested and such sample(s) are retained for 90 days only.

除非另有說明，此報告結果僅對測試之樣品負責，同時此樣品僅保留90天。本報告未經本公司書面許可，不可部份複製。

This document is issued by the Company subject to its General Conditions of Service printed overleaf, available on request or accessible at <http://www.sgs.com.tw/Terms-and-Conditions> and for electronic format documents, subject to Terms and Conditions for Electronic Documents at <http://www.sgs.com.tw/Terms-and-Conditions>. Attention is drawn to the limitation of liability, indemnification and jurisdiction issues defined therein. Any holder of this document is advised that information contained hereon reflects the Company's findings at the time of its intervention only and within the limits of Client's instructions, if any. The Company's sole responsibility is to its Client and this document does not exonerate parties to a transaction from exercising all their rights and obligations under the transaction documents. This document cannot be reproduced except in full, without prior written approval of the Company. Any unauthorized alteration, forgery or falsification of the content or appearance of this document is unlawful and offenders may be prosecuted to the fullest extent of the law.

Radar Type5_Trial22 for 5510MHz

Data Sheet for FCC Radar Type 5						
Trial Number:		22		VSG Frequency(MHz):		5523.663
Number of Bursts in Trial:			14		Successful Detection: Yes	
Burst (8-20)	Number Pulses per Burst (1-3)	Pulse Width (50-100)	Chirp Width (5-20)	Pulse 1-to-2 Spacing	Pulse 2-to-3 Spacing	Starting Location Within Interval
		(μ sec)	(MHz)	(μ sec)	(μ sec)	(μ sec)
1	3	84.5	13	1021.5	1628.5	425699
2	2	66.8	13	1144.2		633700
3	2	74.3	13	1140.7		840682
4	3	95.7	13	904.3	958.3	193640
5	1	51.9	13			401335
6	3	86.7	13	1253.3	1160.3	607151
7	1	64.9	13			816306
8	1	55.2	13			168523
9	1	60.5	13			376178
10	1	62.1	13			583300
11	1	61.4	13			791044
12	3	97.6	13	1516.4	1265.4	142362
13	2	79.9	13	1880.1		349568
14	3	88.6	13	1675.4	1030.4	556281
15						
16						
17						
18						
19						
20						

Unless otherwise stated the results shown in this test report refer only to the sample(s) tested and such sample(s) are retained for 90 days only.

除非另有說明，此報告結果僅對測試之樣品負責，同時此樣品僅保留90天。本報告未經本公司書面許可，不可部份複製。

This document is issued by the Company subject to its General Conditions of Service printed overleaf, available on request or accessible at <http://www.sgs.com.tw/Terms-and-Conditions> and for electronic format documents, subject to Terms and Conditions for Electronic Documents at <http://www.sgs.com.tw/Terms-and-Conditions>. Attention is drawn to the limitation of liability, indemnification and jurisdiction issues defined therein. Any holder of this document is advised that information contained hereon reflects the Company's findings at the time of its intervention only and within the limits of Client's instructions, if any. The Company's sole responsibility is to its Client and this document does not exonerate parties to a transaction from exercising all their rights and obligations under the transaction documents. This document cannot be reproduced except in full, without prior written approval of the Company. Any unauthorized alteration, forgery or falsification of the content or appearance of this document is unlawful and offenders may be prosecuted to the fullest extent of the law.

SGS Taiwan Ltd.

No.134,Wu Kung Road, New Taipei Industrial Park, Wuku District, New Taipei City, Taiwan/新北市五股區新北產業園區五工路 134 號

台灣檢驗科技股份有限公司

t (886-2) 2299-3279

f (886-2) 2298-0488

www.sgs.com.tw

Member of SGS Group

Radar Type5_Trial23 for 5510MHz

Data Sheet for FCC Radar Type 5						
Trial Number:		23		VSG Frequency(MHz):		5523.263
Number of Bursts in Trial:			15		Successful Detection: Yes	
Burst (8-20)	Number Pulses per Burst (1-3)	Pulse Width (50-100)	Chirp Width (5-20)	Pulse 1-to-2 Spacing	Pulse 2-to-3 Spacing	Starting Location Within Interval
		(μ sec)	(MHz)	(μ sec)	(μ sec)	(μ sec)
1	2	74.8	14	1903.2		712954
2	1	64.4	14			109577
3	2	79.6	14	947.4		302690
4	2	82.1	14	1141.9		496146
5	3	86.2	14	1236.8	989.8	688037
6	2	74.8	14	1243.2		85509
7	1	64.5	14			279236
8	1	63.1	14			472748
9	2	73.5	14	1362.5		665464
10	2	81.8	14	1385.2		61664
11	3	94.4	14	1855.6	961.6	254652
12	1	59.9	14			449055
13	2	73.7	14	1136.3		641555
14	2	75.6	14	1761.4		37890
15	1	58.4	14			231571
16						
17						
18						
19						
20						

Unless otherwise stated the results shown in this test report refer only to the sample(s) tested and such sample(s) are retained for 90 days only.

除非另有說明，此報告結果僅對測試之樣品負責，同時此樣品僅保留90天。本報告未經本公司書面許可，不可部份複製。

This document is issued by the Company subject to its General Conditions of Service printed overleaf, available on request or accessible at <http://www.sgs.com.tw/Terms-and-Conditions> and for electronic format documents, subject to Terms and Conditions for Electronic Documents at <http://www.sgs.com.tw/Terms-and-Conditions>. Attention is drawn to the limitation of liability, indemnification and jurisdiction issues defined therein. Any holder of this document is advised that information contained hereon reflects the Company's findings at the time of its intervention only and within the limits of Client's instructions, if any. The Company's sole responsibility is to its Client and this document does not exonerate parties to a transaction from exercising all their rights and obligations under the transaction documents. This document cannot be reproduced except in full, without prior written approval of the Company. Any unauthorized alteration, forgery or falsification of the content or appearance of this document is unlawful and offenders may be prosecuted to the fullest extent of the law.

SGS Taiwan Ltd.

No.134,Wu Kung Road, New Taipei Industrial Park, Wuku District, New Taipei City, Taiwan/新北市五股區新北產業園區五工路 134 號

台灣檢驗科技股份有限公司

t (886-2) 2299-3279

f (886-2) 2298-0488

www.sgs.com.tw

Member of SGS Group

Radar Type5_Trial24 for 5510MHz

Data Sheet for FCC Radar Type 5						
Trial Number:		24		VSG Frequency(MHz):		5526.463
Number of Bursts in Trial:			9		Successful Detection: Yes	
Burst (8-20)	Number Pulses per Burst (1-3)	Pulse Width (50-100)	Chirp Width (5-20)	Pulse 1-to-2 Spacing	Pulse 2-to-3 Spacing	Starting Location Within Interval
		(μ sec)	(MHz)	(μ sec)	(μ sec)	(μ sec)
1	2	76.1	6	1613.9		708682
2	3	98.8	6	973.2	1563.2	1030464
3	2	82.1	6	1484.9		23490
4	1	52.8	6			346421
5	3	88.9	6	1759.1	1530.1	667789
6	1	66.6	6			992268
7	3	88	6	1717	1899	1311409
8	1	54.6	6			306766
9	3	88.1	6	1901.9	1340.9	628217
10						
11						
12						
13						
14						
15						
16						
17						
18						
19						
20						

Unless otherwise stated the results shown in this test report refer only to the sample(s) tested and such sample(s) are retained for 90 days only.

除非另有說明，此報告結果僅對測試之樣品負責，同時此樣品僅保留90天。本報告未經本公司書面許可，不可部份複製。

This document is issued by the Company subject to its General Conditions of Service printed overleaf, available on request or accessible at <http://www.sgs.com.tw/Terms-and-Conditions> and for electronic format documents, subject to Terms and Conditions for Electronic Documents at <http://www.sgs.com.tw/Terms-and-Conditions>. Attention is drawn to the limitation of liability, indemnification and jurisdiction issues defined therein. Any holder of this document is advised that information contained hereon reflects the Company's findings at the time of its intervention only and within the limits of Client's instructions, if any. The Company's sole responsibility is to its Client and this document does not exonerate parties to a transaction from exercising all their rights and obligations under the transaction documents. This document cannot be reproduced except in full, without prior written approval of the Company. Any unauthorized alteration, forgery or falsification of the content or appearance of this document is unlawful and offenders may be prosecuted to the fullest extent of the law.

SGS Taiwan Ltd.

No.134,Wu Kung Road, New Taipei Industrial Park, Wuku District, New Taipei City, Taiwan/新北市五股區新北產業園區五工路 134 號

台灣檢驗科技股份有限公司

t (886-2) 2299-3279

f (886-2) 2298-0488

www.sgs.com.tw

Member of SGS Group

Radar Type5_Trial25 for 5510MHz

Data Sheet for FCC Radar Type 5						
Trial Number:		25		VSG Frequency(MHz):		5524.863
Number of Bursts in Trial:			12		Successful Detection: Yes	
Burst (8-20)	Number Pulses per Burst (1-3)	Pulse Width (50-100)	Chirp Width (5-20)	Pulse 1-to-2 Spacing	Pulse 2-to-3 Spacing	Starting Location Within Interval
		(μ sec)	(MHz)	(μ sec)	(μ sec)	(μ sec)
1	1	66.5	10			713981
2	3	93.2	10	1318.8	1383.8	954060
3	2	77.9	10	1604.1		199837
4	3	91.9	10	1294.1	1759.1	440713
5	1	60	10			684224
6	1	59.8	10			926991
7	3	83.6	10	1361.4	1524.4	169870
8	2	72	10	1008		411973
9	2	76.9	10	1546.1		653647
10	1	65.9	10			896784
11	2	74	10	1743		140278
12	3	88.8	10	1123.2	978.2	381664
13						
14						
15						
16						
17						
18						
19						
20						

Unless otherwise stated the results shown in this test report refer only to the sample(s) tested and such sample(s) are retained for 90 days only.

除非另有說明，此報告結果僅對測試之樣品負責，同時此樣品僅保留90天。本報告未經本公司書面許可，不可部份複製。

This document is issued by the Company subject to its General Conditions of Service printed overleaf, available on request or accessible at <http://www.sgs.com.tw/Terms-and-Conditions> and for electronic format documents, subject to Terms and Conditions for Electronic Documents at <http://www.sgs.com.tw/Terms-and-Conditions>. Attention is drawn to the limitation of liability, indemnification and jurisdiction issues defined therein. Any holder of this document is advised that information contained hereon reflects the Company's findings at the time of its intervention only and within the limits of Client's instructions, if any. The Company's sole responsibility is to its Client and this document does not exonerate parties to a transaction from exercising all their rights and obligations under the transaction documents. This document cannot be reproduced except in full, without prior written approval of the Company. Any unauthorized alteration, forgery or falsification of the content or appearance of this document is unlawful and offenders may be prosecuted to the fullest extent of the law.

Radar Type5_Trial26 for 5510MHz

Data Sheet for FCC Radar Type 5						
Trial Number:		26		VSG Frequency(MHz):		5523.263
Number of Bursts in Trial:			15		Successful Detection: Yes	
Burst (8-20)	Number Pulses per Burst (1-3)	Pulse Width (50-100)	Chirp Width (5-20)	Pulse 1-to-2 Spacing	Pulse 2-to-3 Spacing	Starting Location Within Interval
		(μ sec)	(MHz)	(μ sec)	(μ sec)	(μ sec)
1	2	82.4	14	1229.6		498536
2	2	67.1	14	1773.9		692019
3	3	89.3	14	1756.7	1617.7	88107
4	3	98.9	14	1600.1	1443.1	281127
5	3	99.5	14	1867.5	1028.5	474098
6	2	71.4	14	1023.6		668574
7	3	93.3	14	1751.7	1007.7	64396
8	3	92.6	14	1705.4	1299.4	257232
9	1	51.2	14			451923
10	3	92	14	1685	1843	642653
11	1	63	14			40796
12	3	89.4	14	1839.6	1564.6	233502
13	3	96.9	14	1282.1	1638.1	426399
14	3	84.5	14	1494.5	1024.5	619777
15	1	63.3	14			16934
16						
17						
18						
19						
20						

Unless otherwise stated the results shown in this test report refer only to the sample(s) tested and such sample(s) are retained for 90 days only.

除非另有說明，此報告結果僅對測試之樣品負責，同時此樣品僅保留90天。本報告未經本公司書面許可，不可部份複製。

This document is issued by the Company subject to its General Conditions of Service printed overleaf, available on request or accessible at <http://www.sgs.com.tw/Terms-and-Conditions> and for electronic format documents, subject to Terms and Conditions for Electronic Documents at <http://www.sgs.com.tw/Terms-and-Conditions>. Attention is drawn to the limitation of liability, indemnification and jurisdiction issues defined therein. Any holder of this document is advised that information contained hereon reflects the Company's findings at the time of its intervention only and within the limits of Client's instructions, if any. The Company's sole responsibility is to its Client and this document does not exonerate parties to a transaction from exercising all their rights and obligations under the transaction documents. This document cannot be reproduced except in full, without prior written approval of the Company. Any unauthorized alteration, forgery or falsification of the content or appearance of this document is unlawful and offenders may be prosecuted to the fullest extent of the law.

SGS Taiwan Ltd. No.134,Wu Kung Road, New Taipei Industrial Park, Wuku District, New Taipei City, Taiwan/新北市五股區新北產業園區五工路 134 號

Radar Type5_Trial27 for 5510MHz

Data Sheet for FCC Radar Type 5						
Trial Number:		27		VSG Frequency(MHz):		5522.463
Number of Bursts in Trial:			17		Successful Detection: Yes	
Burst (8-20)	Number Pulses per Burst (1-3)	Pulse Width (50-100)	Chirp Width (5-20)	Pulse 1-to-2 Spacing	Pulse 2-to-3 Spacing	Starting Location Within Interval
		(μ sec)	(MHz)	(μ sec)	(μ sec)	(μ sec)
1	2	79.4	16	1554.6		185404
2	3	94.8	16	1571.2	1078.2	355243
3	3	91.1	16	1445.9	1467.9	524957
4	2	72	16	1706		696602
5	3	86.8	16	1170.2	1767.2	164009
6	1	59.7	16			335368
7	3	91.5	16	1447.5	1197.5	504553
8	1	65.5	16			677665
9	3	93	16	978	1696	143140
10	3	96.9	16	1185.1	1071.1	313396
11	2	72.6	16	976.4		484806
12	1	53	16			655886
13	1	63.7	16			122700
14	3	98.2	16	939.8	1156.8	292699
15	2	72.4	16	1661.6		463032
16	2	83.1	16	955.9		633961
17	1	57.7	16			101592
18						
19						
20						

Unless otherwise stated the results shown in this test report refer only to the sample(s) tested and such sample(s) are retained for 90 days only.

除非另有說明，此報告結果僅對測試之樣品負責，同時此樣品僅保留90天。本報告未經本公司書面許可，不可部份複製。

This document is issued by the Company subject to its General Conditions of Service printed overleaf, available on request or accessible at <http://www.sgs.com.tw/Terms-and-Conditions> and for electronic format documents, subject to Terms and Conditions for Electronic Documents at <http://www.sgs.com.tw/Terms-and-Conditions>. Attention is drawn to the limitation of liability, indemnification and jurisdiction issues defined therein. Any holder of this document is advised that information contained hereon reflects the Company's findings at the time of its intervention only and within the limits of Client's instructions, if any. The Company's sole responsibility is to its Client and this document does not exonerate parties to a transaction from exercising all their rights and obligations under the transaction documents. This document cannot be reproduced except in full, without prior written approval of the Company. Any unauthorized alteration, forgery or falsification of the content or appearance of this document is unlawful and offenders may be prosecuted to the fullest extent of the law.

Radar Type5_Trial28 for 5510MHz

Data Sheet for FCC Radar Type 5						
Trial Number:		28		VSG Frequency(MHz):		5522.863
Number of Bursts in Trial:			16		Successful Detection: Yes	
Burst (8-20)	Number Pulses per Burst (1-3)	Pulse Width (50-100)	Chirp Width (5-20)	Pulse 1-to-2 Spacing	Pulse 2-to-3 Spacing	Starting Location Within Interval
		(μ sec)	(MHz)	(μ sec)	(μ sec)	(μ sec)
1	1	51.6	15			289349
2	2	69.6	15	1249.4		470024
3	3	93.7	15	1041.3	1150.3	650118
4	2	81.7	15	1884.3		85378
5	3	92.9	15	1015.1	1041.1	266411
6	1	54	15			448486
7	3	89.4	15	1661.6	1625.6	627280
8	3	95.2	15	1199.8	1312.8	63036
9	3	94.8	15	1874.2	1264.2	243526
10	1	62	15			426457
11	3	86.8	15	1765.2	1300.2	605400
12	2	74.6	15	1030.4		40835
13	2	80.2	15	1433.8		221894
14	3	88.6	15	1584.4	1204.4	402325
15	3	95.1	15	1364.9	1513.9	582845
16	2	75.6	15	1550.4		18465
17						
18						
19						
20						

Unless otherwise stated the results shown in this test report refer only to the sample(s) tested and such sample(s) are retained for 90 days only.

除非另有說明，此報告結果僅對測試之樣品負責，同時此樣品僅保留90天。本報告未經本公司書面許可，不可部份複製。

This document is issued by the Company subject to its General Conditions of Service printed overleaf, available on request or accessible at <http://www.sgs.com.tw/Terms-and-Conditions> and for electronic format documents, subject to Terms and Conditions for Electronic Documents at <http://www.sgs.com.tw/Terms-and-Conditions>. Attention is drawn to the limitation of liability, indemnification and jurisdiction issues defined therein. Any holder of this document is advised that information contained hereon reflects the Company's findings at the time of its intervention only and within the limits of Client's instructions, if any. The Company's sole responsibility is to its Client and this document does not exonerate parties to a transaction from exercising all their rights and obligations under the transaction documents. This document cannot be reproduced except in full, without prior written approval of the Company. Any unauthorized alteration, forgery or falsification of the content or appearance of this document is unlawful and offenders may be prosecuted to the fullest extent of the law.

Radar Type5_Trial29 for 5510MHz

Data Sheet for FCC Radar Type 5						
Trial Number:		29		VSG Frequency(MHz):		5524.863
Number of Bursts in Trial:			12		Successful Detection: Yes	
Burst (8-20)	Number Pulses per Burst (1-3)	Pulse Width (50-100)	Chirp Width (5-20)	Pulse 1-to-2 Spacing	Pulse 2-to-3 Spacing	Starting Location Within Interval
		(μ sec)	(MHz)	(μ sec)	(μ sec)	(μ sec)
1	3	96.5	10	1604.5	1082.5	265973
2	1	54.2	10			509016
3	2	77.3	10	1263.7		749934
4	3	85.8	10	1593.2	1151.2	990734
5	3	93.9	10	920.1	1876.1	236405
6	3	87.2	10	999.8	1300.8	477860
7	2	79	10	980		720257
8	3	91	10	977	918	961256
9	1	51.6	10			207126
10	3	96.3	10	1180.7	1203.7	448163
11	1	51.9	10			691269
12	2	76.9	10	1126.1		932778
13						
14						
15						
16						
17						
18						
19						
20						

Unless otherwise stated the results shown in this test report refer only to the sample(s) tested and such sample(s) are retained for 90 days only.

除非另有說明，此報告結果僅對測試之樣品負責，同時此樣品僅保留90天。本報告未經本公司書面許可，不可部份複製。

This document is issued by the Company subject to its General Conditions of Service printed overleaf, available on request or accessible at <http://www.sgs.com.tw/Terms-and-Conditions> and for electronic format documents, subject to Terms and Conditions for Electronic Documents at <http://www.sgs.com.tw/Terms-and-Conditions>. Attention is drawn to the limitation of liability, indemnification and jurisdiction issues defined therein. Any holder of this document is advised that information contained hereon reflects the Company's findings at the time of its intervention only and within the limits of Client's instructions, if any. The Company's sole responsibility is to its Client and this document does not exonerate parties to a transaction from exercising all their rights and obligations under the transaction documents. This document cannot be reproduced except in full, without prior written approval of the Company. Any unauthorized alteration, forgery or falsification of the content or appearance of this document is unlawful and offenders may be prosecuted to the fullest extent of the law.

Radar Type5_Trial30 for 5510MHz

Data Sheet for FCC Radar Type 5						
Trial Number:		30		VSG Frequency(MHz):		5521.263
Number of Bursts in Trial:			19		Successful Detection: Yes	
Burst (8-20)	Number Pulses per Burst (1-3)	Pulse Width (50-100)	Chirp Width (5-20)	Pulse 1-to-2 Spacing	Pulse 2-to-3 Spacing	Starting Location Within Interval
		(μ sec)	(MHz)	(μ sec)	(μ sec)	(μ sec)
1	2	68.3	19	1287.7		111742
2	2	79.5	19	1375.5		263974
3	3	94.4	19	1371.6	1809.6	415412
4	2	78.9	19	1033.1		569750
5	1	58.9	19			93035
6	1	55.2	19			245758
7	3	87.8	19	1741.2	931.2	396617
8	2	77.2	19	1149.8		550426
9	3	90.8	19	1320.2	1427.2	73959
10	2	81.7	19	1204.3		226712
11	3	86.5	19	1320.5	1309.5	378328
12	3	90.7	19	1303.3	1374.3	530663
13	1	51.6	19			55500
14	2	76.9	19	1169.1		207885
15	3	92.1	19	1109.9	1723.9	359389
16	3	97.8	19	1590.2	1052.2	511380
17	1	54.6	19			36611
18	3	91	19	1234	1848	188355
19	1	62.7	19			342053
20						

Unless otherwise stated the results shown in this test report refer only to the sample(s) tested and such sample(s) are retained for 90 days only.

除非另有說明，此報告結果僅對測試之樣品負責，同時此樣品僅保留90天。本報告未經本公司書面許可，不可部份複製。

This document is issued by the Company subject to its General Conditions of Service printed overleaf, available on request or accessible at <http://www.sgs.com.tw/Terms-and-Conditions> and for electronic format documents, subject to Terms and Conditions for Electronic Documents at <http://www.sgs.com.tw/Terms-and-Conditions>. Attention is drawn to the limitation of liability, indemnification and jurisdiction issues defined therein. Any holder of this document is advised that information contained hereon reflects the Company's findings at the time of its intervention only and within the limits of Client's instructions, if any. The Company's sole responsibility is to its Client and this document does not exonerate parties to a transaction from exercising all their rights and obligations under the transaction documents. This document cannot be reproduced except in full, without prior written approval of the Company. Any unauthorized alteration, forgery or falsification of the content or appearance of this document is unlawful and offenders may be prosecuted to the fullest extent of the law.

SGS Taiwan Ltd.

No.134,Wu Kung Road, New Taipei Industrial Park, Wuku District, New Taipei City, Taiwan/新北市五股區新北產業園區五工路 134 號

台灣檢驗科技股份有限公司

t (886-2) 2299-3279

f (886-2) 2298-0488

www.sgs.com.tw

Member of SGS Group

Radar Type6 for 5510MHz

Data Sheet for FCC Radar Type 6

Trial	Pulse Width	PRI	Pulses per Hop	Hopping Rate	Hopping Sequence Length	Successful Detection
	(μ sec)	(μ sec)		(kHz)	(msec)	(Yes/No)
1	1	333	9	0.333	300	Yes
2	1	333	9	0.333	300	Yes
3	1	333	9	0.333	300	Yes
4	1	333	9	0.333	300	Yes
5	1	333	9	0.333	300	Yes
6	1	333	9	0.333	300	Yes
7	1	333	9	0.333	300	Yes
8	1	333	9	0.333	300	Yes
9	1	333	9	0.333	300	Yes
10	1	333	9	0.333	300	Yes
11	1	333	9	0.333	300	Yes
12	1	333	9	0.333	300	Yes
13	1	333	9	0.333	300	Yes
14	1	333	9	0.333	300	Yes
15	1	333	9	0.333	300	Yes
16	1	333	9	0.333	300	Yes
17	1	333	9	0.333	300	Yes
18	1	333	9	0.333	300	Yes
19	1	333	9	0.333	300	Yes
20	1	333	9	0.333	300	Yes
21	1	333	9	0.333	300	Yes
22	1	333	9	0.333	300	Yes
23	1	333	9	0.333	300	Yes
24	1	333	9	0.333	300	Yes
25	1	333	9	0.333	300	Yes
26	1	333	9	0.333	300	Yes
27	1	333	9	0.333	300	Yes
28	1	333	9	0.333	300	Yes
29	1	333	9	0.333	300	Yes
30	1	333	9	0.333	300	Yes

Unless otherwise stated the results shown in this test report refer only to the sample(s) tested and such sample(s) are retained for 90 days only.

除非另有說明，此報告結果僅對測試之樣品負責，同時此樣品僅保留90天。本報告未經本公司書面許可，不可部份複製。

This document is issued by the Company subject to its General Conditions of Service printed overleaf, available on request or accessible at <http://www.sgs.com.tw/Terms-and-Conditions> and for electronic format documents, subject to Terms and Conditions for Electronic Documents at <http://www.sgs.com.tw/Terms-and-Conditions>. Attention is drawn to the limitation of liability, indemnification and jurisdiction issues defined therein. Any holder of this document is advised that information contained hereon reflects the Company's findings at the time of its intervention only and within the limits of Client's instructions, if any. The Company's sole responsibility is to its Client and this document does not exonerate parties to a transaction from exercising all their rights and obligations under the transaction documents. This document cannot be reproduced except in full, without prior written approval of the Company. Any unauthorized alteration, forgery or falsification of the content or appearance of this document is unlawful and offenders may be prosecuted to the fullest extent of the law.

HE80_5290MHz

Short Pulse Radar Type	Minimum Number of Trials	Detection(%)		Minmum Percentage of Successful Detection(%)	Pass/Fail
1	30	100		60	Pass
2	30	100		60	Pass
3	30	100		60	Pass
4	30	96.67		60	Pass
Aggregate (Radar Types 1-4)	120	99.1675		80	Pass
Long Pulse Radar Type	Minimum Number of Trials	Each Detection(%)	Total Detection(%)	Minmum Percentage of Successful Detection(%)	Pass/Fail
5	Center:10	100	100	80	Pass
	Low Edge:10	100			
	High Edge:10	100			
Frequency Hopping Radar Type	Minimum Number of Trials	Detection(%)		Minmum Percentage of Successful Detection(%)	Pass/Fail
6	30	96.66666667		70	Pass

Unless otherwise stated the results shown in this test report refer only to the sample(s) tested and such sample(s) are retained for 90 days only.

除非另有說明，此報告結果僅對測試之樣品負責，同時此樣品僅保留90天。本報告未經本公司書面許可，不可部份複製。

This document is issued by the Company subject to its General Conditions of Service printed overleaf, available on request or accessible at <http://www.sgs.com.tw/Terms-and-Conditions> and for electronic format documents, subject to Terms and Conditions for Electronic Documents at <http://www.sgs.com.tw/Terms-and-Conditions>. Attention is drawn to the limitation of liability, indemnification and jurisdiction issues defined therein. Any holder of this document is advised that information contained hereon reflects the Company's findings at the time of its intervention only and within the limits of Client's instructions, if any. The Company's sole responsibility is to its Client and this document does not exonerate parties to a transaction from exercising all their rights and obligations under the transaction documents. This document cannot be reproduced except in full, without prior written approval of the Company. Any unauthorized alteration, forgery or falsification of the content or appearance of this document is unlawful and offenders may be prosecuted to the fullest extent of the law.

Radar Type1 for 5290MHz

Data Sheet for FCC Radar Type 1

Trial	VSG Frequency (MHz)	Pulse Repetition Frequency Number (1 to 23)	Pulse Repetition Frequency	PRI (msec)	Test A/B	Successful Detection (Yes/No)
			(Pulses Per Second)			
1	5290	13	1319.3	758	A	Yes
2	5290	21	1089.3	918	A	Yes
3	5290	8	1519.8	658	A	Yes
4	5290	19	1139	878	A	Yes
5	5290	18	1165.5	858	A	Yes
6	5290	11	1392.8	718	A	Yes
7	5290	6	1618.1	618	A	Yes
8	5290	10	1432.7	698	A	Yes
9	5290	16	1222.5	818	A	Yes
10	5290	17	1193.3	838	A	Yes
11	5290	23	326.2	3066	A	Yes
12	5290	9	1474.9	678	A	Yes
13	5290	4	1730.1	578	A	Yes
14	5290	5	1672.2	598	A	Yes
15	5290	1	1930.5	518	A	Yes
16	5290	-	533.6	1874	B	Yes
17	5290	-	471.7	2120	B	Yes
18	5290	-	342.2	2922	B	Yes
19	5290	-	993	1007	B	Yes
20	5290	-	1257.9	795	B	Yes
21	5290	-	742.9	1346	B	Yes
22	5290	-	814.3	1228	B	Yes
23	5290	-	403.1	2481	B	Yes
24	5290	-	700.8	1427	B	Yes
25	5290	-	1831.5	546	B	Yes
26	5290	-	1251.6	799	B	Yes
27	5290	-	483.6	2068	B	Yes
28	5290	-	970.9	1030	B	Yes
29	5290	-	449.6	2224	B	Yes
30	5290	-	687.8	1454	B	Yes

Unless otherwise stated the results shown in this test report refer only to the sample(s) tested and such sample(s) are retained for 90 days only.

除非另有說明，此報告結果僅對測試之樣品負責，同時此樣品僅保留90天。本報告未經本公司書面許可，不可部份複製。

This document is issued by the Company subject to its General Conditions of Service printed overleaf, available on request or accessible at <http://www.sgs.com.tw/Terms-and-Conditions> and for electronic format documents, subject to Terms and Conditions for Electronic Documents at <http://www.sgs.com.tw/Terms-and-Conditions>. Attention is drawn to the limitation of liability, indemnification and jurisdiction issues defined therein. Any holder of this document is advised that information contained hereon reflects the Company's findings at the time of its intervention only and within the limits of Client's instructions, if any. The Company's sole responsibility is to its Client and this document does not exonerate parties to a transaction from exercising all their rights and obligations under the transaction documents. This document cannot be reproduced except in full, without prior written approval of the Company. Any unauthorized alteration, forgery or falsification of the content or appearance of this document is unlawful and offenders may be prosecuted to the fullest extent of the law.

SGS Taiwan Ltd.

No.134,Wu Kung Road, New Taipei Industrial Park, Wuku District, New Taipei City, Taiwan/新北市五股區新北產業園區五工路 134 號

台灣檢驗科技股份有限公司

t (886-2) 2299-3279

f (886-2) 2298-0488

www.sgs.com.tw

Member of SGS Group

Radar Type2 for 5290MHz

Data Sheet for FCC Radar Type 2

Trial	VSG Frequency (MHz)	Number Pulses per Burst (23-29)	Pulse Width (1-5)	PRI (150-230)	Successful Detection
			(μ s)	(μ s)	(Yes/No)
1	5290	29	4.9	195	Yes
2	5290	28	4.1	153	Yes
3	5290	26	3.2	151	Yes
4	5290	23	1.2	227	Yes
5	5290	23	1.1	179	Yes
6	5290	26	2.9	166	Yes
7	5290	26	2.7	174	Yes
8	5290	24	2.1	230	Yes
9	5290	24	1.9	180	Yes
10	5290	29	4.8	223	Yes
11	5290	26	3.2	193	Yes
12	5290	24	1.9	155	Yes
13	5290	28	4	187	Yes
14	5290	29	5	206	Yes
15	5290	27	3.6	220	Yes
16	5290	29	4.7	175	Yes
17	5290	24	1.7	204	Yes
18	5290	26	3.1	181	Yes
19	5290	25	2.2	228	Yes
20	5290	28	4	182	Yes
21	5290	23	1.4	198	Yes
22	5290	26	3	199	Yes
23	5290	27	3.3	152	Yes
24	5290	23	1.3	178	Yes
25	5290	25	2.2	207	Yes
26	5290	27	3.4	159	Yes
27	5290	28	3.9	225	Yes
28	5290	27	3.6	168	Yes
29	5290	25	2.3	177	Yes
30	5290	29	4.7	205	Yes

Unless otherwise stated the results shown in this test report refer only to the sample(s) tested and such sample(s) are retained for 90 days only.

除非另有說明，此報告結果僅對測試之樣品負責，同時此樣品僅保留90天。本報告未經本公司書面許可，不可部份複製。

This document is issued by the Company subject to its General Conditions of Service printed overleaf, available on request or accessible at <http://www.sgs.com.tw/Terms-and-Conditions> and for electronic format documents, subject to Terms and Conditions for Electronic Documents at <http://www.sgs.com.tw/Terms-and-Conditions>. Attention is drawn to the limitation of liability, indemnification and jurisdiction issues defined therein. Any holder of this document is advised that information contained hereon reflects the Company's findings at the time of its intervention only and within the limits of Client's instructions, if any. The Company's sole responsibility is to its Client and this document does not exonerate parties to a transaction from exercising all their rights and obligations under the transaction documents. This document cannot be reproduced except in full, without prior written approval of the Company. Any unauthorized alteration, forgery or falsification of the content or appearance of this document is unlawful and offenders may be prosecuted to the fullest extent of the law.

Radar Type3 for 5290MHz

Data Sheet for FCC Radar Type 3

Trial	VSG Frequency (MHz)	Number Pulses per Burst (16-18)	Pulse Width (6-10)	PRI (200-500)	Successful Detection
			(μ s)	(μ s)	(Yes/No)
1	5290	18	9.9	442	Yes
2	5290	18	9.1	499	Yes
3	5290	17	8.2	273	Yes
4	5290	16	6.2	338	Yes
5	5290	16	6.1	487	Yes
6	5290	17	7.9	420	Yes
7	5290	17	7.7	450	Yes
8	5290	16	7.1	339	Yes
9	5290	16	6.9	405	Yes
10	5290	18	9.8	223	Yes
11	5290	17	8.2	453	Yes
12	5290	16	6.9	417	Yes
13	5290	18	9	400	Yes
14	5290	18	10	498	Yes
15	5290	17	8.6	274	Yes
16	5290	18	9.7	431	Yes
17	5290	16	6.7	294	Yes
18	5290	17	8.1	203	Yes
19	5290	16	7.2	298	Yes
20	5290	18	9	473	Yes
21	5290	16	6.4	407	Yes
22	5290	17	8	258	Yes
23	5290	17	8.3	249	Yes
24	5290	16	6.3	446	Yes
25	5290	16	7.2	486	Yes
26	5290	17	8.4	480	Yes
27	5290	18	8.9	370	Yes
28	5290	17	8.6	348	Yes
29	5290	16	7.3	401	Yes
30	5290	18	9.7	264	Yes

Unless otherwise stated the results shown in this test report refer only to the sample(s) tested and such sample(s) are retained for 90 days only.

除非另有說明，此報告結果僅對測試之樣品負責，同時此樣品僅保留90天。本報告未經本公司書面許可，不可部份複製。

This document is issued by the Company subject to its General Conditions of Service printed overleaf, available on request or accessible at <http://www.sgs.com.tw/Terms-and-Conditions> and for electronic format documents, subject to Terms and Conditions for Electronic Documents at <http://www.sgs.com.tw/Terms-and-Conditions>. Attention is drawn to the limitation of liability, indemnification and jurisdiction issues defined therein. Any holder of this document is advised that information contained hereon reflects the Company's findings at the time of its intervention only and within the limits of Client's instructions, if any. The Company's sole responsibility is to its Client and this document does not exonerate parties to a transaction from exercising all their rights and obligations under the transaction documents. This document cannot be reproduced except in full, without prior written approval of the Company. Any unauthorized alteration, forgery or falsification of the content or appearance of this document is unlawful and offenders may be prosecuted to the fullest extent of the law.

Radar Type4 for 5290MHz

Data Sheet for FCC Radar Type 4

Trial	VSG Frequency (MHz)	Number Pulses per Burst (12-16)	Pulse Width (11-20)	PRI (200-500)	Successful Detection
			(μ s)	(μ s)	(Yes/No)
1	5290	16	19.6	442	Yes
2	5290	15	17.8	499	Yes
3	5290	14	15.8	273	Yes
4	5290	12	11.4	338	Yes
5	5290	12	11.3	487	Yes
6	5290	14	15.3	420	Yes
7	5290	14	14.9	450	Yes
8	5290	13	13.5	339	Yes
9	5290	13	13.1	405	Yes
10	5290	16	19.5	223	Yes
11	5290	14	16	453	Yes
12	5290	13	13	417	Yes
13	5290	15	17.8	400	Yes
14	5290	16	20	498	Yes
15	5290	15	16.9	274	Yes
16	5290	16	19.2	431	Yes
17	5290	12	12.6	294	Yes
18	5290	14	15.6	203	Yes
19	5290	13	13.6	298	Yes
20	5290	15	17.6	473	Yes
21	5290	12	12.1	407	Yes
22	5290	14	15.5	258	Yes
23	5290	14	16.2	249	Yes
24	5290	12	11.7	446	No
25	5290	13	13.8	486	Yes
26	5290	15	16.5	480	Yes
27	5290	15	17.5	370	Yes
28	5290	15	16.8	348	Yes
29	5290	13	13.9	401	Yes
30	5290	16	19.3	264	Yes

Unless otherwise stated the results shown in this test report refer only to the sample(s) tested and such sample(s) are retained for 90 days only.

除非另有說明，此報告結果僅對測試之樣品負責，同時此樣品僅保留90天。本報告未經本公司書面許可，不可部份複製。

This document is issued by the Company subject to its General Conditions of Service printed overleaf, available on request or accessible at <http://www.sgs.com.tw/Terms-and-Conditions> and for electronic format documents, subject to Terms and Conditions for Electronic Documents at <http://www.sgs.com.tw/Terms-and-Conditions>. Attention is drawn to the limitation of liability, indemnification and jurisdiction issues defined therein. Any holder of this document is advised that information contained hereon reflects the Company's findings at the time of its intervention only and within the limits of Client's instructions, if any. The Company's sole responsibility is to its Client and this document does not exonerate parties to a transaction from exercising all their rights and obligations under the transaction documents. This document cannot be reproduced except in full, without prior written approval of the Company. Any unauthorized alteration, forgery or falsification of the content or appearance of this document is unlawful and offenders may be prosecuted to the fullest extent of the law.

Radar Type5_Trial1 for 5290MHz

Data Sheet for FCC Radar Type 5						
Trial Number:			1	VSG Frequency(MHz):		5290
Number of Bursts in Trial:			20	Successful Detection:		Yes
Burst (8-20)	Number Pulses per Burst (1-3)	Pulse Width (50-100)	Chirp Width (5-20)	Pulse 1-to-2 Spacing	Pulse 2-to-3 Spacing	Starting Location Within Interval
		(μ sec)	(MHz)	(μ sec)	(μ sec)	(μ sec)
1	3	97.7	20	1034.3	1421.3	116141
2	3	87.9	20	1634.1	1463.1	260383
3	2	76.9	20	929.1		406435
4	1	52.4	20			552540
5	1	51.8	20			98818
6	2	74	20	1785		243337
7	2	71.7	20	1586.3		388146
8	1	64	20			534217
9	1	61.5	20			80882
10	3	97.3	20	912.7	1544.7	224944
11	2	77.7	20	1096.3		370763
12	1	61.1	20			516312
13	3	87.5	20	1260.5	1441.5	62728
14	3	99.7	20	1776.3	1284.3	207224
15	2	82.7	20	1140.3		352481
16	3	95.2	20	1213.8	1162.8	495985
17	1	59.1	20			45158
18	2	75.6	20	1041.4		189991
19	1	64.7	20			335648
20	3	86.8	20	918.2	1652.2	478439

Unless otherwise stated the results shown in this test report refer only to the sample(s) tested and such sample(s) are retained for 90 days only.

除非另有說明，此報告結果僅對測試之樣品負責，同時此樣品僅保留90天。本報告未經本公司書面許可，不可部份複製。

This document is issued by the Company subject to its General Conditions of Service printed overleaf, available on request or accessible at <http://www.sgs.com.tw/Terms-and-Conditions> and for electronic format documents, subject to Terms and Conditions for Electronic Documents at <http://www.sgs.com.tw/Terms-and-Conditions>. Attention is drawn to the limitation of liability, indemnification and jurisdiction issues defined therein. Any holder of this document is advised that information contained hereon reflects the Company's findings at the time of its intervention only and within the limits of Client's instructions, if any. The Company's sole responsibility is to its Client and this document does not exonerate parties to a transaction from exercising all their rights and obligations under the transaction documents. This document cannot be reproduced except in full, without prior written approval of the Company. Any unauthorized alteration, forgery or falsification of the content or appearance of this document is unlawful and offenders may be prosecuted to the fullest extent of the law.

Radar Type5_Trial2 for 5290MHz

Data Sheet for FCC Radar Type 5						
Trial Number:		2		VSG Frequency(MHz):		5290
Number of Bursts in Trial:			17		Successful Detection: Yes	
Burst (8-20)	Number Pulses per Burst (1-3)	Pulse Width (50-100)	Chirp Width (5-20)	Pulse 1-to-2 Spacing	Pulse 2-to-3 Spacing	Starting Location Within Interval
		(μ sec)	(MHz)	(μ sec)	(μ sec)	(μ sec)
1	1	56	17			32097
2	2	75.2	17	1446.8		202501
3	2	79.1	17	1594.9		372874
4	1	54.1	17			544886
5	1	65.8	17			11064
6	2	80.4	17	1102.6		181560
7	3	86	17	1685	1290	351173
8	2	82.4	17	1445.6		522390
9	1	66.3	17			694725
10	3	95.8	17	970.2	1319.2	160367
11	3	85.6	17	1831.4	1791.4	329885
12	1	51	17			502809
13	1	64.7	17			673232
14	3	90.6	17	1053.4	1866.4	139129
15	1	53.4	17			310563
16	3	96.2	17	1065.8	1773.8	479259
17	1	65.5	17			652703
18						
19						
20						

Unless otherwise stated the results shown in this test report refer only to the sample(s) tested and such sample(s) are retained for 90 days only.

除非另有說明，此報告結果僅對測試之樣品負責，同時此樣品僅保留90天。本報告未經本公司書面許可，不可部份複製。

This document is issued by the Company subject to its General Conditions of Service printed overleaf, available on request or accessible at <http://www.sgs.com.tw/Terms-and-Conditions> and for electronic format documents, subject to Terms and Conditions for Electronic Documents at <http://www.sgs.com.tw/Terms-and-Conditions>. Attention is drawn to the limitation of liability, indemnification and jurisdiction issues defined therein. Any holder of this document is advised that information contained hereon reflects the Company's findings at the time of its intervention only and within the limits of Client's instructions, if any. The Company's sole responsibility is to its Client and this document does not exonerate parties to a transaction from exercising all their rights and obligations under the transaction documents. This document cannot be reproduced except in full, without prior written approval of the Company. Any unauthorized alteration, forgery or falsification of the content or appearance of this document is unlawful and offenders may be prosecuted to the fullest extent of the law.

Radar Type5_Trial3 for 5290MHz

Data Sheet for FCC Radar Type 5						
Trial Number:			3	VSG Frequency(MHz):		5290
Number of Bursts in Trial:			14	Successful Detection:		Yes
Burst (8-20)	Number Pulses per Burst (1-3)	Pulse Width (50-100)	Chirp Width (5-20)	Pulse 1-to-2 Spacing	Pulse 2-to-3 Spacing	Starting Location Within Interval
		(μ sec)	(MHz)	(μ sec)	(μ sec)	(μ sec)
1	2	75.2	13	1361.8		143969
2	3	90.7	13	1099.3	988.3	350947
3	3	93.8	13	1045.2	1043.2	557505
4	1	60.8	13			766524
5	3	98.2	13	1508.8	1876.8	118256
6	3	88.5	13	959.5	1339.5	325401
7	3	90.5	13	1857.5	1691.5	531589
8	2	74.6	13	957.4		740731
9	2	74.5	13	1040.5		92978
10	1	53.5	13			300652
11	3	89.7	13	1803.3	1110.3	506183
12	2	80.9	13	1738.1		714128
13	1	51.5	13			67556
14	2	80.4	13	1193.6		274857
15						
16						
17						
18						
19						
20						

Unless otherwise stated the results shown in this test report refer only to the sample(s) tested and such sample(s) are retained for 90 days only.

除非另有說明，此報告結果僅對測試之樣品負責，同時此樣品僅保留90天。本報告未經本公司書面許可，不可部份複製。

This document is issued by the Company subject to its General Conditions of Service printed overleaf, available on request or accessible at <http://www.sgs.com.tw/Terms-and-Conditions> and for electronic format documents, subject to Terms and Conditions for Electronic Documents at <http://www.sgs.com.tw/Terms-and-Conditions>. Attention is drawn to the limitation of liability, indemnification and jurisdiction issues defined therein. Any holder of this document is advised that information contained hereon reflects the Company's findings at the time of its intervention only and within the limits of Client's instructions, if any. The Company's sole responsibility is to its Client and this document does not exonerate parties to a transaction from exercising all their rights and obligations under the transaction documents. This document cannot be reproduced except in full, without prior written approval of the Company. Any unauthorized alteration, forgery or falsification of the content or appearance of this document is unlawful and offenders may be prosecuted to the fullest extent of the law.

SGS Taiwan Ltd.

No.134,Wu Kung Road, New Taipei Industrial Park, Wuku District, New Taipei City, Taiwan/新北市五股區新北產業園區五工路 134 號

台灣檢驗科技股份有限公司

t (886-2) 2299-3279

f (886-2) 2298-0488

www.sgs.com.tw

Member of SGS Group

Radar Type5_Trial4 for 5290MHz

Data Sheet for FCC Radar Type 5						
Trial Number:			4	VSG Frequency(MHz):		5290
Number of Bursts in Trial:			8	Successful Detection:		Yes
Burst (8-20)	Number Pulses per Burst (1-3)	Pulse Width (50-100)	Chirp Width (5-20)	Pulse 1-to-2 Spacing	Pulse 2-to-3 Spacing	Starting Location Within Interval
		(μ sec)	(MHz)	(μ sec)	(μ sec)	(μ sec)
1	1	59.8	5			845339
2	1	65.7	5			1208624
3	2	70.7	5	1208.3		73525
4	2	72.4	5	1543.6		436604
5	2	72.4	5	961.6		800038
6	1	58.8	5			1164144
7	2	72.8	5	1723.2		28791
8	3	86.7	5	1407.3	1824.3	391341
9						
10						
11						
12						
13						
14						
15						
16						
17						
18						
19						
20						

Unless otherwise stated the results shown in this test report refer only to the sample(s) tested and such sample(s) are retained for 90 days only.

除非另有說明，此報告結果僅對測試之樣品負責，同時此樣品僅保留90天。本報告未經本公司書面許可，不可部份複製。

This document is issued by the Company subject to its General Conditions of Service printed overleaf, available on request or accessible at <http://www.sgs.com.tw/Terms-and-Conditions> and for electronic format documents, subject to Terms and Conditions for Electronic Documents at <http://www.sgs.com.tw/Terms-and-Conditions>. Attention is drawn to the limitation of liability, indemnification and jurisdiction issues defined therein. Any holder of this document is advised that information contained hereon reflects the Company's findings at the time of its intervention only and within the limits of Client's instructions, if any. The Company's sole responsibility is to its Client and this document does not exonerate parties to a transaction from exercising all their rights and obligations under the transaction documents. This document cannot be reproduced except in full, without prior written approval of the Company. Any unauthorized alteration, forgery or falsification of the content or appearance of this document is unlawful and offenders may be prosecuted to the fullest extent of the law.

Radar Type5_Trial5 for 5290MHz

Data Sheet for FCC Radar Type 5						
Trial Number:			5	VSG Frequency(MHz):		5290
Number of Bursts in Trial:			8	Successful Detection:		Yes
Burst (8-20)	Number Pulses per Burst (1-3)	Pulse Width (50-100)	Chirp Width (5-20)	Pulse 1-to-2 Spacing	Pulse 2-to-3 Spacing	Starting Location Within Interval
		(μ sec)	(MHz)	(μ sec)	(μ sec)	(μ sec)
1	2	71.5	5	1024.5		755079
2	3	88	5	1905	1547	1116130
3	3	89.4	5	1595.6	1232.6	1479179
4	3	97.7	5	1549.3	1090.3	346877
5	1	65.8	5			710997
6	1	61.7	5			1074422
7	2	76.6	5	1387.4		1436084
8	3	96.5	5	1571.5	925.5	302135
9						
10						
11						
12						
13						
14						
15						
16						
17						
18						
19						
20						

Unless otherwise stated the results shown in this test report refer only to the sample(s) tested and such sample(s) are retained for 90 days only.

除非另有說明，此報告結果僅對測試之樣品負責，同時此樣品僅保留90天。本報告未經本公司書面許可，不可部份複製。

This document is issued by the Company subject to its General Conditions of Service printed overleaf, available on request or accessible at <http://www.sgs.com.tw/Terms-and-Conditions> and for electronic format documents, subject to Terms and Conditions for Electronic Documents at <http://www.sgs.com.tw/Terms-and-Conditions>. Attention is drawn to the limitation of liability, indemnification and jurisdiction issues defined therein. Any holder of this document is advised that information contained hereon reflects the Company's findings at the time of its intervention only and within the limits of Client's instructions, if any. The Company's sole responsibility is to its Client and this document does not exonerate parties to a transaction from exercising all their rights and obligations under the transaction documents. This document cannot be reproduced except in full, without prior written approval of the Company. Any unauthorized alteration, forgery or falsification of the content or appearance of this document is unlawful and offenders may be prosecuted to the fullest extent of the law.

SGS Taiwan Ltd.

No.134,Wu Kung Road, New Taipei Industrial Park, Wuku District, New Taipei City, Taiwan/新北市五股區新北產業園區五工路 134 號

台灣檢驗科技股份有限公司

t (886-2) 2299-3279

f (886-2) 2298-0488

www.sgs.com.tw

Member of SGS Group

Radar Type5_Trial6 for 5290MHz

Data Sheet for FCC Radar Type 5						
Trial Number:		6		VSG Frequency(MHz):		5290
Number of Bursts in Trial:			14		Successful Detection: Yes	
Burst (8-20)	Number Pulses per Burst (1-3)	Pulse Width (50-100)	Chirp Width (5-20)	Pulse 1-to-2 Spacing	Pulse 2-to-3 Spacing	Starting Location Within Interval
		(μ sec)	(MHz)	(μ sec)	(μ sec)	(μ sec)
1	3	97	12	1506	1903	378573
2	3	96.3	12	926.7	1064.7	586348
3	3	86.5	12	1416.5	964.5	793292
4	2	79.6	12	1505.4		146992
5	3	84	12	1459	1858	353209
6	3	85	12	1028	1539	560501
7	2	71	12	1692		767848
8	2	76	12	1081		121542
9	1	57.9	12			329085
10	3	86.7	12	1679.3	1245.3	535068
11	3	88.6	12	1154.4	1637.4	741864
12	2	79.5	12	1696.5		95986
13	3	91.3	12	1797.7	1841.7	302190
14	2	76.8	12	1755.2		510022
15						
16						
17						
18						
19						
20						

Unless otherwise stated the results shown in this test report refer only to the sample(s) tested and such sample(s) are retained for 90 days only.

除非另有說明，此報告結果僅對測試之樣品負責，同時此樣品僅保留90天。本報告未經本公司書面許可，不可部份複製。

This document is issued by the Company subject to its General Conditions of Service printed overleaf, available on request or accessible at <http://www.sgs.com.tw/Terms-and-Conditions> and for electronic format documents, subject to Terms and Conditions for Electronic Documents at <http://www.sgs.com.tw/Terms-and-Conditions>. Attention is drawn to the limitation of liability, indemnification and jurisdiction issues defined therein. Any holder of this document is advised that information contained hereon reflects the Company's findings at the time of its intervention only and within the limits of Client's instructions, if any. The Company's sole responsibility is to its Client and this document does not exonerate parties to a transaction from exercising all their rights and obligations under the transaction documents. This document cannot be reproduced except in full, without prior written approval of the Company. Any unauthorized alteration, forgery or falsification of the content or appearance of this document is unlawful and offenders may be prosecuted to the fullest extent of the law.

Radar Type5_Trial7 for 5290MHz

Data Sheet for FCC Radar Type 5						
Trial Number:			7	VSG Frequency(MHz):		5290
Number of Bursts in Trial:			13	Successful Detection:		Yes
Burst (8-20)	Number Pulses per Burst (1-3)	Pulse Width (50-100)	Chirp Width (5-20)	Pulse 1-to-2 Spacing	Pulse 2-to-3 Spacing	Starting Location Within Interval
		(μ sec)	(MHz)	(μ sec)	(μ sec)	(μ sec)
1	3	96.4	11	1752.6	1109.6	771194
2	1	51.4	11			76092
3	1	64.8	11			299489
4	1	65.3	11			522832
5	2	75.7	11	1670.3		745337
6	3	85.4	11	1250.6	979.6	48408
7	3	94	11	1772	1352	270970
8	2	68.1	11	1265.9		494746
9	2	81	11	1161		717983
10	3	87.4	11	1328.6	1906.6	20904
11	3	92.8	11	1267.2	1676.2	243688
12	3	88.6	11	1875.4	1638.4	465906
13	2	69.2	11	1282.8		690603
14						
15						
16						
17						
18						
19						
20						

Unless otherwise stated the results shown in this test report refer only to the sample(s) tested and such sample(s) are retained for 90 days only.

除非另有說明，此報告結果僅對測試之樣品負責，同時此樣品僅保留90天。本報告未經本公司書面許可，不可部份複製。

This document is issued by the Company subject to its General Conditions of Service printed overleaf, available on request or accessible at <http://www.sgs.com.tw/Terms-and-Conditions> and for electronic format documents, subject to Terms and Conditions for Electronic Documents at <http://www.sgs.com.tw/Terms-and-Conditions>. Attention is drawn to the limitation of liability, indemnification and jurisdiction issues defined therein. Any holder of this document is advised that information contained hereon reflects the Company's findings at the time of its intervention only and within the limits of Client's instructions, if any. The Company's sole responsibility is to its Client and this document does not exonerate parties to a transaction from exercising all their rights and obligations under the transaction documents. This document cannot be reproduced except in full, without prior written approval of the Company. Any unauthorized alteration, forgery or falsification of the content or appearance of this document is unlawful and offenders may be prosecuted to the fullest extent of the law.

Radar Type5_Trial8 for 5290MHz

Data Sheet for FCC Radar Type 5						
Trial Number:		8		VSG Frequency(MHz):		5290
Number of Bursts in Trial:			11		Successful Detection: Yes	
Burst (8-20)	Number Pulses per Burst (1-3)	Pulse Width (50-100)	Chirp Width (5-20)	Pulse 1-to-2 Spacing	Pulse 2-to-3 Spacing	Starting Location Within Interval
		(μ sec)	(MHz)	(μ sec)	(μ sec)	(μ sec)
1	1	55.7	9			1081971
2	2	71.5	9	1428.5		256209
3	1	50.4	9			520922
4	2	72.7	9	1676.3		783872
5	2	78.8	9	1564.2		1047535
6	3	98	9	1686	1848	223101
7	2	78.1	9	1319.9		487378
8	1	56.6	9			752190
9	3	93.4	9	1339.6	1120.6	1013747
10	3	94.4	9	1471.6	1168.6	190967
11	2	71.9	9	1853.1		454777
12						
13						
14						
15						
16						
17						
18						
19						
20						

Unless otherwise stated the results shown in this test report refer only to the sample(s) tested and such sample(s) are retained for 90 days only.

除非另有說明，此報告結果僅對測試之樣品負責，同時此樣品僅保留90天。本報告未經本公司書面許可，不可部份複製。

This document is issued by the Company subject to its General Conditions of Service printed overleaf, available on request or accessible at <http://www.sgs.com.tw/Terms-and-Conditions> and for electronic format documents, subject to Terms and Conditions for Electronic Documents at <http://www.sgs.com.tw/Terms-and-Conditions>. Attention is drawn to the limitation of liability, indemnification and jurisdiction issues defined therein. Any holder of this document is advised that information contained hereon reflects the Company's findings at the time of its intervention only and within the limits of Client's instructions, if any. The Company's sole responsibility is to its Client and this document does not exonerate parties to a transaction from exercising all their rights and obligations under the transaction documents. This document cannot be reproduced except in full, without prior written approval of the Company. Any unauthorized alteration, forgery or falsification of the content or appearance of this document is unlawful and offenders may be prosecuted to the fullest extent of the law.

Radar Type5_Trial9 for 5290MHz

Data Sheet for FCC Radar Type 5						
Trial Number:			9	VSG Frequency(MHz):		5290
Number of Bursts in Trial:			11	Successful Detection:		Yes
Burst (8-20)	Number Pulses per Burst (1-3)	Pulse Width (50-100)	Chirp Width (5-20)	Pulse 1-to-2 Spacing	Pulse 2-to-3 Spacing	Starting Location Within Interval
		(μ sec)	(MHz)	(μ sec)	(μ sec)	(μ sec)
1	3	96.5	8	1238.5	1767.5	717802
2	2	74.9	8	1820.1		982334
3	3	94.7	8	1012.3	1446.3	158509
4	3	94.8	8	1520.2	1653.2	421684
5	1	64.4	8			687423
6	3	85.8	8	960.2	1385.2	949648
7	2	70.2	8	1167.8		126134
8	3	93.3	8	943.7	1289.7	389725
9	3	95.4	8	1101.6	1896.6	652936
10	3	94.7	8	1841.3	1060.3	916384
11	3	91.7	8	1816.3	1181.3	93458
12						
13						
14						
15						
16						
17						
18						
19						
20						

Unless otherwise stated the results shown in this test report refer only to the sample(s) tested and such sample(s) are retained for 90 days only.

除非另有說明，此報告結果僅對測試之樣品負責，同時此樣品僅保留90天。本報告未經本公司書面許可，不可部份複製。

This document is issued by the Company subject to its General Conditions of Service printed overleaf, available on request or accessible at <http://www.sgs.com.tw/Terms-and-Conditions> and for electronic format documents, subject to Terms and Conditions for Electronic Documents at <http://www.sgs.com.tw/Terms-and-Conditions>. Attention is drawn to the limitation of liability, indemnification and jurisdiction issues defined therein. Any holder of this document is advised that information contained hereon reflects the Company's findings at the time of its intervention only and within the limits of Client's instructions, if any. The Company's sole responsibility is to its Client and this document does not exonerate parties to a transaction from exercising all their rights and obligations under the transaction documents. This document cannot be reproduced except in full, without prior written approval of the Company. Any unauthorized alteration, forgery or falsification of the content or appearance of this document is unlawful and offenders may be prosecuted to the fullest extent of the law.

Radar Type5_Trial10 for 5290MHz

Data Sheet for FCC Radar Type 5						
Trial Number:		10		VSG Frequency(MHz):		5290
Number of Bursts in Trial:			20		Successful Detection: Yes	
Burst (8-20)	Number Pulses per Burst (1-3)	Pulse Width (50-100)	Chirp Width (5-20)	Pulse 1-to-2 Spacing	Pulse 2-to-3 Spacing	Starting Location Within Interval
		(μ sec)	(MHz)	(μ sec)	(μ sec)	(μ sec)
1	3	87.9	20	1065.1	1054.1	195845
2	2	82.9	20	1649.1		340735
3	1	50.4	20			487164
4	3	86.1	20	1511.9	1327.9	33463
5	3	91.3	20	1333.7	1629.7	177985
6	1	52.4	20			324139
7	2	78.8	20	964.2		468273
8	1	65.2	20			15748
9	3	99.2	20	1105.8	1472.8	160137
10	3	86.9	20	1715.1	1671.1	304464
11	3	95.4	20	1764.6	1171.6	448919
12	1	65.8	20			596028
13	1	65.2	20			142978
14	1	54.5	20			287964
15	1	57.4	20			433443
16	1	64	20			578958
17	1	59.8	20			125123
18	2	81.5	20	1113.5		269660
19	1	63.1	20			415298
20	2	70.1	20	1113.9		559053

Unless otherwise stated the results shown in this test report refer only to the sample(s) tested and such sample(s) are retained for 90 days only.

除非另有說明，此報告結果僅對測試之樣品負責，同時此樣品僅保留90天。本報告未經本公司書面許可，不可部份複製。

This document is issued by the Company subject to its General Conditions of Service printed overleaf, available on request or accessible at <http://www.sgs.com.tw/Terms-and-Conditions> and for electronic format documents, subject to Terms and Conditions for Electronic Documents at <http://www.sgs.com.tw/Terms-and-Conditions>. Attention is drawn to the limitation of liability, indemnification and jurisdiction issues defined therein. Any holder of this document is advised that information contained hereon reflects the Company's findings at the time of its intervention only and within the limits of Client's instructions, if any. The Company's sole responsibility is to its Client and this document does not exonerate parties to a transaction from exercising all their rights and obligations under the transaction documents. This document cannot be reproduced except in full, without prior written approval of the Company. Any unauthorized alteration, forgery or falsification of the content or appearance of this document is unlawful and offenders may be prosecuted to the fullest extent of the law.

SGS Taiwan Ltd.

No.134,Wu Kung Road, New Taipei Industrial Park, Wuku District, New Taipei City, Taiwan/新北市五股區新北產業園區五工路 134 號

台灣檢驗科技股份有限公司

t (886-2) 2299-3279

f (886-2) 2298-0488

www.sgs.com.tw

Member of SGS Group

Radar Type5_Trial11 for 5290MHz

Data Sheet for FCC Radar Type 5						
Trial Number:		11		VSG Frequency(MHz):		5257.659
Number of Bursts in Trial:			15		Successful Detection: Yes	
Burst (8-20)	Number Pulses per Burst (1-3)	Pulse Width (50-100)	Chirp Width (5-20)	Pulse 1-to-2 Spacing	Pulse 2-to-3 Spacing	Starting Location Within Interval
		(μ sec)	(MHz)	(μ sec)	(μ sec)	(μ sec)
1	1	52.9	13			143103
2	1	57	13			336633
3	3	93	13	1786	1375	528454
4	2	68.8	13	1796.2		722576
5	1	50.7	13			119259
6	3	90.7	13	1150.3	1478.3	311911
7	3	99.3	13	1551.7	1326.7	504351
8	1	53.6	13			700354
9	3	95.3	13	1600.7	1466.7	95028
10	2	67.1	13	1419.9		288667
11	3	99.5	13	1883.5	1753.5	480592
12	3	93.2	13	1087.8	1551.8	673584
13	2	74.5	13	1562.5		71396
14	1	64.1	13			265211
15	3	83.6	13	1622.4	1038.4	457007
16						
17						
18						
19						
20						

Unless otherwise stated the results shown in this test report refer only to the sample(s) tested and such sample(s) are retained for 90 days only.

除非另有說明，此報告結果僅對測試之樣品負責，同時此樣品僅保留90天。本報告未經本公司書面許可，不可部份複製。

This document is issued by the Company subject to its General Conditions of Service printed overleaf, available on request or accessible at <http://www.sgs.com.tw/Terms-and-Conditions> and for electronic format documents, subject to Terms and Conditions for Electronic Documents at <http://www.sgs.com.tw/Terms-and-Conditions>. Attention is drawn to the limitation of liability, indemnification and jurisdiction issues defined therein. Any holder of this document is advised that information contained hereon reflects the Company's findings at the time of its intervention only and within the limits of Client's instructions, if any. The Company's sole responsibility is to its Client and this document does not exonerate parties to a transaction from exercising all their rights and obligations under the transaction documents. This document cannot be reproduced except in full, without prior written approval of the Company. Any unauthorized alteration, forgery or falsification of the content or appearance of this document is unlawful and offenders may be prosecuted to the fullest extent of the law.

SGS Taiwan Ltd.

No.134,Wu Kung Road, New Taipei Industrial Park, Wuku District, New Taipei City, Taiwan/新北市五股區新北產業園區五工路 134 號

台灣檢驗科技股份有限公司

t (886-2) 2299-3279

f (886-2) 2298-0488

www.sgs.com.tw

Member of SGS Group

Radar Type5_Trial12 for 5290MHz

Data Sheet for FCC Radar Type 5						
Trial Number:		12		VSG Frequency(MHz):		5255.659
Number of Bursts in Trial:			10		Successful Detection: Yes	
Burst (8-20)	Number Pulses per Burst (1-3)	Pulse Width (50-100)	Chirp Width (5-20)	Pulse 1-to-2 Spacing	Pulse 2-to-3 Spacing	Starting Location Within Interval
		(μ sec)	(MHz)	(μ sec)	(μ sec)	(μ sec)
1	2	67.5	8	1366.5		978633
2	2	72.3	8	1722.7		71453
3	3	92.8	8	1745.2	1601.2	361200
4	1	56.7	8			653086
5	2	75.7	8	1346.3		942117
6	2	77.9	8	1602.1		35724
7	2	78.1	8	933.9		326175
8	3	95.3	8	1766.7	1165.7	615613
9	3	85.1	8	1363.9	1704.9	905273
10	1	51.1	8			1198252
11						
12						
13						
14						
15						
16						
17						
18						
19						
20						

Unless otherwise stated the results shown in this test report refer only to the sample(s) tested and such sample(s) are retained for 90 days only.

除非另有說明，此報告結果僅對測試之樣品負責，同時此樣品僅保留90天。本報告未經本公司書面許可，不可部份複製。

This document is issued by the Company subject to its General Conditions of Service printed overleaf, available on request or accessible at <http://www.sgs.com.tw/Terms-and-Conditions> and for electronic format documents, subject to Terms and Conditions for Electronic Documents at <http://www.sgs.com.tw/Terms-and-Conditions>. Attention is drawn to the limitation of liability, indemnification and jurisdiction issues defined therein. Any holder of this document is advised that information contained hereon reflects the Company's findings at the time of its intervention only and within the limits of Client's instructions, if any. The Company's sole responsibility is to its Client and this document does not exonerate parties to a transaction from exercising all their rights and obligations under the transaction documents. This document cannot be reproduced except in full, without prior written approval of the Company. Any unauthorized alteration, forgery or falsification of the content or appearance of this document is unlawful and offenders may be prosecuted to the fullest extent of the law.

Radar Type5_Trial13 for 5290MHz

Data Sheet for FCC Radar Type 5						
Trial Number:		13		VSG Frequency(MHz):		5258.859
Number of Bursts in Trial:			17		Successful Detection: Yes	
Burst (8-20)	Number Pulses per Burst (1-3)	Pulse Width (50-100)	Chirp Width (5-20)	Pulse 1-to-2 Spacing	Pulse 2-to-3 Spacing	Starting Location Within Interval
		(μ sec)	(MHz)	(μ sec)	(μ sec)	(μ sec)
1	1	59	16			170817
2	2	79.5	16	990.5		341357
3	3	90.3	16	1075.7	1220.7	510526
4	1	57	16			683467
5	2	71.8	16	1218.2		149404
6	1	60.4	16			320410
7	1	61.8	16			491519
8	2	82.3	16	1727.7		660636
9	2	74.5	16	1601.5		128495
10	3	88.7	16	975.3	1412.3	298307
11	2	80.8	16	1746.2		469475
12	3	90	16	1030	1551	638300
13	2	81.6	16	1088.4		107469
14	3	85.3	16	1827.7	1324.7	277145
15	1	50.6	16			449387
16	1	53.2	16			620125
17	2	75.1	16	1843.9		86364
18						
19						
20						

Unless otherwise stated the results shown in this test report refer only to the sample(s) tested and such sample(s) are retained for 90 days only.

除非另有說明，此報告結果僅對測試之樣品負責，同時此樣品僅保留90天。本報告未經本公司書面許可，不可部份複製。

This document is issued by the Company subject to its General Conditions of Service printed overleaf, available on request or accessible at <http://www.sgs.com.tw/Terms-and-Conditions> and for electronic format documents, subject to Terms and Conditions for Electronic Documents at <http://www.sgs.com.tw/Terms-and-Conditions>. Attention is drawn to the limitation of liability, indemnification and jurisdiction issues defined therein. Any holder of this document is advised that information contained hereon reflects the Company's findings at the time of its intervention only and within the limits of Client's instructions, if any. The Company's sole responsibility is to its Client and this document does not exonerate parties to a transaction from exercising all their rights and obligations under the transaction documents. This document cannot be reproduced except in full, without prior written approval of the Company. Any unauthorized alteration, forgery or falsification of the content or appearance of this document is unlawful and offenders may be prosecuted to the fullest extent of the law.

Radar Type5_Trial14 for 5290MHz

Data Sheet for FCC Radar Type 5						
Trial Number:		14		VSG Frequency(MHz):		5260.459
Number of Bursts in Trial:			20		Successful Detection: Yes	
Burst (8-20)	Number Pulses per Burst (1-3)	Pulse Width (50-100)	Chirp Width (5-20)	Pulse 1-to-2 Spacing	Pulse 2-to-3 Spacing	Starting Location Within Interval
		(μ sec)	(MHz)	(μ sec)	(μ sec)	(μ sec)
1	2	70	20	1015		218197
2	2	82	20	1063		363178
3	3	87.4	20	1016.6	1573.6	506900
4	1	52.2	20			55765
5	3	91.3	20	1392.7	1490.7	199823
6	1	51	20			346092
7	2	70.9	20	1197.1		490061
8	3	89.9	20	1240.1	1198.1	37702
9	3	91.8	20	1314.2	999.2	182230
10	2	67.1	20	1850.9		326990
11	2	74.7	20	1018.3		472340
12	3	87.5	20	916.5	1912.5	19883
13	3	92.3	20	1126.7	1650.7	164207
14	2	74.8	20	1634.2		309633
15	1	61.7	20			455707
16	1	57.8	20			2102
17	2	67.7	20	1674.3		146931
18	3	91.8	20	1452.2	1631.2	290728
19	1	61.1	20			437450
20	1	58.9	20			582293

Unless otherwise stated the results shown in this test report refer only to the sample(s) tested and such sample(s) are retained for 90 days only.

除非另有說明，此報告結果僅對測試之樣品負責，同時此樣品僅保留90天。本報告未經本公司書面許可，不可部份複製。

This document is issued by the Company subject to its General Conditions of Service printed overleaf, available on request or accessible at <http://www.sgs.com.tw/Terms-and-Conditions> and for electronic format documents, subject to Terms and Conditions for Electronic Documents at <http://www.sgs.com.tw/Terms-and-Conditions>. Attention is drawn to the limitation of liability, indemnification and jurisdiction issues defined therein. Any holder of this document is advised that information contained hereon reflects the Company's findings at the time of its intervention only and within the limits of Client's instructions, if any. The Company's sole responsibility is to its Client and this document does not exonerate parties to a transaction from exercising all their rights and obligations under the transaction documents. This document cannot be reproduced except in full, without prior written approval of the Company. Any unauthorized alteration, forgery or falsification of the content or appearance of this document is unlawful and offenders may be prosecuted to the fullest extent of the law.

SGS Taiwan Ltd.

No.134,Wu Kung Road, New Taipei Industrial Park, Wuku District, New Taipei City, Taiwan/新北市五股區新北產業園區五工路 134 號

台灣檢驗科技股份有限公司

t (886-2) 2299-3279

f (886-2) 2298-0488

www.sgs.com.tw

Member of SGS Group

Radar Type5_Trial15 for 5290MHz

Data Sheet for FCC Radar Type 5						
Trial Number:		15		VSG Frequency(MHz):		5258.459
Number of Bursts in Trial:			16		Successful Detection: Yes	
Burst (8-20)	Number Pulses per Burst (1-3)	Pulse Width (50-100)	Chirp Width (5-20)	Pulse 1-to-2 Spacing	Pulse 2-to-3 Spacing	Starting Location Within Interval
		(μ sec)	(MHz)	(μ sec)	(μ sec)	(μ sec)
1	3	96.7	15	1581.3	1271.3	161051
2	2	73.5	15	1917.5		342354
3	1	56.7	15			524731
4	3	87.7	15	1898.3	1496.3	703120
5	1	60.8	15			139360
6	3	100	15	1513	1072	319792
7	2	75.5	15	1704.5		501115
8	1	52.7	15			683650
9	2	77.6	15	1511.4		116904
10	3	90.7	15	1515.3	1368.3	297489
11	1	57.4	15			480050
12	1	56.1	15			661425
13	2	72.5	15	1240.5		94607
14	1	52.8	15			276358
15	1	58.1	15			458076
16	1	63.3	15			639282
17						
18						
19						
20						

Unless otherwise stated the results shown in this test report refer only to the sample(s) tested and such sample(s) are retained for 90 days only.

除非另有說明，此報告結果僅對測試之樣品負責，同時此樣品僅保留90天。本報告未經本公司書面許可，不可部份複製。

This document is issued by the Company subject to its General Conditions of Service printed overleaf, available on request or accessible at <http://www.sgs.com.tw/Terms-and-Conditions> and for electronic format documents, subject to Terms and Conditions for Electronic Documents at <http://www.sgs.com.tw/Terms-and-Conditions>. Attention is drawn to the limitation of liability, indemnification and jurisdiction issues defined therein. Any holder of this document is advised that information contained hereon reflects the Company's findings at the time of its intervention only and within the limits of Client's instructions, if any. The Company's sole responsibility is to its Client and this document does not exonerate parties to a transaction from exercising all their rights and obligations under the transaction documents. This document cannot be reproduced except in full, without prior written approval of the Company. Any unauthorized alteration, forgery or falsification of the content or appearance of this document is unlawful and offenders may be prosecuted to the fullest extent of the law.

SGS Taiwan Ltd.

No.134,Wu Kung Road, New Taipei Industrial Park, Wuku District, New Taipei City, Taiwan/新北市五股區新北產業園區五工路 134 號

台灣檢驗科技股份有限公司

t (886-2) 2299-3279

f (886-2) 2298-0488

www.sgs.com.tw

Member of SGS Group

Radar Type5_Trial16 for 5290MHz

Data Sheet for FCC Radar Type 5						
Trial Number:		16		VSG Frequency(MHz):		5260.059
Number of Bursts in Trial:			19		Successful Detection: Yes	
Burst (8-20)	Number Pulses per Burst (1-3)	Pulse Width (50-100)	Chirp Width (5-20)	Pulse 1-to-2 Spacing	Pulse 2-to-3 Spacing	Starting Location Within Interval
		(μ sec)	(MHz)	(μ sec)	(μ sec)	(μ sec)
1	3	97.8	19	1035.2	1109.2	60664
2	3	98.9	19	1349.1	1179.1	212758
3	2	67.7	19	1877.3		365185
4	2	78.4	19	1897.6		517638
5	2	69.3	19	1353.7		42020
6	2	67.1	19	1256.9		194546
7	2	80.1	19	1704.9		346961
8	3	93.4	19	935.6	1527.6	498702
9	3	87.1	19	1769.9	1303.9	23150
10	3	94.9	19	1043.1	1752.1	175148
11	2	82.3	19	1429.7		328193
12	1	63.8	19			481836
13	2	69	19	1717		4428
14	2	82.1	19	1509.9		156800
15	1	63.9	19			310290
16	3	93.6	19	1131.4	1715.4	460941
17	3	89.5	19	1035.5	927.5	613436
18	3	94.3	19	1285.7	1082.7	137818
19	2	78.4	19	1681.6		290315
20						

Unless otherwise stated the results shown in this test report refer only to the sample(s) tested and such sample(s) are retained for 90 days only.

除非另有說明，此報告結果僅對測試之樣品負責，同時此樣品僅保留90天。本報告未經本公司書面許可，不可部份複製。

This document is issued by the Company subject to its General Conditions of Service printed overleaf, available on request or accessible at <http://www.sgs.com.tw/Terms-and-Conditions> and for electronic format documents, subject to Terms and Conditions for Electronic Documents at <http://www.sgs.com.tw/Terms-and-Conditions>. Attention is drawn to the limitation of liability, indemnification and jurisdiction issues defined therein. Any holder of this document is advised that information contained hereon reflects the Company's findings at the time of its intervention only and within the limits of Client's instructions, if any. The Company's sole responsibility is to its Client and this document does not exonerate parties to a transaction from exercising all their rights and obligations under the transaction documents. This document cannot be reproduced except in full, without prior written approval of the Company. Any unauthorized alteration, forgery or falsification of the content or appearance of this document is unlawful and offenders may be prosecuted to the fullest extent of the law.

SGS Taiwan Ltd.

No.134,Wu Kung Road, New Taipei Industrial Park, Wuku District, New Taipei City, Taiwan/新北市五股區新北產業園區五工路 134 號

台灣檢驗科技股份有限公司

t (886-2) 2299-3279

f (886-2) 2298-0488

www.sgs.com.tw

Member of SGS Group

Radar Type5_Trial17 for 5290MHz

Data Sheet for FCC Radar Type 5						
Trial Number:		17		VSG Frequency(MHz):		5255.259
Number of Bursts in Trial:			10		Successful Detection: Yes	
Burst (8-20)	Number Pulses per Burst (1-3)	Pulse Width (50-100)	Chirp Width (5-20)	Pulse 1-to-2 Spacing	Pulse 2-to-3 Spacing	Starting Location Within Interval
		(μ sec)	(MHz)	(μ sec)	(μ sec)	(μ sec)
1	3	96.6	7	1648.4	1865.4	841832
2	2	75.3	7	1301.7		1134370
3	3	99.8	7	1691.2	928.2	226986
4	3	91.4	7	1351.6	1845.6	516768
5	3	91.3	7	1507.7	1109.7	806793
6	2	75.6	7	1497.4		1097643
7	2	68.2	7	1628.8		191388
8	1	62.3	7			482197
9	1	51	7			773239
10	1	59.6	7			1063311
11						
12						
13						
14						
15						
16						
17						
18						
19						
20						

Unless otherwise stated the results shown in this test report refer only to the sample(s) tested and such sample(s) are retained for 90 days only.

除非另有說明，此報告結果僅對測試之樣品負責，同時此樣品僅保留90天。本報告未經本公司書面許可，不可部份複製。

This document is issued by the Company subject to its General Conditions of Service printed overleaf, available on request or accessible at <http://www.sgs.com.tw/Terms-and-Conditions> and for electronic format documents, subject to Terms and Conditions for Electronic Documents at <http://www.sgs.com.tw/Terms-and-Conditions>. Attention is drawn to the limitation of liability, indemnification and jurisdiction issues defined therein. Any holder of this document is advised that information contained hereon reflects the Company's findings at the time of its intervention only and within the limits of Client's instructions, if any. The Company's sole responsibility is to its Client and this document does not exonerate parties to a transaction from exercising all their rights and obligations under the transaction documents. This document cannot be reproduced except in full, without prior written approval of the Company. Any unauthorized alteration, forgery or falsification of the content or appearance of this document is unlawful and offenders may be prosecuted to the fullest extent of the law.

SGS Taiwan Ltd.

No.134,Wu Kung Road, New Taipei Industrial Park, Wuku District, New Taipei City, Taiwan/新北市五股區新北產業園區五工路 134 號

台灣檢驗科技股份有限公司

t (886-2) 2299-3279

f (886-2) 2298-0488

www.sgs.com.tw

Member of SGS Group

Radar Type5_Trial18 for 5290MHz

Data Sheet for FCC Radar Type 5						
Trial Number:		18		VSG Frequency(MHz):		5257.659
Number of Bursts in Trial:			14		Successful Detection: Yes	
Burst (8-20)	Number Pulses per Burst (1-3)	Pulse Width (50-100)	Chirp Width (5-20)	Pulse 1-to-2 Spacing	Pulse 2-to-3 Spacing	Starting Location Within Interval
		(μ sec)	(MHz)	(μ sec)	(μ sec)	(μ sec)
1	2	68.6	13	1499.4		111159
2	1	64.9	13			318639
3	3	89.4	13	1225.6	1206.6	525016
4	2	66.7	13	1407.3		732895
5	3	98.5	13	1094.5	1290.5	85461
6	1	60.1	13			293098
7	2	68.9	13	1207.1		499889
8	2	74	13	1650		706709
9	2	82.7	13	937.3		60119
10	3	89.7	13	913.3	1511.3	266981
11	2	79.6	13	1323.4		474208
12	3	93.4	13	1709.6	922.6	680794
13	1	63.3	13			34618
14	1	50.5	13			242067
15						
16						
17						
18						
19						
20						

Unless otherwise stated the results shown in this test report refer only to the sample(s) tested and such sample(s) are retained for 90 days only.

除非另有說明，此報告結果僅對測試之樣品負責，同時此樣品僅保留90天。本報告未經本公司書面許可，不可部份複製。

This document is issued by the Company subject to its General Conditions of Service printed overleaf, available on request or accessible at <http://www.sgs.com.tw/Terms-and-Conditions> and for electronic format documents, subject to Terms and Conditions for Electronic Documents at <http://www.sgs.com.tw/Terms-and-Conditions>. Attention is drawn to the limitation of liability, indemnification and jurisdiction issues defined therein. Any holder of this document is advised that information contained hereon reflects the Company's findings at the time of its intervention only and within the limits of Client's instructions, if any. The Company's sole responsibility is to its Client and this document does not exonerate parties to a transaction from exercising all their rights and obligations under the transaction documents. This document cannot be reproduced except in full, without prior written approval of the Company. Any unauthorized alteration, forgery or falsification of the content or appearance of this document is unlawful and offenders may be prosecuted to the fullest extent of the law.

Radar Type5_Trial19 for 5290MHz

Data Sheet for FCC Radar Type 5						
Trial Number:		19		VSG Frequency(MHz):		5256.059
Number of Bursts in Trial:			11		Successful Detection: Yes	
Burst (8-20)	Number Pulses per Burst (1-3)	Pulse Width (50-100)	Chirp Width (5-20)	Pulse 1-to-2 Spacing	Pulse 2-to-3 Spacing	Starting Location Within Interval
		(μ sec)	(MHz)	(μ sec)	(μ sec)	(μ sec)
1	1	66	9			572486
2	2	67.7	9	1512.3		835382
3	1	61.6	9			11536
4	3	83.7	9	963.3	1336.3	275055
5	3	95.5	9	1832.5	1354.5	538089
6	2	76.8	9	1049.2		803017
7	1	63.9	9			1068197
8	2	66.7	9	1203.3		242891
9	2	78.3	9	998.7		507034
10	2	74.4	9	1755.6		770438
11	1	61.5	9			1035902
12						
13						
14						
15						
16						
17						
18						
19						
20						

Unless otherwise stated the results shown in this test report refer only to the sample(s) tested and such sample(s) are retained for 90 days only.

除非另有說明，此報告結果僅對測試之樣品負責，同時此樣品僅保留90天。本報告未經本公司書面許可，不可部份複製。

This document is issued by the Company subject to its General Conditions of Service printed overleaf, available on request or accessible at <http://www.sgs.com.tw/Terms-and-Conditions> and for electronic format documents, subject to Terms and Conditions for Electronic Documents at <http://www.sgs.com.tw/Terms-and-Conditions>. Attention is drawn to the limitation of liability, indemnification and jurisdiction issues defined therein. Any holder of this document is advised that information contained hereon reflects the Company's findings at the time of its intervention only and within the limits of Client's instructions, if any. The Company's sole responsibility is to its Client and this document does not exonerate parties to a transaction from exercising all their rights and obligations under the transaction documents. This document cannot be reproduced except in full, without prior written approval of the Company. Any unauthorized alteration, forgery or falsification of the content or appearance of this document is unlawful and offenders may be prosecuted to the fullest extent of the law.

SGS Taiwan Ltd.

No.134,Wu Kung Road, New Taipei Industrial Park, Wuku District, New Taipei City, Taiwan/新北市五股區新北產業園區五工路 134 號

台灣檢驗科技股份有限公司

t (886-2) 2299-3279

f (886-2) 2298-0488

www.sgs.com.tw

Member of SGS Group

Radar Type5_Trial20 for 5290MHz

Data Sheet for FCC Radar Type 5						
Trial Number:		20		VSG Frequency(MHz):		5258.859
Number of Bursts in Trial:			17		Successful Detection: Yes	
Burst (8-20)	Number Pulses per Burst (1-3)	Pulse Width (50-100)	Chirp Width (5-20)	Pulse 1-to-2 Spacing	Pulse 2-to-3 Spacing	Starting Location Within Interval
		(μ sec)	(MHz)	(μ sec)	(μ sec)	(μ sec)
1	3	88	16	1256	919	135783
2	3	98	16	1506	1371	305527
3	1	57.4	16			478186
4	2	76.4	16	1773.6		646724
5	1	52.8	16			115148
6	1	51	16			285926
7	1	54.8	16			456935
8	2	79	16	1222		626758
9	3	83.8	16	1125.2	1487.2	93692
10	2	68.5	16	1802.5		264129
11	2	79.9	16	1904.1		434598
12	3	92.9	16	1398.1	1123.1	604219
13	3	97.1	16	1045.9	1166.9	72856
14	2	70.6	16	1757.4		243445
15	2	72	16	1359		413877
16	3	95	16	1255	1652	582964
17	2	69.5	16	1837.5		51895
18						
19						
20						

Unless otherwise stated the results shown in this test report refer only to the sample(s) tested and such sample(s) are retained for 90 days only.

除非另有說明，此報告結果僅對測試之樣品負責，同時此樣品僅保留90天。本報告未經本公司書面許可，不可部份複製。

This document is issued by the Company subject to its General Conditions of Service printed overleaf, available on request or accessible at <http://www.sgs.com.tw/Terms-and-Conditions> and for electronic format documents, subject to Terms and Conditions for Electronic Documents at <http://www.sgs.com.tw/Terms-and-Conditions>. Attention is drawn to the limitation of liability, indemnification and jurisdiction issues defined therein. Any holder of this document is advised that information contained hereon reflects the Company's findings at the time of its intervention only and within the limits of Client's instructions, if any. The Company's sole responsibility is to its Client and this document does not exonerate parties to a transaction from exercising all their rights and obligations under the transaction documents. This document cannot be reproduced except in full, without prior written approval of the Company. Any unauthorized alteration, forgery or falsification of the content or appearance of this document is unlawful and offenders may be prosecuted to the fullest extent of the law.

Radar Type5_Trial21 for 5290MHz

Data Sheet for FCC Radar Type 5						
Trial Number:		21		VSG Frequency(MHz):		5325.141
Number of Bursts in Trial:			9		Successful Detection: Yes	
Burst (8-20)	Number Pulses per Burst (1-3)	Pulse Width (50-100)	Chirp Width (5-20)	Pulse 1-to-2 Spacing	Pulse 2-to-3 Spacing	Starting Location Within Interval
		(μ sec)	(MHz)	(μ sec)	(μ sec)	(μ sec)
1	1	56.7	6			421551
2	1	54.5	6			744478
3	3	98.9	6	1286.1	1719.1	1064529
4	1	53.1	6			58608
5	1	61.9	6			381621
6	3	99.2	6	1156.8	1217.8	703403
7	2	75.4	6	1653.6		1026298
8	2	73.6	6	1185.4		18794
9	1	64	6			341945
10						
11						
12						
13						
14						
15						
16						
17						
18						
19						
20						

Unless otherwise stated the results shown in this test report refer only to the sample(s) tested and such sample(s) are retained for 90 days only.

除非另有說明，此報告結果僅對測試之樣品負責，同時此樣品僅保留90天。本報告未經本公司書面許可，不可部份複製。

This document is issued by the Company subject to its General Conditions of Service printed overleaf, available on request or accessible at <http://www.sgs.com.tw/Terms-and-Conditions> and for electronic format documents, subject to Terms and Conditions for Electronic Documents at <http://www.sgs.com.tw/Terms-and-Conditions>. Attention is drawn to the limitation of liability, indemnification and jurisdiction issues defined therein. Any holder of this document is advised that information contained hereon reflects the Company's findings at the time of its intervention only and within the limits of Client's instructions, if any. The Company's sole responsibility is to its Client and this document does not exonerate parties to a transaction from exercising all their rights and obligations under the transaction documents. This document cannot be reproduced except in full, without prior written approval of the Company. Any unauthorized alteration, forgery or falsification of the content or appearance of this document is unlawful and offenders may be prosecuted to the fullest extent of the law.

SGS Taiwan Ltd.

No.134,Wu Kung Road, New Taipei Industrial Park, Wuku District, New Taipei City, Taiwan/新北市五股區新北產業園區五工路 134 號

台灣檢驗科技股份有限公司

t (886-2) 2299-3279

f (886-2) 2298-0488

www.sgs.com.tw

Member of SGS Group

Radar Type5_Trial22 for 5290MHz

Data Sheet for FCC Radar Type 5						
Trial Number:		22		VSG Frequency(MHz):		5322.341
Number of Bursts in Trial:			14		Successful Detection: Yes	
Burst (8-20)	Number Pulses per Burst (1-3)	Pulse Width (50-100)	Chirp Width (5-20)	Pulse 1-to-2 Spacing	Pulse 2-to-3 Spacing	Starting Location Within Interval
		(μ sec)	(MHz)	(μ sec)	(μ sec)	(μ sec)
1	3	84.5	13	1021.5	1628.5	425699
2	2	66.8	13	1144.2		633700
3	2	74.3	13	1140.7		840682
4	3	95.7	13	904.3	958.3	193640
5	1	51.9	13			401335
6	3	86.7	13	1253.3	1160.3	607151
7	1	64.9	13			816306
8	1	55.2	13			168523
9	1	60.5	13			376178
10	1	62.1	13			583300
11	1	61.4	13			791044
12	3	97.6	13	1516.4	1265.4	142362
13	2	79.9	13	1880.1		349568
14	3	88.6	13	1675.4	1030.4	556281
15						
16						
17						
18						
19						
20						

Unless otherwise stated the results shown in this test report refer only to the sample(s) tested and such sample(s) are retained for 90 days only.

除非另有說明，此報告結果僅對測試之樣品負責，同時此樣品僅保留90天。本報告未經本公司書面許可，不可部份複製。

This document is issued by the Company subject to its General Conditions of Service printed overleaf, available on request or accessible at <http://www.sgs.com.tw/Terms-and-Conditions> and for electronic format documents, subject to Terms and Conditions for Electronic Documents at <http://www.sgs.com.tw/Terms-and-Conditions>. Attention is drawn to the limitation of liability, indemnification and jurisdiction issues defined therein. Any holder of this document is advised that information contained hereon reflects the Company's findings at the time of its intervention only and within the limits of Client's instructions, if any. The Company's sole responsibility is to its Client and this document does not exonerate parties to a transaction from exercising all their rights and obligations under the transaction documents. This document cannot be reproduced except in full, without prior written approval of the Company. Any unauthorized alteration, forgery or falsification of the content or appearance of this document is unlawful and offenders may be prosecuted to the fullest extent of the law.

SGS Taiwan Ltd.

No.134,Wu Kung Road, New Taipei Industrial Park, Wuku District, New Taipei City, Taiwan/新北市五股區新北產業園區五工路 134 號

台灣檢驗科技股份有限公司

t (886-2) 2299-3279

f (886-2) 2298-0488

www.sgs.com.tw

Member of SGS Group

Radar Type5_Trial23 for 5290MHz

Data Sheet for FCC Radar Type 5						
Trial Number:		23		VSG Frequency(MHz):		5321.941
Number of Bursts in Trial:			15		Successful Detection: Yes	
Burst (8-20)	Number Pulses per Burst (1-3)	Pulse Width (50-100)	Chirp Width (5-20)	Pulse 1-to-2 Spacing	Pulse 2-to-3 Spacing	Starting Location Within Interval
		(μ sec)	(MHz)	(μ sec)	(μ sec)	(μ sec)
1	2	74.8	14	1903.2		712954
2	1	64.4	14			109577
3	2	79.6	14	947.4		302690
4	2	82.1	14	1141.9		496146
5	3	86.2	14	1236.8	989.8	688037
6	2	74.8	14	1243.2		85509
7	1	64.5	14			279236
8	1	63.1	14			472748
9	2	73.5	14	1362.5		665464
10	2	81.8	14	1385.2		61664
11	3	94.4	14	1855.6	961.6	254652
12	1	59.9	14			449055
13	2	73.7	14	1136.3		641555
14	2	75.6	14	1761.4		37890
15	1	58.4	14			231571
16						
17						
18						
19						
20						

Unless otherwise stated the results shown in this test report refer only to the sample(s) tested and such sample(s) are retained for 90 days only.

除非另有說明，此報告結果僅對測試之樣品負責，同時此樣品僅保留90天。本報告未經本公司書面許可，不可部份複製。

This document is issued by the Company subject to its General Conditions of Service printed overleaf, available on request or accessible at <http://www.sgs.com.tw/Terms-and-Conditions> and for electronic format documents, subject to Terms and Conditions for Electronic Documents at <http://www.sgs.com.tw/Terms-and-Conditions>. Attention is drawn to the limitation of liability, indemnification and jurisdiction issues defined therein. Any holder of this document is advised that information contained hereon reflects the Company's findings at the time of its intervention only and within the limits of Client's instructions, if any. The Company's sole responsibility is to its Client and this document does not exonerate parties to a transaction from exercising all their rights and obligations under the transaction documents. This document cannot be reproduced except in full, without prior written approval of the Company. Any unauthorized alteration, forgery or falsification of the content or appearance of this document is unlawful and offenders may be prosecuted to the fullest extent of the law.

SGS Taiwan Ltd.

No.134,Wu Kung Road, New Taipei Industrial Park, Wuku District, New Taipei City, Taiwan/新北市五股區新北產業園區五工路 134 號

台灣檢驗科技股份有限公司

t (886-2) 2299-3279

f (886-2) 2298-0488

www.sgs.com.tw

Member of SGS Group

Radar Type5_Trial24 for 5290MHz

Data Sheet for FCC Radar Type 5						
Trial Number:		24		VSG Frequency(MHz):		5325.141
Number of Bursts in Trial:			9		Successful Detection: Yes	
Burst (8-20)	Number Pulses per Burst (1-3)	Pulse Width (50-100)	Chirp Width (5-20)	Pulse 1-to-2 Spacing	Pulse 2-to-3 Spacing	Starting Location Within Interval
		(μ sec)	(MHz)	(μ sec)	(μ sec)	(μ sec)
1	2	76.1	6	1613.9		708682
2	3	98.8	6	973.2	1563.2	1030464
3	2	82.1	6	1484.9		23490
4	1	52.8	6			346421
5	3	88.9	6	1759.1	1530.1	667789
6	1	66.6	6			992268
7	3	88	6	1717	1899	1311409
8	1	54.6	6			306766
9	3	88.1	6	1901.9	1340.9	628217
10						
11						
12						
13						
14						
15						
16						
17						
18						
19						
20						

Unless otherwise stated the results shown in this test report refer only to the sample(s) tested and such sample(s) are retained for 90 days only.

除非另有說明，此報告結果僅對測試之樣品負責，同時此樣品僅保留90天。本報告未經本公司書面許可，不可部份複製。

This document is issued by the Company subject to its General Conditions of Service printed overleaf, available on request or accessible at <http://www.sgs.com.tw/Terms-and-Conditions> and for electronic format documents, subject to Terms and Conditions for Electronic Documents at <http://www.sgs.com.tw/Terms-and-Conditions>. Attention is drawn to the limitation of liability, indemnification and jurisdiction issues defined therein. Any holder of this document is advised that information contained hereon reflects the Company's findings at the time of its intervention only and within the limits of Client's instructions, if any. The Company's sole responsibility is to its Client and this document does not exonerate parties to a transaction from exercising all their rights and obligations under the transaction documents. This document cannot be reproduced except in full, without prior written approval of the Company. Any unauthorized alteration, forgery or falsification of the content or appearance of this document is unlawful and offenders may be prosecuted to the fullest extent of the law.

SGS Taiwan Ltd.

No.134,Wu Kung Road, New Taipei Industrial Park, Wuku District, New Taipei City, Taiwan/新北市五股區新北產業園區五工路 134 號

台灣檢驗科技股份有限公司

t (886-2) 2299-3279

f (886-2) 2298-0488

www.sgs.com.tw

Member of SGS Group

Radar Type5_Trial25 for 5290MHz

Data Sheet for FCC Radar Type 5						
Trial Number:		25		VSG Frequency(MHz):		5323.541
Number of Bursts in Trial:			12		Successful Detection: Yes	
Burst (8-20)	Number Pulses per Burst (1-3)	Pulse Width (50-100)	Chirp Width (5-20)	Pulse 1-to-2 Spacing	Pulse 2-to-3 Spacing	Starting Location Within Interval
		(μ sec)	(MHz)	(μ sec)	(μ sec)	(μ sec)
1	1	66.5	10			713981
2	3	93.2	10	1318.8	1383.8	954060
3	2	77.9	10	1604.1		199837
4	3	91.9	10	1294.1	1759.1	440713
5	1	60	10			684224
6	1	59.8	10			926991
7	3	83.6	10	1361.4	1524.4	169870
8	2	72	10	1008		411973
9	2	76.9	10	1546.1		653647
10	1	65.9	10			896784
11	2	74	10	1743		140278
12	3	88.8	10	1123.2	978.2	381664
13						
14						
15						
16						
17						
18						
19						
20						

Unless otherwise stated the results shown in this test report refer only to the sample(s) tested and such sample(s) are retained for 90 days only.

除非另有說明，此報告結果僅對測試之樣品負責，同時此樣品僅保留90天。本報告未經本公司書面許可，不可部份複製。

This document is issued by the Company subject to its General Conditions of Service printed overleaf, available on request or accessible at <http://www.sgs.com.tw/Terms-and-Conditions> and for electronic format documents, subject to Terms and Conditions for Electronic Documents at <http://www.sgs.com.tw/Terms-and-Conditions>. Attention is drawn to the limitation of liability, indemnification and jurisdiction issues defined therein. Any holder of this document is advised that information contained hereon reflects the Company's findings at the time of its intervention only and within the limits of Client's instructions, if any. The Company's sole responsibility is to its Client and this document does not exonerate parties to a transaction from exercising all their rights and obligations under the transaction documents. This document cannot be reproduced except in full, without prior written approval of the Company. Any unauthorized alteration, forgery or falsification of the content or appearance of this document is unlawful and offenders may be prosecuted to the fullest extent of the law.

Radar Type5_Trial26 for 5290MHz

Data Sheet for FCC Radar Type 5						
Trial Number:		26		VSG Frequency(MHz):		5321.941
Number of Bursts in Trial:			15		Successful Detection: Yes	
Burst (8-20)	Number Pulses per Burst (1-3)	Pulse Width (50-100)	Chirp Width (5-20)	Pulse 1-to-2 Spacing	Pulse 2-to-3 Spacing	Starting Location Within Interval
		(μ sec)	(MHz)	(μ sec)	(μ sec)	(μ sec)
1	2	82.4	14	1229.6		498536
2	2	67.1	14	1773.9		692019
3	3	89.3	14	1756.7	1617.7	88107
4	3	98.9	14	1600.1	1443.1	281127
5	3	99.5	14	1867.5	1028.5	474098
6	2	71.4	14	1023.6		668574
7	3	93.3	14	1751.7	1007.7	64396
8	3	92.6	14	1705.4	1299.4	257232
9	1	51.2	14			451923
10	3	92	14	1685	1843	642653
11	1	63	14			40796
12	3	89.4	14	1839.6	1564.6	233502
13	3	96.9	14	1282.1	1638.1	426399
14	3	84.5	14	1494.5	1024.5	619777
15	1	63.3	14			16934
16						
17						
18						
19						
20						

Unless otherwise stated the results shown in this test report refer only to the sample(s) tested and such sample(s) are retained for 90 days only.

除非另有說明，此報告結果僅對測試之樣品負責，同時此樣品僅保留90天。本報告未經本公司書面許可，不可部份複製。

This document is issued by the Company subject to its General Conditions of Service printed overleaf, available on request or accessible at <http://www.sgs.com.tw/Terms-and-Conditions> and for electronic format documents, subject to Terms and Conditions for Electronic Documents at <http://www.sgs.com.tw/Terms-and-Conditions>. Attention is drawn to the limitation of liability, indemnification and jurisdiction issues defined therein. Any holder of this document is advised that information contained hereon reflects the Company's findings at the time of its intervention only and within the limits of Client's instructions, if any. The Company's sole responsibility is to its Client and this document does not exonerate parties to a transaction from exercising all their rights and obligations under the transaction documents. This document cannot be reproduced except in full, without prior written approval of the Company. Any unauthorized alteration, forgery or falsification of the content or appearance of this document is unlawful and offenders may be prosecuted to the fullest extent of the law.

SGS Taiwan Ltd.

No.134,Wu Kung Road, New Taipei Industrial Park, Wuku District, New Taipei City, Taiwan/新北市五股區新北產業園區五工路 134 號

台灣檢驗科技股份有限公司

t (886-2) 2299-3279

f (886-2) 2298-0488

www.sgs.com.tw

Member of SGS Group

Radar Type5_Trial27 for 5290MHz

Data Sheet for FCC Radar Type 5						
Trial Number:		27		VSG Frequency(MHz):		5321.141
Number of Bursts in Trial:			17		Successful Detection: Yes	
Burst (8-20)	Number Pulses per Burst (1-3)	Pulse Width (50-100)	Chirp Width (5-20)	Pulse 1-to-2 Spacing	Pulse 2-to-3 Spacing	Starting Location Within Interval
		(μ sec)	(MHz)	(μ sec)	(μ sec)	(μ sec)
1	2	79.4	16	1554.6		185404
2	3	94.8	16	1571.2	1078.2	355243
3	3	91.1	16	1445.9	1467.9	524957
4	2	72	16	1706		696602
5	3	86.8	16	1170.2	1767.2	164009
6	1	59.7	16			335368
7	3	91.5	16	1447.5	1197.5	504553
8	1	65.5	16			677665
9	3	93	16	978	1696	143140
10	3	96.9	16	1185.1	1071.1	313396
11	2	72.6	16	976.4		484806
12	1	53	16			655886
13	1	63.7	16			122700
14	3	98.2	16	939.8	1156.8	292699
15	2	72.4	16	1661.6		463032
16	2	83.1	16	955.9		633961
17	1	57.7	16			101592
18						
19						
20						

Unless otherwise stated the results shown in this test report refer only to the sample(s) tested and such sample(s) are retained for 90 days only.

除非另有說明，此報告結果僅對測試之樣品負責，同時此樣品僅保留90天。本報告未經本公司書面許可，不可部份複製。

This document is issued by the Company subject to its General Conditions of Service printed overleaf, available on request or accessible at <http://www.sgs.com.tw/Terms-and-Conditions> and for electronic format documents, subject to Terms and Conditions for Electronic Documents at <http://www.sgs.com.tw/Terms-and-Conditions>. Attention is drawn to the limitation of liability, indemnification and jurisdiction issues defined therein. Any holder of this document is advised that information contained hereon reflects the Company's findings at the time of its intervention only and within the limits of Client's instructions, if any. The Company's sole responsibility is to its Client and this document does not exonerate parties to a transaction from exercising all their rights and obligations under the transaction documents. This document cannot be reproduced except in full, without prior written approval of the Company. Any unauthorized alteration, forgery or falsification of the content or appearance of this document is unlawful and offenders may be prosecuted to the fullest extent of the law.

SGS Taiwan Ltd.

No.134,Wu Kung Road, New Taipei Industrial Park, Wuku District, New Taipei City, Taiwan/新北市五股區新北產業園區五工路 134 號

台灣檢驗科技股份有限公司

t (886-2) 2299-3279

f (886-2) 2298-0488

www.sgs.com.tw

Member of SGS Group

Radar Type5_Trial28 for 5290MHz

Data Sheet for FCC Radar Type 5						
Trial Number:		28		VSG Frequency(MHz):		5321.541
Number of Bursts in Trial:			16		Successful Detection: Yes	
Burst (8-20)	Number Pulses per Burst (1-3)	Pulse Width (50-100)	Chirp Width (5-20)	Pulse 1-to-2 Spacing	Pulse 2-to-3 Spacing	Starting Location Within Interval
		(μ sec)	(MHz)	(μ sec)	(μ sec)	(μ sec)
1	1	51.6	15			289349
2	2	69.6	15	1249.4		470024
3	3	93.7	15	1041.3	1150.3	650118
4	2	81.7	15	1884.3		85378
5	3	92.9	15	1015.1	1041.1	266411
6	1	54	15			448486
7	3	89.4	15	1661.6	1625.6	627280
8	3	95.2	15	1199.8	1312.8	63036
9	3	94.8	15	1874.2	1264.2	243526
10	1	62	15			426457
11	3	86.8	15	1765.2	1300.2	605400
12	2	74.6	15	1030.4		40835
13	2	80.2	15	1433.8		221894
14	3	88.6	15	1584.4	1204.4	402325
15	3	95.1	15	1364.9	1513.9	582845
16	2	75.6	15	1550.4		18465
17						
18						
19						
20						

Unless otherwise stated the results shown in this test report refer only to the sample(s) tested and such sample(s) are retained for 90 days only.

除非另有說明，此報告結果僅對測試之樣品負責，同時此樣品僅保留90天。本報告未經本公司書面許可，不可部份複製。

This document is issued by the Company subject to its General Conditions of Service printed overleaf, available on request or accessible at <http://www.sgs.com.tw/Terms-and-Conditions> and for electronic format documents, subject to Terms and Conditions for Electronic Documents at <http://www.sgs.com.tw/Terms-and-Conditions>. Attention is drawn to the limitation of liability, indemnification and jurisdiction issues defined therein. Any holder of this document is advised that information contained hereon reflects the Company's findings at the time of its intervention only and within the limits of Client's instructions, if any. The Company's sole responsibility is to its Client and this document does not exonerate parties to a transaction from exercising all their rights and obligations under the transaction documents. This document cannot be reproduced except in full, without prior written approval of the Company. Any unauthorized alteration, forgery or falsification of the content or appearance of this document is unlawful and offenders may be prosecuted to the fullest extent of the law.

Radar Type5_Trial29 for 5290MHz

Data Sheet for FCC Radar Type 5						
Trial Number:		29		VSG Frequency(MHz):		5323.541
Number of Bursts in Trial:			12		Successful Detection: Yes	
Burst (8-20)	Number Pulses per Burst (1-3)	Pulse Width (50-100)	Chirp Width (5-20)	Pulse 1-to-2 Spacing	Pulse 2-to-3 Spacing	Starting Location Within Interval
		(μ sec)	(MHz)	(μ sec)	(μ sec)	(μ sec)
1	3	96.5	10	1604.5	1082.5	265973
2	1	54.2	10			509016
3	2	77.3	10	1263.7		749934
4	3	85.8	10	1593.2	1151.2	990734
5	3	93.9	10	920.1	1876.1	236405
6	3	87.2	10	999.8	1300.8	477860
7	2	79	10	980		720257
8	3	91	10	977	918	961256
9	1	51.6	10			207126
10	3	96.3	10	1180.7	1203.7	448163
11	1	51.9	10			691269
12	2	76.9	10	1126.1		932778
13						
14						
15						
16						
17						
18						
19						
20						

Unless otherwise stated the results shown in this test report refer only to the sample(s) tested and such sample(s) are retained for 90 days only.

除非另有說明，此報告結果僅對測試之樣品負責，同時此樣品僅保留90天。本報告未經本公司書面許可，不可部份複製。

This document is issued by the Company subject to its General Conditions of Service printed overleaf, available on request or accessible at <http://www.sgs.com.tw/Terms-and-Conditions> and for electronic format documents, subject to Terms and Conditions for Electronic Documents at <http://www.sgs.com.tw/Terms-and-Conditions>. Attention is drawn to the limitation of liability, indemnification and jurisdiction issues defined therein. Any holder of this document is advised that information contained hereon reflects the Company's findings at the time of its intervention only and within the limits of Client's instructions, if any. The Company's sole responsibility is to its Client and this document does not exonerate parties to a transaction from exercising all their rights and obligations under the transaction documents. This document cannot be reproduced except in full, without prior written approval of the Company. Any unauthorized alteration, forgery or falsification of the content or appearance of this document is unlawful and offenders may be prosecuted to the fullest extent of the law.

SGS Taiwan Ltd.

No.134,Wu Kung Road, New Taipei Industrial Park, Wuku District, New Taipei City, Taiwan/新北市五股區新北產業園區五工路 134 號

台灣檢驗科技股份有限公司

t (886-2) 2299-3279

f (886-2) 2298-0488

www.sgs.com.tw

Member of SGS Group

Radar Type5_Trial30 for 5290MHz

Data Sheet for FCC Radar Type 5						
Trial Number:		30		VSG Frequency(MHz):		5319.941
Number of Bursts in Trial:			19	Successful Detection:		Yes
Burst (8-20)	Number Pulses per Burst (1-3)	Pulse Width (50-100)	Chirp Width (5-20)	Pulse 1-to-2 Spacing	Pulse 2-to-3 Spacing	Starting Location Within Interval
		(μ sec)	(MHz)	(μ sec)	(μ sec)	(μ sec)
1	2	68.3	19	1287.7		111742
2	2	79.5	19	1375.5		263974
3	3	94.4	19	1371.6	1809.6	415412
4	2	78.9	19	1033.1		569750
5	1	58.9	19			93035
6	1	55.2	19			245758
7	3	87.8	19	1741.2	931.2	396617
8	2	77.2	19	1149.8		550426
9	3	90.8	19	1320.2	1427.2	73959
10	2	81.7	19	1204.3		226712
11	3	86.5	19	1320.5	1309.5	378328
12	3	90.7	19	1303.3	1374.3	530663
13	1	51.6	19			55500
14	2	76.9	19	1169.1		207885
15	3	92.1	19	1109.9	1723.9	359389
16	3	97.8	19	1590.2	1052.2	511380
17	1	54.6	19			36611
18	3	91	19	1234	1848	188355
19	1	62.7	19			342053
20						

Unless otherwise stated the results shown in this test report refer only to the sample(s) tested and such sample(s) are retained for 90 days only.

除非另有說明，此報告結果僅對測試之樣品負責，同時此樣品僅保留90天。本報告未經本公司書面許可，不可部份複製。

This document is issued by the Company subject to its General Conditions of Service printed overleaf, available on request or accessible at <http://www.sgs.com.tw/Terms-and-Conditions> and for electronic format documents, subject to Terms and Conditions for Electronic Documents at <http://www.sgs.com.tw/Terms-and-Conditions>. Attention is drawn to the limitation of liability, indemnification and jurisdiction issues defined therein. Any holder of this document is advised that information contained hereon reflects the Company's findings at the time of its intervention only and within the limits of Client's instructions, if any. The Company's sole responsibility is to its Client and this document does not exonerate parties to a transaction from exercising all their rights and obligations under the transaction documents. This document cannot be reproduced except in full, without prior written approval of the Company. Any unauthorized alteration, forgery or falsification of the content or appearance of this document is unlawful and offenders may be prosecuted to the fullest extent of the law.

Radar Type6 for 5290MHz

Data Sheet for FCC Radar Type 6

Trial	Pulse Width	PRI	Pulses per Hop	Hopping Rate	Hopping Sequence Length	Successful Detection
	(μ sec)	(μ sec)		(kHz)	(msec)	(Yes/No)
1	1	333	9	0.333	300	Yes
2	1	333	9	0.333	300	Yes
3	1	333	9	0.333	300	Yes
4	1	333	9	0.333	300	Yes
5	1	333	9	0.333	300	Yes
6	1	333	9	0.333	300	Yes
7	1	333	9	0.333	300	Yes
8	1	333	9	0.333	300	Yes
9	1	333	9	0.333	300	Yes
10	1	333	9	0.333	300	Yes
11	1	333	9	0.333	300	Yes
12	1	333	9	0.333	300	Yes
13	1	333	9	0.333	300	Yes
14	1	333	9	0.333	300	Yes
15	1	333	9	0.333	300	Yes
16	1	333	9	0.333	300	Yes
17	1	333	9	0.333	300	No
18	1	333	9	0.333	300	Yes
19	1	333	9	0.333	300	Yes
20	1	333	9	0.333	300	Yes
21	1	333	9	0.333	300	Yes
22	1	333	9	0.333	300	Yes
23	1	333	9	0.333	300	Yes
24	1	333	9	0.333	300	Yes
25	1	333	9	0.333	300	Yes
26	1	333	9	0.333	300	Yes
27	1	333	9	0.333	300	Yes
28	1	333	9	0.333	300	Yes
29	1	333	9	0.333	300	Yes
30	1	333	9	0.333	300	Yes

Unless otherwise stated the results shown in this test report refer only to the sample(s) tested and such sample(s) are retained for 90 days only.

除非另有說明，此報告結果僅對測試之樣品負責，同時此樣品僅保留90天。本報告未經本公司書面許可，不可部份複製。

This document is issued by the Company subject to its General Conditions of Service printed overleaf, available on request or accessible at <http://www.sgs.com.tw/Terms-and-Conditions> and for electronic format documents, subject to Terms and Conditions for Electronic Documents at <http://www.sgs.com.tw/Terms-and-Conditions>. Attention is drawn to the limitation of liability, indemnification and jurisdiction issues defined therein. Any holder of this document is advised that information contained hereon reflects the Company's findings at the time of its intervention only and within the limits of Client's instructions, if any. The Company's sole responsibility is to its Client and this document does not exonerate parties to a transaction from exercising all their rights and obligations under the transaction documents. This document cannot be reproduced except in full, without prior written approval of the Company. Any unauthorized alteration, forgery or falsification of the content or appearance of this document is unlawful and offenders may be prosecuted to the fullest extent of the law.

SGS Taiwan Ltd.

No.134,Wu Kung Road, New Taipei Industrial Park, Wuku District, New Taipei City, Taiwan/新北市五股區新北產業園區五工路 134 號

台灣檢驗科技股份有限公司

t (886-2) 2299-3279

f (886-2) 2298-0488

www.sgs.com.tw

Member of SGS Group

HE80_5530MHz

Short Pulse Radar Type	Minimum Number of Trials	Detection(%)		Minmum Percentage of Successful Detection(%)	Pass/Fail
1	30	96.67		60	Pass
2	30	96.67		60	Pass
3	30	66.67		60	Pass
4	30	100		60	Pass
Aggregate (Radar Types 1-4)	120	90.0025		80	Pass
Long Pulse Radar Type	Minimum Number of Trials	Each Detection(%)	Total Detection(%)	Minmum Percentage of Successful Detection(%)	Pass/Fail
5	Center:10	100	100	80	Pass
	Low Edge:10	100			
	High Edge:10	100			
Frequency Hopping Radar Type	Minimum Number of Trials	Detection(%)		Minmum Percentage of Successful Detection(%)	Pass/Fail
6	30	96.66666667		70	Pass

Unless otherwise stated the results shown in this test report refer only to the sample(s) tested and such sample(s) are retained for 90 days only.

除非另有說明，此報告結果僅對測試之樣品負責，同時此樣品僅保留90天。本報告未經本公司書面許可，不可部份複製。

This document is issued by the Company subject to its General Conditions of Service printed overleaf, available on request or accessible at <http://www.sgs.com.tw/Terms-and-Conditions> and for electronic format documents, subject to Terms and Conditions for Electronic Documents at <http://www.sgs.com.tw/Terms-and-Conditions>. Attention is drawn to the limitation of liability, indemnification and jurisdiction issues defined therein. Any holder of this document is advised that information contained hereon reflects the Company's findings at the time of its intervention only and within the limits of Client's instructions, if any. The Company's sole responsibility is to its Client and this document does not exonerate parties to a transaction from exercising all their rights and obligations under the transaction documents. This document cannot be reproduced except in full, without prior written approval of the Company. Any unauthorized alteration, forgery or falsification of the content or appearance of this document is unlawful and offenders may be prosecuted to the fullest extent of the law.

Radar Type1 for 5530MHz

Data Sheet for FCC Radar Type 1

Trial	VSG Frequency (MHz)	Pulse Repetition Frequency Number (1 to 23)	Pulse Repetition Frequency	PRI	Test A/B	Successful Detection
			(Pulses Per Second)	(msec)	A/B	(Yes/No)
1	5530	13	1319.3	758	A	Yes
2	5530	21	1089.3	918	A	Yes
3	5530	8	1519.8	658	A	Yes
4	5530	19	1139	878	A	Yes
5	5530	18	1165.5	858	A	Yes
6	5530	11	1392.8	718	A	No
7	5530	6	1618.1	618	A	Yes
8	5530	10	1432.7	698	A	Yes
9	5530	16	1222.5	818	A	Yes
10	5530	17	1193.3	838	A	Yes
11	5530	23	326.2	3066	A	Yes
12	5530	9	1474.9	678	A	Yes
13	5530	4	1730.1	578	A	Yes
14	5530	5	1672.2	598	A	Yes
15	5530	1	1930.5	518	A	Yes
16	5530	-	533.6	1874	B	Yes
17	5530	-	471.7	2120	B	Yes
18	5530	-	342.2	2922	B	Yes
19	5530	-	993	1007	B	Yes
20	5530	-	1257.9	795	B	Yes
21	5530	-	742.9	1346	B	Yes
22	5530	-	814.3	1228	B	Yes
23	5530	-	403.1	2481	B	Yes
24	5530	-	700.8	1427	B	Yes
25	5530	-	1831.5	546	B	Yes
26	5530	-	1251.6	799	B	Yes
27	5530	-	483.6	2068	B	Yes
28	5530	-	970.9	1030	B	Yes
29	5530	-	449.6	2224	B	Yes
30	5530	-	687.8	1454	B	Yes

Unless otherwise stated the results shown in this test report refer only to the sample(s) tested and such sample(s) are retained for 90 days only.

除非另有說明，此報告結果僅對測試之樣品負責，同時此樣品僅保留90天。本報告未經本公司書面許可，不可部份複製。

This document is issued by the Company subject to its General Conditions of Service printed overleaf, available on request or accessible at <http://www.sgs.com.tw/Terms-and-Conditions> and for electronic format documents, subject to Terms and Conditions for Electronic Documents at <http://www.sgs.com.tw/Terms-and-Conditions>. Attention is drawn to the limitation of liability, indemnification and jurisdiction issues defined therein. Any holder of this document is advised that information contained hereon reflects the Company's findings at the time of its intervention only and within the limits of Client's instructions, if any. The Company's sole responsibility is to its Client and this document does not exonerate parties to a transaction from exercising all their rights and obligations under the transaction documents. This document cannot be reproduced except in full, without prior written approval of the Company. Any unauthorized alteration, forgery or falsification of the content or appearance of this document is unlawful and offenders may be prosecuted to the fullest extent of the law.

SGS Taiwan Ltd.

No.134,Wu Kung Road, New Taipei Industrial Park, Wuku District, New Taipei City, Taiwan/新北市五股區新北產業園區五工路 134 號

台灣檢驗科技股份有限公司

t (886-2) 2299-3279

f (886-2) 2298-0488

www.sgs.com.tw

Member of SGS Group

Radar Type2 for 5530MHz

Data Sheet for FCC Radar Type 2

Trial	VSG Frequency (MHz)	Number Pulses per Burst (23-29)	Pulse Width (1-5)	PRI (150-230)	Successful Detection
			(μ s)	(μ s)	(Yes/No)
1	5530	29	4.9	195	Yes
2	5530	28	4.1	153	Yes
3	5530	26	3.2	151	Yes
4	5530	23	1.2	227	Yes
5	5530	23	1.1	179	Yes
6	5530	26	2.9	166	Yes
7	5530	26	2.7	174	Yes
8	5530	24	2.1	230	Yes
9	5530	24	1.9	180	Yes
10	5530	29	4.8	223	Yes
11	5530	26	3.2	193	Yes
12	5530	24	1.9	155	Yes
13	5530	28	4	187	Yes
14	5530	29	5	206	Yes
15	5530	27	3.6	220	Yes
16	5530	29	4.7	175	Yes
17	5530	24	1.7	204	Yes
18	5530	26	3.1	181	Yes
19	5530	25	2.2	228	Yes
20	5530	28	4	182	Yes
21	5530	23	1.4	198	Yes
22	5530	26	3	199	Yes
23	5530	27	3.3	152	Yes
24	5530	23	1.3	178	No
25	5530	25	2.2	207	Yes
26	5530	27	3.4	159	Yes
27	5530	28	3.9	225	Yes
28	5530	27	3.6	168	Yes
29	5530	25	2.3	177	Yes
30	5530	29	4.7	205	Yes

Unless otherwise stated the results shown in this test report refer only to the sample(s) tested and such sample(s) are retained for 90 days only.

除非另有說明，此報告結果僅對測試之樣品負責，同時此樣品僅保留90天。本報告未經本公司書面許可，不可部份複製。

This document is issued by the Company subject to its General Conditions of Service printed overleaf, available on request or accessible at <http://www.sgs.com.tw/Terms-and-Conditions> and for electronic format documents, subject to Terms and Conditions for Electronic Documents at <http://www.sgs.com.tw/Terms-and-Conditions>. Attention is drawn to the limitation of liability, indemnification and jurisdiction issues defined therein. Any holder of this document is advised that information contained hereon reflects the Company's findings at the time of its intervention only and within the limits of Client's instructions, if any. The Company's sole responsibility is to its Client and this document does not exonerate parties to a transaction from exercising all their rights and obligations under the transaction documents. This document cannot be reproduced except in full, without prior written approval of the Company. Any unauthorized alteration, forgery or falsification of the content or appearance of this document is unlawful and offenders may be prosecuted to the fullest extent of the law.

Radar Type3 for 5530MHz

Data Sheet for FCC Radar Type 3

Trial	VSG Frequency (MHz)	Number Pulses per Burst (16-18)	Pulse Width (6-10)	PRI (200-500)	Successful Detection
			(μ s)	(μ s)	(Yes/No)
1	5530	18	9.9	442	No
2	5530	18	9.1	499	Yes
3	5530	17	8.2	273	Yes
4	5530	16	6.2	338	No
5	5530	16	6.1	487	Yes
6	5530	17	7.9	420	No
7	5530	17	7.7	450	Yes
8	5530	16	7.1	339	No
9	5530	16	6.9	405	Yes
10	5530	18	9.8	223	Yes
11	5530	17	8.2	453	Yes
12	5530	16	6.9	417	No
13	5530	18	9	400	Yes
14	5530	18	10	498	Yes
15	5530	17	8.6	274	Yes
16	5530	18	9.7	431	No
17	5530	16	6.7	294	Yes
18	5530	17	8.1	203	Yes
19	5530	16	7.2	298	Yes
20	5530	18	9	473	No
21	5530	16	6.4	407	No
22	5530	17	8	258	Yes
23	5530	17	8.3	249	Yes
24	5530	16	6.3	446	Yes
25	5530	16	7.2	486	Yes
26	5530	17	8.4	480	No
27	5530	18	8.9	370	Yes
28	5530	17	8.6	348	No
29	5530	16	7.3	401	Yes
30	5530	18	9.7	264	Yes

Unless otherwise stated the results shown in this test report refer only to the sample(s) tested and such sample(s) are retained for 90 days only.

除非另有說明，此報告結果僅對測試之樣品負責，同時此樣品僅保留90天。本報告未經本公司書面許可，不可部份複製。

This document is issued by the Company subject to its General Conditions of Service printed overleaf, available on request or accessible at <http://www.sgs.com.tw/Terms-and-Conditions> and for electronic format documents, subject to Terms and Conditions for Electronic Documents at <http://www.sgs.com.tw/Terms-and-Conditions>. Attention is drawn to the limitation of liability, indemnification and jurisdiction issues defined therein. Any holder of this document is advised that information contained hereon reflects the Company's findings at the time of its intervention only and within the limits of Client's instructions, if any. The Company's sole responsibility is to its Client and this document does not exonerate parties to a transaction from exercising all their rights and obligations under the transaction documents. This document cannot be reproduced except in full, without prior written approval of the Company. Any unauthorized alteration, forgery or falsification of the content or appearance of this document is unlawful and offenders may be prosecuted to the fullest extent of the law.

Radar Type4 for 5530MHz

Data Sheet for FCC Radar Type 4

Trial	VSG Frequency (MHz)	Number Pulses per Burst (12-16)	Pulse Width (11-20)	PRI (200-500)	Successful Detection
			(μ s)	(μ s)	(Yes/No)
1	5530	16	19.6	442	Yes
2	5530	15	17.8	499	Yes
3	5530	14	15.8	273	Yes
4	5530	12	11.4	338	Yes
5	5530	12	11.3	487	Yes
6	5530	14	15.3	420	Yes
7	5530	14	14.9	450	Yes
8	5530	13	13.5	339	Yes
9	5530	13	13.1	405	Yes
10	5530	16	19.5	223	Yes
11	5530	14	16	453	Yes
12	5530	13	13	417	Yes
13	5530	15	17.8	400	Yes
14	5530	16	20	498	Yes
15	5530	15	16.9	274	Yes
16	5530	16	19.2	431	Yes
17	5530	12	12.6	294	Yes
18	5530	14	15.6	203	Yes
19	5530	13	13.6	298	Yes
20	5530	15	17.6	473	Yes
21	5530	12	12.1	407	Yes
22	5530	14	15.5	258	Yes
23	5530	14	16.2	249	Yes
24	5530	12	11.7	446	Yes
25	5530	13	13.8	486	Yes
26	5530	15	16.5	480	Yes
27	5530	15	17.5	370	Yes
28	5530	15	16.8	348	Yes
29	5530	13	13.9	401	Yes
30	5530	16	19.3	264	Yes

Unless otherwise stated the results shown in this test report refer only to the sample(s) tested and such sample(s) are retained for 90 days only.

除非另有說明，此報告結果僅對測試之樣品負責，同時此樣品僅保留90天。本報告未經本公司書面許可，不可部份複製。

This document is issued by the Company subject to its General Conditions of Service printed overleaf, available on request or accessible at <http://www.sgs.com.tw/Terms-and-Conditions> and for electronic format documents, subject to Terms and Conditions for Electronic Documents at <http://www.sgs.com.tw/Terms-and-Conditions>. Attention is drawn to the limitation of liability, indemnification and jurisdiction issues defined therein. Any holder of this document is advised that information contained hereon reflects the Company's findings at the time of its intervention only and within the limits of Client's instructions, if any. The Company's sole responsibility is to its Client and this document does not exonerate parties to a transaction from exercising all their rights and obligations under the transaction documents. This document cannot be reproduced except in full, without prior written approval of the Company. Any unauthorized alteration, forgery or falsification of the content or appearance of this document is unlawful and offenders may be prosecuted to the fullest extent of the law.

Radar Type5_Trial1 for 5530MHz

Data Sheet for FCC Radar Type 5						
Trial Number:			1	VSG Frequency(MHz):		5530
Number of Bursts in Trial:			20	Successful Detection:		Yes
Burst (8-20)	Number Pulses per Burst (1-3)	Pulse Width (50-100)	Chirp Width (5-20)	Pulse 1-to-2 Spacing	Pulse 2-to-3 Spacing	Starting Location Within Interval
		(μ sec)	(MHz)	(μ sec)	(μ sec)	(μ sec)
1	3	97.7	20	1034.3	1421.3	116141
2	3	87.9	20	1634.1	1463.1	260383
3	2	76.9	20	929.1		406435
4	1	52.4	20			552540
5	1	51.8	20			98818
6	2	74	20	1785		243337
7	2	71.7	20	1586.3		388146
8	1	64	20			534217
9	1	61.5	20			80882
10	3	97.3	20	912.7	1544.7	224944
11	2	77.7	20	1096.3		370763
12	1	61.1	20			516312
13	3	87.5	20	1260.5	1441.5	62728
14	3	99.7	20	1776.3	1284.3	207224
15	2	82.7	20	1140.3		352481
16	3	95.2	20	1213.8	1162.8	495985
17	1	59.1	20			45158
18	2	75.6	20	1041.4		189991
19	1	64.7	20			335648
20	3	86.8	20	918.2	1652.2	478439

Unless otherwise stated the results shown in this test report refer only to the sample(s) tested and such sample(s) are retained for 90 days only.

除非另有說明，此報告結果僅對測試之樣品負責，同時此樣品僅保留90天。本報告未經本公司書面許可，不可部份複製。

This document is issued by the Company subject to its General Conditions of Service printed overleaf, available on request or accessible at <http://www.sgs.com.tw/Terms-and-Conditions> and for electronic format documents, subject to Terms and Conditions for Electronic Documents at <http://www.sgs.com.tw/Terms-and-Conditions>. Attention is drawn to the limitation of liability, indemnification and jurisdiction issues defined therein. Any holder of this document is advised that information contained hereon reflects the Company's findings at the time of its intervention only and within the limits of Client's instructions, if any. The Company's sole responsibility is to its Client and this document does not exonerate parties to a transaction from exercising all their rights and obligations under the transaction documents. This document cannot be reproduced except in full, without prior written approval of the Company. Any unauthorized alteration, forgery or falsification of the content or appearance of this document is unlawful and offenders may be prosecuted to the fullest extent of the law.

SGS Taiwan Ltd.

No.134,Wu Kung Road, New Taipei Industrial Park, Wuku District, New Taipei City, Taiwan/新北市五股區新北產業園區五工路 134 號

台灣檢驗科技股份有限公司

t (886-2) 2299-3279

f (886-2) 2298-0488

www.sgs.com.tw

Member of SGS Group

Radar Type5_Trial2 for 5530MHz

Data Sheet for FCC Radar Type 5						
Trial Number:			2		VSG Frequency(MHz): 5530	
Number of Bursts in Trial:			17		Successful Detection: Yes	
Burst (8-20)	Number Pulses per Burst (1-3)	Pulse Width (50-100)	Chirp Width (5-20)	Pulse 1-to-2 Spacing	Pulse 2-to-3 Spacing	Starting Location Within Interval
		(μ sec)	(MHz)	(μ sec)	(μ sec)	(μ sec)
1	1	56	17			32097
2	2	75.2	17	1446.8		202501
3	2	79.1	17	1594.9		372874
4	1	54.1	17			544886
5	1	65.8	17			11064
6	2	80.4	17	1102.6		181560
7	3	86	17	1685	1290	351173
8	2	82.4	17	1445.6		522390
9	1	66.3	17			694725
10	3	95.8	17	970.2	1319.2	160367
11	3	85.6	17	1831.4	1791.4	329885
12	1	51	17			502809
13	1	64.7	17			673232
14	3	90.6	17	1053.4	1866.4	139129
15	1	53.4	17			310563
16	3	96.2	17	1065.8	1773.8	479259
17	1	65.5	17			652703
18						
19						
20						

Unless otherwise stated the results shown in this test report refer only to the sample(s) tested and such sample(s) are retained for 90 days only.

除非另有說明，此報告結果僅對測試之樣品負責，同時此樣品僅保留90天。本報告未經本公司書面許可，不可部份複製。

This document is issued by the Company subject to its General Conditions of Service printed overleaf, available on request or accessible at <http://www.sgs.com.tw/Terms-and-Conditions> and for electronic format documents, subject to Terms and Conditions for Electronic Documents at <http://www.sgs.com.tw/Terms-and-Conditions>. Attention is drawn to the limitation of liability, indemnification and jurisdiction issues defined therein. Any holder of this document is advised that information contained hereon reflects the Company's findings at the time of its intervention only and within the limits of Client's instructions, if any. The Company's sole responsibility is to its Client and this document does not exonerate parties to a transaction from exercising all their rights and obligations under the transaction documents. This document cannot be reproduced except in full, without prior written approval of the Company. Any unauthorized alteration, forgery or falsification of the content or appearance of this document is unlawful and offenders may be prosecuted to the fullest extent of the law.

Radar Type5_Trial3 for 5530MHz

Data Sheet for FCC Radar Type 5						
Trial Number:			3	VSG Frequency(MHz):		5530
Number of Bursts in Trial:			14	Successful Detection:		Yes
Burst (8-20)	Number Pulses per Burst (1-3)	Pulse Width (50-100)	Chirp Width (5-20)	Pulse 1-to-2 Spacing	Pulse 2-to-3 Spacing	Starting Location Within Interval
		(μ sec)	(MHz)	(μ sec)	(μ sec)	(μ sec)
1	2	75.2	13	1361.8		143969
2	3	90.7	13	1099.3	988.3	350947
3	3	93.8	13	1045.2	1043.2	557505
4	1	60.8	13			766524
5	3	98.2	13	1508.8	1876.8	118256
6	3	88.5	13	959.5	1339.5	325401
7	3	90.5	13	1857.5	1691.5	531589
8	2	74.6	13	957.4		740731
9	2	74.5	13	1040.5		92978
10	1	53.5	13			300652
11	3	89.7	13	1803.3	1110.3	506183
12	2	80.9	13	1738.1		714128
13	1	51.5	13			67556
14	2	80.4	13	1193.6		274857
15						
16						
17						
18						
19						
20						

Unless otherwise stated the results shown in this test report refer only to the sample(s) tested and such sample(s) are retained for 90 days only.

除非另有說明，此報告結果僅對測試之樣品負責，同時此樣品僅保留90天。本報告未經本公司書面許可，不可部份複製。

This document is issued by the Company subject to its General Conditions of Service printed overleaf, available on request or accessible at <http://www.sgs.com.tw/Terms-and-Conditions> and for electronic format documents, subject to Terms and Conditions for Electronic Documents at <http://www.sgs.com.tw/Terms-and-Conditions>. Attention is drawn to the limitation of liability, indemnification and jurisdiction issues defined therein. Any holder of this document is advised that information contained hereon reflects the Company's findings at the time of its intervention only and within the limits of Client's instructions, if any. The Company's sole responsibility is to its Client and this document does not exonerate parties to a transaction from exercising all their rights and obligations under the transaction documents. This document cannot be reproduced except in full, without prior written approval of the Company. Any unauthorized alteration, forgery or falsification of the content or appearance of this document is unlawful and offenders may be prosecuted to the fullest extent of the law.

Radar Type5_Trial4 for 5530MHz

Data Sheet for FCC Radar Type 5						
Trial Number:			4	VSG Frequency(MHz):		5530
Number of Bursts in Trial:			8	Successful Detection:		Yes
Burst (8-20)	Number Pulses per Burst (1-3)	Pulse Width (50-100)	Chirp Width (5-20)	Pulse 1-to-2 Spacing	Pulse 2-to-3 Spacing	Starting Location Within Interval
		(μ sec)	(MHz)	(μ sec)	(μ sec)	(μ sec)
1	1	59.8	5			845339
2	1	65.7	5			1208624
3	2	70.7	5	1208.3		73525
4	2	72.4	5	1543.6		436604
5	2	72.4	5	961.6		800038
6	1	58.8	5			1164144
7	2	72.8	5	1723.2		28791
8	3	86.7	5	1407.3	1824.3	391341
9						
10						
11						
12						
13						
14						
15						
16						
17						
18						
19						
20						

Unless otherwise stated the results shown in this test report refer only to the sample(s) tested and such sample(s) are retained for 90 days only.

除非另有說明，此報告結果僅對測試之樣品負責，同時此樣品僅保留90天。本報告未經本公司書面許可，不可部份複製。

This document is issued by the Company subject to its General Conditions of Service printed overleaf, available on request or accessible at <http://www.sgs.com.tw/Terms-and-Conditions> and for electronic format documents, subject to Terms and Conditions for Electronic Documents at <http://www.sgs.com.tw/Terms-and-Conditions>. Attention is drawn to the limitation of liability, indemnification and jurisdiction issues defined therein. Any holder of this document is advised that information contained hereon reflects the Company's findings at the time of its intervention only and within the limits of Client's instructions, if any. The Company's sole responsibility is to its Client and this document does not exonerate parties to a transaction from exercising all their rights and obligations under the transaction documents. This document cannot be reproduced except in full, without prior written approval of the Company. Any unauthorized alteration, forgery or falsification of the content or appearance of this document is unlawful and offenders may be prosecuted to the fullest extent of the law.

SGS Taiwan Ltd.

No.134,Wu Kung Road, New Taipei Industrial Park, Wuku District, New Taipei City, Taiwan/新北市五股區新北產業園區五工路 134 號

台灣檢驗科技股份有限公司

t (886-2) 2299-3279

f (886-2) 2298-0488

www.sgs.com.tw

Member of SGS Group

Radar Type5_Trial5 for 5530MHz

Data Sheet for FCC Radar Type 5						
Trial Number:			5	VSG Frequency(MHz):		5530
Number of Bursts in Trial:			8	Successful Detection:		Yes
Burst (8-20)	Number Pulses per Burst (1-3)	Pulse Width (50-100)	Chirp Width (5-20)	Pulse 1-to-2 Spacing	Pulse 2-to-3 Spacing	Starting Location Within Interval
		(μ sec)	(MHz)	(μ sec)	(μ sec)	(μ sec)
1	2	71.5	5	1024.5		755079
2	3	88	5	1905	1547	1116130
3	3	89.4	5	1595.6	1232.6	1479179
4	3	97.7	5	1549.3	1090.3	346877
5	1	65.8	5			710997
6	1	61.7	5			1074422
7	2	76.6	5	1387.4		1436084
8	3	96.5	5	1571.5	925.5	302135
9						
10						
11						
12						
13						
14						
15						
16						
17						
18						
19						
20						

Unless otherwise stated the results shown in this test report refer only to the sample(s) tested and such sample(s) are retained for 90 days only.

除非另有說明，此報告結果僅對測試之樣品負責，同時此樣品僅保留90天。本報告未經本公司書面許可，不可部份複製。

This document is issued by the Company subject to its General Conditions of Service printed overleaf, available on request or accessible at <http://www.sgs.com.tw/Terms-and-Conditions> and for electronic format documents, subject to Terms and Conditions for Electronic Documents at <http://www.sgs.com.tw/Terms-and-Conditions>. Attention is drawn to the limitation of liability, indemnification and jurisdiction issues defined therein. Any holder of this document is advised that information contained hereon reflects the Company's findings at the time of its intervention only and within the limits of Client's instructions, if any. The Company's sole responsibility is to its Client and this document does not exonerate parties to a transaction from exercising all their rights and obligations under the transaction documents. This document cannot be reproduced except in full, without prior written approval of the Company. Any unauthorized alteration, forgery or falsification of the content or appearance of this document is unlawful and offenders may be prosecuted to the fullest extent of the law.

Radar Type5_Trial6 for 5530MHz

Data Sheet for FCC Radar Type 5						
Trial Number:		6		VSG Frequency(MHz):		5530
Number of Bursts in Trial:			14		Successful Detection: Yes	
Burst (8-20)	Number Pulses per Burst (1-3)	Pulse Width (50-100)	Chirp Width (5-20)	Pulse 1-to-2 Spacing	Pulse 2-to-3 Spacing	Starting Location Within Interval
		(μ sec)	(MHz)	(μ sec)	(μ sec)	(μ sec)
1	3	97	12	1506	1903	378573
2	3	96.3	12	926.7	1064.7	586348
3	3	86.5	12	1416.5	964.5	793292
4	2	79.6	12	1505.4		146992
5	3	84	12	1459	1858	353209
6	3	85	12	1028	1539	560501
7	2	71	12	1692		767848
8	2	76	12	1081		121542
9	1	57.9	12			329085
10	3	86.7	12	1679.3	1245.3	535068
11	3	88.6	12	1154.4	1637.4	741864
12	2	79.5	12	1696.5		95986
13	3	91.3	12	1797.7	1841.7	302190
14	2	76.8	12	1755.2		510022
15						
16						
17						
18						
19						
20						

Unless otherwise stated the results shown in this test report refer only to the sample(s) tested and such sample(s) are retained for 90 days only.

除非另有說明，此報告結果僅對測試之樣品負責，同時此樣品僅保留90天。本報告未經本公司書面許可，不可部份複製。

This document is issued by the Company subject to its General Conditions of Service printed overleaf, available on request or accessible at <http://www.sgs.com.tw/Terms-and-Conditions> and for electronic format documents, subject to Terms and Conditions for Electronic Documents at <http://www.sgs.com.tw/Terms-and-Conditions>. Attention is drawn to the limitation of liability, indemnification and jurisdiction issues defined therein. Any holder of this document is advised that information contained hereon reflects the Company's findings at the time of its intervention only and within the limits of Client's instructions, if any. The Company's sole responsibility is to its Client and this document does not exonerate parties to a transaction from exercising all their rights and obligations under the transaction documents. This document cannot be reproduced except in full, without prior written approval of the Company. Any unauthorized alteration, forgery or falsification of the content or appearance of this document is unlawful and offenders may be prosecuted to the fullest extent of the law.

Radar Type5_Trial7 for 5530MHz

Data Sheet for FCC Radar Type 5						
Trial Number:			7		VSG Frequency(MHz): 5530	
Number of Bursts in Trial:			13		Successful Detection: Yes	
Burst (8-20)	Number Pulses per Burst (1-3)	Pulse Width (50-100)	Chirp Width (5-20)	Pulse 1-to-2 Spacing	Pulse 2-to-3 Spacing	Starting Location Within Interval
		(μ sec)	(MHz)	(μ sec)	(μ sec)	(μ sec)
1	3	96.4	11	1752.6	1109.6	771194
2	1	51.4	11			76092
3	1	64.8	11			299489
4	1	65.3	11			522832
5	2	75.7	11	1670.3		745337
6	3	85.4	11	1250.6	979.6	48408
7	3	94	11	1772	1352	270970
8	2	68.1	11	1265.9		494746
9	2	81	11	1161		717983
10	3	87.4	11	1328.6	1906.6	20904
11	3	92.8	11	1267.2	1676.2	243688
12	3	88.6	11	1875.4	1638.4	465906
13	2	69.2	11	1282.8		690603
14						
15						
16						
17						
18						
19						
20						

Unless otherwise stated the results shown in this test report refer only to the sample(s) tested and such sample(s) are retained for 90 days only.

除非另有說明，此報告結果僅對測試之樣品負責，同時此樣品僅保留90天。本報告未經本公司書面許可，不可部份複製。

This document is issued by the Company subject to its General Conditions of Service printed overleaf, available on request or accessible at <http://www.sgs.com.tw/Terms-and-Conditions> and for electronic format documents, subject to Terms and Conditions for Electronic Documents at <http://www.sgs.com.tw/Terms-and-Conditions>. Attention is drawn to the limitation of liability, indemnification and jurisdiction issues defined therein. Any holder of this document is advised that information contained hereon reflects the Company's findings at the time of its intervention only and within the limits of Client's instructions, if any. The Company's sole responsibility is to its Client and this document does not exonerate parties to a transaction from exercising all their rights and obligations under the transaction documents. This document cannot be reproduced except in full, without prior written approval of the Company. Any unauthorized alteration, forgery or falsification of the content or appearance of this document is unlawful and offenders may be prosecuted to the fullest extent of the law.

Radar Type5_Trial8 for 5530MHz

Data Sheet for FCC Radar Type 5						
Trial Number:		8		VSG Frequency(MHz):		5530
Number of Bursts in Trial:			11		Successful Detection: Yes	
Burst (8-20)	Number Pulses per Burst (1-3)	Pulse Width (50-100)	Chirp Width (5-20)	Pulse 1-to-2 Spacing	Pulse 2-to-3 Spacing	Starting Location Within Interval
		(μ sec)	(MHz)	(μ sec)	(μ sec)	(μ sec)
1	1	55.7	9			1081971
2	2	71.5	9	1428.5		256209
3	1	50.4	9			520922
4	2	72.7	9	1676.3		783872
5	2	78.8	9	1564.2		1047535
6	3	98	9	1686	1848	223101
7	2	78.1	9	1319.9		487378
8	1	56.6	9			752190
9	3	93.4	9	1339.6	1120.6	1013747
10	3	94.4	9	1471.6	1168.6	190967
11	2	71.9	9	1853.1		454777
12						
13						
14						
15						
16						
17						
18						
19						
20						

Unless otherwise stated the results shown in this test report refer only to the sample(s) tested and such sample(s) are retained for 90 days only.

除非另有說明，此報告結果僅對測試之樣品負責，同時此樣品僅保留90天。本報告未經本公司書面許可，不可部份複製。

This document is issued by the Company subject to its General Conditions of Service printed overleaf, available on request or accessible at <http://www.sgs.com.tw/Terms-and-Conditions> and for electronic format documents, subject to Terms and Conditions for Electronic Documents at <http://www.sgs.com.tw/Terms-and-Conditions>. Attention is drawn to the limitation of liability, indemnification and jurisdiction issues defined therein. Any holder of this document is advised that information contained hereon reflects the Company's findings at the time of its intervention only and within the limits of Client's instructions, if any. The Company's sole responsibility is to its Client and this document does not exonerate parties to a transaction from exercising all their rights and obligations under the transaction documents. This document cannot be reproduced except in full, without prior written approval of the Company. Any unauthorized alteration, forgery or falsification of the content or appearance of this document is unlawful and offenders may be prosecuted to the fullest extent of the law.

Radar Type5_Trial9 for 5530MHz

Data Sheet for FCC Radar Type 5						
Trial Number:			9		VSG Frequency(MHz): 5530	
Number of Bursts in Trial:			11		Successful Detection: Yes	
Burst (8-20)	Number Pulses per Burst (1-3)	Pulse Width (50-100)	Chirp Width (5-20)	Pulse 1-to-2 Spacing	Pulse 2-to-3 Spacing	Starting Location Within Interval
		(μ sec)	(MHz)	(μ sec)	(μ sec)	(μ sec)
1	3	96.5	8	1238.5	1767.5	717802
2	2	74.9	8	1820.1		982334
3	3	94.7	8	1012.3	1446.3	158509
4	3	94.8	8	1520.2	1653.2	421684
5	1	64.4	8			687423
6	3	85.8	8	960.2	1385.2	949648
7	2	70.2	8	1167.8		126134
8	3	93.3	8	943.7	1289.7	389725
9	3	95.4	8	1101.6	1896.6	652936
10	3	94.7	8	1841.3	1060.3	916384
11	3	91.7	8	1816.3	1181.3	93458
12						
13						
14						
15						
16						
17						
18						
19						
20						

Unless otherwise stated the results shown in this test report refer only to the sample(s) tested and such sample(s) are retained for 90 days only.

除非另有說明，此報告結果僅對測試之樣品負責，同時此樣品僅保留90天。本報告未經本公司書面許可，不可部份複製。

This document is issued by the Company subject to its General Conditions of Service printed overleaf, available on request or accessible at <http://www.sgs.com.tw/Terms-and-Conditions> and for electronic format documents, subject to Terms and Conditions for Electronic Documents at <http://www.sgs.com.tw/Terms-and-Conditions>. Attention is drawn to the limitation of liability, indemnification and jurisdiction issues defined therein. Any holder of this document is advised that information contained hereon reflects the Company's findings at the time of its intervention only and within the limits of Client's instructions, if any. The Company's sole responsibility is to its Client and this document does not exonerate parties to a transaction from exercising all their rights and obligations under the transaction documents. This document cannot be reproduced except in full, without prior written approval of the Company. Any unauthorized alteration, forgery or falsification of the content or appearance of this document is unlawful and offenders may be prosecuted to the fullest extent of the law.

Radar Type5_Trial10 for 5530MHz

Data Sheet for FCC Radar Type 5						
Trial Number:		10		VSG Frequency(MHz):		5530
Number of Bursts in Trial:			20		Successful Detection: Yes	
Burst (8-20)	Number Pulses per Burst (1-3)	Pulse Width (50-100)	Chirp Width (5-20)	Pulse 1-to-2 Spacing	Pulse 2-to-3 Spacing	Starting Location Within Interval
		(μ sec)	(MHz)	(μ sec)	(μ sec)	(μ sec)
1	3	87.9	20	1065.1	1054.1	195845
2	2	82.9	20	1649.1		340735
3	1	50.4	20			487164
4	3	86.1	20	1511.9	1327.9	33463
5	3	91.3	20	1333.7	1629.7	177985
6	1	52.4	20			324139
7	2	78.8	20	964.2		468273
8	1	65.2	20			15748
9	3	99.2	20	1105.8	1472.8	160137
10	3	86.9	20	1715.1	1671.1	304464
11	3	95.4	20	1764.6	1171.6	448919
12	1	65.8	20			596028
13	1	65.2	20			142978
14	1	54.5	20			287964
15	1	57.4	20			433443
16	1	64	20			578958
17	1	59.8	20			125123
18	2	81.5	20	1113.5		269660
19	1	63.1	20			415298
20	2	70.1	20	1113.9		559053

Unless otherwise stated the results shown in this test report refer only to the sample(s) tested and such sample(s) are retained for 90 days only.

除非另有說明，此報告結果僅對測試之樣品負責，同時此樣品僅保留90天。本報告未經本公司書面許可，不可部份複製。

This document is issued by the Company subject to its General Conditions of Service printed overleaf, available on request or accessible at <http://www.sgs.com.tw/Terms-and-Conditions> and for electronic format documents, subject to Terms and Conditions for Electronic Documents at <http://www.sgs.com.tw/Terms-and-Conditions>. Attention is drawn to the limitation of liability, indemnification and jurisdiction issues defined therein. Any holder of this document is advised that information contained hereon reflects the Company's findings at the time of its intervention only and within the limits of Client's instructions, if any. The Company's sole responsibility is to its Client and this document does not exonerate parties to a transaction from exercising all their rights and obligations under the transaction documents. This document cannot be reproduced except in full, without prior written approval of the Company. Any unauthorized alteration, forgery or falsification of the content or appearance of this document is unlawful and offenders may be prosecuted to the fullest extent of the law.

SGS Taiwan Ltd.

No.134,Wu Kung Road, New Taipei Industrial Park, Wuku District, New Taipei City, Taiwan/新北市五股區新北產業園區五工路 134 號

台灣檢驗科技股份有限公司

t (886-2) 2299-3279

f (886-2) 2298-0488

www.sgs.com.tw

Member of SGS Group

Radar Type5_Trial11 for 5530MHz

Data Sheet for FCC Radar Type 5						
Trial Number:		11		VSG Frequency(MHz):		5496.501
Number of Bursts in Trial:			15		Successful Detection: Yes	
Burst (8-20)	Number Pulses per Burst (1-3)	Pulse Width (50-100)	Chirp Width (5-20)	Pulse 1-to-2 Spacing	Pulse 2-to-3 Spacing	Starting Location Within Interval
		(μ sec)	(MHz)	(μ sec)	(μ sec)	(μ sec)
1	1	52.9	13			143103
2	1	57	13			336633
3	3	93	13	1786	1375	528454
4	2	68.8	13	1796.2		722576
5	1	50.7	13			119259
6	3	90.7	13	1150.3	1478.3	311911
7	3	99.3	13	1551.7	1326.7	504351
8	1	53.6	13			700354
9	3	95.3	13	1600.7	1466.7	95028
10	2	67.1	13	1419.9		288667
11	3	99.5	13	1883.5	1753.5	480592
12	3	93.2	13	1087.8	1551.8	673584
13	2	74.5	13	1562.5		71396
14	1	64.1	13			265211
15	3	83.6	13	1622.4	1038.4	457007
16						
17						
18						
19						
20						

Unless otherwise stated the results shown in this test report refer only to the sample(s) tested and such sample(s) are retained for 90 days only.

除非另有說明，此報告結果僅對測試之樣品負責，同時此樣品僅保留90天。本報告未經本公司書面許可，不可部份複製。

This document is issued by the Company subject to its General Conditions of Service printed overleaf, available on request or accessible at <http://www.sgs.com.tw/Terms-and-Conditions> and for electronic format documents, subject to Terms and Conditions for Electronic Documents at <http://www.sgs.com.tw/Terms-and-Conditions>. Attention is drawn to the limitation of liability, indemnification and jurisdiction issues defined therein. Any holder of this document is advised that information contained hereon reflects the Company's findings at the time of its intervention only and within the limits of Client's instructions, if any. The Company's sole responsibility is to its Client and this document does not exonerate parties to a transaction from exercising all their rights and obligations under the transaction documents. This document cannot be reproduced except in full, without prior written approval of the Company. Any unauthorized alteration, forgery or falsification of the content or appearance of this document is unlawful and offenders may be prosecuted to the fullest extent of the law.

Radar Type5_Trial12 for 5530MHz

Data Sheet for FCC Radar Type 5						
Trial Number:		12		VSG Frequency(MHz):		5494.501
Number of Bursts in Trial:			10		Successful Detection: Yes	
Burst (8-20)	Number Pulses per Burst (1-3)	Pulse Width (50-100)	Chirp Width (5-20)	Pulse 1-to-2 Spacing	Pulse 2-to-3 Spacing	Starting Location Within Interval
		(μ sec)	(MHz)	(μ sec)	(μ sec)	(μ sec)
1	2	67.5	8	1366.5		978633
2	2	72.3	8	1722.7		71453
3	3	92.8	8	1745.2	1601.2	361200
4	1	56.7	8			653086
5	2	75.7	8	1346.3		942117
6	2	77.9	8	1602.1		35724
7	2	78.1	8	933.9		326175
8	3	95.3	8	1766.7	1165.7	615613
9	3	85.1	8	1363.9	1704.9	905273
10	1	51.1	8			1198252
11						
12						
13						
14						
15						
16						
17						
18						
19						
20						

Unless otherwise stated the results shown in this test report refer only to the sample(s) tested and such sample(s) are retained for 90 days only.

除非另有說明，此報告結果僅對測試之樣品負責，同時此樣品僅保留90天。本報告未經本公司書面許可，不可部份複製。

This document is issued by the Company subject to its General Conditions of Service printed overleaf, available on request or accessible at <http://www.sgs.com.tw/Terms-and-Conditions> and for electronic format documents, subject to Terms and Conditions for Electronic Documents at <http://www.sgs.com.tw/Terms-and-Conditions>. Attention is drawn to the limitation of liability, indemnification and jurisdiction issues defined therein. Any holder of this document is advised that information contained hereon reflects the Company's findings at the time of its intervention only and within the limits of Client's instructions, if any. The Company's sole responsibility is to its Client and this document does not exonerate parties to a transaction from exercising all their rights and obligations under the transaction documents. This document cannot be reproduced except in full, without prior written approval of the Company. Any unauthorized alteration, forgery or falsification of the content or appearance of this document is unlawful and offenders may be prosecuted to the fullest extent of the law.

SGS Taiwan Ltd.

No.134,Wu Kung Road, New Taipei Industrial Park, Wuku District, New Taipei City, Taiwan/新北市五股區新北產業園區五工路 134 號

台灣檢驗科技股份有限公司

t (886-2) 2299-3279

f (886-2) 2298-0488

www.sgs.com.tw

Member of SGS Group

Radar Type5_Trial13 for 5530MHz

Data Sheet for FCC Radar Type 5						
Trial Number:		13		VSG Frequency(MHz):		5497.701
Number of Bursts in Trial:			17		Successful Detection: Yes	
Burst (8-20)	Number Pulses per Burst (1-3)	Pulse Width (50-100)	Chirp Width (5-20)	Pulse 1-to-2 Spacing	Pulse 2-to-3 Spacing	Starting Location Within Interval
		(μ sec)	(MHz)	(μ sec)	(μ sec)	(μ sec)
1	1	59	16			170817
2	2	79.5	16	990.5		341357
3	3	90.3	16	1075.7	1220.7	510526
4	1	57	16			683467
5	2	71.8	16	1218.2		149404
6	1	60.4	16			320410
7	1	61.8	16			491519
8	2	82.3	16	1727.7		660636
9	2	74.5	16	1601.5		128495
10	3	88.7	16	975.3	1412.3	298307
11	2	80.8	16	1746.2		469475
12	3	90	16	1030	1551	638300
13	2	81.6	16	1088.4		107469
14	3	85.3	16	1827.7	1324.7	277145
15	1	50.6	16			449387
16	1	53.2	16			620125
17	2	75.1	16	1843.9		86364
18						
19						
20						

Unless otherwise stated the results shown in this test report refer only to the sample(s) tested and such sample(s) are retained for 90 days only.

除非另有說明，此報告結果僅對測試之樣品負責，同時此樣品僅保留90天。本報告未經本公司書面許可，不可部份複製。

This document is issued by the Company subject to its General Conditions of Service printed overleaf, available on request or accessible at <http://www.sgs.com.tw/Terms-and-Conditions> and for electronic format documents, subject to Terms and Conditions for Electronic Documents at <http://www.sgs.com.tw/Terms-and-Conditions>. Attention is drawn to the limitation of liability, indemnification and jurisdiction issues defined therein. Any holder of this document is advised that information contained hereon reflects the Company's findings at the time of its intervention only and within the limits of Client's instructions, if any. The Company's sole responsibility is to its Client and this document does not exonerate parties to a transaction from exercising all their rights and obligations under the transaction documents. This document cannot be reproduced except in full, without prior written approval of the Company. Any unauthorized alteration, forgery or falsification of the content or appearance of this document is unlawful and offenders may be prosecuted to the fullest extent of the law.

Radar Type5_Trial14 for 5530MHz

Data Sheet for FCC Radar Type 5						
Trial Number:		14		VSG Frequency(MHz):		5499.301
Number of Bursts in Trial:			20		Successful Detection: Yes	
Burst (8-20)	Number Pulses per Burst (1-3)	Pulse Width (50-100)	Chirp Width (5-20)	Pulse 1-to-2 Spacing	Pulse 2-to-3 Spacing	Starting Location Within Interval
		(μ sec)	(MHz)	(μ sec)	(μ sec)	(μ sec)
1	2	70	20	1015		218197
2	2	82	20	1063		363178
3	3	87.4	20	1016.6	1573.6	506900
4	1	52.2	20			55765
5	3	91.3	20	1392.7	1490.7	199823
6	1	51	20			346092
7	2	70.9	20	1197.1		490061
8	3	89.9	20	1240.1	1198.1	37702
9	3	91.8	20	1314.2	999.2	182230
10	2	67.1	20	1850.9		326990
11	2	74.7	20	1018.3		472340
12	3	87.5	20	916.5	1912.5	19883
13	3	92.3	20	1126.7	1650.7	164207
14	2	74.8	20	1634.2		309633
15	1	61.7	20			455707
16	1	57.8	20			2102
17	2	67.7	20	1674.3		146931
18	3	91.8	20	1452.2	1631.2	290728
19	1	61.1	20			437450
20	1	58.9	20			582293

Unless otherwise stated the results shown in this test report refer only to the sample(s) tested and such sample(s) are retained for 90 days only.

除非另有說明，此報告結果僅對測試之樣品負責，同時此樣品僅保留90天。本報告未經本公司書面許可，不可部份複製。

This document is issued by the Company subject to its General Conditions of Service printed overleaf, available on request or accessible at <http://www.sgs.com.tw/Terms-and-Conditions> and for electronic format documents, subject to Terms and Conditions for Electronic Documents at <http://www.sgs.com.tw/Terms-and-Conditions>. Attention is drawn to the limitation of liability, indemnification and jurisdiction issues defined therein. Any holder of this document is advised that information contained hereon reflects the Company's findings at the time of its intervention only and within the limits of Client's instructions, if any. The Company's sole responsibility is to its Client and this document does not exonerate parties to a transaction from exercising all their rights and obligations under the transaction documents. This document cannot be reproduced except in full, without prior written approval of the Company. Any unauthorized alteration, forgery or falsification of the content or appearance of this document is unlawful and offenders may be prosecuted to the fullest extent of the law.

SGS Taiwan Ltd.

No.134,Wu Kung Road, New Taipei Industrial Park, Wuku District, New Taipei City, Taiwan/新北市五股區新北產業園區五工路 134 號

台灣檢驗科技股份有限公司

t (886-2) 2299-3279

f (886-2) 2298-0488

www.sgs.com.tw

Member of SGS Group

Radar Type5_Trial15 for 5530MHz

Data Sheet for FCC Radar Type 5						
Trial Number:		15		VSG Frequency(MHz):		5497.301
Number of Bursts in Trial:			16		Successful Detection: Yes	
Burst (8-20)	Number Pulses per Burst (1-3)	Pulse Width (50-100)	Chirp Width (5-20)	Pulse 1-to-2 Spacing	Pulse 2-to-3 Spacing	Starting Location Within Interval
		(μ sec)	(MHz)	(μ sec)	(μ sec)	(μ sec)
1	3	96.7	15	1581.3	1271.3	161051
2	2	73.5	15	1917.5		342354
3	1	56.7	15			524731
4	3	87.7	15	1898.3	1496.3	703120
5	1	60.8	15			139360
6	3	100	15	1513	1072	319792
7	2	75.5	15	1704.5		501115
8	1	52.7	15			683650
9	2	77.6	15	1511.4		116904
10	3	90.7	15	1515.3	1368.3	297489
11	1	57.4	15			480050
12	1	56.1	15			661425
13	2	72.5	15	1240.5		94607
14	1	52.8	15			276358
15	1	58.1	15			458076
16	1	63.3	15			639282
17						
18						
19						
20						

Unless otherwise stated the results shown in this test report refer only to the sample(s) tested and such sample(s) are retained for 90 days only.

除非另有說明，此報告結果僅對測試之樣品負責，同時此樣品僅保留90天。本報告未經本公司書面許可，不可部份複製。

This document is issued by the Company subject to its General Conditions of Service printed overleaf, available on request or accessible at <http://www.sgs.com.tw/Terms-and-Conditions> and for electronic format documents, subject to Terms and Conditions for Electronic Documents at <http://www.sgs.com.tw/Terms-and-Conditions>. Attention is drawn to the limitation of liability, indemnification and jurisdiction issues defined therein. Any holder of this document is advised that information contained hereon reflects the Company's findings at the time of its intervention only and within the limits of Client's instructions, if any. The Company's sole responsibility is to its Client and this document does not exonerate parties to a transaction from exercising all their rights and obligations under the transaction documents. This document cannot be reproduced except in full, without prior written approval of the Company. Any unauthorized alteration, forgery or falsification of the content or appearance of this document is unlawful and offenders may be prosecuted to the fullest extent of the law.

Radar Type5_Trial16 for 5530MHz

Data Sheet for FCC Radar Type 5						
Trial Number:		16		VSG Frequency(MHz):		5498.901
Number of Bursts in Trial:			19		Successful Detection: Yes	
Burst (8-20)	Number Pulses per Burst (1-3)	Pulse Width (50-100)	Chirp Width (5-20)	Pulse 1-to-2 Spacing	Pulse 2-to-3 Spacing	Starting Location Within Interval
		(μ sec)	(MHz)	(μ sec)	(μ sec)	(μ sec)
1	3	97.8	19	1035.2	1109.2	60664
2	3	98.9	19	1349.1	1179.1	212758
3	2	67.7	19	1877.3		365185
4	2	78.4	19	1897.6		517638
5	2	69.3	19	1353.7		42020
6	2	67.1	19	1256.9		194546
7	2	80.1	19	1704.9		346961
8	3	93.4	19	935.6	1527.6	498702
9	3	87.1	19	1769.9	1303.9	23150
10	3	94.9	19	1043.1	1752.1	175148
11	2	82.3	19	1429.7		328193
12	1	63.8	19			481836
13	2	69	19	1717		4428
14	2	82.1	19	1509.9		156800
15	1	63.9	19			310290
16	3	93.6	19	1131.4	1715.4	460941
17	3	89.5	19	1035.5	927.5	613436
18	3	94.3	19	1285.7	1082.7	137818
19	2	78.4	19	1681.6		290315
20						

Unless otherwise stated the results shown in this test report refer only to the sample(s) tested and such sample(s) are retained for 90 days only.

除非另有說明，此報告結果僅對測試之樣品負責，同時此樣品僅保留90天。本報告未經本公司書面許可，不可部份複製。

This document is issued by the Company subject to its General Conditions of Service printed overleaf, available on request or accessible at <http://www.sgs.com.tw/Terms-and-Conditions> and for electronic format documents, subject to Terms and Conditions for Electronic Documents at <http://www.sgs.com.tw/Terms-and-Conditions>. Attention is drawn to the limitation of liability, indemnification and jurisdiction issues defined therein. Any holder of this document is advised that information contained hereon reflects the Company's findings at the time of its intervention only and within the limits of Client's instructions, if any. The Company's sole responsibility is to its Client and this document does not exonerate parties to a transaction from exercising all their rights and obligations under the transaction documents. This document cannot be reproduced except in full, without prior written approval of the Company. Any unauthorized alteration, forgery or falsification of the content or appearance of this document is unlawful and offenders may be prosecuted to the fullest extent of the law.

SGS Taiwan Ltd.

No.134,Wu Kung Road, New Taipei Industrial Park, Wuku District, New Taipei City, Taiwan/新北市五股區新北產業園區五工路 134 號

台灣檢驗科技股份有限公司

t (886-2) 2299-3279

f (886-2) 2298-0488

www.sgs.com.tw

Member of SGS Group

Radar Type5_Trial17 for 5530MHz

Data Sheet for FCC Radar Type 5						
Trial Number:		17		VSG Frequency(MHz):		5494.101
Number of Bursts in Trial:			10		Successful Detection: Yes	
Burst (8-20)	Number Pulses per Burst (1-3)	Pulse Width (50-100)	Chirp Width (5-20)	Pulse 1-to-2 Spacing	Pulse 2-to-3 Spacing	Starting Location Within Interval
		(μ sec)	(MHz)	(μ sec)	(μ sec)	(μ sec)
1	3	96.6	7	1648.4	1865.4	841832
2	2	75.3	7	1301.7		1134370
3	3	99.8	7	1691.2	928.2	226986
4	3	91.4	7	1351.6	1845.6	516768
5	3	91.3	7	1507.7	1109.7	806793
6	2	75.6	7	1497.4		1097643
7	2	68.2	7	1628.8		191388
8	1	62.3	7			482197
9	1	51	7			773239
10	1	59.6	7			1063311
11						
12						
13						
14						
15						
16						
17						
18						
19						
20						

Unless otherwise stated the results shown in this test report refer only to the sample(s) tested and such sample(s) are retained for 90 days only.

除非另有說明，此報告結果僅對測試之樣品負責，同時此樣品僅保留90天。本報告未經本公司書面許可，不可部份複製。

This document is issued by the Company subject to its General Conditions of Service printed overleaf, available on request or accessible at <http://www.sgs.com.tw/Terms-and-Conditions> and for electronic format documents, subject to Terms and Conditions for Electronic Documents at <http://www.sgs.com.tw/Terms-and-Conditions>. Attention is drawn to the limitation of liability, indemnification and jurisdiction issues defined therein. Any holder of this document is advised that information contained hereon reflects the Company's findings at the time of its intervention only and within the limits of Client's instructions, if any. The Company's sole responsibility is to its Client and this document does not exonerate parties to a transaction from exercising all their rights and obligations under the transaction documents. This document cannot be reproduced except in full, without prior written approval of the Company. Any unauthorized alteration, forgery or falsification of the content or appearance of this document is unlawful and offenders may be prosecuted to the fullest extent of the law.

Radar Type5_Trial18 for 5530MHz

Data Sheet for FCC Radar Type 5						
Trial Number:		18		VSG Frequency(MHz):		5496.501
Number of Bursts in Trial:			14		Successful Detection: Yes	
Burst (8-20)	Number Pulses per Burst (1-3)	Pulse Width (50-100)	Chirp Width (5-20)	Pulse 1-to-2 Spacing	Pulse 2-to-3 Spacing	Starting Location Within Interval
		(μ sec)	(MHz)	(μ sec)	(μ sec)	(μ sec)
1	2	68.6	13	1499.4		111159
2	1	64.9	13			318639
3	3	89.4	13	1225.6	1206.6	525016
4	2	66.7	13	1407.3		732895
5	3	98.5	13	1094.5	1290.5	85461
6	1	60.1	13			293098
7	2	68.9	13	1207.1		499889
8	2	74	13	1650		706709
9	2	82.7	13	937.3		60119
10	3	89.7	13	913.3	1511.3	266981
11	2	79.6	13	1323.4		474208
12	3	93.4	13	1709.6	922.6	680794
13	1	63.3	13			34618
14	1	50.5	13			242067
15						
16						
17						
18						
19						
20						

Unless otherwise stated the results shown in this test report refer only to the sample(s) tested and such sample(s) are retained for 90 days only.

除非另有說明，此報告結果僅對測試之樣品負責，同時此樣品僅保留90天。本報告未經本公司書面許可，不可部份複製。

This document is issued by the Company subject to its General Conditions of Service printed overleaf, available on request or accessible at <http://www.sgs.com.tw/Terms-and-Conditions> and for electronic format documents, subject to Terms and Conditions for Electronic Documents at <http://www.sgs.com.tw/Terms-and-Conditions>. Attention is drawn to the limitation of liability, indemnification and jurisdiction issues defined therein. Any holder of this document is advised that information contained hereon reflects the Company's findings at the time of its intervention only and within the limits of Client's instructions, if any. The Company's sole responsibility is to its Client and this document does not exonerate parties to a transaction from exercising all their rights and obligations under the transaction documents. This document cannot be reproduced except in full, without prior written approval of the Company. Any unauthorized alteration, forgery or falsification of the content or appearance of this document is unlawful and offenders may be prosecuted to the fullest extent of the law.

SGS Taiwan Ltd.

No.134,Wu Kung Road, New Taipei Industrial Park, Wuku District, New Taipei City, Taiwan/新北市五股區新北產業園區五工路 134 號

台灣檢驗科技股份有限公司

t (886-2) 2299-3279

f (886-2) 2298-0488

www.sgs.com.tw

Member of SGS Group

Radar Type5_Trial19 for 5530MHz

Data Sheet for FCC Radar Type 5						
Trial Number:		19		VSG Frequency(MHz):		5494.901
Number of Bursts in Trial:			11		Successful Detection: Yes	
Burst (8-20)	Number Pulses per Burst (1-3)	Pulse Width (50-100)	Chirp Width (5-20)	Pulse 1-to-2 Spacing	Pulse 2-to-3 Spacing	Starting Location Within Interval
		(μ sec)	(MHz)	(μ sec)	(μ sec)	(μ sec)
1	1	66	9			572486
2	2	67.7	9	1512.3		835382
3	1	61.6	9			11536
4	3	83.7	9	963.3	1336.3	275055
5	3	95.5	9	1832.5	1354.5	538089
6	2	76.8	9	1049.2		803017
7	1	63.9	9			1068197
8	2	66.7	9	1203.3		242891
9	2	78.3	9	998.7		507034
10	2	74.4	9	1755.6		770438
11	1	61.5	9			1035902
12						
13						
14						
15						
16						
17						
18						
19						
20						

Unless otherwise stated the results shown in this test report refer only to the sample(s) tested and such sample(s) are retained for 90 days only.

除非另有說明，此報告結果僅對測試之樣品負責，同時此樣品僅保留90天。本報告未經本公司書面許可，不可部份複製。

This document is issued by the Company subject to its General Conditions of Service printed overleaf, available on request or accessible at <http://www.sgs.com.tw/Terms-and-Conditions> and for electronic format documents, subject to Terms and Conditions for Electronic Documents at <http://www.sgs.com.tw/Terms-and-Conditions>. Attention is drawn to the limitation of liability, indemnification and jurisdiction issues defined therein. Any holder of this document is advised that information contained hereon reflects the Company's findings at the time of its intervention only and within the limits of Client's instructions, if any. The Company's sole responsibility is to its Client and this document does not exonerate parties to a transaction from exercising all their rights and obligations under the transaction documents. This document cannot be reproduced except in full, without prior written approval of the Company. Any unauthorized alteration, forgery or falsification of the content or appearance of this document is unlawful and offenders may be prosecuted to the fullest extent of the law.

SGS Taiwan Ltd.

No.134,Wu Kung Road, New Taipei Industrial Park, Wuku District, New Taipei City, Taiwan/新北市五股區新北產業園區五工路 134 號

台灣檢驗科技股份有限公司

t (886-2) 2299-3279

f (886-2) 2298-0488

www.sgs.com.tw

Member of SGS Group

Radar Type5_Trial20 for 5530MHz

Data Sheet for FCC Radar Type 5						
Trial Number:		20		VSG Frequency(MHz):		5497.701
Number of Bursts in Trial:			17		Successful Detection: Yes	
Burst (8-20)	Number Pulses per Burst (1-3)	Pulse Width (50-100)	Chirp Width (5-20)	Pulse 1-to-2 Spacing	Pulse 2-to-3 Spacing	Starting Location Within Interval
		(μ sec)	(MHz)	(μ sec)	(μ sec)	(μ sec)
1	3	88	16	1256	919	135783
2	3	98	16	1506	1371	305527
3	1	57.4	16			478186
4	2	76.4	16	1773.6		646724
5	1	52.8	16			115148
6	1	51	16			285926
7	1	54.8	16			456935
8	2	79	16	1222		626758
9	3	83.8	16	1125.2	1487.2	93692
10	2	68.5	16	1802.5		264129
11	2	79.9	16	1904.1		434598
12	3	92.9	16	1398.1	1123.1	604219
13	3	97.1	16	1045.9	1166.9	72856
14	2	70.6	16	1757.4		243445
15	2	72	16	1359		413877
16	3	95	16	1255	1652	582964
17	2	69.5	16	1837.5		51895
18						
19						
20						

Unless otherwise stated the results shown in this test report refer only to the sample(s) tested and such sample(s) are retained for 90 days only.

除非另有說明，此報告結果僅對測試之樣品負責，同時此樣品僅保留90天。本報告未經本公司書面許可，不可部份複製。

This document is issued by the Company subject to its General Conditions of Service printed overleaf, available on request or accessible at <http://www.sgs.com.tw/Terms-and-Conditions> and for electronic format documents, subject to Terms and Conditions for Electronic Documents at <http://www.sgs.com.tw/Terms-and-Conditions>. Attention is drawn to the limitation of liability, indemnification and jurisdiction issues defined therein. Any holder of this document is advised that information contained hereon reflects the Company's findings at the time of its intervention only and within the limits of Client's instructions, if any. The Company's sole responsibility is to its Client and this document does not exonerate parties to a transaction from exercising all their rights and obligations under the transaction documents. This document cannot be reproduced except in full, without prior written approval of the Company. Any unauthorized alteration, forgery or falsification of the content or appearance of this document is unlawful and offenders may be prosecuted to the fullest extent of the law.

Radar Type5_Trial21 for 5530MHz

Data Sheet for FCC Radar Type 5						
Trial Number:		21		VSG Frequency(MHz):		5566.299
Number of Bursts in Trial:			9		Successful Detection: Yes	
Burst (8-20)	Number Pulses per Burst (1-3)	Pulse Width (50-100)	Chirp Width (5-20)	Pulse 1-to-2 Spacing	Pulse 2-to-3 Spacing	Starting Location Within Interval
		(μ sec)	(MHz)	(μ sec)	(μ sec)	(μ sec)
1	1	56.7	6			421551
2	1	54.5	6			744478
3	3	98.9	6	1286.1	1719.1	1064529
4	1	53.1	6			58608
5	1	61.9	6			381621
6	3	99.2	6	1156.8	1217.8	703403
7	2	75.4	6	1653.6		1026298
8	2	73.6	6	1185.4		18794
9	1	64	6			341945
10						
11						
12						
13						
14						
15						
16						
17						
18						
19						
20						

Unless otherwise stated the results shown in this test report refer only to the sample(s) tested and such sample(s) are retained for 90 days only.

除非另有說明，此報告結果僅對測試之樣品負責，同時此樣品僅保留90天。本報告未經本公司書面許可，不可部份複製。

This document is issued by the Company subject to its General Conditions of Service printed overleaf, available on request or accessible at <http://www.sgs.com.tw/Terms-and-Conditions> and for electronic format documents, subject to Terms and Conditions for Electronic Documents at <http://www.sgs.com.tw/Terms-and-Conditions>. Attention is drawn to the limitation of liability, indemnification and jurisdiction issues defined therein. Any holder of this document is advised that information contained hereon reflects the Company's findings at the time of its intervention only and within the limits of Client's instructions, if any. The Company's sole responsibility is to its Client and this document does not exonerate parties to a transaction from exercising all their rights and obligations under the transaction documents. This document cannot be reproduced except in full, without prior written approval of the Company. Any unauthorized alteration, forgery or falsification of the content or appearance of this document is unlawful and offenders may be prosecuted to the fullest extent of the law.

SGS Taiwan Ltd.

No.134,Wu Kung Road, New Taipei Industrial Park, Wuku District, New Taipei City, Taiwan/新北市五股區新北產業園區五工路 134 號

台灣檢驗科技股份有限公司

t (886-2) 2299-3279

f (886-2) 2298-0488

www.sgs.com.tw

Member of SGS Group

Radar Type5_Trial22 for 5530MHz

Data Sheet for FCC Radar Type 5						
Trial Number:		22		VSG Frequency(MHz):		5563.499
Number of Bursts in Trial:			14		Successful Detection: Yes	
Burst (8-20)	Number Pulses per Burst (1-3)	Pulse Width (50-100)	Chirp Width (5-20)	Pulse 1-to-2 Spacing	Pulse 2-to-3 Spacing	Starting Location Within Interval
		(μ sec)	(MHz)	(μ sec)	(μ sec)	(μ sec)
1	3	84.5	13	1021.5	1628.5	425699
2	2	66.8	13	1144.2		633700
3	2	74.3	13	1140.7		840682
4	3	95.7	13	904.3	958.3	193640
5	1	51.9	13			401335
6	3	86.7	13	1253.3	1160.3	607151
7	1	64.9	13			816306
8	1	55.2	13			168523
9	1	60.5	13			376178
10	1	62.1	13			583300
11	1	61.4	13			791044
12	3	97.6	13	1516.4	1265.4	142362
13	2	79.9	13	1880.1		349568
14	3	88.6	13	1675.4	1030.4	556281
15						
16						
17						
18						
19						
20						

Unless otherwise stated the results shown in this test report refer only to the sample(s) tested and such sample(s) are retained for 90 days only.

除非另有說明，此報告結果僅對測試之樣品負責，同時此樣品僅保留90天。本報告未經本公司書面許可，不可部份複製。

This document is issued by the Company subject to its General Conditions of Service printed overleaf, available on request or accessible at <http://www.sgs.com.tw/Terms-and-Conditions> and for electronic format documents, subject to Terms and Conditions for Electronic Documents at <http://www.sgs.com.tw/Terms-and-Conditions>. Attention is drawn to the limitation of liability, indemnification and jurisdiction issues defined therein. Any holder of this document is advised that information contained hereon reflects the Company's findings at the time of its intervention only and within the limits of Client's instructions, if any. The Company's sole responsibility is to its Client and this document does not exonerate parties to a transaction from exercising all their rights and obligations under the transaction documents. This document cannot be reproduced except in full, without prior written approval of the Company. Any unauthorized alteration, forgery or falsification of the content or appearance of this document is unlawful and offenders may be prosecuted to the fullest extent of the law.

SGS Taiwan Ltd.

No.134,Wu Kung Road, New Taipei Industrial Park, Wuku District, New Taipei City, Taiwan/新北市五股區新北產業園區五工路 134 號

台灣檢驗科技股份有限公司

t (886-2) 2299-3279

f (886-2) 2298-0488

www.sgs.com.tw

Member of SGS Group

Radar Type5_Trial23 for 5530MHz

Data Sheet for FCC Radar Type 5						
Trial Number:		23		VSG Frequency(MHz):		5563.099
Number of Bursts in Trial:			15		Successful Detection: Yes	
Burst (8-20)	Number Pulses per Burst (1-3)	Pulse Width (50-100)	Chirp Width (5-20)	Pulse 1-to-2 Spacing	Pulse 2-to-3 Spacing	Starting Location Within Interval
		(μ sec)	(MHz)	(μ sec)	(μ sec)	(μ sec)
1	2	74.8	14	1903.2		712954
2	1	64.4	14			109577
3	2	79.6	14	947.4		302690
4	2	82.1	14	1141.9		496146
5	3	86.2	14	1236.8	989.8	688037
6	2	74.8	14	1243.2		85509
7	1	64.5	14			279236
8	1	63.1	14			472748
9	2	73.5	14	1362.5		665464
10	2	81.8	14	1385.2		61664
11	3	94.4	14	1855.6	961.6	254652
12	1	59.9	14			449055
13	2	73.7	14	1136.3		641555
14	2	75.6	14	1761.4		37890
15	1	58.4	14			231571
16						
17						
18						
19						
20						

Unless otherwise stated the results shown in this test report refer only to the sample(s) tested and such sample(s) are retained for 90 days only.

除非另有說明，此報告結果僅對測試之樣品負責，同時此樣品僅保留90天。本報告未經本公司書面許可，不可部份複製。

This document is issued by the Company subject to its General Conditions of Service printed overleaf, available on request or accessible at <http://www.sgs.com.tw/Terms-and-Conditions> and for electronic format documents, subject to Terms and Conditions for Electronic Documents at <http://www.sgs.com.tw/Terms-and-Conditions>. Attention is drawn to the limitation of liability, indemnification and jurisdiction issues defined therein. Any holder of this document is advised that information contained hereon reflects the Company's findings at the time of its intervention only and within the limits of Client's instructions, if any. The Company's sole responsibility is to its Client and this document does not exonerate parties to a transaction from exercising all their rights and obligations under the transaction documents. This document cannot be reproduced except in full, without prior written approval of the Company. Any unauthorized alteration, forgery or falsification of the content or appearance of this document is unlawful and offenders may be prosecuted to the fullest extent of the law.

SGS Taiwan Ltd.

No.134,Wu Kung Road, New Taipei Industrial Park, Wuku District, New Taipei City, Taiwan/新北市五股區新北產業園區五工路 134 號

台灣檢驗科技股份有限公司

t (886-2) 2299-3279

f (886-2) 2298-0488

www.sgs.com.tw

Member of SGS Group

Radar Type5_Trial24 for 5530MHz

Data Sheet for FCC Radar Type 5						
Trial Number:		24		VSG Frequency(MHz):		5566.299
Number of Bursts in Trial:			9		Successful Detection: Yes	
Burst (8-20)	Number Pulses per Burst (1-3)	Pulse Width (50-100)	Chirp Width (5-20)	Pulse 1-to-2 Spacing	Pulse 2-to-3 Spacing	Starting Location Within Interval
		(μ sec)	(MHz)	(μ sec)	(μ sec)	(μ sec)
1	2	76.1	6	1613.9		708682
2	3	98.8	6	973.2	1563.2	1030464
3	2	82.1	6	1484.9		23490
4	1	52.8	6			346421
5	3	88.9	6	1759.1	1530.1	667789
6	1	66.6	6			992268
7	3	88	6	1717	1899	1311409
8	1	54.6	6			306766
9	3	88.1	6	1901.9	1340.9	628217
10						
11						
12						
13						
14						
15						
16						
17						
18						
19						
20						

Unless otherwise stated the results shown in this test report refer only to the sample(s) tested and such sample(s) are retained for 90 days only.

除非另有說明，此報告結果僅對測試之樣品負責，同時此樣品僅保留90天。本報告未經本公司書面許可，不可部份複製。

This document is issued by the Company subject to its General Conditions of Service printed overleaf, available on request or accessible at <http://www.sgs.com.tw/Terms-and-Conditions> and for electronic format documents, subject to Terms and Conditions for Electronic Documents at <http://www.sgs.com.tw/Terms-and-Conditions>. Attention is drawn to the limitation of liability, indemnification and jurisdiction issues defined therein. Any holder of this document is advised that information contained hereon reflects the Company's findings at the time of its intervention only and within the limits of Client's instructions, if any. The Company's sole responsibility is to its Client and this document does not exonerate parties to a transaction from exercising all their rights and obligations under the transaction documents. This document cannot be reproduced except in full, without prior written approval of the Company. Any unauthorized alteration, forgery or falsification of the content or appearance of this document is unlawful and offenders may be prosecuted to the fullest extent of the law.

SGS Taiwan Ltd.

No.134,Wu Kung Road, New Taipei Industrial Park, Wuku District, New Taipei City, Taiwan/新北市五股區新北產業園區五工路 134 號

台灣檢驗科技股份有限公司

t (886-2) 2299-3279

f (886-2) 2298-0488

www.sgs.com.tw

Member of SGS Group

Radar Type5_Trial25 for 5530MHz

Data Sheet for FCC Radar Type 5						
Trial Number:		25		VSG Frequency(MHz):		5564.699
Number of Bursts in Trial:			12		Successful Detection: Yes	
Burst (8-20)	Number Pulses per Burst (1-3)	Pulse Width (50-100)	Chirp Width (5-20)	Pulse 1-to-2 Spacing	Pulse 2-to-3 Spacing	Starting Location Within Interval
		(μ sec)	(MHz)	(μ sec)	(μ sec)	(μ sec)
1	1	66.5	10			713981
2	3	93.2	10	1318.8	1383.8	954060
3	2	77.9	10	1604.1		199837
4	3	91.9	10	1294.1	1759.1	440713
5	1	60	10			684224
6	1	59.8	10			926991
7	3	83.6	10	1361.4	1524.4	169870
8	2	72	10	1008		411973
9	2	76.9	10	1546.1		653647
10	1	65.9	10			896784
11	2	74	10	1743		140278
12	3	88.8	10	1123.2	978.2	381664
13						
14						
15						
16						
17						
18						
19						
20						

Unless otherwise stated the results shown in this test report refer only to the sample(s) tested and such sample(s) are retained for 90 days only.

除非另有說明，此報告結果僅對測試之樣品負責，同時此樣品僅保留90天。本報告未經本公司書面許可，不可部份複製。

This document is issued by the Company subject to its General Conditions of Service printed overleaf, available on request or accessible at <http://www.sgs.com.tw/Terms-and-Conditions> and for electronic format documents, subject to Terms and Conditions for Electronic Documents at <http://www.sgs.com.tw/Terms-and-Conditions>. Attention is drawn to the limitation of liability, indemnification and jurisdiction issues defined therein. Any holder of this document is advised that information contained hereon reflects the Company's findings at the time of its intervention only and within the limits of Client's instructions, if any. The Company's sole responsibility is to its Client and this document does not exonerate parties to a transaction from exercising all their rights and obligations under the transaction documents. This document cannot be reproduced except in full, without prior written approval of the Company. Any unauthorized alteration, forgery or falsification of the content or appearance of this document is unlawful and offenders may be prosecuted to the fullest extent of the law.

Radar Type5_Trial26 for 5530MHz

Data Sheet for FCC Radar Type 5						
Trial Number:		26		VSG Frequency(MHz):		5563.099
Number of Bursts in Trial:			15		Successful Detection: Yes	
Burst (8-20)	Number Pulses per Burst (1-3)	Pulse Width (50-100)	Chirp Width (5-20)	Pulse 1-to-2 Spacing	Pulse 2-to-3 Spacing	Starting Location Within Interval
		(μ sec)	(MHz)	(μ sec)	(μ sec)	(μ sec)
1	2	82.4	14	1229.6		498536
2	2	67.1	14	1773.9		692019
3	3	89.3	14	1756.7	1617.7	88107
4	3	98.9	14	1600.1	1443.1	281127
5	3	99.5	14	1867.5	1028.5	474098
6	2	71.4	14	1023.6		668574
7	3	93.3	14	1751.7	1007.7	64396
8	3	92.6	14	1705.4	1299.4	257232
9	1	51.2	14			451923
10	3	92	14	1685	1843	642653
11	1	63	14			40796
12	3	89.4	14	1839.6	1564.6	233502
13	3	96.9	14	1282.1	1638.1	426399
14	3	84.5	14	1494.5	1024.5	619777
15	1	63.3	14			16934
16						
17						
18						
19						
20						

Unless otherwise stated the results shown in this test report refer only to the sample(s) tested and such sample(s) are retained for 90 days only.

除非另有說明，此報告結果僅對測試之樣品負責，同時此樣品僅保留90天。本報告未經本公司書面許可，不可部份複製。

This document is issued by the Company subject to its General Conditions of Service printed overleaf, available on request or accessible at <http://www.sgs.com.tw/Terms-and-Conditions> and for electronic format documents, subject to Terms and Conditions for Electronic Documents at <http://www.sgs.com.tw/Terms-and-Conditions>. Attention is drawn to the limitation of liability, indemnification and jurisdiction issues defined therein. Any holder of this document is advised that information contained hereon reflects the Company's findings at the time of its intervention only and within the limits of Client's instructions, if any. The Company's sole responsibility is to its Client and this document does not exonerate parties to a transaction from exercising all their rights and obligations under the transaction documents. This document cannot be reproduced except in full, without prior written approval of the Company. Any unauthorized alteration, forgery or falsification of the content or appearance of this document is unlawful and offenders may be prosecuted to the fullest extent of the law.

Radar Type5_Trial27 for 5530MHz

Data Sheet for FCC Radar Type 5						
Trial Number:		27		VSG Frequency(MHz):		5562.299
Number of Bursts in Trial:			17		Successful Detection: Yes	
Burst (8-20)	Number Pulses per Burst (1-3)	Pulse Width (50-100)	Chirp Width (5-20)	Pulse 1-to-2 Spacing	Pulse 2-to-3 Spacing	Starting Location Within Interval
		(μ sec)	(MHz)	(μ sec)	(μ sec)	(μ sec)
1	2	79.4	16	1554.6		185404
2	3	94.8	16	1571.2	1078.2	355243
3	3	91.1	16	1445.9	1467.9	524957
4	2	72	16	1706		696602
5	3	86.8	16	1170.2	1767.2	164009
6	1	59.7	16			335368
7	3	91.5	16	1447.5	1197.5	504553
8	1	65.5	16			677665
9	3	93	16	978	1696	143140
10	3	96.9	16	1185.1	1071.1	313396
11	2	72.6	16	976.4		484806
12	1	53	16			655886
13	1	63.7	16			122700
14	3	98.2	16	939.8	1156.8	292699
15	2	72.4	16	1661.6		463032
16	2	83.1	16	955.9		633961
17	1	57.7	16			101592
18						
19						
20						

Unless otherwise stated the results shown in this test report refer only to the sample(s) tested and such sample(s) are retained for 90 days only.

除非另有說明，此報告結果僅對測試之樣品負責，同時此樣品僅保留90天。本報告未經本公司書面許可，不可部份複製。

This document is issued by the Company subject to its General Conditions of Service printed overleaf, available on request or accessible at <http://www.sgs.com.tw/Terms-and-Conditions> and for electronic format documents, subject to Terms and Conditions for Electronic Documents at <http://www.sgs.com.tw/Terms-and-Conditions>. Attention is drawn to the limitation of liability, indemnification and jurisdiction issues defined therein. Any holder of this document is advised that information contained hereon reflects the Company's findings at the time of its intervention only and within the limits of Client's instructions, if any. The Company's sole responsibility is to its Client and this document does not exonerate parties to a transaction from exercising all their rights and obligations under the transaction documents. This document cannot be reproduced except in full, without prior written approval of the Company. Any unauthorized alteration, forgery or falsification of the content or appearance of this document is unlawful and offenders may be prosecuted to the fullest extent of the law.

SGS Taiwan Ltd.

No.134,Wu Kung Road, New Taipei Industrial Park, Wuku District, New Taipei City, Taiwan/新北市五股區新北產業園區五工路 134 號

台灣檢驗科技股份有限公司

t (886-2) 2299-3279

f (886-2) 2298-0488

www.sgs.com.tw

Member of SGS Group

Radar Type5_Trial28 for 5530MHz

Data Sheet for FCC Radar Type 5						
Trial Number:		28		VSG Frequency(MHz):		5562.699
Number of Bursts in Trial:			16		Successful Detection: Yes	
Burst (8-20)	Number Pulses per Burst (1-3)	Pulse Width (50-100)	Chirp Width (5-20)	Pulse 1-to-2 Spacing	Pulse 2-to-3 Spacing	Starting Location Within Interval
		(μ sec)	(MHz)	(μ sec)	(μ sec)	(μ sec)
1	1	51.6	15			289349
2	2	69.6	15	1249.4		470024
3	3	93.7	15	1041.3	1150.3	650118
4	2	81.7	15	1884.3		85378
5	3	92.9	15	1015.1	1041.1	266411
6	1	54	15			448486
7	3	89.4	15	1661.6	1625.6	627280
8	3	95.2	15	1199.8	1312.8	63036
9	3	94.8	15	1874.2	1264.2	243526
10	1	62	15			426457
11	3	86.8	15	1765.2	1300.2	605400
12	2	74.6	15	1030.4		40835
13	2	80.2	15	1433.8		221894
14	3	88.6	15	1584.4	1204.4	402325
15	3	95.1	15	1364.9	1513.9	582845
16	2	75.6	15	1550.4		18465
17						
18						
19						
20						

Unless otherwise stated the results shown in this test report refer only to the sample(s) tested and such sample(s) are retained for 90 days only.

除非另有說明，此報告結果僅對測試之樣品負責，同時此樣品僅保留90天。本報告未經本公司書面許可，不可部份複製。

This document is issued by the Company subject to its General Conditions of Service printed overleaf, available on request or accessible at <http://www.sgs.com.tw/Terms-and-Conditions> and for electronic format documents, subject to Terms and Conditions for Electronic Documents at <http://www.sgs.com.tw/Terms-and-Conditions>. Attention is drawn to the limitation of liability, indemnification and jurisdiction issues defined therein. Any holder of this document is advised that information contained hereon reflects the Company's findings at the time of its intervention only and within the limits of Client's instructions, if any. The Company's sole responsibility is to its Client and this document does not exonerate parties to a transaction from exercising all their rights and obligations under the transaction documents. This document cannot be reproduced except in full, without prior written approval of the Company. Any unauthorized alteration, forgery or falsification of the content or appearance of this document is unlawful and offenders may be prosecuted to the fullest extent of the law.

Radar Type5_Trial29 for 5530MHz

Data Sheet for FCC Radar Type 5						
Trial Number:		29		VSG Frequency(MHz):		5564.699
Number of Bursts in Trial:			12		Successful Detection: Yes	
Burst (8-20)	Number Pulses per Burst (1-3)	Pulse Width (50-100)	Chirp Width (5-20)	Pulse 1-to-2 Spacing	Pulse 2-to-3 Spacing	Starting Location Within Interval
		(μ sec)	(MHz)	(μ sec)	(μ sec)	(μ sec)
1	3	96.5	10	1604.5	1082.5	265973
2	1	54.2	10			509016
3	2	77.3	10	1263.7		749934
4	3	85.8	10	1593.2	1151.2	990734
5	3	93.9	10	920.1	1876.1	236405
6	3	87.2	10	999.8	1300.8	477860
7	2	79	10	980		720257
8	3	91	10	977	918	961256
9	1	51.6	10			207126
10	3	96.3	10	1180.7	1203.7	448163
11	1	51.9	10			691269
12	2	76.9	10	1126.1		932778
13						
14						
15						
16						
17						
18						
19						
20						

Unless otherwise stated the results shown in this test report refer only to the sample(s) tested and such sample(s) are retained for 90 days only.

除非另有說明，此報告結果僅對測試之樣品負責，同時此樣品僅保留90天。本報告未經本公司書面許可，不可部份複製。

This document is issued by the Company subject to its General Conditions of Service printed overleaf, available on request or accessible at <http://www.sgs.com.tw/Terms-and-Conditions> and for electronic format documents, subject to Terms and Conditions for Electronic Documents at <http://www.sgs.com.tw/Terms-and-Conditions>. Attention is drawn to the limitation of liability, indemnification and jurisdiction issues defined therein. Any holder of this document is advised that information contained hereon reflects the Company's findings at the time of its intervention only and within the limits of Client's instructions, if any. The Company's sole responsibility is to its Client and this document does not exonerate parties to a transaction from exercising all their rights and obligations under the transaction documents. This document cannot be reproduced except in full, without prior written approval of the Company. Any unauthorized alteration, forgery or falsification of the content or appearance of this document is unlawful and offenders may be prosecuted to the fullest extent of the law.

Radar Type5_Trial30 for 5530MHz

Data Sheet for FCC Radar Type 5						
Trial Number:		30		VSG Frequency(MHz):		5561.099
Number of Bursts in Trial:			19	Successful Detection:		Yes
Burst (8-20)	Number Pulses per Burst (1-3)	Pulse Width (50-100)	Chirp Width (5-20)	Pulse 1-to-2 Spacing	Pulse 2-to-3 Spacing	Starting Location Within Interval
		(μ sec)	(MHz)	(μ sec)	(μ sec)	(μ sec)
1	2	68.3	19	1287.7		111742
2	2	79.5	19	1375.5		263974
3	3	94.4	19	1371.6	1809.6	415412
4	2	78.9	19	1033.1		569750
5	1	58.9	19			93035
6	1	55.2	19			245758
7	3	87.8	19	1741.2	931.2	396617
8	2	77.2	19	1149.8		550426
9	3	90.8	19	1320.2	1427.2	73959
10	2	81.7	19	1204.3		226712
11	3	86.5	19	1320.5	1309.5	378328
12	3	90.7	19	1303.3	1374.3	530663
13	1	51.6	19			55500
14	2	76.9	19	1169.1		207885
15	3	92.1	19	1109.9	1723.9	359389
16	3	97.8	19	1590.2	1052.2	511380
17	1	54.6	19			36611
18	3	91	19	1234	1848	188355
19	1	62.7	19			342053
20						

Unless otherwise stated the results shown in this test report refer only to the sample(s) tested and such sample(s) are retained for 90 days only.

除非另有說明，此報告結果僅對測試之樣品負責，同時此樣品僅保留90天。本報告未經本公司書面許可，不可部份複製。

This document is issued by the Company subject to its General Conditions of Service printed overleaf, available on request or accessible at <http://www.sgs.com.tw/Terms-and-Conditions> and for electronic format documents, subject to Terms and Conditions for Electronic Documents at <http://www.sgs.com.tw/Terms-and-Conditions>. Attention is drawn to the limitation of liability, indemnification and jurisdiction issues defined therein. Any holder of this document is advised that information contained hereon reflects the Company's findings at the time of its intervention only and within the limits of Client's instructions, if any. The Company's sole responsibility is to its Client and this document does not exonerate parties to a transaction from exercising all their rights and obligations under the transaction documents. This document cannot be reproduced except in full, without prior written approval of the Company. Any unauthorized alteration, forgery or falsification of the content or appearance of this document is unlawful and offenders may be prosecuted to the fullest extent of the law.

SGS Taiwan Ltd.

No.134,Wu Kung Road, New Taipei Industrial Park, Wuku District, New Taipei City, Taiwan/新北市五股區新北產業園區五工路 134 號

台灣檢驗科技股份有限公司

t (886-2) 2299-3279

f (886-2) 2298-0488

www.sgs.com.tw

Member of SGS Group

Radar Type6 for 5530MHz

Data Sheet for FCC Radar Type 6

Trial	Pulse Width	PRI	Pulses per Hop	Hopping Rate	Hopping Sequence Length	Successful Detection
	(μ sec)	(μ sec)		(kHz)	(msec)	(Yes/No)
1	1	333	9	0.333	300	Yes
2	1	333	9	0.333	300	Yes
3	1	333	9	0.333	300	Yes
4	1	333	9	0.333	300	Yes
5	1	333	9	0.333	300	Yes
6	1	333	9	0.333	300	Yes
7	1	333	9	0.333	300	Yes
8	1	333	9	0.333	300	Yes
9	1	333	9	0.333	300	Yes
10	1	333	9	0.333	300	Yes
11	1	333	9	0.333	300	Yes
12	1	333	9	0.333	300	Yes
13	1	333	9	0.333	300	Yes
14	1	333	9	0.333	300	Yes
15	1	333	9	0.333	300	Yes
16	1	333	9	0.333	300	Yes
17	1	333	9	0.333	300	Yes
18	1	333	9	0.333	300	Yes
19	1	333	9	0.333	300	Yes
20	1	333	9	0.333	300	Yes
21	1	333	9	0.333	300	Yes
22	1	333	9	0.333	300	No
23	1	333	9	0.333	300	Yes
24	1	333	9	0.333	300	Yes
25	1	333	9	0.333	300	Yes
26	1	333	9	0.333	300	Yes
27	1	333	9	0.333	300	Yes
28	1	333	9	0.333	300	Yes
29	1	333	9	0.333	300	Yes
30	1	333	9	0.333	300	Yes

Unless otherwise stated the results shown in this test report refer only to the sample(s) tested and such sample(s) are retained for 90 days only.

除非另有說明，此報告結果僅對測試之樣品負責，同時此樣品僅保留90天。本報告未經本公司書面許可，不可部份複製。

This document is issued by the Company subject to its General Conditions of Service printed overleaf, available on request or accessible at <http://www.sgs.com.tw/Terms-and-Conditions> and for electronic format documents, subject to Terms and Conditions for Electronic Documents at <http://www.sgs.com.tw/Terms-and-Conditions>. Attention is drawn to the limitation of liability, indemnification and jurisdiction issues defined therein. Any holder of this document is advised that information contained hereon reflects the Company's findings at the time of its intervention only and within the limits of Client's instructions, if any. The Company's sole responsibility is to its Client and this document does not exonerate parties to a transaction from exercising all their rights and obligations under the transaction documents. This document cannot be reproduced except in full, without prior written approval of the Company. Any unauthorized alteration, forgery or falsification of the content or appearance of this document is unlawful and offenders may be prosecuted to the fullest extent of the law.

HE160_5250MHz

Short Pulse Radar Type	Minimum Number of Trials	Detection(%)		Minmum Percentage of Successful Detection(%)	Pass/Fail
1	30	96.67		60	Pass
2	30	100		60	Pass
3	30	100		60	Pass
4	30	100		60	Pass
Aggregate (Radar Types 1-4)	120	99.1675		80	Pass
Long Pulse Radar Type	Minimum Number of Trials	Each Detection(%)	Total Detection(%)	Minmum Percentage of Successful Detection(%)	Pass/Fail
5	Center:10	100	100	80	Pass
	Low Edge:10	100			
	High Edge:10	100			
Frequency Hopping Radar Type	Minimum Number of Trials	Detection(%)		Minmum Percentage of Successful Detection(%)	Pass/Fail
6	30	90		70	Pass

Unless otherwise stated the results shown in this test report refer only to the sample(s) tested and such sample(s) are retained for 90 days only.

除非另有說明，此報告結果僅對測試之樣品負責，同時此樣品僅保留90天。本報告未經本公司書面許可，不可部份複製。

This document is issued by the Company subject to its General Conditions of Service printed overleaf, available on request or accessible at <http://www.sgs.com.tw/Terms-and-Conditions> and for electronic format documents, subject to Terms and Conditions for Electronic Documents at <http://www.sgs.com.tw/Terms-and-Conditions>. Attention is drawn to the limitation of liability, indemnification and jurisdiction issues defined therein. Any holder of this document is advised that information contained hereon reflects the Company's findings at the time of its intervention only and within the limits of Client's instructions, if any. The Company's sole responsibility is to its Client and this document does not exonerate parties to a transaction from exercising all their rights and obligations under the transaction documents. This document cannot be reproduced except in full, without prior written approval of the Company. Any unauthorized alteration, forgery or falsification of the content or appearance of this document is unlawful and offenders may be prosecuted to the fullest extent of the law.

Radar Type1 for 5250MHz

Data Sheet for FCC Radar Type 1

Trial	VSG Frequency (MHz)	Pulse Repetition Frequency Number (1 to 23)	Pulse Repetition Frequency	PRI	Test A/B	Successful Detection
			(Pulses Per Second)	(msec)	A/B	(Yes/No)
1	5250	13	1319.3	758	A	Yes
2	5250	21	1089.3	918	A	Yes
3	5250	8	1519.8	658	A	Yes
4	5250	19	1139	878	A	Yes
5	5250	18	1165.5	858	A	Yes
6	5250	11	1392.8	718	A	No
7	5250	6	1618.1	618	A	Yes
8	5250	10	1432.7	698	A	Yes
9	5250	16	1222.5	818	A	Yes
10	5250	17	1193.3	838	A	Yes
11	5250	23	326.2	3066	A	Yes
12	5250	9	1474.9	678	A	Yes
13	5250	4	1730.1	578	A	Yes
14	5250	5	1672.2	598	A	Yes
15	5250	1	1930.5	518	A	Yes
16	5250	-	533.6	1874	B	Yes
17	5250	-	471.7	2120	B	Yes
18	5250	-	342.2	2922	B	Yes
19	5250	-	993	1007	B	Yes
20	5250	-	1257.9	795	B	Yes
21	5250	-	742.9	1346	B	Yes
22	5250	-	814.3	1228	B	Yes
23	5250	-	403.1	2481	B	Yes
24	5250	-	700.8	1427	B	Yes
25	5250	-	1831.5	546	B	Yes
26	5250	-	1251.6	799	B	Yes
27	5250	-	483.6	2068	B	Yes
28	5250	-	970.9	1030	B	Yes
29	5250	-	449.6	2224	B	Yes
30	5250	-	687.8	1454	B	Yes

Unless otherwise stated the results shown in this test report refer only to the sample(s) tested and such sample(s) are retained for 90 days only.

除非另有說明，此報告結果僅對測試之樣品負責，同時此樣品僅保留90天。本報告未經本公司書面許可，不可部份複製。

This document is issued by the Company subject to its General Conditions of Service printed overleaf, available on request or accessible at <http://www.sgs.com.tw/Terms-and-Conditions> and for electronic format documents, subject to Terms and Conditions for Electronic Documents at <http://www.sgs.com.tw/Terms-and-Conditions>. Attention is drawn to the limitation of liability, indemnification and jurisdiction issues defined therein. Any holder of this document is advised that information contained hereon reflects the Company's findings at the time of its intervention only and within the limits of Client's instructions, if any. The Company's sole responsibility is to its Client and this document does not exonerate parties to a transaction from exercising all their rights and obligations under the transaction documents. This document cannot be reproduced except in full, without prior written approval of the Company. Any unauthorized alteration, forgery or falsification of the content or appearance of this document is unlawful and offenders may be prosecuted to the fullest extent of the law.

SGS Taiwan Ltd.

No.134,Wu Kung Road, New Taipei Industrial Park, Wuku District, New Taipei City, Taiwan/新北市五股區新北產業園區五工路 134 號

台灣檢驗科技股份有限公司

t (886-2) 2299-3279

f (886-2) 2298-0488

www.sgs.com.tw

Member of SGS Group

Radar Type2 for 5250MHz

Data Sheet for FCC Radar Type 2

Trial	VSG Frequency (MHz)	Number Pulses per Burst (23-29)	Pulse Width (1-5)	PRI (150-230)	Successful Detection
			(μ s)	(μ s)	(Yes/No)
1	5250	29	4.9	195	Yes
2	5250	28	4.1	153	Yes
3	5250	26	3.2	151	Yes
4	5250	23	1.2	227	Yes
5	5250	23	1.1	179	Yes
6	5250	26	2.9	166	Yes
7	5250	26	2.7	174	Yes
8	5250	24	2.1	230	Yes
9	5250	24	1.9	180	Yes
10	5250	29	4.8	223	Yes
11	5250	26	3.2	193	Yes
12	5250	24	1.9	155	Yes
13	5250	28	4	187	Yes
14	5250	29	5	206	Yes
15	5250	27	3.6	220	Yes
16	5250	29	4.7	175	Yes
17	5250	24	1.7	204	Yes
18	5250	26	3.1	181	Yes
19	5250	25	2.2	228	Yes
20	5250	28	4	182	Yes
21	5250	23	1.4	198	Yes
22	5250	26	3	199	Yes
23	5250	27	3.3	152	Yes
24	5250	23	1.3	178	Yes
25	5250	25	2.2	207	Yes
26	5250	27	3.4	159	Yes
27	5250	28	3.9	225	Yes
28	5250	27	3.6	168	Yes
29	5250	25	2.3	177	Yes
30	5250	29	4.7	205	Yes

Unless otherwise stated the results shown in this test report refer only to the sample(s) tested and such sample(s) are retained for 90 days only.

除非另有說明，此報告結果僅對測試之樣品負責，同時此樣品僅保留90天。本報告未經本公司書面許可，不可部份複製。

This document is issued by the Company subject to its General Conditions of Service printed overleaf, available on request or accessible at <http://www.sgs.com.tw/Terms-and-Conditions> and for electronic format documents, subject to Terms and Conditions for Electronic Documents at <http://www.sgs.com.tw/Terms-and-Conditions>. Attention is drawn to the limitation of liability, indemnification and jurisdiction issues defined therein. Any holder of this document is advised that information contained hereon reflects the Company's findings at the time of its intervention only and within the limits of Client's instructions, if any. The Company's sole responsibility is to its Client and this document does not exonerate parties to a transaction from exercising all their rights and obligations under the transaction documents. This document cannot be reproduced except in full, without prior written approval of the Company. Any unauthorized alteration, forgery or falsification of the content or appearance of this document is unlawful and offenders may be prosecuted to the fullest extent of the law.

Radar Type3 for 5250MHz

Data Sheet for FCC Radar Type 3

Trial	VSG Frequency (MHz)	Number Pulses per Burst (16-18)	Pulse Width (6-10)	PRI (200-500)	Successful Detection
			(μ s)	(μ s)	(Yes/No)
1	5250	18	9.9	442	Yes
2	5250	18	9.1	499	Yes
3	5250	17	8.2	273	Yes
4	5250	16	6.2	338	Yes
5	5250	16	6.1	487	Yes
6	5250	17	7.9	420	Yes
7	5250	17	7.7	450	Yes
8	5250	16	7.1	339	Yes
9	5250	16	6.9	405	Yes
10	5250	18	9.8	223	Yes
11	5250	17	8.2	453	Yes
12	5250	16	6.9	417	Yes
13	5250	18	9	400	Yes
14	5250	18	10	498	Yes
15	5250	17	8.6	274	Yes
16	5250	18	9.7	431	Yes
17	5250	16	6.7	294	Yes
18	5250	17	8.1	203	Yes
19	5250	16	7.2	298	Yes
20	5250	18	9	473	Yes
21	5250	16	6.4	407	Yes
22	5250	17	8	258	Yes
23	5250	17	8.3	249	Yes
24	5250	16	6.3	446	Yes
25	5250	16	7.2	486	Yes
26	5250	17	8.4	480	Yes
27	5250	18	8.9	370	Yes
28	5250	17	8.6	348	Yes
29	5250	16	7.3	401	Yes
30	5250	18	9.7	264	Yes

Unless otherwise stated the results shown in this test report refer only to the sample(s) tested and such sample(s) are retained for 90 days only.

除非另有說明，此報告結果僅對測試之樣品負責，同時此樣品僅保留90天。本報告未經本公司書面許可，不可部份複製。

This document is issued by the Company subject to its General Conditions of Service printed overleaf, available on request or accessible at <http://www.sgs.com.tw/Terms-and-Conditions> and for electronic format documents, subject to Terms and Conditions for Electronic Documents at <http://www.sgs.com.tw/Terms-and-Conditions>. Attention is drawn to the limitation of liability, indemnification and jurisdiction issues defined therein. Any holder of this document is advised that information contained hereon reflects the Company's findings at the time of its intervention only and within the limits of Client's instructions, if any. The Company's sole responsibility is to its Client and this document does not exonerate parties to a transaction from exercising all their rights and obligations under the transaction documents. This document cannot be reproduced except in full, without prior written approval of the Company. Any unauthorized alteration, forgery or falsification of the content or appearance of this document is unlawful and offenders may be prosecuted to the fullest extent of the law.

Radar Type4 for 5250MHz

Data Sheet for FCC Radar Type 4

Trial	VSG Frequency (MHz)	Number Pulses per Burst (12-16)	Pulse Width (11-20)	PRI (200-500)	Successful Detection
			(μ s)	(μ s)	(Yes/No)
1	5250	16	19.6	442	Yes
2	5250	15	17.8	499	Yes
3	5250	14	15.8	273	Yes
4	5250	12	11.4	338	Yes
5	5250	12	11.3	487	Yes
6	5250	14	15.3	420	Yes
7	5250	14	14.9	450	Yes
8	5250	13	13.5	339	Yes
9	5250	13	13.1	405	Yes
10	5250	16	19.5	223	Yes
11	5250	14	16	453	Yes
12	5250	13	13	417	Yes
13	5250	15	17.8	400	Yes
14	5250	16	20	498	Yes
15	5250	15	16.9	274	Yes
16	5250	16	19.2	431	Yes
17	5250	12	12.6	294	Yes
18	5250	14	15.6	203	Yes
19	5250	13	13.6	298	Yes
20	5250	15	17.6	473	Yes
21	5250	12	12.1	407	Yes
22	5250	14	15.5	258	Yes
23	5250	14	16.2	249	Yes
24	5250	12	11.7	446	Yes
25	5250	13	13.8	486	Yes
26	5250	15	16.5	480	Yes
27	5250	15	17.5	370	Yes
28	5250	15	16.8	348	Yes
29	5250	13	13.9	401	Yes
30	5250	16	19.3	264	Yes

Unless otherwise stated the results shown in this test report refer only to the sample(s) tested and such sample(s) are retained for 90 days only.

除非另有說明，此報告結果僅對測試之樣品負責，同時此樣品僅保留90天。本報告未經本公司書面許可，不可部份複製。

This document is issued by the Company subject to its General Conditions of Service printed overleaf, available on request or accessible at <http://www.sgs.com.tw/Terms-and-Conditions> and for electronic format documents, subject to Terms and Conditions for Electronic Documents at <http://www.sgs.com.tw/Terms-and-Conditions>. Attention is drawn to the limitation of liability, indemnification and jurisdiction issues defined therein. Any holder of this document is advised that information contained hereon reflects the Company's findings at the time of its intervention only and within the limits of Client's instructions, if any. The Company's sole responsibility is to its Client and this document does not exonerate parties to a transaction from exercising all their rights and obligations under the transaction documents. This document cannot be reproduced except in full, without prior written approval of the Company. Any unauthorized alteration, forgery or falsification of the content or appearance of this document is unlawful and offenders may be prosecuted to the fullest extent of the law.

Radar Type5_Trial1 for 5250MHz

Data Sheet for FCC Radar Type 5						
Trial Number:		1		VSG Frequency(MHz):		5288.835
Number of Bursts in Trial:			20		Successful Detection: Yes	
Burst (8-20)	Number Pulses per Burst (1-3)	Pulse Width (50-100)	Chirp Width (5-20)	Pulse 1-to-2 Spacing	Pulse 2-to-3 Spacing	Starting Location Within Interval
		(μ sec)	(MHz)	(μ sec)	(μ sec)	(μ sec)
1	3	97.7	20	1034.3	1421.3	116141
2	3	87.9	20	1634.1	1463.1	260383
3	2	76.9	20	929.1		406435
4	1	52.4	20			552540
5	1	51.8	20			98818
6	2	74	20	1785		243337
7	2	71.7	20	1586.3		388146
8	1	64	20			534217
9	1	61.5	20			80882
10	3	97.3	20	912.7	1544.7	224944
11	2	77.7	20	1096.3		370763
12	1	61.1	20			516312
13	3	87.5	20	1260.5	1441.5	62728
14	3	99.7	20	1776.3	1284.3	207224
15	2	82.7	20	1140.3		352481
16	3	95.2	20	1213.8	1162.8	495985
17	1	59.1	20			45158
18	2	75.6	20	1041.4		189991
19	1	64.7	20			335648
20	3	86.8	20	918.2	1652.2	478439

Unless otherwise stated the results shown in this test report refer only to the sample(s) tested and such sample(s) are retained for 90 days only.

除非另有說明，此報告結果僅對測試之樣品負責，同時此樣品僅保留90天。本報告未經本公司書面許可，不可部份複製。

This document is issued by the Company subject to its General Conditions of Service printed overleaf, available on request or accessible at <http://www.sgs.com.tw/Terms-and-Conditions> and for electronic format documents, subject to Terms and Conditions for Electronic Documents at <http://www.sgs.com.tw/Terms-and-Conditions>. Attention is drawn to the limitation of liability, indemnification and jurisdiction issues defined therein. Any holder of this document is advised that information contained hereon reflects the Company's findings at the time of its intervention only and within the limits of Client's instructions, if any. The Company's sole responsibility is to its Client and this document does not exonerate parties to a transaction from exercising all their rights and obligations under the transaction documents. This document cannot be reproduced except in full, without prior written approval of the Company. Any unauthorized alteration, forgery or falsification of the content or appearance of this document is unlawful and offenders may be prosecuted to the fullest extent of the law.

Radar Type5_Trial2 for 5250MHz

Data Sheet for FCC Radar Type 5						
Trial Number:		2		VSG Frequency(MHz):		5288.835
Number of Bursts in Trial:			17		Successful Detection: Yes	
Burst (8-20)	Number Pulses per Burst (1-3)	Pulse Width (50-100)	Chirp Width (5-20)	Pulse 1-to-2 Spacing	Pulse 2-to-3 Spacing	Starting Location Within Interval
		(μ sec)	(MHz)	(μ sec)	(μ sec)	(μ sec)
1	1	56	17			32097
2	2	75.2	17	1446.8		202501
3	2	79.1	17	1594.9		372874
4	1	54.1	17			544886
5	1	65.8	17			11064
6	2	80.4	17	1102.6		181560
7	3	86	17	1685	1290	351173
8	2	82.4	17	1445.6		522390
9	1	66.3	17			694725
10	3	95.8	17	970.2	1319.2	160367
11	3	85.6	17	1831.4	1791.4	329885
12	1	51	17			502809
13	1	64.7	17			673232
14	3	90.6	17	1053.4	1866.4	139129
15	1	53.4	17			310563
16	3	96.2	17	1065.8	1773.8	479259
17	1	65.5	17			652703
18						
19						
20						

Unless otherwise stated the results shown in this test report refer only to the sample(s) tested and such sample(s) are retained for 90 days only.

除非另有說明，此報告結果僅對測試之樣品負責，同時此樣品僅保留90天。本報告未經本公司書面許可，不可部份複製。

This document is issued by the Company subject to its General Conditions of Service printed overleaf, available on request or accessible at <http://www.sgs.com.tw/Terms-and-Conditions> and for electronic format documents, subject to Terms and Conditions for Electronic Documents at <http://www.sgs.com.tw/Terms-and-Conditions>. Attention is drawn to the limitation of liability, indemnification and jurisdiction issues defined therein. Any holder of this document is advised that information contained hereon reflects the Company's findings at the time of its intervention only and within the limits of Client's instructions, if any. The Company's sole responsibility is to its Client and this document does not exonerate parties to a transaction from exercising all their rights and obligations under the transaction documents. This document cannot be reproduced except in full, without prior written approval of the Company. Any unauthorized alteration, forgery or falsification of the content or appearance of this document is unlawful and offenders may be prosecuted to the fullest extent of the law.

Radar Type5_Trial3 for 5250MHz

Data Sheet for FCC Radar Type 5						
Trial Number:		3		VSG Frequency(MHz):		5288.835
Number of Bursts in Trial:			14		Successful Detection: Yes	
Burst (8-20)	Number Pulses per Burst (1-3)	Pulse Width (50-100)	Chirp Width (5-20)	Pulse 1-to-2 Spacing	Pulse 2-to-3 Spacing	Starting Location Within Interval
		(μ sec)	(MHz)	(μ sec)	(μ sec)	(μ sec)
1	2	75.2	13	1361.8		143969
2	3	90.7	13	1099.3	988.3	350947
3	3	93.8	13	1045.2	1043.2	557505
4	1	60.8	13			766524
5	3	98.2	13	1508.8	1876.8	118256
6	3	88.5	13	959.5	1339.5	325401
7	3	90.5	13	1857.5	1691.5	531589
8	2	74.6	13	957.4		740731
9	2	74.5	13	1040.5		92978
10	1	53.5	13			300652
11	3	89.7	13	1803.3	1110.3	506183
12	2	80.9	13	1738.1		714128
13	1	51.5	13			67556
14	2	80.4	13	1193.6		274857
15						
16						
17						
18						
19						
20						

Unless otherwise stated the results shown in this test report refer only to the sample(s) tested and such sample(s) are retained for 90 days only.

除非另有說明，此報告結果僅對測試之樣品負責，同時此樣品僅保留90天。本報告未經本公司書面許可，不可部份複製。

This document is issued by the Company subject to its General Conditions of Service printed overleaf, available on request or accessible at <http://www.sgs.com.tw/Terms-and-Conditions> and for electronic format documents, subject to Terms and Conditions for Electronic Documents at <http://www.sgs.com.tw/Terms-and-Conditions>. Attention is drawn to the limitation of liability, indemnification and jurisdiction issues defined therein. Any holder of this document is advised that information contained hereon reflects the Company's findings at the time of its intervention only and within the limits of Client's instructions, if any. The Company's sole responsibility is to its Client and this document does not exonerate parties to a transaction from exercising all their rights and obligations under the transaction documents. This document cannot be reproduced except in full, without prior written approval of the Company. Any unauthorized alteration, forgery or falsification of the content or appearance of this document is unlawful and offenders may be prosecuted to the fullest extent of the law.

Radar Type5_Trial4 for 5250MHz

Data Sheet for FCC Radar Type 5						
Trial Number:		4		VSG Frequency(MHz):		5288.835
Number of Bursts in Trial:			8		Successful Detection: Yes	
Burst (8-20)	Number Pulses per Burst (1-3)	Pulse Width (50-100)	Chirp Width (5-20)	Pulse 1-to-2 Spacing	Pulse 2-to-3 Spacing	Starting Location Within Interval
		(μ sec)	(MHz)	(μ sec)	(μ sec)	(μ sec)
1	1	59.8	5			845339
2	1	65.7	5			1208624
3	2	70.7	5	1208.3		73525
4	2	72.4	5	1543.6		436604
5	2	72.4	5	961.6		800038
6	1	58.8	5			1164144
7	2	72.8	5	1723.2		28791
8	3	86.7	5	1407.3	1824.3	391341
9						
10						
11						
12						
13						
14						
15						
16						
17						
18						
19						
20						

Unless otherwise stated the results shown in this test report refer only to the sample(s) tested and such sample(s) are retained for 90 days only.

除非另有說明，此報告結果僅對測試之樣品負責，同時此樣品僅保留90天。本報告未經本公司書面許可，不可部份複製。

This document is issued by the Company subject to its General Conditions of Service printed overleaf, available on request or accessible at <http://www.sgs.com.tw/Terms-and-Conditions> and for electronic format documents, subject to Terms and Conditions for Electronic Documents at <http://www.sgs.com.tw/Terms-and-Conditions>. Attention is drawn to the limitation of liability, indemnification and jurisdiction issues defined therein. Any holder of this document is advised that information contained hereon reflects the Company's findings at the time of its intervention only and within the limits of Client's instructions, if any. The Company's sole responsibility is to its Client and this document does not exonerate parties to a transaction from exercising all their rights and obligations under the transaction documents. This document cannot be reproduced except in full, without prior written approval of the Company. Any unauthorized alteration, forgery or falsification of the content or appearance of this document is unlawful and offenders may be prosecuted to the fullest extent of the law.

Radar Type5_Trial5 for 5250MHz

Data Sheet for FCC Radar Type 5						
Trial Number:		5		VSG Frequency(MHz):		5288.835
Number of Bursts in Trial:			8		Successful Detection: Yes	
Burst (8-20)	Number Pulses per Burst (1-3)	Pulse Width (50-100)	Chirp Width (5-20)	Pulse 1-to-2 Spacing	Pulse 2-to-3 Spacing	Starting Location Within Interval
		(μ sec)	(MHz)	(μ sec)	(μ sec)	(μ sec)
1	2	71.5	5	1024.5		755079
2	3	88	5	1905	1547	1116130
3	3	89.4	5	1595.6	1232.6	1479179
4	3	97.7	5	1549.3	1090.3	346877
5	1	65.8	5			710997
6	1	61.7	5			1074422
7	2	76.6	5	1387.4		1436084
8	3	96.5	5	1571.5	925.5	302135
9						
10						
11						
12						
13						
14						
15						
16						
17						
18						
19						
20						

Unless otherwise stated the results shown in this test report refer only to the sample(s) tested and such sample(s) are retained for 90 days only.

除非另有說明，此報告結果僅對測試之樣品負責，同時此樣品僅保留90天。本報告未經本公司書面許可，不可部份複製。

This document is issued by the Company subject to its General Conditions of Service printed overleaf, available on request or accessible at <http://www.sgs.com.tw/Terms-and-Conditions> and for electronic format documents, subject to Terms and Conditions for Electronic Documents at <http://www.sgs.com.tw/Terms-and-Conditions>. Attention is drawn to the limitation of liability, indemnification and jurisdiction issues defined therein. Any holder of this document is advised that information contained hereon reflects the Company's findings at the time of its intervention only and within the limits of Client's instructions, if any. The Company's sole responsibility is to its Client and this document does not exonerate parties to a transaction from exercising all their rights and obligations under the transaction documents. This document cannot be reproduced except in full, without prior written approval of the Company. Any unauthorized alteration, forgery or falsification of the content or appearance of this document is unlawful and offenders may be prosecuted to the fullest extent of the law.

SGS Taiwan Ltd.

No.134,Wu Kung Road, New Taipei Industrial Park, Wuku District, New Taipei City, Taiwan/新北市五股區新北產業園區五工路 134 號

台灣檢驗科技股份有限公司

t (886-2) 2299-3279

f (886-2) 2298-0488

www.sgs.com.tw

Member of SGS Group

Radar Type5_Trial6 for 5250MHz

Data Sheet for FCC Radar Type 5						
Trial Number:		6		VSG Frequency(MHz):		5288.835
Number of Bursts in Trial:			14		Successful Detection: Yes	
Burst (8-20)	Number Pulses per Burst (1-3)	Pulse Width (50-100)	Chirp Width (5-20)	Pulse 1-to-2 Spacing	Pulse 2-to-3 Spacing	Starting Location Within Interval
		(μ sec)	(MHz)	(μ sec)	(μ sec)	(μ sec)
1	3	97	12	1506	1903	378573
2	3	96.3	12	926.7	1064.7	586348
3	3	86.5	12	1416.5	964.5	793292
4	2	79.6	12	1505.4		146992
5	3	84	12	1459	1858	353209
6	3	85	12	1028	1539	560501
7	2	71	12	1692		767848
8	2	76	12	1081		121542
9	1	57.9	12			329085
10	3	86.7	12	1679.3	1245.3	535068
11	3	88.6	12	1154.4	1637.4	741864
12	2	79.5	12	1696.5		95986
13	3	91.3	12	1797.7	1841.7	302190
14	2	76.8	12	1755.2		510022
15						
16						
17						
18						
19						
20						

Unless otherwise stated the results shown in this test report refer only to the sample(s) tested and such sample(s) are retained for 90 days only.

除非另有說明，此報告結果僅對測試之樣品負責，同時此樣品僅保留90天。本報告未經本公司書面許可，不可部份複製。

This document is issued by the Company subject to its General Conditions of Service printed overleaf, available on request or accessible at <http://www.sgs.com.tw/Terms-and-Conditions> and for electronic format documents, subject to Terms and Conditions for Electronic Documents at <http://www.sgs.com.tw/Terms-and-Conditions>. Attention is drawn to the limitation of liability, indemnification and jurisdiction issues defined therein. Any holder of this document is advised that information contained hereon reflects the Company's findings at the time of its intervention only and within the limits of Client's instructions, if any. The Company's sole responsibility is to its Client and this document does not exonerate parties to a transaction from exercising all their rights and obligations under the transaction documents. This document cannot be reproduced except in full, without prior written approval of the Company. Any unauthorized alteration, forgery or falsification of the content or appearance of this document is unlawful and offenders may be prosecuted to the fullest extent of the law.

Radar Type5_Trial7 for 5250MHz

Data Sheet for FCC Radar Type 5						
Trial Number:		7		VSG Frequency(MHz):		5288.835
Number of Bursts in Trial:			13		Successful Detection: Yes	
Burst (8-20)	Number Pulses per Burst (1-3)	Pulse Width (50-100)	Chirp Width (5-20)	Pulse 1-to-2 Spacing	Pulse 2-to-3 Spacing	Starting Location Within Interval
		(μ sec)	(MHz)	(μ sec)	(μ sec)	(μ sec)
1	3	96.4	11	1752.6	1109.6	771194
2	1	51.4	11			76092
3	1	64.8	11			299489
4	1	65.3	11			522832
5	2	75.7	11	1670.3		745337
6	3	85.4	11	1250.6	979.6	48408
7	3	94	11	1772	1352	270970
8	2	68.1	11	1265.9		494746
9	2	81	11	1161		717983
10	3	87.4	11	1328.6	1906.6	20904
11	3	92.8	11	1267.2	1676.2	243688
12	3	88.6	11	1875.4	1638.4	465906
13	2	69.2	11	1282.8		690603
14						
15						
16						
17						
18						
19						
20						

Unless otherwise stated the results shown in this test report refer only to the sample(s) tested and such sample(s) are retained for 90 days only.

除非另有說明，此報告結果僅對測試之樣品負責，同時此樣品僅保留90天。本報告未經本公司書面許可，不可部份複製。

This document is issued by the Company subject to its General Conditions of Service printed overleaf, available on request or accessible at <http://www.sgs.com.tw/Terms-and-Conditions> and for electronic format documents, subject to Terms and Conditions for Electronic Documents at <http://www.sgs.com.tw/Terms-and-Conditions>. Attention is drawn to the limitation of liability, indemnification and jurisdiction issues defined therein. Any holder of this document is advised that information contained hereon reflects the Company's findings at the time of its intervention only and within the limits of Client's instructions, if any. The Company's sole responsibility is to its Client and this document does not exonerate parties to a transaction from exercising all their rights and obligations under the transaction documents. This document cannot be reproduced except in full, without prior written approval of the Company. Any unauthorized alteration, forgery or falsification of the content or appearance of this document is unlawful and offenders may be prosecuted to the fullest extent of the law.

Radar Type5_Trial8 for 5250MHz

Data Sheet for FCC Radar Type 5						
Trial Number:		8		VSG Frequency(MHz):		5288.835
Number of Bursts in Trial:			11		Successful Detection: Yes	
Burst (8-20)	Number Pulses per Burst (1-3)	Pulse Width (50-100)	Chirp Width (5-20)	Pulse 1-to-2 Spacing	Pulse 2-to-3 Spacing	Starting Location Within Interval
		(μ sec)	(MHz)	(μ sec)	(μ sec)	(μ sec)
1	1	55.7	9			1081971
2	2	71.5	9	1428.5		256209
3	1	50.4	9			520922
4	2	72.7	9	1676.3		783872
5	2	78.8	9	1564.2		1047535
6	3	98	9	1686	1848	223101
7	2	78.1	9	1319.9		487378
8	1	56.6	9			752190
9	3	93.4	9	1339.6	1120.6	1013747
10	3	94.4	9	1471.6	1168.6	190967
11	2	71.9	9	1853.1		454777
12						
13						
14						
15						
16						
17						
18						
19						
20						

Unless otherwise stated the results shown in this test report refer only to the sample(s) tested and such sample(s) are retained for 90 days only.

除非另有說明，此報告結果僅對測試之樣品負責，同時此樣品僅保留90天。本報告未經本公司書面許可，不可部份複製。

This document is issued by the Company subject to its General Conditions of Service printed overleaf, available on request or accessible at <http://www.sgs.com.tw/Terms-and-Conditions> and for electronic format documents, subject to Terms and Conditions for Electronic Documents at <http://www.sgs.com.tw/Terms-and-Conditions>. Attention is drawn to the limitation of liability, indemnification and jurisdiction issues defined therein. Any holder of this document is advised that information contained hereon reflects the Company's findings at the time of its intervention only and within the limits of Client's instructions, if any. The Company's sole responsibility is to its Client and this document does not exonerate parties to a transaction from exercising all their rights and obligations under the transaction documents. This document cannot be reproduced except in full, without prior written approval of the Company. Any unauthorized alteration, forgery or falsification of the content or appearance of this document is unlawful and offenders may be prosecuted to the fullest extent of the law.

SGS Taiwan Ltd.

No.134,Wu Kung Road, New Taipei Industrial Park, Wuku District, New Taipei City, Taiwan/新北市五股區新北產業園區五工路 134 號

台灣檢驗科技股份有限公司

t (886-2) 2299-3279

f (886-2) 2298-0488

www.sgs.com.tw

Member of SGS Group

Radar Type5_Trial9 for 5250MHz

Data Sheet for FCC Radar Type 5						
Trial Number:		9		VSG Frequency(MHz):		5288.835
Number of Bursts in Trial:			11		Successful Detection: Yes	
Burst (8-20)	Number Pulses per Burst (1-3)	Pulse Width (50-100)	Chirp Width (5-20)	Pulse 1-to-2 Spacing	Pulse 2-to-3 Spacing	Starting Location Within Interval
		(μ sec)	(MHz)	(μ sec)	(μ sec)	(μ sec)
1	3	96.5	8	1238.5	1767.5	717802
2	2	74.9	8	1820.1		982334
3	3	94.7	8	1012.3	1446.3	158509
4	3	94.8	8	1520.2	1653.2	421684
5	1	64.4	8			687423
6	3	85.8	8	960.2	1385.2	949648
7	2	70.2	8	1167.8		126134
8	3	93.3	8	943.7	1289.7	389725
9	3	95.4	8	1101.6	1896.6	652936
10	3	94.7	8	1841.3	1060.3	916384
11	3	91.7	8	1816.3	1181.3	93458
12						
13						
14						
15						
16						
17						
18						
19						
20						

Unless otherwise stated the results shown in this test report refer only to the sample(s) tested and such sample(s) are retained for 90 days only.

除非另有說明，此報告結果僅對測試之樣品負責，同時此樣品僅保留90天。本報告未經本公司書面許可，不可部份複製。

This document is issued by the Company subject to its General Conditions of Service printed overleaf, available on request or accessible at <http://www.sgs.com.tw/Terms-and-Conditions> and for electronic format documents, subject to Terms and Conditions for Electronic Documents at <http://www.sgs.com.tw/Terms-and-Conditions>. Attention is drawn to the limitation of liability, indemnification and jurisdiction issues defined therein. Any holder of this document is advised that information contained hereon reflects the Company's findings at the time of its intervention only and within the limits of Client's instructions, if any. The Company's sole responsibility is to its Client and this document does not exonerate parties to a transaction from exercising all their rights and obligations under the transaction documents. This document cannot be reproduced except in full, without prior written approval of the Company. Any unauthorized alteration, forgery or falsification of the content or appearance of this document is unlawful and offenders may be prosecuted to the fullest extent of the law.

Radar Type5_Trial10 for 5250MHz

Data Sheet for FCC Radar Type 5						
Trial Number:		10		VSG Frequency(MHz):		5288.835
Number of Bursts in Trial:			20		Successful Detection: Yes	
Burst (8-20)	Number Pulses per Burst (1-3)	Pulse Width (50-100)	Chirp Width (5-20)	Pulse 1-to-2 Spacing	Pulse 2-to-3 Spacing	Starting Location Within Interval
		(μ sec)	(MHz)	(μ sec)	(μ sec)	(μ sec)
1	3	87.9	20	1065.1	1054.1	195845
2	2	82.9	20	1649.1		340735
3	1	50.4	20			487164
4	3	86.1	20	1511.9	1327.9	33463
5	3	91.3	20	1333.7	1629.7	177985
6	1	52.4	20			324139
7	2	78.8	20	964.2		468273
8	1	65.2	20			15748
9	3	99.2	20	1105.8	1472.8	160137
10	3	86.9	20	1715.1	1671.1	304464
11	3	95.4	20	1764.6	1171.6	448919
12	1	65.8	20			596028
13	1	65.2	20			142978
14	1	54.5	20			287964
15	1	57.4	20			433443
16	1	64	20			578958
17	1	59.8	20			125123
18	2	81.5	20	1113.5		269660
19	1	63.1	20			415298
20	2	70.1	20	1113.9		559053

Unless otherwise stated the results shown in this test report refer only to the sample(s) tested and such sample(s) are retained for 90 days only.

除非另有說明，此報告結果僅對測試之樣品負責，同時此樣品僅保留90天。本報告未經本公司書面許可，不可部份複製。

This document is issued by the Company subject to its General Conditions of Service printed overleaf, available on request or accessible at <http://www.sgs.com.tw/Terms-and-Conditions> and for electronic format documents, subject to Terms and Conditions for Electronic Documents at <http://www.sgs.com.tw/Terms-and-Conditions>. Attention is drawn to the limitation of liability, indemnification and jurisdiction issues defined therein. Any holder of this document is advised that information contained hereon reflects the Company's findings at the time of its intervention only and within the limits of Client's instructions, if any. The Company's sole responsibility is to its Client and this document does not exonerate parties to a transaction from exercising all their rights and obligations under the transaction documents. This document cannot be reproduced except in full, without prior written approval of the Company. Any unauthorized alteration, forgery or falsification of the content or appearance of this document is unlawful and offenders may be prosecuted to the fullest extent of the law.

SGS Taiwan Ltd.

No.134,Wu Kung Road, New Taipei Industrial Park, Wuku District, New Taipei City, Taiwan/新北市五股區新北產業園區五工路 134 號

台灣檢驗科技股份有限公司

t (886-2) 2299-3279

f (886-2) 2298-0488

www.sgs.com.tw

Member of SGS Group

Radar Type5_Trial11 for 5250MHz

Data Sheet for FCC Radar Type 5						
Trial Number:		11		VSG Frequency(MHz):		5255.2
Number of Bursts in Trial:			15		Successful Detection: Yes	
Burst (8-20)	Number Pulses per Burst (1-3)	Pulse Width (50-100)	Chirp Width (5-20)	Pulse 1-to-2 Spacing	Pulse 2-to-3 Spacing	Starting Location Within Interval
		(μ sec)	(MHz)	(μ sec)	(μ sec)	(μ sec)
1	1	52.9	13			143103
2	1	57	13			336633
3	3	93	13	1786	1375	528454
4	2	68.8	13	1796.2		722576
5	1	50.7	13			119259
6	3	90.7	13	1150.3	1478.3	311911
7	3	99.3	13	1551.7	1326.7	504351
8	1	53.6	13			700354
9	3	95.3	13	1600.7	1466.7	95028
10	2	67.1	13	1419.9		288667
11	3	99.5	13	1883.5	1753.5	480592
12	3	93.2	13	1087.8	1551.8	673584
13	2	74.5	13	1562.5		71396
14	1	64.1	13			265211
15	3	83.6	13	1622.4	1038.4	457007
16						
17						
18						
19						
20						

Unless otherwise stated the results shown in this test report refer only to the sample(s) tested and such sample(s) are retained for 90 days only.

除非另有說明，此報告結果僅對測試之樣品負責，同時此樣品僅保留90天。本報告未經本公司書面許可，不可部份複製。

This document is issued by the Company subject to its General Conditions of Service printed overleaf, available on request or accessible at <http://www.sgs.com.tw/Terms-and-Conditions> and for electronic format documents, subject to Terms and Conditions for Electronic Documents at <http://www.sgs.com.tw/Terms-and-Conditions>. Attention is drawn to the limitation of liability, indemnification and jurisdiction issues defined therein. Any holder of this document is advised that information contained hereon reflects the Company's findings at the time of its intervention only and within the limits of Client's instructions, if any. The Company's sole responsibility is to its Client and this document does not exonerate parties to a transaction from exercising all their rights and obligations under the transaction documents. This document cannot be reproduced except in full, without prior written approval of the Company. Any unauthorized alteration, forgery or falsification of the content or appearance of this document is unlawful and offenders may be prosecuted to the fullest extent of the law.

SGS Taiwan Ltd.

No.134,Wu Kung Road, New Taipei Industrial Park, Wuku District, New Taipei City, Taiwan/新北市五股區新北產業園區五工路 134 號

台灣檢驗科技股份有限公司

t (886-2) 2299-3279

f (886-2) 2298-0488

www.sgs.com.tw

Member of SGS Group

Radar Type5_Trial12 for 5250MHz

Data Sheet for FCC Radar Type 5						
Trial Number:		12		VSG Frequency(MHz):		5253.2
Number of Bursts in Trial:			10		Successful Detection: Yes	
Burst (8-20)	Number Pulses per Burst (1-3)	Pulse Width (50-100)	Chirp Width (5-20)	Pulse 1-to-2 Spacing	Pulse 2-to-3 Spacing	Starting Location Within Interval
		(μ sec)	(MHz)	(μ sec)	(μ sec)	(μ sec)
1	2	67.5	8	1366.5		978633
2	2	72.3	8	1722.7		71453
3	3	92.8	8	1745.2	1601.2	361200
4	1	56.7	8			653086
5	2	75.7	8	1346.3		942117
6	2	77.9	8	1602.1		35724
7	2	78.1	8	933.9		326175
8	3	95.3	8	1766.7	1165.7	615613
9	3	85.1	8	1363.9	1704.9	905273
10	1	51.1	8			1198252
11						
12						
13						
14						
15						
16						
17						
18						
19						
20						

Unless otherwise stated the results shown in this test report refer only to the sample(s) tested and such sample(s) are retained for 90 days only.

除非另有說明，此報告結果僅對測試之樣品負責，同時此樣品僅保留90天。本報告未經本公司書面許可，不可部份複製。

This document is issued by the Company subject to its General Conditions of Service printed overleaf, available on request or accessible at <http://www.sgs.com.tw/Terms-and-Conditions> and for electronic format documents, subject to Terms and Conditions for Electronic Documents at <http://www.sgs.com.tw/Terms-and-Conditions>. Attention is drawn to the limitation of liability, indemnification and jurisdiction issues defined therein. Any holder of this document is advised that information contained hereon reflects the Company's findings at the time of its intervention only and within the limits of Client's instructions, if any. The Company's sole responsibility is to its Client and this document does not exonerate parties to a transaction from exercising all their rights and obligations under the transaction documents. This document cannot be reproduced except in full, without prior written approval of the Company. Any unauthorized alteration, forgery or falsification of the content or appearance of this document is unlawful and offenders may be prosecuted to the fullest extent of the law.

SGS Taiwan Ltd.

No.134,Wu Kung Road, New Taipei Industrial Park, Wuku District, New Taipei City, Taiwan/新北市五股區新北產業園區五工路 134 號

台灣檢驗科技股份有限公司

t (886-2) 2299-3279

f (886-2) 2298-0488

www.sgs.com.tw

Member of SGS Group

Radar Type5_Trial13 for 5250MHz

Data Sheet for FCC Radar Type 5						
Trial Number:		13		VSG Frequency(MHz):		5256.4
Number of Bursts in Trial:			17		Successful Detection: Yes	
Burst (8-20)	Number Pulses per Burst (1-3)	Pulse Width (50-100)	Chirp Width (5-20)	Pulse 1-to-2 Spacing	Pulse 2-to-3 Spacing	Starting Location Within Interval
		(μ sec)	(MHz)	(μ sec)	(μ sec)	(μ sec)
1	1	59	16			170817
2	2	79.5	16	990.5		341357
3	3	90.3	16	1075.7	1220.7	510526
4	1	57	16			683467
5	2	71.8	16	1218.2		149404
6	1	60.4	16			320410
7	1	61.8	16			491519
8	2	82.3	16	1727.7		660636
9	2	74.5	16	1601.5		128495
10	3	88.7	16	975.3	1412.3	298307
11	2	80.8	16	1746.2		469475
12	3	90	16	1030	1551	638300
13	2	81.6	16	1088.4		107469
14	3	85.3	16	1827.7	1324.7	277145
15	1	50.6	16			449387
16	1	53.2	16			620125
17	2	75.1	16	1843.9		86364
18						
19						
20						

Unless otherwise stated the results shown in this test report refer only to the sample(s) tested and such sample(s) are retained for 90 days only.

除非另有說明，此報告結果僅對測試之樣品負責，同時此樣品僅保留90天。本報告未經本公司書面許可，不可部份複製。

This document is issued by the Company subject to its General Conditions of Service printed overleaf, available on request or accessible at <http://www.sgs.com.tw/Terms-and-Conditions> and for electronic format documents, subject to Terms and Conditions for Electronic Documents at <http://www.sgs.com.tw/Terms-and-Conditions>. Attention is drawn to the limitation of liability, indemnification and jurisdiction issues defined therein. Any holder of this document is advised that information contained hereon reflects the Company's findings at the time of its intervention only and within the limits of Client's instructions, if any. The Company's sole responsibility is to its Client and this document does not exonerate parties to a transaction from exercising all their rights and obligations under the transaction documents. This document cannot be reproduced except in full, without prior written approval of the Company. Any unauthorized alteration, forgery or falsification of the content or appearance of this document is unlawful and offenders may be prosecuted to the fullest extent of the law.

Radar Type5_Trial14 for 5250MHz

Data Sheet for FCC Radar Type 5						
Trial Number:		14		VSG Frequency(MHz):		5258
Number of Bursts in Trial:			20		Successful Detection: Yes	
Burst (8-20)	Number Pulses per Burst (1-3)	Pulse Width (50-100)	Chirp Width (5-20)	Pulse 1-to-2 Spacing	Pulse 2-to-3 Spacing	Starting Location Within Interval
		(μ sec)	(MHz)	(μ sec)	(μ sec)	(μ sec)
1	2	70	20	1015		218197
2	2	82	20	1063		363178
3	3	87.4	20	1016.6	1573.6	506900
4	1	52.2	20			55765
5	3	91.3	20	1392.7	1490.7	199823
6	1	51	20			346092
7	2	70.9	20	1197.1		490061
8	3	89.9	20	1240.1	1198.1	37702
9	3	91.8	20	1314.2	999.2	182230
10	2	67.1	20	1850.9		326990
11	2	74.7	20	1018.3		472340
12	3	87.5	20	916.5	1912.5	19883
13	3	92.3	20	1126.7	1650.7	164207
14	2	74.8	20	1634.2		309633
15	1	61.7	20			455707
16	1	57.8	20			2102
17	2	67.7	20	1674.3		146931
18	3	91.8	20	1452.2	1631.2	290728
19	1	61.1	20			437450
20	1	58.9	20			582293

Unless otherwise stated the results shown in this test report refer only to the sample(s) tested and such sample(s) are retained for 90 days only.

除非另有說明，此報告結果僅對測試之樣品負責，同時此樣品僅保留90天。本報告未經本公司書面許可，不可部份複製。

This document is issued by the Company subject to its General Conditions of Service printed overleaf, available on request or accessible at <http://www.sgs.com.tw/Terms-and-Conditions> and for electronic format documents, subject to Terms and Conditions for Electronic Documents at <http://www.sgs.com.tw/Terms-and-Conditions>. Attention is drawn to the limitation of liability, indemnification and jurisdiction issues defined therein. Any holder of this document is advised that information contained hereon reflects the Company's findings at the time of its intervention only and within the limits of Client's instructions, if any. The Company's sole responsibility is to its Client and this document does not exonerate parties to a transaction from exercising all their rights and obligations under the transaction documents. This document cannot be reproduced except in full, without prior written approval of the Company. Any unauthorized alteration, forgery or falsification of the content or appearance of this document is unlawful and offenders may be prosecuted to the fullest extent of the law.

SGS Taiwan Ltd.

No.134,Wu Kung Road, New Taipei Industrial Park, Wuku District, New Taipei City, Taiwan/新北市五股區新北產業園區五工路 134 號

台灣檢驗科技股份有限公司

t (886-2) 2299-3279

f (886-2) 2298-0488

www.sgs.com.tw

Member of SGS Group

Radar Type5_Trial15 for 5250MHz

Data Sheet for FCC Radar Type 5						
Trial Number:		15		VSG Frequency(MHz):		5256
Number of Bursts in Trial:			16		Successful Detection: Yes	
Burst (8-20)	Number Pulses per Burst (1-3)	Pulse Width (50-100)	Chirp Width (5-20)	Pulse 1-to-2 Spacing	Pulse 2-to-3 Spacing	Starting Location Within Interval
		(μ sec)	(MHz)	(μ sec)	(μ sec)	(μ sec)
1	3	96.7	15	1581.3	1271.3	161051
2	2	73.5	15	1917.5		342354
3	1	56.7	15			524731
4	3	87.7	15	1898.3	1496.3	703120
5	1	60.8	15			139360
6	3	100	15	1513	1072	319792
7	2	75.5	15	1704.5		501115
8	1	52.7	15			683650
9	2	77.6	15	1511.4		116904
10	3	90.7	15	1515.3	1368.3	297489
11	1	57.4	15			480050
12	1	56.1	15			661425
13	2	72.5	15	1240.5		94607
14	1	52.8	15			276358
15	1	58.1	15			458076
16	1	63.3	15			639282
17						
18						
19						
20						

Unless otherwise stated the results shown in this test report refer only to the sample(s) tested and such sample(s) are retained for 90 days only.

除非另有說明，此報告結果僅對測試之樣品負責，同時此樣品僅保留90天。本報告未經本公司書面許可，不可部份複製。

This document is issued by the Company subject to its General Conditions of Service printed overleaf, available on request or accessible at <http://www.sgs.com.tw/Terms-and-Conditions> and for electronic format documents, subject to Terms and Conditions for Electronic Documents at <http://www.sgs.com.tw/Terms-and-Conditions>. Attention is drawn to the limitation of liability, indemnification and jurisdiction issues defined therein. Any holder of this document is advised that information contained hereon reflects the Company's findings at the time of its intervention only and within the limits of Client's instructions, if any. The Company's sole responsibility is to its Client and this document does not exonerate parties to a transaction from exercising all their rights and obligations under the transaction documents. This document cannot be reproduced except in full, without prior written approval of the Company. Any unauthorized alteration, forgery or falsification of the content or appearance of this document is unlawful and offenders may be prosecuted to the fullest extent of the law.

SGS Taiwan Ltd.

No.134,Wu Kung Road, New Taipei Industrial Park, Wuku District, New Taipei City, Taiwan/新北市五股區新北產業園區五工路 134 號

台灣檢驗科技股份有限公司

t (886-2) 2299-3279

f (886-2) 2298-0488

www.sgs.com.tw

Member of SGS Group

Radar Type5_Trial16 for 5250MHz

Data Sheet for FCC Radar Type 5						
Trial Number:		16		VSG Frequency(MHz):		5257.6
Number of Bursts in Trial:			19		Successful Detection: Yes	
Burst (8-20)	Number Pulses per Burst (1-3)	Pulse Width (50-100)	Chirp Width (5-20)	Pulse 1-to-2 Spacing	Pulse 2-to-3 Spacing	Starting Location Within Interval
		(μ sec)	(MHz)	(μ sec)	(μ sec)	(μ sec)
1	3	97.8	19	1035.2	1109.2	60664
2	3	98.9	19	1349.1	1179.1	212758
3	2	67.7	19	1877.3		365185
4	2	78.4	19	1897.6		517638
5	2	69.3	19	1353.7		42020
6	2	67.1	19	1256.9		194546
7	2	80.1	19	1704.9		346961
8	3	93.4	19	935.6	1527.6	498702
9	3	87.1	19	1769.9	1303.9	23150
10	3	94.9	19	1043.1	1752.1	175148
11	2	82.3	19	1429.7		328193
12	1	63.8	19			481836
13	2	69	19	1717		4428
14	2	82.1	19	1509.9		156800
15	1	63.9	19			310290
16	3	93.6	19	1131.4	1715.4	460941
17	3	89.5	19	1035.5	927.5	613436
18	3	94.3	19	1285.7	1082.7	137818
19	2	78.4	19	1681.6		290315
20						

Unless otherwise stated the results shown in this test report refer only to the sample(s) tested and such sample(s) are retained for 90 days only.

除非另有說明，此報告結果僅對測試之樣品負責，同時此樣品僅保留90天。本報告未經本公司書面許可，不可部份複製。

This document is issued by the Company subject to its General Conditions of Service printed overleaf, available on request or accessible at <http://www.sgs.com.tw/Terms-and-Conditions> and for electronic format documents, subject to Terms and Conditions for Electronic Documents at <http://www.sgs.com.tw/Terms-and-Conditions>. Attention is drawn to the limitation of liability, indemnification and jurisdiction issues defined therein. Any holder of this document is advised that information contained hereon reflects the Company's findings at the time of its intervention only and within the limits of Client's instructions, if any. The Company's sole responsibility is to its Client and this document does not exonerate parties to a transaction from exercising all their rights and obligations under the transaction documents. This document cannot be reproduced except in full, without prior written approval of the Company. Any unauthorized alteration, forgery or falsification of the content or appearance of this document is unlawful and offenders may be prosecuted to the fullest extent of the law.

Radar Type5_Trial17 for 5250MHz

Data Sheet for FCC Radar Type 5						
Trial Number:		17		VSG Frequency(MHz):		5252.8
Number of Bursts in Trial:			10		Successful Detection: Yes	
Burst (8-20)	Number Pulses per Burst (1-3)	Pulse Width (50-100)	Chirp Width (5-20)	Pulse 1-to-2 Spacing	Pulse 2-to-3 Spacing	Starting Location Within Interval
		(μ sec)	(MHz)	(μ sec)	(μ sec)	(μ sec)
1	3	96.6	7	1648.4	1865.4	841832
2	2	75.3	7	1301.7		1134370
3	3	99.8	7	1691.2	928.2	226986
4	3	91.4	7	1351.6	1845.6	516768
5	3	91.3	7	1507.7	1109.7	806793
6	2	75.6	7	1497.4		1097643
7	2	68.2	7	1628.8		191388
8	1	62.3	7			482197
9	1	51	7			773239
10	1	59.6	7			1063311
11						
12						
13						
14						
15						
16						
17						
18						
19						
20						

Unless otherwise stated the results shown in this test report refer only to the sample(s) tested and such sample(s) are retained for 90 days only.

除非另有說明，此報告結果僅對測試之樣品負責，同時此樣品僅保留90天。本報告未經本公司書面許可，不可部份複製。

This document is issued by the Company subject to its General Conditions of Service printed overleaf, available on request or accessible at <http://www.sgs.com.tw/Terms-and-Conditions> and for electronic format documents, subject to Terms and Conditions for Electronic Documents at <http://www.sgs.com.tw/Terms-and-Conditions>. Attention is drawn to the limitation of liability, indemnification and jurisdiction issues defined therein. Any holder of this document is advised that information contained hereon reflects the Company's findings at the time of its intervention only and within the limits of Client's instructions, if any. The Company's sole responsibility is to its Client and this document does not exonerate parties to a transaction from exercising all their rights and obligations under the transaction documents. This document cannot be reproduced except in full, without prior written approval of the Company. Any unauthorized alteration, forgery or falsification of the content or appearance of this document is unlawful and offenders may be prosecuted to the fullest extent of the law.

Radar Type5_Trial18 for 5250MHz

Data Sheet for FCC Radar Type 5						
Trial Number:		18		VSG Frequency(MHz):		5255.2
Number of Bursts in Trial:			14		Successful Detection: Yes	
Burst (8-20)	Number Pulses per Burst (1-3)	Pulse Width (50-100)	Chirp Width (5-20)	Pulse 1-to-2 Spacing	Pulse 2-to-3 Spacing	Starting Location Within Interval
		(μ sec)	(MHz)	(μ sec)	(μ sec)	(μ sec)
1	2	68.6	13	1499.4		111159
2	1	64.9	13			318639
3	3	89.4	13	1225.6	1206.6	525016
4	2	66.7	13	1407.3		732895
5	3	98.5	13	1094.5	1290.5	85461
6	1	60.1	13			293098
7	2	68.9	13	1207.1		499889
8	2	74	13	1650		706709
9	2	82.7	13	937.3		60119
10	3	89.7	13	913.3	1511.3	266981
11	2	79.6	13	1323.4		474208
12	3	93.4	13	1709.6	922.6	680794
13	1	63.3	13			34618
14	1	50.5	13			242067
15						
16						
17						
18						
19						
20						

Unless otherwise stated the results shown in this test report refer only to the sample(s) tested and such sample(s) are retained for 90 days only.

除非另有說明，此報告結果僅對測試之樣品負責，同時此樣品僅保留90天。本報告未經本公司書面許可，不可部份複製。

This document is issued by the Company subject to its General Conditions of Service printed overleaf, available on request or accessible at <http://www.sgs.com.tw/Terms-and-Conditions> and for electronic format documents, subject to Terms and Conditions for Electronic Documents at <http://www.sgs.com.tw/Terms-and-Conditions>. Attention is drawn to the limitation of liability, indemnification and jurisdiction issues defined therein. Any holder of this document is advised that information contained hereon reflects the Company's findings at the time of its intervention only and within the limits of Client's instructions, if any. The Company's sole responsibility is to its Client and this document does not exonerate parties to a transaction from exercising all their rights and obligations under the transaction documents. This document cannot be reproduced except in full, without prior written approval of the Company. Any unauthorized alteration, forgery or falsification of the content or appearance of this document is unlawful and offenders may be prosecuted to the fullest extent of the law.

Radar Type5_Trial19 for 5250MHz

Data Sheet for FCC Radar Type 5						
Trial Number:		19		VSG Frequency(MHz):		5253.6
Number of Bursts in Trial:			11		Successful Detection: Yes	
Burst (8-20)	Number Pulses per Burst (1-3)	Pulse Width (50-100)	Chirp Width (5-20)	Pulse 1-to-2 Spacing	Pulse 2-to-3 Spacing	Starting Location Within Interval
		(μ sec)	(MHz)	(μ sec)	(μ sec)	(μ sec)
1	1	66	9			572486
2	2	67.7	9	1512.3		835382
3	1	61.6	9			11536
4	3	83.7	9	963.3	1336.3	275055
5	3	95.5	9	1832.5	1354.5	538089
6	2	76.8	9	1049.2		803017
7	1	63.9	9			1068197
8	2	66.7	9	1203.3		242891
9	2	78.3	9	998.7		507034
10	2	74.4	9	1755.6		770438
11	1	61.5	9			1035902
12						
13						
14						
15						
16						
17						
18						
19						
20						

Unless otherwise stated the results shown in this test report refer only to the sample(s) tested and such sample(s) are retained for 90 days only.

除非另有說明，此報告結果僅對測試之樣品負責，同時此樣品僅保留90天。本報告未經本公司書面許可，不可部份複製。

This document is issued by the Company subject to its General Conditions of Service printed overleaf, available on request or accessible at <http://www.sgs.com.tw/Terms-and-Conditions> and for electronic format documents, subject to Terms and Conditions for Electronic Documents at <http://www.sgs.com.tw/Terms-and-Conditions>. Attention is drawn to the limitation of liability, indemnification and jurisdiction issues defined therein. Any holder of this document is advised that information contained hereon reflects the Company's findings at the time of its intervention only and within the limits of Client's instructions, if any. The Company's sole responsibility is to its Client and this document does not exonerate parties to a transaction from exercising all their rights and obligations under the transaction documents. This document cannot be reproduced except in full, without prior written approval of the Company. Any unauthorized alteration, forgery or falsification of the content or appearance of this document is unlawful and offenders may be prosecuted to the fullest extent of the law.

SGS Taiwan Ltd.

No.134,Wu Kung Road, New Taipei Industrial Park, Wuku District, New Taipei City, Taiwan/新北市五股區新北產業園區五工路 134 號

台灣檢驗科技股份有限公司

t (886-2) 2299-3279

f (886-2) 2298-0488

www.sgs.com.tw

Member of SGS Group

Radar Type5_Trial20 for 5250MHz

Data Sheet for FCC Radar Type 5						
Trial Number:		20		VSG Frequency(MHz):		5256.4
Number of Bursts in Trial:			17		Successful Detection: Yes	
Burst (8-20)	Number Pulses per Burst (1-3)	Pulse Width (50-100)	Chirp Width (5-20)	Pulse 1-to-2 Spacing	Pulse 2-to-3 Spacing	Starting Location Within Interval
		(μ sec)	(MHz)	(μ sec)	(μ sec)	(μ sec)
1	3	88	16	1256	919	135783
2	3	98	16	1506	1371	305527
3	1	57.4	16			478186
4	2	76.4	16	1773.6		646724
5	1	52.8	16			115148
6	1	51	16			285926
7	1	54.8	16			456935
8	2	79	16	1222		626758
9	3	83.8	16	1125.2	1487.2	93692
10	2	68.5	16	1802.5		264129
11	2	79.9	16	1904.1		434598
12	3	92.9	16	1398.1	1123.1	604219
13	3	97.1	16	1045.9	1166.9	72856
14	2	70.6	16	1757.4		243445
15	2	72	16	1359		413877
16	3	95	16	1255	1652	582964
17	2	69.5	16	1837.5		51895
18						
19						
20						

Unless otherwise stated the results shown in this test report refer only to the sample(s) tested and such sample(s) are retained for 90 days only.

除非另有說明，此報告結果僅對測試之樣品負責，同時此樣品僅保留90天。本報告未經本公司書面許可，不可部份複製。

This document is issued by the Company subject to its General Conditions of Service printed overleaf, available on request or accessible at <http://www.sgs.com.tw/Terms-and-Conditions> and for electronic format documents, subject to Terms and Conditions for Electronic Documents at <http://www.sgs.com.tw/Terms-and-Conditions>. Attention is drawn to the limitation of liability, indemnification and jurisdiction issues defined therein. Any holder of this document is advised that information contained hereon reflects the Company's findings at the time of its intervention only and within the limits of Client's instructions, if any. The Company's sole responsibility is to its Client and this document does not exonerate parties to a transaction from exercising all their rights and obligations under the transaction documents. This document cannot be reproduced except in full, without prior written approval of the Company. Any unauthorized alteration, forgery or falsification of the content or appearance of this document is unlawful and offenders may be prosecuted to the fullest extent of the law.

Radar Type5_Trial21 for 5250MHz

Data Sheet for FCC Radar Type 5						
Trial Number:		21		VSG Frequency(MHz):		5325.27
Number of Bursts in Trial:			9		Successful Detection: Yes	
Burst (8-20)	Number Pulses per Burst (1-3)	Pulse Width (50-100)	Chirp Width (5-20)	Pulse 1-to-2 Spacing	Pulse 2-to-3 Spacing	Starting Location Within Interval
		(μ sec)	(MHz)	(μ sec)	(μ sec)	(μ sec)
1	1	56.7	6			421551
2	1	54.5	6			744478
3	3	98.9	6	1286.1	1719.1	1064529
4	1	53.1	6			58608
5	1	61.9	6			381621
6	3	99.2	6	1156.8	1217.8	703403
7	2	75.4	6	1653.6		1026298
8	2	73.6	6	1185.4		18794
9	1	64	6			341945
10						
11						
12						
13						
14						
15						
16						
17						
18						
19						
20						

Unless otherwise stated the results shown in this test report refer only to the sample(s) tested and such sample(s) are retained for 90 days only.

除非另有說明，此報告結果僅對測試之樣品負責，同時此樣品僅保留90天。本報告未經本公司書面許可，不可部份複製。

This document is issued by the Company subject to its General Conditions of Service printed overleaf, available on request or accessible at <http://www.sgs.com.tw/Terms-and-Conditions> and for electronic format documents, subject to Terms and Conditions for Electronic Documents at <http://www.sgs.com.tw/Terms-and-Conditions>. Attention is drawn to the limitation of liability, indemnification and jurisdiction issues defined therein. Any holder of this document is advised that information contained hereon reflects the Company's findings at the time of its intervention only and within the limits of Client's instructions, if any. The Company's sole responsibility is to its Client and this document does not exonerate parties to a transaction from exercising all their rights and obligations under the transaction documents. This document cannot be reproduced except in full, without prior written approval of the Company. Any unauthorized alteration, forgery or falsification of the content or appearance of this document is unlawful and offenders may be prosecuted to the fullest extent of the law.

SGS Taiwan Ltd.

No.134,Wu Kung Road, New Taipei Industrial Park, Wuku District, New Taipei City, Taiwan/新北市五股區新北產業園區五工路 134 號

台灣檢驗科技股份有限公司

t (886-2) 2299-3279

f (886-2) 2298-0488

www.sgs.com.tw

Member of SGS Group

Radar Type5_Trial22 for 5250MHz

Data Sheet for FCC Radar Type 5						
Trial Number:		22		VSG Frequency(MHz):		5322.47
Number of Bursts in Trial:			14		Successful Detection: Yes	
Burst (8-20)	Number Pulses per Burst (1-3)	Pulse Width (50-100)	Chirp Width (5-20)	Pulse 1-to-2 Spacing	Pulse 2-to-3 Spacing	Starting Location Within Interval
		(μ sec)	(MHz)	(μ sec)	(μ sec)	(μ sec)
1	3	84.5	13	1021.5	1628.5	425699
2	2	66.8	13	1144.2		633700
3	2	74.3	13	1140.7		840682
4	3	95.7	13	904.3	958.3	193640
5	1	51.9	13			401335
6	3	86.7	13	1253.3	1160.3	607151
7	1	64.9	13			816306
8	1	55.2	13			168523
9	1	60.5	13			376178
10	1	62.1	13			583300
11	1	61.4	13			791044
12	3	97.6	13	1516.4	1265.4	142362
13	2	79.9	13	1880.1		349568
14	3	88.6	13	1675.4	1030.4	556281
15						
16						
17						
18						
19						
20						

Unless otherwise stated the results shown in this test report refer only to the sample(s) tested and such sample(s) are retained for 90 days only.

除非另有說明，此報告結果僅對測試之樣品負責，同時此樣品僅保留90天。本報告未經本公司書面許可，不可部份複製。

This document is issued by the Company subject to its General Conditions of Service printed overleaf, available on request or accessible at <http://www.sgs.com.tw/Terms-and-Conditions> and for electronic format documents, subject to Terms and Conditions for Electronic Documents at <http://www.sgs.com.tw/Terms-and-Conditions>. Attention is drawn to the limitation of liability, indemnification and jurisdiction issues defined therein. Any holder of this document is advised that information contained hereon reflects the Company's findings at the time of its intervention only and within the limits of Client's instructions, if any. The Company's sole responsibility is to its Client and this document does not exonerate parties to a transaction from exercising all their rights and obligations under the transaction documents. This document cannot be reproduced except in full, without prior written approval of the Company. Any unauthorized alteration, forgery or falsification of the content or appearance of this document is unlawful and offenders may be prosecuted to the fullest extent of the law.

Radar Type5_Trial23 for 5250MHz

Data Sheet for FCC Radar Type 5						
Trial Number:		23		VSG Frequency(MHz):		5322.07
Number of Bursts in Trial:			15		Successful Detection: Yes	
Burst (8-20)	Number Pulses per Burst (1-3)	Pulse Width (50-100)	Chirp Width (5-20)	Pulse 1-to-2 Spacing	Pulse 2-to-3 Spacing	Starting Location Within Interval
		(μ sec)	(MHz)	(μ sec)	(μ sec)	(μ sec)
1	2	74.8	14	1903.2		712954
2	1	64.4	14			109577
3	2	79.6	14	947.4		302690
4	2	82.1	14	1141.9		496146
5	3	86.2	14	1236.8	989.8	688037
6	2	74.8	14	1243.2		85509
7	1	64.5	14			279236
8	1	63.1	14			472748
9	2	73.5	14	1362.5		665464
10	2	81.8	14	1385.2		61664
11	3	94.4	14	1855.6	961.6	254652
12	1	59.9	14			449055
13	2	73.7	14	1136.3		641555
14	2	75.6	14	1761.4		37890
15	1	58.4	14			231571
16						
17						
18						
19						
20						

Unless otherwise stated the results shown in this test report refer only to the sample(s) tested and such sample(s) are retained for 90 days only.

除非另有說明，此報告結果僅對測試之樣品負責，同時此樣品僅保留90天。本報告未經本公司書面許可，不可部份複製。

This document is issued by the Company subject to its General Conditions of Service printed overleaf, available on request or accessible at <http://www.sgs.com.tw/Terms-and-Conditions> and for electronic format documents, subject to Terms and Conditions for Electronic Documents at <http://www.sgs.com.tw/Terms-and-Conditions>. Attention is drawn to the limitation of liability, indemnification and jurisdiction issues defined therein. Any holder of this document is advised that information contained hereon reflects the Company's findings at the time of its intervention only and within the limits of Client's instructions, if any. The Company's sole responsibility is to its Client and this document does not exonerate parties to a transaction from exercising all their rights and obligations under the transaction documents. This document cannot be reproduced except in full, without prior written approval of the Company. Any unauthorized alteration, forgery or falsification of the content or appearance of this document is unlawful and offenders may be prosecuted to the fullest extent of the law.

Radar Type5_Trial24 for 5250MHz

Data Sheet for FCC Radar Type 5						
Trial Number:		24		VSG Frequency(MHz):		5325.27
Number of Bursts in Trial:			9		Successful Detection: Yes	
Burst (8-20)	Number Pulses per Burst (1-3)	Pulse Width (50-100)	Chirp Width (5-20)	Pulse 1-to-2 Spacing	Pulse 2-to-3 Spacing	Starting Location Within Interval
		(μ sec)	(MHz)	(μ sec)	(μ sec)	(μ sec)
1	2	76.1	6	1613.9		708682
2	3	98.8	6	973.2	1563.2	1030464
3	2	82.1	6	1484.9		23490
4	1	52.8	6			346421
5	3	88.9	6	1759.1	1530.1	667789
6	1	66.6	6			992268
7	3	88	6	1717	1899	1311409
8	1	54.6	6			306766
9	3	88.1	6	1901.9	1340.9	628217
10						
11						
12						
13						
14						
15						
16						
17						
18						
19						
20						

Unless otherwise stated the results shown in this test report refer only to the sample(s) tested and such sample(s) are retained for 90 days only.

除非另有說明，此報告結果僅對測試之樣品負責，同時此樣品僅保留90天。本報告未經本公司書面許可，不可部份複製。

This document is issued by the Company subject to its General Conditions of Service printed overleaf, available on request or accessible at <http://www.sgs.com.tw/Terms-and-Conditions> and for electronic format documents, subject to Terms and Conditions for Electronic Documents at <http://www.sgs.com.tw/Terms-and-Conditions>. Attention is drawn to the limitation of liability, indemnification and jurisdiction issues defined therein. Any holder of this document is advised that information contained hereon reflects the Company's findings at the time of its intervention only and within the limits of Client's instructions, if any. The Company's sole responsibility is to its Client and this document does not exonerate parties to a transaction from exercising all their rights and obligations under the transaction documents. This document cannot be reproduced except in full, without prior written approval of the Company. Any unauthorized alteration, forgery or falsification of the content or appearance of this document is unlawful and offenders may be prosecuted to the fullest extent of the law.

SGS Taiwan Ltd.

No.134,Wu Kung Road, New Taipei Industrial Park, Wuku District, New Taipei City, Taiwan/新北市五股區新北產業園區五工路 134 號

台灣檢驗科技股份有限公司

t (886-2) 2299-3279

f (886-2) 2298-0488

www.sgs.com.tw

Member of SGS Group

Radar Type5_Trial25 for 5250MHz

Data Sheet for FCC Radar Type 5						
Trial Number:		25		VSG Frequency(MHz):		5323.67
Number of Bursts in Trial:			12		Successful Detection: Yes	
Burst (8-20)	Number Pulses per Burst (1-3)	Pulse Width (50-100)	Chirp Width (5-20)	Pulse 1-to-2 Spacing	Pulse 2-to-3 Spacing	Starting Location Within Interval
		(μ sec)	(MHz)	(μ sec)	(μ sec)	(μ sec)
1	1	66.5	10			713981
2	3	93.2	10	1318.8	1383.8	954060
3	2	77.9	10	1604.1		199837
4	3	91.9	10	1294.1	1759.1	440713
5	1	60	10			684224
6	1	59.8	10			926991
7	3	83.6	10	1361.4	1524.4	169870
8	2	72	10	1008		411973
9	2	76.9	10	1546.1		653647
10	1	65.9	10			896784
11	2	74	10	1743		140278
12	3	88.8	10	1123.2	978.2	381664
13						
14						
15						
16						
17						
18						
19						
20						

Unless otherwise stated the results shown in this test report refer only to the sample(s) tested and such sample(s) are retained for 90 days only.

除非另有說明，此報告結果僅對測試之樣品負責，同時此樣品僅保留90天。本報告未經本公司書面許可，不可部份複製。

This document is issued by the Company subject to its General Conditions of Service printed overleaf, available on request or accessible at <http://www.sgs.com.tw/Terms-and-Conditions> and for electronic format documents, subject to Terms and Conditions for Electronic Documents at <http://www.sgs.com.tw/Terms-and-Conditions>. Attention is drawn to the limitation of liability, indemnification and jurisdiction issues defined therein. Any holder of this document is advised that information contained hereon reflects the Company's findings at the time of its intervention only and within the limits of Client's instructions, if any. The Company's sole responsibility is to its Client and this document does not exonerate parties to a transaction from exercising all their rights and obligations under the transaction documents. This document cannot be reproduced except in full, without prior written approval of the Company. Any unauthorized alteration, forgery or falsification of the content or appearance of this document is unlawful and offenders may be prosecuted to the fullest extent of the law.

SGS Taiwan Ltd.

No.134,Wu Kung Road, New Taipei Industrial Park, Wuku District, New Taipei City, Taiwan/新北市五股區新北產業園區五工路 134 號

台灣檢驗科技股份有限公司

t (886-2) 2299-3279

f (886-2) 2298-0488

www.sgs.com.tw

Member of SGS Group

Radar Type5_Trial26 for 5250MHz

Data Sheet for FCC Radar Type 5						
Trial Number:		26		VSG Frequency(MHz):		5322.07
Number of Bursts in Trial:			15		Successful Detection: Yes	
Burst (8-20)	Number Pulses per Burst (1-3)	Pulse Width (50-100)	Chirp Width (5-20)	Pulse 1-to-2 Spacing	Pulse 2-to-3 Spacing	Starting Location Within Interval
		(μ sec)	(MHz)	(μ sec)	(μ sec)	(μ sec)
1	2	82.4	14	1229.6		498536
2	2	67.1	14	1773.9		692019
3	3	89.3	14	1756.7	1617.7	88107
4	3	98.9	14	1600.1	1443.1	281127
5	3	99.5	14	1867.5	1028.5	474098
6	2	71.4	14	1023.6		668574
7	3	93.3	14	1751.7	1007.7	64396
8	3	92.6	14	1705.4	1299.4	257232
9	1	51.2	14			451923
10	3	92	14	1685	1843	642653
11	1	63	14			40796
12	3	89.4	14	1839.6	1564.6	233502
13	3	96.9	14	1282.1	1638.1	426399
14	3	84.5	14	1494.5	1024.5	619777
15	1	63.3	14			16934
16						
17						
18						
19						
20						

Unless otherwise stated the results shown in this test report refer only to the sample(s) tested and such sample(s) are retained for 90 days only.

除非另有說明，此報告結果僅對測試之樣品負責，同時此樣品僅保留90天。本報告未經本公司書面許可，不可部份複製。

This document is issued by the Company subject to its General Conditions of Service printed overleaf, available on request or accessible at <http://www.sgs.com.tw/Terms-and-Conditions> and for electronic format documents, subject to Terms and Conditions for Electronic Documents at <http://www.sgs.com.tw/Terms-and-Conditions>. Attention is drawn to the limitation of liability, indemnification and jurisdiction issues defined therein. Any holder of this document is advised that information contained hereon reflects the Company's findings at the time of its intervention only and within the limits of Client's instructions, if any. The Company's sole responsibility is to its Client and this document does not exonerate parties to a transaction from exercising all their rights and obligations under the transaction documents. This document cannot be reproduced except in full, without prior written approval of the Company. Any unauthorized alteration, forgery or falsification of the content or appearance of this document is unlawful and offenders may be prosecuted to the fullest extent of the law.

Radar Type5_Trial27 for 5250MHz

Data Sheet for FCC Radar Type 5						
Trial Number:		27		VSG Frequency(MHz):		5321.27
Number of Bursts in Trial:			17		Successful Detection: Yes	
Burst (8-20)	Number Pulses per Burst (1-3)	Pulse Width (50-100)	Chirp Width (5-20)	Pulse 1-to-2 Spacing	Pulse 2-to-3 Spacing	Starting Location Within Interval
		(μ sec)	(MHz)	(μ sec)	(μ sec)	(μ sec)
1	2	79.4	16	1554.6		185404
2	3	94.8	16	1571.2	1078.2	355243
3	3	91.1	16	1445.9	1467.9	524957
4	2	72	16	1706		696602
5	3	86.8	16	1170.2	1767.2	164009
6	1	59.7	16			335368
7	3	91.5	16	1447.5	1197.5	504553
8	1	65.5	16			677665
9	3	93	16	978	1696	143140
10	3	96.9	16	1185.1	1071.1	313396
11	2	72.6	16	976.4		484806
12	1	53	16			655886
13	1	63.7	16			122700
14	3	98.2	16	939.8	1156.8	292699
15	2	72.4	16	1661.6		463032
16	2	83.1	16	955.9		633961
17	1	57.7	16			101592
18						
19						
20						

Unless otherwise stated the results shown in this test report refer only to the sample(s) tested and such sample(s) are retained for 90 days only.

除非另有說明，此報告結果僅對測試之樣品負責，同時此樣品僅保留90天。本報告未經本公司書面許可，不可部份複製。

This document is issued by the Company subject to its General Conditions of Service printed overleaf, available on request or accessible at <http://www.sgs.com.tw/Terms-and-Conditions> and for electronic format documents, subject to Terms and Conditions for Electronic Documents at <http://www.sgs.com.tw/Terms-and-Conditions>. Attention is drawn to the limitation of liability, indemnification and jurisdiction issues defined therein. Any holder of this document is advised that information contained hereon reflects the Company's findings at the time of its intervention only and within the limits of Client's instructions, if any. The Company's sole responsibility is to its Client and this document does not exonerate parties to a transaction from exercising all their rights and obligations under the transaction documents. This document cannot be reproduced except in full, without prior written approval of the Company. Any unauthorized alteration, forgery or falsification of the content or appearance of this document is unlawful and offenders may be prosecuted to the fullest extent of the law.

Radar Type5_Trial28 for 5250MHz

Data Sheet for FCC Radar Type 5						
Trial Number:		28		VSG Frequency(MHz):		5321.67
Number of Bursts in Trial:			16		Successful Detection: Yes	
Burst (8-20)	Number Pulses per Burst (1-3)	Pulse Width (50-100)	Chirp Width (5-20)	Pulse 1-to-2 Spacing	Pulse 2-to-3 Spacing	Starting Location Within Interval
		(μ sec)	(MHz)	(μ sec)	(μ sec)	(μ sec)
1	1	51.6	15			289349
2	2	69.6	15	1249.4		470024
3	3	93.7	15	1041.3	1150.3	650118
4	2	81.7	15	1884.3		85378
5	3	92.9	15	1015.1	1041.1	266411
6	1	54	15			448486
7	3	89.4	15	1661.6	1625.6	627280
8	3	95.2	15	1199.8	1312.8	63036
9	3	94.8	15	1874.2	1264.2	243526
10	1	62	15			426457
11	3	86.8	15	1765.2	1300.2	605400
12	2	74.6	15	1030.4		40835
13	2	80.2	15	1433.8		221894
14	3	88.6	15	1584.4	1204.4	402325
15	3	95.1	15	1364.9	1513.9	582845
16	2	75.6	15	1550.4		18465
17						
18						
19						
20						

Unless otherwise stated the results shown in this test report refer only to the sample(s) tested and such sample(s) are retained for 90 days only.

除非另有說明，此報告結果僅對測試之樣品負責，同時此樣品僅保留90天。本報告未經本公司書面許可，不可部份複製。

This document is issued by the Company subject to its General Conditions of Service printed overleaf, available on request or accessible at <http://www.sgs.com.tw/Terms-and-Conditions> and for electronic format documents, subject to Terms and Conditions for Electronic Documents at <http://www.sgs.com.tw/Terms-and-Conditions>. Attention is drawn to the limitation of liability, indemnification and jurisdiction issues defined therein. Any holder of this document is advised that information contained hereon reflects the Company's findings at the time of its intervention only and within the limits of Client's instructions, if any. The Company's sole responsibility is to its Client and this document does not exonerate parties to a transaction from exercising all their rights and obligations under the transaction documents. This document cannot be reproduced except in full, without prior written approval of the Company. Any unauthorized alteration, forgery or falsification of the content or appearance of this document is unlawful and offenders may be prosecuted to the fullest extent of the law.

Radar Type5_Trial29 for 5250MHz

Data Sheet for FCC Radar Type 5						
Trial Number:		29		VSG Frequency(MHz):		5323.67
Number of Bursts in Trial:			12		Successful Detection: Yes	
Burst (8-20)	Number Pulses per Burst (1-3)	Pulse Width (50-100)	Chirp Width (5-20)	Pulse 1-to-2 Spacing	Pulse 2-to-3 Spacing	Starting Location Within Interval
		(μ sec)	(MHz)	(μ sec)	(μ sec)	(μ sec)
1	3	96.5	10	1604.5	1082.5	265973
2	1	54.2	10			509016
3	2	77.3	10	1263.7		749934
4	3	85.8	10	1593.2	1151.2	990734
5	3	93.9	10	920.1	1876.1	236405
6	3	87.2	10	999.8	1300.8	477860
7	2	79	10	980		720257
8	3	91	10	977	918	961256
9	1	51.6	10			207126
10	3	96.3	10	1180.7	1203.7	448163
11	1	51.9	10			691269
12	2	76.9	10	1126.1		932778
13						
14						
15						
16						
17						
18						
19						
20						

Unless otherwise stated the results shown in this test report refer only to the sample(s) tested and such sample(s) are retained for 90 days only.

除非另有說明，此報告結果僅對測試之樣品負責，同時此樣品僅保留90天。本報告未經本公司書面許可，不可部份複製。

This document is issued by the Company subject to its General Conditions of Service printed overleaf, available on request or accessible at <http://www.sgs.com.tw/Terms-and-Conditions> and for electronic format documents, subject to Terms and Conditions for Electronic Documents at <http://www.sgs.com.tw/Terms-and-Conditions>. Attention is drawn to the limitation of liability, indemnification and jurisdiction issues defined therein. Any holder of this document is advised that information contained hereon reflects the Company's findings at the time of its intervention only and within the limits of Client's instructions, if any. The Company's sole responsibility is to its Client and this document does not exonerate parties to a transaction from exercising all their rights and obligations under the transaction documents. This document cannot be reproduced except in full, without prior written approval of the Company. Any unauthorized alteration, forgery or falsification of the content or appearance of this document is unlawful and offenders may be prosecuted to the fullest extent of the law.

Radar Type5_Trial30 for 5250MHz

Data Sheet for FCC Radar Type 5						
Trial Number:		30		VSG Frequency(MHz):		5320.07
Number of Bursts in Trial:			19		Successful Detection: Yes	
Burst (8-20)	Number Pulses per Burst (1-3)	Pulse Width (50-100)	Chirp Width (5-20)	Pulse 1-to-2 Spacing	Pulse 2-to-3 Spacing	Starting Location Within Interval
		(μ sec)	(MHz)	(μ sec)	(μ sec)	(μ sec)
1	2	68.3	19	1287.7		111742
2	2	79.5	19	1375.5		263974
3	3	94.4	19	1371.6	1809.6	415412
4	2	78.9	19	1033.1		569750
5	1	58.9	19			93035
6	1	55.2	19			245758
7	3	87.8	19	1741.2	931.2	396617
8	2	77.2	19	1149.8		550426
9	3	90.8	19	1320.2	1427.2	73959
10	2	81.7	19	1204.3		226712
11	3	86.5	19	1320.5	1309.5	378328
12	3	90.7	19	1303.3	1374.3	530663
13	1	51.6	19			55500
14	2	76.9	19	1169.1		207885
15	3	92.1	19	1109.9	1723.9	359389
16	3	97.8	19	1590.2	1052.2	511380
17	1	54.6	19			36611
18	3	91	19	1234	1848	188355
19	1	62.7	19			342053
20						

Unless otherwise stated the results shown in this test report refer only to the sample(s) tested and such sample(s) are retained for 90 days only.

除非另有說明，此報告結果僅對測試之樣品負責，同時此樣品僅保留90天。本報告未經本公司書面許可，不可部份複製。

This document is issued by the Company subject to its General Conditions of Service printed overleaf, available on request or accessible at <http://www.sgs.com.tw/Terms-and-Conditions> and for electronic format documents, subject to Terms and Conditions for Electronic Documents at <http://www.sgs.com.tw/Terms-and-Conditions>. Attention is drawn to the limitation of liability, indemnification and jurisdiction issues defined therein. Any holder of this document is advised that information contained hereon reflects the Company's findings at the time of its intervention only and within the limits of Client's instructions, if any. The Company's sole responsibility is to its Client and this document does not exonerate parties to a transaction from exercising all their rights and obligations under the transaction documents. This document cannot be reproduced except in full, without prior written approval of the Company. Any unauthorized alteration, forgery or falsification of the content or appearance of this document is unlawful and offenders may be prosecuted to the fullest extent of the law.

Radar Type6 for 5250MHz

Data Sheet for FCC Radar Type 6

Trial	Pulse Width	PRI	Pulses per Hop	Hopping Rate	Hopping Sequence Length	Successful Detection
	(μ sec)	(μ sec)		(kHz)	(msec)	(Yes/No)
1	1	333	9	0.333	300	Yes
2	1	333	9	0.333	300	Yes
3	1	333	9	0.333	300	Yes
4	1	333	9	0.333	300	Yes
5	1	333	9	0.333	300	Yes
6	1	333	9	0.333	300	Yes
7	1	333	9	0.333	300	Yes
8	1	333	9	0.333	300	Yes
9	1	333	9	0.333	300	Yes
10	1	333	9	0.333	300	Yes
11	1	333	9	0.333	300	Yes
12	1	333	9	0.333	300	Yes
13	1	333	9	0.333	300	Yes
14	1	333	9	0.333	300	No
15	1	333	9	0.333	300	Yes
16	1	333	9	0.333	300	Yes
17	1	333	9	0.333	300	No
18	1	333	9	0.333	300	Yes
19	1	333	9	0.333	300	Yes
20	1	333	9	0.333	300	No
21	1	333	9	0.333	300	Yes
22	1	333	9	0.333	300	Yes
23	1	333	9	0.333	300	Yes
24	1	333	9	0.333	300	Yes
25	1	333	9	0.333	300	Yes
26	1	333	9	0.333	300	Yes
27	1	333	9	0.333	300	Yes
28	1	333	9	0.333	300	Yes
29	1	333	9	0.333	300	Yes
30	1	333	9	0.333	300	Yes

Unless otherwise stated the results shown in this test report refer only to the sample(s) tested and such sample(s) are retained for 90 days only.

除非另有說明，此報告結果僅對測試之樣品負責，同時此樣品僅保留90天。本報告未經本公司書面許可，不可部份複製。

This document is issued by the Company subject to its General Conditions of Service printed overleaf, available on request or accessible at <http://www.sgs.com.tw/Terms-and-Conditions> and for electronic format documents, subject to Terms and Conditions for Electronic Documents at <http://www.sgs.com.tw/Terms-and-Conditions>. Attention is drawn to the limitation of liability, indemnification and jurisdiction issues defined therein. Any holder of this document is advised that information contained hereon reflects the Company's findings at the time of its intervention only and within the limits of Client's instructions, if any. The Company's sole responsibility is to its Client and this document does not exonerate parties to a transaction from exercising all their rights and obligations under the transaction documents. This document cannot be reproduced except in full, without prior written approval of the Company. Any unauthorized alteration, forgery or falsification of the content or appearance of this document is unlawful and offenders may be prosecuted to the fullest extent of the law.

HE160_5570MHz

Short Pulse Radar Type	Minimum Number of Trials	Detection(%)		Minmum Percentage of Successful Detection(%)	Pass/Fail
1	30	100		60	Pass
2	30	100		60	Pass
3	30	100		60	Pass
4	30	100		60	Pass
Aggregate (Radar Types 1-4)	120	100		80	Pass
Long Pulse Radar Type	Minimum Number of Trials	Each Detection(%)	Total Detection(%)	Minmum Percentage of Successful Detection(%)	Pass/Fail
5	Center:10	100	100	80	Pass
	Low Edge:10	100			
	High Edge:10	100			
Frequency Hopping Radar Type	Minimum Number of Trials	Detection(%)		Minmum Percentage of Successful Detection(%)	Pass/Fail
6	30	96.66666667		70	Pass

Unless otherwise stated the results shown in this test report refer only to the sample(s) tested and such sample(s) are retained for 90 days only.

除非另有說明，此報告結果僅對測試之樣品負責，同時此樣品僅保留90天。本報告未經本公司書面許可，不可部份複製。

This document is issued by the Company subject to its General Conditions of Service printed overleaf, available on request or accessible at <http://www.sgs.com.tw/Terms-and-Conditions> and for electronic format documents, subject to Terms and Conditions for Electronic Documents at <http://www.sgs.com.tw/Terms-and-Conditions>. Attention is drawn to the limitation of liability, indemnification and jurisdiction issues defined therein. Any holder of this document is advised that information contained hereon reflects the Company's findings at the time of its intervention only and within the limits of Client's instructions, if any. The Company's sole responsibility is to its Client and this document does not exonerate parties to a transaction from exercising all their rights and obligations under the transaction documents. This document cannot be reproduced except in full, without prior written approval of the Company. Any unauthorized alteration, forgery or falsification of the content or appearance of this document is unlawful and offenders may be prosecuted to the fullest extent of the law.

Radar Type1 for 5570MHz

Data Sheet for FCC Radar Type 1

Trial	VSG Frequency (MHz)	Pulse Repetition Frequency Number (1 to 23)	Pulse Repetition Frequency	PRI (msec)	Test A/B	Successful Detection (Yes/No)
			(Pulses Per Second)			
1	5570	13	1319.3	758	A	Yes
2	5570	21	1089.3	918	A	Yes
3	5570	8	1519.8	658	A	Yes
4	5570	19	1139	878	A	Yes
5	5570	18	1165.5	858	A	Yes
6	5570	11	1392.8	718	A	Yes
7	5570	6	1618.1	618	A	Yes
8	5570	10	1432.7	698	A	Yes
9	5570	16	1222.5	818	A	Yes
10	5570	17	1193.3	838	A	Yes
11	5570	23	326.2	3066	A	Yes
12	5570	9	1474.9	678	A	Yes
13	5570	4	1730.1	578	A	Yes
14	5570	5	1672.2	598	A	Yes
15	5570	1	1930.5	518	A	Yes
16	5570	-	533.6	1874	B	Yes
17	5570	-	471.7	2120	B	Yes
18	5570	-	342.2	2922	B	Yes
19	5570	-	993	1007	B	Yes
20	5570	-	1257.9	795	B	Yes
21	5570	-	742.9	1346	B	Yes
22	5570	-	814.3	1228	B	Yes
23	5570	-	403.1	2481	B	Yes
24	5570	-	700.8	1427	B	Yes
25	5570	-	1831.5	546	B	Yes
26	5570	-	1251.6	799	B	Yes
27	5570	-	483.6	2068	B	Yes
28	5570	-	970.9	1030	B	Yes
29	5570	-	449.6	2224	B	Yes
30	5570	-	687.8	1454	B	Yes

Unless otherwise stated the results shown in this test report refer only to the sample(s) tested and such sample(s) are retained for 90 days only.

除非另有說明，此報告結果僅對測試之樣品負責，同時此樣品僅保留90天。本報告未經本公司書面許可，不可部份複製。

This document is issued by the Company subject to its General Conditions of Service printed overleaf, available on request or accessible at <http://www.sgs.com.tw/Terms-and-Conditions> and for electronic format documents, subject to Terms and Conditions for Electronic Documents at <http://www.sgs.com.tw/Terms-and-Conditions>. Attention is drawn to the limitation of liability, indemnification and jurisdiction issues defined therein. Any holder of this document is advised that information contained hereon reflects the Company's findings at the time of its intervention only and within the limits of Client's instructions, if any. The Company's sole responsibility is to its Client and this document does not exonerate parties to a transaction from exercising all their rights and obligations under the transaction documents. This document cannot be reproduced except in full, without prior written approval of the Company. Any unauthorized alteration, forgery or falsification of the content or appearance of this document is unlawful and offenders may be prosecuted to the fullest extent of the law.

Radar Type2 for 5570MHz

Data Sheet for FCC Radar Type 2

Trial	VSG Frequency (MHz)	Number Pulses per Burst (23-29)	Pulse Width (1-5)	PRI (150-230)	Successful Detection
			(μ s)	(μ s)	(Yes/No)
1	5570	29	4.9	195	Yes
2	5570	28	4.1	153	Yes
3	5570	26	3.2	151	Yes
4	5570	23	1.2	227	Yes
5	5570	23	1.1	179	Yes
6	5570	26	2.9	166	Yes
7	5570	26	2.7	174	Yes
8	5570	24	2.1	230	Yes
9	5570	24	1.9	180	Yes
10	5570	29	4.8	223	Yes
11	5570	26	3.2	193	Yes
12	5570	24	1.9	155	Yes
13	5570	28	4	187	Yes
14	5570	29	5	206	Yes
15	5570	27	3.6	220	Yes
16	5570	29	4.7	175	Yes
17	5570	24	1.7	204	Yes
18	5570	26	3.1	181	Yes
19	5570	25	2.2	228	Yes
20	5570	28	4	182	Yes
21	5570	23	1.4	198	Yes
22	5570	26	3	199	Yes
23	5570	27	3.3	152	Yes
24	5570	23	1.3	178	Yes
25	5570	25	2.2	207	Yes
26	5570	27	3.4	159	Yes
27	5570	28	3.9	225	Yes
28	5570	27	3.6	168	Yes
29	5570	25	2.3	177	Yes
30	5570	29	4.7	205	Yes

Unless otherwise stated the results shown in this test report refer only to the sample(s) tested and such sample(s) are retained for 90 days only.

除非另有說明，此報告結果僅對測試之樣品負責，同時此樣品僅保留90天。本報告未經本公司書面許可，不可部份複製。

This document is issued by the Company subject to its General Conditions of Service printed overleaf, available on request or accessible at <http://www.sgs.com.tw/Terms-and-Conditions> and for electronic format documents, subject to Terms and Conditions for Electronic Documents at <http://www.sgs.com.tw/Terms-and-Conditions>. Attention is drawn to the limitation of liability, indemnification and jurisdiction issues defined therein. Any holder of this document is advised that information contained hereon reflects the Company's findings at the time of its intervention only and within the limits of Client's instructions, if any. The Company's sole responsibility is to its Client and this document does not exonerate parties to a transaction from exercising all their rights and obligations under the transaction documents. This document cannot be reproduced except in full, without prior written approval of the Company. Any unauthorized alteration, forgery or falsification of the content or appearance of this document is unlawful and offenders may be prosecuted to the fullest extent of the law.

Radar Type3 for 5570MHz

Data Sheet for FCC Radar Type 3

Trial	VSG Frequency (MHz)	Number Pulses per Burst (16-18)	Pulse Width (6-10)	PRI (200-500)	Successful Detection
			(μ s)	(μ s)	(Yes/No)
1	5570	18	9.9	442	Yes
2	5570	18	9.1	499	Yes
3	5570	17	8.2	273	Yes
4	5570	16	6.2	338	Yes
5	5570	16	6.1	487	Yes
6	5570	17	7.9	420	Yes
7	5570	17	7.7	450	Yes
8	5570	16	7.1	339	Yes
9	5570	16	6.9	405	Yes
10	5570	18	9.8	223	Yes
11	5570	17	8.2	453	Yes
12	5570	16	6.9	417	Yes
13	5570	18	9	400	Yes
14	5570	18	10	498	Yes
15	5570	17	8.6	274	Yes
16	5570	18	9.7	431	Yes
17	5570	16	6.7	294	Yes
18	5570	17	8.1	203	Yes
19	5570	16	7.2	298	Yes
20	5570	18	9	473	Yes
21	5570	16	6.4	407	Yes
22	5570	17	8	258	Yes
23	5570	17	8.3	249	Yes
24	5570	16	6.3	446	Yes
25	5570	16	7.2	486	Yes
26	5570	17	8.4	480	Yes
27	5570	18	8.9	370	Yes
28	5570	17	8.6	348	Yes
29	5570	16	7.3	401	Yes
30	5570	18	9.7	264	Yes

Unless otherwise stated the results shown in this test report refer only to the sample(s) tested and such sample(s) are retained for 90 days only.

除非另有說明，此報告結果僅對測試之樣品負責，同時此樣品僅保留90天。本報告未經本公司書面許可，不可部份複製。

This document is issued by the Company subject to its General Conditions of Service printed overleaf, available on request or accessible at <http://www.sgs.com.tw/Terms-and-Conditions> and for electronic format documents, subject to Terms and Conditions for Electronic Documents at <http://www.sgs.com.tw/Terms-and-Conditions>. Attention is drawn to the limitation of liability, indemnification and jurisdiction issues defined therein. Any holder of this document is advised that information contained hereon reflects the Company's findings at the time of its intervention only and within the limits of Client's instructions, if any. The Company's sole responsibility is to its Client and this document does not exonerate parties to a transaction from exercising all their rights and obligations under the transaction documents. This document cannot be reproduced except in full, without prior written approval of the Company. Any unauthorized alteration, forgery or falsification of the content or appearance of this document is unlawful and offenders may be prosecuted to the fullest extent of the law.

Radar Type4 for 5570MHz

Data Sheet for FCC Radar Type 4

Trial	VSG Frequency (MHz)	Number Pulses per Burst (12-16)	Pulse Width (11-20)	PRI (200-500)	Successful Detection
			(μ s)	(μ s)	(Yes/No)
1	5570	16	19.6	442	Yes
2	5570	15	17.8	499	Yes
3	5570	14	15.8	273	Yes
4	5570	12	11.4	338	Yes
5	5570	12	11.3	487	Yes
6	5570	14	15.3	420	Yes
7	5570	14	14.9	450	Yes
8	5570	13	13.5	339	Yes
9	5570	13	13.1	405	Yes
10	5570	16	19.5	223	Yes
11	5570	14	16	453	Yes
12	5570	13	13	417	Yes
13	5570	15	17.8	400	Yes
14	5570	16	20	498	Yes
15	5570	15	16.9	274	Yes
16	5570	16	19.2	431	Yes
17	5570	12	12.6	294	Yes
18	5570	14	15.6	203	Yes
19	5570	13	13.6	298	Yes
20	5570	15	17.6	473	Yes
21	5570	12	12.1	407	Yes
22	5570	14	15.5	258	Yes
23	5570	14	16.2	249	Yes
24	5570	12	11.7	446	Yes
25	5570	13	13.8	486	Yes
26	5570	15	16.5	480	Yes
27	5570	15	17.5	370	Yes
28	5570	15	16.8	348	Yes
29	5570	13	13.9	401	Yes
30	5570	16	19.3	264	Yes

Unless otherwise stated the results shown in this test report refer only to the sample(s) tested and such sample(s) are retained for 90 days only.

除非另有說明，此報告結果僅對測試之樣品負責，同時此樣品僅保留90天。本報告未經本公司書面許可，不可部份複製。

This document is issued by the Company subject to its General Conditions of Service printed overleaf, available on request or accessible at <http://www.sgs.com.tw/Terms-and-Conditions> and for electronic format documents, subject to Terms and Conditions for Electronic Documents at <http://www.sgs.com.tw/Terms-and-Conditions>. Attention is drawn to the limitation of liability, indemnification and jurisdiction issues defined therein. Any holder of this document is advised that information contained hereon reflects the Company's findings at the time of its intervention only and within the limits of Client's instructions, if any. The Company's sole responsibility is to its Client and this document does not exonerate parties to a transaction from exercising all their rights and obligations under the transaction documents. This document cannot be reproduced except in full, without prior written approval of the Company. Any unauthorized alteration, forgery or falsification of the content or appearance of this document is unlawful and offenders may be prosecuted to the fullest extent of the law.

Radar Type5_Trial1 for 5570MHz

Data Sheet for FCC Radar Type 5						
Trial Number:		1		VSG Frequency(MHz):		5570
Number of Bursts in Trial:			20		Successful Detection: Yes	
Burst (8-20)	Number Pulses per Burst (1-3)	Pulse Width (50-100)	Chirp Width (5-20)	Pulse 1-to-2 Spacing	Pulse 2-to-3 Spacing	Starting Location Within Interval
		(μ sec)	(MHz)	(μ sec)	(μ sec)	(μ sec)
1	3	97.7	20	1034.3	1421.3	116141
2	3	87.9	20	1634.1	1463.1	260383
3	2	76.9	20	929.1		406435
4	1	52.4	20			552540
5	1	51.8	20			98818
6	2	74	20	1785		243337
7	2	71.7	20	1586.3		388146
8	1	64	20			534217
9	1	61.5	20			80882
10	3	97.3	20	912.7	1544.7	224944
11	2	77.7	20	1096.3		370763
12	1	61.1	20			516312
13	3	87.5	20	1260.5	1441.5	62728
14	3	99.7	20	1776.3	1284.3	207224
15	2	82.7	20	1140.3		352481
16	3	95.2	20	1213.8	1162.8	495985
17	1	59.1	20			45158
18	2	75.6	20	1041.4		189991
19	1	64.7	20			335648
20	3	86.8	20	918.2	1652.2	478439

Unless otherwise stated the results shown in this test report refer only to the sample(s) tested and such sample(s) are retained for 90 days only.

除非另有說明，此報告結果僅對測試之樣品負責，同時此樣品僅保留90天。本報告未經本公司書面許可，不可部份複製。

This document is issued by the Company subject to its General Conditions of Service printed overleaf, available on request or accessible at <http://www.sgs.com.tw/Terms-and-Conditions> and for electronic format documents, subject to Terms and Conditions for Electronic Documents at <http://www.sgs.com.tw/Terms-and-Conditions>. Attention is drawn to the limitation of liability, indemnification and jurisdiction issues defined therein. Any holder of this document is advised that information contained hereon reflects the Company's findings at the time of its intervention only and within the limits of Client's instructions, if any. The Company's sole responsibility is to its Client and this document does not exonerate parties to a transaction from exercising all their rights and obligations under the transaction documents. This document cannot be reproduced except in full, without prior written approval of the Company. Any unauthorized alteration, forgery or falsification of the content or appearance of this document is unlawful and offenders may be prosecuted to the fullest extent of the law.

Radar Type5_Trial2 for 5570MHz

Data Sheet for FCC Radar Type 5						
Trial Number:		2		VSG Frequency(MHz):		5570
Number of Bursts in Trial:			17		Successful Detection: Yes	
Burst (8-20)	Number Pulses per Burst (1-3)	Pulse Width (50-100)	Chirp Width (5-20)	Pulse 1-to-2 Spacing	Pulse 2-to-3 Spacing	Starting Location Within Interval
		(μ sec)	(MHz)	(μ sec)	(μ sec)	(μ sec)
1	1	56	17			32097
2	2	75.2	17	1446.8		202501
3	2	79.1	17	1594.9		372874
4	1	54.1	17			544886
5	1	65.8	17			11064
6	2	80.4	17	1102.6		181560
7	3	86	17	1685	1290	351173
8	2	82.4	17	1445.6		522390
9	1	66.3	17			694725
10	3	95.8	17	970.2	1319.2	160367
11	3	85.6	17	1831.4	1791.4	329885
12	1	51	17			502809
13	1	64.7	17			673232
14	3	90.6	17	1053.4	1866.4	139129
15	1	53.4	17			310563
16	3	96.2	17	1065.8	1773.8	479259
17	1	65.5	17			652703
18						
19						
20						

Unless otherwise stated the results shown in this test report refer only to the sample(s) tested and such sample(s) are retained for 90 days only.

除非另有說明，此報告結果僅對測試之樣品負責，同時此樣品僅保留90天。本報告未經本公司書面許可，不可部份複製。

This document is issued by the Company subject to its General Conditions of Service printed overleaf, available on request or accessible at <http://www.sgs.com.tw/Terms-and-Conditions> and for electronic format documents, subject to Terms and Conditions for Electronic Documents at <http://www.sgs.com.tw/Terms-and-Conditions>. Attention is drawn to the limitation of liability, indemnification and jurisdiction issues defined therein. Any holder of this document is advised that information contained hereon reflects the Company's findings at the time of its intervention only and within the limits of Client's instructions, if any. The Company's sole responsibility is to its Client and this document does not exonerate parties to a transaction from exercising all their rights and obligations under the transaction documents. This document cannot be reproduced except in full, without prior written approval of the Company. Any unauthorized alteration, forgery or falsification of the content or appearance of this document is unlawful and offenders may be prosecuted to the fullest extent of the law.

Radar Type5_Trial3 for 5570MHz

Data Sheet for FCC Radar Type 5						
Trial Number:			3	VSG Frequency(MHz):		5570
Number of Bursts in Trial:			14	Successful Detection:		Yes
Burst (8-20)	Number Pulses per Burst (1-3)	Pulse Width (50-100)	Chirp Width (5-20)	Pulse 1-to-2 Spacing	Pulse 2-to-3 Spacing	Starting Location Within Interval
		(μ sec)	(MHz)	(μ sec)	(μ sec)	(μ sec)
1	2	75.2	13	1361.8		143969
2	3	90.7	13	1099.3	988.3	350947
3	3	93.8	13	1045.2	1043.2	557505
4	1	60.8	13			766524
5	3	98.2	13	1508.8	1876.8	118256
6	3	88.5	13	959.5	1339.5	325401
7	3	90.5	13	1857.5	1691.5	531589
8	2	74.6	13	957.4		740731
9	2	74.5	13	1040.5		92978
10	1	53.5	13			300652
11	3	89.7	13	1803.3	1110.3	506183
12	2	80.9	13	1738.1		714128
13	1	51.5	13			67556
14	2	80.4	13	1193.6		274857
15						
16						
17						
18						
19						
20						

Unless otherwise stated the results shown in this test report refer only to the sample(s) tested and such sample(s) are retained for 90 days only.

除非另有說明，此報告結果僅對測試之樣品負責，同時此樣品僅保留90天。本報告未經本公司書面許可，不可部份複製。

This document is issued by the Company subject to its General Conditions of Service printed overleaf, available on request or accessible at <http://www.sgs.com.tw/Terms-and-Conditions> and for electronic format documents, subject to Terms and Conditions for Electronic Documents at <http://www.sgs.com.tw/Terms-and-Conditions>. Attention is drawn to the limitation of liability, indemnification and jurisdiction issues defined therein. Any holder of this document is advised that information contained hereon reflects the Company's findings at the time of its intervention only and within the limits of Client's instructions, if any. The Company's sole responsibility is to its Client and this document does not exonerate parties to a transaction from exercising all their rights and obligations under the transaction documents. This document cannot be reproduced except in full, without prior written approval of the Company. Any unauthorized alteration, forgery or falsification of the content or appearance of this document is unlawful and offenders may be prosecuted to the fullest extent of the law.

Radar Type5_Trial4 for 5570MHz

Data Sheet for FCC Radar Type 5						
Trial Number:			4		VSG Frequency(MHz): 5570	
Number of Bursts in Trial:			8		Successful Detection: Yes	
Burst (8-20)	Number Pulses per Burst (1-3)	Pulse Width (50-100)	Chirp Width (5-20)	Pulse 1-to-2 Spacing	Pulse 2-to-3 Spacing	Starting Location Within Interval
		(μ sec)	(MHz)	(μ sec)	(μ sec)	(μ sec)
1	1	59.8	5			845339
2	1	65.7	5			1208624
3	2	70.7	5	1208.3		73525
4	2	72.4	5	1543.6		436604
5	2	72.4	5	961.6		800038
6	1	58.8	5			1164144
7	2	72.8	5	1723.2		28791
8	3	86.7	5	1407.3	1824.3	391341
9						
10						
11						
12						
13						
14						
15						
16						
17						
18						
19						
20						

Unless otherwise stated the results shown in this test report refer only to the sample(s) tested and such sample(s) are retained for 90 days only.

除非另有說明，此報告結果僅對測試之樣品負責，同時此樣品僅保留90天。本報告未經本公司書面許可，不可部份複製。

This document is issued by the Company subject to its General Conditions of Service printed overleaf, available on request or accessible at <http://www.sgs.com.tw/Terms-and-Conditions> and for electronic format documents, subject to Terms and Conditions for Electronic Documents at <http://www.sgs.com.tw/Terms-and-Conditions>. Attention is drawn to the limitation of liability, indemnification and jurisdiction issues defined therein. Any holder of this document is advised that information contained hereon reflects the Company's findings at the time of its intervention only and within the limits of Client's instructions, if any. The Company's sole responsibility is to its Client and this document does not exonerate parties to a transaction from exercising all their rights and obligations under the transaction documents. This document cannot be reproduced except in full, without prior written approval of the Company. Any unauthorized alteration, forgery or falsification of the content or appearance of this document is unlawful and offenders may be prosecuted to the fullest extent of the law.

Radar Type5_Trial5 for 5570MHz

Data Sheet for FCC Radar Type 5						
Trial Number:		5		VSG Frequency(MHz):		5570
Number of Bursts in Trial:			8		Successful Detection: Yes	
Burst (8-20)	Number Pulses per Burst (1-3)	Pulse Width (50-100)	Chirp Width (5-20)	Pulse 1-to-2 Spacing	Pulse 2-to-3 Spacing	Starting Location Within Interval
		(μ sec)	(MHz)	(μ sec)	(μ sec)	(μ sec)
1	2	71.5	5	1024.5		755079
2	3	88	5	1905	1547	1116130
3	3	89.4	5	1595.6	1232.6	1479179
4	3	97.7	5	1549.3	1090.3	346877
5	1	65.8	5			710997
6	1	61.7	5			1074422
7	2	76.6	5	1387.4		1436084
8	3	96.5	5	1571.5	925.5	302135
9						
10						
11						
12						
13						
14						
15						
16						
17						
18						
19						
20						

Unless otherwise stated the results shown in this test report refer only to the sample(s) tested and such sample(s) are retained for 90 days only.

除非另有說明，此報告結果僅對測試之樣品負責，同時此樣品僅保留90天。本報告未經本公司書面許可，不可部份複製。

This document is issued by the Company subject to its General Conditions of Service printed overleaf, available on request or accessible at <http://www.sgs.com.tw/Terms-and-Conditions> and for electronic format documents, subject to Terms and Conditions for Electronic Documents at <http://www.sgs.com.tw/Terms-and-Conditions>. Attention is drawn to the limitation of liability, indemnification and jurisdiction issues defined therein. Any holder of this document is advised that information contained hereon reflects the Company's findings at the time of its intervention only and within the limits of Client's instructions, if any. The Company's sole responsibility is to its Client and this document does not exonerate parties to a transaction from exercising all their rights and obligations under the transaction documents. This document cannot be reproduced except in full, without prior written approval of the Company. Any unauthorized alteration, forgery or falsification of the content or appearance of this document is unlawful and offenders may be prosecuted to the fullest extent of the law.

SGS Taiwan Ltd.

No.134,Wu Kung Road, New Taipei Industrial Park, Wuku District, New Taipei City, Taiwan/新北市五股區新北產業園區五工路 134 號

台灣檢驗科技股份有限公司

t (886-2) 2299-3279

f (886-2) 2298-0488

www.sgs.com.tw

Member of SGS Group

Radar Type5_Trial6 for 5570MHz

Data Sheet for FCC Radar Type 5						
Trial Number:			6	VSG Frequency(MHz):		5570
Number of Bursts in Trial:			14	Successful Detection:		Yes
Burst (8-20)	Number Pulses per Burst (1-3)	Pulse Width (50-100)	Chirp Width (5-20)	Pulse 1-to-2 Spacing	Pulse 2-to-3 Spacing	Starting Location Within Interval
		(μ sec)	(MHz)	(μ sec)	(μ sec)	(μ sec)
1	3	97	12	1506	1903	378573
2	3	96.3	12	926.7	1064.7	586348
3	3	86.5	12	1416.5	964.5	793292
4	2	79.6	12	1505.4		146992
5	3	84	12	1459	1858	353209
6	3	85	12	1028	1539	560501
7	2	71	12	1692		767848
8	2	76	12	1081		121542
9	1	57.9	12			329085
10	3	86.7	12	1679.3	1245.3	535068
11	3	88.6	12	1154.4	1637.4	741864
12	2	79.5	12	1696.5		95986
13	3	91.3	12	1797.7	1841.7	302190
14	2	76.8	12	1755.2		510022
15						
16						
17						
18						
19						
20						

Unless otherwise stated the results shown in this test report refer only to the sample(s) tested and such sample(s) are retained for 90 days only.

除非另有說明，此報告結果僅對測試之樣品負責，同時此樣品僅保留90天。本報告未經本公司書面許可，不可部份複製。

This document is issued by the Company subject to its General Conditions of Service printed overleaf, available on request or accessible at <http://www.sgs.com.tw/Terms-and-Conditions> and for electronic format documents, subject to Terms and Conditions for Electronic Documents at <http://www.sgs.com.tw/Terms-and-Conditions>. Attention is drawn to the limitation of liability, indemnification and jurisdiction issues defined therein. Any holder of this document is advised that information contained hereon reflects the Company's findings at the time of its intervention only and within the limits of Client's instructions, if any. The Company's sole responsibility is to its Client and this document does not exonerate parties to a transaction from exercising all their rights and obligations under the transaction documents. This document cannot be reproduced except in full, without prior written approval of the Company. Any unauthorized alteration, forgery or falsification of the content or appearance of this document is unlawful and offenders may be prosecuted to the fullest extent of the law.

Radar Type5_Trial7 for 5570MHz

Data Sheet for FCC Radar Type 5						
Trial Number:			7		VSG Frequency(MHz): 5570	
Number of Bursts in Trial:			13		Successful Detection: Yes	
Burst (8-20)	Number Pulses per Burst (1-3)	Pulse Width (50-100)	Chirp Width (5-20)	Pulse 1-to-2 Spacing	Pulse 2-to-3 Spacing	Starting Location Within Interval
		(μ sec)	(MHz)	(μ sec)	(μ sec)	(μ sec)
1	3	96.4	11	1752.6	1109.6	771194
2	1	51.4	11			76092
3	1	64.8	11			299489
4	1	65.3	11			522832
5	2	75.7	11	1670.3		745337
6	3	85.4	11	1250.6	979.6	48408
7	3	94	11	1772	1352	270970
8	2	68.1	11	1265.9		494746
9	2	81	11	1161		717983
10	3	87.4	11	1328.6	1906.6	20904
11	3	92.8	11	1267.2	1676.2	243688
12	3	88.6	11	1875.4	1638.4	465906
13	2	69.2	11	1282.8		690603
14						
15						
16						
17						
18						
19						
20						

Unless otherwise stated the results shown in this test report refer only to the sample(s) tested and such sample(s) are retained for 90 days only.

除非另有說明，此報告結果僅對測試之樣品負責，同時此樣品僅保留90天。本報告未經本公司書面許可，不可部份複製。

This document is issued by the Company subject to its General Conditions of Service printed overleaf, available on request or accessible at <http://www.sgs.com.tw/Terms-and-Conditions> and for electronic format documents, subject to Terms and Conditions for Electronic Documents at <http://www.sgs.com.tw/Terms-and-Conditions>. Attention is drawn to the limitation of liability, indemnification and jurisdiction issues defined therein. Any holder of this document is advised that information contained hereon reflects the Company's findings at the time of its intervention only and within the limits of Client's instructions, if any. The Company's sole responsibility is to its Client and this document does not exonerate parties to a transaction from exercising all their rights and obligations under the transaction documents. This document cannot be reproduced except in full, without prior written approval of the Company. Any unauthorized alteration, forgery or falsification of the content or appearance of this document is unlawful and offenders may be prosecuted to the fullest extent of the law.

SGS Taiwan Ltd. No.134,Wu Kung Road, New Taipei Industrial Park, Wuku District, New Taipei City, Taiwan/新北市五股區新北產業園區五工路 134 號

Radar Type5_Trial8 for 5570MHz

Data Sheet for FCC Radar Type 5						
Trial Number:		8		VSG Frequency(MHz):		5570
Number of Bursts in Trial:			11		Successful Detection: Yes	
Burst (8-20)	Number Pulses per Burst (1-3)	Pulse Width (50-100)	Chirp Width (5-20)	Pulse 1-to-2 Spacing	Pulse 2-to-3 Spacing	Starting Location Within Interval
		(μ sec)	(MHz)	(μ sec)	(μ sec)	(μ sec)
1	1	55.7	9			1081971
2	2	71.5	9	1428.5		256209
3	1	50.4	9			520922
4	2	72.7	9	1676.3		783872
5	2	78.8	9	1564.2		1047535
6	3	98	9	1686	1848	223101
7	2	78.1	9	1319.9		487378
8	1	56.6	9			752190
9	3	93.4	9	1339.6	1120.6	1013747
10	3	94.4	9	1471.6	1168.6	190967
11	2	71.9	9	1853.1		454777
12						
13						
14						
15						
16						
17						
18						
19						
20						

Unless otherwise stated the results shown in this test report refer only to the sample(s) tested and such sample(s) are retained for 90 days only.

除非另有說明，此報告結果僅對測試之樣品負責，同時此樣品僅保留90天。本報告未經本公司書面許可，不可部份複製。

This document is issued by the Company subject to its General Conditions of Service printed overleaf, available on request or accessible at <http://www.sgs.com.tw/Terms-and-Conditions> and for electronic format documents, subject to Terms and Conditions for Electronic Documents at <http://www.sgs.com.tw/Terms-and-Conditions>. Attention is drawn to the limitation of liability, indemnification and jurisdiction issues defined therein. Any holder of this document is advised that information contained hereon reflects the Company's findings at the time of its intervention only and within the limits of Client's instructions, if any. The Company's sole responsibility is to its Client and this document does not exonerate parties to a transaction from exercising all their rights and obligations under the transaction documents. This document cannot be reproduced except in full, without prior written approval of the Company. Any unauthorized alteration, forgery or falsification of the content or appearance of this document is unlawful and offenders may be prosecuted to the fullest extent of the law.

SGS Taiwan Ltd.

No.134,Wu Kung Road, New Taipei Industrial Park, Wuku District, New Taipei City, Taiwan/新北市五股區新北產業園區五工路 134 號

台灣檢驗科技股份有限公司

t (886-2) 2299-3279

f (886-2) 2298-0488

www.sgs.com.tw

Member of SGS Group

Radar Type5_Trial9 for 5570MHz

Data Sheet for FCC Radar Type 5						
Trial Number:			9		VSG Frequency(MHz): 5570	
Number of Bursts in Trial:			11		Successful Detection: Yes	
Burst (8-20)	Number Pulses per Burst (1-3)	Pulse Width (50-100)	Chirp Width (5-20)	Pulse 1-to-2 Spacing	Pulse 2-to-3 Spacing	Starting Location Within Interval
		(μ sec)	(MHz)	(μ sec)	(μ sec)	(μ sec)
1	3	96.5	8	1238.5	1767.5	717802
2	2	74.9	8	1820.1		982334
3	3	94.7	8	1012.3	1446.3	158509
4	3	94.8	8	1520.2	1653.2	421684
5	1	64.4	8			687423
6	3	85.8	8	960.2	1385.2	949648
7	2	70.2	8	1167.8		126134
8	3	93.3	8	943.7	1289.7	389725
9	3	95.4	8	1101.6	1896.6	652936
10	3	94.7	8	1841.3	1060.3	916384
11	3	91.7	8	1816.3	1181.3	93458
12						
13						
14						
15						
16						
17						
18						
19						
20						

Unless otherwise stated the results shown in this test report refer only to the sample(s) tested and such sample(s) are retained for 90 days only.

除非另有說明，此報告結果僅對測試之樣品負責，同時此樣品僅保留90天。本報告未經本公司書面許可，不可部份複製。

This document is issued by the Company subject to its General Conditions of Service printed overleaf, available on request or accessible at <http://www.sgs.com.tw/Terms-and-Conditions> and for electronic format documents, subject to Terms and Conditions for Electronic Documents at <http://www.sgs.com.tw/Terms-and-Conditions>. Attention is drawn to the limitation of liability, indemnification and jurisdiction issues defined therein. Any holder of this document is advised that information contained hereon reflects the Company's findings at the time of its intervention only and within the limits of Client's instructions, if any. The Company's sole responsibility is to its Client and this document does not exonerate parties to a transaction from exercising all their rights and obligations under the transaction documents. This document cannot be reproduced except in full, without prior written approval of the Company. Any unauthorized alteration, forgery or falsification of the content or appearance of this document is unlawful and offenders may be prosecuted to the fullest extent of the law.

Radar Type5_Trial10 for 5570MHz

Data Sheet for FCC Radar Type 5						
Trial Number:		10		VSG Frequency(MHz):		5570
Number of Bursts in Trial:			20		Successful Detection: Yes	
Burst (8-20)	Number Pulses per Burst (1-3)	Pulse Width (50-100)	Chirp Width (5-20)	Pulse 1-to-2 Spacing	Pulse 2-to-3 Spacing	Starting Location Within Interval
		(μ sec)	(MHz)	(μ sec)	(μ sec)	(μ sec)
1	3	87.9	20	1065.1	1054.1	195845
2	2	82.9	20	1649.1		340735
3	1	50.4	20			487164
4	3	86.1	20	1511.9	1327.9	33463
5	3	91.3	20	1333.7	1629.7	177985
6	1	52.4	20			324139
7	2	78.8	20	964.2		468273
8	1	65.2	20			15748
9	3	99.2	20	1105.8	1472.8	160137
10	3	86.9	20	1715.1	1671.1	304464
11	3	95.4	20	1764.6	1171.6	448919
12	1	65.8	20			596028
13	1	65.2	20			142978
14	1	54.5	20			287964
15	1	57.4	20			433443
16	1	64	20			578958
17	1	59.8	20			125123
18	2	81.5	20	1113.5		269660
19	1	63.1	20			415298
20	2	70.1	20	1113.9		559053

Unless otherwise stated the results shown in this test report refer only to the sample(s) tested and such sample(s) are retained for 90 days only.

除非另有說明，此報告結果僅對測試之樣品負責，同時此樣品僅保留90天。本報告未經本公司書面許可，不可部份複製。

This document is issued by the Company subject to its General Conditions of Service printed overleaf, available on request or accessible at <http://www.sgs.com.tw/Terms-and-Conditions> and for electronic format documents, subject to Terms and Conditions for Electronic Documents at <http://www.sgs.com.tw/Terms-and-Conditions>. Attention is drawn to the limitation of liability, indemnification and jurisdiction issues defined therein. Any holder of this document is advised that information contained hereon reflects the Company's findings at the time of its intervention only and within the limits of Client's instructions, if any. The Company's sole responsibility is to its Client and this document does not exonerate parties to a transaction from exercising all their rights and obligations under the transaction documents. This document cannot be reproduced except in full, without prior written approval of the Company. Any unauthorized alteration, forgery or falsification of the content or appearance of this document is unlawful and offenders may be prosecuted to the fullest extent of the law.

SGS Taiwan Ltd.

No.134,Wu Kung Road, New Taipei Industrial Park, Wuku District, New Taipei City, Taiwan/新北市五股區新北產業園區五工路 134 號

台灣檢驗科技股份有限公司

t (886-2) 2299-3279

f (886-2) 2298-0488

www.sgs.com.tw

Member of SGS Group

Radar Type5_Trial11 for 5570MHz

Data Sheet for FCC Radar Type 5						
Trial Number:		11		VSG Frequency(MHz):		5498.49
Number of Bursts in Trial:			15		Successful Detection: Yes	
Burst (8-20)	Number Pulses per Burst (1-3)	Pulse Width (50-100)	Chirp Width (5-20)	Pulse 1-to-2 Spacing	Pulse 2-to-3 Spacing	Starting Location Within Interval
		(μ sec)	(MHz)	(μ sec)	(μ sec)	(μ sec)
1	1	52.9	13			143103
2	1	57	13			336633
3	3	93	13	1786	1375	528454
4	2	68.8	13	1796.2		722576
5	1	50.7	13			119259
6	3	90.7	13	1150.3	1478.3	311911
7	3	99.3	13	1551.7	1326.7	504351
8	1	53.6	13			700354
9	3	95.3	13	1600.7	1466.7	95028
10	2	67.1	13	1419.9		288667
11	3	99.5	13	1883.5	1753.5	480592
12	3	93.2	13	1087.8	1551.8	673584
13	2	74.5	13	1562.5		71396
14	1	64.1	13			265211
15	3	83.6	13	1622.4	1038.4	457007
16						
17						
18						
19						
20						

Unless otherwise stated the results shown in this test report refer only to the sample(s) tested and such sample(s) are retained for 90 days only.

除非另有說明，此報告結果僅對測試之樣品負責，同時此樣品僅保留90天。本報告未經本公司書面許可，不可部份複製。

This document is issued by the Company subject to its General Conditions of Service printed overleaf, available on request or accessible at <http://www.sgs.com.tw/Terms-and-Conditions> and for electronic format documents, subject to Terms and Conditions for Electronic Documents at <http://www.sgs.com.tw/Terms-and-Conditions>. Attention is drawn to the limitation of liability, indemnification and jurisdiction issues defined therein. Any holder of this document is advised that information contained hereon reflects the Company's findings at the time of its intervention only and within the limits of Client's instructions, if any. The Company's sole responsibility is to its Client and this document does not exonerate parties to a transaction from exercising all their rights and obligations under the transaction documents. This document cannot be reproduced except in full, without prior written approval of the Company. Any unauthorized alteration, forgery or falsification of the content or appearance of this document is unlawful and offenders may be prosecuted to the fullest extent of the law.

Radar Type5_Trial12 for 5570MHz

Data Sheet for FCC Radar Type 5						
Trial Number:		12		VSG Frequency(MHz):		5496.49
Number of Bursts in Trial:			10		Successful Detection: Yes	
Burst (8-20)	Number Pulses per Burst (1-3)	Pulse Width (50-100)	Chirp Width (5-20)	Pulse 1-to-2 Spacing	Pulse 2-to-3 Spacing	Starting Location Within Interval
		(μ sec)	(MHz)	(μ sec)	(μ sec)	(μ sec)
1	2	67.5	8	1366.5		978633
2	2	72.3	8	1722.7		71453
3	3	92.8	8	1745.2	1601.2	361200
4	1	56.7	8			653086
5	2	75.7	8	1346.3		942117
6	2	77.9	8	1602.1		35724
7	2	78.1	8	933.9		326175
8	3	95.3	8	1766.7	1165.7	615613
9	3	85.1	8	1363.9	1704.9	905273
10	1	51.1	8			1198252
11						
12						
13						
14						
15						
16						
17						
18						
19						
20						

Unless otherwise stated the results shown in this test report refer only to the sample(s) tested and such sample(s) are retained for 90 days only.

除非另有說明，此報告結果僅對測試之樣品負責，同時此樣品僅保留90天。本報告未經本公司書面許可，不可部份複製。

This document is issued by the Company subject to its General Conditions of Service printed overleaf, available on request or accessible at <http://www.sgs.com.tw/Terms-and-Conditions> and for electronic format documents, subject to Terms and Conditions for Electronic Documents at <http://www.sgs.com.tw/Terms-and-Conditions>. Attention is drawn to the limitation of liability, indemnification and jurisdiction issues defined therein. Any holder of this document is advised that information contained hereon reflects the Company's findings at the time of its intervention only and within the limits of Client's instructions, if any. The Company's sole responsibility is to its Client and this document does not exonerate parties to a transaction from exercising all their rights and obligations under the transaction documents. This document cannot be reproduced except in full, without prior written approval of the Company. Any unauthorized alteration, forgery or falsification of the content or appearance of this document is unlawful and offenders may be prosecuted to the fullest extent of the law.

SGS Taiwan Ltd.

No.134,Wu Kung Road, New Taipei Industrial Park, Wuku District, New Taipei City, Taiwan/新北市五股區新北產業園區五工路 134 號

台灣檢驗科技股份有限公司

t (886-2) 2299-3279

f (886-2) 2298-0488

www.sgs.com.tw

Member of SGS Group

Radar Type5_Trial13 for 5570MHz

Data Sheet for FCC Radar Type 5						
Trial Number:		13		VSG Frequency(MHz):		5499.69
Number of Bursts in Trial:			17		Successful Detection: Yes	
Burst (8-20)	Number Pulses per Burst (1-3)	Pulse Width (50-100)	Chirp Width (5-20)	Pulse 1-to-2 Spacing	Pulse 2-to-3 Spacing	Starting Location Within Interval
		(μ sec)	(MHz)	(μ sec)	(μ sec)	(μ sec)
1	1	59	16			170817
2	2	79.5	16	990.5		341357
3	3	90.3	16	1075.7	1220.7	510526
4	1	57	16			683467
5	2	71.8	16	1218.2		149404
6	1	60.4	16			320410
7	1	61.8	16			491519
8	2	82.3	16	1727.7		660636
9	2	74.5	16	1601.5		128495
10	3	88.7	16	975.3	1412.3	298307
11	2	80.8	16	1746.2		469475
12	3	90	16	1030	1551	638300
13	2	81.6	16	1088.4		107469
14	3	85.3	16	1827.7	1324.7	277145
15	1	50.6	16			449387
16	1	53.2	16			620125
17	2	75.1	16	1843.9		86364
18						
19						
20						

Unless otherwise stated the results shown in this test report refer only to the sample(s) tested and such sample(s) are retained for 90 days only.

除非另有說明，此報告結果僅對測試之樣品負責，同時此樣品僅保留90天。本報告未經本公司書面許可，不可部份複製。

This document is issued by the Company subject to its General Conditions of Service printed overleaf, available on request or accessible at <http://www.sgs.com.tw/Terms-and-Conditions> and for electronic format documents, subject to Terms and Conditions for Electronic Documents at <http://www.sgs.com.tw/Terms-and-Conditions>. Attention is drawn to the limitation of liability, indemnification and jurisdiction issues defined therein. Any holder of this document is advised that information contained hereon reflects the Company's findings at the time of its intervention only and within the limits of Client's instructions, if any. The Company's sole responsibility is to its Client and this document does not exonerate parties to a transaction from exercising all their rights and obligations under the transaction documents. This document cannot be reproduced except in full, without prior written approval of the Company. Any unauthorized alteration, forgery or falsification of the content or appearance of this document is unlawful and offenders may be prosecuted to the fullest extent of the law.

Radar Type5_Trial14 for 5570MHz

Data Sheet for FCC Radar Type 5						
Trial Number:		14		VSG Frequency(MHz):		5501.29
Number of Bursts in Trial:			20		Successful Detection: Yes	
Burst (8-20)	Number Pulses per Burst (1-3)	Pulse Width (50-100)	Chirp Width (5-20)	Pulse 1-to-2 Spacing	Pulse 2-to-3 Spacing	Starting Location Within Interval
		(μ sec)	(MHz)	(μ sec)	(μ sec)	(μ sec)
1	2	70	20	1015		218197
2	2	82	20	1063		363178
3	3	87.4	20	1016.6	1573.6	506900
4	1	52.2	20			55765
5	3	91.3	20	1392.7	1490.7	199823
6	1	51	20			346092
7	2	70.9	20	1197.1		490061
8	3	89.9	20	1240.1	1198.1	37702
9	3	91.8	20	1314.2	999.2	182230
10	2	67.1	20	1850.9		326990
11	2	74.7	20	1018.3		472340
12	3	87.5	20	916.5	1912.5	19883
13	3	92.3	20	1126.7	1650.7	164207
14	2	74.8	20	1634.2		309633
15	1	61.7	20			455707
16	1	57.8	20			2102
17	2	67.7	20	1674.3		146931
18	3	91.8	20	1452.2	1631.2	290728
19	1	61.1	20			437450
20	1	58.9	20			582293

Unless otherwise stated the results shown in this test report refer only to the sample(s) tested and such sample(s) are retained for 90 days only.

除非另有說明，此報告結果僅對測試之樣品負責，同時此樣品僅保留90天。本報告未經本公司書面許可，不可部份複製。

This document is issued by the Company subject to its General Conditions of Service printed overleaf, available on request or accessible at <http://www.sgs.com.tw/Terms-and-Conditions> and for electronic format documents, subject to Terms and Conditions for Electronic Documents at <http://www.sgs.com.tw/Terms-and-Conditions>. Attention is drawn to the limitation of liability, indemnification and jurisdiction issues defined therein. Any holder of this document is advised that information contained hereon reflects the Company's findings at the time of its intervention only and within the limits of Client's instructions, if any. The Company's sole responsibility is to its Client and this document does not exonerate parties to a transaction from exercising all their rights and obligations under the transaction documents. This document cannot be reproduced except in full, without prior written approval of the Company. Any unauthorized alteration, forgery or falsification of the content or appearance of this document is unlawful and offenders may be prosecuted to the fullest extent of the law.

Radar Type5_Trial15 for 5570MHz

Data Sheet for FCC Radar Type 5						
Trial Number:		15		VSG Frequency(MHz):		5499.29
Number of Bursts in Trial:			16		Successful Detection: Yes	
Burst (8-20)	Number Pulses per Burst (1-3)	Pulse Width (50-100)	Chirp Width (5-20)	Pulse 1-to-2 Spacing	Pulse 2-to-3 Spacing	Starting Location Within Interval
		(μ sec)	(MHz)	(μ sec)	(μ sec)	(μ sec)
1	3	96.7	15	1581.3	1271.3	161051
2	2	73.5	15	1917.5		342354
3	1	56.7	15			524731
4	3	87.7	15	1898.3	1496.3	703120
5	1	60.8	15			139360
6	3	100	15	1513	1072	319792
7	2	75.5	15	1704.5		501115
8	1	52.7	15			683650
9	2	77.6	15	1511.4		116904
10	3	90.7	15	1515.3	1368.3	297489
11	1	57.4	15			480050
12	1	56.1	15			661425
13	2	72.5	15	1240.5		94607
14	1	52.8	15			276358
15	1	58.1	15			458076
16	1	63.3	15			639282
17						
18						
19						
20						

Unless otherwise stated the results shown in this test report refer only to the sample(s) tested and such sample(s) are retained for 90 days only.

除非另有說明，此報告結果僅對測試之樣品負責，同時此樣品僅保留90天。本報告未經本公司書面許可，不可部份複製。

This document is issued by the Company subject to its General Conditions of Service printed overleaf, available on request or accessible at <http://www.sgs.com.tw/Terms-and-Conditions> and for electronic format documents, subject to Terms and Conditions for Electronic Documents at <http://www.sgs.com.tw/Terms-and-Conditions>. Attention is drawn to the limitation of liability, indemnification and jurisdiction issues defined therein. Any holder of this document is advised that information contained hereon reflects the Company's findings at the time of its intervention only and within the limits of Client's instructions, if any. The Company's sole responsibility is to its Client and this document does not exonerate parties to a transaction from exercising all their rights and obligations under the transaction documents. This document cannot be reproduced except in full, without prior written approval of the Company. Any unauthorized alteration, forgery or falsification of the content or appearance of this document is unlawful and offenders may be prosecuted to the fullest extent of the law.

SGS Taiwan Ltd.

No.134,Wu Kung Road, New Taipei Industrial Park, Wuku District, New Taipei City, Taiwan/新北市五股區新北產業園區五工路 134 號

台灣檢驗科技股份有限公司

t (886-2) 2299-3279

f (886-2) 2298-0488

www.sgs.com.tw

Member of SGS Group

Radar Type5_Trial16 for 5570MHz

Data Sheet for FCC Radar Type 5						
Trial Number:		16		VSG Frequency(MHz):		5500.89
Number of Bursts in Trial:			19		Successful Detection: Yes	
Burst (8-20)	Number Pulses per Burst (1-3)	Pulse Width (50-100)	Chirp Width (5-20)	Pulse 1-to-2 Spacing	Pulse 2-to-3 Spacing	Starting Location Within Interval
		(μ sec)	(MHz)	(μ sec)	(μ sec)	(μ sec)
1	3	97.8	19	1035.2	1109.2	60664
2	3	98.9	19	1349.1	1179.1	212758
3	2	67.7	19	1877.3		365185
4	2	78.4	19	1897.6		517638
5	2	69.3	19	1353.7		42020
6	2	67.1	19	1256.9		194546
7	2	80.1	19	1704.9		346961
8	3	93.4	19	935.6	1527.6	498702
9	3	87.1	19	1769.9	1303.9	23150
10	3	94.9	19	1043.1	1752.1	175148
11	2	82.3	19	1429.7		328193
12	1	63.8	19			481836
13	2	69	19	1717		4428
14	2	82.1	19	1509.9		156800
15	1	63.9	19			310290
16	3	93.6	19	1131.4	1715.4	460941
17	3	89.5	19	1035.5	927.5	613436
18	3	94.3	19	1285.7	1082.7	137818
19	2	78.4	19	1681.6		290315
20						

Unless otherwise stated the results shown in this test report refer only to the sample(s) tested and such sample(s) are retained for 90 days only.

除非另有說明，此報告結果僅對測試之樣品負責，同時此樣品僅保留90天。本報告未經本公司書面許可，不可部份複製。

This document is issued by the Company subject to its General Conditions of Service printed overleaf, available on request or accessible at <http://www.sgs.com.tw/Terms-and-Conditions> and for electronic format documents, subject to Terms and Conditions for Electronic Documents at <http://www.sgs.com.tw/Terms-and-Conditions>. Attention is drawn to the limitation of liability, indemnification and jurisdiction issues defined therein. Any holder of this document is advised that information contained hereon reflects the Company's findings at the time of its intervention only and within the limits of Client's instructions, if any. The Company's sole responsibility is to its Client and this document does not exonerate parties to a transaction from exercising all their rights and obligations under the transaction documents. This document cannot be reproduced except in full, without prior written approval of the Company. Any unauthorized alteration, forgery or falsification of the content or appearance of this document is unlawful and offenders may be prosecuted to the fullest extent of the law.

Radar Type5_Trial17 for 5570MHz

Data Sheet for FCC Radar Type 5						
Trial Number:		17		VSG Frequency(MHz):		5496.09
Number of Bursts in Trial:			10		Successful Detection: Yes	
Burst (8-20)	Number Pulses per Burst (1-3)	Pulse Width (50-100)	Chirp Width (5-20)	Pulse 1-to-2 Spacing	Pulse 2-to-3 Spacing	Starting Location Within Interval
		(μ sec)	(MHz)	(μ sec)	(μ sec)	(μ sec)
1	3	96.6	7	1648.4	1865.4	841832
2	2	75.3	7	1301.7		1134370
3	3	99.8	7	1691.2	928.2	226986
4	3	91.4	7	1351.6	1845.6	516768
5	3	91.3	7	1507.7	1109.7	806793
6	2	75.6	7	1497.4		1097643
7	2	68.2	7	1628.8		191388
8	1	62.3	7			482197
9	1	51	7			773239
10	1	59.6	7			1063311
11						
12						
13						
14						
15						
16						
17						
18						
19						
20						

Unless otherwise stated the results shown in this test report refer only to the sample(s) tested and such sample(s) are retained for 90 days only.

除非另有說明，此報告結果僅對測試之樣品負責，同時此樣品僅保留90天。本報告未經本公司書面許可，不可部份複製。

This document is issued by the Company subject to its General Conditions of Service printed overleaf, available on request or accessible at <http://www.sgs.com.tw/Terms-and-Conditions> and for electronic format documents, subject to Terms and Conditions for Electronic Documents at <http://www.sgs.com.tw/Terms-and-Conditions>. Attention is drawn to the limitation of liability, indemnification and jurisdiction issues defined therein. Any holder of this document is advised that information contained hereon reflects the Company's findings at the time of its intervention only and within the limits of Client's instructions, if any. The Company's sole responsibility is to its Client and this document does not exonerate parties to a transaction from exercising all their rights and obligations under the transaction documents. This document cannot be reproduced except in full, without prior written approval of the Company. Any unauthorized alteration, forgery or falsification of the content or appearance of this document is unlawful and offenders may be prosecuted to the fullest extent of the law.

Radar Type5_Trial18 for 5570MHz

Data Sheet for FCC Radar Type 5						
Trial Number:		18		VSG Frequency(MHz):		5498.49
Number of Bursts in Trial:			14		Successful Detection: Yes	
Burst (8-20)	Number Pulses per Burst (1-3)	Pulse Width (50-100)	Chirp Width (5-20)	Pulse 1-to-2 Spacing	Pulse 2-to-3 Spacing	Starting Location Within Interval
		(μ sec)	(MHz)	(μ sec)	(μ sec)	(μ sec)
1	2	68.6	13	1499.4		111159
2	1	64.9	13			318639
3	3	89.4	13	1225.6	1206.6	525016
4	2	66.7	13	1407.3		732895
5	3	98.5	13	1094.5	1290.5	85461
6	1	60.1	13			293098
7	2	68.9	13	1207.1		499889
8	2	74	13	1650		706709
9	2	82.7	13	937.3		60119
10	3	89.7	13	913.3	1511.3	266981
11	2	79.6	13	1323.4		474208
12	3	93.4	13	1709.6	922.6	680794
13	1	63.3	13			34618
14	1	50.5	13			242067
15						
16						
17						
18						
19						
20						

Unless otherwise stated the results shown in this test report refer only to the sample(s) tested and such sample(s) are retained for 90 days only.

除非另有說明，此報告結果僅對測試之樣品負責，同時此樣品僅保留90天。本報告未經本公司書面許可，不可部份複製。

This document is issued by the Company subject to its General Conditions of Service printed overleaf, available on request or accessible at <http://www.sgs.com.tw/Terms-and-Conditions> and for electronic format documents, subject to Terms and Conditions for Electronic Documents at <http://www.sgs.com.tw/Terms-and-Conditions>. Attention is drawn to the limitation of liability, indemnification and jurisdiction issues defined therein. Any holder of this document is advised that information contained hereon reflects the Company's findings at the time of its intervention only and within the limits of Client's instructions, if any. The Company's sole responsibility is to its Client and this document does not exonerate parties to a transaction from exercising all their rights and obligations under the transaction documents. This document cannot be reproduced except in full, without prior written approval of the Company. Any unauthorized alteration, forgery or falsification of the content or appearance of this document is unlawful and offenders may be prosecuted to the fullest extent of the law.

Radar Type5_Trial19 for 5570MHz

Data Sheet for FCC Radar Type 5						
Trial Number:		19		VSG Frequency(MHz):		5496.89
Number of Bursts in Trial:			11		Successful Detection: Yes	
Burst (8-20)	Number Pulses per Burst (1-3)	Pulse Width (50-100)	Chirp Width (5-20)	Pulse 1-to-2 Spacing	Pulse 2-to-3 Spacing	Starting Location Within Interval
		(μ sec)	(MHz)	(μ sec)	(μ sec)	(μ sec)
1	1	66	9			572486
2	2	67.7	9	1512.3		835382
3	1	61.6	9			11536
4	3	83.7	9	963.3	1336.3	275055
5	3	95.5	9	1832.5	1354.5	538089
6	2	76.8	9	1049.2		803017
7	1	63.9	9			1068197
8	2	66.7	9	1203.3		242891
9	2	78.3	9	998.7		507034
10	2	74.4	9	1755.6		770438
11	1	61.5	9			1035902
12						
13						
14						
15						
16						
17						
18						
19						
20						

Unless otherwise stated the results shown in this test report refer only to the sample(s) tested and such sample(s) are retained for 90 days only.

除非另有說明，此報告結果僅對測試之樣品負責，同時此樣品僅保留90天。本報告未經本公司書面許可，不可部份複製。

This document is issued by the Company subject to its General Conditions of Service printed overleaf, available on request or accessible at <http://www.sgs.com.tw/Terms-and-Conditions> and for electronic format documents, subject to Terms and Conditions for Electronic Documents at <http://www.sgs.com.tw/Terms-and-Conditions>. Attention is drawn to the limitation of liability, indemnification and jurisdiction issues defined therein. Any holder of this document is advised that information contained hereon reflects the Company's findings at the time of its intervention only and within the limits of Client's instructions, if any. The Company's sole responsibility is to its Client and this document does not exonerate parties to a transaction from exercising all their rights and obligations under the transaction documents. This document cannot be reproduced except in full, without prior written approval of the Company. Any unauthorized alteration, forgery or falsification of the content or appearance of this document is unlawful and offenders may be prosecuted to the fullest extent of the law.

Radar Type5_Trial20 for 5570MHz

Data Sheet for FCC Radar Type 5						
Trial Number:		20		VSG Frequency(MHz):		5499.69
Number of Bursts in Trial:			17		Successful Detection: Yes	
Burst (8-20)	Number Pulses per Burst (1-3)	Pulse Width (50-100)	Chirp Width (5-20)	Pulse 1-to-2 Spacing	Pulse 2-to-3 Spacing	Starting Location Within Interval
		(μ sec)	(MHz)	(μ sec)	(μ sec)	(μ sec)
1	3	88	16	1256	919	135783
2	3	98	16	1506	1371	305527
3	1	57.4	16			478186
4	2	76.4	16	1773.6		646724
5	1	52.8	16			115148
6	1	51	16			285926
7	1	54.8	16			456935
8	2	79	16	1222		626758
9	3	83.8	16	1125.2	1487.2	93692
10	2	68.5	16	1802.5		264129
11	2	79.9	16	1904.1		434598
12	3	92.9	16	1398.1	1123.1	604219
13	3	97.1	16	1045.9	1166.9	72856
14	2	70.6	16	1757.4		243445
15	2	72	16	1359		413877
16	3	95	16	1255	1652	582964
17	2	69.5	16	1837.5		51895
18						
19						
20						

Unless otherwise stated the results shown in this test report refer only to the sample(s) tested and such sample(s) are retained for 90 days only.

除非另有說明，此報告結果僅對測試之樣品負責，同時此樣品僅保留90天。本報告未經本公司書面許可，不可部份複製。

This document is issued by the Company subject to its General Conditions of Service printed overleaf, available on request or accessible at <http://www.sgs.com.tw/Terms-and-Conditions> and for electronic format documents, subject to Terms and Conditions for Electronic Documents at <http://www.sgs.com.tw/Terms-and-Conditions>. Attention is drawn to the limitation of liability, indemnification and jurisdiction issues defined therein. Any holder of this document is advised that information contained hereon reflects the Company's findings at the time of its intervention only and within the limits of Client's instructions, if any. The Company's sole responsibility is to its Client and this document does not exonerate parties to a transaction from exercising all their rights and obligations under the transaction documents. This document cannot be reproduced except in full, without prior written approval of the Company. Any unauthorized alteration, forgery or falsification of the content or appearance of this document is unlawful and offenders may be prosecuted to the fullest extent of the law.

Radar Type5_Trial21 for 5570MHz

Data Sheet for FCC Radar Type 5						
Trial Number:		21		VSG Frequency(MHz):		5644.31
Number of Bursts in Trial:			9		Successful Detection: Yes	
Burst (8-20)	Number Pulses per Burst (1-3)	Pulse Width (50-100)	Chirp Width (5-20)	Pulse 1-to-2 Spacing	Pulse 2-to-3 Spacing	Starting Location Within Interval
		(μ sec)	(MHz)	(μ sec)	(μ sec)	(μ sec)
1	1	56.7	6			421551
2	1	54.5	6			744478
3	3	98.9	6	1286.1	1719.1	1064529
4	1	53.1	6			58608
5	1	61.9	6			381621
6	3	99.2	6	1156.8	1217.8	703403
7	2	75.4	6	1653.6		1026298
8	2	73.6	6	1185.4		18794
9	1	64	6			341945
10						
11						
12						
13						
14						
15						
16						
17						
18						
19						
20						

Unless otherwise stated the results shown in this test report refer only to the sample(s) tested and such sample(s) are retained for 90 days only.

除非另有說明，此報告結果僅對測試之樣品負責，同時此樣品僅保留90天。本報告未經本公司書面許可，不可部份複製。

This document is issued by the Company subject to its General Conditions of Service printed overleaf, available on request or accessible at <http://www.sgs.com.tw/Terms-and-Conditions> and for electronic format documents, subject to Terms and Conditions for Electronic Documents at <http://www.sgs.com.tw/Terms-and-Conditions>. Attention is drawn to the limitation of liability, indemnification and jurisdiction issues defined therein. Any holder of this document is advised that information contained hereon reflects the Company's findings at the time of its intervention only and within the limits of Client's instructions, if any. The Company's sole responsibility is to its Client and this document does not exonerate parties to a transaction from exercising all their rights and obligations under the transaction documents. This document cannot be reproduced except in full, without prior written approval of the Company. Any unauthorized alteration, forgery or falsification of the content or appearance of this document is unlawful and offenders may be prosecuted to the fullest extent of the law.

SGS Taiwan Ltd.

No.134,Wu Kung Road, New Taipei Industrial Park, Wuku District, New Taipei City, Taiwan/新北市五股區新北產業園區五工路 134 號

台灣檢驗科技股份有限公司

t (886-2) 2299-3279

f (886-2) 2298-0488

www.sgs.com.tw

Member of SGS Group

Radar Type5_Trial22 for 5570MHz

Data Sheet for FCC Radar Type 5						
Trial Number:		22		VSG Frequency(MHz):		5641.51
Number of Bursts in Trial:			14		Successful Detection: Yes	
Burst (8-20)	Number Pulses per Burst (1-3)	Pulse Width (50-100)	Chirp Width (5-20)	Pulse 1-to-2 Spacing	Pulse 2-to-3 Spacing	Starting Location Within Interval
		(μ sec)	(MHz)	(μ sec)	(μ sec)	(μ sec)
1	3	84.5	13	1021.5	1628.5	425699
2	2	66.8	13	1144.2		633700
3	2	74.3	13	1140.7		840682
4	3	95.7	13	904.3	958.3	193640
5	1	51.9	13			401335
6	3	86.7	13	1253.3	1160.3	607151
7	1	64.9	13			816306
8	1	55.2	13			168523
9	1	60.5	13			376178
10	1	62.1	13			583300
11	1	61.4	13			791044
12	3	97.6	13	1516.4	1265.4	142362
13	2	79.9	13	1880.1		349568
14	3	88.6	13	1675.4	1030.4	556281
15						
16						
17						
18						
19						
20						

Unless otherwise stated the results shown in this test report refer only to the sample(s) tested and such sample(s) are retained for 90 days only.

除非另有說明，此報告結果僅對測試之樣品負責，同時此樣品僅保留90天。本報告未經本公司書面許可，不可部份複製。

This document is issued by the Company subject to its General Conditions of Service printed overleaf, available on request or accessible at <http://www.sgs.com.tw/Terms-and-Conditions> and for electronic format documents, subject to Terms and Conditions for Electronic Documents at <http://www.sgs.com.tw/Terms-and-Conditions>. Attention is drawn to the limitation of liability, indemnification and jurisdiction issues defined therein. Any holder of this document is advised that information contained hereon reflects the Company's findings at the time of its intervention only and within the limits of Client's instructions, if any. The Company's sole responsibility is to its Client and this document does not exonerate parties to a transaction from exercising all their rights and obligations under the transaction documents. This document cannot be reproduced except in full, without prior written approval of the Company. Any unauthorized alteration, forgery or falsification of the content or appearance of this document is unlawful and offenders may be prosecuted to the fullest extent of the law.

SGS Taiwan Ltd.

No.134,Wu Kung Road, New Taipei Industrial Park, Wuku District, New Taipei City, Taiwan/新北市五股區新北產業園區五工路 134 號

台灣檢驗科技股份有限公司

t (886-2) 2299-3279

f (886-2) 2298-0488

www.sgs.com.tw

Member of SGS Group

Radar Type5_Trial23 for 5570MHz

Data Sheet for FCC Radar Type 5						
Trial Number:		23		VSG Frequency(MHz):		5641.11
Number of Bursts in Trial:			15		Successful Detection: Yes	
Burst (8-20)	Number Pulses per Burst (1-3)	Pulse Width (50-100)	Chirp Width (5-20)	Pulse 1-to-2 Spacing	Pulse 2-to-3 Spacing	Starting Location Within Interval
		(μ sec)	(MHz)	(μ sec)	(μ sec)	(μ sec)
1	2	74.8	14	1903.2		712954
2	1	64.4	14			109577
3	2	79.6	14	947.4		302690
4	2	82.1	14	1141.9		496146
5	3	86.2	14	1236.8	989.8	688037
6	2	74.8	14	1243.2		85509
7	1	64.5	14			279236
8	1	63.1	14			472748
9	2	73.5	14	1362.5		665464
10	2	81.8	14	1385.2		61664
11	3	94.4	14	1855.6	961.6	254652
12	1	59.9	14			449055
13	2	73.7	14	1136.3		641555
14	2	75.6	14	1761.4		37890
15	1	58.4	14			231571
16						
17						
18						
19						
20						

Unless otherwise stated the results shown in this test report refer only to the sample(s) tested and such sample(s) are retained for 90 days only.

除非另有說明，此報告結果僅對測試之樣品負責，同時此樣品僅保留90天。本報告未經本公司書面許可，不可部份複製。

This document is issued by the Company subject to its General Conditions of Service printed overleaf, available on request or accessible at <http://www.sgs.com.tw/Terms-and-Conditions> and for electronic format documents, subject to Terms and Conditions for Electronic Documents at <http://www.sgs.com.tw/Terms-and-Conditions>. Attention is drawn to the limitation of liability, indemnification and jurisdiction issues defined therein. Any holder of this document is advised that information contained hereon reflects the Company's findings at the time of its intervention only and within the limits of Client's instructions, if any. The Company's sole responsibility is to its Client and this document does not exonerate parties to a transaction from exercising all their rights and obligations under the transaction documents. This document cannot be reproduced except in full, without prior written approval of the Company. Any unauthorized alteration, forgery or falsification of the content or appearance of this document is unlawful and offenders may be prosecuted to the fullest extent of the law.

Radar Type5_Trial24 for 5570MHz

Data Sheet for FCC Radar Type 5						
Trial Number:		24		VSG Frequency(MHz):		5644.31
Number of Bursts in Trial:			9		Successful Detection: Yes	
Burst (8-20)	Number Pulses per Burst (1-3)	Pulse Width (50-100)	Chirp Width (5-20)	Pulse 1-to-2 Spacing	Pulse 2-to-3 Spacing	Starting Location Within Interval
		(μ sec)	(MHz)	(μ sec)	(μ sec)	(μ sec)
1	2	76.1	6	1613.9		708682
2	3	98.8	6	973.2	1563.2	1030464
3	2	82.1	6	1484.9		23490
4	1	52.8	6			346421
5	3	88.9	6	1759.1	1530.1	667789
6	1	66.6	6			992268
7	3	88	6	1717	1899	1311409
8	1	54.6	6			306766
9	3	88.1	6	1901.9	1340.9	628217
10						
11						
12						
13						
14						
15						
16						
17						
18						
19						
20						

Unless otherwise stated the results shown in this test report refer only to the sample(s) tested and such sample(s) are retained for 90 days only.

除非另有說明，此報告結果僅對測試之樣品負責，同時此樣品僅保留90天。本報告未經本公司書面許可，不可部份複製。

This document is issued by the Company subject to its General Conditions of Service printed overleaf, available on request or accessible at <http://www.sgs.com.tw/Terms-and-Conditions> and for electronic format documents, subject to Terms and Conditions for Electronic Documents at <http://www.sgs.com.tw/Terms-and-Conditions>. Attention is drawn to the limitation of liability, indemnification and jurisdiction issues defined therein. Any holder of this document is advised that information contained hereon reflects the Company's findings at the time of its intervention only and within the limits of Client's instructions, if any. The Company's sole responsibility is to its Client and this document does not exonerate parties to a transaction from exercising all their rights and obligations under the transaction documents. This document cannot be reproduced except in full, without prior written approval of the Company. Any unauthorized alteration, forgery or falsification of the content or appearance of this document is unlawful and offenders may be prosecuted to the fullest extent of the law.

SGS Taiwan Ltd.

No.134,Wu Kung Road, New Taipei Industrial Park, Wuku District, New Taipei City, Taiwan/新北市五股區新北產業園區五工路 134 號

台灣檢驗科技股份有限公司

t (886-2) 2299-3279

f (886-2) 2298-0488

www.sgs.com.tw

Member of SGS Group

Radar Type5_Trial25 for 5570MHz

Data Sheet for FCC Radar Type 5						
Trial Number:		25		VSG Frequency(MHz):		5642.71
Number of Bursts in Trial:			12		Successful Detection: Yes	
Burst (8-20)	Number Pulses per Burst (1-3)	Pulse Width (50-100)	Chirp Width (5-20)	Pulse 1-to-2 Spacing	Pulse 2-to-3 Spacing	Starting Location Within Interval
		(μ sec)	(MHz)	(μ sec)	(μ sec)	(μ sec)
1	1	66.5	10			713981
2	3	93.2	10	1318.8	1383.8	954060
3	2	77.9	10	1604.1		199837
4	3	91.9	10	1294.1	1759.1	440713
5	1	60	10			684224
6	1	59.8	10			926991
7	3	83.6	10	1361.4	1524.4	169870
8	2	72	10	1008		411973
9	2	76.9	10	1546.1		653647
10	1	65.9	10			896784
11	2	74	10	1743		140278
12	3	88.8	10	1123.2	978.2	381664
13						
14						
15						
16						
17						
18						
19						
20						

Unless otherwise stated the results shown in this test report refer only to the sample(s) tested and such sample(s) are retained for 90 days only.

除非另有說明，此報告結果僅對測試之樣品負責，同時此樣品僅保留90天。本報告未經本公司書面許可，不可部份複製。

This document is issued by the Company subject to its General Conditions of Service printed overleaf, available on request or accessible at <http://www.sgs.com.tw/Terms-and-Conditions> and for electronic format documents, subject to Terms and Conditions for Electronic Documents at <http://www.sgs.com.tw/Terms-and-Conditions>. Attention is drawn to the limitation of liability, indemnification and jurisdiction issues defined therein. Any holder of this document is advised that information contained hereon reflects the Company's findings at the time of its intervention only and within the limits of Client's instructions, if any. The Company's sole responsibility is to its Client and this document does not exonerate parties to a transaction from exercising all their rights and obligations under the transaction documents. This document cannot be reproduced except in full, without prior written approval of the Company. Any unauthorized alteration, forgery or falsification of the content or appearance of this document is unlawful and offenders may be prosecuted to the fullest extent of the law.

Radar Type5_Trial26 for 5570MHz

Data Sheet for FCC Radar Type 5						
Trial Number:		26		VSG Frequency(MHz):		5641.11
Number of Bursts in Trial:			15		Successful Detection: Yes	
Burst (8-20)	Number Pulses per Burst (1-3)	Pulse Width (50-100)	Chirp Width (5-20)	Pulse 1-to-2 Spacing	Pulse 2-to-3 Spacing	Starting Location Within Interval
		(μ sec)	(MHz)	(μ sec)	(μ sec)	(μ sec)
1	2	82.4	14	1229.6		498536
2	2	67.1	14	1773.9		692019
3	3	89.3	14	1756.7	1617.7	88107
4	3	98.9	14	1600.1	1443.1	281127
5	3	99.5	14	1867.5	1028.5	474098
6	2	71.4	14	1023.6		668574
7	3	93.3	14	1751.7	1007.7	64396
8	3	92.6	14	1705.4	1299.4	257232
9	1	51.2	14			451923
10	3	92	14	1685	1843	642653
11	1	63	14			40796
12	3	89.4	14	1839.6	1564.6	233502
13	3	96.9	14	1282.1	1638.1	426399
14	3	84.5	14	1494.5	1024.5	619777
15	1	63.3	14			16934
16						
17						
18						
19						
20						

Unless otherwise stated the results shown in this test report refer only to the sample(s) tested and such sample(s) are retained for 90 days only.

除非另有說明，此報告結果僅對測試之樣品負責，同時此樣品僅保留90天。本報告未經本公司書面許可，不可部份複製。

This document is issued by the Company subject to its General Conditions of Service printed overleaf, available on request or accessible at <http://www.sgs.com.tw/Terms-and-Conditions> and for electronic format documents, subject to Terms and Conditions for Electronic Documents at <http://www.sgs.com.tw/Terms-and-Conditions>. Attention is drawn to the limitation of liability, indemnification and jurisdiction issues defined therein. Any holder of this document is advised that information contained hereon reflects the Company's findings at the time of its intervention only and within the limits of Client's instructions, if any. The Company's sole responsibility is to its Client and this document does not exonerate parties to a transaction from exercising all their rights and obligations under the transaction documents. This document cannot be reproduced except in full, without prior written approval of the Company. Any unauthorized alteration, forgery or falsification of the content or appearance of this document is unlawful and offenders may be prosecuted to the fullest extent of the law.

Radar Type5_Trial27 for 5570MHz

Data Sheet for FCC Radar Type 5						
Trial Number:		27		VSG Frequency(MHz):		5640.31
Number of Bursts in Trial:			17		Successful Detection: Yes	
Burst (8-20)	Number Pulses per Burst (1-3)	Pulse Width (50-100)	Chirp Width (5-20)	Pulse 1-to-2 Spacing	Pulse 2-to-3 Spacing	Starting Location Within Interval
		(μ sec)	(MHz)	(μ sec)	(μ sec)	(μ sec)
1	2	79.4	16	1554.6		185404
2	3	94.8	16	1571.2	1078.2	355243
3	3	91.1	16	1445.9	1467.9	524957
4	2	72	16	1706		696602
5	3	86.8	16	1170.2	1767.2	164009
6	1	59.7	16			335368
7	3	91.5	16	1447.5	1197.5	504553
8	1	65.5	16			677665
9	3	93	16	978	1696	143140
10	3	96.9	16	1185.1	1071.1	313396
11	2	72.6	16	976.4		484806
12	1	53	16			655886
13	1	63.7	16			122700
14	3	98.2	16	939.8	1156.8	292699
15	2	72.4	16	1661.6		463032
16	2	83.1	16	955.9		633961
17	1	57.7	16			101592
18						
19						
20						

Unless otherwise stated the results shown in this test report refer only to the sample(s) tested and such sample(s) are retained for 90 days only.

除非另有說明，此報告結果僅對測試之樣品負責，同時此樣品僅保留90天。本報告未經本公司書面許可，不可部份複製。

This document is issued by the Company subject to its General Conditions of Service printed overleaf, available on request or accessible at <http://www.sgs.com.tw/Terms-and-Conditions> and for electronic format documents, subject to Terms and Conditions for Electronic Documents at <http://www.sgs.com.tw/Terms-and-Conditions>. Attention is drawn to the limitation of liability, indemnification and jurisdiction issues defined therein. Any holder of this document is advised that information contained hereon reflects the Company's findings at the time of its intervention only and within the limits of Client's instructions, if any. The Company's sole responsibility is to its Client and this document does not exonerate parties to a transaction from exercising all their rights and obligations under the transaction documents. This document cannot be reproduced except in full, without prior written approval of the Company. Any unauthorized alteration, forgery or falsification of the content or appearance of this document is unlawful and offenders may be prosecuted to the fullest extent of the law.

SGS Taiwan Ltd.

No.134,Wu Kung Road, New Taipei Industrial Park, Wuku District, New Taipei City, Taiwan/新北市五股區新北產業園區五工路 134 號

台灣檢驗科技股份有限公司

t (886-2) 2299-3279

f (886-2) 2298-0488

www.sgs.com.tw

Member of SGS Group

Radar Type5_Trial28 for 5570MHz

Data Sheet for FCC Radar Type 5						
Trial Number:		28		VSG Frequency(MHz):		5640.71
Number of Bursts in Trial:			16		Successful Detection: Yes	
Burst (8-20)	Number Pulses per Burst (1-3)	Pulse Width (50-100)	Chirp Width (5-20)	Pulse 1-to-2 Spacing	Pulse 2-to-3 Spacing	Starting Location Within Interval
		(μ sec)	(MHz)	(μ sec)	(μ sec)	(μ sec)
1	1	51.6	15			289349
2	2	69.6	15	1249.4		470024
3	3	93.7	15	1041.3	1150.3	650118
4	2	81.7	15	1884.3		85378
5	3	92.9	15	1015.1	1041.1	266411
6	1	54	15			448486
7	3	89.4	15	1661.6	1625.6	627280
8	3	95.2	15	1199.8	1312.8	63036
9	3	94.8	15	1874.2	1264.2	243526
10	1	62	15			426457
11	3	86.8	15	1765.2	1300.2	605400
12	2	74.6	15	1030.4		40835
13	2	80.2	15	1433.8		221894
14	3	88.6	15	1584.4	1204.4	402325
15	3	95.1	15	1364.9	1513.9	582845
16	2	75.6	15	1550.4		18465
17						
18						
19						
20						

Unless otherwise stated the results shown in this test report refer only to the sample(s) tested and such sample(s) are retained for 90 days only.

除非另有說明，此報告結果僅對測試之樣品負責，同時此樣品僅保留90天。本報告未經本公司書面許可，不可部份複製。

This document is issued by the Company subject to its General Conditions of Service printed overleaf, available on request or accessible at <http://www.sgs.com.tw/Terms-and-Conditions> and for electronic format documents, subject to Terms and Conditions for Electronic Documents at <http://www.sgs.com.tw/Terms-and-Conditions>. Attention is drawn to the limitation of liability, indemnification and jurisdiction issues defined therein. Any holder of this document is advised that information contained hereon reflects the Company's findings at the time of its intervention only and within the limits of Client's instructions, if any. The Company's sole responsibility is to its Client and this document does not exonerate parties to a transaction from exercising all their rights and obligations under the transaction documents. This document cannot be reproduced except in full, without prior written approval of the Company. Any unauthorized alteration, forgery or falsification of the content or appearance of this document is unlawful and offenders may be prosecuted to the fullest extent of the law.

Radar Type5_Trial29 for 5570MHz

Data Sheet for FCC Radar Type 5						
Trial Number:		29		VSG Frequency(MHz):		5642.71
Number of Bursts in Trial:			12		Successful Detection: Yes	
Burst (8-20)	Number Pulses per Burst (1-3)	Pulse Width (50-100)	Chirp Width (5-20)	Pulse 1-to-2 Spacing	Pulse 2-to-3 Spacing	Starting Location Within Interval
		(μ sec)	(MHz)	(μ sec)	(μ sec)	(μ sec)
1	3	96.5	10	1604.5	1082.5	265973
2	1	54.2	10			509016
3	2	77.3	10	1263.7		749934
4	3	85.8	10	1593.2	1151.2	990734
5	3	93.9	10	920.1	1876.1	236405
6	3	87.2	10	999.8	1300.8	477860
7	2	79	10	980		720257
8	3	91	10	977	918	961256
9	1	51.6	10			207126
10	3	96.3	10	1180.7	1203.7	448163
11	1	51.9	10			691269
12	2	76.9	10	1126.1		932778
13						
14						
15						
16						
17						
18						
19						
20						

Unless otherwise stated the results shown in this test report refer only to the sample(s) tested and such sample(s) are retained for 90 days only.

除非另有說明，此報告結果僅對測試之樣品負責，同時此樣品僅保留90天。本報告未經本公司書面許可，不可部份複製。

This document is issued by the Company subject to its General Conditions of Service printed overleaf, available on request or accessible at <http://www.sgs.com.tw/Terms-and-Conditions> and for electronic format documents, subject to Terms and Conditions for Electronic Documents at <http://www.sgs.com.tw/Terms-and-Conditions>. Attention is drawn to the limitation of liability, indemnification and jurisdiction issues defined therein. Any holder of this document is advised that information contained hereon reflects the Company's findings at the time of its intervention only and within the limits of Client's instructions, if any. The Company's sole responsibility is to its Client and this document does not exonerate parties to a transaction from exercising all their rights and obligations under the transaction documents. This document cannot be reproduced except in full, without prior written approval of the Company. Any unauthorized alteration, forgery or falsification of the content or appearance of this document is unlawful and offenders may be prosecuted to the fullest extent of the law.

Radar Type5_Trial30 for 5570MHz

Data Sheet for FCC Radar Type 5						
Trial Number:		30		VSG Frequency(MHz):		5639.11
Number of Bursts in Trial:			19		Successful Detection: Yes	
Burst (8-20)	Number Pulses per Burst (1-3)	Pulse Width (50-100)	Chirp Width (5-20)	Pulse 1-to-2 Spacing	Pulse 2-to-3 Spacing	Starting Location Within Interval
		(μ sec)	(MHz)	(μ sec)	(μ sec)	(μ sec)
1	2	68.3	19	1287.7		111742
2	2	79.5	19	1375.5		263974
3	3	94.4	19	1371.6	1809.6	415412
4	2	78.9	19	1033.1		569750
5	1	58.9	19			93035
6	1	55.2	19			245758
7	3	87.8	19	1741.2	931.2	396617
8	2	77.2	19	1149.8		550426
9	3	90.8	19	1320.2	1427.2	73959
10	2	81.7	19	1204.3		226712
11	3	86.5	19	1320.5	1309.5	378328
12	3	90.7	19	1303.3	1374.3	530663
13	1	51.6	19			55500
14	2	76.9	19	1169.1		207885
15	3	92.1	19	1109.9	1723.9	359389
16	3	97.8	19	1590.2	1052.2	511380
17	1	54.6	19			36611
18	3	91	19	1234	1848	188355
19	1	62.7	19			342053
20						

Unless otherwise stated the results shown in this test report refer only to the sample(s) tested and such sample(s) are retained for 90 days only.

除非另有說明，此報告結果僅對測試之樣品負責，同時此樣品僅保留90天。本報告未經本公司書面許可，不可部份複製。

This document is issued by the Company subject to its General Conditions of Service printed overleaf, available on request or accessible at <http://www.sgs.com.tw/Terms-and-Conditions> and for electronic format documents, subject to Terms and Conditions for Electronic Documents at <http://www.sgs.com.tw/Terms-and-Conditions>. Attention is drawn to the limitation of liability, indemnification and jurisdiction issues defined therein. Any holder of this document is advised that information contained hereon reflects the Company's findings at the time of its intervention only and within the limits of Client's instructions, if any. The Company's sole responsibility is to its Client and this document does not exonerate parties to a transaction from exercising all their rights and obligations under the transaction documents. This document cannot be reproduced except in full, without prior written approval of the Company. Any unauthorized alteration, forgery or falsification of the content or appearance of this document is unlawful and offenders may be prosecuted to the fullest extent of the law.

Radar Type6 for 5570MHz

Data Sheet for FCC Radar Type 6

Trial	Pulse Width	PRI	Pulses per Hop	Hopping Rate	Hopping Sequence Length	Successful Detection
	(μ sec)	(μ sec)		(kHz)	(msec)	(Yes/No)
1	1	333	9	0.333	300	Yes
2	1	333	9	0.333	300	Yes
3	1	333	9	0.333	300	Yes
4	1	333	9	0.333	300	Yes
5	1	333	9	0.333	300	Yes
6	1	333	9	0.333	300	Yes
7	1	333	9	0.333	300	Yes
8	1	333	9	0.333	300	Yes
9	1	333	9	0.333	300	Yes
10	1	333	9	0.333	300	Yes
11	1	333	9	0.333	300	Yes
12	1	333	9	0.333	300	Yes
13	1	333	9	0.333	300	Yes
14	1	333	9	0.333	300	Yes
15	1	333	9	0.333	300	Yes
16	1	333	9	0.333	300	Yes
17	1	333	9	0.333	300	Yes
18	1	333	9	0.333	300	Yes
19	1	333	9	0.333	300	Yes
20	1	333	9	0.333	300	Yes
21	1	333	9	0.333	300	No
22	1	333	9	0.333	300	Yes
23	1	333	9	0.333	300	Yes
24	1	333	9	0.333	300	Yes
25	1	333	9	0.333	300	Yes
26	1	333	9	0.333	300	Yes
27	1	333	9	0.333	300	Yes
28	1	333	9	0.333	300	Yes
29	1	333	9	0.333	300	Yes
30	1	333	9	0.333	300	Yes

~End of Report~

Unless otherwise stated the results shown in this test report refer only to the sample(s) tested and such sample(s) are retained for 90 days only.

除非另有說明，此報告結果僅對測試之樣品負責，同時此樣品僅保留90天。本報告未經本公司書面許可，不可部份複製。

This document is issued by the Company subject to its General Conditions of Service printed overleaf, available on request or accessible at <http://www.sgs.com.tw/Terms-and-Conditions> and for electronic format documents, subject to Terms and Conditions for Electronic Documents at <http://www.sgs.com.tw/Terms-and-Conditions>. Attention is drawn to the limitation of liability, indemnification and jurisdiction issues defined therein. Any holder of this document is advised that information contained hereon reflects the Company's findings at the time of its intervention only and within the limits of Client's instructions, if any. The Company's sole responsibility is to its Client and this document does not exonerate parties to a transaction from exercising all their rights and obligations under the transaction documents. This document cannot be reproduced except in full, without prior written approval of the Company. Any unauthorized alteration, forgery or falsification of the content or appearance of this document is unlawful and offenders may be prosecuted to the fullest extent of the law.

SGS Taiwan Ltd.

No.134,Wu Kung Road, New Taipei Industrial Park, Wuku District, New Taipei City, Taiwan/新北市五股區新北產業園區五工路 134 號

台灣檢驗科技股份有限公司

t (886-2) 2299-3279

f (886-2) 2298-0488

www.sgs.com.tw

Member of SGS Group