

FCC ISED DFS Test Report

Test Report Number	STA-23031061-LC-FCC-IC-DFS
FCC ID	N6C-PCEAX
ISED ID	4908A-PCEAX
Applicant	Silex Technology, Inc.
Applicant Address	2-3-1 Hikaridai, Seika-cho, Soraku-gun, Kyoto 619-0237, Japan
Product Name	Wi-Fi 6E + BT 5.2 Module
Model (s)	SX-PCEAX
Date of Receipt	04/10/2023
Date of Test	04/12/2023 – 04/21/2023
Report Issue Date	04/26/2023
Test Standards	47CFR Part 15.407 RSS-247 Issue 2.0: Feb 2017
Test Result	PASS



Issued by:

Vista Compliance Laboratories

1261 Puerta Del Sol, San Clemente, CA 92673 USA

www.vista-compliance.com



Devin Tai (Test Engineer)



David Zhang (Technical Manager)

This report is for the exclusive use of the applicant. Any copying or replication of this report to or for any other person or entity, or use of our name or trademark, is permitted only with our prior written permission. Note that the results contained in this report pertain only to the test samples identified herein, and the results relate only to the items tested and the results that were obtained in the period between the date of initial receipt of samples and the date of issue of the report. This report sets forth our findings solely with respect to the test samples identified herein. The results set forth in this report are not indicative or representative of the quality or characteristics of the lot from which a test sample was taken or any similar or identical product unless specifically and expressly noted. Our report includes all of the tests requested and the results thereof based upon the information provided to us. The applicant has 60 days from date of issuance of this report to notify us of any material error or omission. Failure to raise such issue within the prescribed time shall constitute your unqualified acceptance of the completeness of this report, the tests conducted and the correctness of the report contents. Unless specific mention, the uncertainty of measurement has been explicitly taken into account to declare the compliance or non-compliance to the specification. The report must not be used by the client to claim product certification, approval, or endorsement by any government agencies. This report is not to be reproduced by any means except in full and in any case not without the written approval of Vista Laboratories.

REVISION HISTORY

Report Number	Version	Description	Issued Date
STA-23031061-LC-FCC-IC-DFS	01	Initial report	05/19/2023

TABLE OF CONTENTS

1 TEST SUMMARY4

2 GENERAL INFORMATION.....5

 2.1 Applicant5

 2.2 Product information.....5

 2.3 Test standard and method.....5

3 TEST SITE INFORMATION.....6

4 MODIFICATION OF EUT / DEVIATIONS FROM STANDARDS.....6

5 TEST CONFIGURATION AND OPERATION6

 5.1 EUT Test Configuration6

 5.2 Supporting Equipment.....6

6 UNCERTAINTY OF MEASUREMENT6

7 TEST SUMMARY AND RESULT.....7

 7.1 Dynamic Frequency Selection (DFS) Introduction7

 7.2 Dynamic Frequency Selection (DFS) Applicability11

 7.3 Dynamic Frequency Selection (DFS) Testing12

8 DFS RADAR WAVEFORM CHARACTERISTIC.....43

9 EUT PHOTOS.....65

10 TEST INSTRUMENT LIST.....66

1 Test Summary

Test Item	Test Requirement	Test Method	Result
UNII Detection Bandwidth	47CFR Part 15, Subpart E RSS-247 Issue 2.0: Feb 2017	ANSI C63.10 (2013) KDB 905462	Pass
Initial Channel Availability Check Time	47CFR Part 15, Subpart E RSS-247 Issue 2.0: Feb 2017	ANSI C63.10 (2013) KDB 905462	Pass
Radar Burst at the Beginning of the CAC Time	47CFR Part 15, Subpart E RSS-247 Issue 2.0: Feb 2017	ANSI C63.10 (2013) KDB 905462	Pass
Radar Burst at the End of the CAC Time	47CFR Part 15, Subpart E RSS-247 Issue 2.0: Feb 2017	ANSI C63.10 (2013) KDB 905462	Pass
In-Service Monitoring - Channel Move Time	47CFR Part 15, Subpart E RSS-247 Issue 2.0: Feb 2017	ANSI C63.10 (2013) KDB 905462	Pass
In-Service Monitoring - Channel Closing Transmission Time	47CFR Part 15, Subpart E RSS-247 Issue 2.0: Feb 2017	ANSI C63.10 (2013) KDB 905462	Pass
In-Service Monitoring - Non- Occupancy Period	47CFR Part 15, Subpart E RSS-247 Issue 2.0: Feb 2017	ANSI C63.10 (2013) KDB 905462	Pass
Statistical Performance Check	47CFR Part 15, Subpart E RSS-247 Issue 2.0: Feb 2017	ANSI C63.10 (2013) KDB 905462	Pass

2 General Information

2.1 Applicant

Applicant	Silex Technology, Inc.
Applicant address	2-3-1 Hikaridai, Seika-cho, Soraku-gun, Kyoto 619-0237, Japan
Manufacturer	Silex Technology, Inc.
Manufacturer Address	2-3-1 Hikaridai, Seika-cho, Soraku-gun, Kyoto 619-0237, Japan

2.2 Product information

Product Name	Wi-Fi 6E + BT 5.2 Module
Model Number	SX-PCEAX
Family Models	N/A
Serial Number	1CBCEC011EB6
Frequency Band	Bluetooth BDR/EDR/BLE: 2.402 ~ 2.480GHz 2.4GHz WLAN: 2.412 ~2.462GHz 5GHz WLAN: 5.15~ 5.35GHz, 5.47 ~ 5.725GHz, 5.725 ~ 5.85GHz 6GHz WLAN: 5.85~ 5.925GHz, 5.925 ~ 7.125GHz
Type of modulation	BT: GFSK, $\pi/4$ DQPSK, 8DPSK WLAN: 64QAM, 16QAM, QPSK, BPSK for OFDM in 11a/n mode 1024QAM for OFDM in 11ac mode 4096QAM for OFDMA in 11ax HE mode
Equipment Class	U-NII
Antenna Information	Various antenna, -2 dBi (minimum antenna gain)
Clock Frequencies	N/A
Input Power	3.3Vdc from host equipment
Power Adapter Manufacturer/Model	EDACPOWER ELEC./EA10682N-120
Power Adapter SN	131210680175
Hardware version	N/A
Software version	N/A
Additional Info	This module supports 2 x 2 MIMO. Both antenna ports have the same characteristics. The testing is done at the antenna port 0 only. This module is certified a single module. It supports various type of antennas. Reference to the manual/datasheet for more information about the supported antennas. For DFS testing purpose, the minimum antenna gain value of -2 dBi is used to evaluate the worst-case scenario.

2.3 Test standard and method

Test standard	47CFR Part 15.407, Subpart E RSS-247 Issue 2.0: Feb 2017
Test method	ANSI C63.10 (2013) 905462 D02 UNII DFS Compliance Procedures New Rules v02

3 Test Site Information

Lab performing tests	Vista Laboratories, Inc.
Lab Address	1261 Puerta Del Sol, San Clemente, CA 92673 USA
Phone Number	+1 (949) 393-1123
Website	www.vista-compliance.com

Test Condition	Temperature	Humidity	Atmospheric Pressure
DFS Testing	23.5°C	58.2%	996 mbar

4 Modification of EUT / Deviations from Standards

N/A

5 Test Configuration and Operation

5.1 EUT Test Configuration

The EUT is installed onto a I.MX 8M evaluation board for testing purpose, which is powered by an external 12VDC AC/DC adapter. EUT operating as a DFS Master Device. A test laptop with Intel Wi-Fi 6 AX201 radio module is used as DFS client to establish connection with the for the DFS testing. DFS testing while the System testing was performed with the data traffic established using iPerf.exe.

5.2 Supporting Equipment

Description	Manufacturer	Model #	Serial #
Test laptop	Dell	Latitude E6440	FFF4JC2
Test laptop (DFS client)	Lenovo	IdeaPad FLEX-15IWL	MP1JRS70
evaluation board	NXP	I.MX 8M	TR18042902
AC/DC power adapter	EDAC Power Elec	EA10682N-120	400-76062

6 Uncertainty of Measurement

Test item	Measurement Uncertainty (dB)
Dynamic frequency selection (DFS) Conducted Measurement	±1.5dB

7 Test Summary and Result

7.1 Dynamic Frequency Selection (DFS) Introduction

7.1.1 Requirement

Interference Threshold values, Master or Client incorporating In-Service Monitoring

Maximum Transmit Power	Value (see note)
≥ 200 milliwatt	-64 dBm
EIRP < 200 milliwatt and power spectral density < 10 dBm/MHz	-62 dBm
EIRP < 200 milliwatt that do not meet the power spectra density requirement	-64 dBm

Note 1: This is the level at the input of the receiver assuming a 0 dBi receive antenna.
 Note 2: Throughout these test procedures an additional 1 dB has been added to the amplitude of the test transmission waveforms to account for variations in measurement equipment. This will ensure that the test signal is at or above the detection threshold level to trigger a DFS response.
 Note3: EIRP is based on the highest antenna gain. For MIMO devices refer to KDB Publication 662911 D01.

DFS Response requirement values

Parameter	Value
Non-occupancy period	Minimum 30 minutes
Channel Availability Check Time	60 seconds
Channel Move Time	10 seconds See Note 1.
Channel Closing Transmission Time	200 milliseconds + an aggregate of 60 milliseconds over remaining 10 second period. See Notes 1 and 2.
U-NII Detection Bandwidth	Minimum 100% of the UNII 99% transmission power bandwidth See Note 3.

Note 1: Channel Move Time and the Channel Closing Transmission Time should be performed with Radar Type 0. The measurement timing begins at the end of the Radar Type 0 burst.
 Note 2: The Channel Closing Transmission Time is comprised of 200 milliseconds starting at the beginning of the Channel Move Time plus any additional intermittent control signals required facilitating a Channel move (an aggregate of 60 milliseconds) during the remainder of the 10 second period. The aggregate duration of control signals will not count quiet periods in between transmissions.
 Note 3: During the U-NII Detection Bandwidth detection test, radar type 0 should be used. For each frequency step the minimum percentage of detection is 90 percent. Measurements are performed with no data traffic.

7.1.2 Radar type and test waveforms

This section provides the parameters for required test waveforms, minimum percentage of successful detections, and the minimum number of trials that must be used for determining DFS conformance. Step intervals of 0.1 microsecond for Pulse Width, 1 microsecond for PRI, 1 MHz for chirp width and 1 for the number of pulses will be utilized for the random determination of specific test waveforms.

Short Pulse Radar Test Waveforms

Radar Type	Pulse Width (μsec)	PRI (μsec)	Number of Pulses	Minimum Percentage of Successful Detection	Minimum Trials
0	1	1428	18	See Note 1	See Note 1
1	1	Test A: 15 unique PRI values randomly selected from the list of 23 PRI values in Table 5a	Roundup $\{(1/360) * (19 * 10^6 / PRI_{\mu sec})\}$	60%	30
		Test B: 15 unique PRI values randomly selected within the range of 518-3066 μsec, with a minimum increment of 1 μsec, excluding PRI values selected in Test A	-		
2	1-5	150-230	23-29	60%	30
3	6-10	200-500	16-18	60%	30
4	11-20	200-500	12-16	60%	30
Aggregate (Radar Types 1-4)				80%	120
Note 1: Short Pulse Radar Type 0 should be used for the detection bandwidth test, channel move time, and channel closing time tests.					

Long Pulse Radar Test Waveform

Radar Type	Pulse Width (μsec)	Chirp Width (MHz)	PRI (μsec)	Number of Pulses per Burst	Number of Bursts	Minimum Percentage of Successful Detection	Minimum Trials
5	50-100	5-20	1000-2000	1-3	8-20	80%	30

The parameters for this waveform are randomly chosen. Thirty unique waveforms are required for the Long Pulse radar test signal. If more than 30 waveforms are used for the Long Pulse radar test signal, then each additional waveform must also be unique and not repeated from the previous waveforms.

Each waveform is defined as follows:

- 1) The transmission period for the Long Pulse Radar test signal is 12 seconds.
- 2) There are a total of 8 to 20 Bursts in the 12 second period, with the number of Bursts being randomly chosen. This number is Burst Count.
- 3) Each Burst consists of 1 to 3 pulses, with the number of pulses being randomly chosen. Each Burst within the 12 second sequence may have a different number of pulses.
- 4) The pulse width is between 50 and 100 microseconds, with the pulse width being randomly chosen. Each pulse within a Burst will have the same pulse width. Pulses in different Bursts may have different pulse widths.
- 5) Each pulse has a linear FM chirp between 5 and 20 MHz, with the chirp width being randomly chosen. Each pulse within a Burst will have the same chirp width. Pulses in different Bursts may have different chirp widths. The chirp is centered on the pulse. For example, with a radar frequency of 5300 MHz and a 20 MHz chirped signal, the chirp starts at 5290 MHz and ends at 5310 MHz
- 6) If more than one pulse is present in a Burst, the time between the pulses will be between 1000 and 2000 microseconds, with the time being randomly chosen. If three pulses are present in a Burst, the time between the first and second pulses is chosen independently of the time between the second and third pulses.
- 7) The 12 second transmission period is divided into even intervals. The number of intervals is equal to Burst Count. Each interval is of length $(12,000,000 / \text{Burst Count})$ microseconds. Each interval contains one Burst. The start time for the Burst, relative to the beginning of the interval, is between 1 and $[(12,000,000 / \text{Burst Count}) - (\text{Total Burst Length}) + (\text{One Random PRI Interval})]$ microseconds, with the start time being randomly chosen. The step interval for the start time is 1 microsecond. The start time for each Burst is chosen independently.

A representative example of a Long Pulse radar test waveform:

- 1) The total test signal length is 12 seconds.
- 2) 8 Bursts are randomly generated for the Burst Count.
- 3) Burst 1 has 2 randomly generated pulses.
- 4) The pulse width (for both pulses) is randomly selected to be 75 microseconds.
- 5) The PRI is randomly selected to be at 1213 microseconds.
- 6) Bursts 2 through 8 are generated using steps 3 – 5.
- 7) Each Burst is contained in even intervals of 1,500,000 microseconds. The starting location for Pulse 1, Burst 1 is randomly generated (1 to 1,500,000 minus the total Burst 1 length + 1 random PRI interval) at the 325,001-microsecond step. Bursts 2 through 8 randomly fall in successive 1,500,000 microsecond intervals (i.e. Burst 2 falls in the 1,500,001 – 3,000,000 microsecond range).

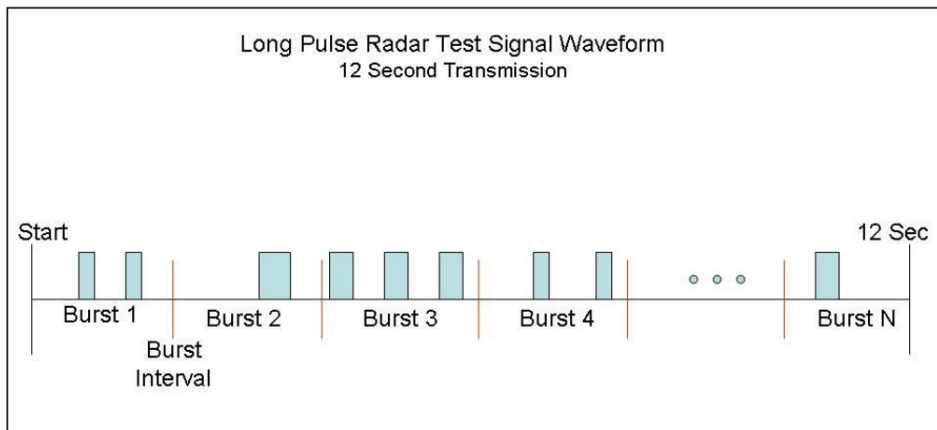

Frequency Hopping Radar Type

Radar Type	Pulse Width (μsec)	PRI (μsec)	Pulses per Hop	Hopping Rate (kHz)	Hopping Sequence Length (msec)	Minimum Percentage of Successful Detection	Minimum Trials
6	1	333	9	.333	300	70%	30

For the Frequency Hopping Radar Type, the same Burst parameters are used for each waveform. The hopping sequence is different for each waveform and a 100-length segment is selected 1 from the hopping sequence defined by the following algorithm:

The first frequency in a hopping sequence is selected randomly from the group of 475 integer frequencies from 5250 – 5724 MHz. Next, the frequency that was just chosen is removed from the group and a frequency is randomly selected from the remaining 474 frequencies in the group. This process continues until all 475 frequencies are chosen for the set. For selection of a random frequency, the frequencies remaining within the group are always treated as equally likely.

7.2 Dynamic Frequency Selection (DFS) Applicability

7.2.1 Requirement

A U-NII network will employ a DFS function to detect signals from radar systems and to avoid co-channel operation with these systems. This applies to the 5250-5350 MHz and/or 5470-5725 MHz bands.¹

Within the context of the operation of the DFS function, a U-NII device will operate in either Master Mode or Client Mode. U-NII devices operating in Client Mode can only operate in a network controlled by a UNII device operating in Master Mode.

Following tables shown below summarize the DFS testing applicability.

Applicability of DFS Requirements Prior to Use of a Channel

Requirement	Operational Mode		
	Master	Client Without Radar Detection	Client With Radar Detection
<i>Non-Occupancy Period</i>	Yes	Not required	Yes
<i>DFS Detection Threshold</i>	Yes	Not required	Yes
<i>Channel Availability Check Time</i>	Yes	Not required	Not required
<i>U-NII Detection Bandwidth</i>	Yes	Not required	Yes

Applicability of DFS requirements during normal operation

Requirement	Operational Mode	
	Master Device or Client with Radar Detection	Client Without Radar Detection
<i>DFS Detection Threshold</i>	Yes	Not required
<i>Channel Closing Transmission Time</i>	Yes	Yes
<i>Channel Move Time</i>	Yes	Yes
<i>U-NII Detection Bandwidth</i>	Yes	Not required

Additional requirements for devices with multiple bandwidth modes	Master Device or Client with Radar Detection	Client Without Radar Detection
<i>U-NII Detection Bandwidth and Statistical Performance Check</i>	All BW modes must be tested	Not required
<i>Channel Move Time and Channel Closing Transmission Time</i>	Test using widest BW mode available	Test using the widest BW mode available for the link
<i>All other tests</i>	Any single BW mode	Not required
Note: Frequencies selected for statistical performance check (Section 7.8.4) should include several frequencies within the radar detection bandwidth and frequencies near the edge of the radar detection bandwidth. For 802.11 devices it is suggested to select frequencies in each of the bonded 20 MHz channels and the channel center frequency.		

7.2.2 Conclusion

EUT operates over the 5250-5350MHz and 5470-5725MHz ranges and EUT is a Master device with radar detection and DFS capability.

7.3 Dynamic Frequency Selection (DFS) Testing

7.3.1 Requirement

Channel Closing Transmission Time

The Channel Closing Transmission Time is comprised of 200 milliseconds starting at the beginning of the Channel Move Time plus any additional intermittent control signals required to facilitate a Channel move (an aggregate of 60 milliseconds) during the remainder of the 10 second period. The aggregate duration of control signals will not count quiet periods in between transmissions.

The channel closing transmission time shall be less than (200 milliseconds + an aggregate of 60 milliseconds) over remaining 10 second period

Channel Move Time

After a radar's presence is detected, all transmissions shall cease on the operating channel within 10 seconds. Transmissions during this period shall consist of normal traffic for a maximum of 200 ms after detection of the radar signal. In addition, intermittent management and control signals can be sent during the remaining time to facilitate vacating the operating channel.

7.3.2 Radar Waveform Calibration

The following equipment setup was used to calibrate the conducted Radar Waveform. A spectrum analyzer was used to establish the test signal level for each radar type. During this process there were no transmissions by either the Master or Client Device. The spectrum analyzer was switched to the zero span (Time Domain) mode at the frequency of the Radar Waveform generator. Peak detection was utilized.

Calibration Test Plots
20MHz BW / 5500MHz

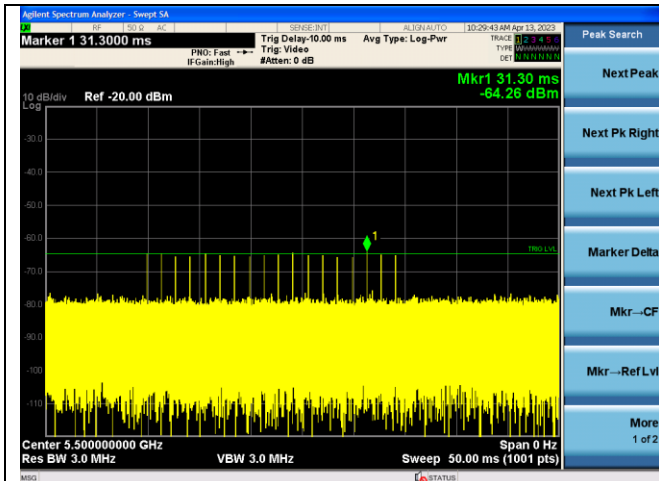

Radar Type 0

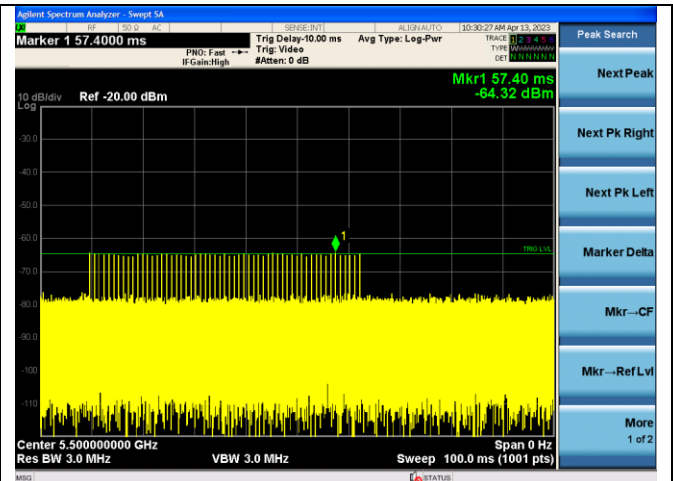

Radar Type 1

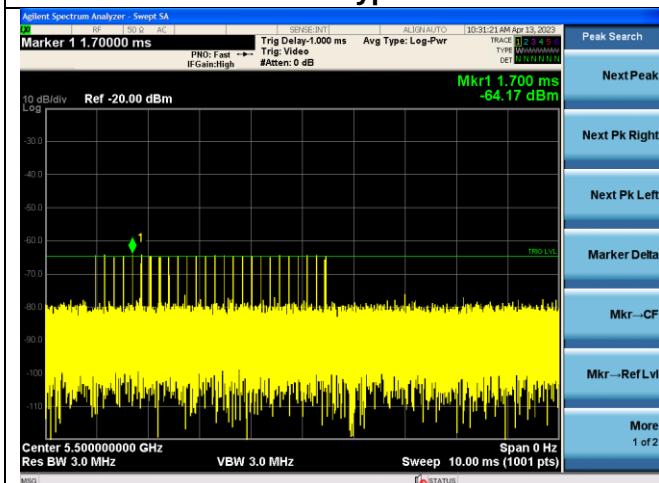

Radar Type 2

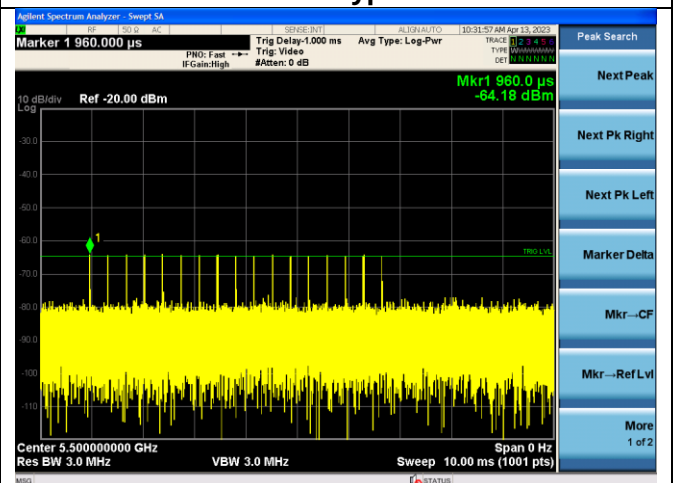

Radar Type 3

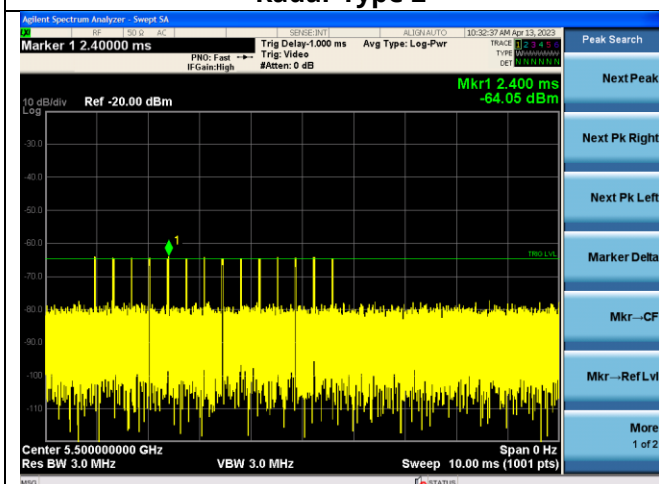

Radar Type 4

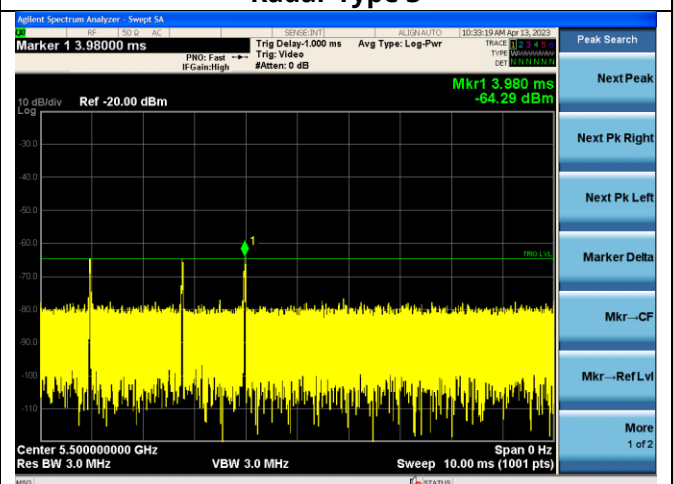

Radar Type 5

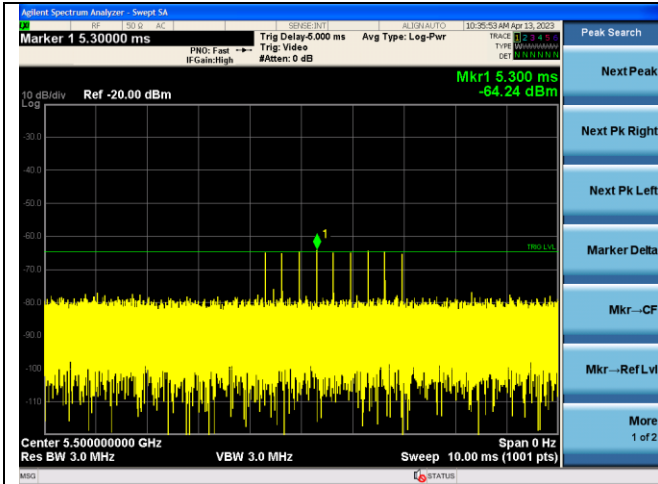

Radar Type 6

N/A

N/A

40MHz BW / 5510MHz

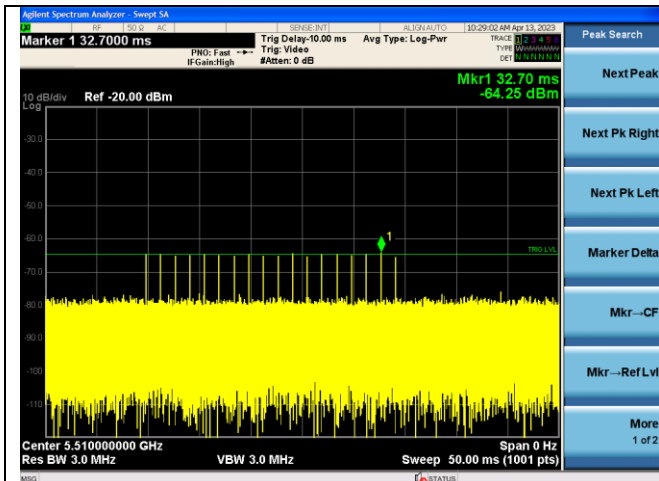

Radar Type 0

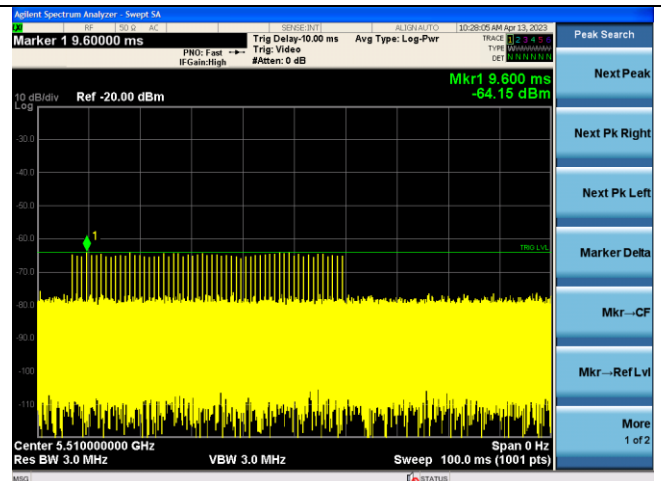

Radar Type 1

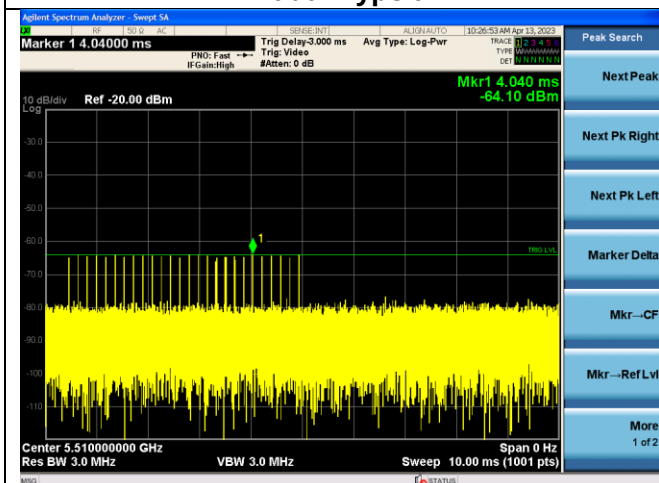

Radar Type 2

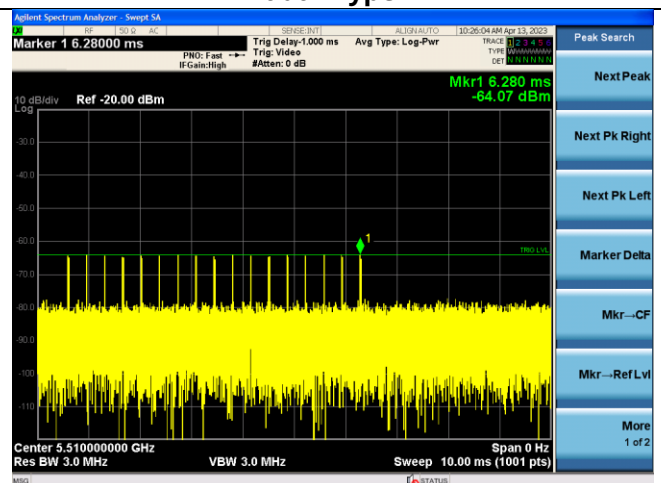

Radar Type 3

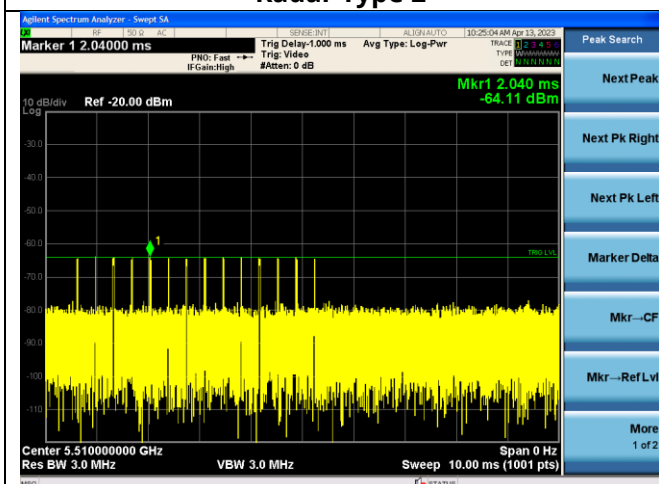

Radar Type 4

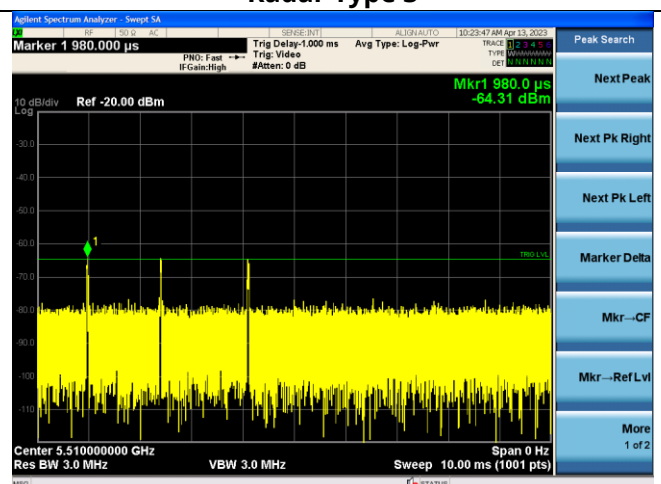

Radar Type 5

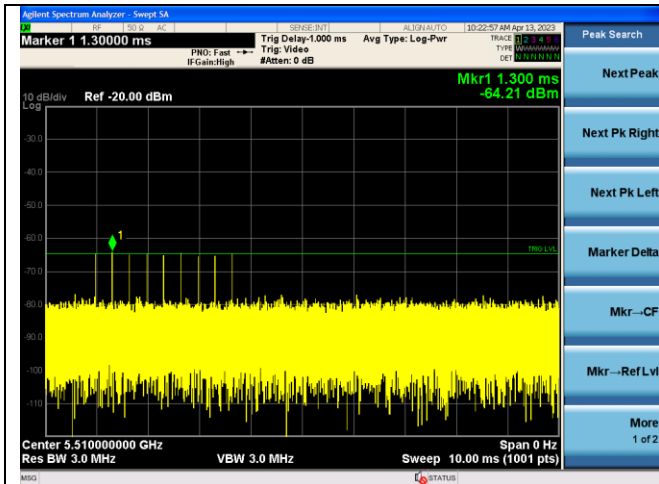

Radar Type 6

Peak Search Next Peak Next Pk Right Next Pk Left Marker Delta Mkr--CF Mkr--Ref Lvl More 1 of 2	N/A
--	-----

N/A

80MHz BW / 5530MHz

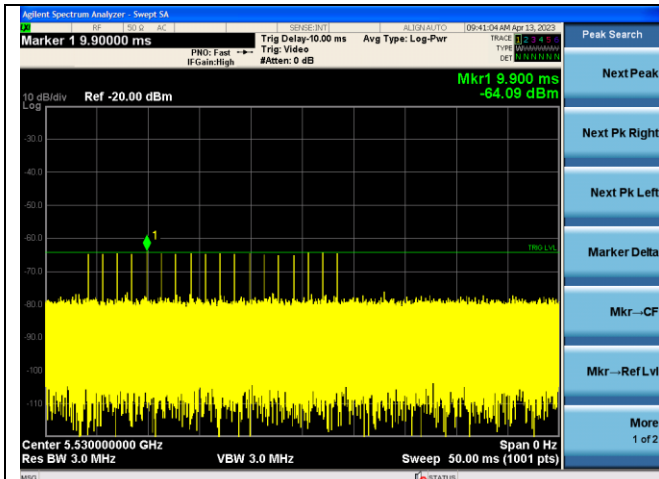

Radar Type 0

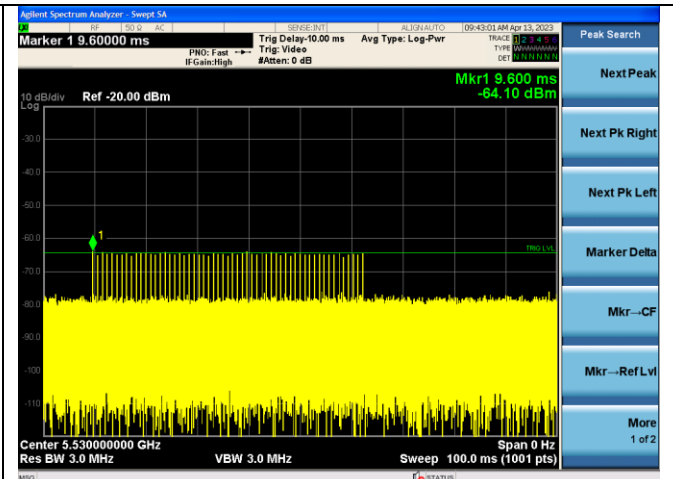

Radar Type 1

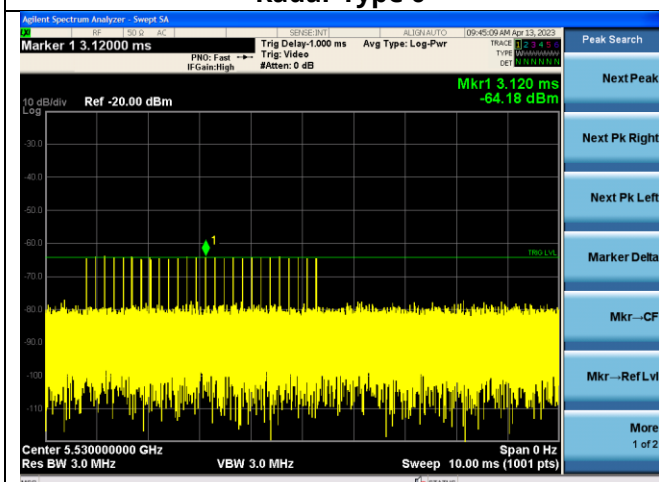

Radar Type 2

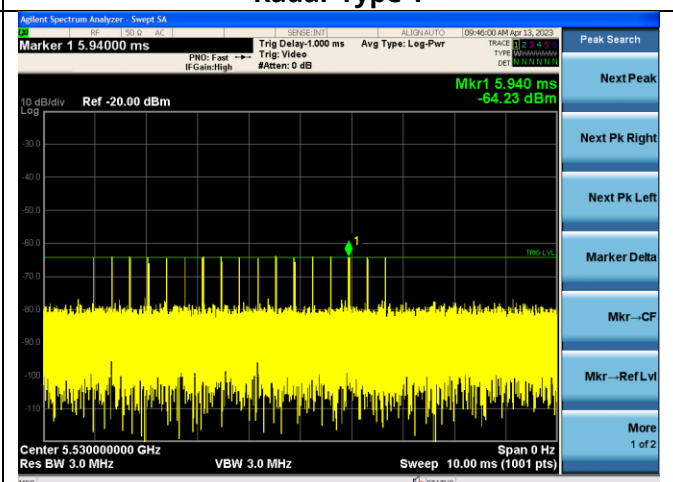

Radar Type 3

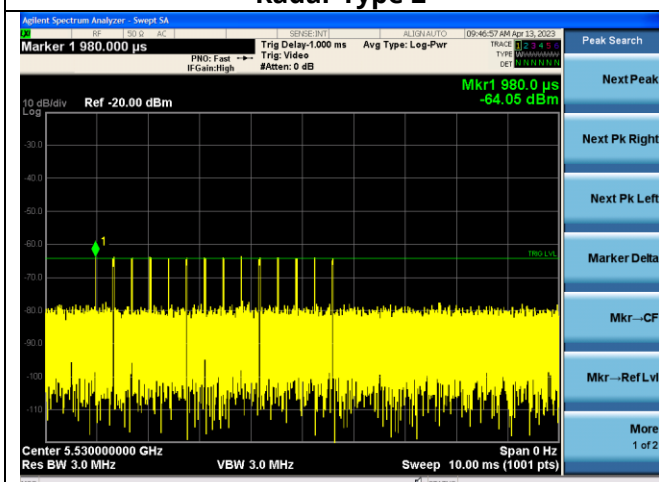

Radar Type 4

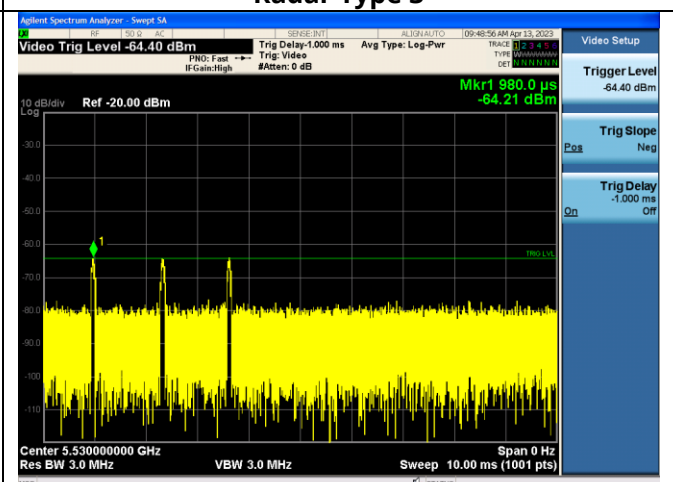

Radar Type 5

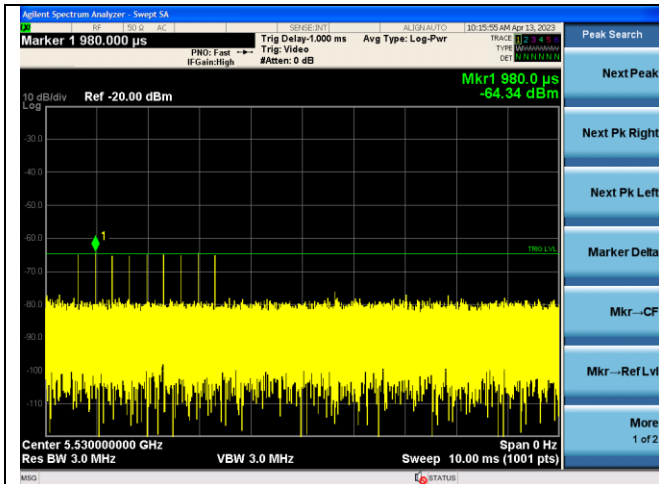

Radar Type 6

N/A

N/A

160MHz BW / 5570MHz

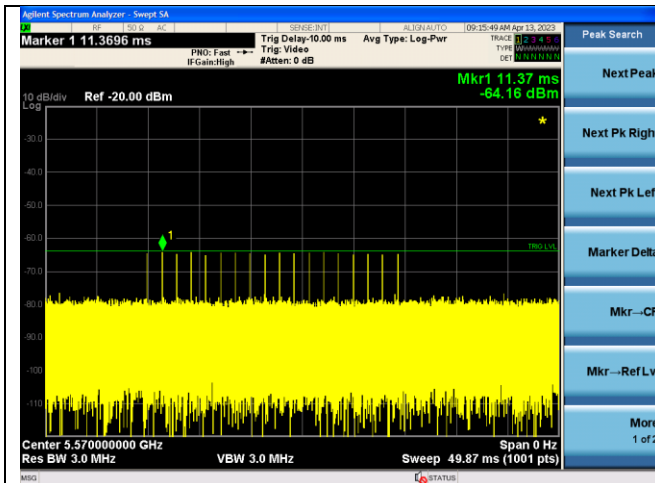

Radar Type 0

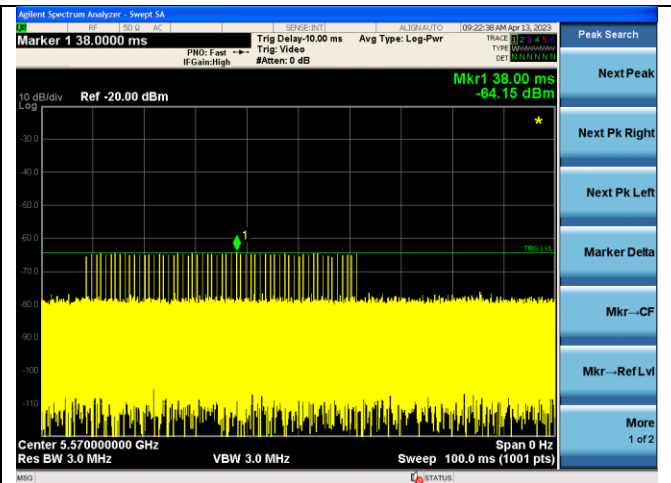

Radar Type 1

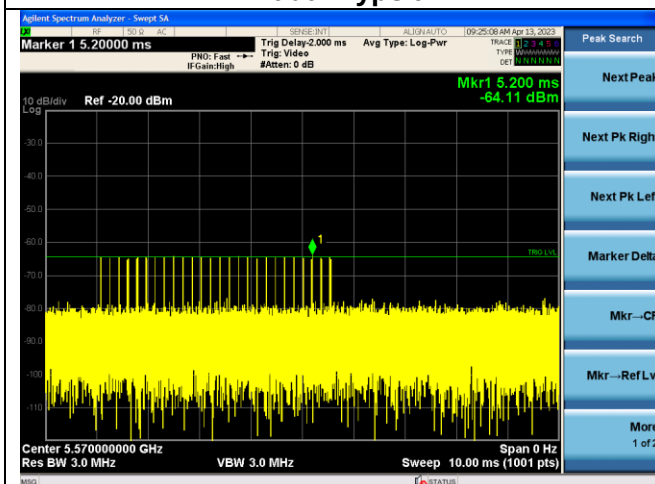

Radar Type 2

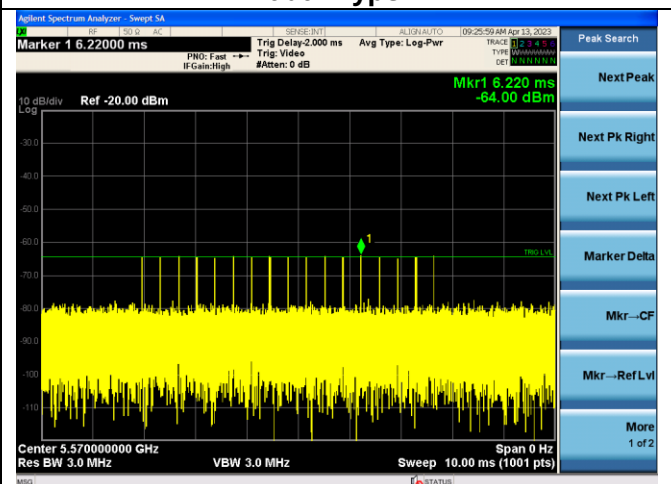

Radar Type 3

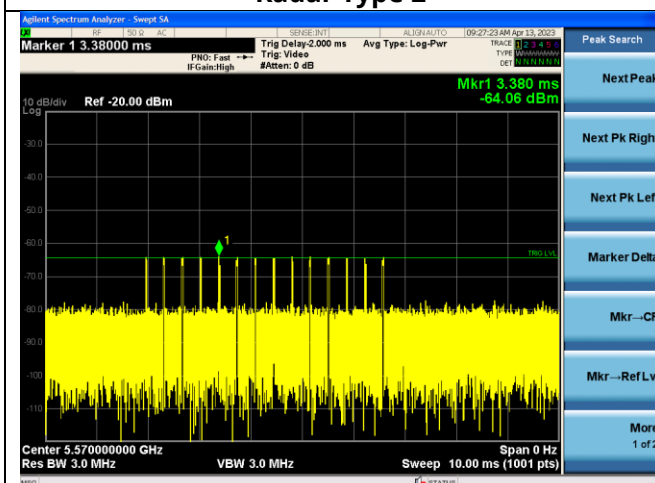

Radar Type 4

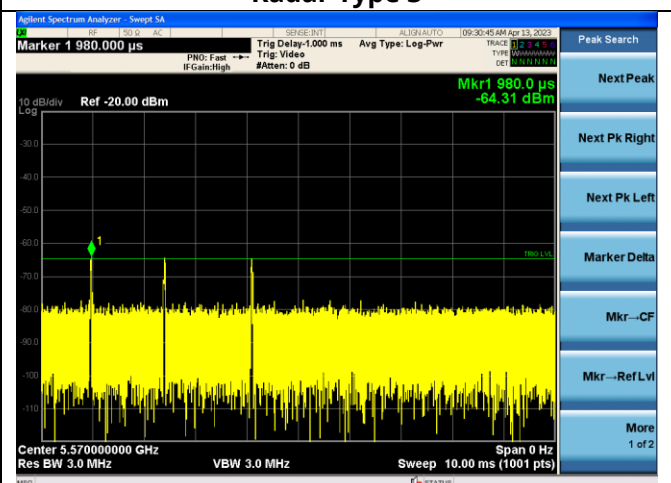

Radar Type 5

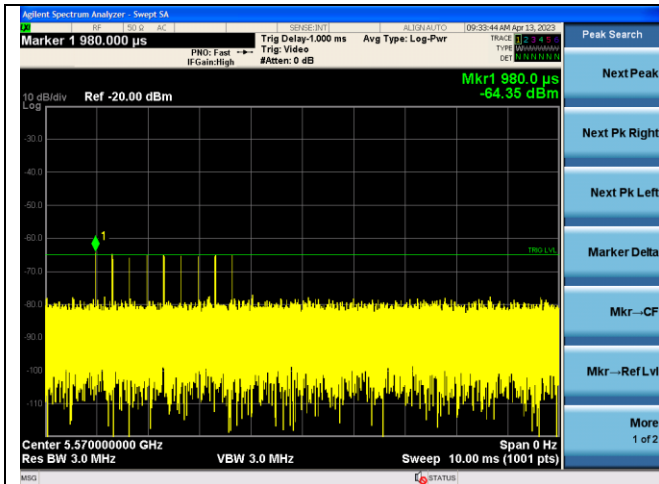

Radar Type 6

N/A

N/A

7.3.3 DFS Test Procedure

In-Service Monitoring for Channel Move Time, Channel Closing Transmission Time and Non-Occupancy Period

These tests define how the following DFS parameters are verified during In-Service Monitoring: Channel Closing Transmission Time, Channel Move Time, and Non-Occupancy Period.

The steps below define the procedure to determine the above-mentioned parameters when a radar Burst with a level equal to the DFS Detection Threshold + 1dB is generated on the Operating Channel of the U-NII device.

UUT operating as a Master will associate with the client device at Mid Channel. DFS testing while the System testing was performed with the designated MPEG test file that streams full motion video from the Master to the Client IP based system.

At time T0 the Radar Waveform generator sends a Burst of pulses for each of the radar types.

Observe the transmissions of the UUT at the end of the radar Burst on the Operating Channel for duration greater than 10 seconds. Measure and record the transmissions from the UUT during the observation time (Channel Move Time). Compare the Channel Move Time and Channel Closing Transmission Time results to the limits defined in the DFS Response requirement values table.

Channel Closing Transmission Time- Measurement

A type 1 waveform was introduced to the EUT and the Spectrum Analyzer sweep time was set to 1s for monitoring and capturing the plot. A LabVIEW program was created to collect trace data and capturing the plot. The program will calculate the channel closing time base on the spectrum analyzer result. The result will be calculated based on FCC procedure.

$$C = N * Dwell$$

C is the closing time; N is the number of spectrum analyzer sampling bins showing a U-NII transmission and dwell is the dwell time per bin.

$$Dwell = S/B$$

Where Dwell is the dwell time per spectrum analyzer sampling bin, S is the sweep time and B is the number of spectrum analyzer sampling bins.

7.3.4 Channel Loading

System testing will be performed with channel-loading using means appropriate to the data types that are used by the unlicensed device. The following requirements apply:

a	The data file must be of a type that is typical for the device (i.e., MPEG-2, MPEG-4, WAV, MP3, MP4, AVI, etc.) and must generally be transmitting in a streaming mode.	
b	Software to ping the client is permitted to simulate data transfer but must have random ping intervals.	
c	Timing plots are required with calculations demonstrating a minimum channel loading of approximately 17% or greater.	
d	Unicast or Multicast protocols are preferable but other protocols may be used. The appropriate protocol used must be described in the test procedures.	√

Note: iperf.exe is used to establish data traffic between EUT and DFS client device.

7.3.5 DFS Test Setup

Test Setup Block Diagram

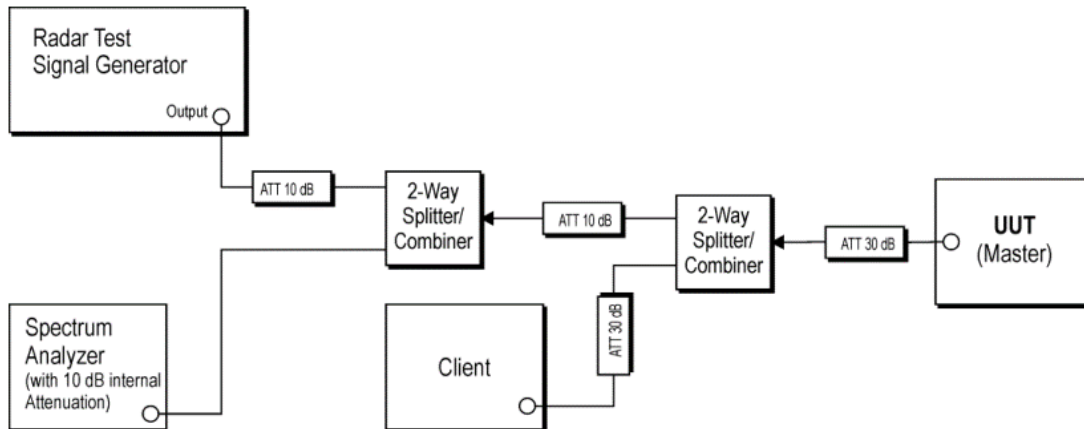

The radio was set at the center channel frequency of tested Channel. A laptop with FCC approved WLAN client module integrated (FCC ID: PD9AX201D2L) was used to link with DUT device.

The master device provides, on aggregate, uniform loading of the spectrum across all devices by selecting an operating channel among the available channels using a random algorithm.

The rated output power of the Master unit is < 23 dBm (EIRP). A worst case of -2 dBi antenna gain is used to determine the DFS threshold level. Therefore, the required interference threshold is $-62+(-2)$ dBi = -64 dBm.

The calibrated DFS detection threshold level at EUT antenna port is set to -64 dBm. The tested level is lower than the required level hence it provides margining to the limit.

7.3.6 DFS Test Result

7.3.6.1 UNII Detection Bandwidth

UNII Detection Bandwidth: All UNII channels for this device have identical Channel bandwidths and testing was performed on Mid Channel

The generating equipment is configured as shown in the Conducted Test Setup above. A single *Burst* of the short pulse radar type 0 is produced at Mid Channel at the required DFS detection threshold level. The UUT is set up as a standalone device (no associated Client and no traffic).

A single radar Burst is generated for a minimum of 10 trials, and the response of the UUT is noted. The UUT must detect the Radar Waveform 90% or more of the time.

Starting at the center frequency of the UUT operating Channel, increase the radar frequency in 5 MHz steps, repeating the above test sequence, until the detection rate falls below the U-NII Detection Bandwidth criterion specified. Repeat this measurement in 1MHz steps at frequencies 5 MHz below where the detection rate begins to fall. Record the highest frequency (denote as FH) at which detection is greater than or equal to the U-NII Detection Bandwidth criterion. Recording the detection rate at frequencies above FH is not required to demonstrate compliance.

Starting at the center frequency of the UUT operating Channel, decrease the radar frequency in 5 MHz steps, repeating the above test sequence, until the detection rate falls below the U-NII Detection Bandwidth criterion specified in Table 4. Repeat this measurement in 1MHz steps at frequencies 5 MHz above where the detection rate begins to fall. Record the lowest frequency (denote as FL) at which detection is greater than or equal to the U-NII Detection Bandwidth criterion. Recording the detection rate at frequencies below FL is not required to demonstrate compliance.

The U-NII Detection Bandwidth is calculated as follows:

$$\text{U-NII Detection Bandwidth} = \text{FH} - \text{FL}$$

The U-NII Detection Bandwidth must be at least 100% of the UUT transmitter 99% power, otherwise, the UUT does not comply with DFS requirements.

Test Result

EUT Frequency = 5500MHz (11a mode)

Frequency (MHz)	Trial 1	Trial 2	Trial 3	Trial 4	Trial 5	Trial 6	Trial 7	Trial 8	Trial 9	Trial 10	Detection Rate %
5490	Yes	Yes	Yes	Yes	Yes	Yes	Yes	Yes	Yes	Yes	100.00%
5491	Yes	Yes	Yes	Yes	Yes	Yes	Yes	Yes	Yes	Yes	100.00%
5492	Yes	Yes	Yes	Yes	Yes	Yes	Yes	Yes	Yes	Yes	100.00%
5493	Yes	Yes	Yes	Yes	Yes	Yes	Yes	Yes	Yes	Yes	100.00%
5494	Yes	Yes	Yes	Yes	Yes	Yes	Yes	Yes	Yes	Yes	100.00%
5495	Yes	Yes	Yes	Yes	Yes	Yes	Yes	Yes	Yes	Yes	100.00%
5500	Yes	Yes	Yes	Yes	Yes	Yes	Yes	Yes	Yes	Yes	100.00%
5505	Yes	Yes	Yes	Yes	Yes	Yes	Yes	Yes	Yes	Yes	100.00%
5506	Yes	Yes	Yes	Yes	Yes	Yes	Yes	Yes	Yes	Yes	100.00%
5507	Yes	Yes	Yes	Yes	Yes	Yes	Yes	Yes	Yes	Yes	100.00%
5508	Yes	Yes	Yes	Yes	Yes	Yes	Yes	Yes	Yes	Yes	100.00%
5509	Yes	Yes	Yes	Yes	Yes	Yes	Yes	Yes	Yes	Yes	100.00%
5510	Yes	Yes	Yes	Yes	Yes	Yes	Yes	Yes	Yes	Yes	100.00%
Detection Bandwidth: 20 MHz											
Specification: at least 100% of 99% of EUT bandwidth= 18.84 MHz											

EUT Frequency = 5510MHz (11n-40MHz mode)

Frequency (MHz)	Trial 1	Trial 2	Trial 3	Trial 4	Trial 5	Trial 6	Trial 7	Trial 8	Trial 9	Trial 10	Detection Rate %
5490	Yes	Yes	Yes	Yes	Yes	Yes	Yes	Yes	Yes	Yes	100.00%
5491	Yes	Yes	Yes	Yes	Yes	Yes	Yes	Yes	Yes	Yes	100.00%
5492	Yes	Yes	Yes	Yes	Yes	Yes	Yes	Yes	Yes	Yes	100.00%
5493	Yes	Yes	Yes	Yes	Yes	Yes	Yes	Yes	Yes	Yes	100.00%
5494	Yes	Yes	Yes	Yes	Yes	Yes	Yes	Yes	Yes	Yes	100.00%
5495	Yes	Yes	Yes	Yes	Yes	Yes	Yes	Yes	Yes	Yes	100.00%
5500	Yes	Yes	Yes	Yes	Yes	Yes	Yes	Yes	Yes	Yes	100.00%
5505	Yes	Yes	Yes	Yes	Yes	Yes	Yes	Yes	Yes	Yes	100.00%
5510	Yes	Yes	Yes	Yes	Yes	Yes	Yes	Yes	Yes	Yes	100.00%
5515	Yes	Yes	Yes	Yes	Yes	Yes	Yes	Yes	Yes	Yes	100.00%
5520	Yes	Yes	Yes	Yes	Yes	Yes	Yes	Yes	Yes	Yes	100.00%
5525	Yes	Yes	Yes	Yes	Yes	Yes	Yes	Yes	Yes	Yes	100.00%
5526	Yes	Yes	Yes	Yes	Yes	Yes	Yes	Yes	Yes	Yes	100.00%
5527	Yes	Yes	Yes	Yes	Yes	Yes	Yes	Yes	Yes	Yes	100.00%
5528	Yes	Yes	Yes	Yes	Yes	Yes	Yes	Yes	Yes	Yes	100.00%
5529	Yes	Yes	Yes	Yes	Yes	Yes	Yes	Yes	Yes	Yes	100.00%
5530	Yes	Yes	Yes	Yes	Yes	Yes	Yes	Yes	Yes	Yes	100.00%
Detection Bandwidth: 40 MHz											
Specification: at least 100% of 99% of EUT bandwidth= 37.92 MHz											

EUT Frequency = 5530MHz (11ac-80MHz mode)

Frequency (MHz)	Trial 1	Trial 2	Trial 3	Trial 4	Trial 5	Trial 6	Trial 7	Trial 8	Trial 9	Trial 10	Detection Rate %
5490	Yes	Yes	Yes	Yes	Yes	Yes	Yes	Yes	Yes	Yes	100.00%
5491	Yes	Yes	Yes	Yes	Yes	Yes	Yes	Yes	Yes	Yes	100.00%
5492	Yes	Yes	Yes	Yes	Yes	Yes	Yes	Yes	Yes	Yes	100.00%
5493	Yes	Yes	Yes	Yes	Yes	Yes	Yes	Yes	Yes	Yes	100.00%
5494	Yes	Yes	Yes	Yes	Yes	Yes	Yes	Yes	Yes	Yes	100.00%
5495	Yes	Yes	Yes	Yes	Yes	Yes	Yes	Yes	Yes	Yes	100.00%
5500	Yes	Yes	Yes	Yes	Yes	Yes	Yes	Yes	Yes	Yes	100.00%
5505	Yes	Yes	Yes	Yes	Yes	Yes	Yes	Yes	Yes	Yes	100.00%
5510	Yes	Yes	Yes	Yes	Yes	Yes	Yes	Yes	Yes	Yes	100.00%
5515	Yes	Yes	Yes	Yes	Yes	Yes	Yes	Yes	Yes	Yes	100.00%
5520	Yes	Yes	Yes	Yes	Yes	Yes	Yes	Yes	Yes	Yes	100.00%
5525	Yes	Yes	Yes	Yes	Yes	Yes	Yes	Yes	Yes	Yes	100.00%
5530	Yes	Yes	Yes	Yes	Yes	Yes	Yes	Yes	Yes	Yes	100.00%
5535	Yes	Yes	Yes	Yes	Yes	Yes	Yes	Yes	Yes	Yes	100.00%
5540	Yes	Yes	Yes	Yes	Yes	Yes	Yes	Yes	Yes	Yes	100.00%
5545	Yes	Yes	Yes	Yes	Yes	Yes	Yes	Yes	Yes	Yes	100.00%
5550	Yes	Yes	Yes	Yes	Yes	Yes	Yes	Yes	Yes	Yes	100.00%
5555	Yes	Yes	Yes	Yes	Yes	Yes	Yes	Yes	Yes	Yes	100.00%
5560	Yes	Yes	Yes	Yes	Yes	Yes	Yes	Yes	Yes	Yes	100.00%
5565	Yes	Yes	Yes	Yes	Yes	Yes	Yes	Yes	Yes	Yes	100.00%
5566	Yes	Yes	Yes	Yes	Yes	Yes	Yes	Yes	Yes	Yes	100.00%
5567	Yes	Yes	Yes	Yes	Yes	Yes	Yes	Yes	Yes	Yes	100.00%
5568	Yes	Yes	Yes	Yes	Yes	Yes	Yes	Yes	Yes	Yes	100.00%
5569	Yes	Yes	Yes	Yes	Yes	Yes	Yes	Yes	Yes	Yes	100.00%
5570	Yes	Yes	Yes	Yes	Yes	Yes	Yes	Yes	Yes	Yes	100.00%
Detection Bandwidth: 80 MHz											
Specification: at least 100% of 99% of EUT bandwidth= 77.28 MHz											

EUT Frequency = 5570MHz (11ac-160MHz mode)

Frequency (MHz)	Trial 1	Trial 2	Trial 3	Trial 4	Trial 5	Trial 6	Trial 7	Trial 8	Trial 9	Trial 10	Detection Rate %
5489	Yes	Yes	Yes	Yes	Yes	Yes	Yes	Yes	Yes	Yes	100.00%
5490	Yes	Yes	Yes	Yes	Yes	Yes	Yes	Yes	Yes	Yes	100.00%
5491	Yes	Yes	Yes	Yes	Yes	Yes	Yes	Yes	Yes	Yes	100.00%
5492	Yes	Yes	Yes	Yes	Yes	Yes	Yes	Yes	Yes	Yes	100.00%
5493	Yes	Yes	Yes	Yes	Yes	Yes	Yes	Yes	Yes	Yes	100.00%
5494	Yes	Yes	Yes	Yes	Yes	Yes	Yes	Yes	Yes	Yes	100.00%
5495	Yes	Yes	Yes	Yes	Yes	Yes	Yes	Yes	Yes	Yes	100.00%
5500	Yes	Yes	Yes	Yes	Yes	Yes	Yes	Yes	Yes	Yes	100.00%
5510	Yes	Yes	Yes	Yes	Yes	Yes	Yes	Yes	Yes	Yes	100.00%
5530	Yes	Yes	Yes	Yes	Yes	Yes	Yes	Yes	Yes	Yes	100.00%
5550	Yes	Yes	Yes	Yes	Yes	Yes	Yes	Yes	Yes	Yes	100.00%
5570	Yes	Yes	Yes	Yes	Yes	Yes	Yes	Yes	Yes	Yes	100.00%
5590	Yes	Yes	Yes	Yes	Yes	Yes	Yes	Yes	Yes	Yes	100.00%
5610	Yes	Yes	Yes	Yes	Yes	Yes	Yes	Yes	Yes	Yes	100.00%
5630	Yes	Yes	Yes	Yes	Yes	Yes	Yes	Yes	Yes	Yes	100.00%
5640	Yes	Yes	Yes	Yes	Yes	Yes	Yes	Yes	Yes	Yes	100.00%
5645	Yes	Yes	Yes	Yes	Yes	Yes	Yes	Yes	Yes	Yes	100.00%
5646	Yes	Yes	Yes	Yes	Yes	Yes	Yes	Yes	Yes	Yes	100.00%
5647	Yes	Yes	Yes	Yes	Yes	Yes	Yes	Yes	Yes	Yes	100.00%
5648	Yes	Yes	Yes	Yes	Yes	Yes	Yes	Yes	Yes	Yes	100.00%
5649	Yes	Yes	Yes	Yes	Yes	Yes	Yes	Yes	Yes	Yes	100.00%
5650	Yes	Yes	Yes	Yes	Yes	Yes	Yes	Yes	Yes	Yes	100.00%
Detection Bandwidth: 80 MHz											
Specification: at least 100% of 99% of EUT bandwidth= 154.56 MHz											

7.3.6.2 Initial Channel Availability Check Time

The Initial Channel Availability Check Time tests that the UUT does not emit beacon, control, or data signals on the test Channel until the power-up sequence has been completed and the U-NII device checks for Radar Waveforms for one minute on the test Channel. This test does not use any Radar Waveforms and only needs to be performed one time.

The U-NII device is powered on and be instructed to operate at Low channel, Mid Channel or High channel. At the same time the UUT is powered on, the spectrum analyzer is set to zero span modes with a 3 MHz resolution bandwidth at low, mid can high channel with a 2.5-minute sweep time. The analyzer's sweep will be started the same time power is applied to the UNII device.

The UUT should not transmit any beacon or data transmissions until at least 1 minute after the completion of the power-on cycle.

The initial power up time of the UUT is indicated by marker 1 in the plot. Initial beacons/data transmissions are indicated by marker.

Note:

EUT initial power on cycle time before starting transmission is 74.47 Seconds.

This includes required 60 seconds of initial CAC time.

Test Plots

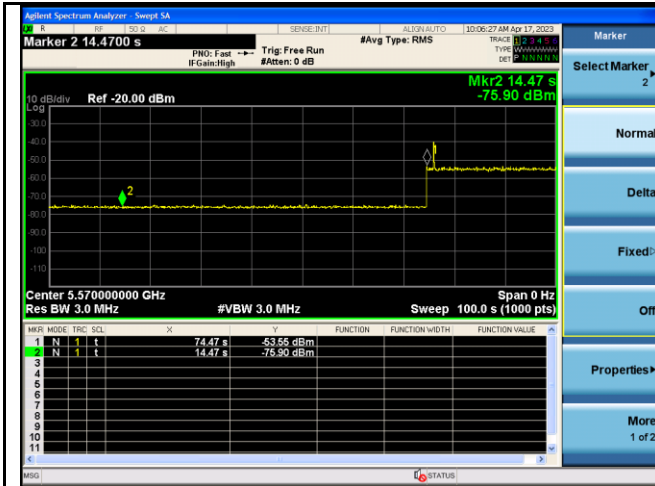

Initial CAC - 5570MHz

N/A

N/A

7.3.6.3 Radar Burst at the Beginning of the Channel Availability Check Time

Radar Burst at the Beginning of the Channel Availability Check Time: The steps below define the procedure to verify successful radar detection on the selected Channel during a period equal to the Channel Availability Check Time and avoidance of operation on that Channel when a radar burst with a level equal to the DFS Detection Threshold + 1 dB occurs at the beginning of the Channel Availability Check Time.

The UUT is powered on at T0. T1 denotes the instant when the UUT has completed its power-up sequence. The Channel Availability Check Time commences at instant T1 and will end no sooner than T1 + 60 seconds. A single Burst of short pulse of radar type 1 at -62 dBm will commence within a 6 second window.

Verify that during the 2.5-minute measurement window no UUT transmissions occurred at mid channel. Visual indication on the UUT of successful detection of the radar Burst will be recorded and reported.

Observation of emissions at center frequency of low channel, mid channel and high channel will continue for 2.5 minutes after the radar Burst has been generated.

Note:

For CAC at the beginning, the radar signal was injected within 6 seconds after CAC started.

For CAC at the end, the radar signal was injected within 6 seconds before CAC ended.

Frequency (MHz)	EUT power on cycle time (sec)	Timing window (sec)	Radar injection time window(sec)
5570	74.47	6	14.47 - 20.47

Test Plots

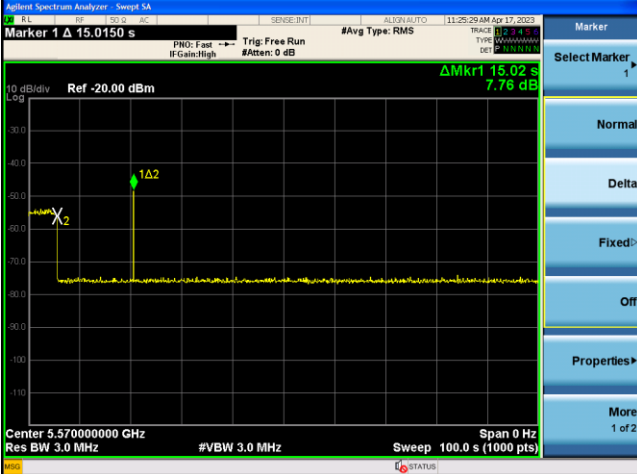
	<p>N/A</p>
<p>Radar at beginning of CAC – 5570MHz</p>	<p>N/A</p>

7.3.6.4 Radar Burst at the End of the Channel Availability Check Time

Radar Burst at the End of the Channel Availability Check Time: The steps below define the procedure to verify successful radar detection on the selected Channel during a period equal to the Channel Availability Check Time and avoidance of operation on that Channel when a radar Burst with a level equal to the DFS Detection Threshold + 1 dB occurs at the end of the Channel Availability Check Time.

The UUT is powered on at T0. T1 denotes the instant when the UUT has completed its power-up sequence. The Channel Availability Check Time commences at instant T1 and will end no sooner than T1 + 60 seconds.

A single Burst of short pulse of radar type 1 at -62 dBm will commence within a last 6 second window.

Visual indication on the UUT of successful detection of the radar Burst will be recorded and reported.

Observation of emissions at center frequency of mid channel will continue for 2.5 minutes after the radar Burst has been generated.

Verify that during the 2.5-minute measurement window no UUT transmissions occurred at mid channel.

Note:

For CAC at the beginning, the radar signal was injected within 6 seconds after CAC started.

For CAC at the end, the radar signal was injected within 6 seconds before CAC ended.

Frequency (MHz)	EUT power on cycle time (sec)	Timing window (sec)	Radar injection time window(sec)
5570	74.47	6	68.47 -74.47

Note: the EUT transmission was monitored more than 2.5 mins after the radar injection and no transmission occurred.

Test Plots

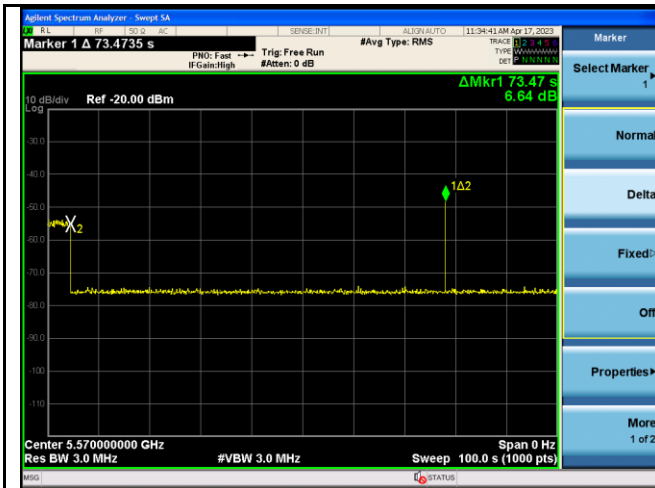

Radar at end of CAC - 5570MHz

N/A

N/A

7.3.6.5 In-Service Monitoring for Channel Move Time, Channel Closing Transmission Time and Non-Occupancy Period

These tests define how the following DFS parameters are verified during In-Service Monitoring; Channel Closing Transmission Time, Channel Move Time, and Non-Occupancy Period.

The steps below define the procedure to determine the above-mentioned parameters when a radar Burst with a level equal to the DFS Detection Threshold + 1dB is generated on the Operating Channel of the U-NII device.

A U-NII device operating as a Client Device will associate with the UUT (Master) at Mid Channel. Stream the MPEG test file from the Master Device to the Client Device on the selected Channel for the entire period of the test.

At time T₀ the Radar Waveform generator sends a Burst of pulses for each of the radar types at -62dBm.

Observe the transmissions of the UUT at the end of the radar Burst on the Operating Channel for duration greater than 10 seconds. Measure and record the transmissions from the UUT during the observation time (Channel Move Time). Compare the Channel Move Time and Channel Closing Transmission Time results to the limits defined in the DFS Response requirement values table.

Channel Closing Transmission Time- Measurement

A type 1 waveform was introduced to the EUT and the Spectrum Analyzer sweep time was set to 1s for monitoring and capturing the plot. A LabView program was created to collect trace data and capturing the plot. The program will calculate the channel closing time base on the spectrum analyzer result. The result will be calculated based on FCC procedure.

$$C = N * D_{well}$$

C is the closing time; N is the number of spectrum analyzer sampling bins showing a U-NII transmission and dwell is the dwell time per bin.

$$D_{well} = S / B$$

Where Dwell is the dwell time per spectrum analyzer sampling bin, S is the sweep time and B is the number of spectrum analyzer sampling bins.

Test Result for Channel Move Time

Frequency (MHz)	Channel Move Time (Sec)	Limit (Sec)
5570	<10	10

Test Result for Channel Closing Time

Frequency (MHz)	Standard Channel Closing Time (mS)	Remaining Aggregate Transmission (mS)	Total Channel Closing time (mS)	Limit (mS)
5570	200	0	200	260
5570	200	0	200	260

Test Result for Non-Occupancy Time

Frequency (MHz)	Non-Occupancy Period (min)	Limit (min)
5570	>30	30
5500	>30	30

Test Result

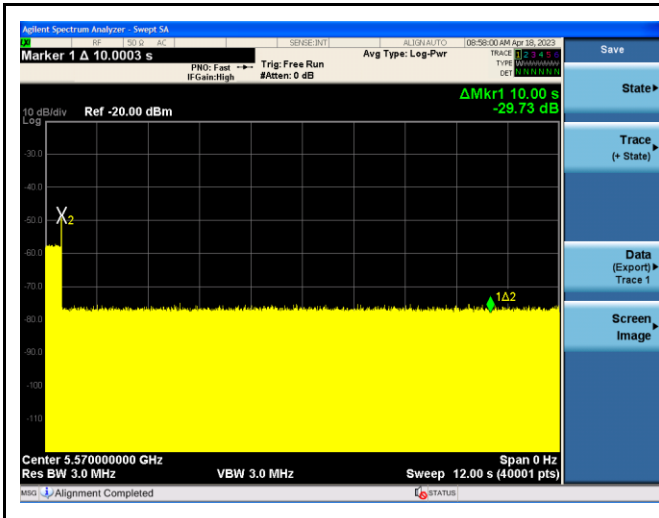

Channel Move Time - 5570MHz (Type0)

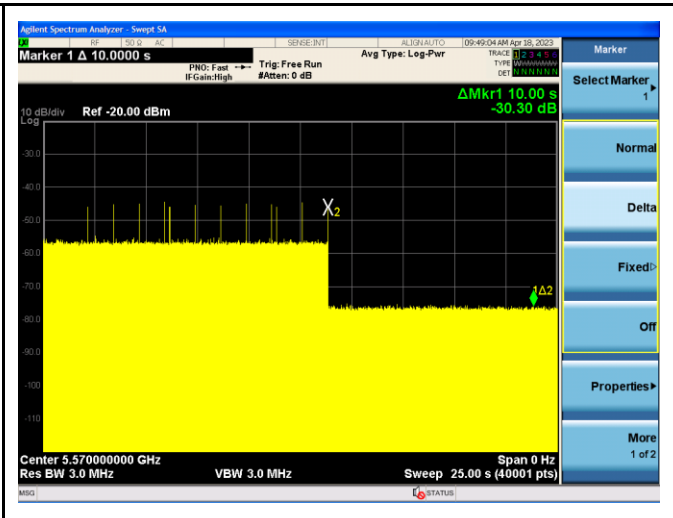

Channel Move Time - 5570MHz (Type5)



Channel Closing Time - 5570MHz (Type0)

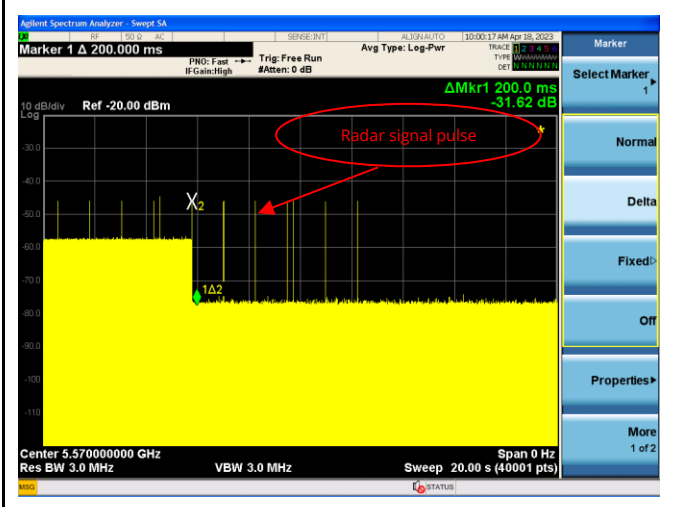

Channel Closing Time - 5570MHz (Type5)

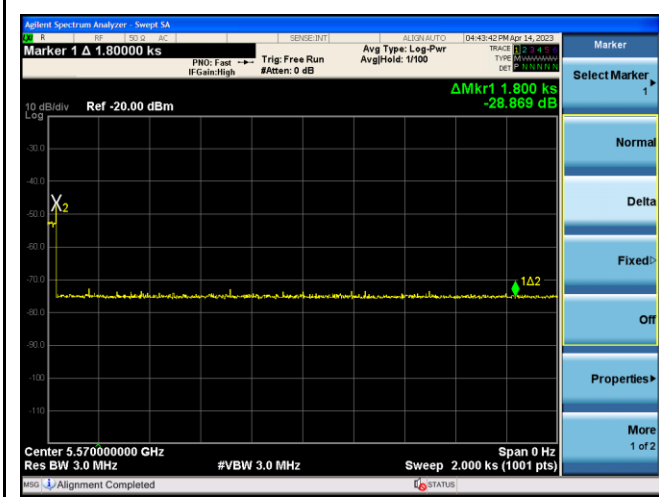

Non-Occupancy Period - 5570MHz

N/A

N/A

7.3.6.6 Statistical Performance Check

Statistical Performance Check, the steps below define the procedure to determine the minimum percentage of detection when a radar burst with a level equal to the DFS Detection Threshold + 1dB is generated on the Operating Channel of the U-NII device.

A U-NII device operating as a Client Device will associate with the UUT (Master) at Low, Mid and High Channel. Stream the MPEG test file from the Master Device to the Client Device on the selected Channel for the entire period of the test.

The Radar Waveform generator sends the individual waveform for each of the radar types 0-6 at -62dbm. Statistical data will be gathered to determine the ability of the device to detect the radar test waveforms. The device can utilize a test mode to demonstrate when detection occurs to prevent the need to reset the device

TotalWaveformDetections

$\frac{\text{TotalWaveformDetections}}{\text{TotalWaveformTrials}} \times 100 = \text{Probability of Detection Radar Waveform calculated by:}$

The Minimum number of trails, minimum percentage of successful detection and the average minimum percentage of successful detection are found in the Radar Test Waveforms section.

Short Pulse Radar Test Waveforms

Table 5 – Short Pulse Radar Test Waveforms

Radar Type	Pulse Width (µsec)	PRI (µsec)	Number of Pulses	Minimum Percentage of Successful Detection	Minimum Number of Trials
1	1	3066	18	60%	30
2	1~5	150-230	23-29	60%	30
3	6~10	200-500	16-18	60%	30
4	11~20	200-500	12-16	60%	30
Aggregate (Radar Types 1-4)				80%	120

The aggregate is the average of the percentage of successful detections of Short Pulse Radar Types 1-4. For example, the following table indicates how to compute the aggregate of percentage of successful detections.

Radar Type	Number of Trials	Number of Successful Detections	Minimum Percentage of Successful Detection
1	35	29	82.9%
2	30	18	60%
3	30	27	90%
4	50	44	88%
Aggregate (82.9%+60%+90%+88%)/4 = 80.2%			

Long Pulse Radar Test Waveform

Table 6 – Long Pulse Radar Test Waveform

Radar Type	Pulse Width (μsec)	Chirp Width (MHz)	PRI (μsec)	Number of Pulses per Burst	Number of Bursts	Minimum Percentage of Successful Detection	Minimum Number of Trials
5	50-100	5-20	1000- 2000	1-3	8-20	80%	30

The parameters for this waveform are randomly chosen. Thirty unique waveforms are required for the Long Pulse Radar Type waveforms. If more than 30 waveforms are used for the Long Pulse Radar Type waveforms, then each additional waveform must also be unique and not repeated from the previous waveforms.

Frequency Hopping Radar Test Waveform

Table 7 – Frequency Hopping Radar Test Waveform

Radar Type	Pulse Width (μsec)	PRI (μsec)	Pulses per Hop	Hopping Rate (kHz)	Hopping Sequence Length (msec)	Minimum Percentage of Successful Detection	Minimum Number of Trials
6	1	333	9	0.333	300	70%	30

For the Frequency Hopping Radar Type, the same Burst parameters are used for each waveform. The hopping sequence is different for each waveform and a 100-length segment is selected from the hopping sequence defined by the following algorithm:

The first frequency in a hopping sequence is selected randomly from the group of 475 integer frequencies from 5250 – 5724 MHz. Next, the frequency that was just chosen is removed from the group and a frequency is randomly selected from the remaining 474 frequencies in the group. This process continues until all 475 frequencies are chosen for the set. For selection of a random frequency, the frequencies remaining within the group are always treated as equally likely.

Test Result-5500MHz – 802.11a

Detection = Yes, No Detection = No								
Trials	Frequency (MHz)	Waveform	Type1	Type2	Type3	Type4	Type5	Type6
0	5490	WFM1	Yes	Yes	Yes	Yes	Yes	Yes
1	5491	WFM2	Yes	Yes	Yes	Yes	Yes	Yes
2	5492	WFM3	Yes	Yes	Yes	Yes	Yes	Yes
3	5493	WFM4	Yes	Yes	No	Yes	Yes	Yes
4	5494	WFM5	Yes	Yes	Yes	No	Yes	Yes
5	5500	WFM6	Yes	Yes	Yes	Yes	Yes	Yes
6	5500	WFM7	Yes	Yes	Yes	Yes	Yes	Yes
7	5500	WFM8	Yes	Yes	Yes	Yes	Yes	Yes
8	5500	WFM9	Yes	Yes	Yes	Yes	Yes	Yes
9	5500	WFM10	Yes	Yes	Yes	Yes	Yes	Yes
10	5500	WFM11	Yes	Yes	Yes	Yes	Yes	Yes
11	5500	WFM12	Yes	Yes	Yes	Yes	Yes	Yes
12	5500	WFM13	Yes	Yes	Yes	Yes	Yes	Yes
13	5500	WFM14	Yes	Yes	Yes	Yes	Yes	Yes
14	5500	WFM15	Yes	Yes	Yes	Yes	Yes	Yes
15	5500	WFM16	Yes	Yes	Yes	Yes	Yes	Yes
16	5500	WFM17	Yes	Yes	Yes	Yes	Yes	Yes
17	5500	WFM18	Yes	Yes	Yes	Yes	Yes	Yes
18	5500	WFM19	Yes	Yes	Yes	Yes	Yes	Yes
19	5500	WFM20	Yes	Yes	Yes	Yes	Yes	Yes
20	5500	WFM21	Yes	Yes	Yes	Yes	Yes	Yes
21	5500	WFM22	Yes	Yes	Yes	Yes	Yes	Yes
22	5500	WFM23	Yes	Yes	Yes	Yes	Yes	Yes
23	5500	WFM24	Yes	Yes	Yes	Yes	Yes	Yes
24	5500	WFM25	Yes	Yes	Yes	Yes	Yes	Yes
25	5506	WFM26	Yes	Yes	Yes	Yes	Yes	Yes
26	5507	WFM27	Yes	Yes	Yes	Yes	Yes	Yes
27	5508	WFM28	Yes	Yes	Yes	No	Yes	Yes
28	5509	WFM29	Yes	Yes	Yes	Yes	Yes	Yes
29	5510	WFM30	Yes	Yes	Yes	Yes	Yes	Yes
Detection Probability Rate %:			100	100	96.7	93.3	100	100
Limit			≥60%	≥60%	≥60%	≥60%	≥80%	≥70%

Test Result-5510MHz – 802.11ac40

Detection = Yes, No Detection = No								
Trials	Frequency (MHz)	Waveform	Type1	Type2	Type3	Type4	Type5	Type6
0	5500	WFM1	Yes	Yes	Yes	Yes	Yes	Yes
1	5501	WFM2	Yes	Yes	Yes	Yes	Yes	Yes
2	5502	WFM3	Yes	Yes	Yes	Yes	Yes	Yes
3	5503	WFM4	Yes	Yes	Yes	Yes	No	Yes
4	5504	WFM5	Yes	No	Yes	Yes	Yes	Yes
5	5510	WFM6	Yes	Yes	Yes	Yes	Yes	Yes
6	5510	WFM7	Yes	Yes	Yes	Yes	Yes	Yes
7	5510	WFM8	Yes	Yes	Yes	Yes	Yes	Yes
8	5510	WFM9	Yes	Yes	Yes	Yes	Yes	Yes
9	5510	WFM10	Yes	Yes	Yes	Yes	Yes	Yes
10	5510	WFM11	Yes	Yes	Yes	Yes	Yes	Yes
11	5510	WFM12	Yes	Yes	Yes	Yes	Yes	Yes
12	5510	WFM13	Yes	Yes	Yes	Yes	Yes	Yes
13	5510	WFM14	Yes	Yes	Yes	Yes	Yes	Yes
14	5510	WFM15	Yes	Yes	Yes	Yes	Yes	Yes
15	5510	WFM16	Yes	Yes	Yes	Yes	Yes	Yes
16	5510	WFM17	Yes	Yes	Yes	Yes	Yes	Yes
17	5510	WFM18	Yes	Yes	Yes	Yes	Yes	Yes
18	5510	WFM19	Yes	Yes	Yes	Yes	Yes	Yes
19	5510	WFM20	Yes	Yes	Yes	Yes	Yes	Yes
20	5510	WFM21	Yes	Yes	Yes	Yes	Yes	Yes
21	5510	WFM22	Yes	Yes	Yes	Yes	Yes	Yes
22	5510	WFM23	Yes	Yes	Yes	Yes	Yes	Yes
23	5510	WFM24	Yes	Yes	Yes	Yes	No	Yes
24	5510	WFM25	Yes	Yes	Yes	Yes	Yes	Yes
25	5516	WFM26	Yes	Yes	Yes	Yes	Yes	Yes
26	5517	WFM27	Yes	Yes	Yes	Yes	Yes	Yes
27	5518	WFM28	Yes	Yes	Yes	Yes	Yes	Yes
28	5519	WFM29	Yes	Yes	Yes	Yes	Yes	Yes
29	5520	WFM30	Yes	Yes	Yes	Yes	Yes	Yes
Detection Probability Rate %:			100	96.7	100	100	93.3	100
Limit			≥60%	≥60%	≥60%	≥60%	≥80%	≥70%

Test Result-5530MHz – 802.11ac80

Detection = Yes, No Detection = No								
Trials	Frequency (MHz)	Waveform	Type1	Type2	Type3	Type4	Type5	Type6
0	5520	WFM1	Yes	Yes	Yes	Yes	Yes	Yes
1	5521	WFM2	Yes	Yes	Yes	Yes	No	Yes
2	5522	WFM3	Yes	Yes	Yes	Yes	Yes	Yes
3	5523	WFM4	Yes	Yes	Yes	Yes	Yes	No
4	5524	WFM5	Yes	Yes	Yes	Yes	Yes	Yes
5	5530	WFM6	Yes	Yes	Yes	Yes	Yes	Yes
6	5530	WFM7	Yes	Yes	Yes	Yes	Yes	Yes
7	5530	WFM8	Yes	Yes	Yes	Yes	Yes	Yes
8	5530	WFM9	Yes	Yes	Yes	Yes	Yes	Yes
9	5530	WFM10	Yes	Yes	Yes	Yes	Yes	Yes
10	5530	WFM11	Yes	Yes	Yes	Yes	Yes	Yes
11	5530	WFM12	Yes	Yes	Yes	Yes	Yes	Yes
12	5530	WFM13	Yes	Yes	Yes	Yes	Yes	Yes
13	5530	WFM14	Yes	Yes	Yes	Yes	Yes	Yes
14	5530	WFM15	Yes	Yes	Yes	Yes	Yes	Yes
15	5530	WFM16	Yes	Yes	Yes	Yes	Yes	Yes
16	5530	WFM17	Yes	Yes	Yes	Yes	Yes	Yes
17	5530	WFM18	Yes	Yes	Yes	Yes	Yes	Yes
18	5530	WFM19	Yes	Yes	Yes	Yes	Yes	Yes
19	5530	WFM20	Yes	Yes	Yes	Yes	Yes	Yes
20	5530	WFM21	Yes	Yes	Yes	Yes	Yes	Yes
21	5530	WFM22	Yes	Yes	Yes	Yes	Yes	Yes
22	5530	WFM23	Yes	Yes	Yes	Yes	Yes	Yes
23	5530	WFM24	Yes	Yes	Yes	Yes	Yes	Yes
24	5530	WFM25	Yes	Yes	Yes	Yes	Yes	Yes
25	5536	WFM26	Yes	Yes	Yes	Yes	Yes	Yes
26	5537	WFM27	Yes	Yes	Yes	Yes	Yes	Yes
27	5538	WFM28	Yes	Yes	Yes	Yes	No	Yes
28	5539	WFM29	Yes	Yes	Yes	Yes	Yes	Yes
29	5540	WFM30	Yes	Yes	Yes	Yes	Yes	Yes
Detection Probability Rate %:			100	100	100	100	93.3	96.7
Limit			≥60%	≥60%	≥60%	≥60%	≥80%	≥70%

Test Result-5570MHz – 802.11ac160

Detection = Yes, No Detection = No								
Trials	Frequency (MHz)	Waveform	Type1	Type2	Type3	Type4	Type5	Type6
0	5500	WFM1	Yes	Yes	Yes	Yes	Yes	Yes
1	5500	WFM2	Yes	Yes	Yes	Yes	Yes	Yes
2	5500	WFM3	No	Yes	Yes	Yes	Yes	No
3	5523	WFM4	Yes	Yes	Yes	Yes	No	Yes
4	5523	WFM5	Yes	Yes	Yes	Yes	Yes	Yes
5	5523	WFM6	Yes	Yes	Yes	Yes	Yes	Yes
6	5530	WFM7	Yes	No	Yes	Yes	Yes	Yes
7	5530	WFM8	Yes	Yes	Yes	Yes	Yes	Yes
8	5530	WFM9	Yes	Yes	Yes	Yes	Yes	Yes
9	5545	WFM10	Yes	Yes	Yes	Yes	Yes	Yes
10	5545	WFM11	Yes	Yes	Yes	Yes	Yes	Yes
11	5545	WFM12	Yes	Yes	Yes	Yes	Yes	Yes
12	5570	WFM13	Yes	Yes	Yes	Yes	Yes	Yes
13	5570	WFM14	Yes	Yes	Yes	Yes	Yes	Yes
14	5570	WFM15	Yes	Yes	Yes	Yes	Yes	Yes
15	5570	WFM16	Yes	Yes	Yes	Yes	Yes	Yes
16	5570	WFM17	Yes	Yes	Yes	Yes	Yes	Yes
17	5570	WFM18	Yes	Yes	Yes	Yes	Yes	Yes
18	5570	WFM19	Yes	Yes	Yes	Yes	Yes	Yes
19	5570	WFM20	Yes	Yes	Yes	Yes	Yes	Yes
20	5570	WFM21	Yes	Yes	Yes	Yes	Yes	Yes
21	5570	WFM22	Yes	Yes	Yes	Yes	Yes	Yes
22	5570	WFM23	Yes	Yes	Yes	Yes	Yes	Yes
23	5570	WFM24	Yes	Yes	Yes	Yes	Yes	Yes
24	5570	WFM25	Yes	Yes	Yes	Yes	Yes	Yes
25	5610	WFM26	Yes	Yes	Yes	Yes	No	Yes
26	5615	WFM27	Yes	Yes	Yes	Yes	Yes	Yes
27	5545	WFM28	Yes	Yes	Yes	Yes	Yes	Yes
28	5645	WFM29	Yes	Yes	Yes	Yes	Yes	No
29	5645	WFM30	Yes	Yes	Yes	Yes	Yes	Yes
Detection Probability Rate %:			96.7	96.7	100	100	93.3	93.3
Limit			≥60%	≥60%	≥60%	≥60%	≥80%	≥70%

8 DFS Radar Waveform Characteristic

Trial Id	Radar Type	Pulse Width (us)	PRI (us)	Number of Pulses	Waveform Length (us)
0	Type 0	1	1428	18	25704
1	Type 0	1	1428	18	25704
2	Type 0	1	1428	18	25704
3	Type 0	1	1428	18	25704
4	Type 0	1	1428	18	25704
5	Type 0	1	1428	18	25704
6	Type 0	1	1428	18	25704
7	Type 0	1	1428	18	25704
8	Type 0	1	1428	18	25704
9	Type 0	1	1428	18	25704
10	Type 0	1	1428	18	25704
11	Type 0	1	1428	18	25704
12	Type 0	1	1428	18	25704
13	Type 0	1	1428	18	25704
14	Type 0	1	1428	18	25704
15	Type 0	1	1428	18	25704
16	Type 0	1	1428	18	25704
17	Type 0	1	1428	18	25704
18	Type 0	1	1428	18	25704

Trial Id	Radar Type	Pulse Width (us)	PRI (us)	Number of Pulses	Waveform Length (us)
0	Type 1	1	938	57	53466
1	Type 1	1	698	76	53048
2	Type 1	1	618	86	53148
3	Type 1	1	538	99	53262
4	Type 1	1	878	61	53558
5	Type 1	1	3066	18	55188
6	Type 1	1	638	83	52954
7	Type 1	1	918	58	53244
8	Type 1	1	838	63	52794
9	Type 1	1	858	62	53196
10	Type 1	1	798	67	53466
11	Type 1	1	718	74	53132
12	Type 1	1	578	92	53176
13	Type 1	1	598	89	53222
14	Type 1	1	558	95	53010
15	Type 1	1	2536	21	53256
16	Type 1	1	966	55	53130
17	Type 1	1	827	64	52928
18	Type 1	1	2501	22	55022
19	Type 1	1	2595	21	54495
20	Type 1	1	1114	48	53472
21	Type 1	1	1302	41	53382
22	Type 1	1	3045	18	54810
23	Type 1	1	1624	33	53592
24	Type 1	1	2878	19	54682
25	Type 1	1	1027	52	53404
26	Type 1	1	2485	22	54670
27	Type 1	1	1600	33	52800
28	Type 1	1	1172	46	53912
29	Type 1	1	1177	45	52965

Trial Id	Radar Type	Pulse Width (us)	PRI (us)	Number of Pulses	Waveform Length (us)
0	Type 2	3.2	179	26	4654
1	Type 2	1.1	207	23	4761
2	Type 2	2.1	230	24	5520
3	Type 2	4.8	200	29	5800
4	Type 2	3.9	214	28	5992
5	Type 2	2.9	222	26	5772
6	Type 2	3.2	204	26	5304
7	Type 2	2.5	192	25	4800
8	Type 2	3.1	164	26	4264
9	Type 2	1.2	156	23	3588
10	Type 2	3.9	210	27	5670
11	Type 2	4.6	201	29	5829
12	Type 2	3.2	162	26	4212
13	Type 2	2.2	197	25	4925
14	Type 2	4.5	163	29	4727
15	Type 2	3	203	26	5278
16	Type 2	5	168	29	4872
17	Type 2	2.4	217	25	5425
18	Type 2	2.9	191	26	4966
19	Type 2	2.3	166	25	4150
20	Type 2	3.7	150	27	4050
21	Type 2	2.2	176	25	4400
22	Type 2	4.9	195	29	5655
23	Type 2	2.9	202	26	5252
24	Type 2	2.5	178	25	4450
25	Type 2	1.1	206	23	4738
26	Type 2	3.8	155	27	4185
27	Type 2	4.7	157	29	4553
28	Type 2	2.4	224	25	5600
29	Type 2	4.2	159	28	4452

Trial Id	Radar Type	Pulse Width (us)	PRI (us)	Number of Pulses	Waveform Length (us)
0	Type 3	8.2	355	17	6035
1	Type 3	6.1	487	16	7792
2	Type 3	7.1	344	16	5504
3	Type 3	9.8	288	18	5184
4	Type 3	8.9	230	18	4140
5	Type 3	7.9	432	17	7344
6	Type 3	8.2	207	17	3519
7	Type 3	7.5	443	17	7531
8	Type 3	8.1	439	17	7463
9	Type 3	6.2	223	16	3568
10	Type 3	8.9	208	18	3744
11	Type 3	9.6	463	18	8334
12	Type 3	8.2	441	17	7497
13	Type 3	7.2	323	16	5168
14	Type 3	9.5	297	18	5346
15	Type 3	8	412	17	7004
16	Type 3	10	324	18	5832
17	Type 3	7.4	271	17	4607
18	Type 3	7.9	349	17	5933
19	Type 3	7.3	409	16	6544
20	Type 3	8.7	373	18	6714
21	Type 3	7.2	254	16	4064
22	Type 3	9.9	274	18	4932
23	Type 3	7.9	278	17	4726
24	Type 3	7.5	317	17	5389
25	Type 3	6.1	260	16	4160
26	Type 3	8.8	211	18	3798
27	Type 3	9.7	272	18	4896
28	Type 3	7.4	264	17	4488
29	Type 3	9.2	284	18	5112

Trial Id	Radar Type	Pulse Width (us)	PRI (us)	Number of Pulses	Waveform Length (us)
0	Type 4	16	355	14	4970
1	Type 4	11.3	487	12	5844
2	Type 4	13.5	344	13	4472
3	Type 4	19.4	288	16	4608
4	Type 4	17.5	230	15	3450
5	Type 4	15.3	432	14	6048
6	Type 4	15.9	207	14	2898
7	Type 4	14.3	443	13	5759
8	Type 4	15.8	439	14	6146
9	Type 4	11.5	223	12	2676
10	Type 4	17.4	208	15	3120
11	Type 4	19	463	16	7408
12	Type 4	16	441	14	6174
13	Type 4	13.8	323	13	4199
14	Type 4	18.9	297	16	4752
15	Type 4	15.5	412	14	5768
16	Type 4	19.9	324	16	5184
17	Type 4	14.1	271	13	3523
18	Type 4	15.2	349	14	4886
19	Type 4	13.8	409	13	5317
20	Type 4	17.1	373	15	5595
21	Type 4	13.8	254	13	3302
22	Type 4	19.8	274	16	4384
23	Type 4	15.3	278	14	3892
24	Type 4	14.5	317	13	4121
25	Type 4	11.3	260	12	3120
26	Type 4	17.3	211	15	3165
27	Type 4	19.2	272	16	4352
28	Type 4	14.2	264	13	3432
29	Type 4	18.2	284	15	4260

Type5 waveform#0

Trial Id	Radar Type	Number of Bursts	Burst Period (s)	Waveform Length (us)				
0	Type 5	15	0.8	12				
	Burst ID	Burst Offset (us)	Pulse Width (us)	Chirp Width (MHz)	Number of Pulses per Burst	PRI-1 (us)	PRI-2 (us)	PRI-3 (us)
	0	636185	77.8	13	2	1665	1477	-
	1	32674	51.9	5	1	1074	-	-
	2	226294	63.8	9	1	1584	-	-
	3	417976	96.6	19	3	1682	1786	1843
	4	611152	85.9	16	3	1795	1215	1729
	5	8789	73.7	12	2	1198	1549	-
	6	201917	77.2	13	2	1837	1819	-
	7	395530	68.4	10	2	1587	1114	-
	8	588564	76.7	13	2	2000	1155	-
	9	783794	53.2	6	1	1147	-	-
	10	177933	85.7	16	3	1433	1695	1394
	11	370624	94.3	19	3	1670	1426	1935
	12	564893	77.6	13	2	1294	1671	-
	13	759583	65.7	10	1	1512	-	-
	14	154262	93.5	18	3	1444	1130	1468

Type5 waveform#1

Trial Id	Radar Type	Number of Bursts	Burst Period (s)	Waveform Length (us)				
1	Type 5	8	1.5	12				
	Burst ID	Burst Offset (us)	Pulse Width (us)	Chirp Width (MHz)	Number of Pulses per Burst	PRI-1 (us)	PRI-2 (us)	PRI-3 (us)
	0	653020	75	12	2	1880	1527	-
	1	1015643	99.4	20	3	1401	1262	1257
	2	1379398	67.4	10	2	1531	1403	-
	3	245489	73.6	12	2	1449	1041	-
	4	609113	65.9	10	1	1432	-	-
	5	970852	83.8	15	3	1356	1292	1419
	6	1335913	65.5	9	1	1543	-	-
	7	200406	98.6	20	3	1548	1796	1728

Type5 waveform#2

Trial Id	Radar Type	Number of Bursts	Burst Period (s)	Waveform Length (us)				
2	Type 5	11	1.090909	12				
	Burst ID	Burst Offset (us)	Pulse Width (us)	Chirp Width (MHz)	Number of Pulses per Burst	PRI-1 (us)	PRI-2 (us)	PRI-3 (us)
	0	409565	73.8	12	2	1806	1538	-
	1	673692	69.5	11	2	1117	1649	-
	2	938562	51.9	5	1	1651	-	-
	3	113209	84.6	16	3	1976	1032	1271
	4	376726	95.4	19	3	1060	1903	1388
	5	641212	68	10	2	1368	1351	-
	6	903714	89.6	17	3	1338	1514	1573
	7	80863	81.9	15	2	1022	1689	-
	8	344067	88.3	17	3	1810	1330	1838
	9	609331	53.7	6	1	1597	-	-
	10	871542	91.3	18	3	1961	1106	1001

Type5 waveform#3

Trial Id	Radar Type	Number of Bursts	Burst Period (s)	Waveform Length (us)				
3	Type 5	20	0.6	12				
	Burst ID	Burst Offset (us)	Pulse Width (us)	Chirp Width (MHz)	Number of Pulses per Burst	PRI-1 (us)	PRI-2 (us)	PRI-3 (us)
	0	26541	68.1	10	2	1339	1355	-
	1	171821	58.7	7	1	1251	-	-
	2	316229	75.3	13	2	1136	1640	-
	3	461864	56.4	7	1	1753	-	-
	4	8677	99.7	20	3	1196	1708	1159
	5	153995	57.7	7	1	1013	-	-
	6	299238	59.5	8	1	1072	-	-
	7	443177	80	14	2	1482	1369	-
	8	587671	82	15	2	1993	1197	-
	9	135674	82.8	15	2	1883	1005	-
	10	279928	88	17	3	1061	1928	1101
	11	424279	93.2	18	3	1207	1907	1223
	12	570132	70.4	11	2	1526	1360	-
	13	117439	95.3	19	3	1171	1955	1775
	14	262502	81.9	15	2	1690	1545	-
	15	406573	98.5	20	3	1975	1169	1062
	16	553328	65	9	1	1767	-	-
	17	99799	85.4	16	3	1011	1637	1425
	18	244095	91.6	18	3	1878	1445	1325
	19	390012	67.3	10	2	1091	1218	-

Type5 waveform#4

Trial Id	Radar Type	Number of Bursts	Burst Period (s)	Waveform Length (us)				
4	Type 5	17	0.705882	12				
	Burst ID	Burst Offset (us)	Pulse Width (us)	Chirp Width (MHz)	Number of Pulses per Burst	PRI-1 (us)	PRI-2 (us)	PRI-3 (us)
	0	629614	67.9	10	2	1320	1133	-
	1	96856	62.3	8	1	1957	-	-
	2	267719	53.3	6	1	1592	-	-
	3	436784	90	17	3	1900	1153	1346
	4	608289	77.1	13	2	1166	1646	-
	5	75610	83.9	15	3	1278	1232	1459
	6	245638	89.1	17	3	1240	1384	1939
	7	416355	81.8	15	2	1833	1676	-
	8	588736	50.3	5	1	1075	-	-
	9	54571	87.1	16	3	1116	1996	1756
	10	225175	71.3	11	2	1225	1815	-
	11	394825	97.5	20	3	1884	1465	1132
	12	565361	90.6	17	3	1561	1040	1354
	13	33643	86.3	16	3	1596	1183	1792
	14	203957	97.6	20	3	1365	1073	1361
	15	373812	84.7	16	3	1021	1718	1854
	16	544060	99.7	20	3	1150	1244	1988

Type5 waveform#5

Trial Id	Radar Type	Number of Bursts	Burst Period (s)	Waveform Length (us)				
5	Type 5	14	0.857143	12				
	Burst ID	Burst Offset (us)	Pulse Width (us)	Chirp Width (MHz)	Number of Pulses per Burst	PRI-1 (us)	PRI-2 (us)	PRI-3 (us)
	0	15438	92.9	18	3	1085	1564	1407
	1	222486	67.7	10	2	1744	1747	-
	2	430731	65.8	10	1	1092	-	-
	3	637784	56.3	7	1	1851	-	-
	4	845342	53.7	6	1	1727	-	-
	5	196720	83.5	15	3	1679	1930	1025
	6	404955	65.8	10	1	1519	-	-
	7	610711	85.9	16	3	1134	1034	1808
	8	818057	76.3	13	2	1606	1926	-
	9	171459	81.5	15	2	1891	1714	-
	10	377969	89.4	17	3	1310	1594	1827
	11	586875	63.4	9	1	1568	-	-
	12	792834	69.6	11	2	1307	1925	-
	13	146044	74.5	12	2	1264	1846	-

Type5 waveform#6

Trial Id	Radar Type	Number of Bursts	Burst Period (s)	Waveform Length (us)				
6	Type 5	15	0.8	12				
	Burst ID	Burst Offset (us)	Pulse Width (us)	Chirp Width (MHz)	Number of Pulses per Burst	PRI-1 (us)	PRI-2 (us)	PRI-3 (us)
	0	329022	96.6	19	3	1182	1609	1581
	1	521718	96.7	19	3	1829	1799	1154
	2	714222	86.5	16	3	1923	1396	1865
	3	112450	73.3	12	2	1908	1318	-
	4	306283	55.8	6	1	1688	-	-
	5	500239	55.4	6	1	1145	-	-
	6	690932	85.3	16	3	1336	1504	1820
	7	88645	79.4	14	2	1344	1893	-
	8	282508	65.7	10	1	1476	-	-
	9	475842	68.6	10	2	1008	1028	-
	10	667887	77.7	13	2	1972	1835	-
	11	64845	79.6	14	2	1882	1331	-
	12	257755	94.9	19	3	1830	1070	1349
	13	452335	61.4	8	1	1451	-	-
	14	643395	90.6	17	3	1233	1562	1887

Type5 waveform#7

Trial Id	Radar Type	Number of Bursts	Burst Period (s)	Waveform Length (us)				
7	Type 5	12	1	12				
	Burst ID	Burst Offset (us)	Pulse Width (us)	Chirp Width (MHz)	Number of Pulses per Burst	PRI-1 (us)	PRI-2 (us)	PRI-3 (us)
	0	51446	52.6	5	1	1210	-	-
	1	292696	84.1	15	3	1314	1725	1529
	2	533989	97.7	20	3	1139	1868	1805
	3	775564	97.3	20	3	1341	1446	1755
	4	21542	98.8	20	3	1544	1386	1302
	5	263385	72.2	12	2	1771	1184	-
	6	505581	67.6	10	2	1175	1027	-
	7	747058	75.7	13	2	1026	1871	-
	8	989976	60.9	8	1	1798	-	-
	9	234024	64.2	9	1	1138	-	-
	10	475207	78.8	14	2	1784	1604	-
	11	715825	87.5	16	3	1511	1712	1683

Type5 waveform#8

Trial Id	Radar Type	Number of Bursts	Burst Period (s)	Waveform Length (us)				
8	Type 5	14	0.857143	12				
	Burst ID	Burst Offset (us)	Pulse Width (us)	Chirp Width (MHz)	Number of Pulses per Burst	PRI-1 (us)	PRI-2 (us)	PRI-3 (us)
	0	823112	54.1	6	1	1415	-	-
	1	174965	50.7	5	1	1221	-	-
	2	382216	52.3	5	1	1974	-	-
	3	587395	99.8	20	3	1558	1696	1949
	4	796897	68.4	10	2	1014	1099	-
	5	149042	80.8	14	2	1736	1505	-
	6	356750	62.5	9	1	1778	-	-
	7	563824	74.8	12	2	1149	1204	-
	8	772314	50.8	5	1	1049	-	-
	9	123796	54	6	1	1417	-	-
	10	331215	63	9	1	1730	-	-
	11	537402	91.8	18	3	1143	1270	1347
	12	744805	79.3	14	2	1274	1992	-
	13	98172	64.3	9	1	1937	-	-

Type5 waveform#9

Trial Id	Radar Type	Number of Bursts	Burst Period (s)	Waveform Length (us)				
9	Type 5	8	1.5	12				
	Burst ID	Burst Offset (us)	Pulse Width (us)	Chirp Width (MHz)	Number of Pulses per Burst	PRI-1 (us)	PRI-2 (us)	PRI-3 (us)
	0	535615	63.4	9	1	1043	-	-
	1	898668	52	5	1	1863	-	-
	2	1259235	97.2	20	3	1973	1605	1583
	3	127106	78.7	14	2	1466	1743	-
	4	490358	74.2	12	2	1280	1219	-
	5	852409	88.7	17	3	1293	1934	1273
	6	1217152	54.3	6	1	1991	-	-
	7	82296	95.4	19	3	1580	1555	1791

Type5 waveform#10

Trial Id	Radar Type	Number of Bursts	Burst Period (s)	Waveform Length (us)				
10	Type 5	17	0.705882	12				
	Burst ID	Burst Offset (us)	Pulse Width (us)	Chirp Width (MHz)	Number of Pulses per Burst	PRI-1 (us)	PRI-2 (us)	PRI-3 (us)
	0	209249	73.7	12	2	1208	1497	-
	1	378386	97.4	20	3	1942	1754	1613
	2	548411	91.7	18	3	1999	1702	1462
	3	17733	66.2	10	1	1393	-	-
	4	187952	70.8	11	2	1968	1821	-
	5	359277	52.3	5	1	1740	-	-
	6	528886	78.9	14	2	1308	1984	-
	7	700166	70.9	11	2	1050	1358	-
	8	167197	75.6	13	2	1437	1430	-
	9	338262	59.1	7	1	1697	-	-
	10	508324	77	13	2	1397	1304	-
	11	678689	67.9	10	2	1803	1083	-
	12	146031	81.2	14	2	1720	1932	-
	13	316923	78.7	14	2	1247	1121	-
	14	488056	63.3	9	1	1634	-	-
	15	657326	68.9	11	2	1849	1423	-
	16	125509	59.3	7	1	1093	-	-

Type5 waveform#11

Trial Id	Radar Type	Number of Bursts	Burst Period (s)	Waveform Length (us)				
11	Type 5	19	0.631579	12				
	Burst ID	Burst Offset (us)	Pulse Width (us)	Chirp Width (MHz)	Number of Pulses per Burst	PRI-1 (us)	PRI-2 (us)	PRI-3 (us)
	0	263736	98.9	20	3	1381	1680	1488
	1	416459	82.3	15	2	1716	1855	-
	2	567902	86.7	16	3	1211	1400	1919
	3	92979	89.7	17	3	1861	1068	1282
	4	245155	98.6	20	3	1507	1194	1461
	5	397609	71.1	11	2	1921	1789	-
	6	551431	55.9	6	1	1947	-	-
	7	74413	67.9	10	2	1350	1372	-
	8	226559	84.4	16	3	1203	1107	1443
	9	380056	58.8	7	1	1715	-	-
	10	533408	65.6	9	1	1017	-	-
	11	55547	78.5	14	2	1911	1704	-
	12	207876	82.3	15	2	1845	1686	-
	13	359771	90.1	17	3	1938	1071	1266
	14	511297	90.2	17	3	1989	1089	1950
	15	36803	83.1	15	2	1943	1406	-
	16	189652	58.8	7	1	1742	-	-
	17	341809	77	13	2	1187	1657	-
	18	495737	55	6	1	1012	-	-

Type5 waveform#12

Trial Id	Radar Type	Number of Bursts	Burst Period (s)	Waveform Length (us)				
12	Type 5	15	0.8	12				
	Burst ID	Burst Offset (us)	Pulse Width (us)	Chirp Width (MHz)	Number of Pulses per Burst	PRI-1 (us)	PRI-2 (us)	PRI-3 (us)
	0	22911	58.1	7	1	1929	-	-
	1	216473	52.1	5	1	1910	-	-
	2	410004	59.9	8	1	1971	-	-
	3	603671	60.2	8	1	1812	-	-
	4	794160	95.9	19	3	1399	1906	1608
	5	192251	79.9	14	2	1626	1859	-
	6	385590	78.5	14	2	1238	1917	-
	7	579862	53.8	6	1	1763	-	-
	8	773423	64.7	9	1	1800	-	-
	9	168898	61.4	8	1	1390	-	-
	10	361606	83.2	15	2	1692	1858	-
	11	553866	84.7	16	3	1533	1677	1638
	12	747241	88.7	17	3	1703	1528	1058
	13	144710	78.3	14	2	1258	1951	-
	14	337856	69.3	11	2	1731	1717	-

Type5 waveform#13

Trial Id	Radar Type	Number of Bursts	Burst Period (s)	Waveform Length (us)				
13	Type 5	12	1	12				
	Burst ID	Burst Offset (us)	Pulse Width (us)	Chirp Width (MHz)	Number of Pulses per Burst	PRI-1 (us)	PRI-2 (us)	PRI-3 (us)
	0	664275	75.3	13	2	1994	1612	-
	1	907886	56.3	7	1	1456	-	-
	2	151316	67.7	10	2	1617	1185	-
	3	393746	55.6	6	1	1337	-	-
	4	635093	75.2	13	2	1421	1267	-
	5	876993	76.3	13	2	1359	1305	-
	6	121278	85.7	16	3	1547	1362	1924
	7	362696	98.4	20	3	1873	1550	1249
	8	604342	86.4	16	3	1779	1439	1046
	9	846453	93.6	18	3	1059	1031	1452
	10	91871	63.3	9	1	1328	-	-
	11	333050	92.4	18	3	1412	1673	1322

Type5 waveform#14

Trial Id	Radar Type	Number of Bursts	Burst Period (s)	Waveform Length (us)				
14	Type 5	19	0.631579	12				
	Burst ID	Burst Offset (us)	Pulse Width (us)	Chirp Width (MHz)	Number of Pulses per Burst	PRI-1 (us)	PRI-2 (us)	PRI-3 (us)
	0	361323	93.3	18	3	1983	1912	1535
	1	515261	69.1	11	2	1102	1794	-
	2	39025	86.9	16	3	1044	1152	1148
	3	190900	84.9	16	3	1894	1948	1118
	4	343941	72.3	12	2	1094	1916	-
	5	497624	51.7	5	1	1447	-	-
	6	20319	58.3	7	1	1429	-	-
	7	172999	60.8	8	1	1979	-	-
	8	325872	57.1	7	1	1641	-	-
	9	475841	88.9	17	3	1886	1964	1489
	10	1489	72	12	2	1909	1297	-
	11	153647	90.9	18	3	1261	1566	1370
	12	307096	59.8	8	1	1552	-	-
	13	458804	70	11	2	1759	1291	-
	14	610798	67.2	10	2	1625	1881	-
	15	134759	91.2	18	3	1382	1832	1661
	16	288306	56.5	7	1	1483	-	-
	17	441296	51.2	5	1	1237	-	-
	18	592780	74.1	12	2	1471	1245	-

Type5 waveform#15

Trial Id	Radar Type	Number of Bursts	Burst Period (s)	Waveform Length (us)				
15	Type 5	14	0.857143	12				
	Burst ID	Burst Offset (us)	Pulse Width (us)	Chirp Width (MHz)	Number of Pulses per Burst	PRI-1 (us)	PRI-2 (us)	PRI-3 (us)
	0	158286	76.9	13	2	1110	1140	-
	1	366024	50.2	5	1	1316	-	-
	2	573452	62.9	9	1	1520	-	-
	3	780619	64.7	9	1	1902	-	-
	4	132455	83.8	15	3	1410	1097	1621
	5	340207	65.4	9	1	1944	-	-
	6	548208	53.2	6	1	1024	-	-
	7	755333	51.7	5	1	1603	-	-
	8	107117	78.7	14	2	1804	1168	-
	9	314500	72.4	12	2	1030	1343	-
	10	522447	53.8	6	1	1327	-	-
	11	728517	73.6	12	2	1524	1553	-
	12	81611	66.7	10	2	1722	1122	-
	13	288948	82.5	15	2	1404	1019	-

Type5 waveform#16

Trial Id	Radar Type	Number of Bursts	Burst Period (s)	Waveform Length (us)				
16	Type 5	20	0.6	12				
	Burst ID	Burst Offset (us)	Pulse Width (us)	Chirp Width (MHz)	Number of Pulses per Burst	PRI-1 (us)	PRI-2 (us)	PRI-3 (us)
	0	345766	87.6	17	3	1565	1055	1840
	1	490019	85.2	16	3	1735	1541	1408
	2	39073	84.8	16	3	1534	1889	1463
	3	183923	77.9	13	2	1749	1460	-
	4	328777	76.5	13	2	1518	1485	-
	5	474728	60.9	8	1	1540	-	-
	6	21394	83	15	2	1080	1010	-
	7	165992	80.4	14	2	1824	1752	-
	8	310973	67.5	10	2	1764	1181	-
	9	456884	62.1	8	1	1495	-	-
	10	3515	86.4	16	3	1773	1966	1263
	11	147928	84.3	15	3	1593	1188	1788
	12	293225	76.9	13	2	1226	1537	-
	13	436922	95.8	19	3	1192	1298	1844
	14	584015	55.2	6	1	1644	-	-
	15	130832	59	7	1	1402	-	-
	16	274684	94.5	19	3	1296	1700	1283
	17	418579	91.9	18	3	1970	1978	1165
	18	563464	85.2	16	3	1732	1551	1189
	19	112787	69.5	11	2	1038	1224	-

Type5 waveform#17

Trial Id	Radar Type	Number of Bursts	Burst Period (s)	Waveform Length (us)				
17	Type 5	12	1	12				
	Burst ID	Burst Offset (us)	Pulse Width (us)	Chirp Width (MHz)	Number of Pulses per Burst	PRI-1 (us)	PRI-2 (us)	PRI-3 (us)
	0	429224	86.4	16	3	1259	1918	1455
	1	670241	92.2	18	3	1598	1719	1895
	2	912880	80.4	14	2	1816	1899	-
	3	158603	54.3	6	1	1335	-	-
	4	400824	53.1	5	1	1303	-	-
	5	641915	69.4	11	2	1503	1546	-
	6	883823	69.1	11	2	1279	1639	-
	7	128373	100	20	3	1375	1438	1595
	8	370379	79.6	14	2	1239	1705	-
	9	611194	88.4	17	3	1374	1579	1623
	10	855665	53.3	6	1	1016	-	-
	11	98897	65.3	9	1	1709	-	-

Type5 waveform#18

Trial Id	Radar Type	Number of Bursts	Burst Period (s)	Waveform Length (us)				
18	Type 5	14	0.857143	12				
	Burst ID	Burst Offset (us)	Pulse Width (us)	Chirp Width (MHz)	Number of Pulses per Burst	PRI-1 (us)	PRI-2 (us)	PRI-3 (us)
	0	292143	55.3	6	1	1920	-	-
	1	499633	58.3	7	1	1797	-	-
	2	706377	72.3	12	2	1610	1039	-
	3	58989	84.8	16	3	1131	1761	1721
	4	266161	82.5	15	2	1875	1431	-
	5	474469	63.3	9	1	1095	-	-
	6	680544	80	14	2	1119	1913	-
	7	33519	90.3	17	3	1660	1853	1123
	8	240319	91.1	18	3	1539	1783	1172
	9	447400	96.6	19	3	1525	1036	1385
	10	654516	82.7	15	2	1710	1990	-
	11	8083	50.7	5	1	1234	-	-
	12	215435	78.4	14	2	1047	1109	-
	13	421325	99.5	20	3	1299	1965	1869

Type5 waveform#19

Trial Id	Radar Type	Number of Bursts	Burst Period (s)	Waveform Length (us)				
19	Type 5	12	1	12				
	Burst ID	Burst Offset (us)	Pulse Width (us)	Chirp Width (MHz)	Number of Pulses per Burst	PRI-1 (us)	PRI-2 (us)	PRI-3 (us)
	0	733725	88.6	17	3	1501	1067	1927
	1	977882	57.4	7	1	1723	-	-
	2	221197	96.6	19	3	1086	1658	1324
	3	462915	69.7	11	2	1751	1945	-
	4	705071	77.9	13	2	1642	1317	-
	5	947923	62	8	1	1866	-	-
	6	191373	88.4	17	3	1997	1077	1366
	7	432561	97.3	20	3	1790	1896	1367
	8	674004	96.2	19	3	1391	1787	1672
	9	915842	95.4	19	3	1020	1892	1414
	10	162176	54.8	6	1	1084	-	-
	11	403553	80.4	14	2	1850	1436	-

Type5 waveform#20

Trial Id	Radar Type	Number of Bursts	Burst Period (s)	Waveform Length (us)				
20	Type 5	16	0.75	12				
	Burst ID	Burst Offset (us)	Pulse Width (us)	Chirp Width (MHz)	Number of Pulses per Burst	PRI-1 (us)	PRI-2 (us)	PRI-3 (us)
	0	483470	74.7	12	2	1619	1611	-
	1	666072	57.1	7	1	1560	-	-
	2	98810	91.9	18	3	1392	1475	1276
	3	279914	83.1	15	2	1809	1772	-
	4	462536	50.7	5	1	1003	-	-
	5	642324	79.2	14	2	1574	1600	-
	6	76831	58.7	7	1	1186	-	-
	7	257785	71	11	2	1521	1567	-
	8	438554	79	14	2	1777	1960	-
	9	620397	68.5	10	2	1284	1428	-
	10	54310	73.5	12	2	1904	1352	-
	11	235506	70.5	11	2	1864	1115	-
	12	417036	76.6	13	2	1045	1300	-
	13	597974	81.2	14	2	1160	1675	-
	14	32086	61.8	8	1	1277	-	-
	15	212751	94.9	19	3	1450	1206	1860

Type5 waveform#21

Trial Id	Radar Type	Number of Bursts	Burst Period (s)	Waveform Length (us)				
21	Type 5	12	1	12				
	Burst ID	Burst Offset (us)	Pulse Width (us)	Chirp Width (MHz)	Number of Pulses per Burst	PRI-1 (us)	PRI-2 (us)	PRI-3 (us)
	0	526149	78.5	14	2	1653	1698	-
	1	767135	89.8	17	3	1174	1962	1167
	2	12955	59.4	8	1	1982	-	-
	3	254612	79.6	14	2	1633	1890	-
	4	496588	76	13	2	1112	1811	-
	5	739728	53.6	6	1	1144	-	-
	6	980872	80.9	14	2	1220	1053	-
	7	225249	61.6	8	1	1724	-	-
	8	467279	53.4	6	1	1901	-	-
	9	709720	59.9	8	1	1379	-	-
	10	951847	60.4	8	1	1453	-	-
	11	194839	91.4	18	3	1768	1726	1227

Type5 waveform#22

Trial Id	Radar Type	Number of Bursts	Burst Period (s)	Waveform Length (us)				
22	Type 5	20	0.6	12				
	Burst ID	Burst Offset (us)	Pulse Width (us)	Chirp Width (MHz)	Number of Pulses per Burst	PRI-1 (us)	PRI-2 (us)	PRI-3 (us)
	0	261858	77	13	2	1191	1363	-
	1	407646	58.1	7	1	1248	-	-
	2	552319	62.1	8	1	1836	-	-
	3	99107	76.9	13	2	1334	1236	-
	4	243514	80	14	2	1914	1852	-
	5	389464	52	5	1	1701	-	-
	6	531093	88.6	17	3	1693	1995	1905
	7	81159	72.9	12	2	1922	1387	-
	8	225245	98.5	20	3	1839	1746	1389
	9	371906	57.9	7	1	1193	-	-
	10	514197	95.9	19	3	1659	1870	1066
	11	63561	53.5	6	1	1162	-	-
	12	207510	92	18	3	1745	1654	1458
	13	353638	57.3	7	1	1834	-	-
	14	497515	70.5	11	2	1684	1586	-
	15	45553	70	11	2	1042	1664	-
	16	189821	84	15	3	1765	1630	1176
	17	335330	76.1	13	2	1557	1057	-
	18	478825	93.2	18	3	1985	1018	1340
	19	27594	96.8	19	3	1760	1614	1817

Type5 waveform#23

Trial Id	Radar Type	Number of Bursts	Burst Period (s)	Waveform Length (us)				
23	Type 5	14	0.857143	12				
	Burst ID	Burst Offset (us)	Pulse Width (us)	Chirp Width (MHz)	Number of Pulses per Burst	PRI-1 (us)	PRI-2 (us)	PRI-3 (us)
	0	247117	50.1	5	1	1841	-	-
	1	453362	93.5	18	3	1590	1081	1413
	2	660875	68.8	11	2	1707	1577	-
	3	14140	56.3	7	1	1056	-	-
	4	220734	86	16	3	1953	1108	1987
	5	428367	75.2	13	2	1572	1536	-
	6	636681	54.4	6	1	1517	-	-
	7	843157	71.1	11	2	1329	1243	-
	8	195585	76.2	13	2	1940	1770	-
	9	403231	80.2	14	2	1098	1209	-
	10	610202	79.7	14	2	1588	1214	-
	11	815229	90.9	18	3	1615	1862	1601
	12	170267	68.7	10	2	1377	1441	-
	13	377306	67.4	10	2	1872	1313	-

Type5 waveform#24

Trial Id	Radar Type	Number of Bursts	Burst Period (s)	Waveform Length (us)				
24	Type 5	13	0.923077	12				
	Burst ID	Burst Offset (us)	Pulse Width (us)	Chirp Width (MHz)	Number of Pulses per Burst	PRI-1 (us)	PRI-2 (us)	PRI-3 (us)
	0	628071	94	19	3	1643	1748	1941
	1	853391	70.8	11	2	1177	1201	-
	2	156223	56.3	7	1	1006	-	-
	3	378734	96.7	19	3	1230	1163	1332
	4	601331	90.6	17	3	1217	1582	1498
	5	825462	74.5	12	2	1569	1281	-
	6	128265	92.6	18	3	1065	1669	1222
	7	351161	89	17	3	1493	1135	1380
	8	573425	96.5	19	3	1607	1822	1602
	9	798431	70.5	11	2	1141	1178	-
	10	100737	94	19	3	1009	1629	1956
	11	324661	55.8	6	1	1290	-	-
	12	546278	87.7	17	3	1435	1963	1164

Type5 waveform#25

Trial Id	Radar Type	Number of Bursts	Burst Period (s)	Waveform Length (us)				
25	Type 5	8	1.5	12				
	Burst ID	Burst Offset (us)	Pulse Width (us)	Chirp Width (MHz)	Number of Pulses per Burst	PRI-1 (us)	PRI-2 (us)	PRI-3 (us)
	0	1253842	68.6	10	2	1306	1161	-
	1	119486	83.1	15	2	1420	1315	-
	2	482958	60.9	8	1	1687	-	-
	3	845641	77.7	13	2	1776	1158	-
	4	1208428	77.4	13	2	1793	1510	-
	5	74748	66.8	10	2	1576	1323	-
	6	438300	63.7	9	1	1333	-	-
	7	800152	91.2	18	3	1409	1681	1275

Type5 waveform#26

Trial Id	Radar Type	Number of Bursts	Burst Period (s)	Waveform Length (us)				
26	Type 5	17	0.705882	12				
	Burst ID	Burst Offset (us)	Pulse Width (us)	Chirp Width (MHz)	Number of Pulses per Burst	PRI-1 (us)	PRI-2 (us)	PRI-3 (us)
	0	545865	83.6	15	3	1632	1195	1000
	1	14067	89.4	17	3	1173	1627	1656
	2	184953	55.8	6	1	1532	-	-
	3	353759	90.9	18	3	1981	1554	1998
	4	526388	54.7	6	1	1825	-	-
	5	694806	97.7	20	3	1734	1202	1250
	6	163568	67.5	10	2	1571	1434	-
	7	333410	96.7	19	3	1589	1469	1268
	8	504006	68.3	10	2	1750	1954	-
	9	675297	78.3	14	2	1591	1082	-
	10	142890	55	6	1	1427	-	-
	11	312479	84.9	16	3	1129	1936	1199
	12	482953	74.6	12	2	1959	1856	-
	13	655022	63.3	9	1	1885	-	-
	14	121457	99.8	20	3	1035	1515	1120
	15	292606	63.6	9	1	1647	-	-
	16	461322	87.3	16	3	1931	1051	1831

Type5 waveform#27

Trial Id	Radar Type	Number of Bursts	Burst Period (s)	Waveform Length (us)				
27	Type 5	19	0.631579	12				
	Burst ID	Burst Offset (us)	Pulse Width (us)	Chirp Width (MHz)	Number of Pulses per Burst	PRI-1 (us)	PRI-2 (us)	PRI-3 (us)
	0	565136	85.6	16	3	1946	1078	1015
	1	89970	68.6	10	2	1029	1780	-
	2	243121	54.2	6	1	1111	-	-
	3	396034	61.2	8	1	1104	-	-
	4	546225	97.1	20	3	1157	1969	1100
	5	70998	98.3	20	3	1142	1699	1622
	6	224093	62.4	8	1	1655	-	-
	7	376127	80.2	14	2	1126	1769	-
	8	527806	87.5	17	3	1216	1448	1179
	9	52247	85.8	16	3	1847	1348	1472
	10	204582	88.1	17	3	1023	1124	1631
	11	357941	65.3	9	1	1848	-	-
	12	510977	52.5	5	1	1470	-	-
	13	33698	52.3	5	1	1312	-	-
	14	186023	74.1	12	2	1915	1200	-
	15	339327	54.9	6	1	1479	-	-
	16	491053	76.2	13	2	1376	1502	-
	17	14858	60.4	8	1	1758	-	-
	18	167387	81.5	15	2	1491	1103	-

Type5 waveform#28

Trial Id	Radar Type	Number of Bursts	Burst Period (s)	Waveform Length (us)				
28	Type 5	12	1	12				
	Burst ID	Burst Offset (us)	Pulse Width (us)	Chirp Width (MHz)	Number of Pulses per Burst	PRI-1 (us)	PRI-2 (us)	PRI-3 (us)
	0	507709	50.5	5	1	1857	-	-
	1	750249	55.7	6	1	1246	-	-
	2	989003	85.8	16	3	1774	1002	1967
	3	235634	76.9	13	2	1125	1474	-
	4	477675	75.1	13	2	1254	1052	-
	5	718312	92.3	18	3	1180	1486	1492
	6	960895	78.1	14	2	1301	1757	-
	7	205370	92.2	18	3	1898	1252	1713
	8	446940	89	17	3	1260	1706	1411
	9	689225	70.9	11	2	1578	1620	-
	10	932305	63.1	9	1	1782	-	-
	11	176231	55.3	6	1	1522	-	-

Type5 waveform#29

Trial Id	Radar Type	Number of Bursts	Burst Period (s)	Waveform Length (us)				
29	Type 5	18	0.666667	12				
	Burst ID	Burst Offset (us)	Pulse Width (us)	Chirp Width (MHz)	Number of Pulses per Burst	PRI-1 (us)	PRI-2 (us)	PRI-3 (us)
	0	277485	83.4	15	3	1454	1205	1801
	1	437880	97.3	20	3	1319	1826	1635
	2	598445	90.4	17	3	1079	1986	1674
	3	97088	91.8	18	3	1563	1151	1802
	4	257251	98.2	20	3	1876	1977	1766
	5	419893	59.5	8	1	1952	-	-
	6	580724	80	14	2	1253	1137	-
	7	77366	86.5	16	3	1054	1128	1828
	8	238032	91.1	18	3	1105	1599	1442
	9	398605	93.5	18	3	1867	1373	1087
	10	562025	60.7	8	1	1033	-	-
	11	57684	67.2	10	2	1288	1405	-
	12	219083	61.8	8	1	1585	-	-
	13	379234	79.4	14	2	1933	1667	-
	14	540896	81.4	15	2	1096	1464	-
	15	37916	65.7	10	1	1496	-	-
	16	198794	76	13	2	1733	1255	-
	17	359754	81	14	2	1326	1668	-

Trial Id	Radar Type	Pulse Width (us)	PRI (us)	Pulses per Hop	Hopping Rate (KHz)	Hopping Sequences Length (ms)	Visible Frequency Number
0	Type 6	1	333.3	9	0.3333	300	32
1	Type 6	1	333.3	9	0.3333	300	27
2	Type 6	1	333.3	9	0.3333	300	25
3	Type 6	1	333.3	9	0.3333	300	33
4	Type 6	1	333.3	9	0.3333	300	37
5	Type 6	1	333.3	9	0.3333	300	30
6	Type 6	1	333.3	9	0.3333	300	33
7	Type 6	1	333.3	9	0.3333	300	27
8	Type 6	1	333.3	9	0.3333	300	33
9	Type 6	1	333.3	9	0.3333	300	30
10	Type 6	1	333.3	9	0.3333	300	37
11	Type 6	1	333.3	9	0.3333	300	36
12	Type 6	1	333.3	9	0.3333	300	38
13	Type 6	1	333.3	9	0.3333	300	35
14	Type 6	1	333.3	9	0.3333	300	28
15	Type 6	1	333.3	9	0.3333	300	37
16	Type 6	1	333.3	9	0.3333	300	35
17	Type 6	1	333.3	9	0.3333	300	37
18	Type 6	1	333.3	9	0.3333	300	27
19	Type 6	1	333.3	9	0.3333	300	34
20	Type 6	1	333.3	9	0.3333	300	35
21	Type 6	1	333.3	9	0.3333	300	37
22	Type 6	1	333.3	9	0.3333	300	41
23	Type 6	1	333.3	9	0.3333	300	36
24	Type 6	1	333.3	9	0.3333	300	29
25	Type 6	1	333.3	9	0.3333	300	32
26	Type 6	1	333.3	9	0.3333	300	30
27	Type 6	1	333.3	9	0.3333	300	31
28	Type 6	1	333.3	9	0.3333	300	31
29	Type 6	1	333.3	9	0.3333	300	40

9 EUT Photos

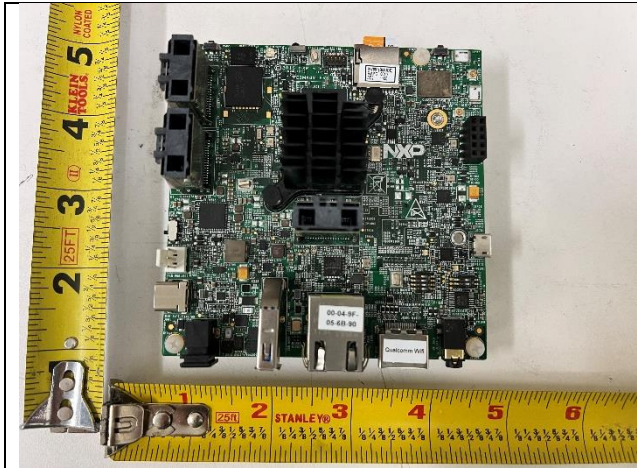

i.MX8 Board (Support testing board) – Front View



i.MX8 Board (Support testing board) –Rear View



EUT – Front View

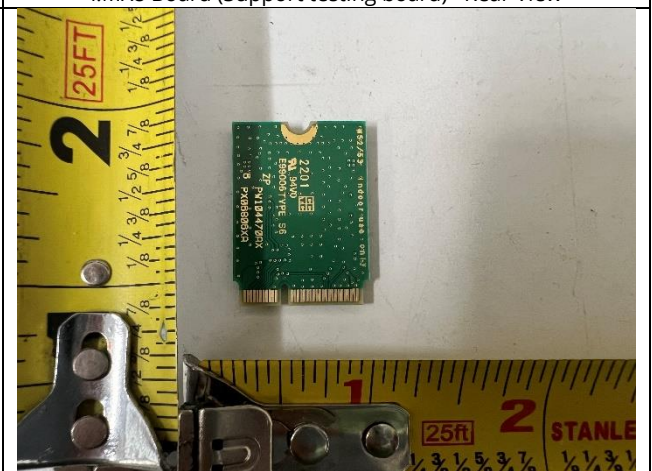

EUT – Rear View



Antenna Port

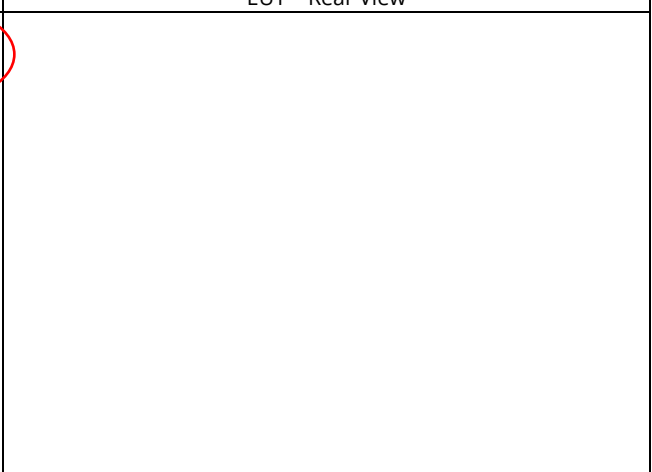

10 Test Instrument List

Equipment	Manufacturer	Model	Instrument Number	Cal. Date	Cal. Due
Semi-Anechoic Chamber	ETS-Lindgren	10M	VL001	10/18/2022	10/18/2023
Spectrum Analyzer	Keysight	N9020A	MY50110074	06/09/2022	06/09/2023
Agilent Signal Generator	MXG N5182A	N5182A	US47080548	06/07/2022	06/07/2023
Horn Antenna (1-18GHz)	Electro-Metrics	EM-6961	6292	07/21/2022	07/21/2023
Horn Antenna (1-18GHz)	FT-RF	HA-07M18G-NF	180010HA	05/14/2022	05/14/2023
Temp / Humidity / Pressure Meter	PCE Instruments	PCE-THB 40	R062028	06/07/2022	06/07/2023
RF Attenuator	Pasternack	PE7005-3	VL061	07/16/2022	07/16/2023
RE test cable (1-18GHz)	PhaseTrack	II-240	RE-18GHz-01	07/16/2022	07/16/2023
RE test cable (>18GHz)	Sucoflex	104	344903/4	07/16/2022	07/16/2023
Power Splitter/Combiner	Mini-Circuits	ZFSC-2-9G+	VL052	N/A	N/A
Power Splitter/Combiner	Mini-Circuits	ZFSC-2-9G+	VL053	N/A	N/A
Power Splitter/Combiner	Mini-Circuits	ZFSC-2-9G+	VL054	N/A	N/A
Power Splitter/Combiner	Mini-Circuits	ZFSC-2-9G+	VL055	N/A	N/A

---END---