

**ELECTROMAGNETIC EMISSIONS  
COMPLIANCE REPORT**

**Applicant:** silex technology, Inc.  
2-3-1 Hikaridai, Seika-cho, Soraku-gun, Kyoto 619-0237,  
Japan

**Manufacturer:** silex technology, Inc.  
2-3-1 Hikaridai, Seika-cho, Soraku-gun, Kyoto 619-0237,  
Japan

**Product Name:** AP-800AX

**Brand Name:** Silex Technology

**Model No.:** AP-800AX

**Model Difference:** N/A

**Report Number:** TERF2303000752ER

**FCC ID** N6C-AP800AX

**IC:** 4908A-AP800AX

**Date of EUT Received:** March 29, 2023

**Date of Test:** March 29, 2023~May 11, 2023

**Issue Date:** July 20, 2023

Approved By \_\_\_\_\_

**Blue Yang**

**We hereby certify that:**

The above equipment was tested by SGS Taiwan Ltd. Central RF Lab The test data, data evaluation, test procedures, and equipment configurations shown in this report were made in accordance with the procedures given in ANSI C63.10:2013 and the energy emitted by the sample EUT comply with FCC rule part §15.247, ISCED RSS-247.

The results of this report relate only to the sample identified in this report.

Unless otherwise stated the results shown in this test report refer only to the sample(s) tested and such sample(s) are retained for 90 days only.  
除非另有說明，此報告結果僅對測試之樣品負責，同時此樣品僅保留90天。本報告未經本公司書面許可，不可部份複製。

This document is issued by the Company subject to its General Conditions of Service printed overleaf, available on request or accessible at <http://www.sgs.com.tw/Terms-and-Conditions>, and for electronic format documents, subject to Terms and Conditions for Electronic Documents at <http://www.sgs.com.tw/Terms-and-Conditions>. Attention is drawn to the limitation of liability, indemnification and jurisdiction issues defined therein. Any holder of this document is advised that information contained hereon reflects the Company's findings at the time of its intervention only and within the limits of Client's instructions, if any. The Company's sole responsibility is to its Client and this document does not exonerate parties to a transaction from exercising all their rights and obligations under the transaction documents. This document cannot be reproduced except in full, without prior written approval of the Company. Any unauthorized alteration, forgery or falsification of the content or appearance of this document is unlawful and offenders may be prosecuted to the fullest extent of the law.

## Revision History

| Report Number    | Revision | Description | Issue Date    | Revised By | Remark |
|------------------|----------|-------------|---------------|------------|--------|
| TERF2303000752ER | 00       | Original.   | July 20, 2023 | Susan Lin  |        |
|                  |          |             |               |            |        |
|                  |          |             |               |            |        |
|                  |          |             |               |            |        |
|                  |          |             |               |            |        |
|                  |          |             |               |            |        |
|                  |          |             |               |            |        |

**Note:**

- The remark "\*" indicates modification of the report upon requests from certification body.

Unless otherwise stated the results shown in this test report refer only to the sample(s) tested and such sample(s) are retained for 90 days only.  
 除非另有說明，此報告結果僅對測試之樣品負責，同時此樣品僅保留90天。本報告未經本公司書面許可，不可部份複製。

This document is issued by the Company subject to its General Conditions of Service printed overleaf, available on request or accessible at <http://www.sgs.com.tw/Terms-and-Conditions> and for electronic format documents, subject to Terms and Conditions for Electronic Documents at <http://www.sgs.com.tw/Terms-and-Conditions>. Attention is drawn to the limitation of liability, indemnification and jurisdiction issues defined therein. Any holder of this document is advised that information contained hereon reflects the Company's findings at the time of its intervention only and within the limits of Client's instructions, if any. The Company's sole responsibility is to its Client and this document does not exonerate parties to a transaction from exercising all their rights and obligations under the transaction documents. This document cannot be reproduced except in full, without prior written approval of the Company. Any unauthorized alteration, forgery or falsification of the content or appearance of this document is unlawful and offenders may be prosecuted to the fullest extent of the law.

SGS Taiwan Ltd.

No.134,Wu Kung Road, New Taipei Industrial Park, Wuku District, New Taipei City, Taiwan/新北市五股區新北產業園區五工路 134 號

台灣檢驗科技股份有限公司

t (886-2) 2299-3279

f (886-2) 2298-0488

[www.sgs.com.tw](http://www.sgs.com.tw)

Member of SGS Group

## Table of Contents

|           |                                                                     |            |
|-----------|---------------------------------------------------------------------|------------|
| <b>1</b>  | <b>GENERAL INFORMATION.....</b>                                     | <b>4</b>   |
| <b>2</b>  | <b>SYSTEM TEST CONFIGURATION.....</b>                               | <b>7</b>   |
| <b>3</b>  | <b>SUMMARY OF TEST RESULTS .....</b>                                | <b>10</b>  |
| <b>4</b>  | <b>DESCRIPTION OF TEST MODES .....</b>                              | <b>11</b>  |
| <b>5</b>  | <b>MEASUREMENT UNCERTAINTY .....</b>                                | <b>15</b>  |
| <b>6</b>  | <b>MEASUREMENT EQUIPMENT USED .....</b>                             | <b>16</b>  |
| <b>7</b>  | <b>CONDUCTED EMISSION TEST .....</b>                                | <b>18</b>  |
| <b>8</b>  | <b>PEAK OUTPUT POWER MEASUREMENT .....</b>                          | <b>22</b>  |
| <b>9</b>  | <b>EMISSION BANDWIDTH MEASUREMENT .....</b>                         | <b>40</b>  |
| <b>10</b> | <b>CONDUCTED BAND EDGES AND SPURIOUS EMISSION MEASUREMENT .....</b> | <b>57</b>  |
| <b>11</b> | <b>RADIATED BANEDGE AND SPURIOUS EMISSION MEASUREMENT .....</b>     | <b>78</b>  |
| <b>12</b> | <b>POWER SPECTRAL DENSITY .....</b>                                 | <b>176</b> |
| <b>13</b> | <b>ANTENNA REQUIREMENT.....</b>                                     | <b>186</b> |

Unless otherwise stated the results shown in this test report refer only to the sample(s) tested and such sample(s) are retained for 90 days only.

除非另有說明，此報告結果僅對測試之樣品負責，同時此樣品僅保留90天。本報告未經本公司書面許可，不可部份複製。

This document is issued by the Company subject to its General Conditions of Service printed overleaf, available on request or accessible at <http://www.sgs.com.tw/Terms-and-Conditions> and for electronic format documents, subject to Terms and Conditions for Electronic Documents at <http://www.sgs.com.tw/Terms-and-Conditions>. Attention is drawn to the limitation of liability, indemnification and jurisdiction issues defined therein. Any holder of this document is advised that information contained hereon reflects the Company's findings at the time of its intervention only and within the limits of Client's instructions, if any. The Company's sole responsibility is to its Client and this document does not exonerate parties to a transaction from exercising all their rights and obligations under the transaction documents. This document cannot be reproduced except in full, without prior written approval of the Company. Any unauthorized alteration, forgery or falsification of the content or appearance of this document is unlawful and offenders may be prosecuted to the fullest extent of the law.

# 1 GENERAL INFORMATION

## 1.1 Product Description

|                               |                  |
|-------------------------------|------------------|
| Product Name:                 | AP-800AX         |
| Brand Name:                   | Silex Technology |
| Model No.:                    | AP-800AX         |
| Model Difference:             | N/A              |
| Hardware Version:             | N/A              |
| Firmware Version:             | N/A              |
| EUT Series No.:               | 000001814        |
| Power Supply:                 | 12Vdc            |
| Test Software (Name/Version): | QRCT v4.0.211.0  |

## 1.2 RF Specification

### WLAN 2.4GHz

| Wi-Fi            | Frequency Range | Channels                                              | Rated Power (dBm) |       | Modulation Technology |
|------------------|-----------------|-------------------------------------------------------|-------------------|-------|-----------------------|
|                  |                 |                                                       | Peak              | Avg.  |                       |
| 802.11b          | 2412~2462       | 11                                                    | 25.74             | 22.97 | DSSS                  |
| 802.11g          | 2412~2462       | 11                                                    | 28.74             | 22.93 | OFDM                  |
| 802.11n20        | 2412~2462       | 11                                                    | 29.34             | 22.98 | OFDM                  |
| 802.11n40        | 2422~2452       | 7                                                     | 29.05             | 22.92 | OFDM                  |
| 802.11ax20       | 2412~2462       | 11                                                    | 29.86             | 22.99 | OFDMA                 |
| 802.11ax40       | 2422~2452       | 7                                                     | 29.56             | 22.46 | OFDMA                 |
| Modulation type: |                 | CCK, DQPSK, DBPSK for DSSS                            |                   |       |                       |
|                  |                 | 64QAM, 16QAM, QPSK, BPSK for OFDM                     |                   |       |                       |
|                  |                 | 1024 QAM, 256 QAM, 64QAM, 16QAM, QPSK, BPSK for OFDMA |                   |       |                       |
| Data Rate:       |                 | 802.11 b: 1/2/5.5/11 Mbps                             |                   |       |                       |
|                  |                 | 802.11 g: 6/9/12/18/24/36/48/54 Mbps                  |                   |       |                       |
|                  |                 | 802.11 n_20MHz: up to 144.4Mbps                       |                   |       |                       |
|                  |                 | 802.11 n_40MHz: up to 300Mbps                         |                   |       |                       |
|                  |                 | 802.11 ax_20MHz: up to 286.8Mbps                      |                   |       |                       |
|                  |                 | 802.11 ax_40MHz: up to 573.6Mbps                      |                   |       |                       |

Unless otherwise stated the results shown in this test report refer only to the sample(s) tested and such sample(s) are retained for 90 days only.

除非另有說明，此報告結果僅對測試之樣品負責，同時此樣品僅保留90天。本報告未經本公司書面許可，不可部份複製。

This document is issued by the Company subject to its General Conditions of Service printed overleaf, available on request or accessible at <http://www.sgs.com.tw/Terms-and-Conditions> and for electronic format documents, subject to Terms and Conditions for Electronic Documents at <http://www.sgs.com.tw/Terms-and-Conditions>. Attention is drawn to the limitation of liability, indemnification and jurisdiction issues defined therein. Any holder of this document is advised that information contained herein reflects the Company's findings at the time of its intervention only and within the limits of Client's instructions, if any. The Company's sole responsibility is to its Client and this document does not exonerate parties to a transaction from exercising all their rights and obligations under the transaction documents. This document cannot be reproduced except in full, without prior written approval of the Company. Any unauthorized alteration, forgery or falsification of the content or appearance of this document is unlawful and offenders may be prosecuted to the fullest extent of the law.

WLAN 2.4GHz for IC

| Wi-Fi            | Frequency Range | Channels                                               | Rated Power (dBm) |       | Rated Power in dBm (EIRP) | Modulation Technology |
|------------------|-----------------|--------------------------------------------------------|-------------------|-------|---------------------------|-----------------------|
|                  |                 |                                                        | Peak              | Avg.  |                           |                       |
| 802.11b          | 2412~2462       | 11                                                     | 25.74             | 22.97 | 27.18                     | DSSS                  |
| 802.11g          | 2412~2462       | 11                                                     | 28.74             | 22.93 | 27.14                     | OFDM                  |
| 802.11n20        | 2412~2462       | 11                                                     | 29.34             | 22.98 | 27.19                     | OFDM                  |
| 802.11n40        | 2422~2452       | 7                                                      | 29.05             | 22.92 | 27.13                     | OFDM                  |
| 802.11ax20       | 2412~2462       | 11                                                     | 29.86             | 22.99 | 27.20                     | OFDMA                 |
| 802.11ax40       | 2422~2452       | 7                                                      | 29.56             | 22.46 | 26.67                     | OFDMA                 |
| Modulation type: |                 | CCK, DQPSK, DBPSK for DSSS                             |                   |       |                           |                       |
|                  |                 | 64QAM, 16QAM, QPSK, BPSK for OFDM                      |                   |       |                           |                       |
|                  |                 | 1024 QAM, 256 QAM , 64QAM, 16QAM, QPSK, BPSK for OFDMA |                   |       |                           |                       |
| Data Rate:       |                 | 802.11 b: 1/2/5.5/11 Mbps                              |                   |       |                           |                       |
|                  |                 | 802.11 g: 6/9/12/18/24/36/48/54 Mbps                   |                   |       |                           |                       |
|                  |                 | 802.11 n_20MHz:up to 144.4Mbps                         |                   |       |                           |                       |
|                  |                 | 802.11 n_40MHz:up to 300Mbps                           |                   |       |                           |                       |
|                  |                 | 802.11 ax_20MHz:up to 286.8Mbps                        |                   |       |                           |                       |
|                  |                 | 802.11 ax_40MHz:up to 573.6Mbps                        |                   |       |                           |                       |

### 1.3 Antenna Designation

| Antenna Type | Ch0/Ch1 | Antenna Part No. | Freq. (MHz) | Peak Antenna Gain (dBi) | Directional Gain (dBi) |
|--------------|---------|------------------|-------------|-------------------------|------------------------|
| Dipole       | Ch0     | ANTDP-039A0      | 2412~2462   | 1.2                     | 4.21                   |
|              | Ch1     |                  |             | 1.2                     | 4.21                   |

**Note:**

1. Pre-scanned was done on the above antennas, measurements were demonstrated by using the antenna with the highest gain as the worst case scenarios.
2. Antenna information is provided by the applicant.

Unless otherwise stated the results shown in this test report refer only to the sample(s) tested and such sample(s) are retained for 90 days only.

除非另有說明，此報告結果僅對測試之樣品負責，同時此樣品僅保留90天。本報告未經本公司書面許可，不可部份複製。  
 This document is issued by the Company subject to its General Conditions of Service printed overleaf, available on request or accessible at <http://www.sgs.com.tw/Terms-and-Conditions> and for electronic format documents, subject to Terms and Conditions for Electronic Documents at <http://www.sgs.com.tw/Terms-and-Conditions>. Attention is drawn to the limitation of liability, indemnification and jurisdiction issues defined therein. Any holder of this document is advised that information contained hereon reflects the Company's findings at the time of its intervention only and within the limits of Client's instructions, if any. The Company's sole responsibility is to its Client and this document does not exonerate parties to a transaction from exercising all their rights and obligations under the transaction documents. This document cannot be reproduced except in full, without prior written approval of the Company. Any unauthorized alteration, forgery or falsification of the content or appearance of this document is unlawful and offenders may be prosecuted to the fullest extent of the law.

### 1.4 Test Methodology of Applied Standards

FCC Part 15, Subpart C §15.247  
 FCC KDB 558074 D01 15.247 Meas Guidance v05r02  
 FCC KDB 662911 D01 Multiple Transmitter Output v02r01  
 RSS-247 issue 2 Feb. 2017  
 RSS-Gen,issue 5 April, 2018  
 ANSI C63.10:2013

### 1.5 Test Facility

| Laboratory                                            | Test Site Address                                                                         | Test Site Name | FCC Designation number | IC CAB identifier |
|-------------------------------------------------------|-------------------------------------------------------------------------------------------|----------------|------------------------|-------------------|
| SGS Taiwan Ltd.<br>Central RF Lab.<br>(TAF code 3702) | No.134, Wu Kung Road, New Taipei Industrial Park, Wuku District, New Taipei City, Taiwan. | SAC 1          | TW0027                 | TW3702            |
|                                                       |                                                                                           | SAC 2          |                        |                   |
|                                                       |                                                                                           | SAC 3          |                        |                   |
|                                                       |                                                                                           | Conduction 1   |                        |                   |
|                                                       |                                                                                           | Conducted 1    |                        |                   |
|                                                       |                                                                                           | Conducted 2    |                        |                   |
|                                                       |                                                                                           | Conducted 3    |                        |                   |
|                                                       |                                                                                           | Conducted 4    |                        |                   |
|                                                       |                                                                                           | Conducted 5    |                        |                   |
|                                                       | Conducted 6                                                                               |                |                        |                   |
|                                                       | No.2, Keji 1st Rd., Guishan District, Taoyuan City, Taiwan 333                            | Conduction C   | TW0028                 |                   |
|                                                       |                                                                                           | SAC C          |                        |                   |
|                                                       |                                                                                           | SAC D          |                        |                   |
|                                                       |                                                                                           | SAC G          |                        |                   |
|                                                       |                                                                                           | Conducted A    |                        |                   |
|                                                       |                                                                                           | Conducted B    |                        |                   |
|                                                       |                                                                                           | Conducted C    |                        |                   |
|                                                       |                                                                                           | Conducted D    |                        |                   |
|                                                       |                                                                                           | Conducted E    |                        |                   |
| Conducted F                                           |                                                                                           |                |                        |                   |
| Conducted G                                           |                                                                                           |                |                        |                   |

**Note:** Test site name is remarked on the equipment list in each section of this report as an indication where measurements occurred in specific test site and address.

### 1.6 Special Accessories

There are no special accessories used while test was conducted.

### 1.7 Equipment Modifications

There was no modification incorporated into the EUT.

Unless otherwise stated the results shown in this test report refer only to the sample(s) tested and such sample(s) are retained for 90 days only.  
 除非另有說明，此報告結果僅對測試之樣品負責，同時此樣品僅保留90天。本報告未經本公司書面許可，不可部份複製。

This document is issued by the Company subject to its General Conditions of Service printed overleaf, available on request or accessible at <http://www.sgs.com.tw/Terms-and-Conditions> and for electronic format documents, subject to Terms and Conditions for Electronic Documents at <http://www.sgs.com.tw/Terms-and-Conditions>. Attention is drawn to the limitation of liability, indemnification and jurisdiction issues defined therein. Any holder of this document is advised that information contained hereon reflects the Company's findings at the time of its intervention only and within the limits of Client's instructions, if any. The Company's sole responsibility is to its Client and this document does not exonerate parties to a transaction from exercising all their rights and obligations under the transaction documents. This document cannot be reproduced except in full, without prior written approval of the Company. Any unauthorized alteration, forgery or falsification of the content or appearance of this document is unlawful and offenders may be prosecuted to the fullest extent of the law.

## 2 SYSTEM TEST CONFIGURATION

### 2.1 EUT Configuration

The EUT configuration for testing is installed on RF field strength measurement to meet the Commissions requirement and operating in a manner which intends to maximize its emission characteristics in a continuous normal application.

### 2.2 EUT Exercise

An engineering test mode (software/firmware) that applicant provided was utilized to manipulate the EUT into transmit, selection of the test channel, and modulation scheme.

### 2.3 Test Procedure

#### 2.3.1 Conducted Emissions

The EUT is a placed on a table which is 0.8 m above ground plane. Conducted emissions from the EUT measured in the frequency range between 0.15 MHz and 30MHz. The CISPR Quasi-Peak and Average detector mode is employed. The two LISNs provide 50uH/50 ohm of coupling impedance for the measuring instrument. Both lines of the power mains connected to the EUT were checked for maximum conducted interference.

#### 2.3.2 Conducted Test (RF)

The active antenna port of the unlicensed wireless device is connected to the spectrum analyzer with attenuator to protect the instrumentation. If a second antenna port is available, it is tested at one operating frequency, with other port(s) appropriately terminated, to verify it has similar output characteristics as the fully tested port.

#### 2.3.3 Radiated Emissions

The EUT is a placed on a turn table. For emissions testing at or below 1 GHz, the table height shall be 0.8 m above the reference ground plane. For emission measurements above 1 GHz, the table height shall be 1.5 m. The turn table shall rotate 360 degrees to determine the position of maximum emission level. EUT is set 3m away from the receiving antenna which varied from 1m to 4m to find out the highest emission. And also, each emission was to be maximized by changing the polarization of receiving antenna both horizontal and vertical. In order to find out the max. emission, the relative positions of this transmitter (EUT) was rotated through three orthogonal axes and measurement procedures for electric field radiated emissions above 1 GHz the EUT measurement is to be made "while keeping the antenna in the 'cone of radiation' from that area and pointed at the area both in azimuth and elevation, with polarization oriented for maximum response." is still within the 3dB illumination BW of the measurement antenna.

Unless otherwise stated the results shown in this test report refer only to the sample(s) tested and such sample(s) are retained for 90 days only.  
除非另有說明，此報告結果僅對測試之樣品負責，同時此樣品僅保留90天。本報告未經本公司書面許可，不可部份複製。

This document is issued by the Company subject to its General Conditions of Service printed overleaf, available on request or accessible at <http://www.sgs.com.tw/Terms-and-Conditions> and for electronic format documents, subject to Terms and Conditions for Electronic Documents at <http://www.sgs.com.tw/Terms-and-Conditions>. Attention is drawn to the limitation of liability, indemnification and jurisdiction issues defined therein. Any holder of this document is advised that information contained hereon reflects the Company's findings at the time of its intervention only and within the limits of Client's instructions, if any. The Company's sole responsibility is to its Client and this document does not exonerate parties to a transaction from exercising all their rights and obligations under the transaction documents. This document cannot be reproduced except in full, without prior written approval of the Company. Any unauthorized alteration, forgery or falsification of the content or appearance of this document is unlawful and offenders may be prosecuted to the fullest extent of the law.

## 2.4 Measurement Results Explanation Example

### 2.4.1 Radiated Emission Test Sites For Measurements From 9 kHz To 30 MHz

Radiated emission below 30MHz is measured in a 9m\*6m\*6m semi-anechoic chamber, the measurements correspond to those obtained at an open-field test site.

There is a comparison data of both open-field test site and semi-Anechoic chamber, and the result came out very similar.

### 2.4.2 For all conducted test items:

The offset level is set in the spectrum analyzer to compensate the RF cable loss and attenuation factor between EUT conducted port and spectrum analyzer. With the offset compensation, the spectrum analyzer reading level is exactly EUT RF output level.

Unless otherwise stated the results shown in this test report refer only to the sample(s) tested and such sample(s) are retained for 90 days only.  
除非另有說明，此報告結果僅對測試之樣品負責，同時此樣品僅保留90天。本報告未經本公司書面許可，不可部份複製。

This document is issued by the Company subject to its General Conditions of Service printed overleaf, available on request or accessible at <http://www.sgs.com.tw/Terms-and-Conditions> and for electronic format documents, subject to Terms and Conditions for Electronic Documents at <http://www.sgs.com.tw/Terms-and-Conditions>. Attention is drawn to the limitation of liability, indemnification and jurisdiction issues defined therein. Any holder of this document is advised that information contained hereon reflects the Company's findings at the time of its intervention only and within the limits of Client's instructions, if any. The Company's sole responsibility is to its Client and this document does not exonerate parties to a transaction from exercising all their rights and obligations under the transaction documents. This document cannot be reproduced except in full, without prior written approval of the Company. Any unauthorized alteration, forgery or falsification of the content or appearance of this document is unlawful and offenders may be prosecuted to the fullest extent of the law.



## 2.5 Test Configuration

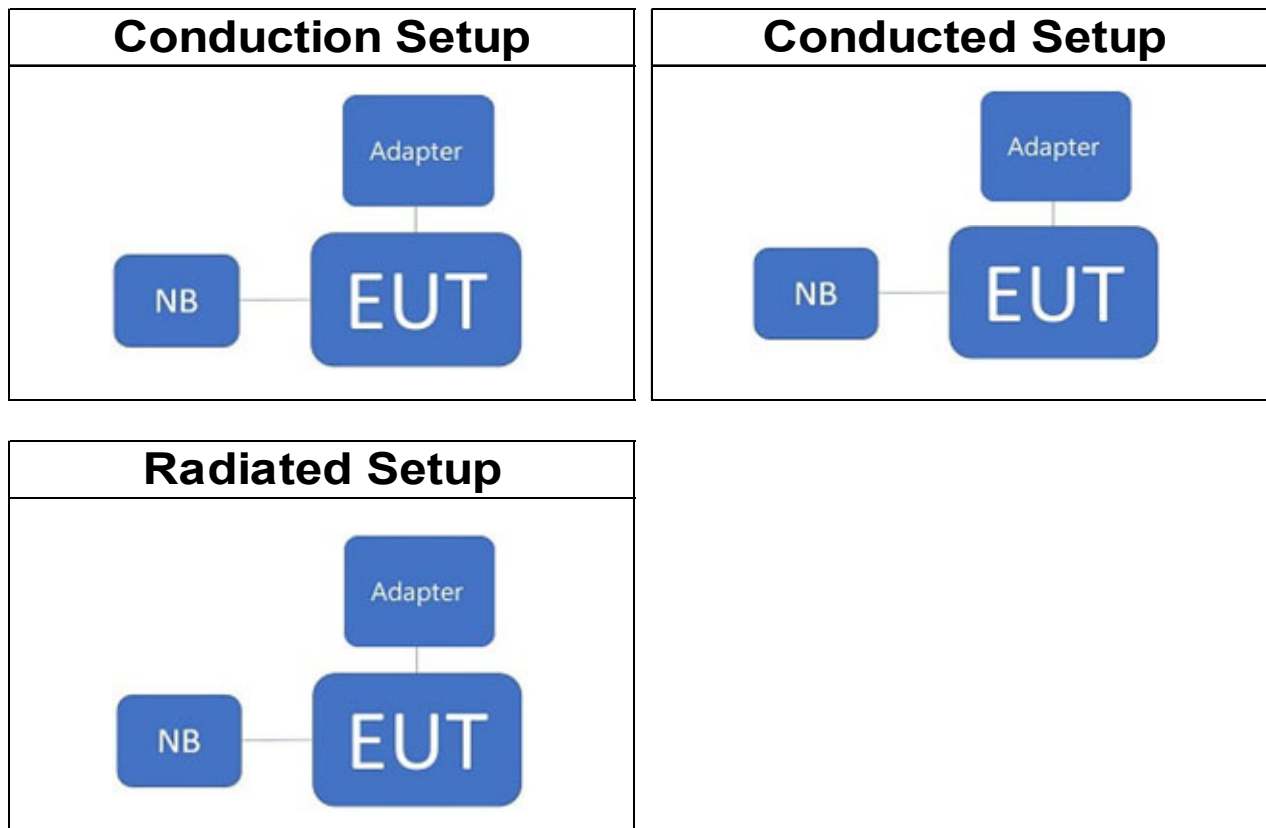

## 2.6 Control Unit(s)

| AC Power-Line Conducted Emission Test Site: Conduction 1 |         |               |               |           |          |
|----------------------------------------------------------|---------|---------------|---------------|-----------|----------|
| EQUIPMENT TYPE                                           | MFR     | MODEL NUMBER  | SERIAL NUMBER | LAST CAL. | CAL DUE. |
| Notebook                                                 | DELL    | Latitude 5590 | 3R9FST2       | N/A       | N/A      |
| Adapter                                                  | ADAPTER | ATS036T-A120  | N/A           | N/A       | N/A      |

| Conducted Emission Test Site: Conducted 2 |         |               |               |           |          |
|-------------------------------------------|---------|---------------|---------------|-----------|----------|
| EQUIPMENT TYPE                            | MFR     | MODEL NUMBER  | SERIAL NUMBER | LAST CAL. | CAL DUE. |
| Notebook                                  | DELL    | Latitude 5590 | 3R9FST2       | N/A       | N/A      |
| Adapter                                   | ADAPTER | ATS036T-A120  | N/A           | N/A       | N/A      |

| Radiated Emission Test Site: SAC 3 |         |               |               |           |          |
|------------------------------------|---------|---------------|---------------|-----------|----------|
| EQUIPMENT TYPE                     | MFR     | MODEL NUMBER  | SERIAL NUMBER | LAST CAL. | CAL DUE. |
| Notebook                           | DELL    | Latitude 5590 | 3R9FST2       | N/A       | N/A      |
| Adapter                            | ADAPTER | ATS036T-A120  | N/A           | N/A       | N/A      |

Unless otherwise stated the results shown in this test report refer only to the sample(s) tested and such sample(s) are retained for 90 days only.

除非另有說明，此報告結果僅對測試之樣品負責，同時此樣品僅保留90天。本報告未經本公司書面許可，不可部份複製。  
 This document is issued by the Company subject to its General Conditions of Service printed overleaf, available on request or accessible at <http://www.sgs.com.tw/Terms-and-Conditions> and for electronic format documents, subject to Terms and Conditions for Electronic Documents at <http://www.sgs.com.tw/Terms-and-Conditions>. Attention is drawn to the limitation of liability, indemnification and jurisdiction issues defined therein. Any holder of this document is advised that information contained hereon reflects the Company's findings at the time of its intervention only and within the limits of Client's instructions, if any. The Company's sole responsibility is to its Client and this document does not exonerate parties to a transaction from exercising all their rights and obligations under the transaction documents. This document cannot be reproduced except in full, without prior written approval of the Company. Any unauthorized alteration, forgery or falsification of the content or appearance of this document is unlawful and offenders may be prosecuted to the fullest extent of the law.

### 3 SUMMARY OF TEST RESULTS

| FCC Rules                        | ISED Rules                                                     | Description Of Test                                  | Result    |
|----------------------------------|----------------------------------------------------------------|------------------------------------------------------|-----------|
| §15.207(a)                       | RSS-Gen §8.8                                                   | AC Power Line Conducted Emission                     | Compliant |
| §15.247(b)<br>(3)                | RSS-247 §5.4 d                                                 | Peak Output Power                                    | Compliant |
| §15.247(a)(2)                    | RSS-247 §5.2 a<br>RSS-Gen §6.7                                 | Emission Bandwidth                                   | Compliant |
| §15.205<br>§15.209<br>§15.247(d) | RSS-247 §5.5<br>RSS-Gen §8.9<br>RSS-Gen §8.10<br>RSS-Gen §6.13 | Radiated & Conducted Band Edge and Spurious Emission | Compliant |
| §15.247(e)                       | RSS-247 §5.2 b                                                 | Power Spectral Density                               | Compliant |
| §15.203                          | N/A                                                            | Antenna Requirement                                  | Compliant |

Unless otherwise stated the results shown in this test report refer only to the sample(s) tested and such sample(s) are retained for 90 days only.

除非另有說明，此報告結果僅對測試之樣品負責，同時此樣品僅保留90天。本報告未經本公司書面許可，不可部份複製。

This document is issued by the Company subject to its General Conditions of Service printed overleaf, available on request or accessible at <http://www.sgs.com.tw/Terms-and-Conditions> and for electronic format documents, subject to Terms and Conditions for Electronic Documents at <http://www.sgs.com.tw/Terms-and-Conditions>. Attention is drawn to the limitation of liability, indemnification and jurisdiction issues defined therein. Any holder of this document is advised that information contained hereon reflects the Company's findings at the time of its intervention only and within the limits of Client's instructions, if any. The Company's sole responsibility is to its Client and this document does not exonerate parties to a transaction from exercising all their rights and obligations under the transaction documents. This document cannot be reproduced except in full, without prior written approval of the Company. Any unauthorized alteration, forgery or falsification of the content or appearance of this document is unlawful and offenders may be prosecuted to the fullest extent of the law.

## 4 DESCRIPTION OF TEST MODES

### 4.1 Operatin Frequencies

| Modulation of BW 20MHz |                 | Modulation of BW 40MHz |                 |
|------------------------|-----------------|------------------------|-----------------|
| CHANNEL                | FREQUENCY (MHz) | CHANNEL                | FREQUENCY (MHz) |
| 1                      | 2412            | 3                      | 2422            |
| 2                      | 2417            | 4                      | 2427            |
| 3                      | 2422            | 5                      | 2432            |
| 4                      | 2427            | 6                      | 2437            |
| 5                      | 2432            | 7                      | 2442            |
| 6                      | 2437            | 8                      | 2447            |
| 7                      | 2442            | 9                      | 2452            |
| 8                      | 2447            |                        |                 |
| 9                      | 2452            |                        |                 |
| 10                     | 2457            |                        |                 |
| 11                     | 2462            |                        |                 |

Unless otherwise stated the results shown in this test report refer only to the sample(s) tested and such sample(s) are retained for 90 days only.

除非另有說明，此報告結果僅對測試之樣品負責，同時此樣品僅保留90天。本報告未經本公司書面許可，不可部份複製。

This document is issued by the Company subject to its General Conditions of Service printed overleaf, available on request or accessible at <http://www.sgs.com.tw/Terms-and-Conditions> and for electronic format documents, subject to Terms and Conditions for Electronic Documents at <http://www.sgs.com.tw/Terms-and-Conditions>. Attention is drawn to the limitation of liability, indemnification and jurisdiction issues defined therein. Any holder of this document is advised that information contained hereon reflects the Company's findings at the time of its intervention only and within the limits of Client's instructions, if any. The Company's sole responsibility is to its Client and this document does not exonerate parties to a transaction from exercising all their rights and obligations under the transaction documents. This document cannot be reproduced except in full, without prior written approval of the Company. Any unauthorized alteration, forgery or falsification of the content or appearance of this document is unlawful and offenders may be prosecuted to the fullest extent of the law.

SGS Taiwan Ltd. No.134,Wu Kung Road, New Taipei Industrial Park, Wuku District, New Taipei City, Taiwan/新北市五股區新北產業園區五工路 134 號

#### 4.2 The Worst Test Modes and Channel Details

1. The EUT has been tested under operating condition.
2. Test program used to control the EUT for staying in continuous transmitting and receiving mode is programmed.
3. Investigation has been done on all the possible configurations for searching the worst case.

The given UE is pre-scanned among below modes.

| Modulation |           | Transmission Chain |     |   |     |  |     |  | Single Transmission Spatial | Multi Transmission Spatial |     |   |     |
|------------|-----------|--------------------|-----|---|-----|--|-----|--|-----------------------------|----------------------------|-----|---|-----|
| v          | 802.11 b  | v                  | Ch0 | v | Ch1 |  | Ch2 |  | Ch3                         |                            | 1TX | v | 2TX |
| v          | 802.11 g  | v                  | Ch0 | v | Ch1 |  | Ch2 |  | Ch3                         |                            | 1TX | v | 2TX |
| v          | 802.11 n  | v                  | Ch0 | v | Ch1 |  | Ch2 |  | Ch3                         |                            | 1TX | v | 2TX |
| v          | 802.11 ax | v                  | Ch0 | v | Ch1 |  | Ch2 |  | Ch3                         |                            | 1TX | v | 2TX |

4. Therefore, below summary is the modes of test configuration that yield the highest reading and generate the highest emission chosen to carry out the relevantly mandatory test items.
5. Observations have been done for 802.11 ax available RU configurations below and found that the lowest, highest and Full RU results higher emissions. Only one RU can be enabled at any given time.

Unless otherwise stated the results shown in this test report refer only to the sample(s) tested and such sample(s) are retained for 90 days only.  
 除非另有說明，此報告結果僅對測試之樣品負責，同時此樣品僅保留90天。本報告未經本公司書面許可，不可部份複製。

This document is issued by the Company subject to its General Conditions of Service printed overleaf, available on request or accessible at <http://www.sgs.com.tw/Terms-and-Conditions> and for electronic format documents, subject to Terms and Conditions for Electronic Documents at <http://www.sgs.com.tw/Terms-and-Conditions>. Attention is drawn to the limitation of liability, indemnification and jurisdiction issues defined therein. Any holder of this document is advised that information contained hereon reflects the Company's findings at the time of its intervention only and within the limits of Client's instructions, if any. The Company's sole responsibility is to its Client and this document does not exonerate parties to a transaction from exercising all their rights and obligations under the transaction documents. This document cannot be reproduced except in full, without prior written approval of the Company. Any unauthorized alteration, forgery or falsification of the content or appearance of this document is unlawful and offenders may be prosecuted to the fullest extent of the law.

| 802.11ax                      | 20MHz      |                  |             |                    | 802.11ax                      | 40MHz      |              |             |                    |
|-------------------------------|------------|------------------|-------------|--------------------|-------------------------------|------------|--------------|-------------|--------------------|
| RU type                       | 26-tone RU |                  | 52-tone RU  |                    | RU type                       | 26-tone RU |              | 52-tone RU  |                    |
| RU index and subcarrier range | RU0        | [-121: -96]      | RU37        | [-121: -70]        | RU index and subcarrier range | RU0        | [-243: -218] | RU37        | [-243: -192]       |
|                               | RU1        | [-95: -70]       | RU38        | [-68: -17]         |                               | RU1        | [-217: -192] | RU38        | [-189: -138]       |
|                               | RU2        | [-68: -43]       | RU39        | [17: 68]           |                               | RU2        | [-189: -164] | RU39        | [-109: -58]        |
|                               | RU3        | [-42: -17]       | RU40        | [70: 121]          |                               | RU3        | [-163: -138] | RU40        | [-55: -4]          |
|                               | RU4        | [-16: -4, 4: 16] | RU41        | N/A                |                               | RU4        | [-136: -111] | RU41        | [4: 55]            |
|                               | RU5        | [17: 42]         | RU42        | N/A                |                               | RU5        | [-109: -84]  | RU42        | [58: 109]          |
|                               | RU6        | [43: 68]         | RU43        | N/A                |                               | RU6        | [-83: -58]   | RU43        | [138: 189]         |
|                               | RU7        | [70: 95]         | RU44        | N/A                |                               | RU7        | [-55: -30]   | RU44        | [192: 243]         |
|                               | RU8        | [96: 121]        | RU45        | N/A                |                               | RU8        | [-29: -4]    | RU45        | N/A                |
|                               | RU9        | N/A              | RU46        | N/A                |                               | RU9        | [4: 29]      | RU46        | N/A                |
|                               | RU10       | N/A              | RU47        | N/A                |                               | RU10       | [30: 55]     | RU47        | N/A                |
|                               | RU11       | N/A              | RU48        | N/A                |                               | RU11       | [58: 83]     | RU48        | N/A                |
|                               | RU12       | N/A              | RU49        | N/A                |                               | RU12       | [84: 109]    | RU49        | N/A                |
|                               | RU13       | N/A              | RU50        | N/A                |                               | RU13       | [111: 136]   | RU50        | N/A                |
|                               | RU14       | N/A              | RU51        | N/A                |                               | RU14       | [138: 163]   | RU51        | N/A                |
|                               | RU15       | N/A              | RU52        | N/A                |                               | RU15       | [164: 189]   | RU52        | N/A                |
|                               | RU16       | N/A              |             |                    |                               | RU16       | [192: 217]   |             |                    |
|                               | RU17       | N/A              | 106-tone RU |                    |                               | RU17       | [218: 243]   | 106-tone RU |                    |
|                               | RU18       | N/A              | RU53        | [-122: -17]        |                               | RU18       | N/A          | RU53        | [-243: -138]       |
|                               | RU19       | N/A              | RU54        | [17: 122]          |                               | RU19       | N/A          | RU54        | [-109: -4]         |
|                               | RU20       | N/A              | RU55        | N/A                |                               | RU20       | N/A          | RU55        | [4: 109]           |
|                               | RU21       | N/A              | RU56        | N/A                |                               | RU21       | N/A          | RU56        | [138: 243]         |
|                               | RU22       | N/A              | RU57        | N/A                |                               | RU22       | N/A          | RU57        | N/A                |
|                               | RU23       | N/A              | RU58        | N/A                |                               | RU23       | N/A          | RU58        | N/A                |
|                               | RU24       | N/A              | RU59        | N/A                |                               | RU24       | N/A          | RU59        | N/A                |
|                               | RU25       | N/A              | RU60        | N/A                |                               | RU25       | N/A          | RU60        | N/A                |
|                               | RU26       | N/A              |             |                    |                               | RU26       | N/A          |             |                    |
|                               | RU27       | N/A              | 242-tone RU |                    |                               | RU27       | N/A          | 242-tone RU |                    |
|                               | RU28       | N/A              | RU61        | [-122: -2, 2: 122] |                               | RU28       | N/A          | RU61        | [-244: -3]         |
|                               | RU29       | N/A              | RU62        | N/A                |                               | RU29       | N/A          | RU62        | [3: 244]           |
|                               | RU30       | N/A              | RU63        | N/A                |                               | RU30       | N/A          | RU63        | N/A                |
|                               | RU31       | N/A              | RU64        | N/A                |                               | RU31       | N/A          | RU64        | N/A                |
|                               | RU32       | N/A              |             |                    |                               | RU32       | N/A          |             |                    |
|                               | RU33       | N/A              |             |                    |                               | RU33       | N/A          | 484-tone RU |                    |
|                               | RU34       | N/A              |             |                    |                               | RU34       | N/A          | RU65        | [-244: -3, 3: 244] |
|                               | RU35       | N/A              |             |                    |                               | RU35       | N/A          | RU66        | N/A                |
| RU36                          | N/A        |                  |             | RU36               | N/A                           |            |              |             |                    |

Unless otherwise stated the results shown in this test report refer only to the sample(s) tested and such sample(s) are retained for 90 days only.

除非另有說明，此報告結果僅對測試之樣品負責，同時此樣品僅保留90天。本報告未經本公司書面許可，不可部份複製。

This document is issued by the Company subject to its General Conditions of Service printed overleaf, available on request or accessible at <http://www.sgs.com.tw/Terms-and-Conditions> and for electronic format documents, subject to Terms and Conditions for Electronic Documents at <http://www.sgs.com.tw/Terms-and-Conditions>. Attention is drawn to the limitation of liability, indemnification and jurisdiction issues defined therein. Any holder of this document is advised that information contained hereon reflects the Company's findings at the time of its intervention only and within the limits of Client's instructions, if any. The Company's sole responsibility is to its Client and this document does not exonerate parties to a transaction from exercising all their rights and obligations under the transaction documents. This document cannot be reproduced except in full, without prior written approval of the Company. Any unauthorized alteration, forgery or falsification of the content or appearance of this document is unlawful and offenders may be prosecuted to the fullest extent of the law.

| Conducted       |                   |                |            |                  |              |
|-----------------|-------------------|----------------|------------|------------------|--------------|
| MODE            | AVAILABLE CHANNEL | TESTED CHANNEL | MODULATION | DATA RATE (Mbps) | ANTENNA PORT |
| 802.11b         | 1 to 11           | 1,4,6,8,11     | DSSS       | 1                | 2TX          |
| 802.11g         | 1 to 11           | 1,4,6,8,11     | OFDM       | 6                | 2TX          |
| 802.11n (HT20)  | 1 to 11           | 1,4,6,8,11     | OFDM       | MCS0             | 2TX          |
| 802.11n (HT40)  | 3 to 9            | 3,5,6,7,9      | OFDM       | MCS0             | 2TX          |
| 802.11ax (HE20) | 1 to 11           | 1,4,6,8,11     | OFDMA      | MCS0             | 2TX          |
| 802.11ax (HE40) | 3 to 9            | 3,5,6,7,9      | OFDMA      | MCS0             | 2TX          |

| RADIATED EMISSION TEST (BELOW 1 GHz) |                   |                |            |                  |              |
|--------------------------------------|-------------------|----------------|------------|------------------|--------------|
| MODE                                 | AVAILABLE CHANNEL | TESTED CHANNEL | MODULATION | DATA RATE (Mbps) | ANTENNA PORT |
| 802.11g                              | 1 to 11           | 6              | OFDM       | 6                | 2TX          |

| RADIATED EMISSION TEST (ABOVE 1 GHz) |                   |                |            |                  |              |
|--------------------------------------|-------------------|----------------|------------|------------------|--------------|
| MODE                                 | AVAILABLE CHANNEL | TESTED CHANNEL | MODULATION | DATA RATE (Mbps) | ANTENNA PORT |
| 802.11b                              | 1 to 11           | 1,4,6,8,11     | DSSS       | 1                | 2TX          |
| 802.11g                              | 1 to 11           | 1,4,6,8,11     | OFDM       | 6                | 2TX          |
| 802.11n (HT20)                       | 1 to 11           | 1,4,6,8,11     | OFDM       | MCS0             | 2TX          |
| 802.11n (HT40)                       | 3 to 9            | 3,5,6,7,9      | OFDM       | MCS0             | 2TX          |
| 802.11ax (HE20)                      | 1 to 11           | 1,4,6,8,11     | OFDMA      | MCS0             | 2TX          |
| 802.11ax (HE40)                      | 3 to 9            | 3,5,6,7,9      | OFDMA      | MCS0             | 2TX          |

**Note:**

The field strength of radiated emission was measured as the EUT positioned in different orthogonal planes (E1/E2/H) based on actual usage of the EUT to pre-scan the emissions for determining the worst case scenario.

Unless otherwise stated the results shown in this test report refer only to the sample(s) tested and such sample(s) are retained for 90 days only.  
 除非另有說明，此報告結果僅對測試之樣品負責，同時此樣品僅保留90天。本報告未經本公司書面許可，不可部份複製。

This document is issued by the Company subject to its General Conditions of Service printed overleaf, available on request or accessible at <http://www.sgs.com.tw/Terms-and-Conditions> and for electronic format documents, subject to Terms and Conditions for Electronic Documents at <http://www.sgs.com.tw/Terms-and-Conditions>. Attention is drawn to the limitation of liability, indemnification and jurisdiction issues defined therein. Any holder of this document is advised that information contained hereon reflects the Company's findings at the time of its intervention only and within the limits of Client's instructions, if any. The Company's sole responsibility is to its Client and this document does not exonerate parties to a transaction from exercising all their rights and obligations under the transaction documents. This document cannot be reproduced except in full, without prior written approval of the Company. Any unauthorized alteration, forgery or falsification of the content or appearance of this document is unlawful and offenders may be prosecuted to the fullest extent of the law.

## 5 MEASUREMENT UNCERTAINTY

| Test Items                                 | Uncertainty |
|--------------------------------------------|-------------|
| AC Power Line Conducted Emission           | +/- 2.32 dB |
| Output Power measurement                   | +/- 1 dB    |
| Emission Bandwidth                         | +/- 1.53 Hz |
| Undesignable radiated emission measurement | +/- 1.68 dB |
| Peak Power Density                         | +/- 2.16 dB |
| Temperature                                | +/- 0.7 °C  |
| Humidity                                   | +/- 3 %     |
| DC / AC Power Source                       | +/- 1 %     |

| Radiated Spurious Emission Measurement Uncertainty |     |         |                 |
|----------------------------------------------------|-----|---------|-----------------|
| Polarization: Vertical                             | +/- | 2.8 dB  | 9kHz~30MHz      |
|                                                    | +/- | 4.82 dB | 30MHz - 1000MHz |
|                                                    | +/- | 4.37 dB | 1GHz - 18GHz    |
|                                                    | +/- | 4.21 dB | 18GHz - 40GHz   |
| Polarization: Horizontal                           | +/- | 2.8 dB  | 9kHz~30MHz      |
|                                                    | +/- | 4.54 dB | 30MHz - 1000MHz |
|                                                    | +/- | 4.37 dB | 1GHz - 18GHz    |
|                                                    | +/- | 4.21 dB | 18GHz - 40GHz   |

### Note:

1. This uncertainty represents an expanded uncertainty expressed at approximately the 95% confidence level using a coverage factor of k=2.
2. The conformity assessment statement in this report is based solely on the test results, measurement uncertainty is excluded.

Unless otherwise stated the results shown in this test report refer only to the sample(s) tested and such sample(s) are retained for 90 days only.

除非另有說明，此報告結果僅對測試之樣品負責，同時此樣品僅保留90天。本報告未經本公司書面許可，不可部份複製。

This document is issued by the Company subject to its General Conditions of Service printed overleaf, available on request or accessible at <http://www.sgs.com.tw/Terms-and-Conditions> and for electronic format documents, subject to Terms and Conditions for Electronic Documents at <http://www.sgs.com.tw/Terms-and-Conditions>. Attention is drawn to the limitation of liability, indemnification and jurisdiction issues defined therein. Any holder of this document is advised that information contained hereon reflects the Company's findings at the time of its intervention only and within the limits of Client's instructions, if any. The Company's sole responsibility is to its Client and this document does not exonerate parties to a transaction from exercising all their rights and obligations under the transaction documents. This document cannot be reproduced except in full, without prior written approval of the Company. Any unauthorized alteration, forgery or falsification of the content or appearance of this document is unlawful and offenders may be prosecuted to the fullest extent of the law.

## 6 MEASUREMENT EQUIPMENT USED

### 6.1 Emission from AC power line

| AC Power-Line Conducted Emission Test Site: Conduction 1 |                       |                      |               |            |            |
|----------------------------------------------------------|-----------------------|----------------------|---------------|------------|------------|
| EQUIPMENT TYPE                                           | MFR                   | MODEL NUMBER         | SERIAL NUMBER | LAST CAL.  | CAL DUE.   |
| EMI Test Receiver                                        | R&S                   | ESR 7                | 102525        | 02/18/2023 | 02/17/2024 |
| Pulse Limiter                                            | SCHWARZBECK           | VTSD 9561F-N         | 793           | 06/22/2022 | 06/21/2023 |
| LISN                                                     | SCHWARZBECK           | NSLK 8127            | 01040         | 08/23/2022 | 08/22/2023 |
| Coaxial Cables                                           | EMC Instruments Corp. | EMCCFD300-BM-BM-3000 | 161207        | 06/22/2022 | 06/21/2023 |
| Test Software                                            | audix                 | e3                   | Ver. 9 210322 | N.C.R      | N.C.R      |

### 6.2 Conducted Measurement

| Conducted Emission Test Site: Conducted 2 |               |                     |               |            |            |
|-------------------------------------------|---------------|---------------------|---------------|------------|------------|
| EQUIPMENT TYPE                            | MFR           | MODEL NUMBER        | SERIAL NUMBER | LAST CAL.  | CAL DUE.   |
| EXA Spectrum Analyzer                     | KEYSIGHT      | N9010B              | MY59071541    | 07/14/2022 | 07/13/2023 |
| Test Software                             | SGS           | Radio Test Software | Ver. 21       | N.C.R      | N.C.R      |
| Power Meter                               | Anritsu       | ML2496A             | 2132007       | 09/21/2022 | 09/20/2023 |
| Power Sensor                              | Anritsu       | MA2411B             | 1911391       | 09/21/2022 | 09/20/2023 |
| Power Sensor                              | Anritsu       | MA2411B             | 1911392       | 09/21/2022 | 09/20/2023 |
| Attenuator                                | Mini-Circuit  | BW-S10W2+           | 4             | 12/13/2022 | 12/12/2023 |
| DC Block                                  | Mini-Circuits | BLK-18-S+           | 1             | 12/13/2022 | 12/12/2023 |

Unless otherwise stated the results shown in this test report refer only to the sample(s) tested and such sample(s) are retained for 90 days only.

除非另有說明，此報告結果僅對測試之樣品負責，同時此樣品僅保留90天。本報告未經本公司書面許可，不可部份複製。

This document is issued by the Company subject to its General Conditions of Service printed overleaf, available on request or accessible at <http://www.sgs.com.tw/Terms-and-Conditions> and for electronic format documents, subject to Terms and Conditions for Electronic Documents at <http://www.sgs.com.tw/Terms-and-Conditions>. Attention is drawn to the limitation of liability, indemnification and jurisdiction issues defined therein. Any holder of this document is advised that information contained hereon reflects the Company's findings at the time of its intervention only and within the limits of Client's instructions, if any. The Company's sole responsibility is to its Client and this document does not exonerate parties to a transaction from exercising all their rights and obligations under the transaction documents. This document cannot be reproduced except in full, without prior written approval of the Company. Any unauthorized alteration, forgery or falsification of the content or appearance of this document is unlawful and offenders may be prosecuted to the fullest extent of the law.



### 6.3 Radiated Measurement

| Radiated Emission Test Site: SAC 3 |                 |                    |               |            |            |
|------------------------------------|-----------------|--------------------|---------------|------------|------------|
| EQUIPMENT TYPE                     | MFR             | MODEL NUMBER       | SERIAL NUMBER | LAST CAL.  | CAL DUE.   |
| Horn Antenna                       | SCHWARZBECK     | BBHA9170           | 184           | 12/30/2022 | 12/29/2023 |
| Horn Antenna                       | SCHWARZBECK     | BBHA9120D          | 1441          | 09/27/2022 | 09/26/2023 |
| Bi-log Antenna                     | SCHWARZBECK     | VULB9168           | 378           | 08/15/2022 | 08/14/2023 |
| Loop Antenna                       | ETS.LINDGREN    | 6502               | 148045        | 10/05/2022 | 10/04/2023 |
| Spectrum Analyzer                  | Agilent         | E4446A             | MY51100003    | 10/28/2022 | 10/27/2023 |
| EMI Test Receiver                  | R&S             | ESCI 7             | 100759        | 08/22/2022 | 08/21/2023 |
| Pre-Amplifier                      | EMC Instruments | EMC118A45SEE       | 980868        | 12/13/2022 | 12/12/2023 |
| Pre-Amplifier                      | EMC Instruments | EMC184045B         | 980135        | 10/27/2022 | 10/26/2023 |
| Pre-Amplifier                      | HP              | 8447D              | 2944A07676    | 12/13/2022 | 12/12/2023 |
| Attenuator                         | Mini-Circuit    | BW-S10W2+          | 4             | 12/13/2022 | 12/12/2023 |
| Filter 2400-2483.5 MHz             | EWT             | EWT-14-0166        | M1            | 12/13/2022 | 12/12/2023 |
| High Pass Filter                   | WI              | WHKX4.0/18G-10SS   | 22            | 12/13/2022 | 12/12/2023 |
| Coaxial Cable                      | Huber Suhner    | SUCOFLEX 104PEA    | MY4251/4PEA   | 12/13/2022 | 12/12/2023 |
| Coaxial Cable                      | EMC Instruments | EMC 107-SM-SM-500  | 221104        | 12/13/2022 | 12/12/2023 |
| Coaxial Cable                      | EMC Instruments | EMC 107-SM-SM-1000 | 221103        | 12/13/2022 | 12/12/2023 |
| Coaxial Cable                      | EMC Instruments | EMC 107-SM-SM-1500 | 221110        | 12/13/2022 | 12/12/2023 |
| Coaxial Cable                      | EMC Instruments | EMC 107-SM-SM-8000 | 221109        | 12/13/2022 | 12/12/2023 |
| Site Cal                           | SGS             | SAC 3              | N/A           | 01/01/2023 | 12/31/2023 |
| Test Software                      | audix           | e3                 | Ver. 9 210322 | N.C.R      | N.C.R      |

**NOTE:** N.C.R refers to Not Calibrated Required.

Unless otherwise stated the results shown in this test report refer only to the sample(s) tested and such sample(s) are retained for 90 days only.

除非另有說明，此報告結果僅對測試之樣品負責，同時此樣品僅保留90天。本報告未經本公司書面許可，不可部份複製。

This document is issued by the Company subject to its General Conditions of Service printed overleaf, available on request or accessible at <http://www.sgs.com.tw/Terms-and-Conditions> and for electronic format documents, subject to Terms and Conditions for Electronic Documents at <http://www.sgs.com.tw/Terms-and-Conditions>. Attention is drawn to the limitation of liability, indemnification and jurisdiction issues defined therein. Any holder of this document is advised that information contained hereon reflects the Company's findings at the time of its intervention only and within the limits of Client's instructions, if any. The Company's sole responsibility is to its Client and this document does not exonerate parties to a transaction from exercising all their rights and obligations under the transaction documents. This document cannot be reproduced except in full, without prior written approval of the Company. Any unauthorized alteration, forgery or falsification of the content or appearance of this document is unlawful and offenders may be prosecuted to the fullest extent of the law.

## 7 CONDUCTED EMISSION TEST

### 7.1 Standard Applicable

Frequency range within 150kHz to 30MHz shall not exceed the Limit table as below.

| Frequency range<br>MHz | Limits<br>(dBuV) |          |
|------------------------|------------------|----------|
|                        | Quasi-peak       | Average  |
| 0.15 to 0.50           | 66 to 56         | 56 to 46 |
| 0.50 to 5              | 56               | 46       |
| 5 to 30                | 60               | 50       |

Note

- The lower limit shall apply at the transition frequencies
- The limit decreases linearly with the logarithm of the frequency in the range 0.15 MHz to 0.50 MHz.

### 7.2 EUT Setup

- The conducted emission tests were performed in the test site, using the setup in accordance with the ANSI C63.10:2013.
- The AC/DC Power adaptor of EUT was plug-in LISN. The EUT was placed flushed with the rear of the table.
- The LISN was connected with 120Vac/60Hz power source.

### 7.3 Test Setup

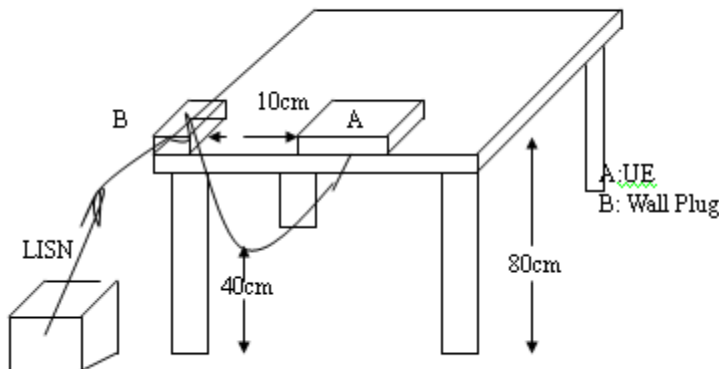

Unless otherwise stated the results shown in this test report refer only to the sample(s) tested and such sample(s) are retained for 90 days only.

除非另有說明，此報告結果僅對測試之樣品負責，同時此樣品僅保留90天。本報告未經本公司書面許可，不可部份複製。

This document is issued by the Company subject to its General Conditions of Service printed overleaf, available on request or accessible at <http://www.sgs.com.tw/Terms-and-Conditions> and for electronic format documents, subject to Terms and Conditions for Electronic Documents at <http://www.sgs.com.tw/Terms-and-Conditions>. Attention is drawn to the limitation of liability, indemnification and jurisdiction issues defined therein. Any holder of this document is advised that information contained hereon reflects the Company's findings at the time of its intervention only and within the limits of Client's instructions, if any. The Company's sole responsibility is to its Client and this document does not exonerate parties to a transaction from exercising all their rights and obligations under the transaction documents. This document cannot be reproduced except in full, without prior written approval of the Company. Any unauthorized alteration, forgery or falsification of the content or appearance of this document is unlawful and offenders may be prosecuted to the fullest extent of the law.

## 7.4 Measurement Procedure

1. The EUT was placed on a table which is 0.8m above ground plane.
2. Maximum procedure was performed on the six highest emissions to ensure EUT compliance.
3. Repeat above procedures until all phases of power being supplied by given UE are completed

## 7.5 Measurement Result

Note: Refer to next page for measurement data and plots.

Note2: The \* reveals the worst-case results that closest to the limit.

Unless otherwise stated the results shown in this test report refer only to the sample(s) tested and such sample(s) are retained for 90 days only.  
除非另有說明，此報告結果僅對測試之樣品負責，同時此樣品僅保留90天。本報告未經本公司書面許可，不可部份複製。

This document is issued by the Company subject to its General Conditions of Service printed overleaf, available on request or accessible at <http://www.sgs.com.tw/Terms-and-Conditions> and for electronic format documents, subject to Terms and Conditions for Electronic Documents at <http://www.sgs.com.tw/Terms-and-Conditions>. Attention is drawn to the limitation of liability, indemnification and jurisdiction issues defined therein. Any holder of this document is advised that information contained hereon reflects the Company's findings at the time of its intervention only and within the limits of Client's instructions, if any. The Company's sole responsibility is to its Client and this document does not exonerate parties to a transaction from exercising all their rights and obligations under the transaction documents. This document cannot be reproduced except in full, without prior written approval of the Company. Any unauthorized alteration, forgery or falsification of the content or appearance of this document is unlawful and offenders may be prosecuted to the fullest extent of the law.

### AC POWER LINE CONDUCTED EMISSION TEST DATA

|               |                       |             |               |
|---------------|-----------------------|-------------|---------------|
| Report Number | :TERF2303000752ER     | Test Site   | :Conduction 1 |
| Test Mode     | :Operation (WLAN2.4G) | Test Date   | :2023-04-21   |
| Power         | :120V/60Hz            | Temp./Humi. | :26.5/55      |
| Probe         | :L                    | Engineer    | :Nick Lin     |
| Note:         | :                     |             |               |

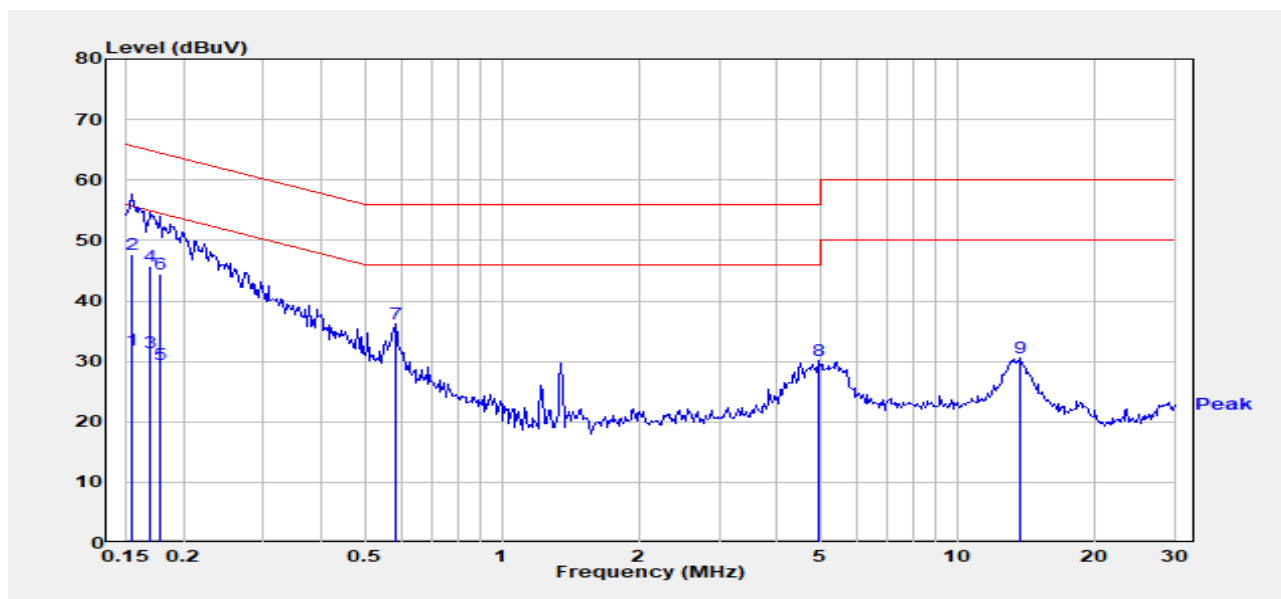

| Freq.<br>MHz | Detector<br>Mode | Spectrum<br>Reading Level<br>dBuV | Factor<br>dB | Actual<br>FS<br>dBuV | Limit<br>dBuV | Margin<br>dB |
|--------------|------------------|-----------------------------------|--------------|----------------------|---------------|--------------|
| 0.153        | Average          | 21.71                             | 10.25        | 31.96                | 55.81         | -23.85       |
| 0.153        | QP               | 37.52                             | 10.25        | 47.77                | 65.81         | -18.04       |
| 0.170        | Average          | 21.09                             | 10.25        | 31.34                | 54.98         | -23.64       |
| 0.170        | QP               | 35.51                             | 10.25        | 45.76                | 64.98         | -19.22       |
| 0.178        | Average          | 19.26                             | 10.25        | 29.51                | 54.60         | -25.09       |
| 0.178        | QP               | 34.12                             | 10.25        | 44.37                | 64.60         | -20.23       |
| 0.584        | Peak             | 25.92                             | 10.28        | 36.19                | 56.00         | -19.81       |
| 4.975        | Peak             | 19.61                             | 10.54        | 30.15                | 56.00         | -25.85       |
| 13.814       | Peak             | 19.83                             | 10.78        | 30.60                | 60.00         | -29.40       |

Unless otherwise stated the results shown in this test report refer only to the sample(s) tested and such sample(s) are retained for 90 days only.

除非另有說明，此報告結果僅對測試之樣品負責，同時此樣品僅保留90天。本報告未經本公司書面許可，不可部份複製。  
This document is issued by the Company subject to its General Conditions of Service printed overleaf, available on request or accessible at <http://www.sgs.com.tw/Terms-and-Conditions> and for electronic format documents, subject to Terms and Conditions for Electronic Documents at <http://www.sgs.com.tw/Terms-and-Conditions>. Attention is drawn to the limitation of liability, indemnification and jurisdiction issues defined therein. Any holder of this document is advised that information contained hereon reflects the Company's findings at the time of its intervention only and within the limits of Client's instructions, if any. The Company's sole responsibility is to its Client and this document does not exonerate parties to a transaction from exercising all their rights and obligations under the transaction documents. This document cannot be reproduced except in full, without prior written approval of the Company. Any unauthorized alteration, forgery or falsification of the content or appearance of this document is unlawful and offenders may be prosecuted to the fullest extent of the law.

SGS Taiwan Ltd. No.134,Wu Kung Road, New Taipei Industrial Park, Wuku District, New Taipei City, Taiwan/新北市五股區新北產業園區五工路 134 號

Report Number :TERF2303000752ER  
 Test Mode :Operation (WLAN2.4G)  
 Power :120V/60Hz  
 Probe :N  
 Note :

Test Site :Conduction 1  
 Test Date :2023-04-21  
 Temp./Humi. :26.5/55  
 Engineer :Nick Lin

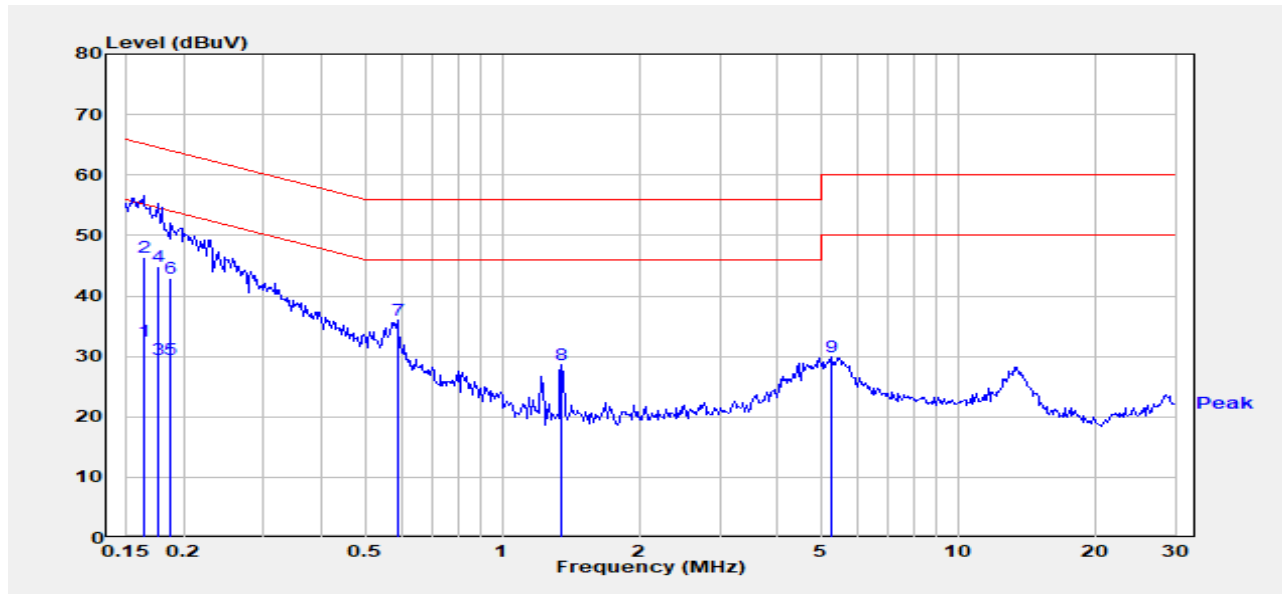

| Freq.<br>MHz | Detector<br>Mode<br>PK/QP/AV | Spectrum<br>Reading Level<br>dB $\mu$ V | Factor<br>dB | Actual<br>FS<br>dB $\mu$ V | Limit<br>dB $\mu$ V | Margin<br>dB |
|--------------|------------------------------|-----------------------------------------|--------------|----------------------------|---------------------|--------------|
| 0.163        | Average                      | 22.18                                   | 10.25        | 32.43                      | 55.30               | -22.87       |
| 0.163        | QP                           | 36.22                                   | 10.25        | 46.47                      | 65.30               | -18.83       |
| 0.176        | Average                      | 19.22                                   | 10.25        | 29.47                      | 54.66               | -25.19       |
| 0.176        | QP                           | 34.53                                   | 10.25        | 44.78                      | 64.66               | -19.88       |
| 0.187        | Average                      | 19.18                                   | 10.25        | 29.43                      | 54.15               | -24.72       |
| 0.187        | QP                           | 32.76                                   | 10.25        | 43.01                      | 64.15               | -21.14       |
| 0.588        | Peak                         | 25.72                                   | 10.28        | 36.00                      | 56.00               | -20.00       |
| 1.349        | Peak                         | 17.90                                   | 10.67        | 28.57                      | 56.00               | -27.43       |
| 5.290        | Peak                         | 19.30                                   | 10.56        | 29.86                      | 60.00               | -30.14       |

Unless otherwise stated the results shown in this test report refer only to the sample(s) tested and such sample(s) are retained for 90 days only.

除非另有說明，此報告結果僅對測試之樣品負責，同時此樣品僅保留90天。本報告未經本公司書面許可，不可部份複製。  
 This document is issued by the Company subject to its General Conditions of Service printed overleaf, available on request or accessible at <http://www.sgs.com.tw/Terms-and-Conditions> and for electronic format documents, subject to Terms and Conditions for Electronic Documents at <http://www.sgs.com.tw/Terms-and-Conditions>. Attention is drawn to the limitation of liability, indemnification and jurisdiction issues defined therein. Any holder of this document is advised that information contained hereon reflects the Company's findings at the time of its intervention only and within the limits of Client's instructions, if any. The Company's sole responsibility is to its Client and this document does not exonerate parties to a transaction from exercising all their rights and obligations under the transaction documents. This document cannot be reproduced except in full, without prior written approval of the Company. Any unauthorized alteration, forgery or falsification of the content or appearance of this document is unlawful and offenders may be prosecuted to the fullest extent of the law.

## 8 PEAK OUTPUT POWER MEASUREMENT

### 8.1 Standard Applicable

### 8.2 Duty Cycle

Pre-analysis Check: While conducting average power measurement, duty cycle of each mode shall be checked to ensure its duty cycle in order to compensate for the loss due to insufficient ratio of duty cycle.

All duty cycle is pre-scanned, and result as obtained below shows only the most representative ones where duty cycle is conducted as the given transmission with given virtual operation that expresses the percentage.

### 8.3 Output Power

For systems using digital modulation in the 2400-2483.5 MHz bands, the limit for peak output power is 1Watt and the e.i.r.p. shall not exceed 4 W.

If the transmitting antenna of directional gain greater than 6dBi are used the peak output power form the intentional radiator shall be reduced below the above stated value by the amount in dB that the directional gain of the Antenna exceeds 6dBi.

In case of point-to-point operation, the limit has to be reduced by 1dB for every 3dB that the directional gain of Antenna exceeds 6dBi.

#### Note:

As per section F. 2). e). (ii) of FCC KDB 662911 D01

If antenna gains are not equal and each transmit antenna is driven by only one spatial stream, directional gain may be calculated by either of the following formulas.

$$\bullet \quad \text{DirectionalGain} = 10 \cdot \log \left[ \frac{\sum_{j=1}^{N_{SS}} \left\{ \sum_{k=1}^{N_{ANT}} g_{j,k} \right\}^2}{N_{ANT}} \right]$$

where

Each antenna is driven by no more than one spatial stream;

NSS = the number of independent spatial streams of data;

NANT = the total number of antennas

$g_{j,k} = 10^{G_k/20}$  if the kth antenna is being fed by spatial stream j, or zero if it is not;

Unless otherwise stated the results shown in this test report refer only to the sample(s) tested and such sample(s) are retained for 90 days only.  
 除非另有說明，此報告結果僅對測試之樣品負責，同時此樣品僅保留90天。本報告未經本公司書面許可，不可部份複製。

This document is issued by the Company subject to its General Conditions of Service printed overleaf, available on request or accessible at <http://www.sgs.com.tw/Terms-and-Conditions> and for electronic format documents, subject to Terms and Conditions for Electronic Documents at <http://www.sgs.com.tw/Terms-and-Conditions>. Attention is drawn to the limitation of liability, indemnification and jurisdiction issues defined therein. Any holder of this document is advised that information contained hereon reflects the Company's findings at the time of its intervention only and within the limits of Client's instructions, if any. The Company's sole responsibility is to its Client and this document does not exonerate parties to a transaction from exercising all their rights and obligations under the transaction documents. This document cannot be reproduced except in full, without prior written approval of the Company. Any unauthorized alteration, forgery or falsification of the content or appearance of this document is unlawful and offenders may be prosecuted to the fullest extent of the law.

$G_k$  is the gain in dBi of the kth antenna.

The antenna gain is not greater than 6 dBi. Therefore, reduction of power is not required.

## 8.4 Test Setup

### 8.4.1 Duty Cycle

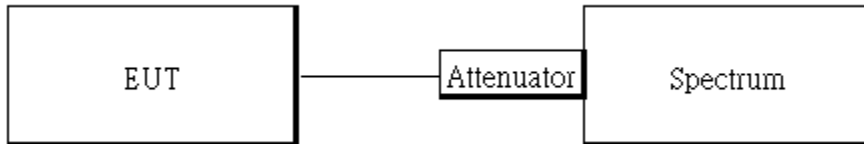

### 8.4.2 Output Power:

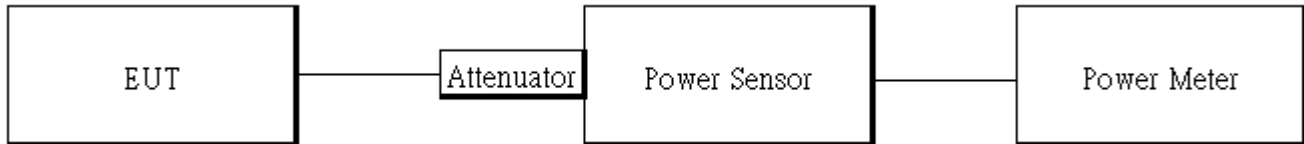

## 8.5 Measurement Procedure

### 8.5.1 Duty Cycle:

1. Set span = Zero
2. RBW = 8MHz
3. VBW = 8MHz,
4. Detector = Peak

### 8.5.2 Output Power

1. Place the EUT on the table and set it in transmitting mode.
2. The testing follows the Measurement Procedure of FCC KDB 558074 D01 DTS Meas. Guidance .
3. Remove the antenna from the EUT and then connect a low loss RF cable from the antenna port to the power meter.

#### Power Meter:

It is used as the auxiliary test equipment to conduct the output power measurement.

4. Record the max. Reading as observed from Spectrum or Power Meter.
5. MIMO mode: offset is set with “measure and add 10 Log (N)” to measurement for MIMO mode. Offset = cable loss + 10 log (N), where N is number of transmitting antenna, cable loss is specified below.

**\* Note: The duty cycle factor and below is compensated to obtain the maximum value of measurement in average.**

Unless otherwise stated the results shown in this test report refer only to the sample(s) tested and such sample(s) are retained for 90 days only.  
 除非另有說明，此報告結果僅對測試之樣品負責，同時此樣品僅保留90天。本報告未經本公司書面許可，不可部份複製。

This document is issued by the Company subject to its General Conditions of Service printed overleaf, available on request or accessible at <http://www.sgs.com.tw/Terms-and-Conditions> and for electronic format documents, subject to Terms and Conditions for Electronic Documents at <http://www.sgs.com.tw/Terms-and-Conditions>. Attention is drawn to the limitation of liability, indemnification and jurisdiction issues defined therein. Any holder of this document is advised that information contained hereon reflects the Company's findings at the time of its intervention only and within the limits of Client's instructions, if any. The Company's sole responsibility is to its Client and this document does not exonerate parties to a transaction from exercising all their rights and obligations under the transaction documents. This document cannot be reproduced except in full, without prior written approval of the Company. Any unauthorized alteration, forgery or falsification of the content or appearance of this document is unlawful and offenders may be prosecuted to the fullest extent of the law.

## 8.6 Measurement Result

### 8.6.1 Duty Cycle:

|             | Duty Cycle (%)<br>= Ton / (Ton+Toff) | Duty Factor (dB)<br>=10*log ( 1/Duty Cycle ) | 1/T<br>(kHz) | VBW setting<br>(kHz) |
|-------------|--------------------------------------|----------------------------------------------|--------------|----------------------|
| 802.11b     | 83.98                                | 0.76                                         | 0.08         | 1.00                 |
| 802.11g     | 96.11                                | 0.17                                         | 0.51         | 1.00                 |
| 802.11n_20  | 80.41                                | 0.95                                         | 0.18         | 1.00                 |
| 802.11n_40  | 80.32                                | 0.95                                         | 0.18         | 1.00                 |
| 802.11ax_20 | 80.51                                | 0.94                                         | 0.18         | 1.00                 |
| 802.11ax_40 | 80.38                                | 0.95                                         | 0.18         | 1.00                 |

Unless otherwise stated the results shown in this test report refer only to the sample(s) tested and such sample(s) are retained for 90 days only.  
 除非另有說明，此報告結果僅對測試之樣品負責，同時此樣品僅保留90天。本報告未經本公司書面許可，不可部份複製。

This document is issued by the Company subject to its General Conditions of Service printed overleaf, available on request or accessible at <http://www.sgs.com.tw/Terms-and-Conditions> and for electronic format documents, subject to Terms and Conditions for Electronic Documents at <http://www.sgs.com.tw/Terms-and-Conditions>. Attention is drawn to the limitation of liability, indemnification and jurisdiction issues defined therein. Any holder of this document is advised that information contained hereon reflects the Company's findings at the time of its intervention only and within the limits of Client's instructions, if any. The Company's sole responsibility is to its Client and this document does not exonerate parties to a transaction from exercising all their rights and obligations under the transaction documents. This document cannot be reproduced except in full, without prior written approval of the Company. Any unauthorized alteration, forgery or falsification of the content or appearance of this document is unlawful and offenders may be prosecuted to the fullest extent of the law.



### 8.6.2 Duty Cycle test plots

802.11b\_20MHz\_Chain0\_2412MHz

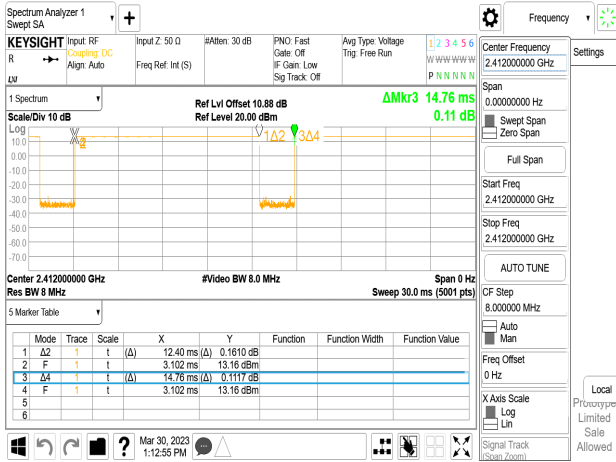

802.11n\_40MHz\_Chain0\_2422MHz

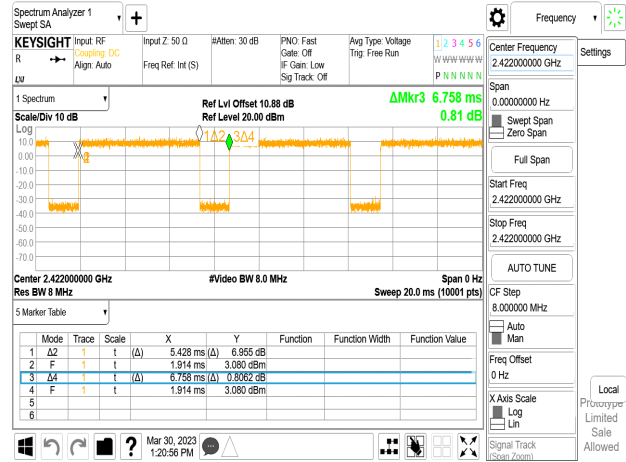

802.11g\_20MHz\_Chain0\_2412MHz

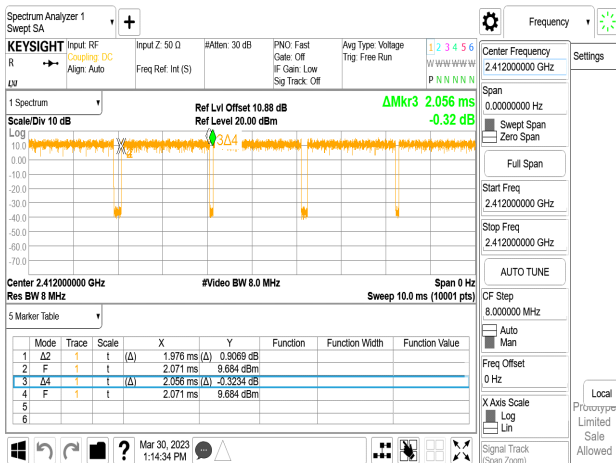

802.11ax\_20MHz\_Chain0\_2412MHz

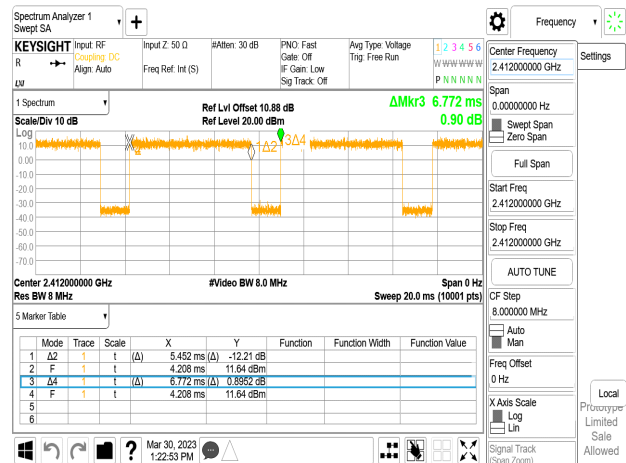

802.11n\_20MHz\_Chain0\_2412MHz



802.11ax\_40MHz\_Chain0\_2422MHz

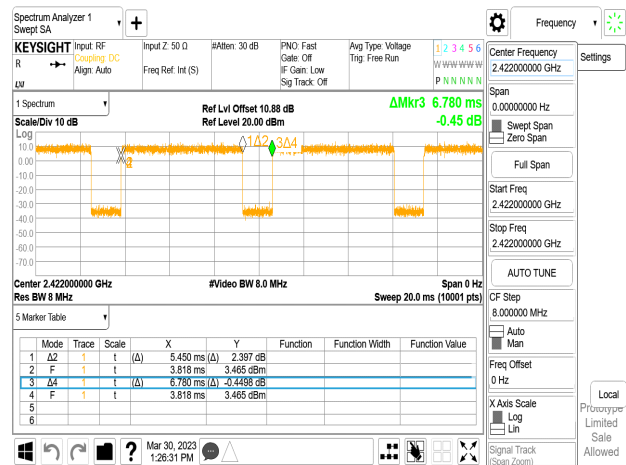

Unless otherwise stated the results shown in this test report refer only to the sample(s) tested and such sample(s) are retained for 90 days only.

除非另有說明，此報告結果僅對測試之樣品負責，同時此樣品僅保留90天。本報告未經本公司書面許可，不可部份複製。

This document is issued by the Company subject to its General Conditions of Service printed overleaf, available on request or accessible at <http://www.sgs.com.tw/Terms-and-Conditions> and for electronic format documents, subject to Terms and Conditions for Electronic Documents at <http://www.sgs.com.tw/Terms-and-Conditions>. Attention is drawn to the limitation of liability, indemnification and jurisdiction issues defined therein. Any holder of this document is advised that information contained hereon reflects the Company's findings at the time of its intervention only and within the limits of Client's instructions, if any. The Company's sole responsibility is to its Client and this document does not exonerate parties to a transaction from exercising all their rights and obligations under the transaction documents. This document cannot be reproduced except in full, without prior written approval of the Company. Any unauthorized alteration, forgery or falsification of the content or appearance of this document is unlawful and offenders may be prosecuted to the fullest extent of the law.

## 8.6.3 Output Power

| 802.11b Ch0 |             |           |           |                         |             |        |
|-------------|-------------|-----------|-----------|-------------------------|-------------|--------|
| CH          | Freq. (MHz) | Data Rate | Power set | Peak Output Power (dBm) | Limit (dBm) | RESULT |
| 1           | 2412        | 1         | 18        | 20.36                   | 30.00       | PASS   |
| 4           | 2427        | 1         | 19.5      | 22.25                   | 30.00       | PASS   |
| 6           | 2437        | 1         | 19.5      | 21.91                   | 30.00       | PASS   |
| 8           | 2447        | 1         | 20        | 22.08                   | 30.00       | PASS   |
| 11          | 2462        | 1         | 18.5      | 20.47                   | 30.00       | PASS   |

| 802.11b Ch0 |             |           |           |                                                        |             |        |
|-------------|-------------|-----------|-----------|--------------------------------------------------------|-------------|--------|
| CH          | Freq. (MHz) | Data Rate | Power set | Max. Avg. Output include tune up tolerance Power (dBm) | Limit (dBm) | RESULT |
| 1           | 2412        | 1         | 18        | 17.68                                                  | 30.00       | PASS   |
| 4           | 2427        | 1         | 19.5      | 19.78                                                  | 30.00       | PASS   |
| 6           | 2437        | 1         | 19.5      | 19.63                                                  | 30.00       | PASS   |
| 8           | 2447        | 1         | 20        | 19.75                                                  | 30.00       | PASS   |
| 11          | 2462        | 1         | 18.5      | 17.95                                                  | 30.00       | PASS   |

| 802.11b Ch1 |             |           |           |                         |             |        |
|-------------|-------------|-----------|-----------|-------------------------|-------------|--------|
| CH          | Freq. (MHz) | Data Rate | Power set | Peak Output Power (dBm) | Limit (dBm) | RESULT |
| 1           | 2412        | 1         | 18.5      | 20.06                   | 30.00       | PASS   |
| 4           | 2427        | 1         | 19.5      | 21.77                   | 30.00       | PASS   |
| 6           | 2437        | 1         | 20        | 21.58                   | 30.00       | PASS   |
| 8           | 2447        | 1         | 19.5      | 21.95                   | 30.00       | PASS   |
| 11          | 2462        | 1         | 19        | 20.26                   | 30.00       | PASS   |

| 802.11b Ch1 |             |           |           |                                                        |             |        |
|-------------|-------------|-----------|-----------|--------------------------------------------------------|-------------|--------|
| CH          | Freq. (MHz) | Data Rate | Power set | Max. Avg. Output include tune up tolerance Power (dBm) | Limit (dBm) | RESULT |
| 1           | 2412        | 1         | 18.5      | 17.61                                                  | 30.00       | PASS   |
| 4           | 2427        | 1         | 19.5      | 19.68                                                  | 30.00       | PASS   |
| 6           | 2437        | 1         | 20        | 19.54                                                  | 30.00       | PASS   |
| 8           | 2447        | 1         | 19.5      | 19.56                                                  | 30.00       | PASS   |
| 11          | 2462        | 1         | 19        | 17.85                                                  | 30.00       | PASS   |

Unless otherwise stated the results shown in this test report refer only to the sample(s) tested and such sample(s) are retained for 90 days only.

除非另有說明，此報告結果僅對測試之樣品負責，同時此樣品僅保留90天。本報告未經本公司書面許可，不可部份複製。

This document is issued by the Company subject to its General Conditions of Service printed overleaf, available on request or accessible at <http://www.sgs.com.tw/Terms-and-Conditions> and for electronic format documents, subject to Terms and Conditions for Electronic Documents at <http://www.sgs.com.tw/Terms-and-Conditions>. Attention is drawn to the limitation of liability, indemnification and jurisdiction issues defined therein. Any holder of this document is advised that information contained hereon reflects the Company's findings at the time of its intervention only and within the limits of Client's instructions, if any. The Company's sole responsibility is to its Client and this document does not exonerate parties to a transaction from exercising all their rights and obligations under the transaction documents. This document cannot be reproduced except in full, without prior written approval of the Company. Any unauthorized alteration, forgery or falsification of the content or appearance of this document is unlawful and offenders may be prosecuted to the fullest extent of the law.

| 802.11b_2TX |             |           |           |                   |       |                               |             |        |
|-------------|-------------|-----------|-----------|-------------------|-------|-------------------------------|-------------|--------|
| CH          | Freq. (MHz) | Data Rate | Power set | Peak Output Power |       | Total Peak Output Power (dBm) | Limit (dBm) | RESULT |
|             |             |           |           | Ch0               | Ch1   |                               |             |        |
| 1           | 2412        | 1         | 18.5      | 20.74             | 20.64 | 23.70                         | 30.00       | PASS   |
| 4           | 2427        | 1         | 20.5      | 22.77             | 22.69 | <b>25.74</b>                  | 30.00       | PASS   |
| 6           | 2437        | 1         | 20.5      | 22.57             | 22.42 | 25.51                         | 30.00       | PASS   |
| 8           | 2447        | 1         | 20.5      | 22.73             | 22.44 | 25.60                         | 30.00       | PASS   |
| 11          | 2462        | 1         | 19        | 20.52             | 20.29 | 23.42                         | 30.00       | PASS   |

| 802.11b_2TX |             |           |           |                         |       |                                                        |             |        |
|-------------|-------------|-----------|-----------|-------------------------|-------|--------------------------------------------------------|-------------|--------|
| CH          | Freq. (MHz) | Data Rate | Power set | Avg. Output Power (dBm) |       | Max. Avg. Output include tune up tolerance Power (dBm) | Limit (dBm) | RESULT |
|             |             |           |           | Ch0                     | Ch1   |                                                        |             |        |
| 1           | 2412        | 1         | 18.5      | 18.04                   | 17.89 | 20.97                                                  | 30.00       | PASS   |
| 4           | 2427        | 1         | 20.5      | 20.03                   | 19.89 | <b>22.97</b>                                           | 30.00       | PASS   |
| 6           | 2437        | 1         | 20.5      | 19.81                   | 19.67 | 22.75                                                  | 30.00       | PASS   |
| 8           | 2447        | 1         | 20.5      | 19.88                   | 19.75 | 22.82                                                  | 30.00       | PASS   |
| 11          | 2462        | 1         | 19        | 17.98                   | 17.97 | 20.98                                                  | 30.00       | PASS   |

**802.11g Ch0**

| CH | Freq. (MHz) | Data Rate | Power set | Peak Output Power (dBm) | Limit (dBm) | RESULT |
|----|-------------|-----------|-----------|-------------------------|-------------|--------|
| 1  | 2412        | 6         | 15.5      | 20.43                   | 30.00       | PASS   |
| 4  | 2427        | 6         | 20.5      | 25.71                   | 30.00       | PASS   |
| 6  | 2437        | 6         | 20.5      | 25.61                   | 30.00       | PASS   |
| 8  | 2447        | 6         | 20.5      | 25.72                   | 30.00       | PASS   |
| 11 | 2462        | 6         | 16        | 20.46                   | 30.00       | PASS   |

**802.11g Ch0**

| CH | Freq. (MHz) | Data Rate | Power set | Max. Avg. Output include tune up tolerance Power (dBm) | Limit (dBm) | RESULT |
|----|-------------|-----------|-----------|--------------------------------------------------------|-------------|--------|
| 1  | 2412        | 6         | 15.5      | 14.78                                                  | 30.00       | PASS   |
| 4  | 2427        | 6         | 20.5      | 19.98                                                  | 30.00       | PASS   |
| 6  | 2437        | 6         | 20.5      | 19.85                                                  | 30.00       | PASS   |
| 8  | 2447        | 6         | 20.5      | 19.96                                                  | 30.00       | PASS   |
| 11 | 2462        | 6         | 16        | 14.82                                                  | 30.00       | PASS   |

Unless otherwise stated the results shown in this test report refer only to the sample(s) tested and such sample(s) are retained for 90 days only.

除非另有說明，此報告結果僅對測試之樣品負責，同時此樣品僅保留90天。本報告未經本公司書面許可，不可部份複製。

This document is issued by the Company subject to its General Conditions of Service printed overleaf, available on request or accessible at <http://www.sgs.com.tw/Terms-and-Conditions> and for electronic format documents, subject to Terms and Conditions for Electronic Documents at <http://www.sgs.com.tw/Terms-and-Conditions>. Attention is drawn to the limitation of liability, indemnification and jurisdiction issues defined therein. Any holder of this document is advised that information contained hereon reflects the Company's findings at the time of its intervention only and within the limits of Client's instructions, if any. The Company's sole responsibility is to its Client and this document does not exonerate parties to a transaction from exercising all their rights and obligations under the transaction documents. This document cannot be reproduced except in full, without prior written approval of the Company. Any unauthorized alteration, forgery or falsification of the content or appearance of this document is unlawful and offenders may be prosecuted to the fullest extent of the law.

| 802.11g Ch1 |             |           |           |                         |             |        |
|-------------|-------------|-----------|-----------|-------------------------|-------------|--------|
| CH          | Freq. (MHz) | Data Rate | Power set | Peak Output Power (dBm) | Limit (dBm) | RESULT |
| 1           | 2412        | 6         | 15.5      | 20.30                   | 30.00       | PASS   |
| 4           | 2427        | 6         | 20.5      | 25.49                   | 30.00       | PASS   |
| 6           | 2437        | 6         | 20.5      | 25.21                   | 30.00       | PASS   |
| 8           | 2447        | 6         | 20.5      | 25.38                   | 30.00       | PASS   |
| 11          | 2462        | 6         | 16        | 20.17                   | 30.00       | PASS   |

| 802.11g Ch1 |             |           |           |                                                        |             |        |
|-------------|-------------|-----------|-----------|--------------------------------------------------------|-------------|--------|
| CH          | Freq. (MHz) | Data Rate | Power set | Max. Avg. Output include tune up tolerance Power (dBm) | Limit (dBm) | RESULT |
| 1           | 2412        | 6         | 15.5      | 14.61                                                  | 30.00       | PASS   |
| 4           | 2427        | 6         | 20.5      | 19.65                                                  | 30.00       | PASS   |
| 6           | 2437        | 6         | 20.5      | 19.52                                                  | 30.00       | PASS   |
| 8           | 2447        | 6         | 20.5      | 19.56                                                  | 30.00       | PASS   |
| 11          | 2462        | 6         | 16        | 14.55                                                  | 30.00       | PASS   |

**802.11g\_2TX**

| CH | Freq. (MHz) | Data Rate | Power set | Peak Output Power |       | Total Peak Output Power (dBm) | Limit (dBm) | RESULT |
|----|-------------|-----------|-----------|-------------------|-------|-------------------------------|-------------|--------|
|    |             |           |           | Ch0               | Ch1   |                               |             |        |
| 1  | 2412        | 6         | 15.5      | 20.48             | 20.38 | 23.44                         | 30.00       | PASS   |
| 4  | 2427        | 6         | 20.5      | 25.78             | 25.68 | <b>28.74</b>                  | 30.00       | PASS   |
| 6  | 2437        | 6         | 20.5      | 25.63             | 25.27 | 28.46                         | 30.00       | PASS   |
| 8  | 2447        | 6         | 20.5      | 25.83             | 25.41 | 28.64                         | 30.00       | PASS   |
| 11 | 2462        | 6         | 15.5      | 20.47             | 20.25 | 23.37                         | 30.00       | PASS   |

**802.11g\_2TX**

| CH | Freq. (MHz) | Data Rate | Power set | Avg. Output Power (dBm) |       | Max. Avg. Output include tune up tolerance Power (dBm) | Limit (dBm) | RESULT |
|----|-------------|-----------|-----------|-------------------------|-------|--------------------------------------------------------|-------------|--------|
|    |             |           |           | Ch0                     | Ch1   |                                                        |             |        |
| 1  | 2412        | 6         | 15.5      | 14.79                   | 14.66 | 17.74                                                  | 30.00       | PASS   |
| 4  | 2427        | 6         | 20.5      | 19.99                   | 19.85 | <b>22.93</b>                                           | 30.00       | PASS   |
| 6  | 2437        | 6         | 20.5      | 19.88                   | 19.55 | 22.73                                                  | 30.00       | PASS   |
| 8  | 2447        | 6         | 20.5      | 19.98                   | 19.59 | 22.80                                                  | 30.00       | PASS   |
| 11 | 2462        | 6         | 15.5      | 14.88                   | 14.58 | 17.75                                                  | 30.00       | PASS   |

Unless otherwise stated the results shown in this test report refer only to the sample(s) tested and such sample(s) are retained for 90 days only.

除非另有說明，此報告結果僅對測試之樣品負責，同時此樣品僅保留90天。本報告未經本公司書面許可，不可部份複製。

This document is issued by the Company subject to its General Conditions of Service printed overleaf, available on request or accessible at <http://www.sgs.com.tw/Terms-and-Conditions> and for electronic format documents, subject to Terms and Conditions for Electronic Documents at <http://www.sgs.com.tw/Terms-and-Conditions>. Attention is drawn to the limitation of liability, indemnification and jurisdiction issues defined therein. Any holder of this document is advised that information contained herein reflects the Company's findings at the time of its intervention only and within the limits of Client's instructions, if any. The Company's sole responsibility is to its Client and this document does not exonerate parties to a transaction from exercising all their rights and obligations under the transaction documents. This document cannot be reproduced except in full, without prior written approval of the Company. Any unauthorized alteration, forgery or falsification of the content or appearance of this document is unlawful and offenders may be prosecuted to the fullest extent of the law.

| 802.11n_HT_20M Ch0 |             |           |           |                                                        |             |        |
|--------------------|-------------|-----------|-----------|--------------------------------------------------------|-------------|--------|
| CH                 | Freq. (MHz) | Data Rate | Power set | Peak Output Power (dBm)                                | Limit (dBm) | RESULT |
| 1                  | 2412        | MCS0      | 16        | 21.10                                                  | 30.00       | PASS   |
| 4                  | 2427        | MCS0      | 21        | 26.40                                                  | 30.00       | PASS   |
| 6                  | 2437        | MCS0      | 21        | 26.37                                                  | 30.00       | PASS   |
| 8                  | 2447        | MCS0      | 21        | 26.39                                                  | 30.00       | PASS   |
| 11                 | 2462        | MCS0      | 16        | 20.83                                                  | 30.00       | PASS   |
| 802.11n_HT_20M Ch0 |             |           |           |                                                        |             |        |
| CH                 | Freq. (MHz) | Data Rate | Power set | Max. Avg. Output include tune up tolerance Power (dBm) | Limit (dBm) | RESULT |
| 1                  | 2412        | MCS0      | 16        | 14.98                                                  | 30.00       | PASS   |
| 4                  | 2427        | MCS0      | 21        | 19.98                                                  | 30.00       | PASS   |
| 6                  | 2437        | MCS0      | 21        | 19.96                                                  | 30.00       | PASS   |
| 8                  | 2447        | MCS0      | 21        | 19.97                                                  | 30.00       | PASS   |
| 11                 | 2462        | MCS0      | 16        | 14.71                                                  | 30.00       | PASS   |
| 802.11n_HT_20M Ch1 |             |           |           |                                                        |             |        |
| CH                 | Freq. (MHz) | Data Rate | Power set | Peak Output Power (dBm)                                | Limit (dBm) | RESULT |
| 1                  | 2412        | MCS0      | 16        | 20.69                                                  | 30.00       | PASS   |
| 4                  | 2427        | MCS0      | 21        | 25.88                                                  | 30.00       | PASS   |
| 6                  | 2437        | MCS0      | 21        | 25.82                                                  | 30.00       | PASS   |
| 8                  | 2447        | MCS0      | 21        | 25.86                                                  | 30.00       | PASS   |
| 11                 | 2462        | MCS0      | 16        | 20.64                                                  | 30.00       | PASS   |
| 802.11n_HT_20M Ch1 |             |           |           |                                                        |             |        |
| CH                 | Freq. (MHz) | Data Rate | Power set | Max. Avg. Output include tune up tolerance Power (dBm) | Limit (dBm) | RESULT |
| 1                  | 2412        | MCS0      | 16        | 14.67                                                  | 30.00       | PASS   |
| 4                  | 2427        | MCS0      | 21        | 19.91                                                  | 30.00       | PASS   |
| 6                  | 2437        | MCS0      | 21        | 19.54                                                  | 30.00       | PASS   |
| 8                  | 2447        | MCS0      | 21        | 19.67                                                  | 30.00       | PASS   |
| 11                 | 2462        | MCS0      | 16        | 14.51                                                  | 30.00       | PASS   |

Unless otherwise stated the results shown in this test report refer only to the sample(s) tested and such sample(s) are retained for 90 days only.

除非另有說明，此報告結果僅對測試之樣品負責，同時此樣品僅保留90天。本報告未經本公司書面許可，不可部份複製。

This document is issued by the Company subject to its General Conditions of Service printed overleaf, available on request or accessible at <http://www.sgs.com.tw/Terms-and-Conditions> and for electronic format documents, subject to Terms and Conditions for Electronic Documents at <http://www.sgs.com.tw/Terms-and-Conditions>. Attention is drawn to the limitation of liability, indemnification and jurisdiction issues defined therein. Any holder of this document is advised that information contained hereon reflects the Company's findings at the time of its intervention only and within the limits of Client's instructions, if any. The Company's sole responsibility is to its Client and this document does not exonerate parties to a transaction from exercising all their rights and obligations under the transaction documents. This document cannot be reproduced except in full, without prior written approval of the Company. Any unauthorized alteration, forgery or falsification of the content or appearance of this document is unlawful and offenders may be prosecuted to the fullest extent of the law.

**802.11n\_HT20M\_2TX**

| CH | Freq. (MHz) | Data Rate | Power set | Peak Output Power |       | Total Peak Output Power (dBm) | Limit (dBm) | RESULT |
|----|-------------|-----------|-----------|-------------------|-------|-------------------------------|-------------|--------|
|    |             |           |           | Ch0               | Ch1   |                               |             |        |
| 1  | 2412        | MCS0      | 16        | 21.15             | 20.73 | 23.96                         | 30.00       | PASS   |
| 4  | 2427        | MCS0      | 21        | 26.42             | 26.23 | <b>29.34</b>                  | 30.00       | PASS   |
| 6  | 2437        | MCS0      | 21        | 26.38             | 25.87 | 29.14                         | 30.00       | PASS   |
| 8  | 2447        | MCS0      | 21        | 26.48             | 25.91 | 29.21                         | 30.00       | PASS   |
| 11 | 2462        | MCS0      | 16.5      | 21.13             | 20.89 | 24.02                         | 30.00       | PASS   |

**802.11n\_HT20M\_2TX**

| CH | Freq. (MHz) | Data Rate | Power set | Avg. Output Power (dBm) |       | Max. Avg. Output include tune up tolerance Power (dBm) | Limit (dBm) | RESULT |
|----|-------------|-----------|-----------|-------------------------|-------|--------------------------------------------------------|-------------|--------|
|    |             |           |           | Ch0                     | Ch1   |                                                        |             |        |
| 1  | 2412        | MCS0      | 16        | 15.00                   | 14.81 | 17.91                                                  | 30.00       | PASS   |
| 4  | 2427        | MCS0      | 21        | 20.00                   | 19.94 | <b>22.98</b>                                           | 30.00       | PASS   |
| 6  | 2437        | MCS0      | 21        | 20.02                   | 19.55 | 22.80                                                  | 30.00       | PASS   |
| 8  | 2447        | MCS0      | 21        | 20.03                   | 19.84 | 22.94                                                  | 30.00       | PASS   |
| 11 | 2462        | MCS0      | 16.5      | 15.09                   | 14.74 | 17.93                                                  | 30.00       | PASS   |

**802.11n\_HT\_40M Ch0**

| CH | Freq. (MHz) | Data Rate | Power set | Peak Output Power (dBm) | Limit (dBm) | RESULT |
|----|-------------|-----------|-----------|-------------------------|-------------|--------|
| 3  | 2422        | MCS0      | 13.5      | 18.85                   | 30.00       | PASS   |
| 5  | 2432        | MCS0      | 20        | 25.92                   | 30.00       | PASS   |
| 6  | 2437        | MCS0      | 20        | 25.84                   | 30.00       | PASS   |
| 7  | 2442        | MCS0      | 20        | 25.89                   | 30.00       | PASS   |
| 9  | 2452        | MCS0      | 13.5      | 18.53                   | 30.00       | PASS   |

**802.11n\_HT\_40M Ch0**

| CH | Freq. (MHz) | Data Rate | Power set | Max. Avg. Output include tune up tolerance Power (dBm) | Limit (dBm) | RESULT |
|----|-------------|-----------|-----------|--------------------------------------------------------|-------------|--------|
| 3  | 2422        | MCS0      | 13.5      | 12.86                                                  | 30.00       | PASS   |
| 5  | 2432        | MCS0      | 20        | 19.84                                                  | 30.00       | PASS   |
| 6  | 2437        | MCS0      | 20        | 19.74                                                  | 30.00       | PASS   |
| 7  | 2442        | MCS0      | 20        | 19.82                                                  | 30.00       | PASS   |
| 9  | 2452        | MCS0      | 13.5      | 12.75                                                  | 30.00       | PASS   |

Unless otherwise stated the results shown in this test report refer only to the sample(s) tested and such sample(s) are retained for 90 days only.

除非另有說明，此報告結果僅對測試之樣品負責，同時此樣品僅保留90天。本報告未經本公司書面許可，不可部份複製。

This document is issued by the Company subject to its General Conditions of Service printed overleaf, available on request or accessible at <http://www.sgs.com.tw/Terms-and-Conditions> and for electronic format documents, subject to Terms and Conditions for Electronic Documents at <http://www.sgs.com.tw/Terms-and-Conditions>. Attention is drawn to the limitation of liability, indemnification and jurisdiction issues defined therein. Any holder of this document is advised that information contained hereon reflects the Company's findings at the time of its intervention only and within the limits of Client's instructions, if any. The Company's sole responsibility is to its Client and this document does not exonerate parties to a transaction from exercising all their rights and obligations under the transaction documents. This document cannot be reproduced except in full, without prior written approval of the Company. Any unauthorized alteration, forgery or falsification of the content or appearance of this document is unlawful and offenders may be prosecuted to the fullest extent of the law.

| 802.11n_HT_40M Ch1 |             |           |           |                                                        |             |        |
|--------------------|-------------|-----------|-----------|--------------------------------------------------------|-------------|--------|
| CH                 | Freq. (MHz) | Data Rate | Power set | Peak Output Power (dBm)                                | Limit (dBm) | RESULT |
| 3                  | 2422        | MCS0      | 13.5      | 18.39                                                  | 30.00       | PASS   |
| 5                  | 2432        | MCS0      | 20.5      | 25.81                                                  | 30.00       | PASS   |
| 6                  | 2437        | MCS0      | 20.5      | 25.61                                                  | 30.00       | PASS   |
| 7                  | 2442        | MCS0      | 20.5      | 25.73                                                  | 30.00       | PASS   |
| 9                  | 2452        | MCS0      | 13.5      | 18.49                                                  | 30.00       | PASS   |
| 802.11n_HT_40M Ch1 |             |           |           |                                                        |             |        |
| CH                 | Freq. (MHz) | Data Rate | Power set | Max. Avg. Output include tune up tolerance Power (dBm) | Limit (dBm) | RESULT |
| 3                  | 2422        | MCS0      | 13.5      | 12.58                                                  | 30.00       | PASS   |
| 5                  | 2432        | MCS0      | 20.5      | 19.81                                                  | 30.00       | PASS   |
| 6                  | 2437        | MCS0      | 20.5      | 19.55                                                  | 30.00       | PASS   |
| 7                  | 2442        | MCS0      | 20.5      | 19.61                                                  | 30.00       | PASS   |
| 9                  | 2452        | MCS0      | 13.5      | 12.54                                                  | 30.00       | PASS   |

| 802.11n_HT40M_2TX |             |           |           |                         |       |                                                        |             |        |
|-------------------|-------------|-----------|-----------|-------------------------|-------|--------------------------------------------------------|-------------|--------|
| CH                | Freq. (MHz) | Data Rate | Power set | Peak Output Power       |       | Total Peak Output Power (dBm)                          | Limit (dBm) | RESULT |
|                   |             |           |           | Ch0                     | Ch1   |                                                        |             |        |
| 3                 | 2422        | MCS0      | 13.5      | 18.89                   | 18.93 | 21.92                                                  | 30.00       | PASS   |
| 5                 | 2432        | MCS0      | 18        | 24.85                   | 24.39 | 27.64                                                  | 30.00       | PASS   |
| 6                 | 2437        | MCS0      | 19        | 25.73                   | 25.18 | 28.47                                                  | 30.00       | PASS   |
| 7                 | 2442        | MCS0      | 20.5      | 26.10                   | 25.98 | <b>29.05</b>                                           | 30.00       | PASS   |
| 9                 | 2452        | MCS0      | 13.5      | 18.79                   | 18.82 | 21.82                                                  | 30.00       | PASS   |
| 802.11n_HT40M_2TX |             |           |           |                         |       |                                                        |             |        |
| CH                | Freq. (MHz) | Data Rate | Power set | Avg. Output Power (dBm) |       | Max. Avg. Output include tune up tolerance Power (dBm) | Limit (dBm) | RESULT |
|                   |             |           |           | Ch0                     | Ch1   |                                                        |             |        |
| 3                 | 2422        | MCS0      | 13.5      | 12.93                   | 12.80 | 15.88                                                  | 30.00       | PASS   |
| 5                 | 2432        | MCS0      | 18        | 18.25                   | 17.68 | 20.98                                                  | 30.00       | PASS   |
| 6                 | 2437        | MCS0      | 19        | 19.25                   | 18.49 | 21.90                                                  | 30.00       | PASS   |
| 7                 | 2442        | MCS0      | 20.5      | 20.00                   | 19.82 | <b>22.92</b>                                           | 30.00       | PASS   |
| 9                 | 2452        | MCS0      | 13.5      | 13.18                   | 12.74 | 15.98                                                  | 30.00       | PASS   |

Unless otherwise stated the results shown in this test report refer only to the sample(s) tested and such sample(s) are retained for 90 days only.

除非另有說明，此報告結果僅對測試之樣品負責，同時此樣品僅保留90天。本報告未經本公司書面許可，不可部份複製。

This document is issued by the Company subject to its General Conditions of Service printed overleaf, available on request or accessible at <http://www.sgs.com.tw/Terms-and-Conditions> and for electronic format documents, subject to Terms and Conditions for Electronic Documents at <http://www.sgs.com.tw/Terms-and-Conditions>. Attention is drawn to the limitation of liability, indemnification and jurisdiction issues defined therein. Any holder of this document is advised that information contained herein reflects the Company's findings at the time of its intervention only and within the limits of Client's instructions, if any. The Company's sole responsibility is to its Client and this document does not exonerate parties to a transaction from exercising all their rights and obligations under the transaction documents. This document cannot be reproduced except in full, without prior written approval of the Company. Any unauthorized alteration, forgery or falsification of the content or appearance of this document is unlawful and offenders may be prosecuted to the fullest extent of the law.

**802.11ax\_HE\_20M Ch0**

| CH | Freq. (MHz) | Data Rate | RU Config | Power set | Peak Output Power (dBm) | Limit (dBm) | RESULT |
|----|-------------|-----------|-----------|-----------|-------------------------|-------------|--------|
| 1  | 2412        | MCS0      | full      | 16        | 21.61                   | 30.00       | PASS   |
| 4  | 2427        | MCS0      | full      | 20.5      | 26.82                   | 30.00       | PASS   |
| 6  | 2437        | MCS0      | full      | 21        | 26.62                   | 30.00       | PASS   |
| 8  | 2447        | MCS0      | full      | 21        | 26.99                   | 30.00       | PASS   |
| 11 | 2462        | MCS0      | full      | 16        | 21.72                   | 30.00       | PASS   |

**802.11ax\_HE\_20M Ch0**

| CH | Freq. (MHz) | Data Rate | RU Config | Power set | Max. Avg. Output include tune up tolerance Power (dBm) | Limit (dBm) | RESULT |
|----|-------------|-----------|-----------|-----------|--------------------------------------------------------|-------------|--------|
| 1  | 2412        | MCS0      | full      | 16        | 14.83                                                  | 30.00       | PASS   |
| 4  | 2427        | MCS0      | full      | 20.5      | 19.93                                                  | 30.00       | PASS   |
| 6  | 2437        | MCS0      | full      | 21        | 19.77                                                  | 30.00       | PASS   |
| 8  | 2447        | MCS0      | full      | 21        | 19.98                                                  | 30.00       | PASS   |
| 11 | 2462        | MCS0      | full      | 16        | 14.73                                                  | 30.00       | PASS   |

**802.11ax\_HE\_20M Ch1**

| CH | Freq. (MHz) | Data Rate | RU Config | Power set | Peak Output Power (dBm) | Limit (dBm) | RESULT |
|----|-------------|-----------|-----------|-----------|-------------------------|-------------|--------|
| 1  | 2412        | MCS0      | full      | 16        | 21.35                   | 30.00       | PASS   |
| 4  | 2427        | MCS0      | full      | 21        | 26.54                   | 30.00       | PASS   |
| 6  | 2437        | MCS0      | full      | 21.5      | 26.09                   | 30.00       | PASS   |
| 8  | 2447        | MCS0      | full      | 21.5      | 26.41                   | 30.00       | PASS   |
| 11 | 2462        | MCS0      | full      | 16.5      | 21.39                   | 30.00       | PASS   |

**802.11ax\_HE\_20M Ch1**

| CH | Freq. (MHz) | Data Rate | RU Config | Power set | Max. Avg. Output include tune up tolerance Power (dBm) | Limit (dBm) | RESULT |
|----|-------------|-----------|-----------|-----------|--------------------------------------------------------|-------------|--------|
| 1  | 2412        | MCS0      | full      | 16        | 14.61                                                  | 30.00       | PASS   |
| 4  | 2427        | MCS0      | full      | 21        | 19.72                                                  | 30.00       | PASS   |
| 6  | 2437        | MCS0      | full      | 21.5      | 19.67                                                  | 30.00       | PASS   |
| 8  | 2447        | MCS0      | full      | 21.5      | 19.87                                                  | 30.00       | PASS   |
| 11 | 2462        | MCS0      | full      | 16.5      | 14.65                                                  | 30.00       | PASS   |

Unless otherwise stated the results shown in this test report refer only to the sample(s) tested and such sample(s) are retained for 90 days only.

除非另有說明，此報告結果僅對測試之樣品負責，同時此樣品僅保留90天。本報告未經本公司書面許可，不可部份複製。

This document is issued by the Company subject to its General Conditions of Service printed overleaf, available on request or accessible at <http://www.sgs.com.tw/Terms-and-Conditions> and for electronic format documents, subject to Terms and Conditions for Electronic Documents at <http://www.sgs.com.tw/Terms-and-Conditions>. Attention is drawn to the limitation of liability, indemnification and jurisdiction issues defined therein. Any holder of this document is advised that information contained hereon reflects the Company's findings at the time of its intervention only and within the limits of Client's instructions, if any. The Company's sole responsibility is to its Client and this document does not exonerate parties to a transaction from exercising all their rights and obligations under the transaction documents. This document cannot be reproduced except in full, without prior written approval of the Company. Any unauthorized alteration, forgery or falsification of the content or appearance of this document is unlawful and offenders may be prosecuted to the fullest extent of the law.



**802.11ax\_HE20M\_2TX**

| CH | Freq. (MHz) | Data Rate | RU Config | Power set | Peak Output Power |       | Total Peak Output Power (dBm) | Limit (dBm) | RESULT |
|----|-------------|-----------|-----------|-----------|-------------------|-------|-------------------------------|-------------|--------|
|    |             |           |           |           | Ch0               | Ch1   |                               |             |        |
| 1  | 2412        | MCS0      | full      | 16        | 21.98             | 21.39 | 24.71                         | 30.00       | PASS   |
| 4  | 2427        | MCS0      | full      | 21        | 26.93             | 26.76 | <b>29.86</b>                  | 30.00       | PASS   |
| 6  | 2437        | MCS0      | full      | 21        | 26.79             | 26.39 | 29.60                         | 30.00       | PASS   |
| 8  | 2447        | MCS0      | full      | 21        | 27.01             | 26.54 | 29.79                         | 30.00       | PASS   |
| 11 | 2462        | MCS0      | full      | 16.5      | 21.86             | 21.44 | 24.67                         | 30.00       | PASS   |

**802.11ax\_HE20M\_2TX**

| CH | Freq. (MHz) | Data Rate | RU Config | Power set | Avg. Output Power (dBm) |       | Max. Avg. Output include tune up tolerance Power (dBm) | Limit (dBm) | RESULT |
|----|-------------|-----------|-----------|-----------|-------------------------|-------|--------------------------------------------------------|-------------|--------|
|    |             |           |           |           | Ch0                     | Ch1   |                                                        |             |        |
| 1  | 2412        | MCS0      | full      | 16        | 15.17                   | 14.73 | 17.97                                                  | 30.00       | PASS   |
| 4  | 2427        | MCS0      | full      | 21        | 20.11                   | 19.76 | 22.95                                                  | 30.00       | PASS   |
| 6  | 2437        | MCS0      | full      | 21        | 20.00                   | 19.69 | 22.86                                                  | 30.00       | PASS   |
| 8  | 2447        | MCS0      | full      | 21        | 20.06                   | 19.90 | <b>22.99</b>                                           | 30.00       | PASS   |
| 11 | 2462        | MCS0      | full      | 16.5      | 15.01                   | 14.84 | 17.94                                                  | 30.00       | PASS   |

**802.11ax\_HE\_40M Ch0**

| CH | Freq. (MHz) | Data Rate | RU Config | Power set | Peak Output Power (dBm) | Limit (dBm) | RESULT |
|----|-------------|-----------|-----------|-----------|-------------------------|-------------|--------|
| 3  | 2422        | MCS0      | full      | 14        | 19.67                   | 30.00       | PASS   |
| 5  | 2432        | MCS0      | full      | 20.5      | 26.72                   | 30.00       | PASS   |
| 6  | 2437        | MCS0      | full      | 20.5      | 26.63                   | 30.00       | PASS   |
| 7  | 2442        | MCS0      | full      | 20.5      | 26.68                   | 30.00       | PASS   |
| 9  | 2452        | MCS0      | full      | 14        | 19.46                   | 30.00       | PASS   |

**802.11ax\_HE\_40M Ch0**

| CH | Freq. (MHz) | Data Rate | RU Config | Power set | Max. Avg. Output include tune up tolerance Power (dBm) | Limit (dBm) | RESULT |
|----|-------------|-----------|-----------|-----------|--------------------------------------------------------|-------------|--------|
| 3  | 2422        | MCS0      | full      | 14        | 12.91                                                  | 30.00       | PASS   |
| 5  | 2432        | MCS0      | full      | 20.5      | 19.85                                                  | 30.00       | PASS   |
| 6  | 2437        | MCS0      | full      | 20.5      | 19.84                                                  | 30.00       | PASS   |
| 7  | 2442        | MCS0      | full      | 20.5      | 19.99                                                  | 30.00       | PASS   |
| 9  | 2452        | MCS0      | full      | 14        | 12.96                                                  | 30.00       | PASS   |

Unless otherwise stated the results shown in this test report refer only to the sample(s) tested and such sample(s) are retained for 90 days only.

除非另有說明，此報告結果僅對測試之樣品負責，同時此樣品僅保留90天。本報告未經本公司書面許可，不可部份複製。

This document is issued by the Company subject to its General Conditions of Service printed overleaf, available on request or accessible at <http://www.sgs.com.tw/Terms-and-Conditions> and for electronic format documents, subject to Terms and Conditions for Electronic Documents at <http://www.sgs.com.tw/Terms-and-Conditions>. Attention is drawn to the limitation of liability, indemnification and jurisdiction issues defined therein. Any holder of this document is advised that information contained hereon reflects the Company's findings at the time of its intervention only and within the limits of Client's instructions, if any. The Company's sole responsibility is to its Client and this document does not exonerate parties to a transaction from exercising all their rights and obligations under the transaction documents. This document cannot be reproduced except in full, without prior written approval of the Company. Any unauthorized alteration, forgery or falsification of the content or appearance of this document is unlawful and offenders may be prosecuted to the fullest extent of the law.

| 802.11ax_HE_40M Ch1 |             |           |           |           |                         |             |        |
|---------------------|-------------|-----------|-----------|-----------|-------------------------|-------------|--------|
| CH                  | Freq. (MHz) | Data Rate | RU Config | Power set | Peak Output Power (dBm) | Limit (dBm) | RESULT |
| 3                   | 2422        | MCS0      | full      | 14        | 11.68                   | 30.00       | PASS   |
| 5                   | 2432        | MCS0      | full      | 21        | 26.52                   | 30.00       | PASS   |
| 6                   | 2437        | MCS0      | full      | 21        | 26.48                   | 30.00       | PASS   |
| 7                   | 2442        | MCS0      | full      | 21        | 26.62                   | 30.00       | PASS   |
| 9                   | 2452        | MCS0      | full      | 14        | 19.40                   | 30.00       | PASS   |

| 802.11ax_HE_40M Ch1 |             |           |           |           |                                                        |             |        |
|---------------------|-------------|-----------|-----------|-----------|--------------------------------------------------------|-------------|--------|
| CH                  | Freq. (MHz) | Data Rate | RU Config | Power set | Max. Avg. Output include tune up tolerance Power (dBm) | Limit (dBm) | RESULT |
| 3                   | 2422        | MCS0      | full      | 14        | 12.58                                                  | 30.00       | PASS   |
| 5                   | 2432        | MCS0      | full      | 21        | 19.57                                                  | 30.00       | PASS   |
| 6                   | 2437        | MCS0      | full      | 21        | 19.52                                                  | 30.00       | PASS   |
| 7                   | 2442        | MCS0      | full      | 21        | 19.69                                                  | 30.00       | PASS   |
| 9                   | 2452        | MCS0      | full      | 14        | 12.73                                                  | 30.00       | PASS   |

802.11ax\_HE40M\_2TX

| CH | Freq. (MHz) | Data Rate | RU Config | Power set | Peak Output Power |       | Total Peak Output Power (dBm) | Limit (dBm) | RESULT |
|----|-------------|-----------|-----------|-----------|-------------------|-------|-------------------------------|-------------|--------|
|    |             |           |           |           | Ch0               | Ch1   |                               |             |        |
| 3  | 2422        | MCS0      | full      | 13.5      | 18.93             | 18.82 | 21.89                         | 30.00       | PASS   |
| 5  | 2432        | MCS0      | full      | 18.5      | 25.05             | 24.71 | 27.89                         | 30.00       | PASS   |
| 6  | 2437        | MCS0      | full      | 19        | 25.62             | 25.11 | 28.38                         | 30.00       | PASS   |
| 7  | 2442        | MCS0      | full      | 20.5      | 26.61             | 26.49 | <b>29.56</b>                  | 30.00       | PASS   |
| 9  | 2452        | MCS0      | full      | 13.5      | 18.83             | 18.76 | 21.81                         | 30.00       | PASS   |

802.11ax\_HE40M\_2TX

| CH | Freq. (MHz) | Data Rate | RU Config | Power set | Avg. Output Power (dBm) |       | Max. Avg. Output include tune up tolerance Power (dBm) | Limit (dBm) | RESULT |
|----|-------------|-----------|-----------|-----------|-------------------------|-------|--------------------------------------------------------|-------------|--------|
|    |             |           |           |           | Ch0                     | Ch1   |                                                        |             |        |
| 3  | 2422        | MCS0      | full      | 13.5      | 13.08                   | 12.73 | 15.92                                                  | 30.00       | PASS   |
| 5  | 2432        | MCS0      | full      | 18.5      | 18.23                   | 17.85 | 21.05                                                  | 30.00       | PASS   |
| 6  | 2437        | MCS0      | full      | 19        | 18.79                   | 18.09 | 21.46                                                  | 30.00       | PASS   |
| 7  | 2442        | MCS0      | full      | 20.5      | 19.62                   | 19.28 | <b>22.46</b>                                           | 30.00       | PASS   |
| 9  | 2452        | MCS0      | full      | 13.5      | 13.04                   | 12.67 | 15.87                                                  | 30.00       | PASS   |

Unless otherwise stated the results shown in this test report refer only to the sample(s) tested and such sample(s) are retained for 90 days only.

除非另有說明，此報告結果僅對測試之樣品負責，同時此樣品僅保留90天。本報告未經本公司書面許可，不可部份複製。

This document is issued by the Company subject to its General Conditions of Service printed overleaf, available on request or accessible at <http://www.sgs.com.tw/Terms-and-Conditions> and for electronic format documents, subject to Terms and Conditions for Electronic Documents at <http://www.sgs.com.tw/Terms-and-Conditions>. Attention is drawn to the limitation of liability, indemnification and jurisdiction issues defined therein. Any holder of this document is advised that information contained herein reflects the Company's findings at the time of its intervention only and within the limits of Client's instructions, if any. The Company's sole responsibility is to its Client and this document does not exonerate parties to a transaction from exercising all their rights and obligations under the transaction documents. This document cannot be reproduced except in full, without prior written approval of the Company. Any unauthorized alteration, forgery or falsification of the content or appearance of this document is unlawful and offenders may be prosecuted to the fullest extent of the law.

| 802.11b Ch0 |             |           |                         |                    |            |             |        |
|-------------|-------------|-----------|-------------------------|--------------------|------------|-------------|--------|
| CH          | Freq. (MHz) | Data Rate | Avg. Output Power (dBm) | Antenna Gain (dBi) | EIRP (dBm) | Limit (dBm) | RESULT |
| 1           | 2412        | 1         | 17.68                   | 1.20               | 18.88      | 36          | PASS   |
| 4           | 2427        | 1         | 19.78                   | 1.20               | 20.98      | 36          | PASS   |
| 6           | 2437        | 1         | 19.63                   | 1.20               | 20.83      | 36          | PASS   |
| 8           | 2447        | 1         | 19.75                   | 1.20               | 20.95      | 36          | PASS   |
| 11          | 2462        | 1         | 17.95                   | 1.20               | 19.15      | 36          | PASS   |

| 802.11b Ch1 |             |           |                         |                    |            |             |        |
|-------------|-------------|-----------|-------------------------|--------------------|------------|-------------|--------|
| CH          | Freq. (MHz) | Data Rate | Avg. Output Power (dBm) | Antenna Gain (dBi) | EIRP (dBm) | Limit (dBm) | RESULT |
| 1           | 2412        | 1         | 17.61                   | 1.20               | 18.81      | 36          | PASS   |
| 4           | 2427        | 1         | 19.68                   | 1.20               | 20.88      | 36          | PASS   |
| 6           | 2437        | 1         | 19.54                   | 1.20               | 20.74      | 36          | PASS   |
| 8           | 2447        | 1         | 19.56                   | 1.20               | 20.76      | 36          | PASS   |
| 11          | 2462        | 1         | 17.85                   | 1.20               | 19.05      | 36          | PASS   |

| 802.11b_2TX |             |           |                   |       |                               |                    |              |             |        |
|-------------|-------------|-----------|-------------------|-------|-------------------------------|--------------------|--------------|-------------|--------|
| CH          | Freq. (MHz) | Data Rate | Avg. Output Power |       | Total Avg. Output Power (dBm) | Antenna Gain (dBi) | EIRP (dBm)   | Limit (dBm) | RESULT |
|             |             |           | Ch0               | Ch1   |                               |                    |              |             |        |
| 1           | 2412        | 1         | 18.04             | 17.89 | 20.97                         | 4.21               | 25.18        | 36          | PASS   |
| 4           | 2427        | 1         | 20.03             | 19.89 | 22.97                         | 4.21               | <b>27.18</b> | 36          | PASS   |
| 6           | 2437        | 1         | 19.81             | 19.67 | 22.75                         | 4.21               | 26.96        | 36          | PASS   |
| 8           | 2447        | 1         | 19.88             | 19.75 | 22.82                         | 4.21               | 27.03        | 36          | PASS   |
| 11          | 2462        | 1         | 17.98             | 17.97 | 20.98                         | 4.21               | 25.19        | 36          | PASS   |

| 802.11g Ch0 |             |           |                         |                    |            |             |        |
|-------------|-------------|-----------|-------------------------|--------------------|------------|-------------|--------|
| CH          | Freq. (MHz) | Data Rate | Avg. Output Power (dBm) | Antenna Gain (dBi) | EIRP (dBm) | Limit (dBm) | RESULT |
| 1           | 2412        | 6         | 14.78                   | 1.20               | 15.98      | 36          | PASS   |
| 4           | 2427        | 6         | 19.98                   | 1.20               | 21.18      | 36          | PASS   |
| 6           | 2437        | 6         | 19.85                   | 1.20               | 21.05      | 36          | PASS   |
| 8           | 2447        | 6         | 19.96                   | 1.20               | 21.16      | 36          | PASS   |
| 11          | 2462        | 6         | 14.82                   | 1.20               | 16.02      | 36          | PASS   |

Unless otherwise stated the results shown in this test report refer only to the sample(s) tested and such sample(s) are retained for 90 days only.

除非另有說明，此報告結果僅對測試之樣品負責，同時此樣品僅保留90天。本報告未經本公司書面許可，不可部份複製。

This document is issued by the Company subject to its General Conditions of Service printed overleaf, available on request or accessible at <http://www.sgs.com.tw/Terms-and-Conditions> and for electronic format documents, subject to Terms and Conditions for Electronic Documents at <http://www.sgs.com.tw/Terms-and-Conditions>. Attention is drawn to the limitation of liability, indemnification and jurisdiction issues defined therein. Any holder of this document is advised that information contained hereon reflects the Company's findings at the time of its intervention only and within the limits of Client's instructions, if any. The Company's sole responsibility is to its Client and this document does not exonerate parties to a transaction from exercising all their rights and obligations under the transaction documents. This document cannot be reproduced except in full, without prior written approval of the Company. Any unauthorized alteration, forgery or falsification of the content or appearance of this document is unlawful and offenders may be prosecuted to the fullest extent of the law.

| 802.11g Ch1 |             |           |                         |                    |            |             |        |
|-------------|-------------|-----------|-------------------------|--------------------|------------|-------------|--------|
| CH          | Freq. (MHz) | Data Rate | Avg. Output Power (dBm) | Antenna Gain (dBi) | EIRP (dBm) | Limit (dBm) | RESULT |
| 1           | 2412        | 6         | 14.61                   | 1.20               | 15.81      | 36          | PASS   |
| 4           | 2427        | 6         | 19.65                   | 1.20               | 20.85      | 36          | PASS   |
| 6           | 2437        | 6         | 19.52                   | 1.20               | 20.72      | 36          | PASS   |
| 8           | 2447        | 6         | 19.56                   | 1.20               | 20.76      | 36          | PASS   |
| 11          | 2462        | 6         | 14.55                   | 1.20               | 15.75      | 36          | PASS   |

| 802.11g_2TX |             |           |                   |       |                               |                    |            |             |        |
|-------------|-------------|-----------|-------------------|-------|-------------------------------|--------------------|------------|-------------|--------|
| CH          | Freq. (MHz) | Data Rate | Avg. Output Power |       | Total Avg. Output Power (dBm) | Antenna Gain (dBi) | EIRP (dBm) | Limit (dBm) | RESULT |
|             |             |           | Ch0               | Ch1   |                               |                    |            |             |        |
| 1           | 2412        | 6         | 14.79             | 14.66 | 17.74                         | 4.21               | 21.95      | 36          | PASS   |
| 4           | 2427        | 6         | 19.99             | 19.85 | 22.93                         | 4.21               | 27.14      | 36          | PASS   |
| 6           | 2437        | 6         | 19.88             | 19.55 | 22.73                         | 4.21               | 26.94      | 36          | PASS   |
| 8           | 2447        | 6         | 19.98             | 19.59 | 22.80                         | 4.21               | 27.01      | 36          | PASS   |
| 11          | 2462        | 6         | 14.88             | 14.58 | 17.75                         | 4.21               | 21.96      | 36          | PASS   |

| 802.11n_HT_20M Ch0 |             |           |                         |                    |            |             |        |
|--------------------|-------------|-----------|-------------------------|--------------------|------------|-------------|--------|
| CH                 | Freq. (MHz) | Data Rate | Avg. Output Power (dBm) | Antenna Gain (dBi) | EIRP (dBm) | Limit (dBm) | RESULT |
| 1                  | 2412        | MCS0      | 14.98                   | 1.20               | 16.18      | 36          | PASS   |
| 4                  | 2427        | MCS0      | 19.98                   | 1.20               | 21.18      | 36          | PASS   |
| 6                  | 2437        | MCS0      | 19.96                   | 1.20               | 21.16      | 36          | PASS   |
| 8                  | 2447        | MCS0      | 19.97                   | 1.20               | 21.17      | 36          | PASS   |
| 11                 | 2462        | MCS0      | 14.71                   | 1.20               | 15.91      | 36          | PASS   |

| 802.11n_HT_20M Ch1 |             |           |                         |                    |            |             |        |
|--------------------|-------------|-----------|-------------------------|--------------------|------------|-------------|--------|
| CH                 | Freq. (MHz) | Data Rate | Avg. Output Power (dBm) | Antenna Gain (dBi) | EIRP (dBm) | Limit (dBm) | RESULT |
| 1                  | 2412        | MCS0      | 14.67                   | 1.20               | 15.87      | 36          | PASS   |
| 4                  | 2427        | MCS0      | 19.91                   | 1.20               | 21.11      | 36          | PASS   |
| 6                  | 2437        | MCS0      | 19.54                   | 1.20               | 20.74      | 36          | PASS   |
| 8                  | 2447        | MCS0      | 19.67                   | 1.20               | 20.87      | 36          | PASS   |
| 11                 | 2462        | MCS0      | 14.51                   | 1.20               | 15.71      | 36          | PASS   |

Unless otherwise stated the results shown in this test report refer only to the sample(s) tested and such sample(s) are retained for 90 days only.

除非另有說明，此報告結果僅對測試之樣品負責，同時此樣品僅保留90天。本報告未經本公司書面許可，不可部份複製。

This document is issued by the Company subject to its General Conditions of Service printed overleaf, available on request or accessible at <http://www.sgs.com.tw/Terms-and-Conditions>, and for electronic format documents, subject to Terms and Conditions for Electronic Documents at <http://www.sgs.com.tw/Terms-and-Conditions>. Attention is drawn to the limitation of liability, indemnification and jurisdiction issues defined therein. Any holder of this document is advised that information contained hereon reflects the Company's findings at the time of its intervention only and within the limits of Client's instructions, if any. The Company's sole responsibility is to its Client and this document does not exonerate parties to a transaction from exercising all their rights and obligations under the transaction documents. This document cannot be reproduced except in full, without prior written approval of the Company. Any unauthorized alteration, forgery or falsification of the content or appearance of this document is unlawful and offenders may be prosecuted to the fullest extent of the law.

**802.11n\_HT20M\_2TX**

| CH | Freq. (MHz) | Data Rate | Avg. Output Power |       | Total Avg. Output Power (dBm) | Antenna Gain (dBi) | EIRP (dBm)   | Limit (dBm) | RESULT |
|----|-------------|-----------|-------------------|-------|-------------------------------|--------------------|--------------|-------------|--------|
|    |             |           | Ch0               | Ch1   |                               |                    |              |             |        |
| 1  | 2412        | MCS0      | 15.00             | 14.81 | 17.91                         | 4.21               | 22.12        | 36          | PASS   |
| 4  | 2427        | MCS0      | 20.00             | 19.94 | 22.98                         | 4.21               | <b>27.19</b> | 36          | PASS   |
| 6  | 2437        | MCS0      | 20.02             | 19.55 | 22.80                         | 4.21               | 27.01        | 36          | PASS   |
| 8  | 2447        | MCS0      | 20.03             | 19.84 | 22.94                         | 4.21               | 27.15        | 36          | PASS   |
| 11 | 2462        | MCS0      | 15.09             | 14.74 | 17.93                         | 4.21               | 22.14        | 36          | PASS   |

**802.11n\_HT\_40M Ch0**

| CH | Freq. (MHz) | Data Rate | Avg. Output Power (dBm) | Antenna Gain (dBi) | EIRP (dBm) | Limit (dBm) | RESULT |
|----|-------------|-----------|-------------------------|--------------------|------------|-------------|--------|
| 3  | 2422        | MCS0      | 12.86                   | 1.20               | 14.06      | 36          | PASS   |
| 5  | 2432        | MCS0      | 19.84                   | 1.20               | 21.04      | 36          | PASS   |
| 6  | 2437        | MCS0      | 19.74                   | 1.20               | 20.94      | 36          | PASS   |
| 7  | 2442        | MCS0      | 19.82                   | 1.20               | 21.02      | 36          | PASS   |
| 9  | 2452        | MCS0      | 12.75                   | 1.20               | 13.95      | 36          | PASS   |

**802.11n\_HT\_40M Ch1**

| CH | Freq. (MHz) | Data Rate | Avg. Output Power (dBm) | Antenna Gain (dBi) | EIRP (dBm) | Limit (dBm) | RESULT |
|----|-------------|-----------|-------------------------|--------------------|------------|-------------|--------|
| 3  | 2422        | MCS0      | 12.58                   | 1.20               | 13.78      | 36          | PASS   |
| 5  | 2432        | MCS0      | 19.81                   | 1.20               | 21.01      | 36          | PASS   |
| 6  | 2437        | MCS0      | 19.55                   | 1.20               | 20.75      | 36          | PASS   |
| 7  | 2442        | MCS0      | 19.61                   | 1.20               | 20.81      | 36          | PASS   |
| 9  | 2452        | MCS0      | 12.54                   | 1.20               | 13.74      | 36          | PASS   |

**802.11n\_HT40M\_2TX**

| CH | Freq. (MHz) | Data Rate | Avg. Output Power |       | Total Avg. Output Power (dBm) | Antenna Gain (dBi) | EIRP (dBm)   | Limit (dBm) | RESULT |
|----|-------------|-----------|-------------------|-------|-------------------------------|--------------------|--------------|-------------|--------|
|    |             |           | Ch0               | Ch1   |                               |                    |              |             |        |
| 3  | 2422        | MCS0      | 12.93             | 12.80 | 15.88                         | 4.21               | 20.09        | 36          | PASS   |
| 5  | 2432        | MCS0      | 18.25             | 17.68 | 20.98                         | 4.21               | 25.19        | 36          | PASS   |
| 6  | 2437        | MCS0      | 19.25             | 18.49 | 21.90                         | 4.21               | 26.11        | 36          | PASS   |
| 7  | 2442        | MCS0      | 20.00             | 19.82 | 22.92                         | 4.21               | <b>27.13</b> | 36          | PASS   |
| 9  | 2452        | MCS0      | 13.18             | 12.74 | 15.98                         | 4.21               | 20.19        | 36          | PASS   |

Unless otherwise stated the results shown in this test report refer only to the sample(s) tested and such sample(s) are retained for 90 days only.

除非另有說明，此報告結果僅對測試之樣品負責，同時此樣品僅保留90天。本報告未經本公司書面許可，不可部份複製。

This document is issued by the Company subject to its General Conditions of Service printed overleaf, available on request or accessible at <http://www.sgs.com.tw/Terms-and-Conditions> and for electronic format documents, subject to Terms and Conditions for Electronic Documents at <http://www.sgs.com.tw/Terms-and-Conditions>. Attention is drawn to the limitation of liability, indemnification and jurisdiction issues defined therein. Any holder of this document is advised that information contained hereon reflects the Company's findings at the time of its intervention only and within the limits of Client's instructions, if any. The Company's sole responsibility is to its Client and this document does not exonerate parties to a transaction from exercising all their rights and obligations under the transaction documents. This document cannot be reproduced except in full, without prior written approval of the Company. Any unauthorized alteration, forgery or falsification of the content or appearance of this document is unlawful and offenders may be prosecuted to the fullest extent of the law.

| 802.11ax_HE_20M Ch0 |             |           |           |                         |                    |            |       |        |
|---------------------|-------------|-----------|-----------|-------------------------|--------------------|------------|-------|--------|
| CH                  | Freq. (MHz) | Data Rate | RU Config | Avg. Output Power (dBm) | Antenna Gain (dBi) | EIRP (dBm) | Limit | RESULT |
| 1                   | 2412        | MCS0      | full      | 14.83                   | 1.20               | 16.03      | 36    | PASS   |
| 4                   | 2427        | MCS0      | full      | 19.93                   | 1.20               | 21.13      | 36    | PASS   |
| 6                   | 2437        | MCS0      | full      | 19.77                   | 1.20               | 20.97      | 36    | PASS   |
| 8                   | 2447        | MCS0      | full      | 19.98                   | 1.20               | 21.18      | 36    | PASS   |
| 11                  | 2462        | MCS0      | full      | 14.73                   | 1.20               | 15.93      | 36    | PASS   |

| 802.11ax_HE_20M Ch1 |             |           |           |                         |                    |            |       |        |
|---------------------|-------------|-----------|-----------|-------------------------|--------------------|------------|-------|--------|
| CH                  | Freq. (MHz) | Data Rate | RU Config | Avg. Output Power (dBm) | Antenna Gain (dBi) | EIRP (dBm) | Limit | RESULT |
| 1                   | 2412        | MCS0      | full      | 14.61                   | 1.20               | 15.81      | 36    | PASS   |
| 4                   | 2427        | MCS0      | full      | 19.72                   | 1.20               | 20.92      | 36    | PASS   |
| 6                   | 2437        | MCS0      | full      | 19.67                   | 1.20               | 20.87      | 36    | PASS   |
| 8                   | 2447        | MCS0      | full      | 19.87                   | 1.20               | 21.07      | 36    | PASS   |
| 11                  | 2462        | MCS0      | full      | 14.65                   | 1.20               | 15.85      | 36    | PASS   |

| 802.11ax_HE20M_2TX |             |           |           |                   |       |                               |                    |              |       |        |
|--------------------|-------------|-----------|-----------|-------------------|-------|-------------------------------|--------------------|--------------|-------|--------|
| CH                 | Freq. (MHz) | Data Rate | RU Config | Avg. Output Power |       | Total Avg. Output Power (dBm) | Antenna Gain (dBi) | EIRP (dBm)   | Limit | RESULT |
|                    |             |           |           | Ch0               | Ch1   |                               |                    |              |       |        |
| 1                  | 2412        | MCS0      | full      | 15.17             | 14.73 | 17.97                         | 4.21               | 22.18        | 36    | PASS   |
| 4                  | 2427        | MCS0      | full      | 20.11             | 19.76 | 22.95                         | 4.21               | 27.16        | 36    | PASS   |
| 6                  | 2437        | MCS0      | full      | 20.00             | 19.69 | 22.86                         | 4.21               | 27.07        | 36    | PASS   |
| 8                  | 2447        | MCS0      | full      | 20.06             | 19.90 | 22.99                         | 4.21               | <b>27.20</b> | 36    | PASS   |
| 11                 | 2462        | MCS0      | full      | 15.01             | 14.84 | 17.94                         | 4.21               | 22.15        | 36    | PASS   |

| 802.11ax_HE_40M Ch0 |             |           |           |                         |                    |            |       |        |
|---------------------|-------------|-----------|-----------|-------------------------|--------------------|------------|-------|--------|
| CH                  | Freq. (MHz) | Data Rate | RU Config | Avg. Output Power (dBm) | Antenna Gain (dBi) | EIRP (dBm) | Limit | RESULT |
| 3                   | 2422        | MCS0      | full      | 12.91                   | 1.20               | 14.11      | 36    | PASS   |
| 5                   | 2432        | MCS0      | full      | 19.85                   | 1.20               | 21.05      | 36    | PASS   |
| 6                   | 2437        | MCS0      | full      | 19.84                   | 1.20               | 21.04      | 36    | PASS   |
| 7                   | 2442        | MCS0      | full      | 19.99                   | 1.20               | 21.19      | 36    | PASS   |
| 9                   | 2452        | MCS0      | full      | 12.96                   | 1.20               | 14.16      | 36    | PASS   |

Unless otherwise stated the results shown in this test report refer only to the sample(s) tested and such sample(s) are retained for 90 days only.

除非另有說明，此報告結果僅對測試之樣品負責，同時此樣品僅保留90天。本報告未經本公司書面許可，不可部份複製。

This document is issued by the Company subject to its General Conditions of Service printed overleaf, available on request or accessible at <http://www.sgs.com.tw/Terms-and-Conditions> and for electronic format documents, subject to Terms and Conditions for Electronic Documents at <http://www.sgs.com.tw/Terms-and-Conditions>. Attention is drawn to the limitation of liability, indemnification and jurisdiction issues defined therein. Any holder of this document is advised that information contained hereon reflects the Company's findings at the time of its intervention only and within the limits of Client's instructions, if any. The Company's sole responsibility is to its Client and this document does not exonerate parties to a transaction from exercising all their rights and obligations under the transaction documents. This document cannot be reproduced except in full, without prior written approval of the Company. Any unauthorized alteration, forgery or falsification of the content or appearance of this document is unlawful and offenders may be prosecuted to the fullest extent of the law.

**802.11ax\_HE\_40M Ch1**

| CH | Freq. (MHz) | Data Rate | RU Config | Avg. Output Power (dBm) | Antenna Gain (dBi) | EIRP (dBm) | Limit | RESULT |
|----|-------------|-----------|-----------|-------------------------|--------------------|------------|-------|--------|
| 3  | 2422        | MCS0      | full      | 12.58                   | 1.20               | 13.78      | 36    | PASS   |
| 5  | 2432        | MCS0      | full      | 19.57                   | 1.20               | 20.77      | 36    | PASS   |
| 6  | 2437        | MCS0      | full      | 19.52                   | 1.20               | 20.72      | 36    | PASS   |
| 7  | 2442        | MCS0      | full      | 19.69                   | 1.20               | 20.89      | 36    | PASS   |
| 9  | 2452        | MCS0      | full      | 12.73                   | 1.20               | 13.93      | 36    | PASS   |

**802.11ax\_HE40M\_2TX**

| CH | Freq. (MHz) | Data Rate | RU Config | Avg. Output Power |       | Total Avg. Output Power (dBm) | Antenna Gain (dBi) | EIRP (dBm)   | Limit | RESULT |
|----|-------------|-----------|-----------|-------------------|-------|-------------------------------|--------------------|--------------|-------|--------|
|    |             |           |           | Ch0               | Ch1   |                               |                    |              |       |        |
| 3  | 2422        | MCS0      | full      | 13.08             | 12.73 | 15.92                         | 4.21               | 20.13        | 36    | PASS   |
| 5  | 2432        | MCS0      | full      | 18.23             | 17.85 | 21.05                         | 4.21               | 25.26        | 36    | PASS   |
| 6  | 2437        | MCS0      | full      | 18.79             | 18.09 | 21.46                         | 4.21               | 25.67        | 36    | PASS   |
| 7  | 2442        | MCS0      | full      | 19.62             | 19.28 | 22.46                         | 4.21               | <b>26.67</b> | 36    | PASS   |
| 9  | 2452        | MCS0      | full      | 13.04             | 12.67 | 15.87                         | 4.21               | 20.08        | 36    | PASS   |

Unless otherwise stated the results shown in this test report refer only to the sample(s) tested and such sample(s) are retained for 90 days only.  
 除非另有說明，此報告結果僅對測試之樣品負責，同時此樣品僅保留90天。本報告未經本公司書面許可，不可部份複製。

This document is issued by the Company subject to its General Conditions of Service printed overleaf, available on request or accessible at <http://www.sgs.com.tw/Terms-and-Conditions> and for electronic format documents, subject to Terms and Conditions for Electronic Documents at <http://www.sgs.com.tw/Terms-and-Conditions>. Attention is drawn to the limitation of liability, indemnification and jurisdiction issues defined therein. Any holder of this document is advised that information contained hereon reflects the Company's findings at the time of its intervention only and within the limits of Client's instructions, if any. The Company's sole responsibility is to its Client and this document does not exonerate parties to a transaction from exercising all their rights and obligations under the transaction documents. This document cannot be reproduced except in full, without prior written approval of the Company. Any unauthorized alteration, forgery or falsification of the content or appearance of this document is unlawful and offenders may be prosecuted to the fullest extent of the law.

## 9 EMISSION BANDWIDTH MEASUREMENT

### 9.1 Standard Applicable

The minimum 6 dB bandwidth shall be at least 500 kHz.

### 9.2 Test Setup

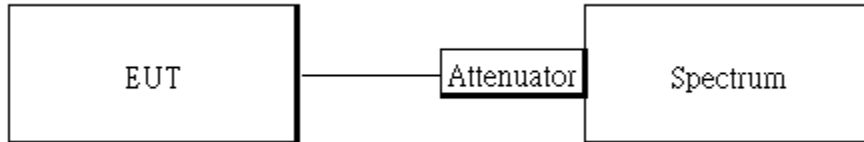

### 9.3 Measurement Procedure:

1. Place the EUT on the table and set it in transmitting mode.
2. Remove the antenna from the EUT and then connect a low loss RF cable from the antenna port to the spectrum analyzer.

#### 9.3.1 FCC measurements

1. The testing follows the Measurement Procedure of the KDB 558074 D01.
2. Set the spectrum analyzer as  
 RBW= 100 kHz ,  
 VBW = 3 X RBW,  
 Span= 2 to 5 times of the OBW,  
 Sweep=auto, Detector = Peak, and Max hold.
3. Mark the upper and lower frequencies of -6dB.
4. Repeat above procedures until all test default channel is completed.

#### 9.3.2 ISED measurements

1. The testing follows the Measurement Procedure of the RSS-Gen section 6.7.
2. Set the spectrum analyzer as  
 RBW= 1 % to 5% of 99% and -6dB Bandwidth ,  
 VBW  $\geq$  3 X RBW,  
 Span= large enough to capture all products of the modulation process  
 Sweep=auto, Detector = Peak, and Max hold.
3. Mark the upper and lower frequencies of 99% and -6dB.
4. Repeat above procedures until all test default channel is completed.

Unless otherwise stated the results shown in this test report refer only to the sample(s) tested and such sample(s) are retained for 90 days only.  
 除非另有說明，此報告結果僅對測試之樣品負責，同時此樣品僅保留90天。本報告未經本公司書面許可，不可部份複製。

This document is issued by the Company subject to its General Conditions of Service printed overleaf, available on request or accessible at <http://www.sgs.com.tw/Terms-and-Conditions> and for electronic format documents, subject to Terms and Conditions for Electronic Documents at <http://www.sgs.com.tw/Terms-and-Conditions>. Attention is drawn to the limitation of liability, indemnification and jurisdiction issues defined therein. Any holder of this document is advised that information contained hereon reflects the Company's findings at the time of its intervention only and within the limits of Client's instructions, if any. The Company's sole responsibility is to its Client and this document does not exonerate parties to a transaction from exercising all their rights and obligations under the transaction documents. This document cannot be reproduced except in full, without prior written approval of the Company. Any unauthorized alteration, forgery or falsification of the content or appearance of this document is unlawful and offenders may be prosecuted to the fullest extent of the law.



## 9.4 6dB Bandwidth

## 802.11b Ch0

| Freq. (MHz) | 6dB BW (kHz)   | Limit (kHz) | Result |
|-------------|----------------|-------------|--------|
| 2412        | 7596.00        | ≥ 500       | PASS   |
| 2437        | <b>8050.00</b> | ≥ 500       | PASS   |
| 2462        | 7585.00        | ≥ 500       | PASS   |

## 802.11b Ch1

| Freq. (MHz) | 6dB BW (kHz)   | Limit (kHz) | Result |
|-------------|----------------|-------------|--------|
| 2412        | <b>7193.00</b> | ≥ 500       | PASS   |
| 2437        | 7119.00        | ≥ 500       | PASS   |
| 2462        | 7143.00        | ≥ 500       | PASS   |

## 802.11g Ch0

| Freq. (MHz) | 6dB BW (kHz)    | Limit (kHz) | Result |
|-------------|-----------------|-------------|--------|
| 2412        | <b>15480.00</b> | ≥ 500       | PASS   |
| 2437        | 15180.00        | ≥ 500       | PASS   |
| 2462        | 15390.00        | ≥ 500       | PASS   |

## 802.11g Ch1

| Freq. (MHz) | 6dB BW (kHz)    | Limit (kHz) | Result |
|-------------|-----------------|-------------|--------|
| 2412        | <b>16030.00</b> | ≥ 500       | PASS   |
| 2437        | 15700.00        | ≥ 500       | PASS   |
| 2462        | 15760.00        | ≥ 500       | PASS   |

## 802.11n\_HT\_20M Ch0

| Freq. (MHz) | 6dB BW (kHz)    | Limit (kHz) | Result |
|-------------|-----------------|-------------|--------|
| 2412        | 15980.00        | ≥ 500       | PASS   |
| 2437        | <b>16000.00</b> | ≥ 500       | PASS   |
| 2462        | 15910.00        | ≥ 500       | PASS   |

## 802.11n\_HT\_20M Ch1

| Freq. (MHz) | 6dB BW (kHz)    | Limit (kHz) | Result |
|-------------|-----------------|-------------|--------|
| 2412        | <b>16820.00</b> | ≥ 500       | PASS   |
| 2437        | 15970.00        | ≥ 500       | PASS   |
| 2462        | 16560.00        | ≥ 500       | PASS   |

Unless otherwise stated the results shown in this test report refer only to the sample(s) tested and such sample(s) are retained for 90 days only.

除非另有說明，此報告結果僅對測試之樣品負責，同時此樣品僅保留90天。本報告未經本公司書面許可，不可部份複製。

This document is issued by the Company subject to its General Conditions of Service printed overleaf, available on request or accessible at <http://www.sgs.com.tw/Terms-and-Conditions> and for electronic format documents, subject to Terms and Conditions for Electronic Documents at <http://www.sgs.com.tw/Terms-and-Conditions>. Attention is drawn to the limitation of liability, indemnification and jurisdiction issues defined therein. Any holder of this document is advised that information contained hereon reflects the Company's findings at the time of its intervention only and within the limits of Client's instructions, if any. The Company's sole responsibility is to its Client and this document does not exonerate parties to a transaction from exercising all their rights and obligations under the transaction documents. This document cannot be reproduced except in full, without prior written approval of the Company. Any unauthorized alteration, forgery or falsification of the content or appearance of this document is unlawful and offenders may be prosecuted to the fullest extent of the law.

## 802.11n\_HT\_40M Ch0

| Freq. (MHz) | 6dB BW (kHz)    | Limit (kHz) | Result |
|-------------|-----------------|-------------|--------|
| 2422        | 35340.00        | ≥ 500       | PASS   |
| 2437        | 35170.00        | ≥ 500       | PASS   |
| 2452        | <b>36000.00</b> | ≥ 500       | PASS   |

## 802.11n\_HT\_40M Ch1

| Freq. (MHz) | 6dB BW (kHz)    | Limit (kHz) | Result |
|-------------|-----------------|-------------|--------|
| 2422        | <b>36310.00</b> | ≥ 500       | PASS   |
| 2437        | 35130.00        | ≥ 500       | PASS   |
| 2452        | 35710.00        | ≥ 500       | PASS   |

## 802.11ax\_HE\_20M Ch0

| Freq. (MHz) | RU Config | 6dB BW (kHz)    | Limit (kHz) | Result |
|-------------|-----------|-----------------|-------------|--------|
| 2412        | full      | 17830.00        | ≥ 500       | PASS   |
| 2437        | full      | 18050.00        | ≥ 500       | PASS   |
| 2462        | full      | <b>18580.00</b> | ≥ 500       | PASS   |

## 802.11ax\_HE\_20M Ch1

| Freq. (MHz) | RU Config | 6dB BW (kHz)    | Limit (kHz) | Result |
|-------------|-----------|-----------------|-------------|--------|
| 2412        | full      | 18160.00        | ≥ 500       | PASS   |
| 2437        | full      | <b>18450.00</b> | ≥ 500       | PASS   |
| 2462        | full      | 18410.00        | ≥ 500       | PASS   |

## 802.11ax\_HE\_40M Ch0

| Freq. (MHz) | RU Config | 6dB BW (kHz)    | Limit (kHz) | Result |
|-------------|-----------|-----------------|-------------|--------|
| 2422        | full      | 37210.00        | ≥ 500       | PASS   |
| 2437        | full      | 37570.00        | ≥ 500       | PASS   |
| 2452        | full      | <b>37810.00</b> | ≥ 500       | PASS   |

## 802.11ax\_HE\_40M Ch1

| Freq. (MHz) | RU Config | 6dB BW (kHz)    | Limit (kHz) | Result |
|-------------|-----------|-----------------|-------------|--------|
| 2422        | full      | <b>37760.00</b> | ≥ 500       | PASS   |
| 2437        | full      | 37160.00        | ≥ 500       | PASS   |
| 2452        | full      | 36400.00        | ≥ 500       | PASS   |

Unless otherwise stated the results shown in this test report refer only to the sample(s) tested and such sample(s) are retained for 90 days only.

除非另有說明，此報告結果僅對測試之樣品負責，同時此樣品僅保留90天。本報告未經本公司書面許可，不可部份複製。

This document is issued by the Company subject to its General Conditions of Service printed overleaf, available on request or accessible at <http://www.sgs.com.tw/Terms-and-Conditions> and for electronic format documents, subject to Terms and Conditions for Electronic Documents at <http://www.sgs.com.tw/Terms-and-Conditions>. Attention is drawn to the limitation of liability, indemnification and jurisdiction issues defined therein. Any holder of this document is advised that information contained hereon reflects the Company's findings at the time of its intervention only and within the limits of Client's instructions, if any. The Company's sole responsibility is to its Client and this document does not exonerate parties to a transaction from exercising all their rights and obligations under the transaction documents. This document cannot be reproduced except in full, without prior written approval of the Company. Any unauthorized alteration, forgery or falsification of the content or appearance of this document is unlawful and offenders may be prosecuted to the fullest extent of the law.

802.11b\_20MHz\_Chain0\_2412MHz

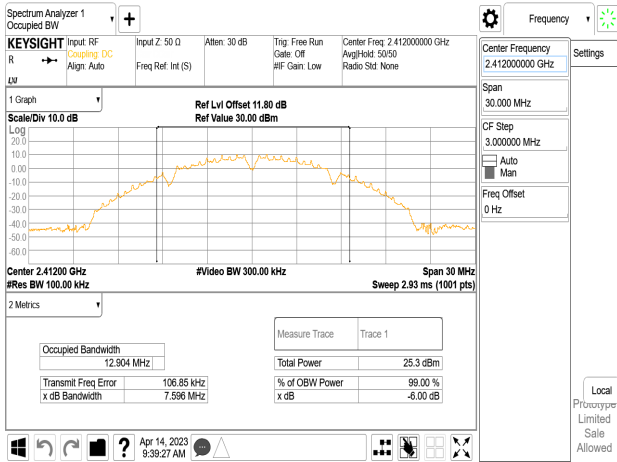

802.11b\_20MHz\_Chain1\_2412MHz

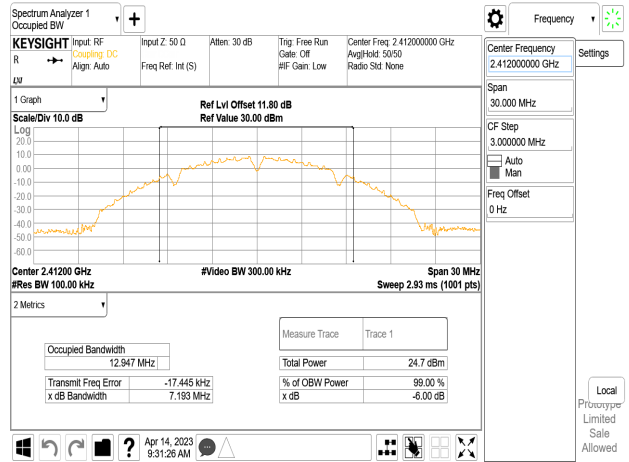

802.11b\_20MHz\_Chain0\_2437MHz

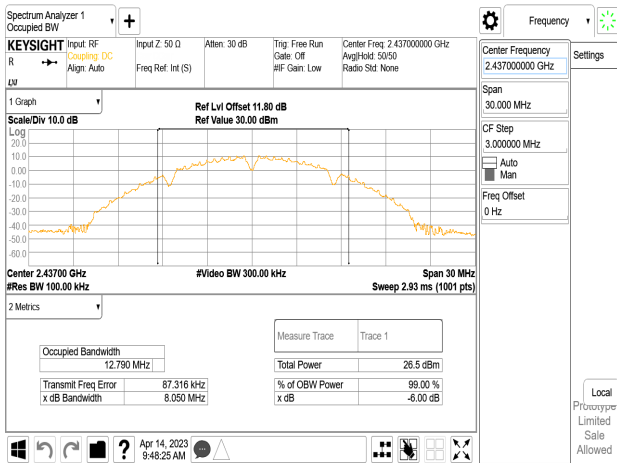

802.11b\_20MHz\_Chain1\_2437MHz

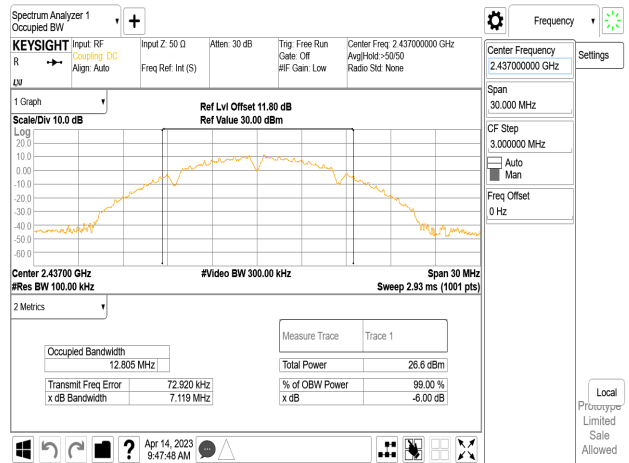

802.11b\_20MHz\_Chain0\_2462MHz

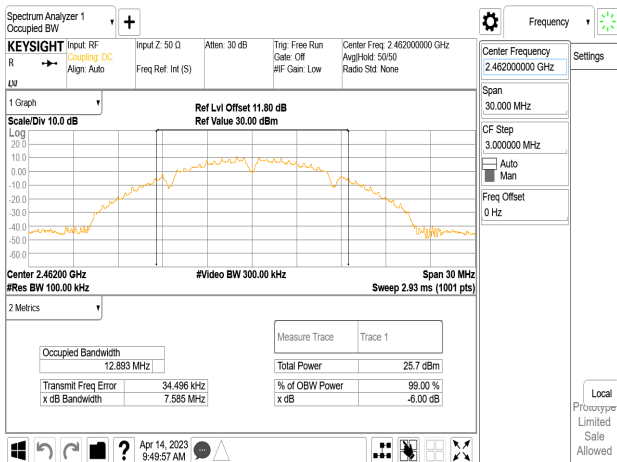

802.11b\_20MHz\_Chain1\_2462MHz

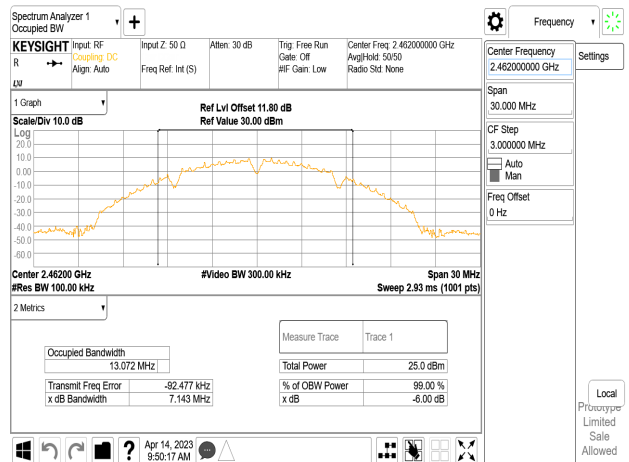

Unless otherwise stated the results shown in this test report refer only to the sample(s) tested and such sample(s) are retained for 90 days only.

除非另有說明，此報告結果僅對測試之樣品負責，同時此樣品僅保留90天。本報告未經本公司書面許可，不可部份複製。

This document is issued by the Company subject to its General Conditions of Service printed overleaf, available on request or accessible at <http://www.sgs.com.tw/Terms-and-Conditions> and for electronic format documents, subject to Terms and Conditions for Electronic Documents at <http://www.sgs.com.tw/Terms-and-Conditions>. Attention is drawn to the limitation of liability, indemnification and jurisdiction issues defined therein. Any holder of this document is advised that information contained hereon reflects the Company's findings at the time of its intervention only and within the limits of Client's instructions, if any. The Company's sole responsibility is to its Client and this document does not exonerate parties to a transaction from exercising all their rights and obligations under the transaction documents. This document cannot be reproduced except in full, without prior written approval of the Company. Any unauthorized alteration, forgery or falsification of the content or appearance of this document is unlawful and offenders may be prosecuted to the fullest extent of the law.

802.11g\_20MHz\_Chain0\_2412MHz

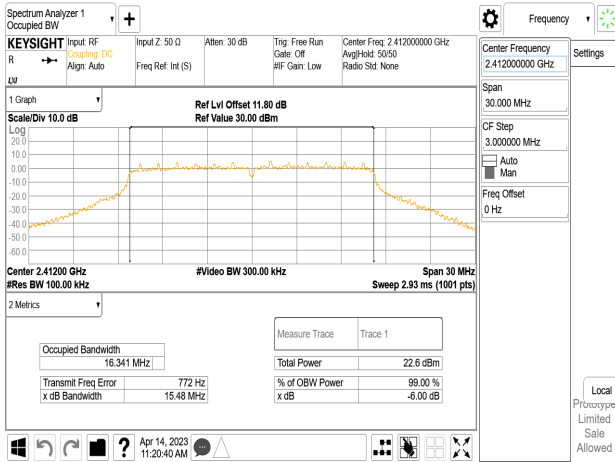

802.11g\_20MHz\_Chain1\_2412MHz

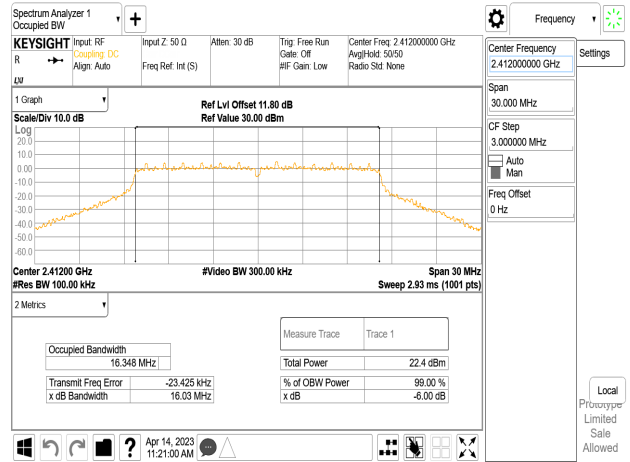

802.11g\_20MHz\_Chain0\_2437MHz

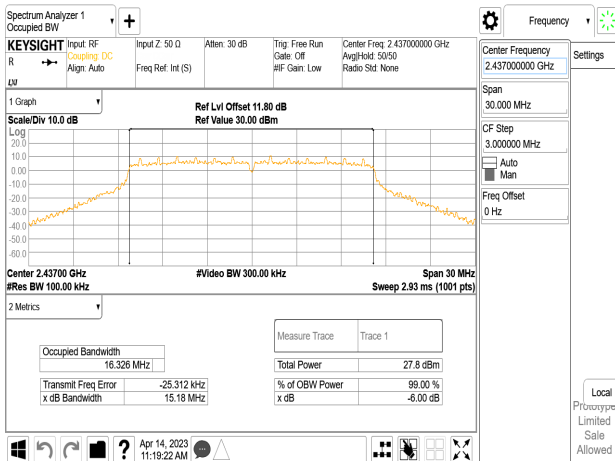

802.11g\_20MHz\_Chain1\_2437MHz

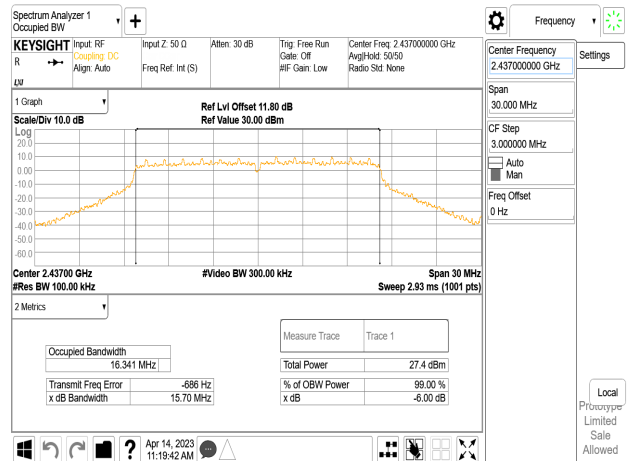

802.11g\_20MHz\_Chain0\_2462MHz

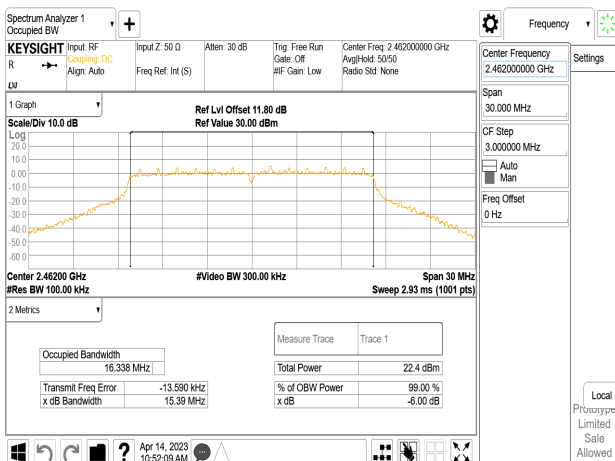

802.11g\_20MHz\_Chain1\_2462MHz

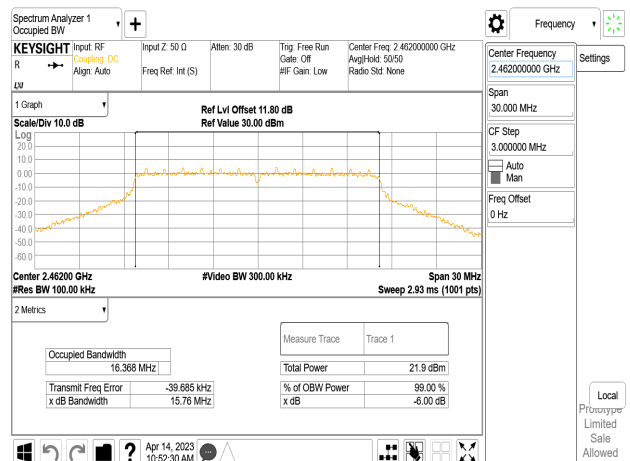

Unless otherwise stated the results shown in this test report refer only to the sample(s) tested and such sample(s) are retained for 90 days only.

除非另有說明，此報告結果僅對測試之樣品負責，同時此樣品僅保留90天。本報告未經本公司書面許可，不可部份複製。

This document is issued by the Company subject to its General Conditions of Service printed overleaf, available on request or accessible at <http://www.sgs.com.tw/Terms-and-Conditions> and for electronic format documents, subject to Terms and Conditions for Electronic Documents at <http://www.sgs.com.tw/Terms-and-Conditions>. Attention is drawn to the limitation of liability, indemnification and jurisdiction issues defined therein. Any holder of this document is advised that information contained hereon reflects the Company's findings at the time of its intervention only and within the limits of Client's instructions, if any. The Company's sole responsibility is to its Client and this document does not exonerate parties to a transaction from exercising all their rights and obligations under the transaction documents. This document cannot be reproduced except in full, without prior written approval of the Company. Any unauthorized alteration, forgery or falsification of the content or appearance of this document is unlawful and offenders may be prosecuted to the fullest extent of the law.

802.11n\_20MHz\_Chain0\_2412MHz

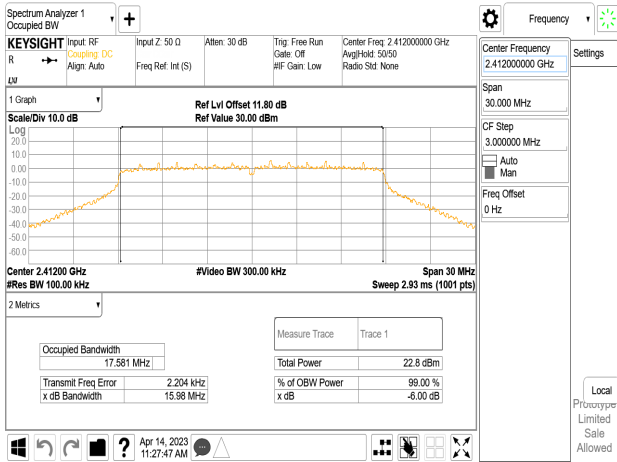

802.11n\_20MHz\_Chain1\_2412MHz

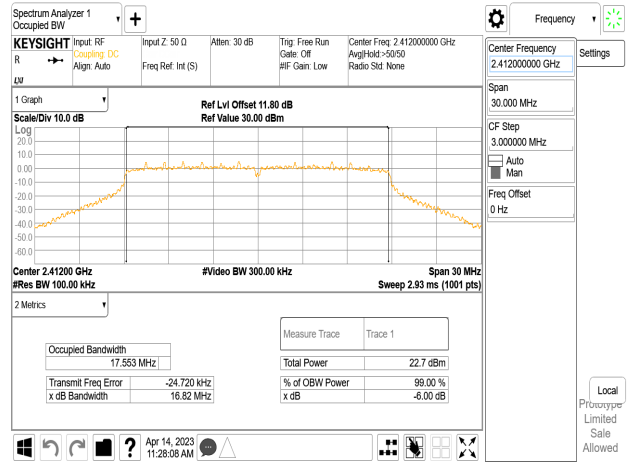

802.11n\_20MHz\_Chain0\_2437MHz

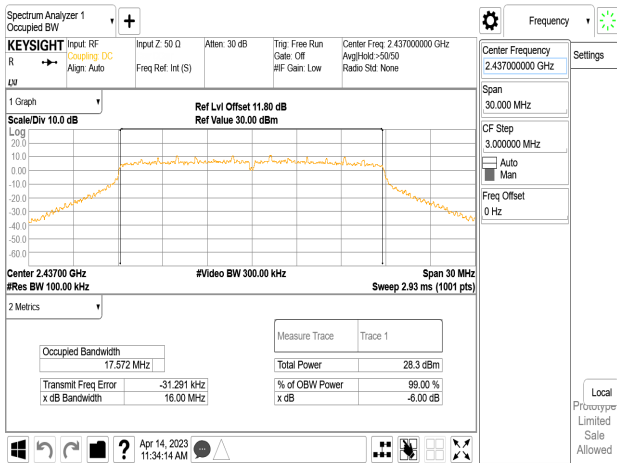

802.11n\_20MHz\_Chain1\_2437MHz

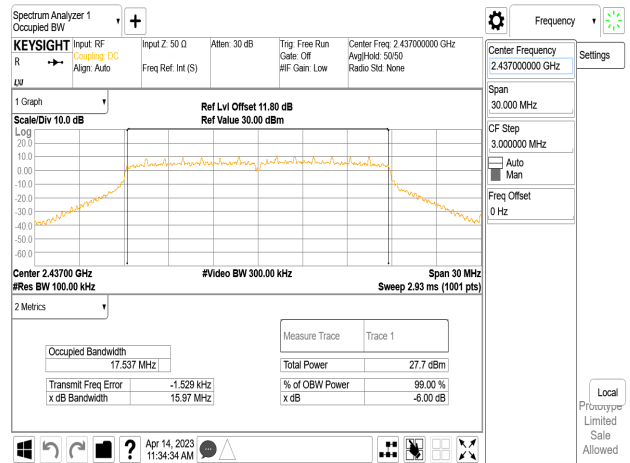

802.11n\_20MHz\_Chain0\_2462MHz

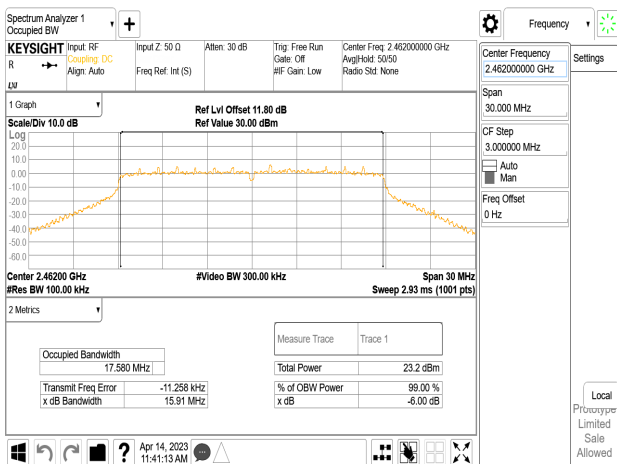

802.11n\_20MHz\_Chain1\_2462MHz

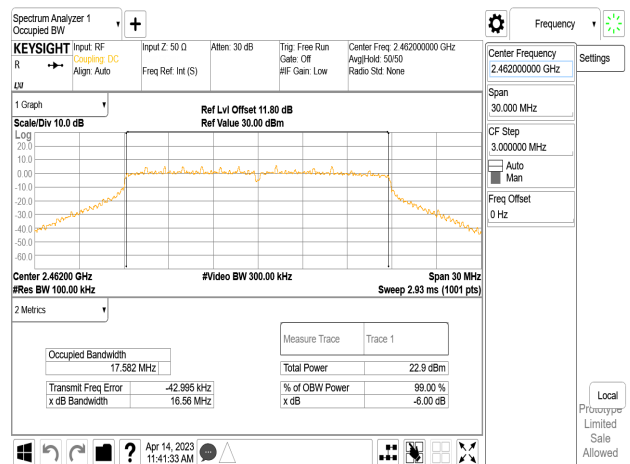

Unless otherwise stated the results shown in this test report refer only to the sample(s) tested and such sample(s) are retained for 90 days only.

除非另有說明，此報告結果僅對測試之樣品負責，同時此樣品僅保留90天。本報告未經本公司書面許可，不可部份複製。

This document is issued by the Company subject to its General Conditions of Service printed overleaf, available on request or accessible at <http://www.sgs.com.tw/Terms-and-Conditions> and for electronic format documents, subject to Terms and Conditions for Electronic Documents at <http://www.sgs.com.tw/Terms-and-Conditions>. Attention is drawn to the limitation of liability, indemnification and jurisdiction issues defined therein. Any holder of this document is advised that information contained hereon reflects the Company's findings at the time of its intervention only and within the limits of Client's instructions, if any. The Company's sole responsibility is to its Client and this document does not exonerate parties to a transaction from exercising all their rights and obligations under the transaction documents. This document cannot be reproduced except in full, without prior written approval of the Company. Any unauthorized alteration, forgery or falsification of the content or appearance of this document is unlawful and offenders may be prosecuted to the fullest extent of the law.

802.11n\_40MHz\_Chain0\_2422MHz

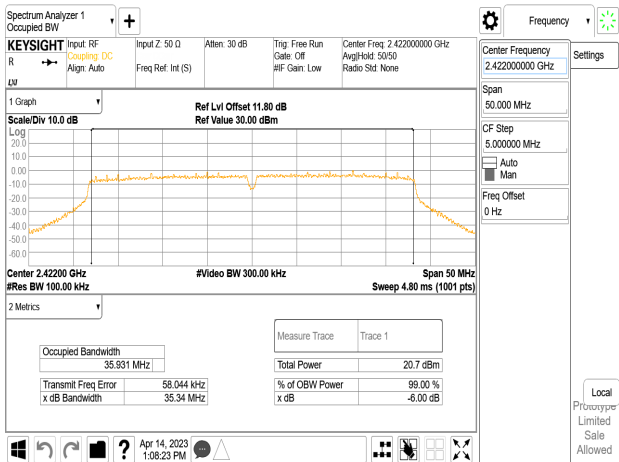

802.11n\_40MHz\_Chain1\_2422MHz

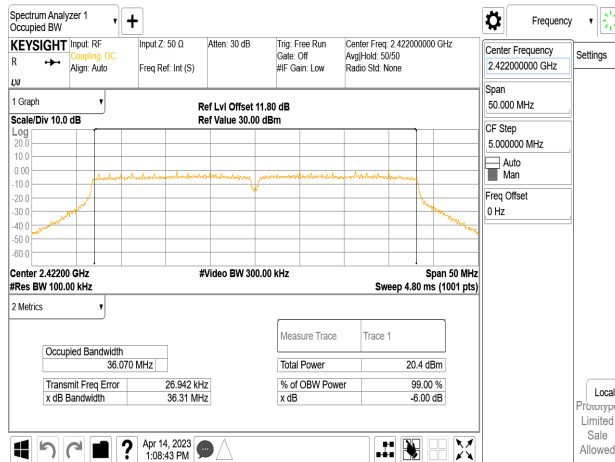

802.11n\_40MHz\_Chain0\_2437MHz

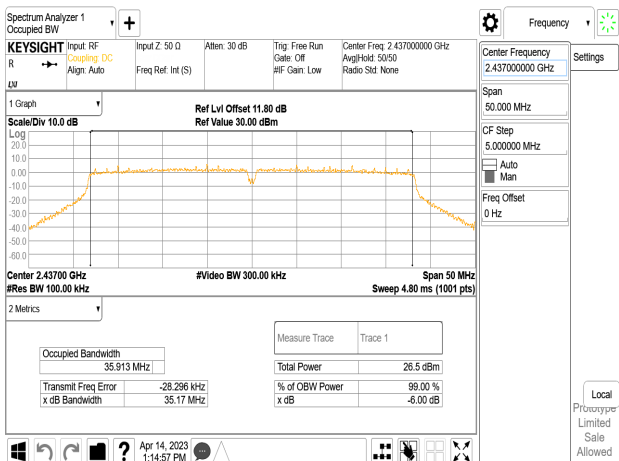

802.11n\_40MHz\_Chain1\_2437MHz

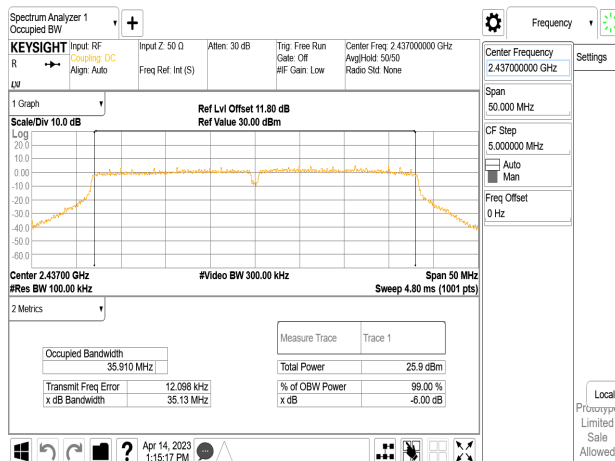

802.11n\_40MHz\_Chain0\_2452MHz

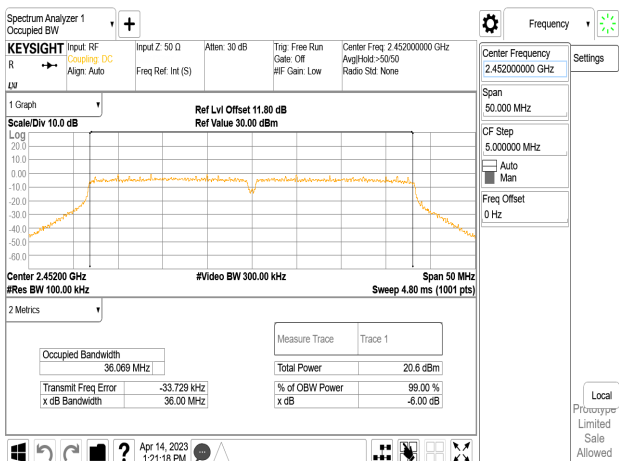

802.11n\_40MHz\_Chain1\_2452MHz

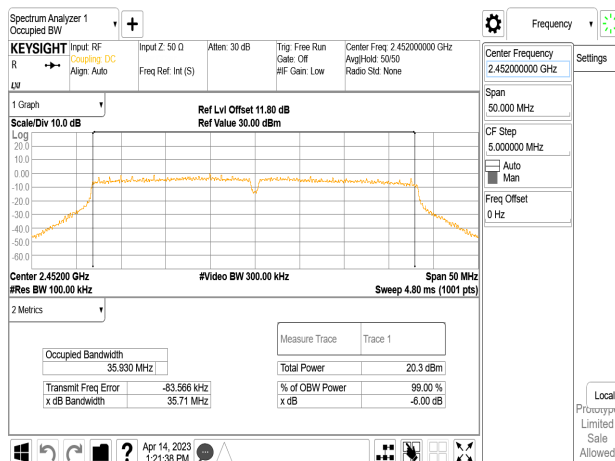

Unless otherwise stated the results shown in this test report refer only to the sample(s) tested and such sample(s) are retained for 90 days only.

除非另有說明，此報告結果僅對測試之樣品負責，同時此樣品僅保留90天。本報告未經本公司書面許可，不可部份複製。

This document is issued by the Company subject to its General Conditions of Service printed overleaf, available on request or accessible at <http://www.sgs.com.tw/Terms-and-Conditions> and for electronic format documents, subject to Terms and Conditions for Electronic Documents at <http://www.sgs.com.tw/Terms-and-Conditions>. Attention is drawn to the limitation of liability, indemnification and jurisdiction issues defined therein. Any holder of this document is advised that information contained hereon reflects the Company's findings at the time of its intervention only and within the limits of Client's instructions, if any. The Company's sole responsibility is to its Client and this document does not exonerate parties to a transaction from exercising all their rights and obligations under the transaction documents. This document cannot be reproduced except in full, without prior written approval of the Company. Any unauthorized alteration, forgery or falsification of the content or appearance of this document is unlawful and offenders may be prosecuted to the fullest extent of the law.

802.11ax\_20MHz\_Chain0\_2412MHz

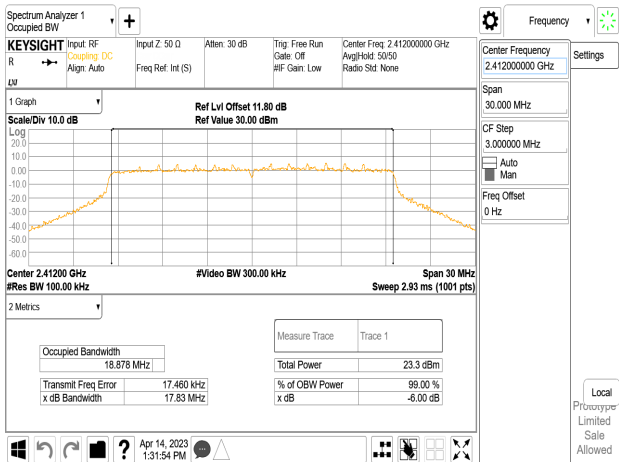

802.11ax\_20MHz\_Chain1\_2412MHz

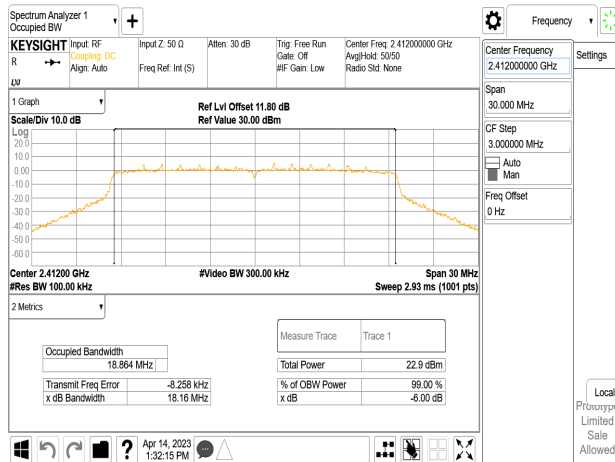

802.11ax\_20MHz\_Chain0\_2437MHz

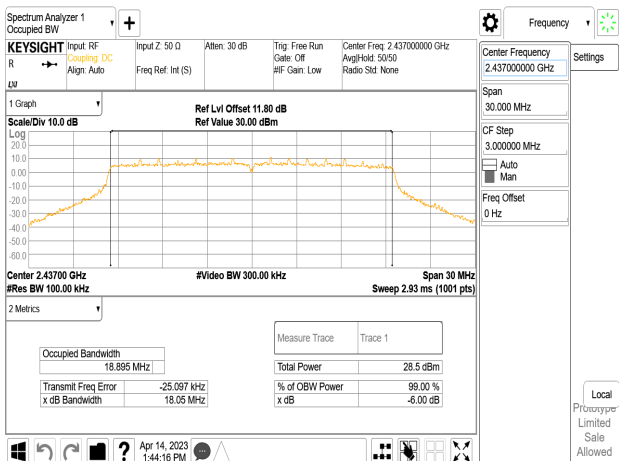

802.11ax\_20MHz\_Chain1\_2437MHz

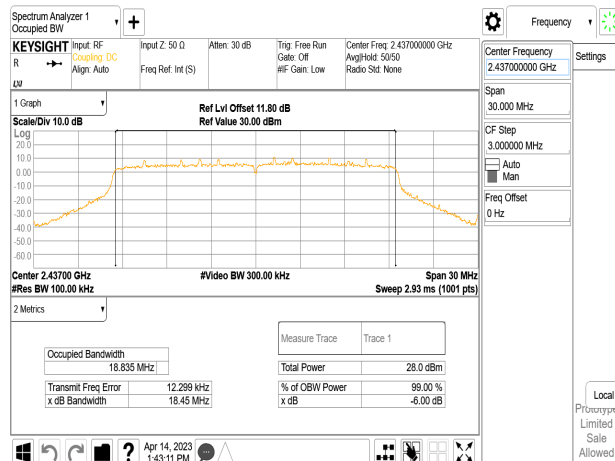

802.11ax\_20MHz\_Chain0\_2462MHz

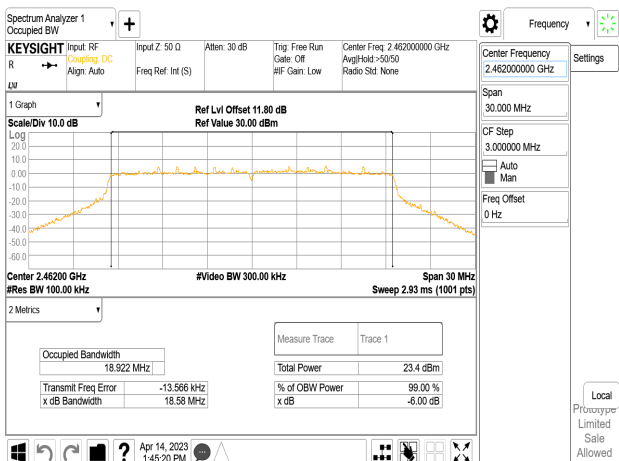

802.11ax\_20MHz\_Chain1\_2462MHz

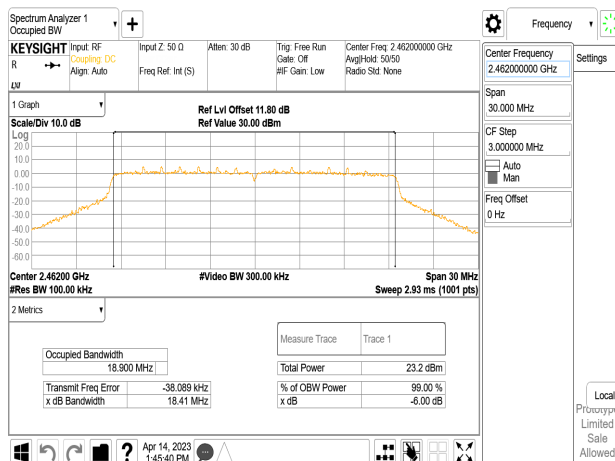

Unless otherwise stated the results shown in this test report refer only to the sample(s) tested and such sample(s) are retained for 90 days only.

除非另有說明，此報告結果僅對測試之樣品負責，同時此樣品僅保留90天。本報告未經本公司書面許可，不可部份複製。

This document is issued by the Company subject to its General Conditions of Service printed overleaf, available on request or accessible at <http://www.sgs.com.tw/Terms-and-Conditions> and for electronic format documents, subject to Terms and Conditions for Electronic Documents at <http://www.sgs.com.tw/Terms-and-Conditions>. Attention is drawn to the limitation of liability, indemnification and jurisdiction issues defined therein. Any holder of this document is advised that information contained hereon reflects the Company's findings at the time of its intervention only and within the limits of Client's instructions, if any. The Company's sole responsibility is to its Client and this document does not exonerate parties to a transaction from exercising all their rights and obligations under the transaction documents. This document cannot be reproduced except in full, without prior written approval of the Company. Any unauthorized alteration, forgery or falsification of the content or appearance of this document is unlawful and offenders may be prosecuted to the fullest extent of the law.

802.11ax\_40MHz\_Chain0\_2422MHz

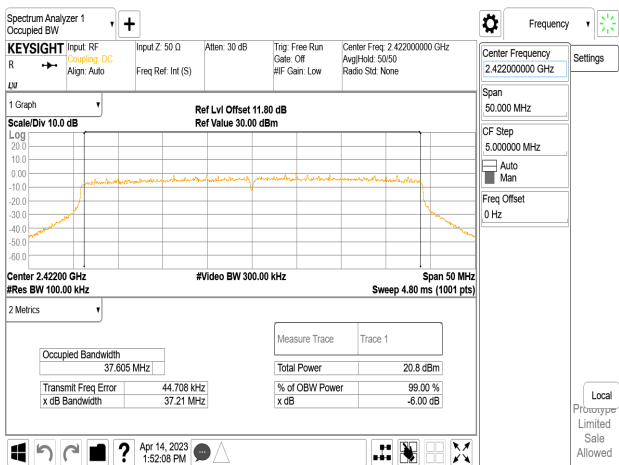

802.11ax\_40MHz\_Chain1\_2422MHz

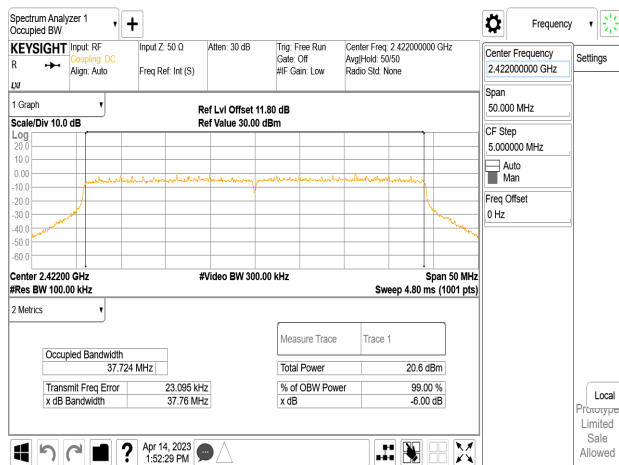

802.11ax\_40MHz\_Chain0\_2437MHz

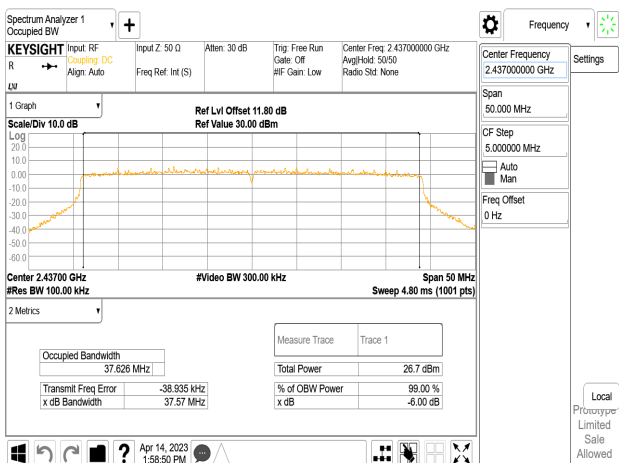

802.11ax\_40MHz\_Chain1\_2437MHz

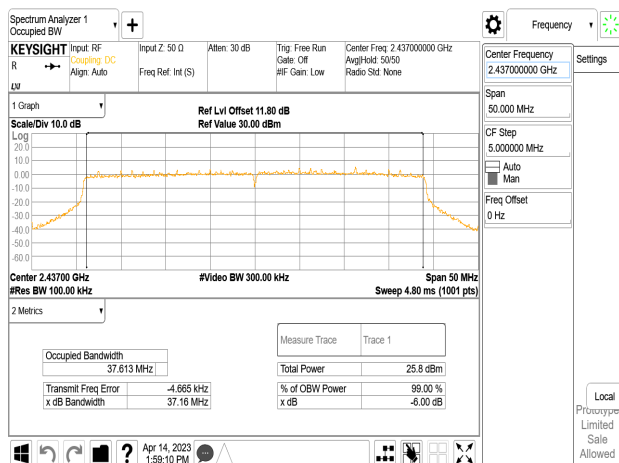

802.11ax\_40MHz\_Chain0\_2452MHz

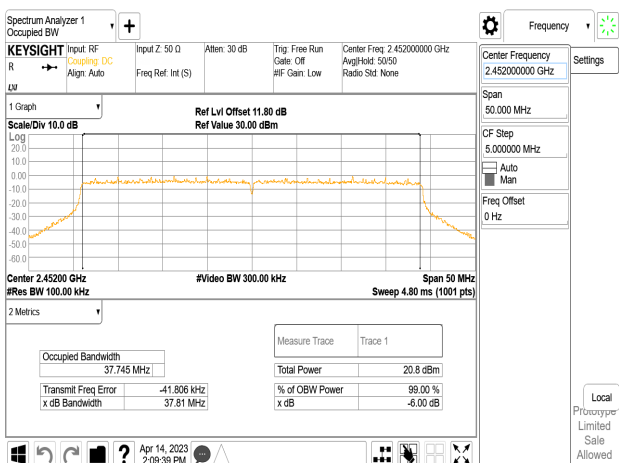

802.11ax\_40MHz\_Chain1\_2452MHz

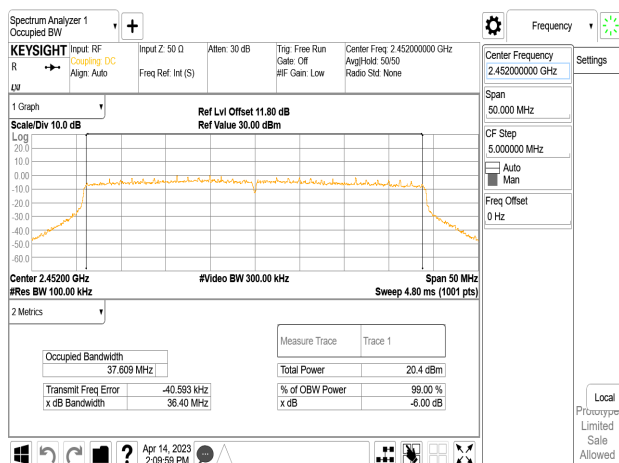

Unless otherwise stated the results shown in this test report refer only to the sample(s) tested and such sample(s) are retained for 90 days only.

除非另有說明，此報告結果僅對測試之樣品負責，同時此樣品僅保留90天。本報告未經本公司書面許可，不可部份複製。

This document is issued by the Company subject to its General Conditions of Service printed overleaf, available on request or accessible at <http://www.sgs.com.tw/Terms-and-Conditions> and for electronic format documents, subject to Terms and Conditions for Electronic Documents at <http://www.sgs.com.tw/Terms-and-Conditions>. Attention is drawn to the limitation of liability, indemnification and jurisdiction issues defined therein. Any holder of this document is advised that information contained hereon reflects the Company's findings at the time of its intervention only and within the limits of Client's instructions, if any. The Company's sole responsibility is to its Client and this document does not exonerate parties to a transaction from exercising all their rights and obligations under the transaction documents. This document cannot be reproduced except in full, without prior written approval of the Company. Any unauthorized alteration, forgery or falsification of the content or appearance of this document is unlawful and offenders may be prosecuted to the fullest extent of the law.



## 9.5 99% Bandwidth

**802.11b Ch0**

| Freq. (MHz) | 99% BW (MHz)  | Freq. (MHz) | 99% BW (MHz)  |
|-------------|---------------|-------------|---------------|
| 2412        | <b>12.947</b> | 2412        | 12.981        |
| 2437        | 12.932        | 2437        | 12.809        |
| 2462        | 12.945        | 2462        | <b>13.054</b> |

**802.11b Ch1**
**802.11g Ch0**

| Freq. (MHz) | 99% BW (MHz)  | Freq. (MHz) | 99% BW (MHz)  |
|-------------|---------------|-------------|---------------|
| 2412        | 16.433        | 2412        | 16.432        |
| 2437        | 16.405        | 2437        | 16.409        |
| 2462        | <b>16.436</b> | 2462        | <b>16.455</b> |

**802.11g Ch1**
**802.11n\_HT20M Ch0**

| Freq. (MHz) | 99% BW (MHz)  | Freq. (MHz) | 99% BW (MHz)  |
|-------------|---------------|-------------|---------------|
| 2412        | <b>17.634</b> | 2412        | 17.599        |
| 2437        | 17.624        | 2437        | 17.584        |
| 2462        | 17.633        | 2462        | <b>17.644</b> |

**802.11n\_HT20M Ch1**
**802.11n\_HT40M Ch0**

| Freq. (MHz) | 99% BW (MHz)  | Freq. (MHz) | 99% BW (MHz)  |
|-------------|---------------|-------------|---------------|
| 2422        | 36.008        | 2422        | <b>36.161</b> |
| 2437        | 36.026        | 2437        | 35.981        |
| 2452        | <b>36.154</b> | 2452        | 35.967        |

**802.11n\_HT40M Ch1**

Unless otherwise stated the results shown in this test report refer only to the sample(s) tested and such sample(s) are retained for 90 days only.

除非另有說明，此報告結果僅對測試之樣品負責，同時此樣品僅保留90天。本報告未經本公司書面許可，不可部份複製。

This document is issued by the Company subject to its General Conditions of Service printed overleaf, available on request or accessible at <http://www.sgs.com.tw/Terms-and-Conditions> and for electronic format documents, subject to Terms and Conditions for Electronic Documents at <http://www.sgs.com.tw/Terms-and-Conditions>. Attention is drawn to the limitation of liability, indemnification and jurisdiction issues defined therein. Any holder of this document is advised that information contained hereon reflects the Company's findings at the time of its intervention only and within the limits of Client's instructions, if any. The Company's sole responsibility is to its Client and this document does not exonerate parties to a transaction from exercising all their rights and obligations under the transaction documents. This document cannot be reproduced except in full, without prior written approval of the Company. Any unauthorized alteration, forgery or falsification of the content or appearance of this document is unlawful and offenders may be prosecuted to the fullest extent of the law.

802.11ax\_HE20M Ch0

802.11ax\_HE20M Ch1

| Freq. (MHz) | RU Config | 99% BW (MHz)  | Freq. (MHz) | RU Config | 99% BW (MHz) |
|-------------|-----------|---------------|-------------|-----------|--------------|
| 2412        | full      | 18.949        | 2412        | full      | 18.904       |
| 2437        | full      | <b>18.958</b> | 2437        | full      | 18.861       |
| 2462        | full      | 18.955        | 2462        | full      | 18.952       |

802.11ax\_HE40M Ch0

802.11ax\_HE40M Ch1

| Freq. (MHz) | RU Config | 99% BW (MHz)  | Freq. (MHz) | RU Config | 99% BW (MHz) |
|-------------|-----------|---------------|-------------|-----------|--------------|
| 2422        | full      | 37.704        | 2422        | full      | 37.751       |
| 2437        | full      | 37.689        | 2437        | full      | 37.618       |
| 2452        | full      | <b>37.808</b> | 2452        | full      | 37.609       |

Unless otherwise stated the results shown in this test report refer only to the sample(s) tested and such sample(s) are retained for 90 days only.  
 除非另有說明，此報告結果僅對測試之樣品負責，同時此樣品僅保留90天。本報告未經本公司書面許可，不可部份複製。

This document is issued by the Company subject to its General Conditions of Service printed overleaf, available on request or accessible at <http://www.sgs.com.tw/Terms-and-Conditions> and for electronic format documents, subject to Terms and Conditions for Electronic Documents at <http://www.sgs.com.tw/Terms-and-Conditions>. Attention is drawn to the limitation of liability, indemnification and jurisdiction issues defined therein. Any holder of this document is advised that information contained hereon reflects the Company's findings at the time of its intervention only and within the limits of Client's instructions, if any. The Company's sole responsibility is to its Client and this document does not exonerate parties to a transaction from exercising all their rights and obligations under the transaction documents. This document cannot be reproduced except in full, without prior written approval of the Company. Any unauthorized alteration, forgery or falsification of the content or appearance of this document is unlawful and offenders may be prosecuted to the fullest extent of the law.

802.11b\_20MHz\_Chain0\_2412MHz

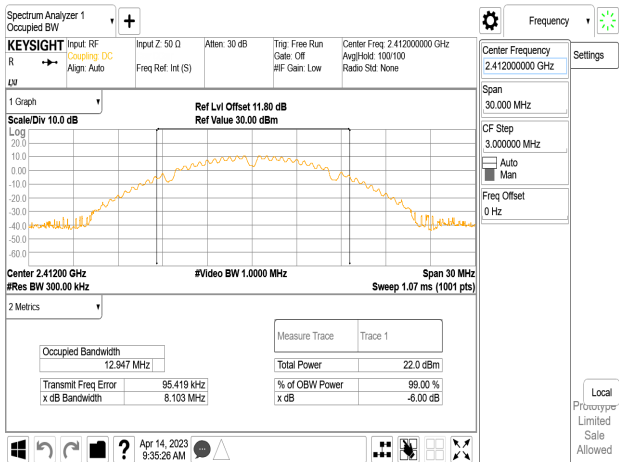

802.11b\_20MHz\_Chain1\_2412MHz

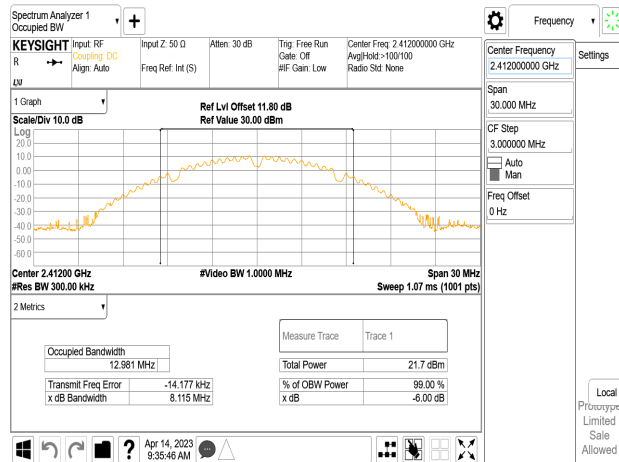

802.11b\_20MHz\_Chain0\_2437MHz

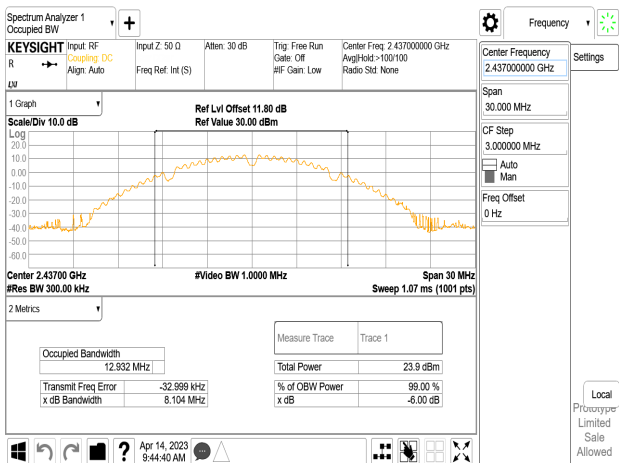

802.11b\_20MHz\_Chain1\_2437MHz

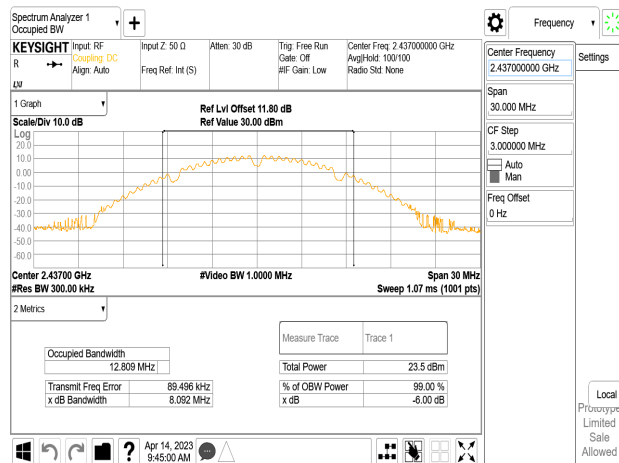

802.11b\_20MHz\_Chain0\_2462MHz

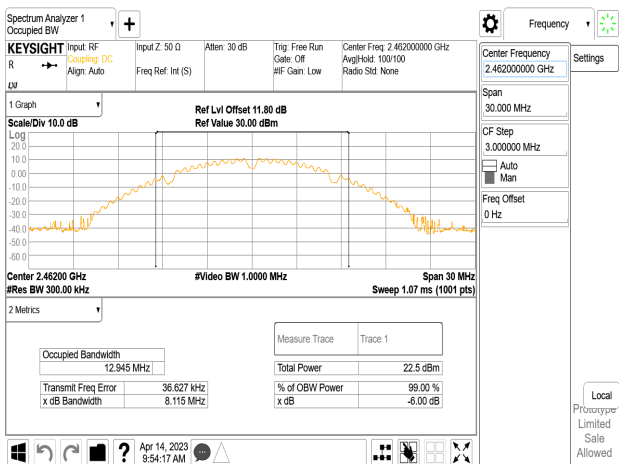

802.11b\_20MHz\_Chain1\_2462MHz

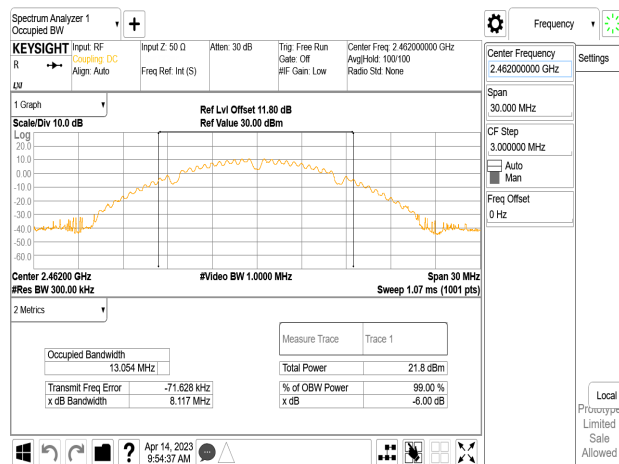

Unless otherwise stated the results shown in this test report refer only to the sample(s) tested and such sample(s) are retained for 90 days only.

除非另有說明，此報告結果僅對測試之樣品負責，同時此樣品僅保留90天。本報告未經本公司書面許可，不可部份複製。

This document is issued by the Company subject to its General Conditions of Service printed overleaf, available on request or accessible at <http://www.sgs.com.tw/Terms-and-Conditions> and for electronic format documents, subject to Terms and Conditions for Electronic Documents at <http://www.sgs.com.tw/Terms-and-Conditions>. Attention is drawn to the limitation of liability, indemnification and jurisdiction issues defined therein. Any holder of this document is advised that information contained hereon reflects the Company's findings at the time of its intervention only and within the limits of Client's instructions, if any. The Company's sole responsibility is to its Client and this document does not exonerate parties to a transaction from exercising all their rights and obligations under the transaction documents. This document cannot be reproduced except in full, without prior written approval of the Company. Any unauthorized alteration, forgery or falsification of the content or appearance of this document is unlawful and offenders may be prosecuted to the fullest extent of the law.

802.11g\_20MHz\_Chain0\_2412MHz

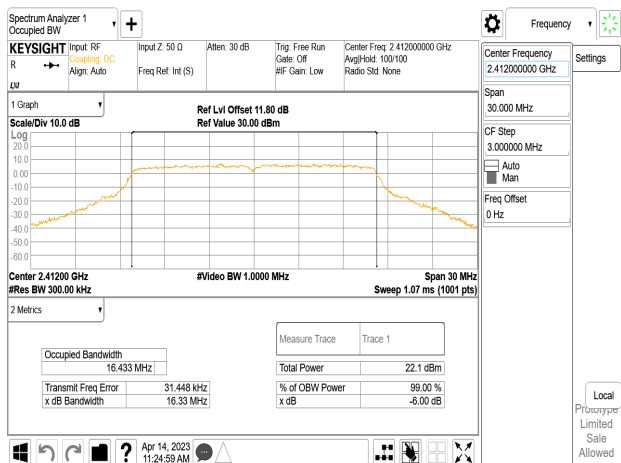

802.11g\_20MHz\_Chain1\_2412MHz

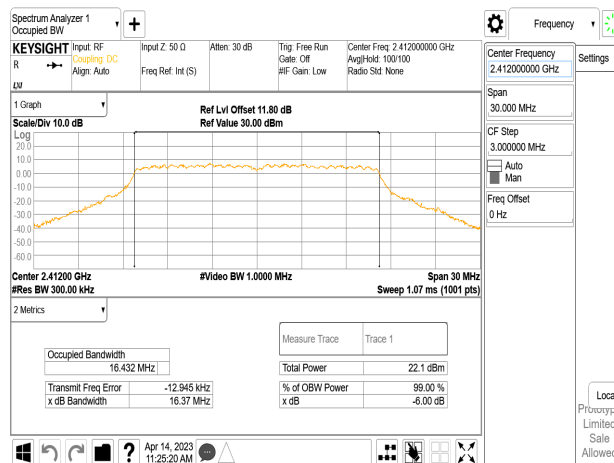

802.11g\_20MHz\_Chain0\_2437MHz

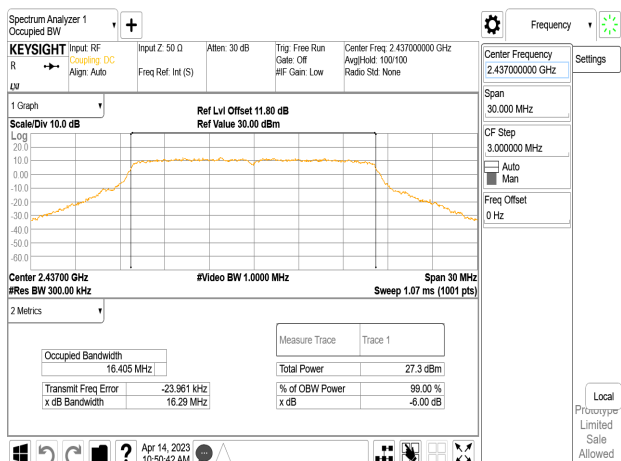

802.11g\_20MHz\_Chain1\_2437MHz

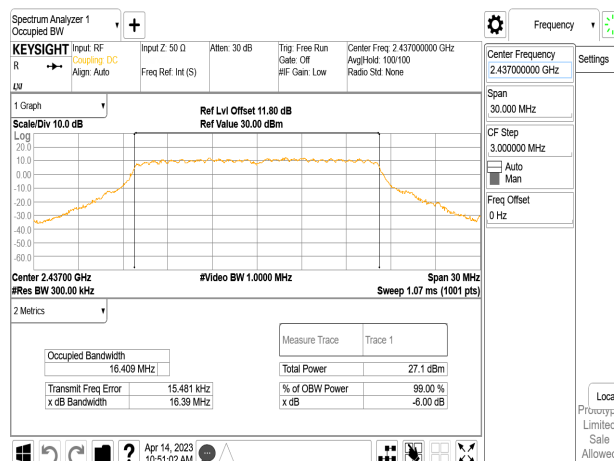

802.11g\_20MHz\_Chain0\_2462MHz

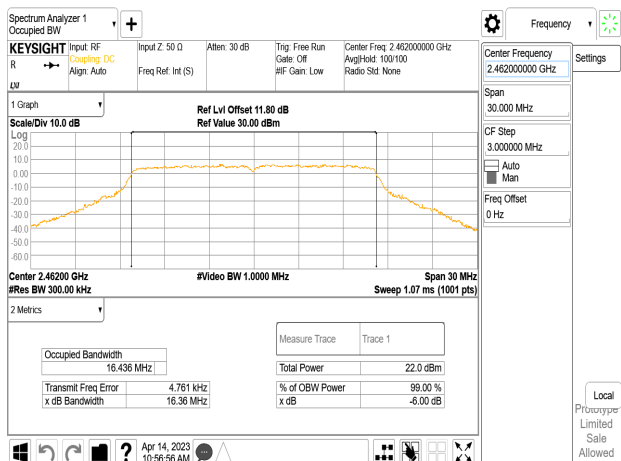

802.11g\_20MHz\_Chain1\_2462MHz

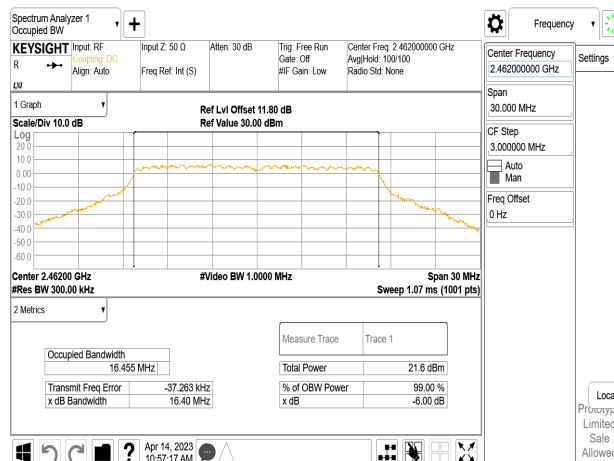

Unless otherwise stated the results shown in this test report refer only to the sample(s) tested and such sample(s) are retained for 90 days only.

除非另有說明，此報告結果僅對測試之樣品負責，同時此樣品僅保留90天。本報告未經本公司書面許可，不可部份複製。

This document is issued by the Company subject to its General Conditions of Service printed overleaf, available on request or accessible at <http://www.sgs.com.tw/Terms-and-Conditions> and for electronic format documents, subject to Terms and Conditions for Electronic Documents at <http://www.sgs.com.tw/Terms-and-Conditions>. Attention is drawn to the limitation of liability, indemnification and jurisdiction issues defined therein. Any holder of this document is advised that information contained hereon reflects the Company's findings at the time of its intervention only and within the limits of Client's instructions, if any. The Company's sole responsibility is to its Client and this document does not exonerate parties to a transaction from exercising all their rights and obligations under the transaction documents. This document cannot be reproduced except in full, without prior written approval of the Company. Any unauthorized alteration, forgery or falsification of the content or appearance of this document is unlawful and offenders may be prosecuted to the fullest extent of the law.

802.11n\_20MHz\_Chain0\_2412MHz

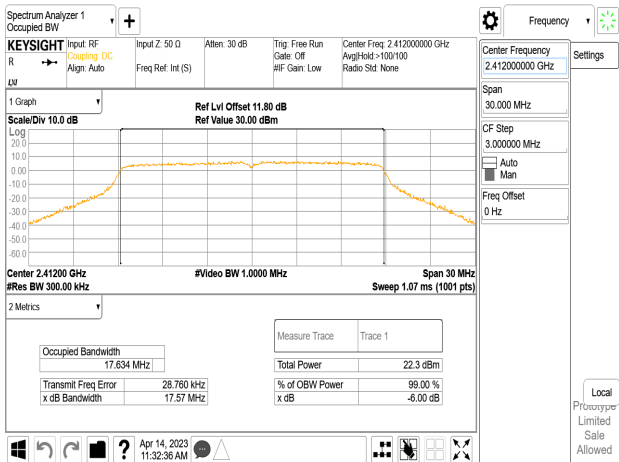

802.11n\_20MHz\_Chain1\_2412MHz

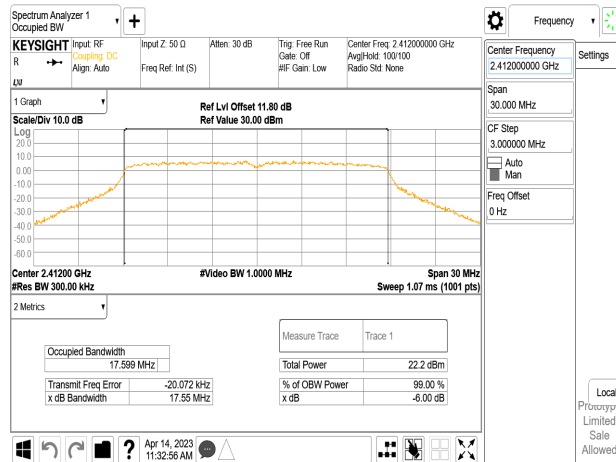

802.11n\_20MHz\_Chain0\_2437MHz

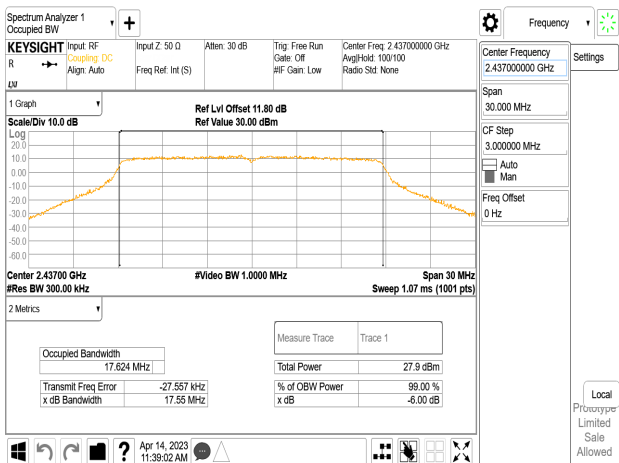

802.11n\_20MHz\_Chain1\_2437MHz

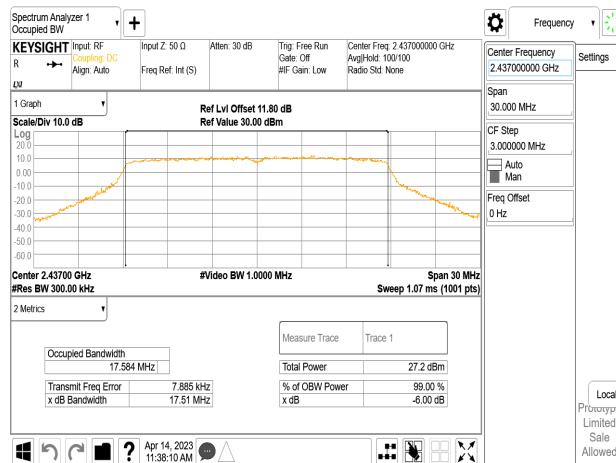

802.11n\_20MHz\_Chain0\_2462MHz

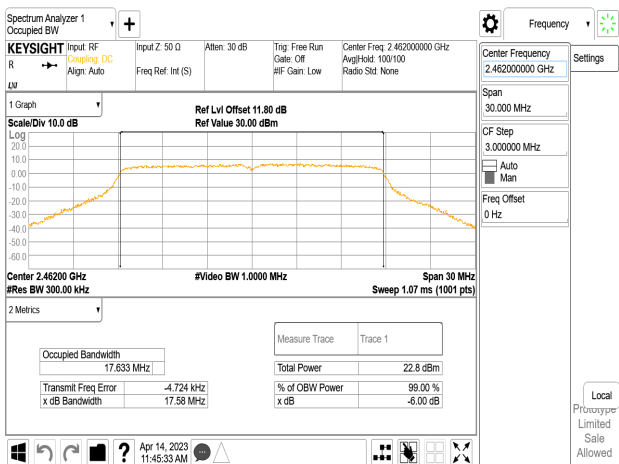

802.11n\_20MHz\_Chain1\_2462MHz

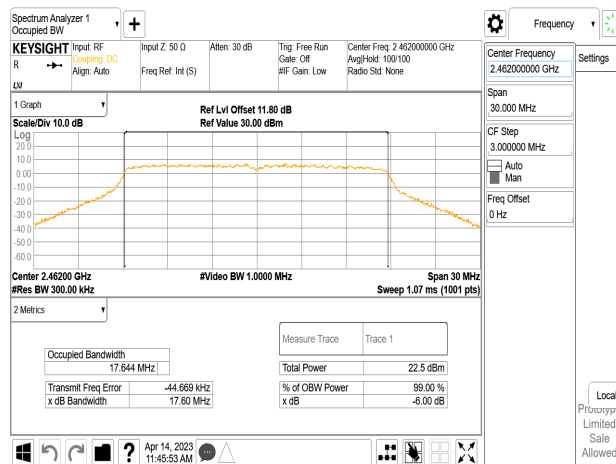

Unless otherwise stated the results shown in this test report refer only to the sample(s) tested and such sample(s) are retained for 90 days only.

除非另有說明，此報告結果僅對測試之樣品負責，同時此樣品僅保留90天。本報告未經本公司書面許可，不可部份複製。

This document is issued by the Company subject to its General Conditions of Service printed overleaf, available on request or accessible at <http://www.sgs.com.tw/Terms-and-Conditions> and for electronic format documents, subject to Terms and Conditions for Electronic Documents at <http://www.sgs.com.tw/Terms-and-Conditions>. Attention is drawn to the limitation of liability, indemnification and jurisdiction issues defined therein. Any holder of this document is advised that information contained hereon reflects the Company's findings at the time of its intervention only and within the limits of Client's instructions, if any. The Company's sole responsibility is to its Client and this document does not exonerate parties to a transaction from exercising all their rights and obligations under the transaction documents. This document cannot be reproduced except in full, without prior written approval of the Company. Any unauthorized alteration, forgery or falsification of the content or appearance of this document is unlawful and offenders may be prosecuted to the fullest extent of the law.