



FCC RF Test Report

APPLICANT : Montage
EQUIPMENT : GO7 3G GPS Tracker
BRAND NAME : Montage Asia
MODEL NAME : GO7 3G
FCC ID : N69-835100
STANDARD : FCC 47 CFR Part 2, 22(H), 24(E)
CLASSIFICATION : PCS Licensed Transmitter (PCB)

The product was received on Mar. 28, 2013 and completely tested on May 14, 2013. We, SPORTON INTERNATIONAL (SHENZHEN) INC., would like to declare that the tested sample has been evaluated in accordance with the procedures given in ANSI / TIA / EIA-603-C-2004 and shown compliance with the applicable technical standards.

The test results in this report apply exclusively to the tested model / sample. Without written approval of SPORTON INTERNATIONAL (SHENZHEN) INC., the test report shall not be reproduced except in full.

Reviewed by: Joseph Lin / Supervisor

Approved by: Jones Tsai / Manager



SPORTON INTERNATIONAL (SHENZHEN) INC.

No. 3 Building, the third floor of south, Shahe River west, Fengzeyuan warehouse, Nanshan District, Shenzhen, Guangdong, P.R.C.



TABLE OF CONTENTS

REVISION HISTORY..... 3

SUMMARY OF TEST RESULT 4

1 GENERAL DESCRIPTION 5

 1.1 Applicant..... 5

 1.2 Manufacturer 5

 1.3 Feature of Equipment Under Test..... 5

 1.4 Product Specification of Equipment Under Test 6

 1.5 Modification of EUT 6

 1.6 Maximum ERP/EIRP Power, Frequency Tolerance, and Emission Designator 6

 1.7 Testing Site 7

 1.8 Applied Standards 7

2 TEST CONFIGURATION OF EQUIPMENT UNDER TEST 8

 2.1 Test Mode..... 8

 2.2 Connection Diagram of Test System 9

 2.3 Support Unit used in test configuration and system..... 10

 2.4 Measurement Results Explanation Example 10

3 TEST RESULT..... 11

 3.1 Conducted Output Power Measurement..... 11

 3.2 Peak-to-Average Ratio 13

 3.3 Effective Radiated Power and Effective Isotropic Radiated Power Measurement 19

 3.4 99% Occupied Bandwidth and 26dB Bandwidth Measurement..... 23

 3.5 Band Edge Measurement..... 37

 3.6 Conducted Spurious Emission Measurement..... 46

 3.7 Field Strength of Spurious Radiation Measurement 57

 3.8 Frequency Stability Measurement..... 67

4 LIST OF MEASURING EQUIPMENT 74

5 UNCERTAINTY OF EVALUATION 75

APPENDIX A. PHOTOGRAPHS OF EUT

APPENDIX B. SETUP PHOTOGRAPHS



SUMMARY OF TEST RESULT

Report Section	FCC Rule	Description	Limit	Result	Remark
3.1	§2.1046	Conducted Output Power	N/A	PASS	-
3.2	§24.232(d)	Peak-to-Average Ratio	< 13 dB	PASS	-
3.3	§22.913(a)(2)	Effective Radiated Power	< 7 Watts	PASS	-
3.3	§24.232(c)	Equivalent Isotropic Radiated Power	< 2 Watts	PASS	-
3.4	§2.1049 §22.917(a) §24.238(b)	Occupied Bandwidth	N/A	PASS	-
3.5	§2.1051 §22.917(a) §24.238(a)	Band Edge Measurement	< 43+10log ₁₀ (P[Watts])	PASS	-
3.6	§2.1051 §22.917(a) §24.238(a)	Conducted Spurious Emission	< 43+10log ₁₀ (P[Watts])	PASS	-
3.7	§2.1053 §22.917(a) §24.238(a)	Field Strength of Spurious Radiation	< 43+10log ₁₀ (P[Watts])	PASS	Under limit 2.04 dB at 2509.000 MHz
3.8	§2.1055 §22.355 §24.235	Frequency Stability for Temperature & Voltage	< 2.5 ppm	PASS	-



1 General Description

1.1 Applicant

Montage

Flat J, 13/F, Tower C, NEO Enterprise Avenue, 6009 Shennan Mid Road, Futian, Shenzhen, CHINA
518048

1.2 Manufacturer

Montage

Flat J, 13/F, Tower C, NEO Enterprise Avenue, 6009 Shennan Mid Road, Futian, Shenzhen, CHINA
518048

1.3 Feature of Equipment Under Test

Product Feature	
Equipment	GO7 3G GPS Tracker
Brand Name	Montage Asia
Model Name	GO7 3G
FCC ID	N69-835100
EUT supports Radios application	GPRS/WCDMA/HSPA
HW Version	GO7_V103
SW Version	M7600_V1.7.6
EUT Stage	Identical Prototype

Remark: The above EUT's information was declared by manufacturer. Please refer to the specifications or user's manual for more detailed description.

1.4 Product Specification of Equipment Under Test

Product Specification subjective to this standard	
Tx Frequency	GSM850: 824.2 MHz ~ 848.8 MHz GSM1900: 1850.2 MHz ~ 1909.8MHz WCDMA Band V: 826.4 MHz ~ 846.6 MHz WCDMA Band II: 1852.4 MHz ~ 1907.6 MHz
Rx Frequency	GSM850: 869.2 MHz ~ 893.8 MHz GSM1900: 1930.2 MHz ~ 1989.8 MHz WCDMA Band V: 871.4 MHz ~ 891.6 MHz WCDMA Band II: 1932.4 MHz ~ 1987.6 MHz
Maximum Output Power to Antenna	GSM850 : 33.85 dBm GSM1900 : 29.56 dBm WCDMA Band V : 22.70 dBm WCDMA Band II : 23.56 dBm
Antenna Gain	-1 dBi for GSM850 and WCDMA Band V 1 dBi for GSM1900 and WCDMA Band II
Antenna Type	PIFA Antenna
Type of Modulation	GPRS: GMSK WCDMA: QPSK (Uplink) HSDPA: QPSK (Uplink) HSUPA: QPSK (Uplink)

1.5 Modification of EUT

No modifications are made to the EUT during all test items.

1.6 Maximum ERP/EIRP Power, Frequency Tolerance, and Emission Designator

FCC Rule	System	Type of Modulation	Maximum ERP/EIRP (W)	Frequency Tolerance (% , Hz, ppm)	Emission Designator
Part 22	GSM850 GPRS class 8	GMSK	0.6353	0.01 ppm	246KGXW
Part 22	WCDMA Band V RMC 12.2Kbps	QPSK	0.1042	0.01 ppm	4M22F9W
Part 24	GSM1900 GPRS class 8	GMSK	0.5984	0.02 ppm	246KGXW
Part 24	WCDMA Band II RMC 12.2Kbps	QPSK	0.1225	0.01 ppm	4M20F9W

1.7 Testing Site

Test Site	SPORTON INTERNATIONAL (SHENZHEN) INC.		
Test Site Location	No. 3 Building, the third floor of south, Shahe River west, Fengzeyuan warehouse, Nanshan District, Shenzhen, Guangdong, P.R.C. TEL: +86-755- 3320-2398		
Test Site No.	Sporton Site No.		FCC/IC Registration No.
	TH01-SZ	03CH01-SZ	831040/4086F-1

1.8 Applied Standards

According to the specifications of the manufacturer, the EUT must comply with the requirements of the following standards:

- ♦ FCC 47 CFR Part 2, 22(H), 24(E)
- ♦ ANSI / TIA / EIA-603-C-2004
- ♦ FCC KDB 971168 D01 Power Meas. License Digital Systems v02

Remark:

1. All test items were verified and recorded according to the standards and without any deviation during the test.
2. This EUT has also been tested and complied with the requirements of FCC Part 15, Subpart B, recorded in a separate test report.

2 Test Configuration of Equipment Under Test

2.1 Test Mode

During all testing, EUT is in link mode with base station emulator at maximum power level. The spurious emission measurements were carried out in semi-anechoic chamber with 3-meter test range.

Frequency range investigated for radiated emission is as follows:

1. 30 MHz to 9000 MHz for GSM850 and WCDMA Band V.
2. 30 MHz to 19000 MHz for GSM1900 and WCDMA Band II.

Test Modes		
Band	Radiated TCs	Conducted TCs
GSM 850	■ GPRS class 8 Link	■ GPRS class 8 Link
GSM 1900	■ GPRS class 8 Link	■ GPRS class 8 Link
WCDMA Band V	■ RMC 12.2Kbps Link	■ RMC 12.2Kbps Link
WCDMA Band II	■ RMC 12.2Kbps Link	■ RMC 12.2Kbps Link

Note:

The maximum power levels are GPRS multi-slot class 8 mode for GMSK link, RMC 12.2Kbps mode for WCDMA band V, and RMC 12.2Kbps mode for WCDMA band II, only these modes were used for all tests.

The conducted power tables are as follows:

Conducted Power (*Unit: dBm)						
Band	GSM850			GSM1900		
Channel	128	189	251	512	661	810
Frequency	824.2	836.4	848.8	1850.2	1880.0	1909.8
GPRS (GMSK, 1 Tx slot) – CS1	33.85	33.80	33.79	29.56	29.25	29.14
GPRS (GMSK, 2 Tx slots) – CS1	32.60	32.55	32.55	28.96	28.85	28.87
GPRS (GMSK, 3 Tx slots) – CS1	29.97	29.90	29.94	26.97	26.96	27.28
GPRS (GMSK, 4 Tx slots) – CS1	29.17	29.12	29.15	26.18	26.18	26.50

Conducted Power (*Unit: dBm)						
Band	WCDMA Band V			WCDMA Band II		
Channel	4132	4182	4233	9262	9400	9538
Frequency	826.4	836.4	846.6	1852.4	1880.0	1907.6
RMC 12.2K	22.70	22.50	22.67	23.20	23.21	23.56
HSDPA Subtest-1	22.66	22.54	22.65	23.04	23.06	23.41
HSDPA Subtest-2	21.71	21.53	21.68	22.07	22.08	22.43
HSDPA Subtest-3	21.26	21.04	21.25	21.59	21.59	21.96
HSDPA Subtest-4	21.25	21.03	21.30	21.56	21.57	21.91
HSUPA Subtest-1	20.74	20.53	20.71	19.52	19.51	19.85
HSUPA Subtest-2	19.76	19.54	19.73	20.04	20.06	20.43
HSUPA Subtest-3	19.74	19.53	19.70	20.03	20.04	20.39
HSUPA Subtest-4	20.20	20.01	20.16	21.08	21.07	21.45
HSUPA Subtest-5	20.57	20.40	20.57	19.62	19.60	19.93

2.2 Connection Diagram of Test System

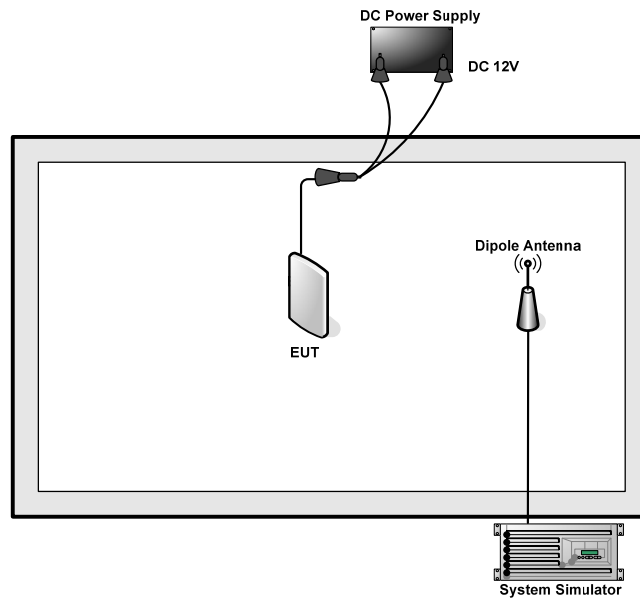

2.3 Support Unit used in test configuration and system

Item	Equipment	Trade Name	Model No.	FCC ID	Data Cable	Power Cord
1.	System Simulator	Agilent	E5515C	N/A	N/A	Unshielded, 1.8 m
2.	DC Power Supply	TOPWORD	3303DR	N/A	N/A	Unshielded, 1.8 m

2.4 Measurement Results Explanation Example

For all conducted test items:

The offset level is set in the spectrum analyzer to compensate the RF cable loss and attenuator factor between EUT conducted output port and spectrum analyzer. With the offset compensation, the spectrum analyzer reading level is exactly the EUT RF output level.

Example :

The spectrum analyzer offset is derived from RF cable loss and attenuator factor.

Offset = RF cable loss + attenuator factor.

Following shows an offset computation example with cable loss 7 dB and 10dB attenuator.

$$\begin{aligned} \text{Offset(dB)} &= \text{RF cable loss(dB)} + \text{attenuator factor(dB)}. \\ &= 7 + 10 = 17 \text{ (dB)} \end{aligned}$$

3 Test Result

3.1 Conducted Output Power Measurement

3.1.1 Description of the Conducted Output Power Measurement

A base station simulator was used to establish communication with the EUT. Its parameters were set to transmit the maximum power on the EUT. The measured power in the radio frequency on the transmitter output terminals shall be reported.

3.1.2 Measuring Instruments

See list of measuring instruments of this test report.

3.1.3 Test Procedures

1. The transmitter output port was connected to base station.
2. The RF output of EUT was connected to the spectrum analyzer by RF cable and attenuator. The path loss was compensated to the results for each measurement.
3. Set EUT at maximum power through base station.
4. Select lowest, middle, and highest channels for each band and different modulation.
5. Measure the maximum burst average power for GSM and maximum average power for other modulation signal.

3.1.4 Test Setup

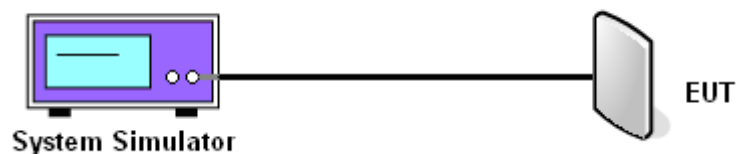

3.1.5 Test Result of Conducted Output Power

Cellular Band						
Modes	GSM850 (GPRS class 8)			WCDMA Band V (RMC 12.2Kbps)		
Channel	128 (Low)	189 (Mid)	251 (High)	4132 (Low)	4182 (Mid)	4233 (High)
Frequency (MHz)	824.2	836.4	848.8	826.4	836.4	846.6
Conducted Power (dBm)	33.85	33.80	33.79	22.70	22.50	22.67
Conducted Power (Watts)	2.43	2.40	2.39	0.19	0.18	0.18

PCS Band						
Modes	GSM1900 (GPRS class 8)			WCDMA Band II (RMC 12.2Kbps)		
Channel	512 (Low)	661 (Mid)	810 (High)	9262 (Low)	9400 (Mid)	9538 (High)
Frequency (MHz)	1850.2	1880	1909.8	1852.4	1880	1907.6
Conducted Power (dBm)	29.56	29.25	29.14	23.20	23.21	23.56
Conducted Power (Watts)	0.90	0.84	0.82	0.21	0.21	0.23

Note: maximum burst average power for GSM, and maximum average power for WCDMA.

3.2 Peak-to-Average Ratio

3.2.1 Description of the PAR Measurement

The peak-to-average ratio (PAR) of the transmission may not exceed 13 dB.

3.2.2 Measuring Instruments

See list of measuring instruments of this test report.

3.2.3 Test Procedures

1. The EUT was connected to Spectrum Analyzer and System Simulator via power divider.
2. For GPRS operating modes:
 - a. Set EUT in maximum power output.
 - b. Set the RBW = 1MHz, VBW = 3MHz, Peak detector in spectrum analyzer for first trace.
 - c. Set the RBW = 1MHz, VBW = 3MHz, RMS detector in spectrum analyzer for second trace.
 - d. The wanted burst signal is triggered by spectrum analyzer, and measured respectively the peak level and Mean level without burst-off time, after system simulator synchronized with the spectrum analyzer.
3. For UMTS operating modes:
 - a. Set the CCDF (Complementary Cumulative Distribution Function) option in spectrum analyzer.
 - b. The highest RF powers were measured and recorded the maximum PAPR level associated with a probability of 0.1 %.
4. Record the deviation as Peak to Average Ratio.

3.2.4 Test Setup

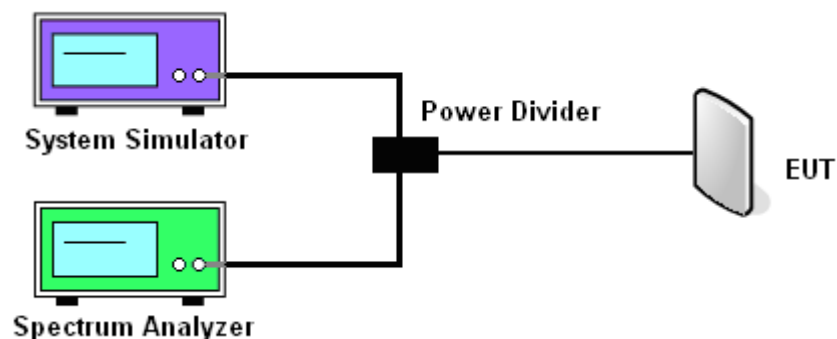



3.2.5 Test Result of Peak-to-Average Ratio

PCS Band						
Modes	GSM1900 (GPRS class 8)			WCDMA Band II (RMC 12.2Kbps)		
Channel	512 (Low)	661 (Mid)	810 (High)	9262 (Low)	9400 (Mid)	9538 (High)
Frequency (MHz)	1850.2	1880	1909.8	1852.4	1880	1907.6
Peak-to-Average Ratio (dB)	0.30	0.31	0.31	2.48	2.48	2.28

3.2.6 Test Result (Plots) of Peak-to-Average Ratio

Band :	GSM 1900	Test Mode :	GPRS class 8 Link (GMSK)
---------------	----------	--------------------	--------------------------

Peak-to-Average Ratio on Channel 512 (1850.2 MHz)

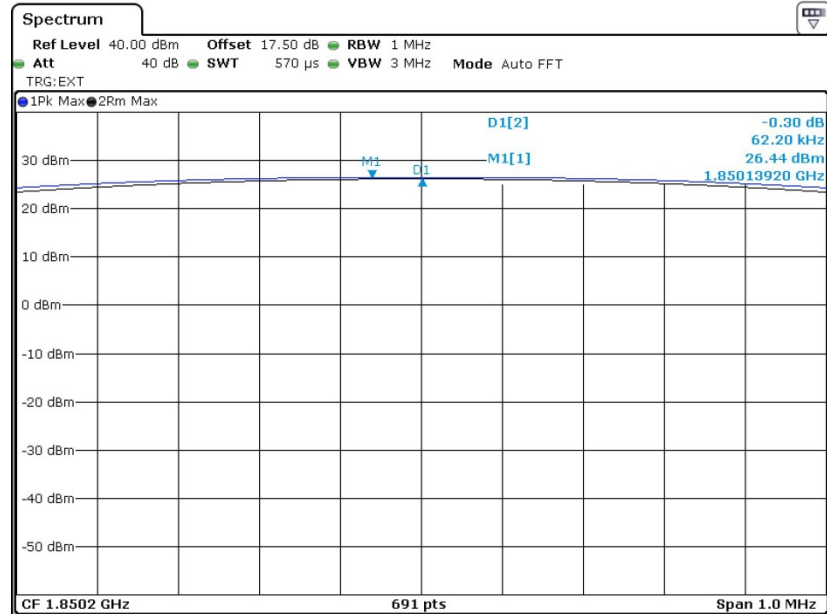

Date: 14.MAY.2013 13:09:11

Peak-to-Average Ratio on Channel 661 (1880.0 MHz)

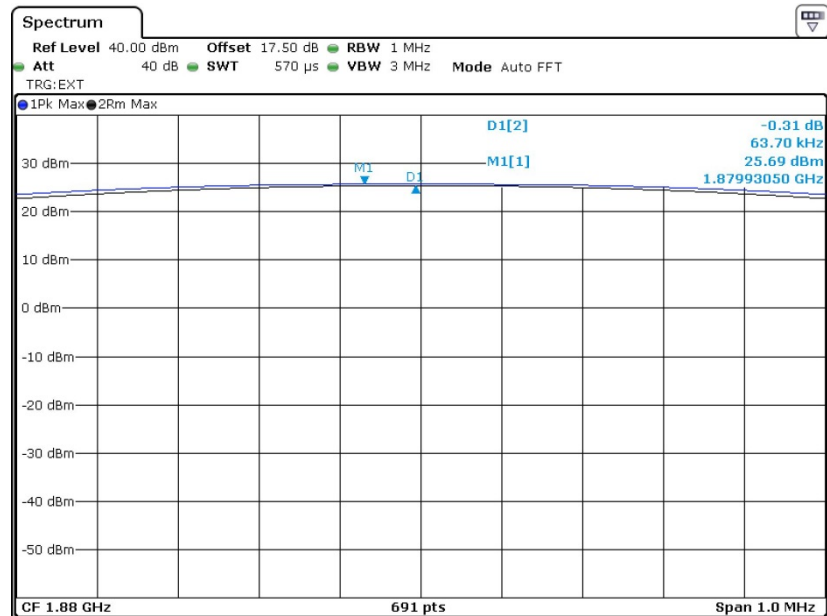

Date: 14.MAY.2013 13:05:57



Peak-to-Average Ratio on Channel 810 (1909.8 MHz)

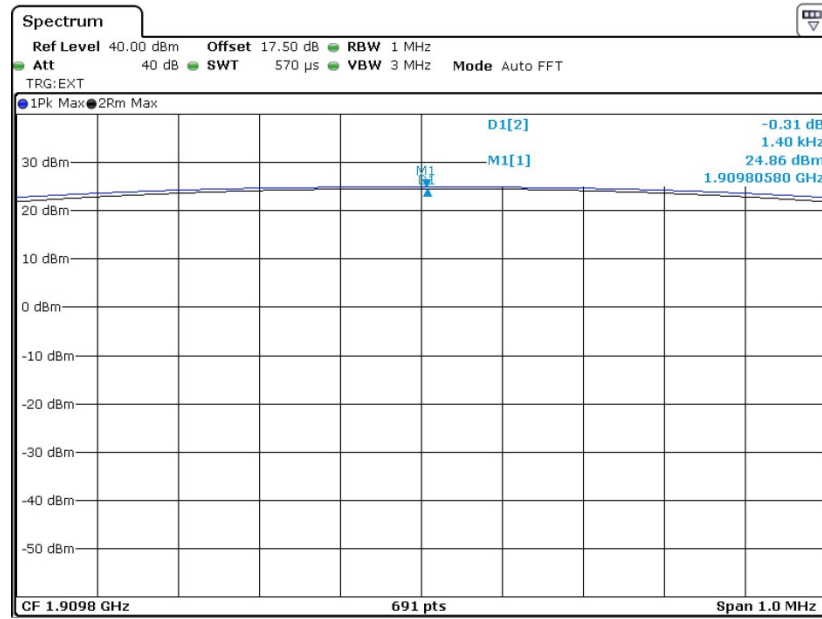

Date: 14.MAY.2013 13:04:49



Band :	WCDMA Band II	Test Mode :	RMC 12.2Kbps Link (QPSK)
---------------	---------------	--------------------	--------------------------

Peak-to-Average Ratio on Channel 9262 (1852.4 MHz)

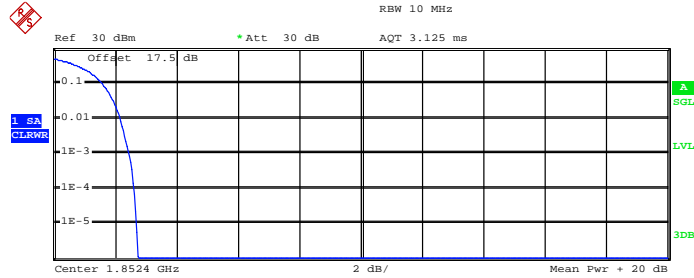

Complementary Cumulative Distribution Function (100000 samples)

Trace 1
 Mean 22.44 dBm
 Peak 25.17 dBm
 Crest 2.73 dB

10 % 1.60 dB
 1 % 2.16 dB
 .1 % 2.48 dB
 .01 % 2.64 dB

Date: 12.APR.2013 00:28:21

Peak-to-Average Ratio on Channel 9400 (1880.0 MHz)

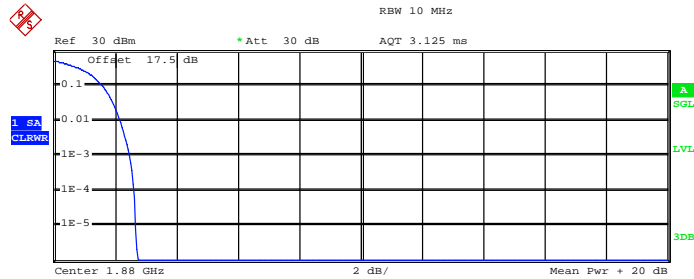

Complementary Cumulative Distribution Function (100000 samples)

Trace 1
 Mean 22.51 dBm
 Peak 25.24 dBm
 Crest 2.73 dB

10 % 1.60 dB
 1 % 2.16 dB
 .1 % 2.48 dB
 .01 % 2.64 dB

Date: 12.APR.2013 00:27:33



Peak-to-Average Ratio on Channel 9538 (1907.6 MHz)

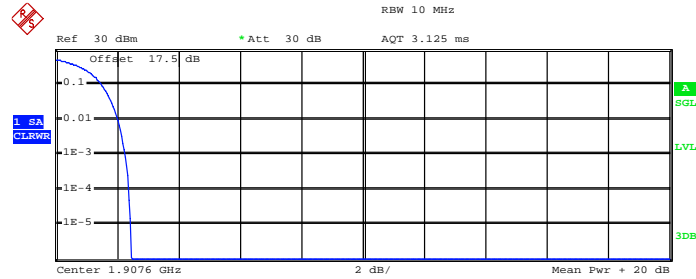

Complementary Cumulative Distribution Function (100000 samples)

Trace 1	
Mean	22.14 dBm
Peak	24.61 dBm
Crest	2.47 dB
10 %	1.52 dB
1 %	2.04 dB
.1 %	2.28 dB
.01 %	2.40 dB

Date: 12.APR.2013 00:26:06

3.3 Effective Radiated Power and Effective Isotropic Radiated Power Measurement

3.3.1 Description of the ERP/EIRP Measurement

The substitution method, in ANSI / TIA / EIA-603-C-2004, was used for ERP/EIRP measurement, and the spectrum analyzer configuration follows KDB 971168 D01 Power Meas. License Digital Systems v02. The ERP of mobile transmitters must not exceed 7 Watts and the EIRP of mobile transmitters are limited to 2 Watts.

3.3.2 Measuring Instruments

See list of measuring instruments of this test report.

3.3.3 Test Procedures

1. The EUT was placed on a non-conductive rotating platform with 0.8 meter height in a semi-anechoic chamber. The radiated emission at the fundamental frequency was measured at 3 m with a test antenna and a spectrum analyzer with RBW= 1MHz, VBW= 3MHz for GSM, RBW= 100 KHz, VBW= 300 KHz, used channel power option with bandwidth=5MHz for WCDMA, and RMS detector settings per KDB 971168 D01.
2. During the measurement, the EUT was enforced in maximum power and linked with a base station. The highest emission was recorded from analyzer power level (LVL) from the 360 degrees rotation of the turntable and the test antenna raised and lowered over a range from 1 to 4 meters in both horizontally and vertically polarized orientations.
3. Effective Isotropic Radiated Power (EIRP) was measured by substitution method according to TIA/EIA-603-C. The EUT was replaced by dipole antenna (substitution antenna) at same location, and then a known power from S.G. was applied into the dipole antenna through a Tx cable, and then recorded the maximum Analyzer reading through raised and lowered the test antenna. The correction factor (in dB) = S.G. - Tx Cable loss + Substitution antenna gain - Analyzer reading. Then the EUT's EIRP was calculated with the correction factor, $EIRP = LVL + \text{Correction factor}$ and $ERP = EIRP - 2.15$.

3.3.4 Test Setup

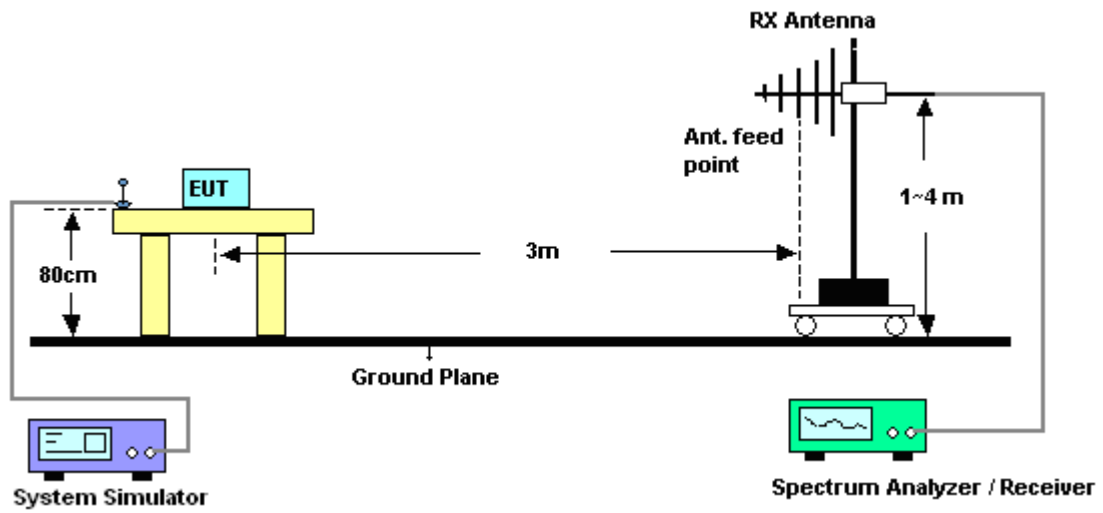

3.3.5 Test Result of ERP

GSM850 (GPRS class 8) Radiated Power ERP				
Horizontal Polarization				
Frequency (MHz)	LVL (dBm)	Correction Factor (dB)	ERP (dBm)	ERP (W)
824.2	-1.35	30.25	26.75	0.4732
836.4	-0.18	30.15	27.82	0.6053
848.8	0.13	30.05	28.03	0.6353
Vertical Polarization				
Frequency (MHz)	LVL (dBm)	Correction Factor (dB)	ERP (dBm)	ERP (W)
824.2	-4.31	33.29	26.83	0.4819
836.4	-4.25	33.29	26.89	0.4887
848.8	-4.16	33.26	26.95	0.4955

* ERP = LVL (dBm) + Correction Factor (dB) – 2.15

WCDMA Band V (RMC 12.2Kbps) Radiated Power ERP				
Horizontal Polarization				
Frequency (MHz)	LVL (dBm)	Correction Factor (dB)	ERP (dBm)	ERP (W)
826.40	-8.45	30.25	19.65	0.0923
836.40	-8.77	30.15	19.23	0.0838
846.60	-7.72	30.05	20.18	0.1042
Vertical Polarization				
Frequency (MHz)	LVL (dBm)	Correction Factor (dB)	ERP (dBm)	ERP (W)
826.40	-14.94	33.29	16.20	0.0417
836.40	-14.44	33.29	16.70	0.0468
846.60	-14.33	33.26	16.78	0.0476

* ERP = LVL (dBm) + Correction Factor (dB) – 2.15

3.3.6 Test Result of EIRP

GSM1900 (GPRS class 8) Radiated Power EIRP				
Horizontal Polarization				
Frequency (MHz)	LVL (dBm)	Correction Factor (dB)	EIRP (dBm)	EIRP (W)
1850.2	-14.94	42.33	27.39	0.5483
1880.0	-15.49	43.26	27.77	0.5984
1909.8	-15.78	43.11	27.33	0.5408
Vertical Polarization				
Frequency (MHz)	LVL (dBm)	Correction Factor (dB)	EIRP (dBm)	EIRP (W)
1850.2	-20.57	44.96	24.39	0.2748
1880.0	-20.77	45.13	24.36	0.2729
1909.8	-21.90	46.24	24.34	0.2716

* EIRP = LVL (dBm) + Correction Factor (dB)

WCDMA Band II (RMC 12.2Kbps) Radiated Power EIRP				
Horizontal Polarization				
Frequency (MHz)	LVL (dBm)	Correction Factor (dB)	EIRP (dBm)	EIRP (W)
1852.40	-22.73	42.39	19.66	0.0925
1880.00	-22.68	43.26	20.58	0.1143
1907.60	-22.17	43.05	20.88	0.1225
Vertical Polarization				
Frequency (MHz)	LVL (dBm)	Correction Factor (dB)	EIRP (dBm)	EIRP (W)
1852.40	-26.03	44.90	18.87	0.0771
1880.00	-26.94	45.13	18.19	0.0659
1907.60	-26.95	46.48	19.53	0.0897

* EIRP = LVL (dBm) + Correction Factor (dB)

3.4 99% Occupied Bandwidth and 26dB Bandwidth Measurement

3.4.1 Description of 99% Occupied Bandwidth and 26dB Bandwidth Measurement

The 99% occupied bandwidth is the width of a frequency band such that, below the lower and above the upper frequency limits, the mean powers emitted are each equal to a specified percentage 0.5% of the total mean transmitted power.

The emission bandwidth is defined as the width of the signal between two points, located at the 2 sides of the carrier frequency, outside of which all emissions are attenuated at least 26 dB below the transmitter power.

3.4.2 Measuring Instruments

See list of measuring instruments of this test report.

3.4.3 Test Procedures

1. The EUT was connected to Spectrum Analyzer and Base Station via power divider.
2. The RF output of EUT was connected to the spectrum analyzer by RF cable and attenuator. The path loss was compensated to the results for each measurement.
3. The 99% occupied bandwidth were measured, set RBW= 1% of span, VBW= 3*RBW, sample detector, trace maximum hold.
4. The 26dB bandwidth were measured, set RBW= 1% of EBW, VBW= 3*RBW, peak detector, trace maximum hold.

3.4.4 Test Setup

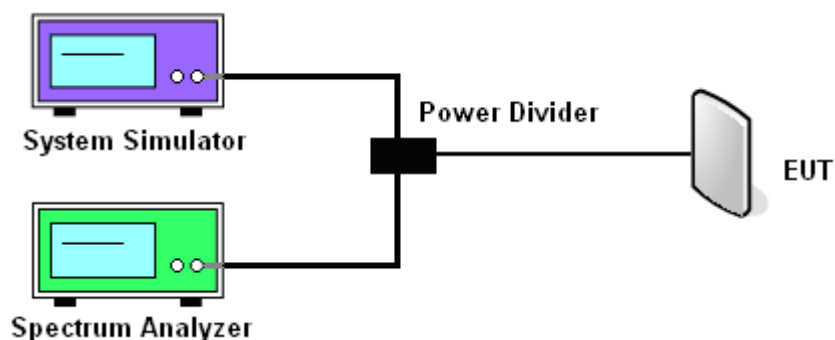

3.4.5 Test Result of Occupied Bandwidth and 26dB Bandwidth

Cellular Band			
Modes	GSM850 (GPRS class 8)		
Channel	128 (Low)	189 (Mid)	251 (High)
Frequency (MHz)	824.2	836.4	848.8
99% OBW (kHz)	246.00	244.00	244.00
26dB BW (kHz)	314.00	310.00	312.00

PCS Band			
Modes	GSM1900 (GPRS class 8)		
Channel	512 (Low)	661 (Mid)	810 (High)
Frequency (MHz)	1850.2	1880	1909.8
99% OBW (kHz)	246.00	246.00	246.00
26dB BW (kHz)	310.00	312.00	310.00

Cellular Band			
Modes	WCDMA Band V (RMC 12.2Kbps)		
Channel	4132 (Low)	4182 (Mid)	4233 (High)
Frequency (MHz)	826.4	836.4	846.6
99% OBW (MHz)	4.18	4.22	4.18
26dB BW (MHz)	4.70	4.82	4.70

PCS Band			
Modes	WCDMA Band II (RMC 12.2Kbps)		
Channel	9262 (Low)	9400 (Mid)	9538 (High)
Frequency (MHz)	1852.4	1880	1907.6
99% OBW (MHz)	4.20	4.18	4.18
26dB BW (MHz)	4.72	4.72	4.72



3.4.6 Test Result (Plots) of Occupied Bandwidth and 26dB Bandwidth

Band :	GSM 850	Test Mode :	GPRS class 8 Link (GMSK)
--------	---------	-------------	--------------------------

99% Occupied Bandwidth Plot on Channel 128 (824.2 MHz)

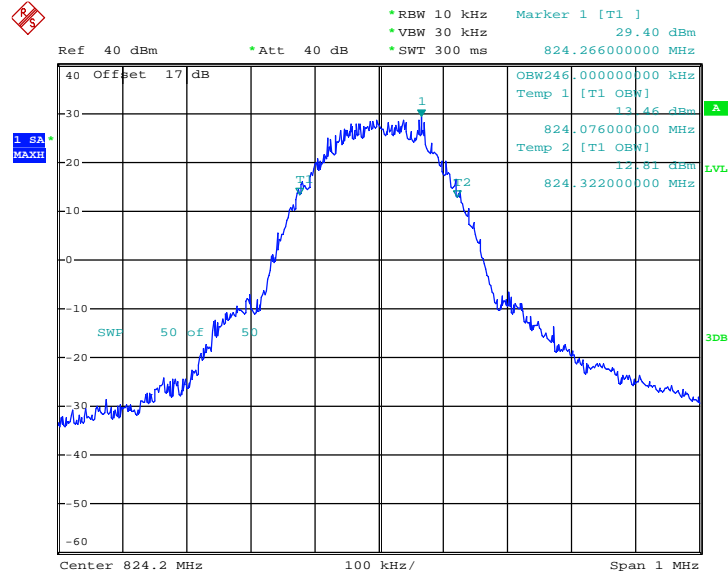

Date: 11.APR.2013 18:34:40

26dB Bandwidth Plot on Channel 128 (824.2 MHz)

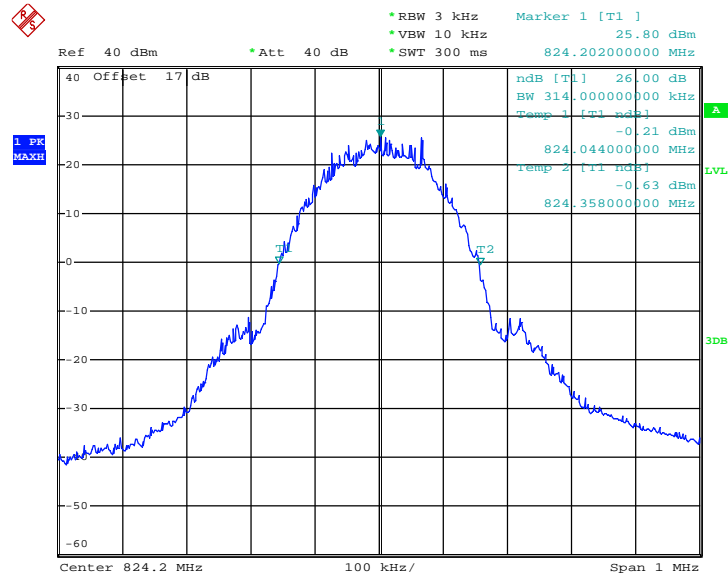

Date: 11.APR.2013 18:17:46



99% Occupied Bandwidth Plot on Channel 189 (836.4 MHz)

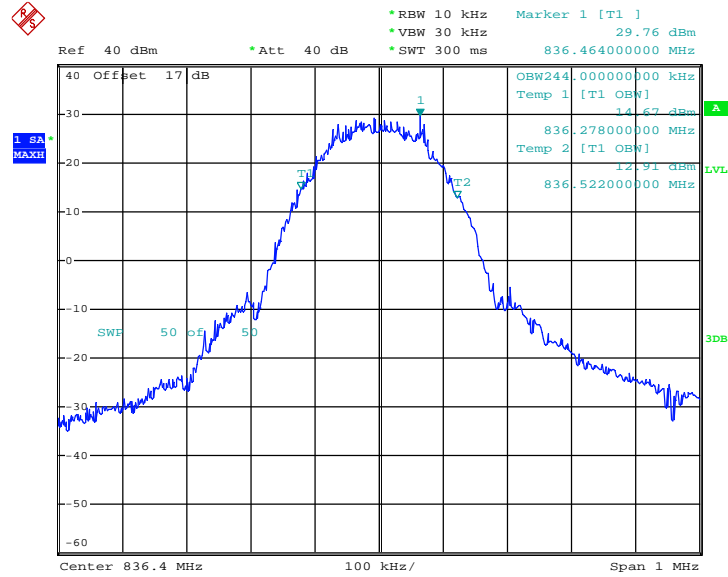

Date: 11.APR.2013 18:31:49

26dB Bandwidth Plot on Channel 189 (836.4 MHz)

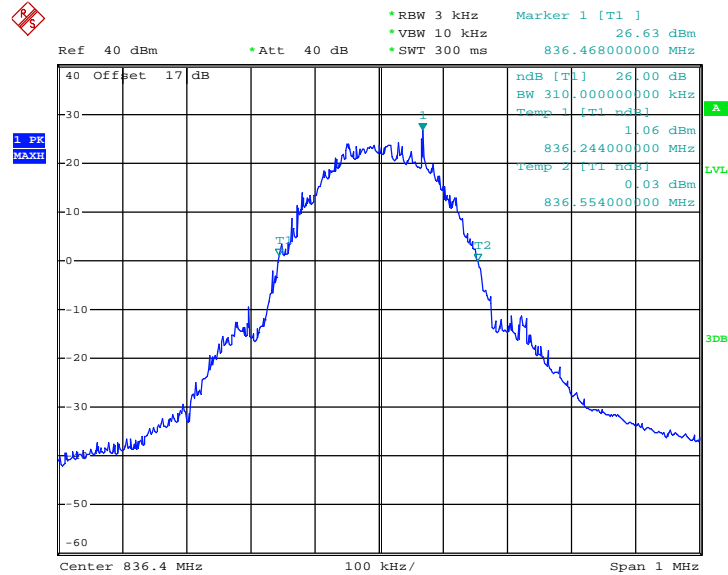

Date: 11.APR.2013 18:16:31



99% Occupied Bandwidth Plot on Channel 251 (848.8 MHz)

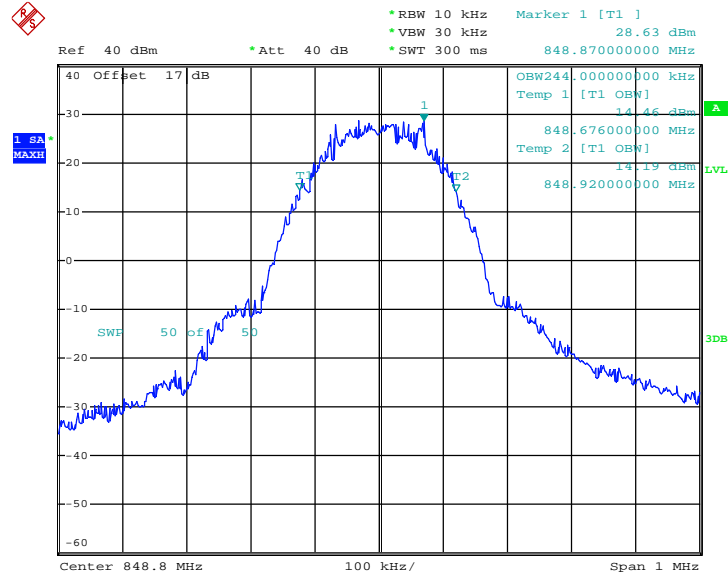

Date: 11.APR.2013 18:28:51

26dB Bandwidth Plot on Channel 251 (848.8 MHz)

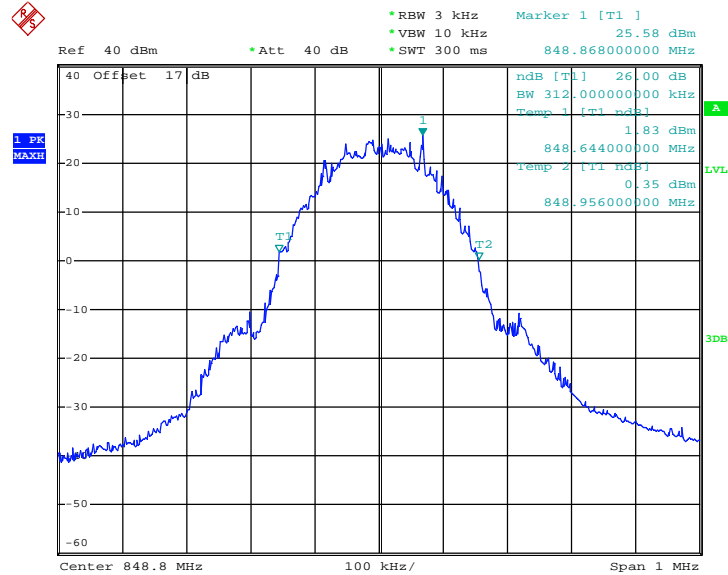

Date: 11.APR.2013 18:15:29



Band :	GSM 1900	Test Mode :	GPRS class 8 Link (GMSK)
--------	----------	-------------	--------------------------

99% Occupied Bandwidth Plot on Channel 512 (1850.2 MHz)

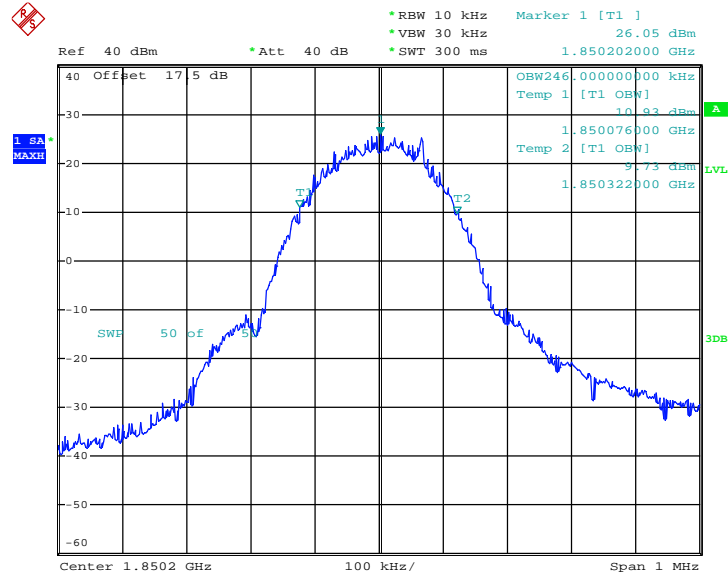

Date: 11.APR.2013 17:36:11

26dB Bandwidth Plot on Channel 512 (1850.2 MHz)

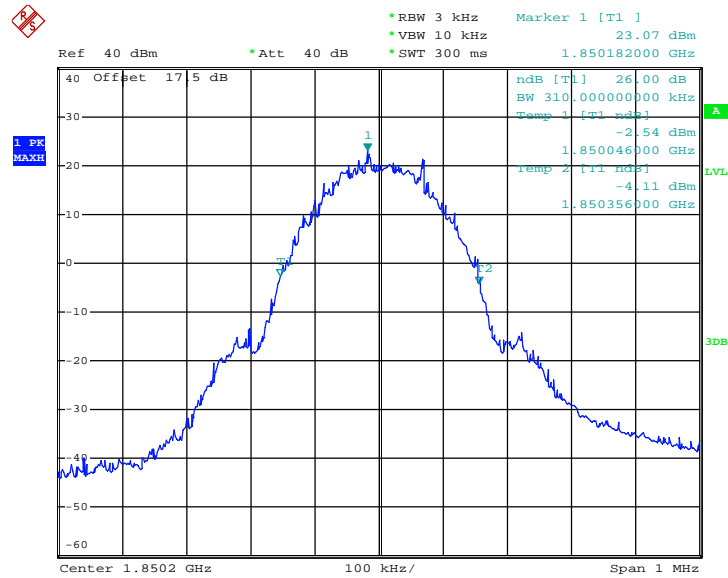

Date: 11.APR.2013 17:45:25



99% Occupied Bandwidth Plot on Channel 661 (1880.0 MHz)

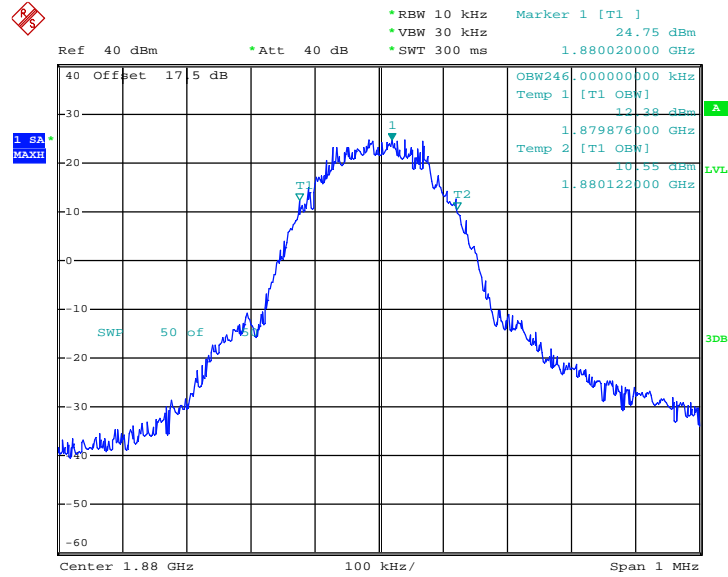

Date: 11.APR.2013 17:38:10

26dB Bandwidth Plot on Channel 661 (1880.0 MHz)

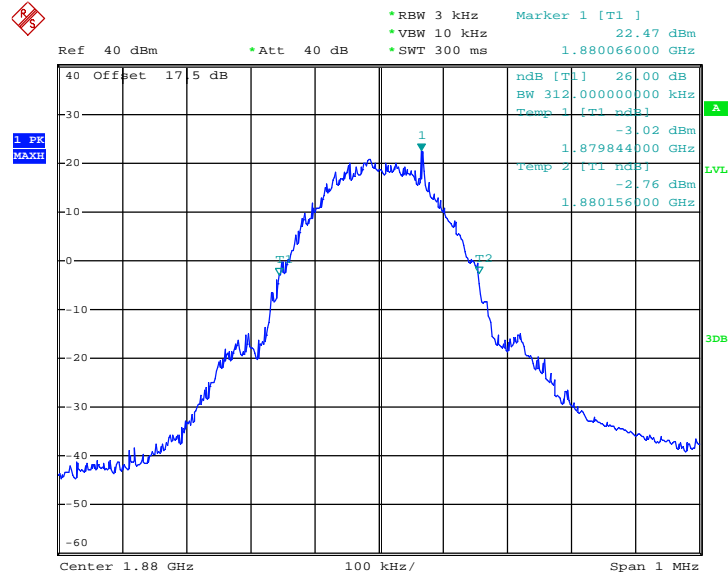

Date: 11.APR.2013 17:43:07



99% Occupied Bandwidth Plot on Channel 810 (1909.8 MHz)

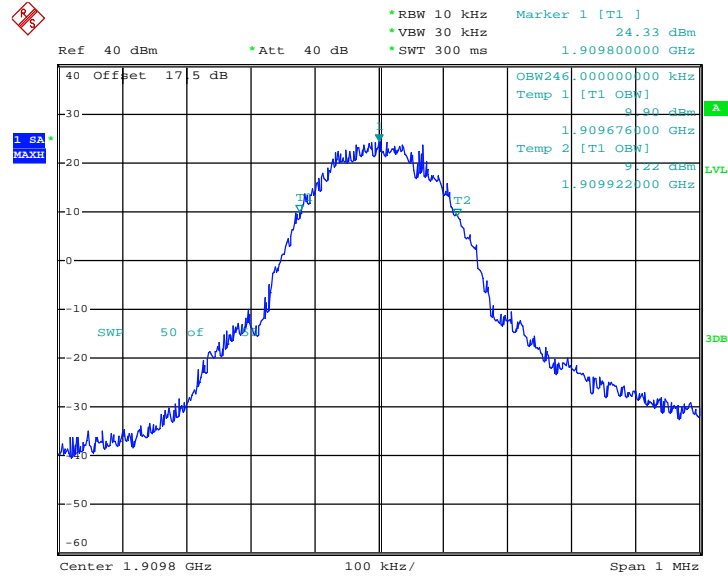

Date: 11.APR.2013 17:40:21

26dB Bandwidth Plot on Channel 810 (1909.8 MHz)

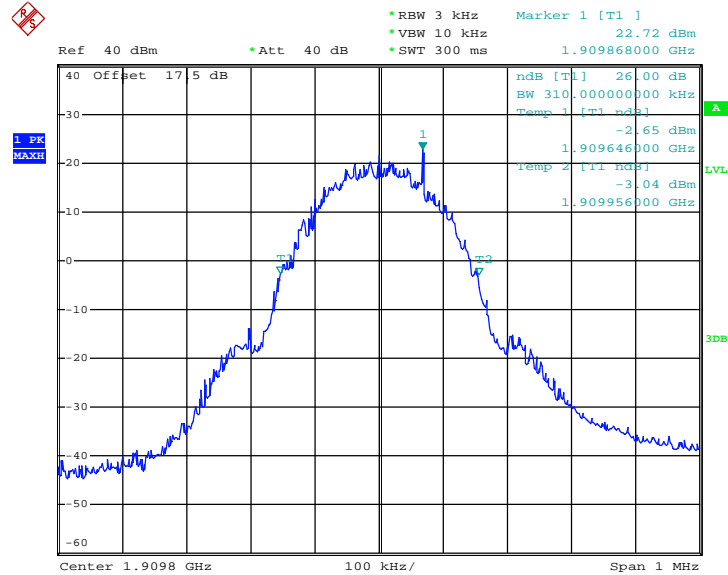

Date: 11.APR.2013 17:41:43



Band :	WCDMA Band V	Test Mode :	RMC 12.2Kbps Link (QPSK)
--------	--------------	-------------	--------------------------

99% Occupied Bandwidth Plot on Channel 4132 (826.4 MHz)

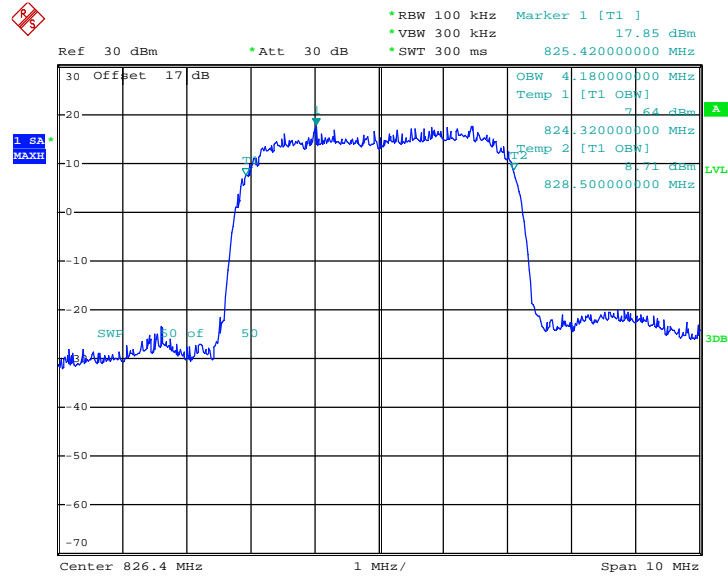

Date: 11.APR.2013 23:25:10

26dB Bandwidth Plot on Channel 4132 (826.4 MHz)

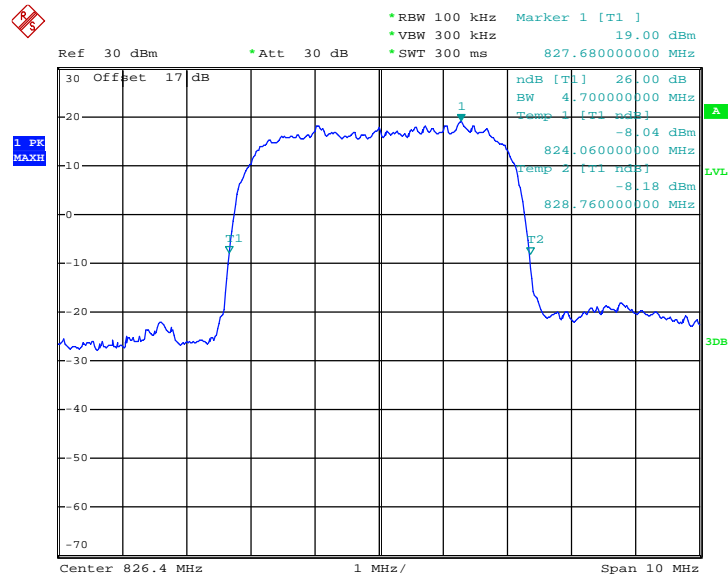

Date: 11.APR.2013 23:10:07



99% Occupied Bandwidth Plot on Channel 4182 (836.4 MHz)

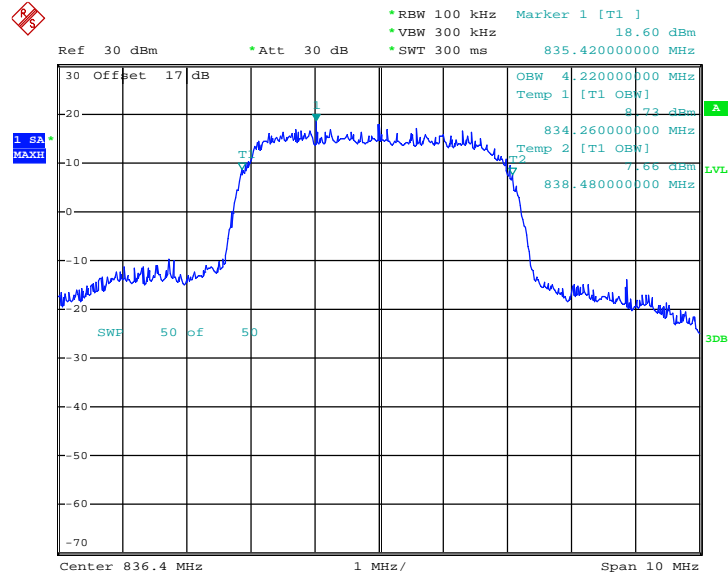

Date: 11.APR.2013 23:20:42

26dB Bandwidth Plot on Channel 4182 (836.4 MHz)

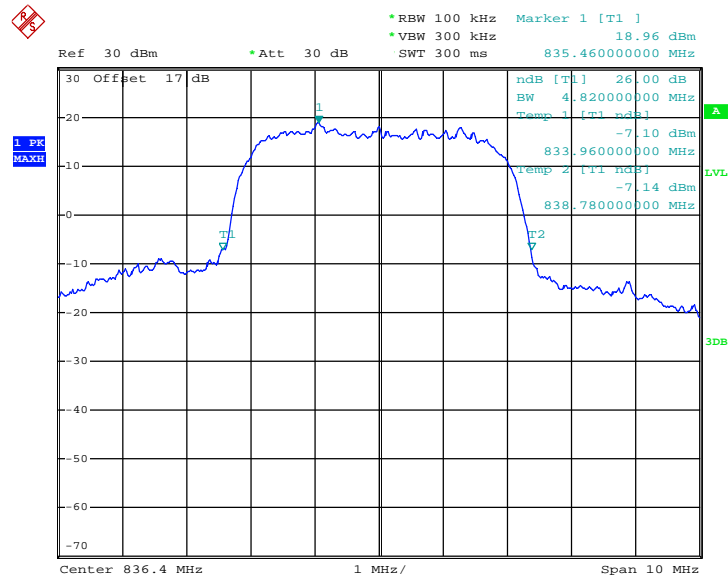

Date: 11.APR.2013 23:06:51



99% Occupied Bandwidth Plot on Channel 4233 (846.6 MHz)

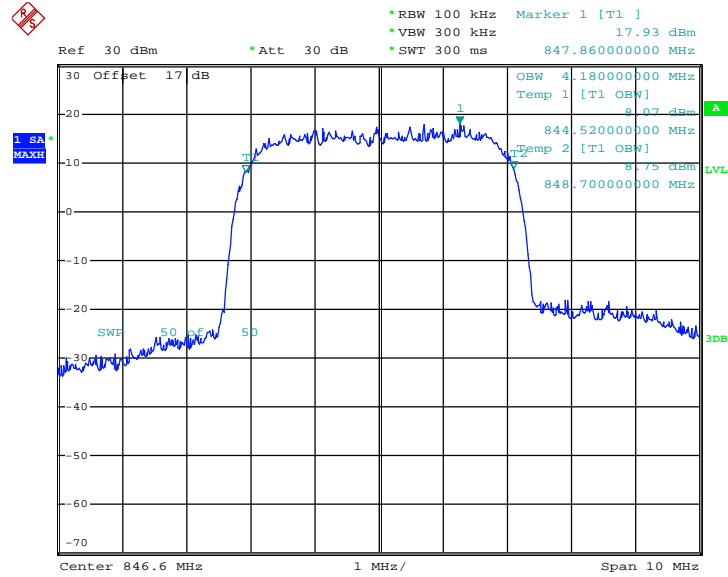

Date: 11.APR.2013 23:18:33

26dB Bandwidth Plot on Channel 4233 (846.6 MHz)

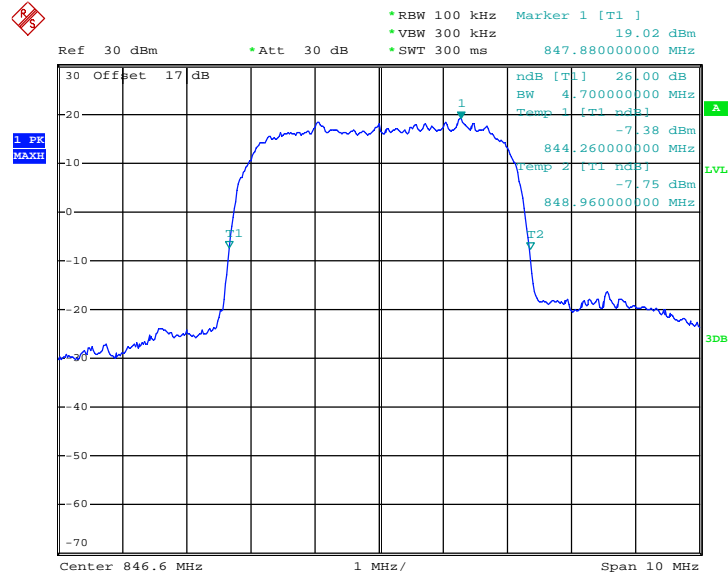

Date: 11.APR.2013 23:11:31



Band :	WCDMA Band II	Test Mode :	RMC 12.2Kbps Link (QPSK)
--------	---------------	-------------	--------------------------

99% Occupied Bandwidth Plot on Channel 9262 (1852.4 MHz)

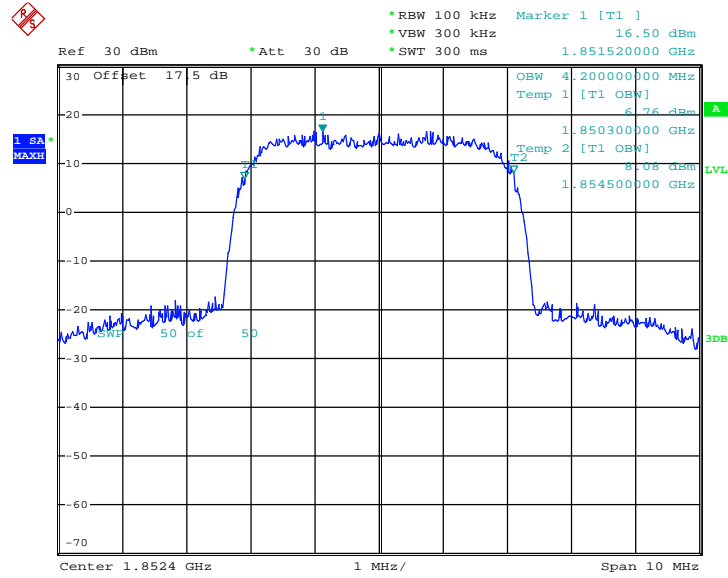

Date: 12.APR.2013 00:03:14

26dB Bandwidth Plot on Channel 9262 (1852.4 MHz)

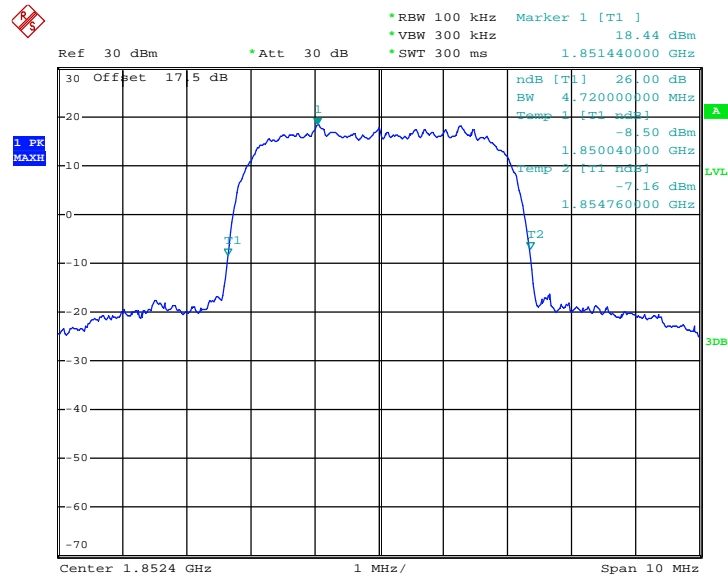

Date: 11.APR.2013 23:59:20



99% Occupied Bandwidth Plot on Channel 9400 (1880.0 MHz)

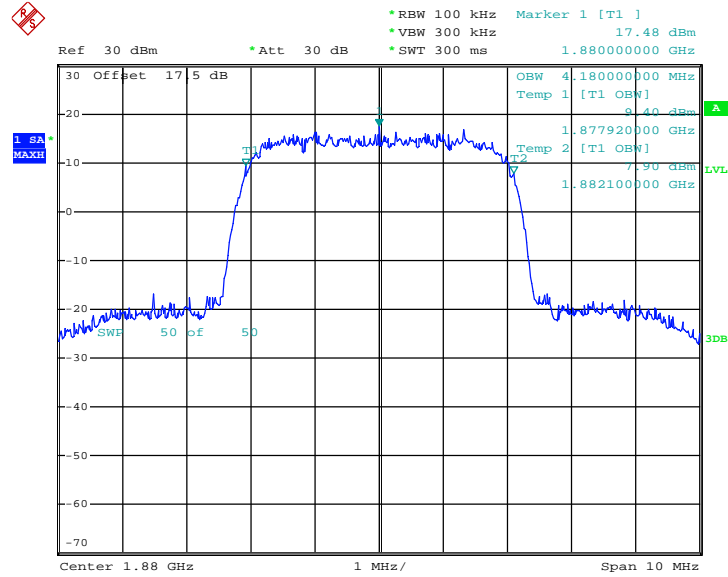

Date: 12.APR.2013 00:04:42

26dB Bandwidth Plot on Channel 9400 (1880.0 MHz)

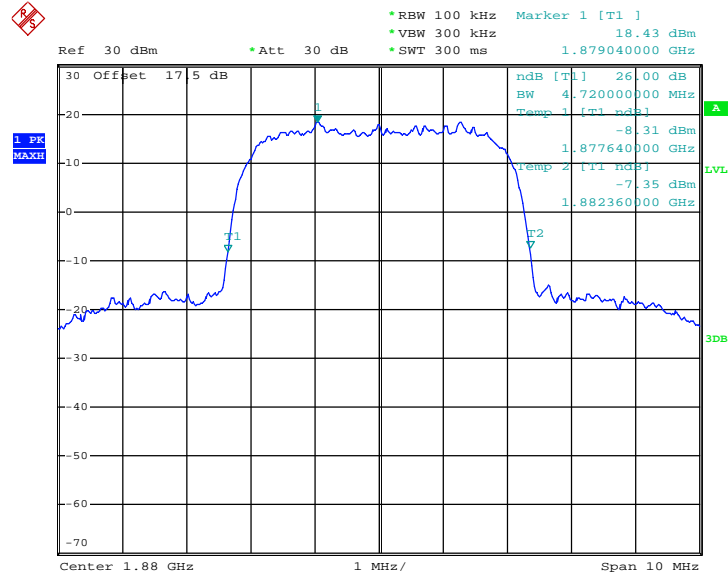

Date: 11.APR.2013 23:57:35



99% Occupied Bandwidth Plot on Channel 9538 (1907.6 MHz)

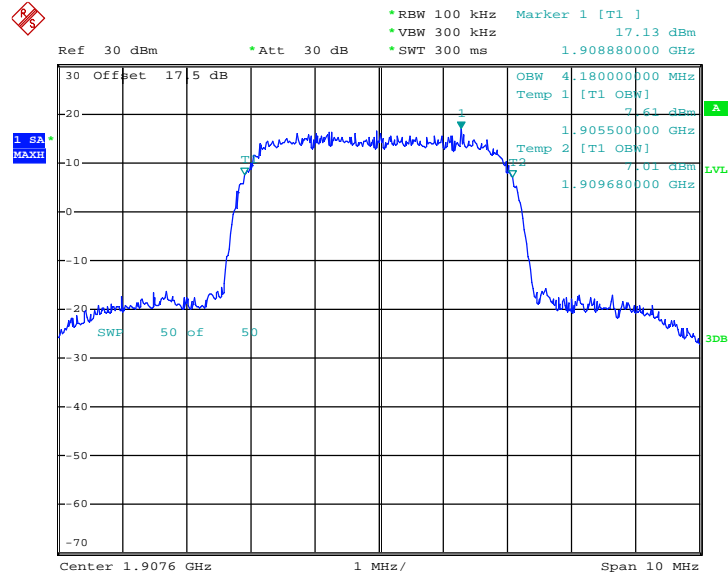

Date: 12.APR.2013 00:10:05

26dB Bandwidth Plot on Channel 9538 (1907.6 MHz)

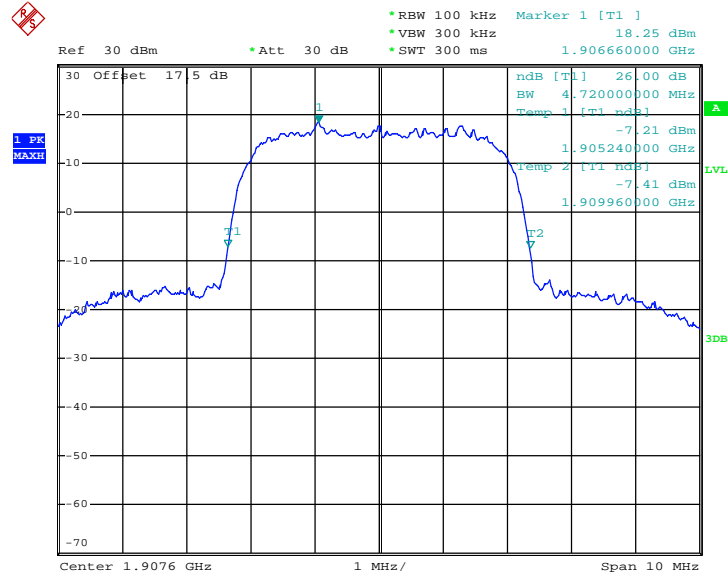

Date: 11.APR.2013 23:49:08

3.5 Band Edge Measurement

3.5.1 Description of Band Edge Measurement

The power of any emission outside of the authorized operating frequency ranges must be lower than the transmitter power (P) by a factor of at least $43 + 10 \log (P)$ dB.

3.5.2 Measuring Instruments

See list of measuring instruments of this test report.

3.5.3 Test Procedures

1. The EUT was connected to Spectrum Analyzer and Base Station via power divider.
2. The RF output of EUT was connected to the spectrum analyzer by RF cable and attenuator. The path loss was compensated to the results for each measurement.
3. The band edges of low and high channels for the highest RF powers were measured. Setting RBW as roughly $BW/100$.
4. The RF fundamental frequency should be excluded against the limit line in the operating frequency band.
5. The limit line is derived from $43 + 10\log(P)$ dB below the transmitter power P(Watts)
 $= P(W) - [43 + 10\log(P)]$ (dB)
 $= [30 + 10\log(P)]$ (dBm) - $[43 + 10\log(P)]$ (dB)
 $= -13\text{dBm}$.

3.5.4 Test Setup

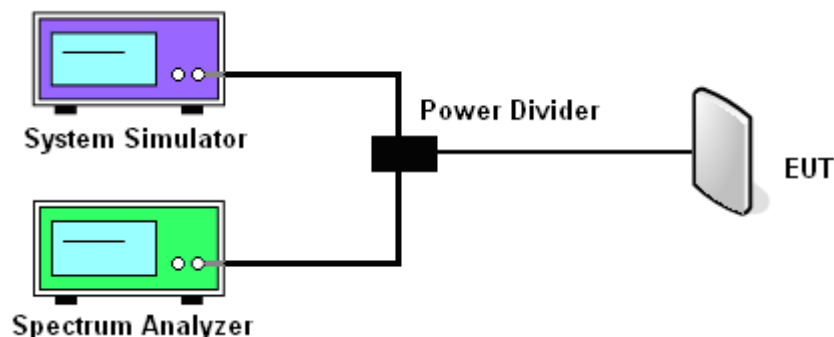

3.5.5 Test Result (Plots) of Conducted Band Edge

Band :	GSM850	Test Mode :	GPRS class 8 Link (GMSK)
Correction Factor :	0.20dB	Maximum 26dB Bandwidth :	0.314MHz
Band Edge :	-16.68dBm	Measurement Value :	-16.88dBm

Lower Band Edge Plot on Channel 128 (824.2 MHz)

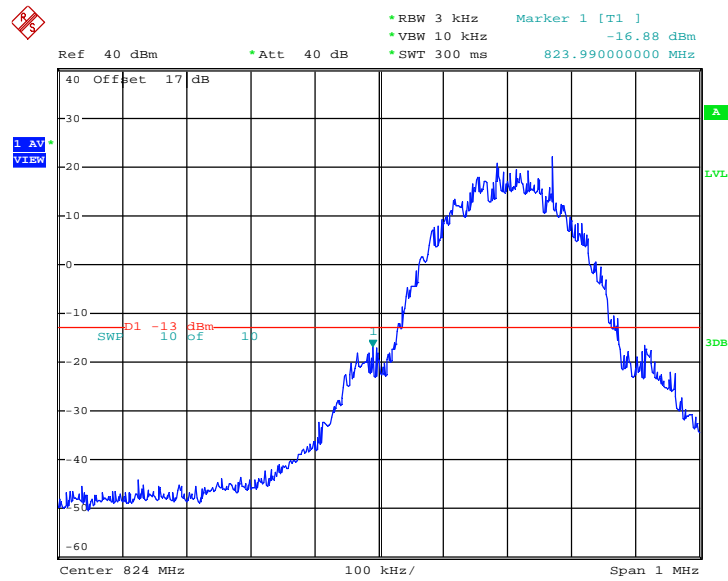

Date: 11.APR.2013 18:38:35

1. Correction Factor(dB)= $10\log(1\% \text{ Emission BW/RBW})$
 2. Band Edge= Measurement Value + Correction Factor(dB)
- For example, $-16.88\text{dBm} + 0.20\text{dB} = -16.68\text{dBm}$



Band :	GSM850	Test Mode :	GPRS class 8 Link (GMSK)
Correction Factor :	0.20dB	Maximum 26dB Bandwidth :	0.314MHz
Band Edge :	-16.37dBm	Measurement Value :	-16.57dBm

Higher Band Edge Plot on Channel 251 (848.8 MHz)

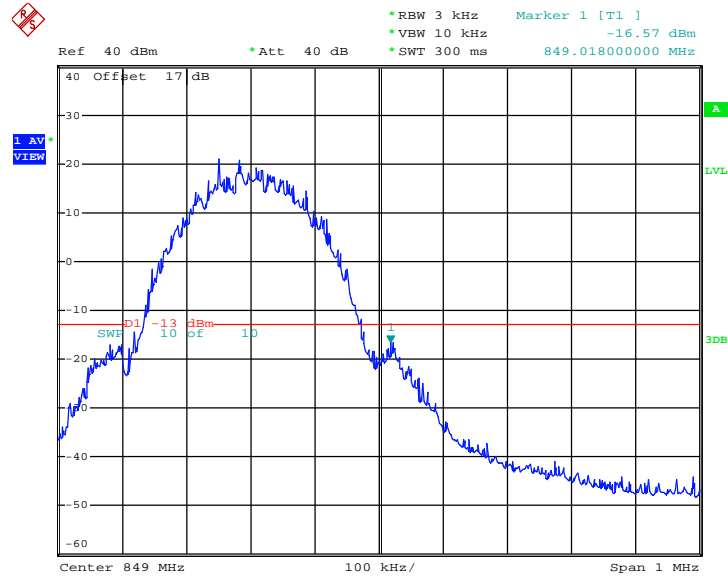

Date: 11.APR.2013 18:37:32

1. Correction Factor(dB)= 10log(1% Emission BW/RBW)
2. Band Edge= Measurement Value + Correction Factor(dB)



Band :	GSM1900	Test Mode :	GPRS class 8 Link (GMSK)
Correction Factor :	0.17dB	Maximum 26dB Bandwidth :	0.312MHz
Band Edge :	-20.30dBm	Measurement Value :	-20.47dBm

Lower Band Edge Plot on Channel 512 (1850.2 MHz)

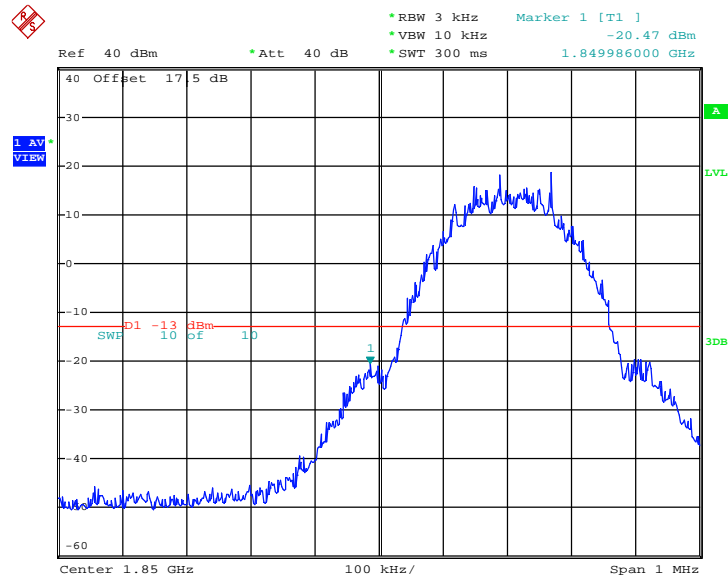

Date: 11.APR.2013 17:25:08

1. Correction Factor(dB)= $10\log(1\% \text{ Emission BW/RBW})$
2. Band Edge= Measurement Value + Correction Factor(dB)



Band :	GSM1900	Test Mode :	GPRS class 8 Link (GMSK)
Correction Factor :	0.17dB	Maximum 26dB Bandwidth :	0.312MHz
Band Edge :	-20.33dBm	Measurement Value :	-20.50dBm

Higher Band Edge Plot on Channel 810 (1909.8 MHz)

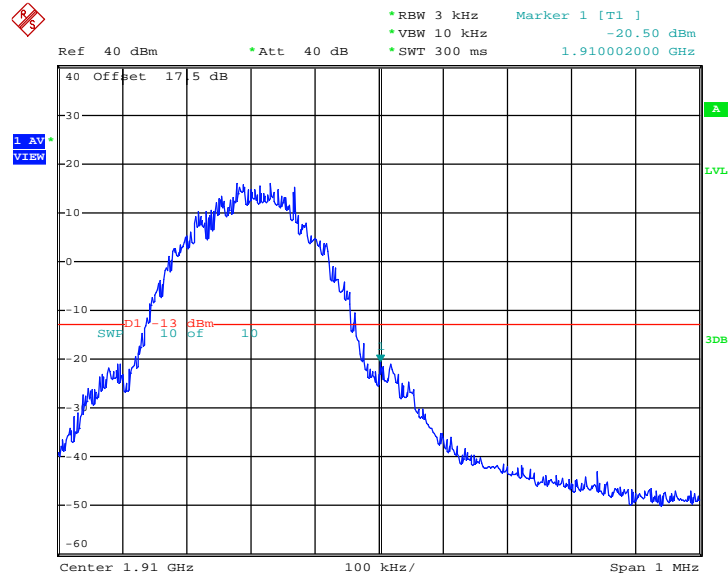

Date: 11.APR.2013 17:23:55

1. Correction Factor(dB)= 10log(1% Emission BW/RBW)
2. Band Edge= Measurement Value + Correction Factor(dB)



Band :	WCDMA Band V	Test Mode :	RMC 12.2Kbps Link (QPSK)
Correction Factor :	-3.17dB	Maximum 26dB Bandwidth :	4.820MHz
Band Edge :	-30.36dBm	Measurement Value :	-27.19dBm

Lower Band Edge Plot on Channel 4132 (826.4 MHz)

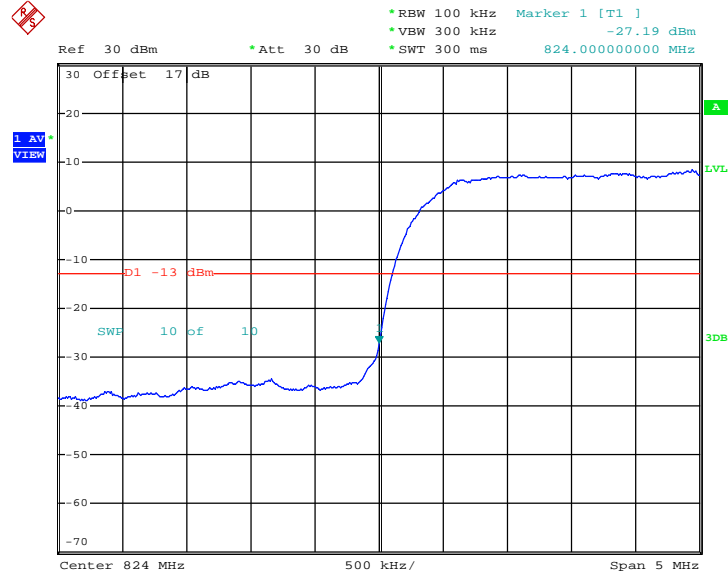

Date: 11.APR.2013 23:31:37

1. Correction Factor(dB)= 10log(1% Emission BW/RBW)
2. Band Edge= Measurement Value + Correction Factor(dB)



Band :	WCDMA Band V	Test Mode :	RMC 12.2Kbps Link (QPSK)
Correction Factor :	-3.17dB	Maximum 26dB Bandwidth :	4.820MHz
Band Edge :	-26.04dBm	Measurement Value :	-22.87dBm

Higher Band Edge Plot on Channel 4233 (846.6 MHz)

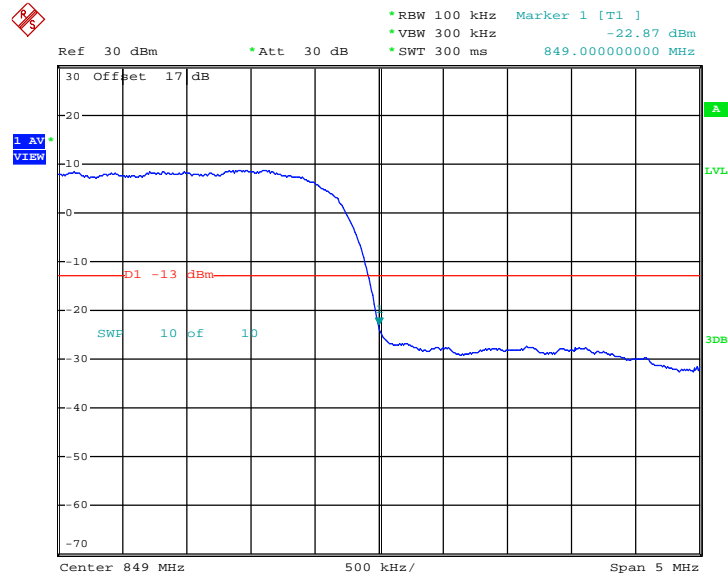

Date: 11.APR.2013 23:32:52

1. Correction Factor(dB)= $10\log(1\% \text{ Emission BW/RBW})$
2. Band Edge= Measurement Value + Correction Factor(dB)



Band :	WCDMA Band II	Test Mode :	RMC 12.2Kbps Link (QPSK)
Correction Factor :	-3.26dB	Maximum 26dB Bandwidth :	4.720MHz
Band Edge :	-25.16dBm	Measurement Value :	-21.90dBm

Lower Band Edge Plot on Channel 9262 (1852.4 MHz)

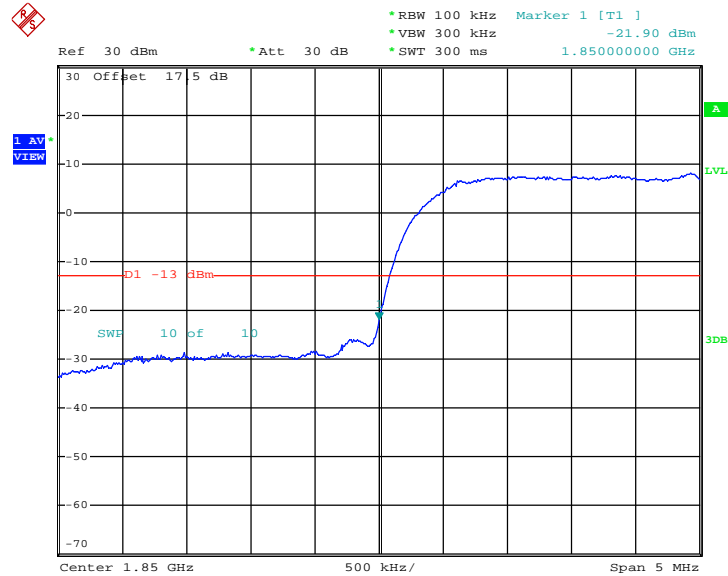

Date: 11.APR.2013 23:40:59

1. Correction Factor(dB)= $10\log(1\% \text{ Emission BW/RBW})$
2. Band Edge= Measurement Value + Correction Factor(dB)



Band :	WCDMA Band II	Test Mode :	RMC 12.2Kbps Link (QPSK)
Correction Factor :	-3.26dB	Maximum 26dB Bandwidth :	4.720MHz
Band Edge :	-23.95dBm	Measurement Value :	-20.69dBm

Higher Band Edge Plot on Channel 9538 (1907.6 MHz)

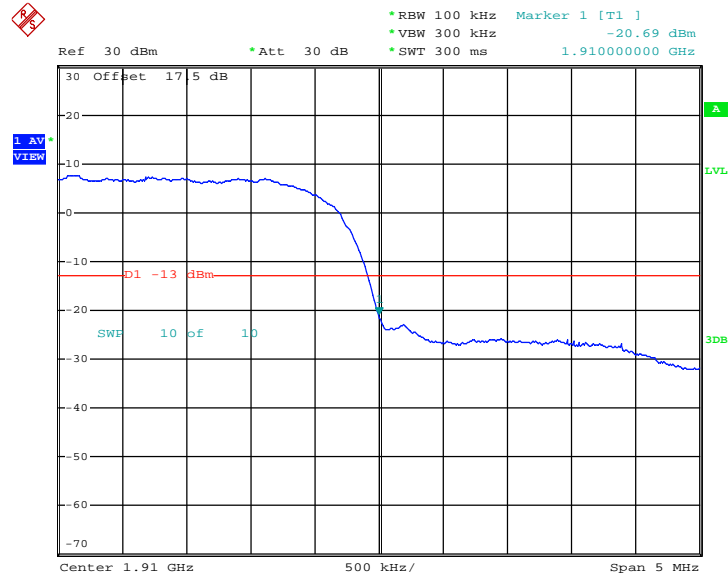

Date: 11.APR.2013 23:42:29

1. Correction Factor(dB)= 10log(1% Emission BW/RBW)
2. Band Edge= Measurement Value + Correction Factor(dB)

3.6 Conducted Spurious Emission Measurement

3.6.1 Description of Conducted Spurious Emission Measurement

The power of any emission outside of the authorized operating frequency ranges must be lower than the transmitter power (P) by a factor of at least $43 + 10 \log (P)$ dB.

It is measured by means of a calibrated spectrum analyzer and scanned from 30 MHz up to a frequency including its 10th harmonic.

3.6.2 Measuring Instruments

See list of measuring instruments of this test report.

3.6.3 Test Procedures

1. The EUT was connected to spectrum analyzer and base station via power divider.
2. The RF output of EUT was connected to the spectrum analyzer by RF cable and attenuator. The path loss was compensated to the results for each measurement.
3. The middle channel for the highest RF power within the transmitting frequency was measured.
4. The conducted spurious emission for the whole frequency range was taken.

3.6.4 Test Setup

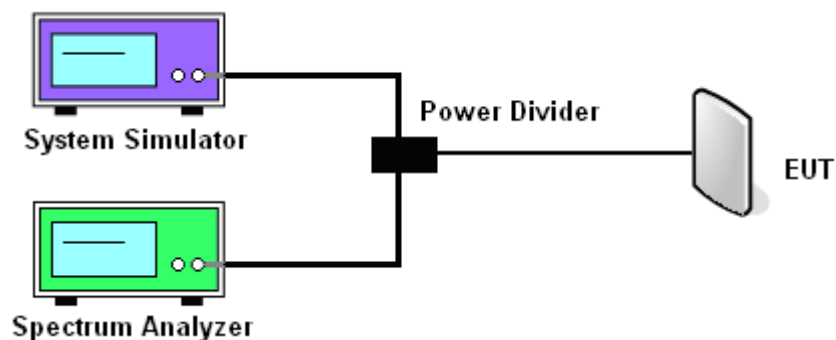

3.6.5 Test Result (Plots) of Conducted Spurious Emission

Band :	GSM850	Channel :	CH189
Test Mode :	GPRS class 8 Link (GMSK)	Frequency :	836.4 MHz

Conducted Spurious Emission Plot between 30MHz ~ 1GHz

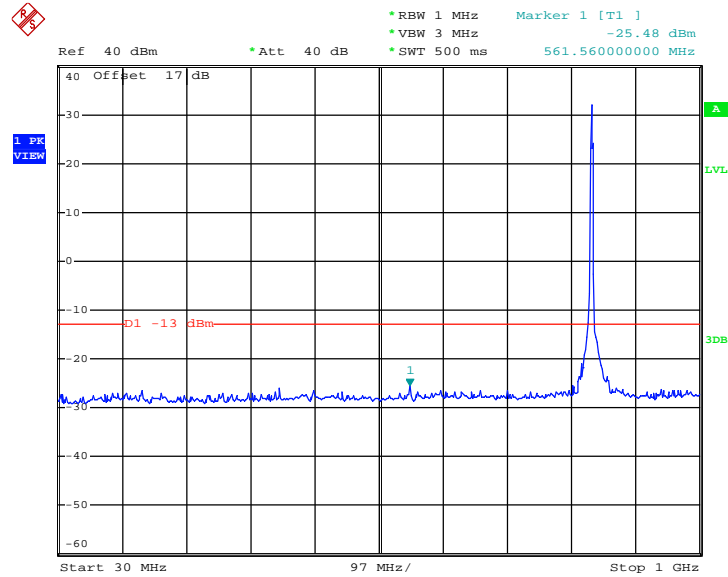

Date: 11.APR.2013 18:10:04

Conducted Spurious Emission Plot between 1GHz ~ 3GHz

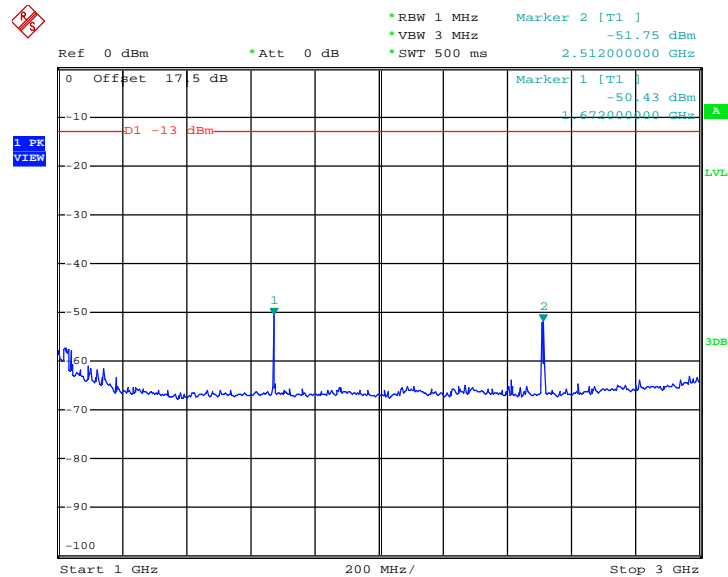

Date: 11.APR.2013 18:05:37



Conducted Spurious Emission Plot between 3GHz ~ 7GHz

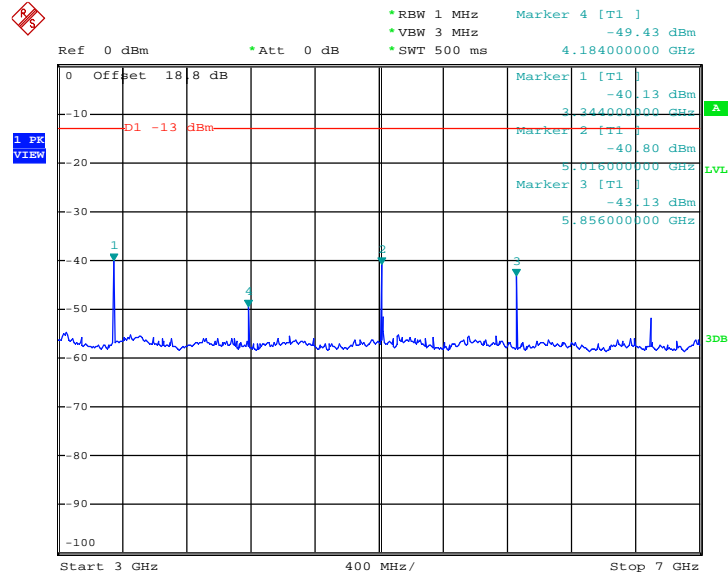

Date: 11.APR.2013 18:06:43

Conducted Spurious Emission Plot between 7GHz ~ 9GHz

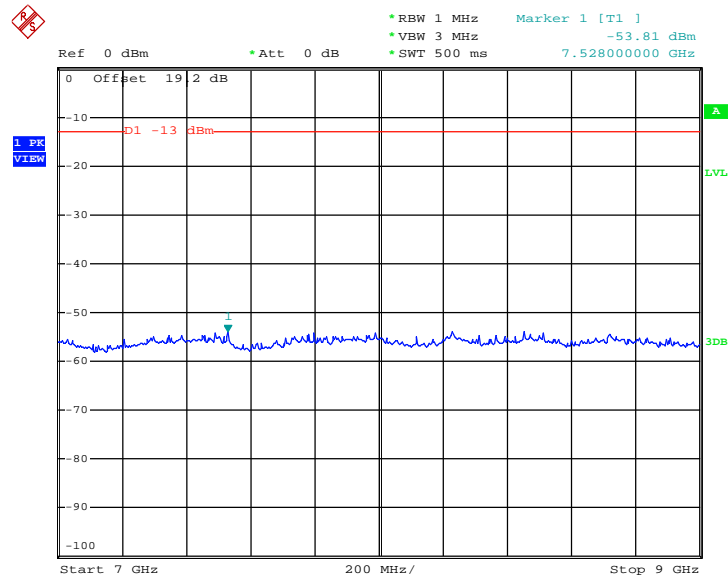

Date: 11.APR.2013 18:07:35



Band :	GSM1900	Channel :	CH661
Test Mode :	GPRS class 8 Link (GMSK)	Frequency :	1880.0 MHz

Conducted Spurious Emission Plot between 30MHz ~ 1GHz

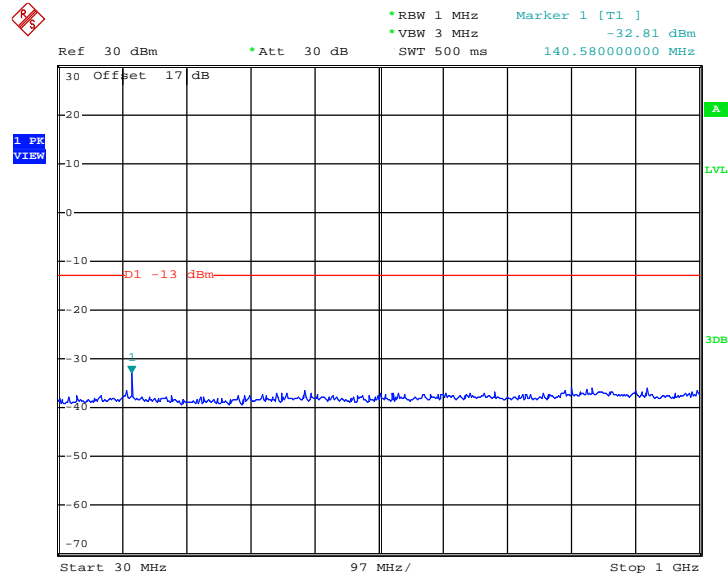

Date: 11.APR.2013 17:52:10

Conducted Spurious Emission Plot between 1GHz ~ 3GHz

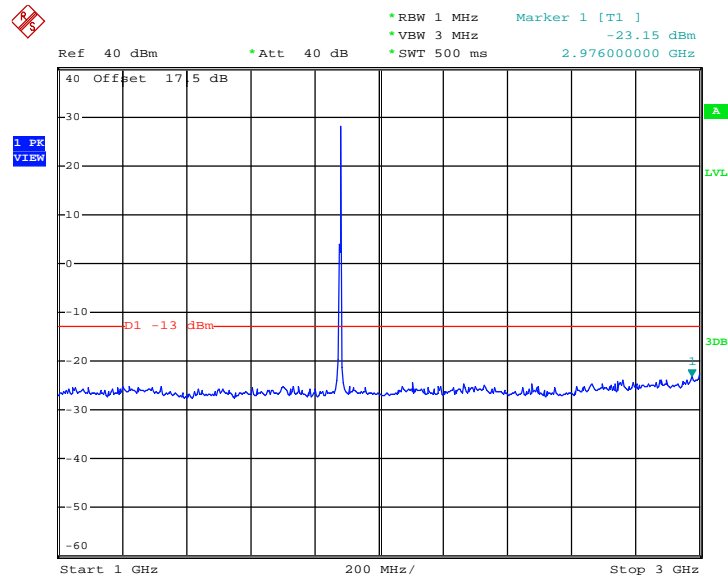

Date: 11.APR.2013 17:53:30



Conducted Spurious Emission Plot between 3GHz ~ 7GHz

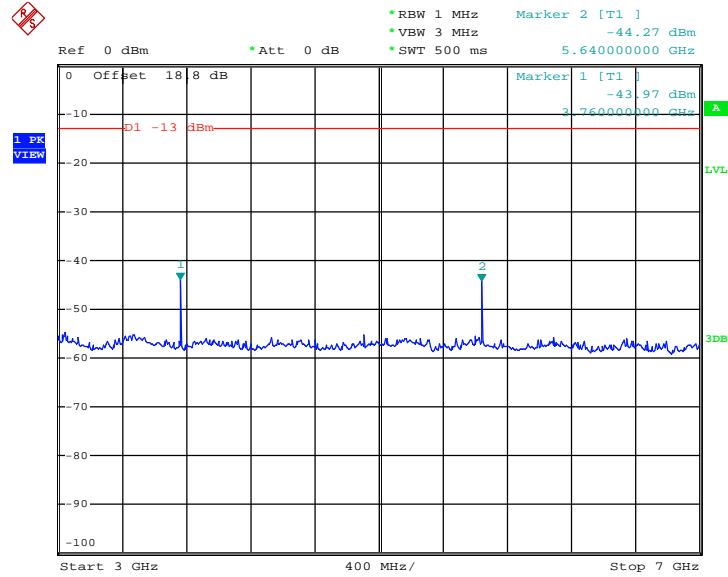

Date: 11.APR.2013 18:01:07

Conducted Emission Plot between 7GHz ~ 13.6GHz

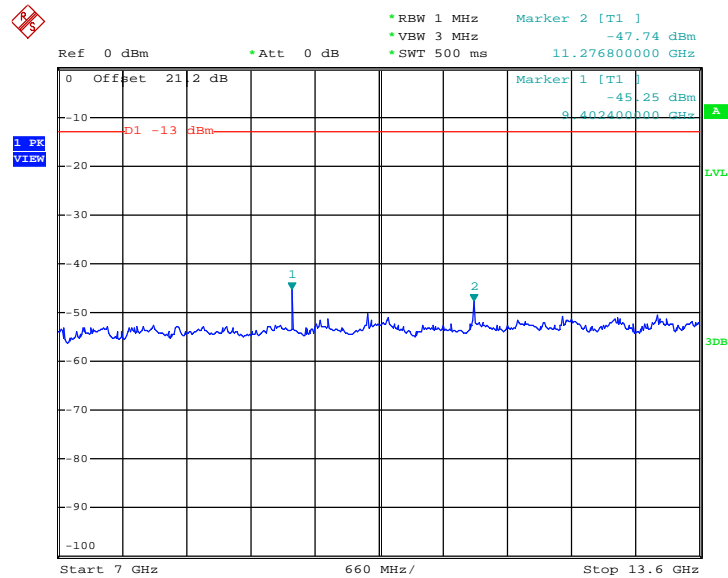

Date: 11.APR.2013 18:01:56



Conducted Spurious Emission Plot between 13.6GHz ~ 19.1GHz

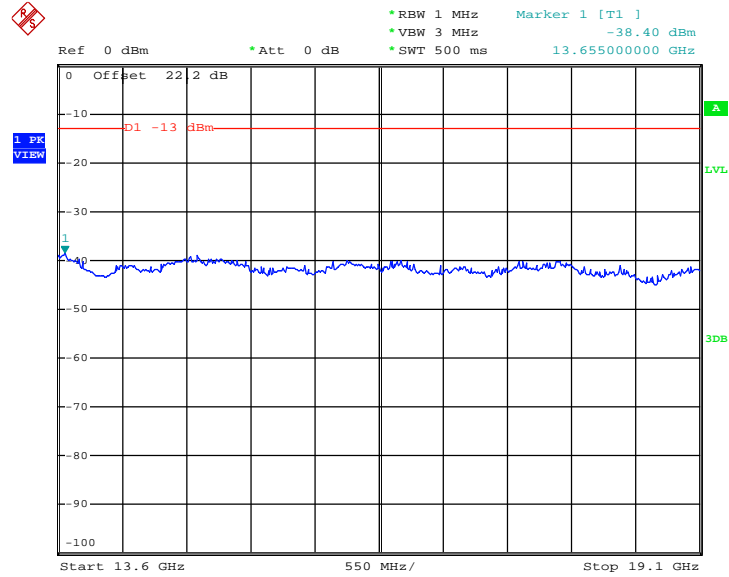

Date: 11.APR.2013 18:02:50



Band :	WCDMA Band V	Channel :	CH4182
Test Mode :	RMC 12.2Kbps Link (QPSK)	Frequency :	836.4 MHz

Conducted Spurious Emission Plot between 30MHz ~ 1GHz

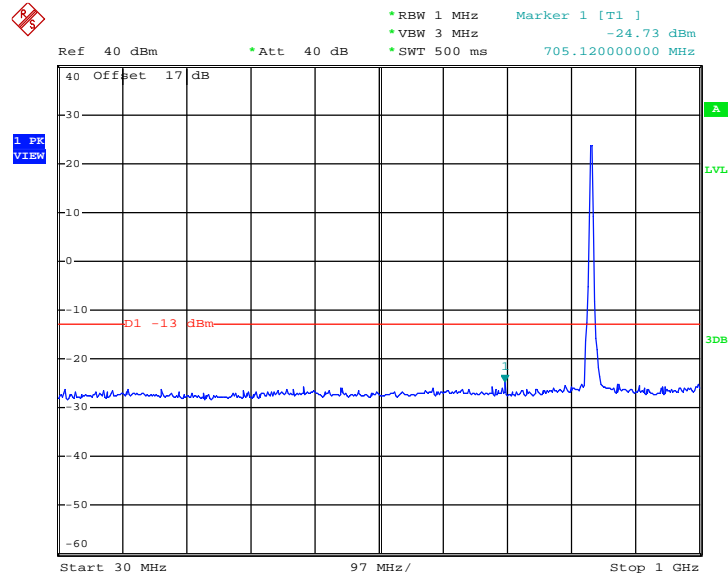

Date: 12.APR.2013 00:38:34

Conducted Spurious Emission Plot between 1GHz ~ 3GHz

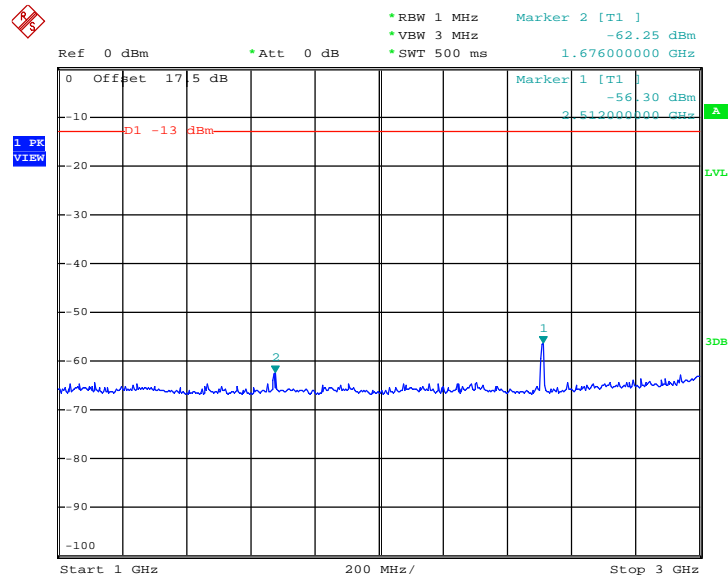

Date: 12.APR.2013 00:46:13



Conducted Spurious Emission Plot between 3GHz ~ 7GHz

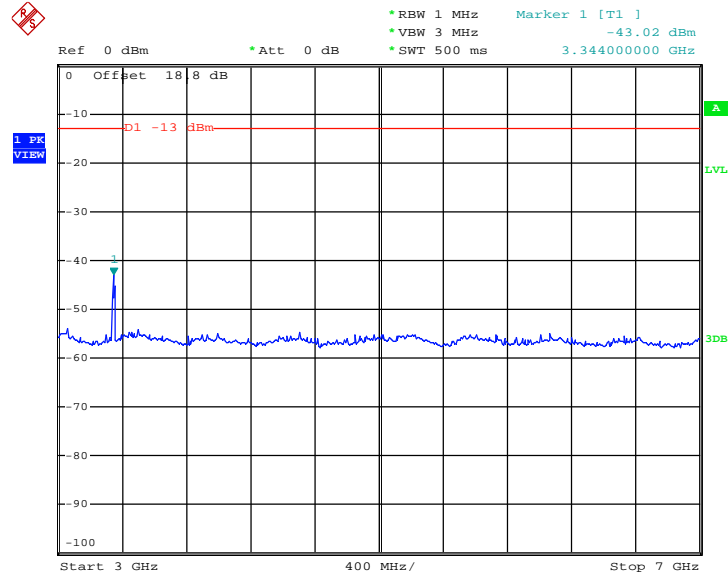

Date: 12.APR.2013 00:48:01

Conducted Spurious Emission Plot between 7GHz ~ 9GHz

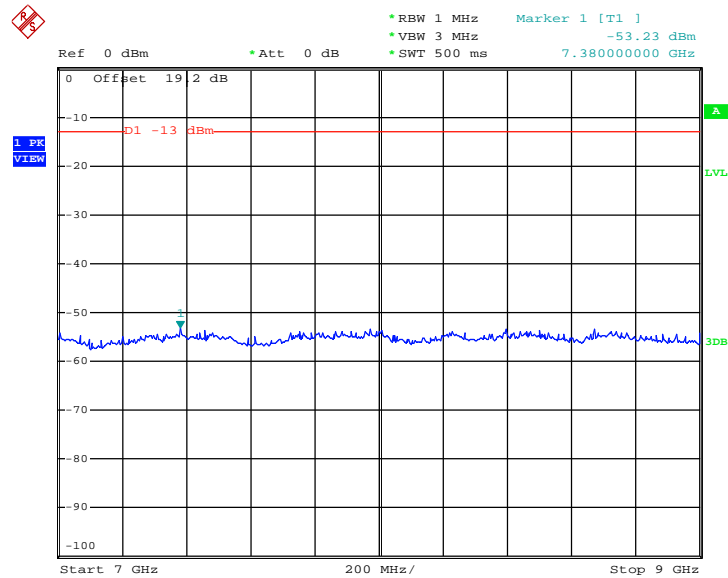

Date: 12.APR.2013 00:50:19



Band :	WCDMA Band II	Channel :	CH9400
Test Mode :	RMC 12.2Kbps Link (QPSK)	Frequency :	1880.0 MHz

Conducted Spurious Emission Plot between 30MHz ~ 1GHz

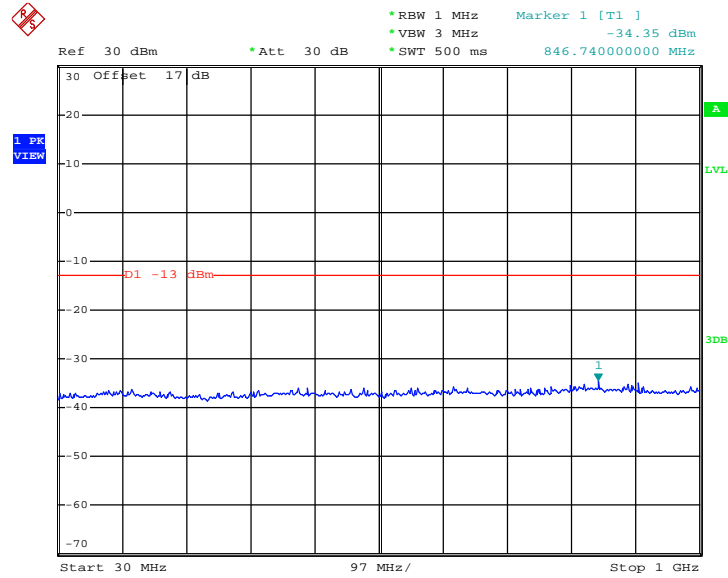

Date: 12.APR.2013 00:59:27

Conducted Spurious Emission Plot between 1GHz ~ 3GHz

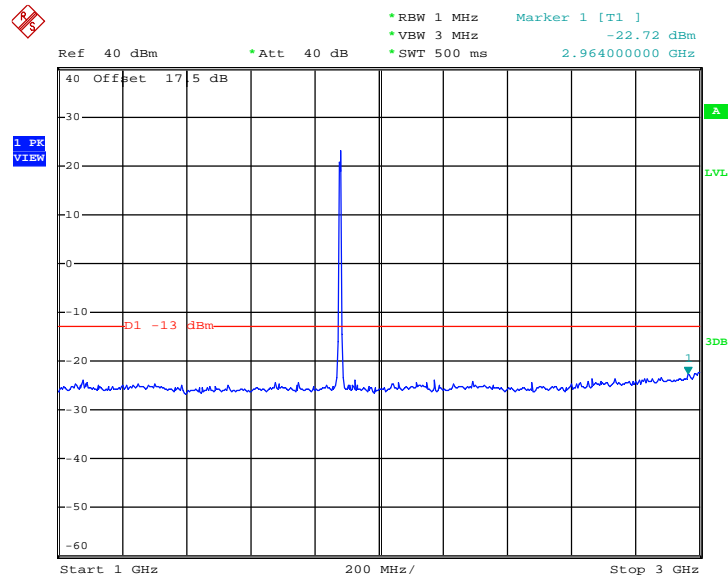

Date: 12.APR.2013 01:05:22



Conducted Spurious Emission Plot between 13.6GHz ~ 19.1GHz

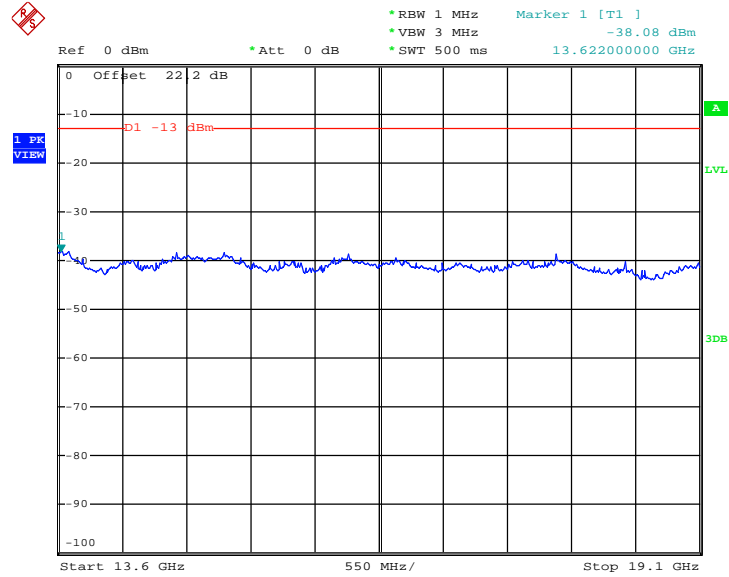

Date: 12.APR.2013 01:13:05

3.7 Field Strength of Spurious Radiation Measurement

3.7.1 Description of Field Strength of Spurious Radiated Measurement

The power of any emission outside of the authorized operating frequency ranges must be attenuated below the transmitter power (P) by a factor of at least $43 + 10 \log(P)$ dB. The spectrum is scanned from 30 MHz up to a frequency including its 10th harmonic.

3.7.2 Measuring Instruments

See list of measuring instruments of this test report.

3.7.3 Test Procedures

1. The EUT was placed on a rotatable wooden table with 0.8 meter above ground.
2. The EUT was set 3 meters from the receiving antenna, which was mounted on the antenna tower.
3. The table was rotated 360 degrees to determine the position of the highest spurious emission.
4. The height of the receiving antenna is varied between one meter and four meters to search the maximum spurious emission for both horizontal and vertical polarizations.
5. Make the measurement with the spectrum analyzer's RBW = 1MHz, VBW = 3MHz, taking the record of maximum spurious emission.
6. A horn antenna was substituted in place of the EUT and was driven by a signal generator.
7. Tune the output power of signal generator to the same emission level with EUT maximum spurious emission.
8. Taking the record of output power at antenna port.
9. Repeat step 7 to step 8 for another polarization.
10. The RF fundamental frequency should be excluded against the limit line in the operating frequency band.
11. The limit line is derived from $43 + 10\log(P)$ dB below the transmitter power P(Watts)
 $= P(W) - [43 + 10\log(P)]$ (dB)
 $= [30 + 10\log(P)]$ (dBm) - $[43 + 10\log(P)]$ (dB)
 $= -13\text{dBm}$.
12. EIRP (dBm) = S.G. Power – Tx Cable Loss + Tx Antenna Gain
13. ERP (dBm) = EIRP - 2.15

3.7.4 Test Setup

For radiated emissions from 30MHz to 1GHz

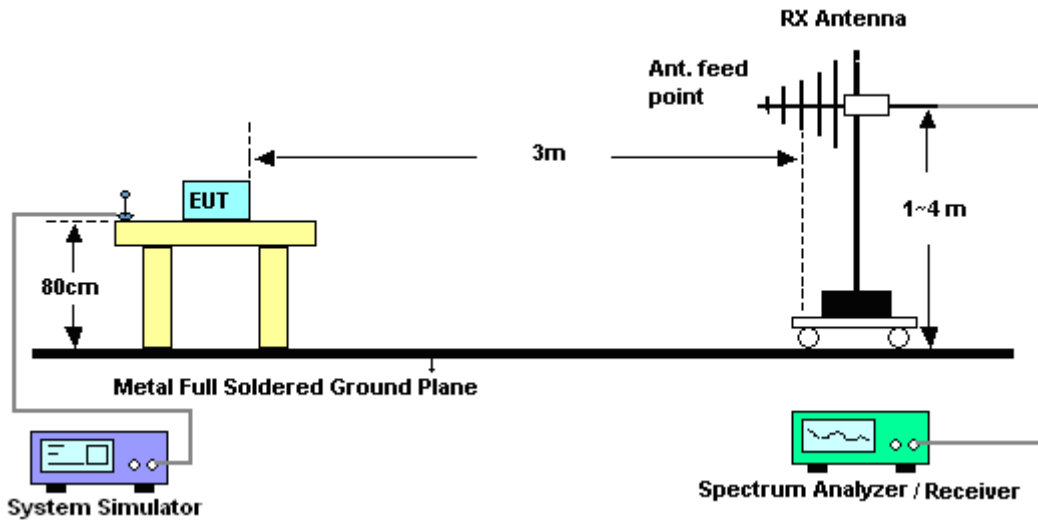

For radiated emissions above 1GHz

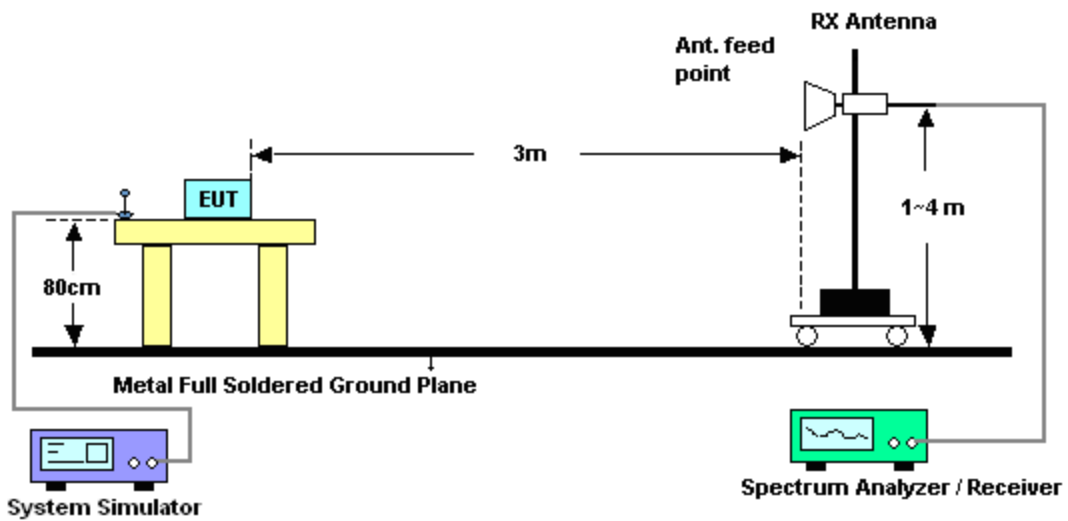



3.7.5 Test Result of Field Strength of Spurious Radiated

Band :	GSM850	Temperature :	24~26°C
Test Mode :	GPRS class 8 Link (GMSK)	Relative Humidity :	50~53%
Test Engineer :	Blithe Li	Polarization :	Horizontal
Remark :	Spurious emissions within 30-1000MHz were found more than 20dB below limit line.		

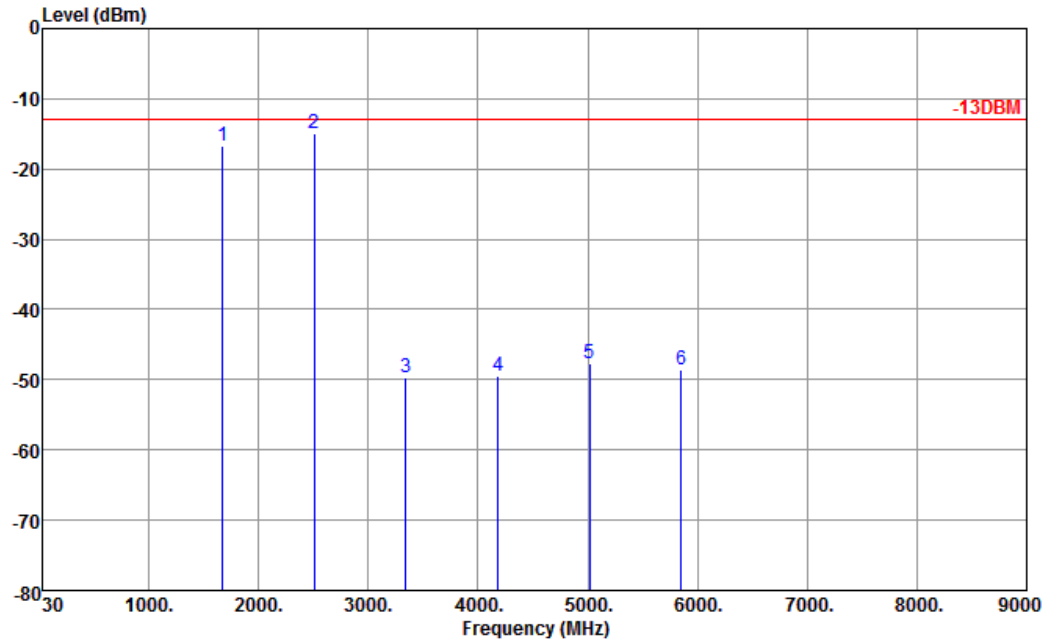

Site : 03CH01-SZ
 Condition : -13DBM HF_EIRP_H_130101 HORIZONTAL
 Project : (FG)332805

Frequency (MHz)	ERP (dBm)	Limit (dBm)	Over Limit (dB)	SPA Reading (dBm)	S.G. Power (dBm)	TX Cable loss (dB)	TX Antenna Gain (dBi)	Polarization (H/V)	Result
1672	-16.81	-13	-3.81	-33.54	-19.78	0.88	6.00	H	Pass
2509	-15.04	-13	-2.04	-40.87	-17.65	1.08	5.84	H	Pass
3345	-49.65	-13	-36.65	-60.25	-54.02	1.14	7.66	H	Pass
4182	-49.45	-13	-36.45	-64.21	-54.72	1.37	8.79	H	Pass
5018	-47.68	-13	-34.68	-65.97	-53.82	1.51	9.80	H	Pass
5854	-48.54	-13	-35.54	-66.76	-55.07	1.62	10.30	H	Pass



Band :	GSM850	Temperature :	24~26°C
Test Mode :	GPRS class 8 Link (GMSK)	Relative Humidity :	50~53%
Test Engineer :	Blithe Li	Polarization :	Vertical
Remark :	Spurious emissions within 30-1000MHz were found more than 20dB below limit line.		

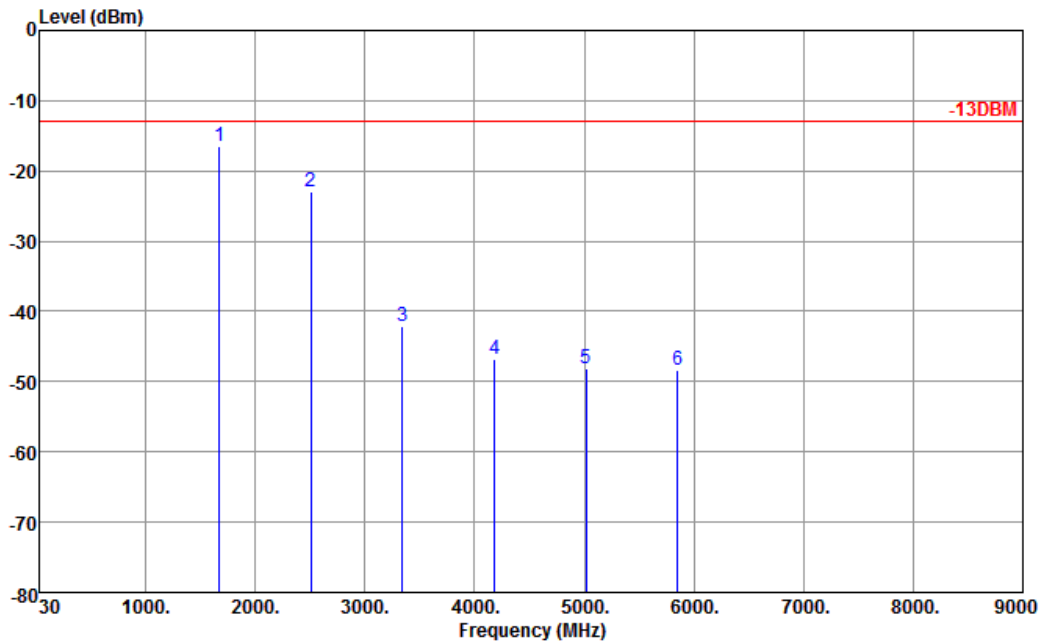

Site : 03CH01-SZ
 Condition : -13DBM HF_EIRP_V_130101 VERTICAL
 Project : (FG)332805

Frequency (MHz)	ERP (dBm)	Limit (dBm)	Over Limit (dB)	SPA Reading (dBm)	S.G. Power (dBm)	TX Cable loss (dB)	TX Antenna Gain (dBi)	Polarization (H/V)	Result
1672	-16.40	-13	-3.40	-30.71	-19.37	0.88	6.00	V	Pass
2509	-22.97	-13	-9.97	-46.19	-25.58	1.08	5.84	V	Pass
3345	-42.09	-13	-29.09	-55.88	-46.46	1.14	7.66	V	Pass
4182	-46.75	-13	-33.75	-61.97	-52.02	1.37	8.79	V	Pass
5018	-48.24	-13	-35.24	-65.69	-54.38	1.51	9.80	V	Pass
5854	-48.27	-13	-35.27	-66.17	-54.80	1.62	10.30	V	Pass



Band :	GSM1900	Temperature :	24~26°C
Test Mode :	GPRS class 8 Link (GMSK)	Relative Humidity :	50~53%
Test Engineer :	Blithe Li	Polarization :	Horizontal
Remark :	Spurious emissions within 30-1000MHz were found more than 20dB below limit line.		

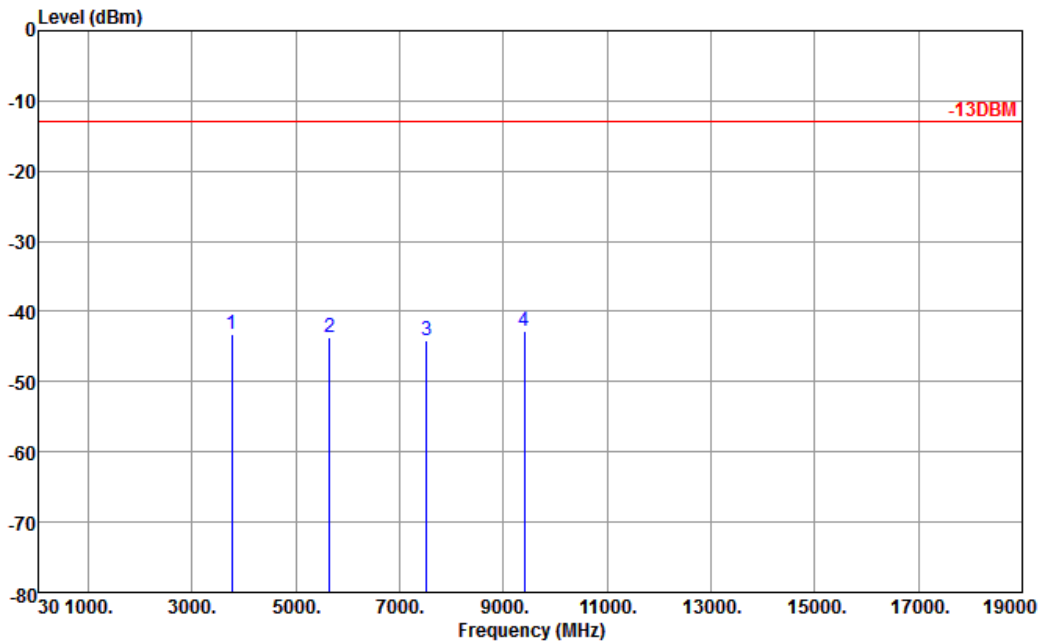

Site : 03CH01-SZ
 Condition : -13DBM HF_EIRP_H_130101 HORIZONTAL
 Project : (FG)332805

Frequency (MHz)	EIRP (dBm)	Limit (dBm)	Over Limit (dB)	SPA Reading (dBm)	S.G. Power (dBm)	TX Cable loss (dB)	TX Antenna Gain (dBi)	Polarization (H/V)	Result
3760	-43.21	-13	-30.21	-58.89	-47.80	1.28	8.02	H	Pass
5636	-43.75	-13	-30.75	-62.69	-50.02	1.58	10.00	H	Pass
7520	-44.08	-13	-31.08	-66.02	-52.25	1.78	12.10	H	Pass
9396	-42.71	-13	-29.71	-65	-51.34	2.22	13.00	H	Pass



Band :	GSM1900	Temperature :	24~26°C
Test Mode :	GPRS class 8 Link (GMSK)	Relative Humidity :	50~53%
Test Engineer :	Blithe Li	Polarization :	Vertical
Remark :	Spurious emissions within 30-1000MHz were found more than 20dB below limit line.		

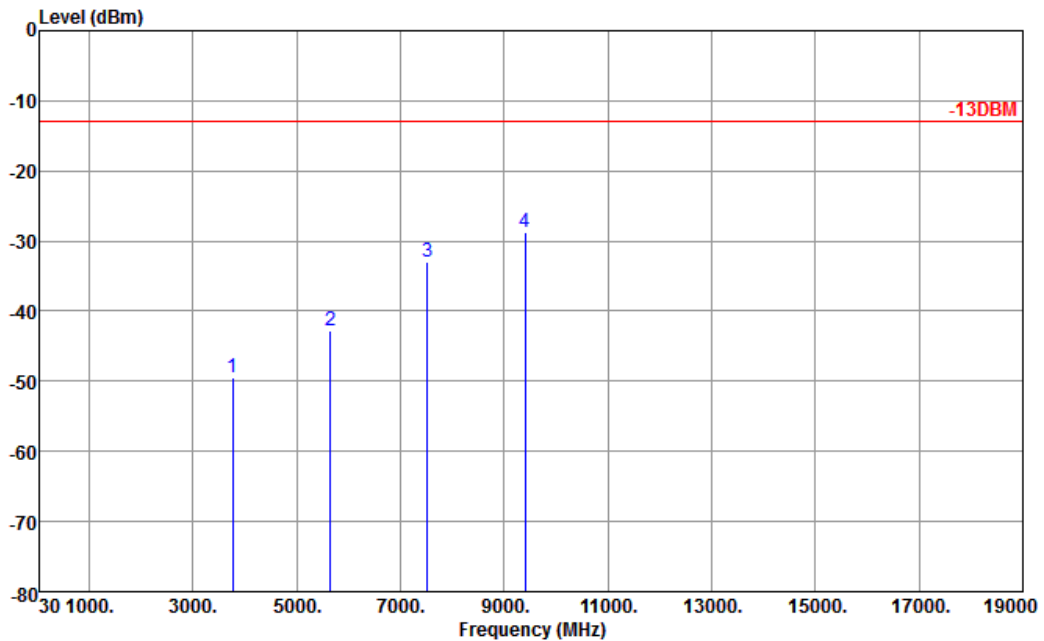

Site : 03CH01-SZ
 Condition : -13DBM HF_EIRP_V_130101 VERTICAL
 Project : (FG)332805

Frequency (MHz)	EIRP (dBm)	Limit (dBm)	Over Limit (dB)	SPA Reading (dBm)	S.G. Power (dBm)	TX Cable loss (dB)	TX Antenna Gain (dBi)	Polarization (H/V)	Result
3760	-49.41	-13	-36.41	-64.44	-54.00	1.28	8.02	V	Pass
5636	-42.70	-13	-29.70	-61.19	-48.97	1.58	10.00	V	Pass
7520	-33.08	-13	-20.08	-57.61	-41.25	1.78	12.10	V	Pass
9396	-28.72	-13	-15.72	-55.87	-37.35	2.22	13.00	V	Pass



Band :	WCDMA Band V	Temperature :	24~26°C
Test Mode :	RMC 12.2Kbps Link (QPSK)	Relative Humidity :	50~53%
Test Engineer :	Blithe Li	Polarization :	Horizontal
Remark :	Spurious emissions within 30-1000MHz were found more than 20dB below limit line.		

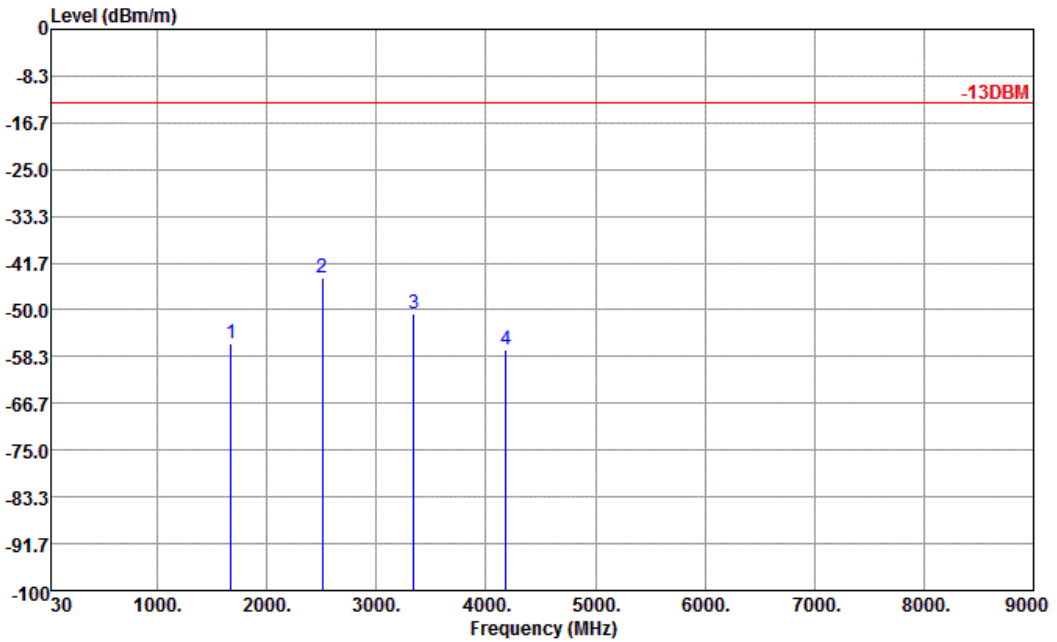

Site : 03CH01-SZ
 Condition : -13DBM HF_EIRP_H_130101 HORIZONTAL
 Project : (FG)332805

Frequency (MHz)	ERP (dBm)	Limit (dBm)	Over Limit (dB)	SPA Reading (dBm)	S.G. Power (dBm)	TX Cable loss (dB)	TX Antenna Gain (dBi)	Polarization (H/V)	Result
1672	-56.01	-13	-43.01	-68.93	-58.98	0.88	6.00	H	Pass
2510	-44.16	-13	-31.16	-67.52	-46.77	1.08	5.84	H	Pass
3345	-50.81	-13	-37.81	-61.41	-55.18	1.14	7.66	H	Pass
4182	-57.19	-13	-44.19	-71.95	-62.46	1.37	8.79	H	Pass



Band :	WCDMA Band V	Temperature :	24~26°C
Test Mode :	RMC 12.2Kbps Link (QPSK)	Relative Humidity :	50~53%
Test Engineer :	Blithe Li	Polarization :	Vertical
Remark :	Spurious emissions within 30-1000MHz were found more than 20dB below limit line.		

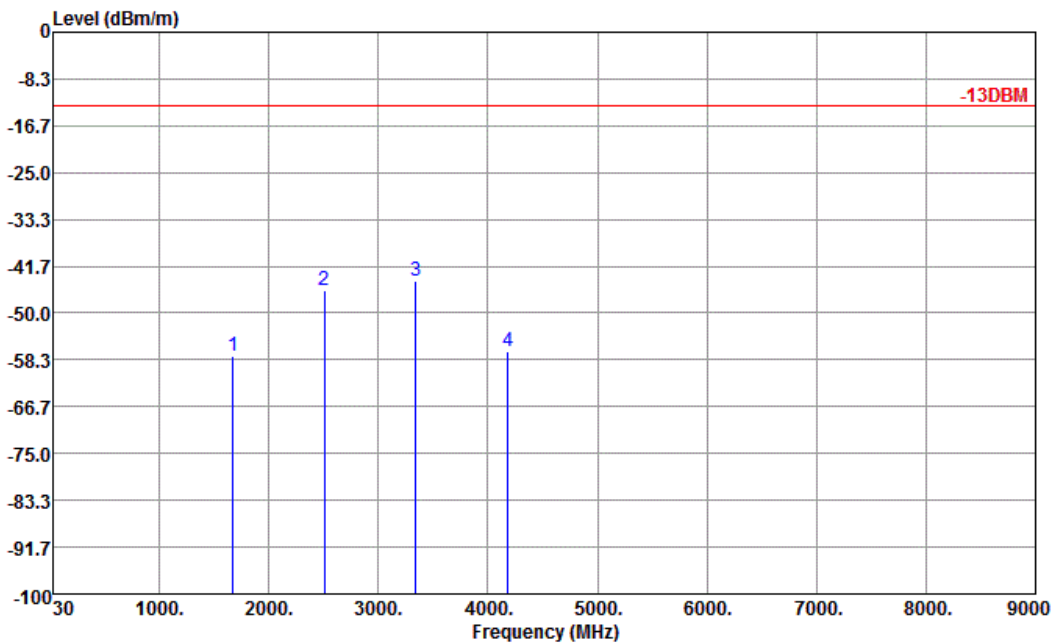

Site : 03CH01-SZ
 Condition : -13DBM HF_EIRP_V_130101 VERTICAL
 Project : (FG)332805

Frequency (MHz)	ERP (dBm)	Limit (dBm)	Over Limit (dB)	SPA Reading (dBm)	S.G. Power (dBm)	TX Cable loss (dB)	TX Antenna Gain (dBi)	Polarization (H/V)	Result
1672	-57.70	-13	-44.70	-68.33	-60.67	0.88	6.00	V	Pass
2510	-45.83	-13	-32.83	-66.87	-48.44	1.08	5.84	V	Pass
3345	-44.21	-13	-31.21	-57.36	-48.58	1.14	7.66	V	Pass
4182	-56.87	-13	-43.87	-72.09	-62.14	1.37	8.79	V	Pass



Band :	WCDMA Band II	Temperature :	24~26°C
Test Mode :	RMC 12.2Kbps Link (QPSK)	Relative Humidity :	50~53%
Test Engineer :	Blithe Li	Polarization :	Horizontal
Remark :	Spurious emissions within 30-1000MHz were found more than 20dB below limit line.		

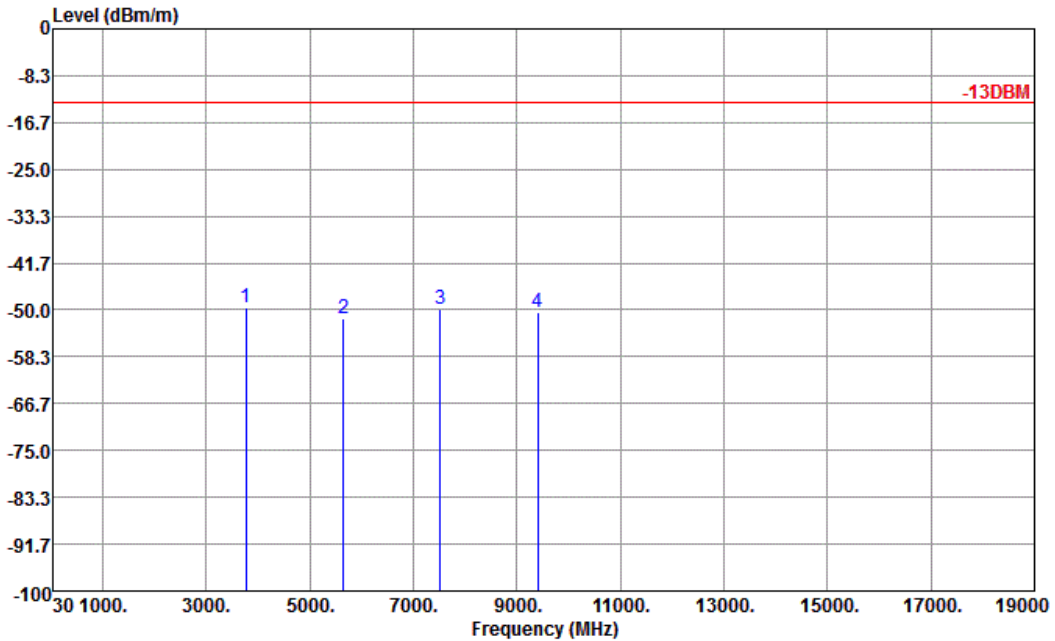

Site : 03CH01-SZ
 Condition : -13DBM HF_EIRP_H_130101 HORIZONTAL
 Project : (FG)332805

Frequency (MHz)	EIRP (dBm)	Limit (dBm)	Over Limit (dB)	SPA Reading (dBm)	S.G. Power (dBm)	TX Cable loss (dB)	TX Antenna Gain (dBi)	Polarization (H/V)	Result
3760	-49.67	-13	-36.67	-63.10	-56.41	1.28	8.02	H	Pass
5640	-51.42	-13	-38.42	-69.41	-59.84	1.58	10.00	H	Pass
7520	-49.91	-13	-36.91	-71.85	-60.23	1.78	12.10	H	Pass
9400	-50.34	-13	-37.34	-72.46	-61.12	2.22	13.00	H	Pass



Band :	WCDMA Band II	Temperature :	24~26°C
Test Mode :	RMC 12.2Kbps Link (QPSK)	Relative Humidity :	50~53%
Test Engineer :	Blithe Li	Polarization :	Vertical
Remark :	Spurious emissions within 30-1000MHz were found more than 20dB below limit line.		

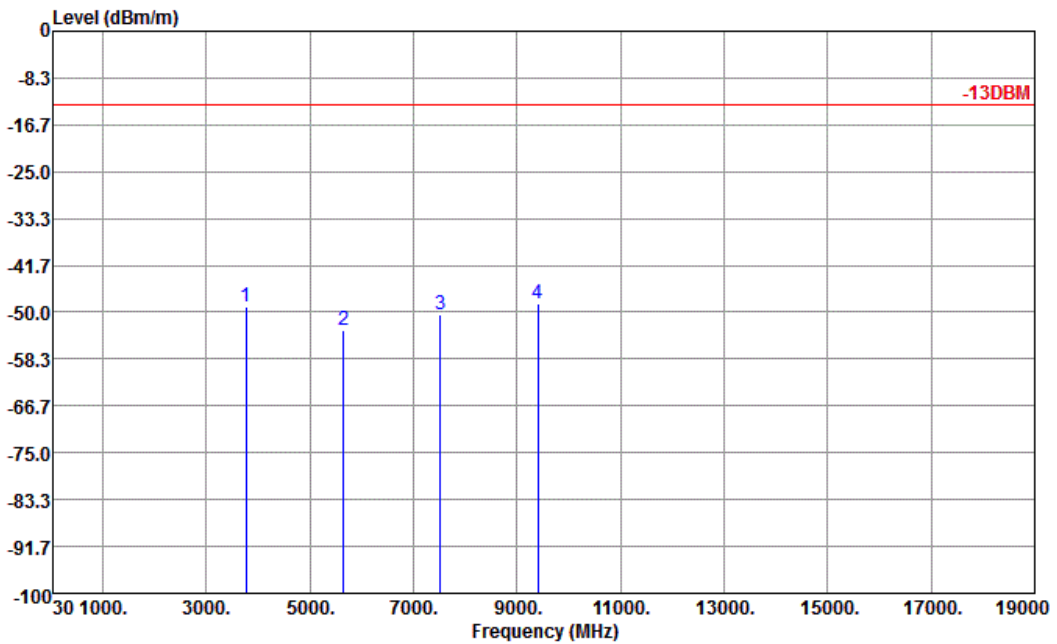

Site : 03CH01-SZ
 Condition : -13DBM HF_EIRP_V_130101 VERTICAL
 Project : (FG)332805

Frequency (MHz)	EIRP (dBm)	Limit (dBm)	Over Limit (dB)	SPA Reading (dBm)	S.G. Power (dBm)	TX Cable loss (dB)	TX Antenna Gain (dBi)	Polarization (H/V)	Result
3760	-49.13	-13	-36.13	-64.16	-55.87	1.28	8.02	V	Pass
5640	-53.28	-13	-40.28	-70.36	-61.70	1.58	10	V	Pass
7520	-50.34	-13	-37.34	-72.59	-60.66	1.78	12.1	V	Pass
9400	-48.60	-13	-35.60	-72.22	-59.38	2.22	13	V	Pass

3.8 Frequency Stability Measurement

3.8.1 Description of Frequency Stability Measurement

The frequency stability shall be measured by variation of ambient temperature and variation of primary supply voltage to ensure that the fundamental emission stays within the authorized frequency block. The frequency stability of the transmitter shall be maintained within $\pm 0.00025\%$ ($\pm 2.5\text{ppm}$) of the center frequency.

3.8.2 Measuring Instruments

See list of measuring instruments of this test report.

3.8.3 Test Procedures for Temperature Variation

1. The EUT was set up in the thermal chamber and connected with the base station.
2. With power OFF, the temperature was decreased to -30°C and the EUT was stabilized before testing. Power was applied and the maximum change in frequency was recorded within one minute.
3. With power OFF, the temperature was raised in 10°C step up to 50°C . The EUT was stabilized at each step for at least half an hour. Power was applied and the maximum frequency change was recorded within one minute.
4. If the EUT cannot be turned on at -30°C , the testing lowest temperature will be raised in 10°C step until the EUT can be turned on.

3.8.4 Test Procedures for Voltage Variation

1. The EUT was placed in a temperature chamber at $25\pm 5^{\circ}\text{C}$ and connected with the base station.
2. The power supply voltage to the EUT was varied from BEP to 115% of the nominal value measured at the input to the EUT.
3. The variation in frequency was measured for the worst case.

3.8.5 Test Setup

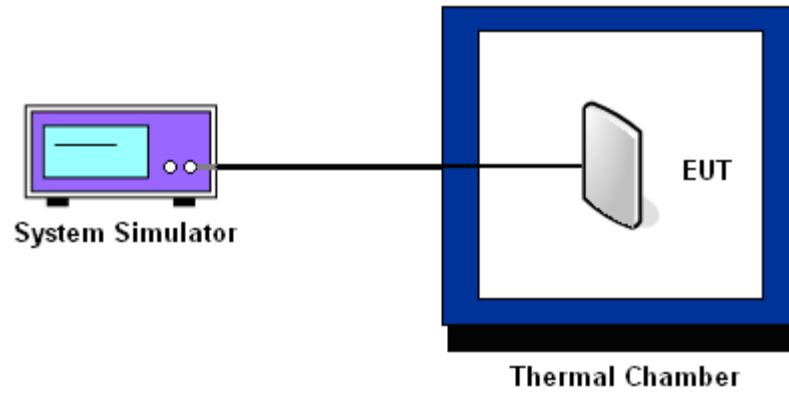

3.8.6 Test Result of Temperature Variation

Band :	GSM 850	Channel :	189
Limit (ppm) :	2.5	Frequency :	836.4 MHz

Temperature (°C)	GPRS class 8		Result
	Freq. Dev. (Hz)	Deviation (ppm)	
-30	11	+0.01	PASS
-20	10	+0.01	
-10	8	+0.01	
0	9	+0.01	
10	10	+0.01	
20	9	+0.01	
30	8	+0.01	
40	9	+0.01	
50	11	+0.01	
60	10	+0.01	
70	12	+0.01	

Note: The manufacturer declared that the EUT could work properly at temperature 60°C and 70°C.



Band :	GSM 1900	Channel :	661
Limit (ppm) :	2.5	Frequency :	1880.0 MHz

Temperature (°C)	GPRS class 8		Result
	Freq. Dev. (Hz)	Deviation (ppm)	
-30	-18	-0.01	PASS
-20	-22	-0.01	
-10	20	+0.01	
0	16	+0.01	
10	24	+0.01	
20	22	+0.01	
30	21	+0.01	
40	19	+0.01	
50	26	+0.01	
60	27	+0.01	
70	29	+0.02	

Note: The manufacturer declared that the EUT could work properly at temperature 60°C and 70°C.



Band :	WCDMA Band V	Channel :	4182
Limit (ppm) :	2.5	Frequency :	836.4 MHz

Temperature (°C)	RMC 12.2Kbps		Result
	Freq. Dev. (Hz)	Deviation (ppm)	
-30	6	+0.01	PASS
-20	5	+0.01	
-10	4	+0.01	
0	5	+0.01	
10	3	+0.01	
20	3	+0.01	
30	4	+0.01	
40	6	+0.01	
50	5	+0.01	
60	3	+0.01	
70	4	+0.01	

Note: The manufacturer declared that the EUT could work properly at temperature 60°C and 70°C.



Band :	WCDMA Band II	Channel :	9400
Limit (ppm) :	2.5	Frequency :	1880.0 MHz

Temperature (°C)	RMC 12.2Kbps		Result
	Freq. Dev. (Hz)	Deviation (ppm)	
-30	11	+0.01	PASS
-20	10	+0.01	
-10	9	+0.01	
0	10	+0.01	
10	8	+0.01	
20	7	+0.01	
30	10	+0.01	
40	7	+0.01	
50	9	+0.01	
60	8	+0.01	
70	11	+0.01	

Note: The manufacturer declared that the EUT could work properly at temperature 60°C and 70°C.

3.8.7 Test Result of Voltage Variation

Band & Channel	Mode	Voltage (Volt)	Freq. Dev. (Hz)	Deviation (ppm)	Limit (ppm)	Result
GSM 850 CH189	GPRS class 8	12	-10	-0.01	2.5	PASS
		6	-7	-0.01		
		16	-11	-0.01		
GSM 1900 CH661	GPRS class 8	12	-18	-0.01		
		6	-20	-0.01		
		16	-16	-0.01		
WCDMA Band V CH4182	RMC 12.2Kbps	12	3	+0.00		
		6	3	+0.00		
		16	4	+0.00		
WCDMA Band II CH9400	RMC 12.2Kbps	12	-7	+0.00		
		6	-8	+0.00		
		16	8	+0.00		

Note: Normal Voltage = 12V.



4 List of Measuring Equipment

Instrument	Manufacturer	Model No.	Serial No.	Characteristics	Calibration Date	Test Date	Due Date	Remark
Spectrum Analyzer	R&S	FSP30	101400	9kHz~30GHz	Mar. 28, 2013	Apr. 11, 2013~ May 14, 2013	Mar. 27, 2014	Conducted (TH01-SZ)
Power Meter	Anritsu	ML2495A	1218010	N/A	Mar. 28, 2013	Apr. 11, 2013~ May 14, 2013	Mar. 27, 2014	Conducted (TH01-SZ)
Power Sensor	Anritsu	MA2411B	1207253	N/A	Mar. 28, 2013	Apr. 11, 2013~ May 14, 2013	Mar. 27, 2014	Conducted (TH01-SZ)
Thermal Chamber	Hongzhan	LP-150U	HD20120425	N/A	Mar. 28, 2013	Apr. 11, 2013~ May 14, 2013	Mar. 27, 2014	Conducted (TH01-SZ)
ESCI TEST Receiver	R&S	ESCI	100724	9kHz~3GHz	Mar. 28, 2013	Apr. 16, 2013	Mar. 27, 2014	Radiation (03CH01-SZ)
Spectrum Analyzer	R&S	FSP30	101362	9kHz~30GHz	Oct. 11, 2012	Apr. 16, 2013	Oct. 10, 2013	Radiation (03CH01-SZ)
Bilog Antenna	SCHAFFNER	CBL6112B	2614	30MHz~2GHz	Nov. 03, 2012	Apr. 16, 2013	Nov. 02, 2013	Radiation (03CH01-SZ)
Double Ridge Horn Antenna	ETS Lindgren	3117	00119436	1GHz~18GHz	Oct. 12, 2012	Apr. 16, 2013	Oct. 11, 2013	Radiation (03CH01-SZ)
Amplifier	ADVANTEST	BB525C	E9007003	9kHz~3000MHz GAIN 30dB	Mar. 28, 2013	Apr. 16, 2013	Mar. 27, 2014	Radiation (03CH01-SZ)
Amplifier	Yiai	AV3860B	04030	2GHz~26.5GHz	Mar. 28, 2013	Apr. 16, 2013	Mar. 27, 2014	Radiation (03CH01-SZ)
SHF-EHF -Horn	Schwarzbeck	BBHA9170	BBHA917024 9	14GHz~40GHz	Nov. 23, 2012	Apr. 16, 2013	Nov. 22, 2013	Radiation (03CH01-SZ)
Turn Table	EM Electronics	EM 1000	N/A	0 ~ 360 degree	N/A	Apr. 16, 2013	N/A	Radiation (03CH01-SZ)
Antenna Mast	EM Electronics	EM 1000	N/A	1 m~4 m	N/A	Apr. 16, 2013	N/A	Radiation (03CH01-SZ)

5 Uncertainty of Evaluation

Uncertainty of Radiated Emission Measurement (30 MHz ~ 1000 MHz)

Measuring Uncertainty for a Level of Confidence of 95% ($U = 2Uc(y)$)	2.54
---	------

Uncertainty of Radiated Emission Measurement (1 GHz ~ 40 GHz)

Measuring Uncertainty for a Level of Confidence of 95% ($U = 2Uc(y)$)	4.72
---	------



Appendix A. Photographs of EUT

Please refer to Sporton report number EP332805 as below.