

Date: ESPOO 04.10.2013

Page: 1 (30)

Appendices -

Number:
No. 1 / 1

245598B

Date of handing in: 30.09.2013

Tested by:



Timo Hietala, test specialist

Reviewed by:



Janne Nyman, Compliance Specialist

SORT OF EQUIPMENT:

2.4 GHz Transceiver

TRADE MARK:

SCANRECO

TYPE:

G5 CU R

MANUFACTURER:

Scanreco Industrietechnik AB

CLIENT:

Scanreco Industrietechnik AB

ADDRESS:

Årsta Skolgränd 22, S – 100 74 Stockholm, Sweden

TEST LABORATORY:

Nemko Oy

FCC REG. NO.

359859 October 20, 2011

IC FILE NO.

2040F-1 November 22, 2012

SUMMARY:

In regard to the performed tests the equipment under test fulfils the requirements defined in the test specifications, see page 2 for details.

The test results are valid for the tested unit only. Without a written permission of Nemko Oy it is allowed to copy this report as a whole, but not partially.

Summary of performed tests and test results

<i>Section in CFR 47</i>	<i>Section in RSS-GEN or RSS-210, Issue 8</i>		<i>Result</i>
15.247 (b)(1)	A8.4 (2)	Conducted peak output power	PASS
15.247 (d)	A8.5	Band-edge compliance of RF emissions	PASS
15.247 (d)	A8.5	Spurious RF conducted emissions	*)
15.247 (d) 15.209	A8.5	Spurious radiated emissions	PASS
15.207	7.2.2	AC power line conducted emissions	PASS
15.247 (a)(1)	A8.1 (a)	20 dB bandwidth	*)
15.247 (a)(1)	A8.1 (b)	Carrier frequency separation	*)
15.247 (a)(1)(iii)	A8.1 (d)	Number of hopping frequencies	*)
15.247 (a)/1)(iii)	A8.1 (d)	Time of occupancy	*)

*) Test results in test report no. 224568 FCC 15.247 TRF EMC rev2.

PASS The EUT passed that particular test.

FAIL The EUT failed that particular test.

N.A. The test not applicable, battery operated equipment

X The measurement was done, but there is no applicable performance criteria.

N.T. Not Tested

Contents

Summary of performed tests and test results.....	2
1. EUT and Accessory Information	4
1.1 EUT description	4
1.2 EUT and accessories.....	4
1.3 Additional information related to testing	4
2. Test setups.....	5
3. Standards and measurement methods.....	6
4. Test results.....	6
4.1 Conducted peak output power.....	6
4.1.1 EUT operation mode.....	6
4.1.2 Test method and limit.....	6
4.1.3 Test results	6
4.2 Band-edge compliance of RF emissions	9
4.2.1 EUT operation mode.....	9
4.2.1 Test method and limit.....	9
4.2.2 Test results	10
4.3 Spurious radiated emission.....	18
4.3.1 EUT operation mode.....	18
4.3.2 Test method and limit.....	18
4.3.3 Test results	20
4.3.4 Test results, Radiated emissions in restricted bands 30 MHz – 25 GHz.....	20
4.4 Duty cycle correction factor.....	24
4.5 AC power line conducted emissions	25
4.5.1 Test method and limit.....	25
4.5.2 EUT operation mode.....	25
4.5.3 Test results	26
5. List of test equipment	28
6. Photographs.....	29

1. EUT and Accessory Information

1.1 EUT description

2.4 GHz transceiver, Frequency hopping system, 16 channels

Type: G5 CU R

1.2 EUT and accessories

	<i>unit</i>	<i>type</i>	<i>s/n</i>
<i>EUT1</i>	Transceiver with antenna connector (SMA-RP) 80mm dipole (art.n. 49070)	G5 CU R	3
<i>EUT2</i>	Transceiver with Pcb Inverted F Antenna	G5 CU R	5

Operating voltages

12 VDC

1.3 Additional information related to testing

Tested Technology:	Frequency Hopping System, 16 channels	
Antenna:	SMA-RP, 80mm length, gain=2.1dBi min (EUT1) or Integral, gain=3.3dBi max (EUT2)	
Type of Unit	Transmitter	
Modulation:	FHSS	
Power Supply Requirement:	Nominal	12V
Transmit Frequency Range	2400 MHz to 2483.5 MHz	
Transmit Channels Tested:	Channel Number	Channel Frequency (MHz)
	0	2405
	7	2440
	15	2480

2. Test setups

Setup 1 (Conducted measurements)

The test was performed inside a shielded room.

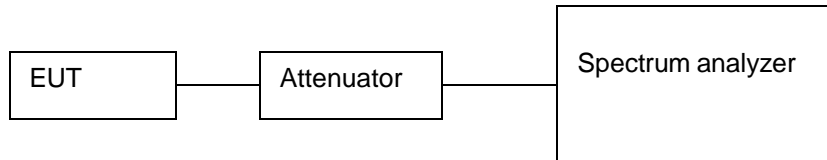

Setup 2 (Radiated measurements)

The test was performed inside a semi anechoic shielded room. For the duration of the test the EUT was placed on a non-conductive support 0.8 m high standing on the turntable. The tower and turn table were remotely controlled to turn the EUT and change the antenna polarization. The measured signal was routed from the measuring antenna to the spectrum analyzer.

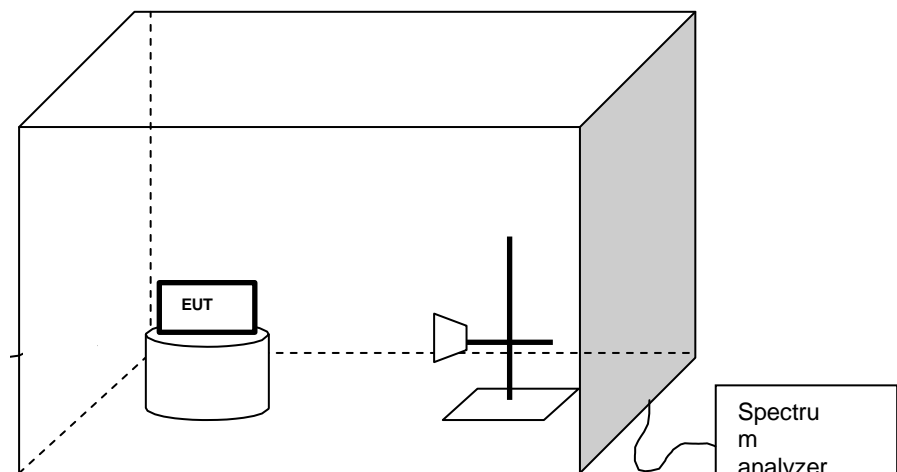

3. Standards and measurement methods

The test were performed in guidance of the CFR 47, FCC Rules Part 15 Subpart C, ANSI C63.4 (2003), CISPR 22 Ed. 6.0, Public notice DA 00-705, ANSI C63.10 (2009), IC standards RSS-GEN (Issue 3, December 2010) and RSS-210 (Issue 8, December 2010).

4. Test results

4.1 Conducted peak output power

The test was performed as a compliance test. The test parameters concerned were as follows:

<i>EUT</i>	EUT1, setup 1
<i>Site name</i>	Nemko Oy / Perkkaa
<i>FCC rule part</i>	§ 15.247 (b)(1)
<i>Section in RSS-210</i>	A8.4 (2)
<i>Date of testing</i>	01.10.2013
<i>Test equipment</i>	566, 390
<i>Test conditions</i>	22 °C, 35 % RH

4.1.1 EUT operation mode

<i>EUT channel</i>	0, 7 and 15
--------------------	-------------

4.1.2 Test method and limit

The measurement is made according to ANSI C63.10 Section 6.10.1 and IC standard RSS-210.

<i>Frequency range (MHz)</i>	<i>Limit (W)</i>	<i>Limit (dBm)</i>
2400 – 2483.5	≤ 1.0	≤ 30

4.1.3 Test results

<i>Channel / f (MHz)</i>	<i>P (dBm)</i>	<i>Result</i>
0 / 2405	18.27	PASS
7 / 2440	18.16	PASS
15 / 2480	17.67	PASS

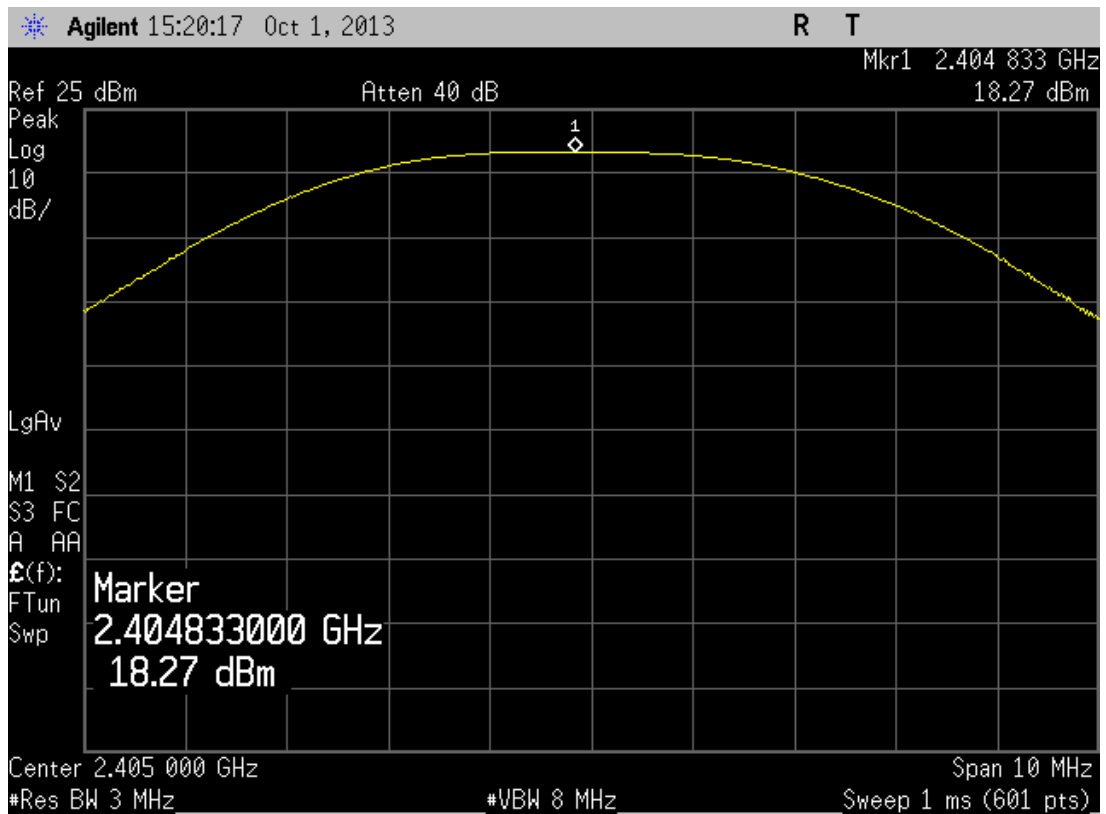

Figure 1, channel 0, conducted peak output power

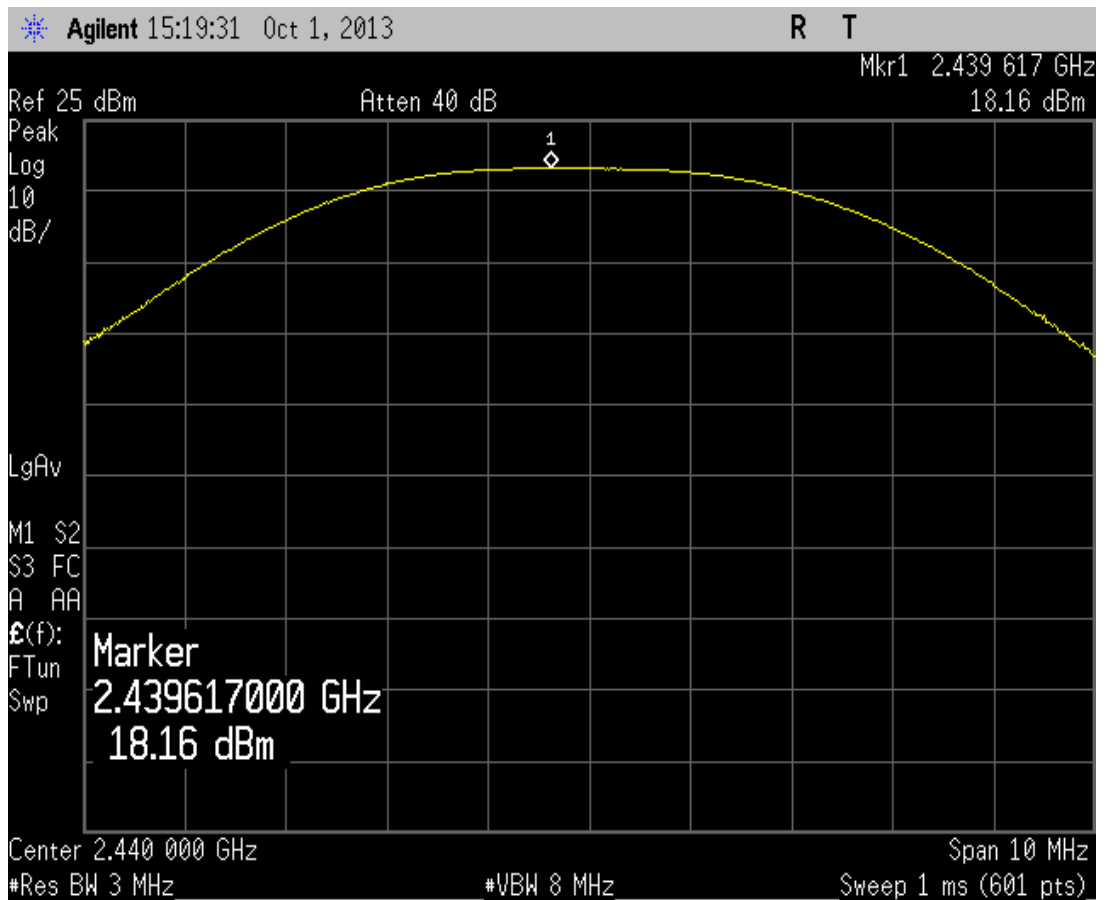

Figure 2, channel 7, conducted peak output power

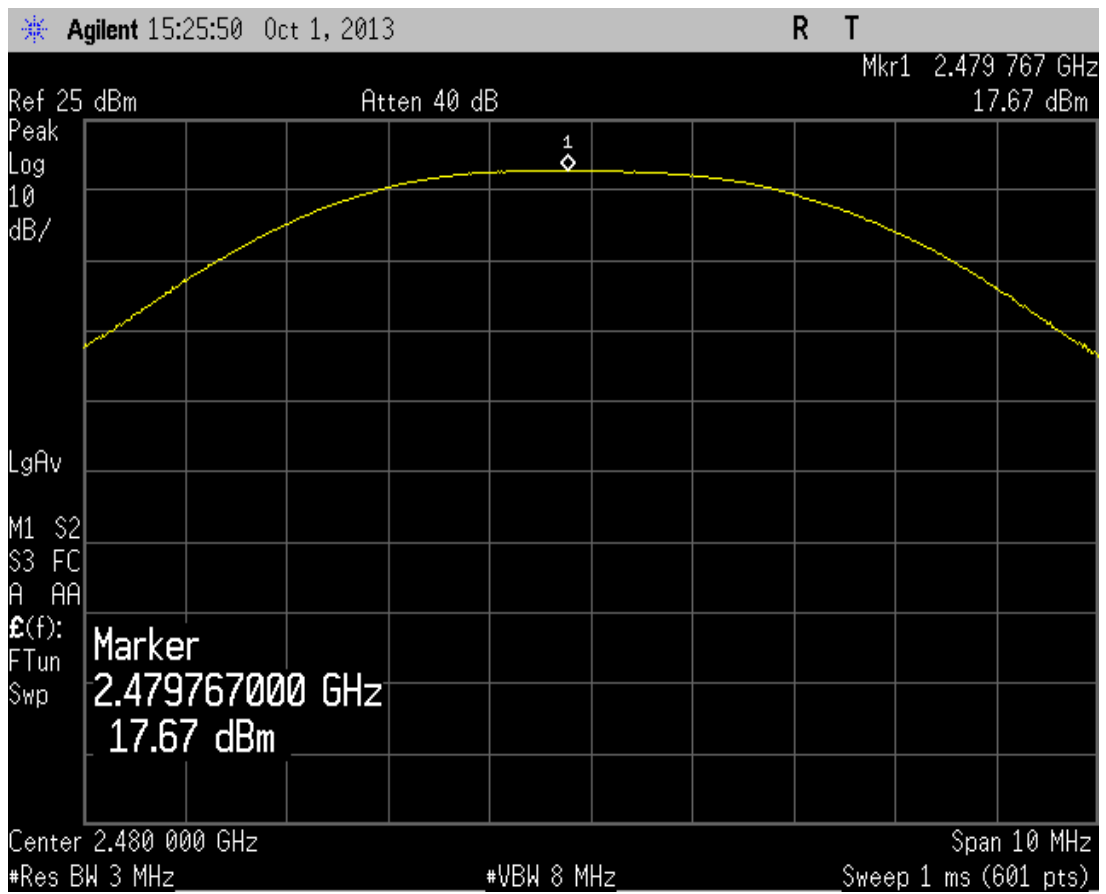

Figure 3., channel 15, conducted peak output power

4.2 Band-edge compliance of RF emissions

The test was performed as a compliance test. The test parameters concerned were as follows:

<i>EUT</i>	EUT1 and EUT2, setup 2
<i>Site name</i>	Nemko Oy / Perkaa
<i>FCC rule part</i>	§ 15.247 (d)
<i>Section in RSS-210</i>	A8.5
<i>Date of testing</i>	30.09-01.10.2013
<i>Test equipment</i>	566, 525, 350, 564
<i>Test conditions</i>	22 °C, 35 % RH
<i>Test result</i>	PASS

4.2.1 EUT operation mode

<i>EUT channel</i>	Hopping ON Hopping OFF channels low and high
--------------------	---

4.2.1 Test method and limit

The measurement is made according to ANSI C63.10 Section 6.9.2 and FCC KDB 913591.

<i>Frequency range (MHz)</i>	<i>Limit (dBc)</i>
Below 2400	≤ -20

Limit (3m measuring distance)

<i>Frequency range (MHz)</i>	<i>Average dB(μV/m)</i>	<i>Peak dB(μV/m)</i>
Below 2390	54	74

Limit (3m measuring distance)

<i>Frequency range (MHz)</i>	<i>Average dB(μV/m)</i>	<i>Peak dB(μV/m)</i>
Above 2483.5	54	74

Delta measurement technique was used at upper band edge (FCC KDB 913591).

STEP 1 In-band field strength measurement of the fundamental emission using the RBW 1MHz
 STEP 2 Using the RBW 100kHz record peak levels of the fundamental emission and the relevant band edge emission (i.e., run several sweeps in peak hold mode). Measure the amplitude delta between the peak of the fundamental and the peak of the band edge emission

STEP 3 - Subtract the delta measured in step (2) from the field strengths measured in step (1)

For peak to average Duty Cycle correction factor (dB) -21.27 dB was used.

4.2.2 Test results

EUT1

Hopping ON:

Below 2400 MHz:

<i>Detector (RBW: 100kHz)</i>	<i>P (dBc)</i>	<i>Result</i>
Peak	-52.77	PASS

Below 2390 MHz:

<i>Detector (RBW: 1MHz)</i>	<i>E (dBμV/m)</i>	<i>Result</i>
Peak	61.12	PASS
Average	39.85	PASS

Above 2483.5 MHz:

<i>Detector (RBW: 100kHz)</i>	<i>P (dBc)</i>	<i>E (dBμV/m)</i>	<i>Result</i>
Peak	-49.94	63.46	PASS
Average	-49.94	42.19	PASS

Radiated field strength of the fundamental (RBW 1MHz, VBW 3MHz) is 113.4 dB(μ V/m)@3m

Hopping OFF

Channel 0:

Below 2400 MHz:

<i>Detector (RBW: 100kHz)</i>	<i>P (dBc)</i>	<i>Result</i>
Peak	-52.78	PASS

Below 2390 MHz:

<i>Detector (RBW: 1MHz)</i>	<i>E (dBμV/m)</i>	<i>Result</i>
Peak	61.02	PASS
Average	39.75	PASS

Channel 15:

Above 2483.5 MHz:

<i>Detector (RBW: 100kHz)</i>	<i>P (dBc)</i>	<i>E (dBμV/m)</i>	<i>Result</i>
Peak	-49.86	63.54	PASS
Average	-49.86	42.27	PASS

Radiated field strength of the fundamental (RBW 1MHz, VBW 3MHz) is 113.4 dB(μ V/m)@3m

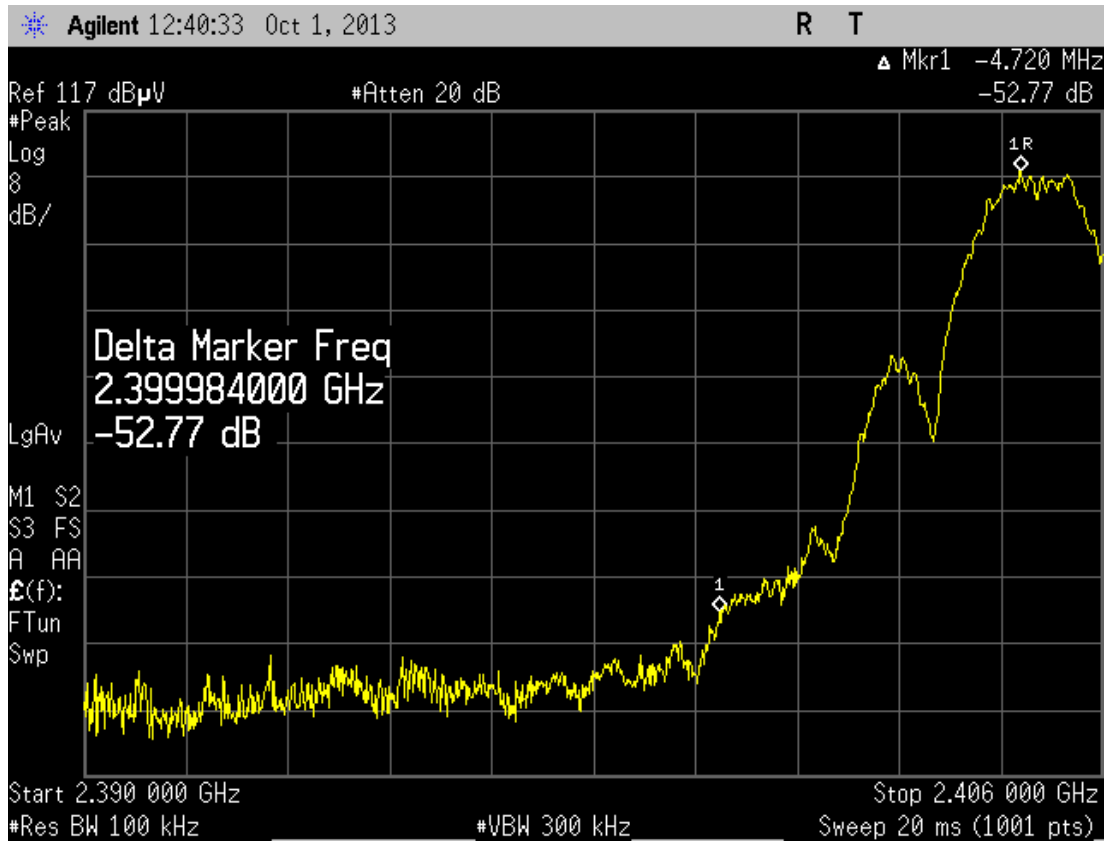

Figure 4, Hopping on, Band-edge compliance, low end <2400MHz

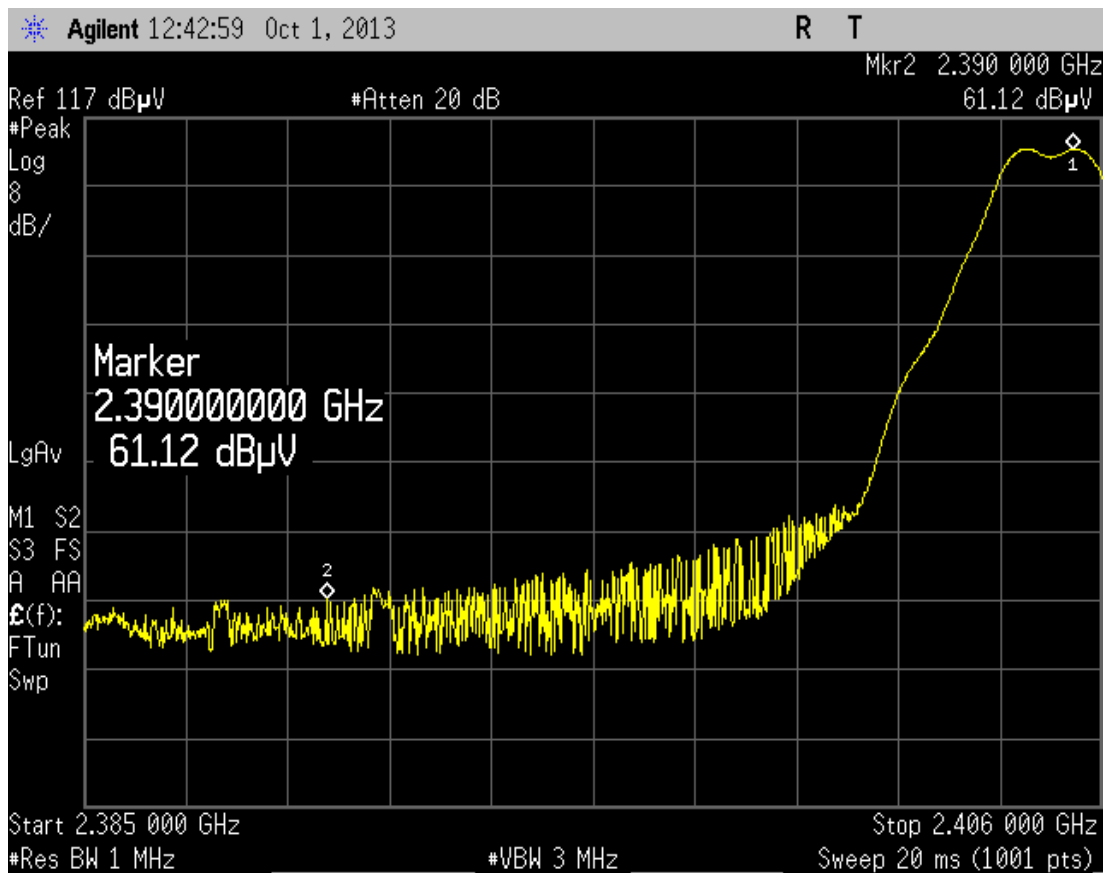

Figure 5, Hopping on, Band-edge compliance, low end <2390MHz

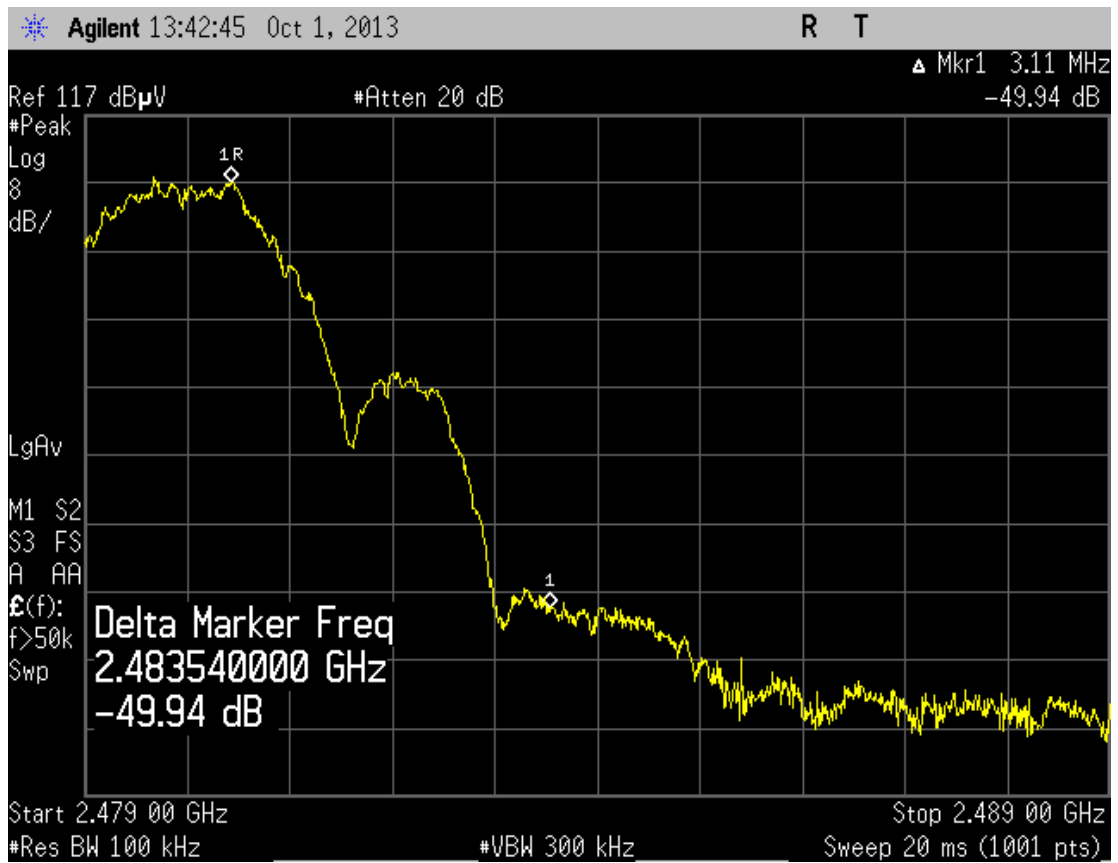

Figure 6, Hopping on, Band-edge compliance, high end



Figure 7, Hopping off, Channel 0, Band-edge compliance, low end

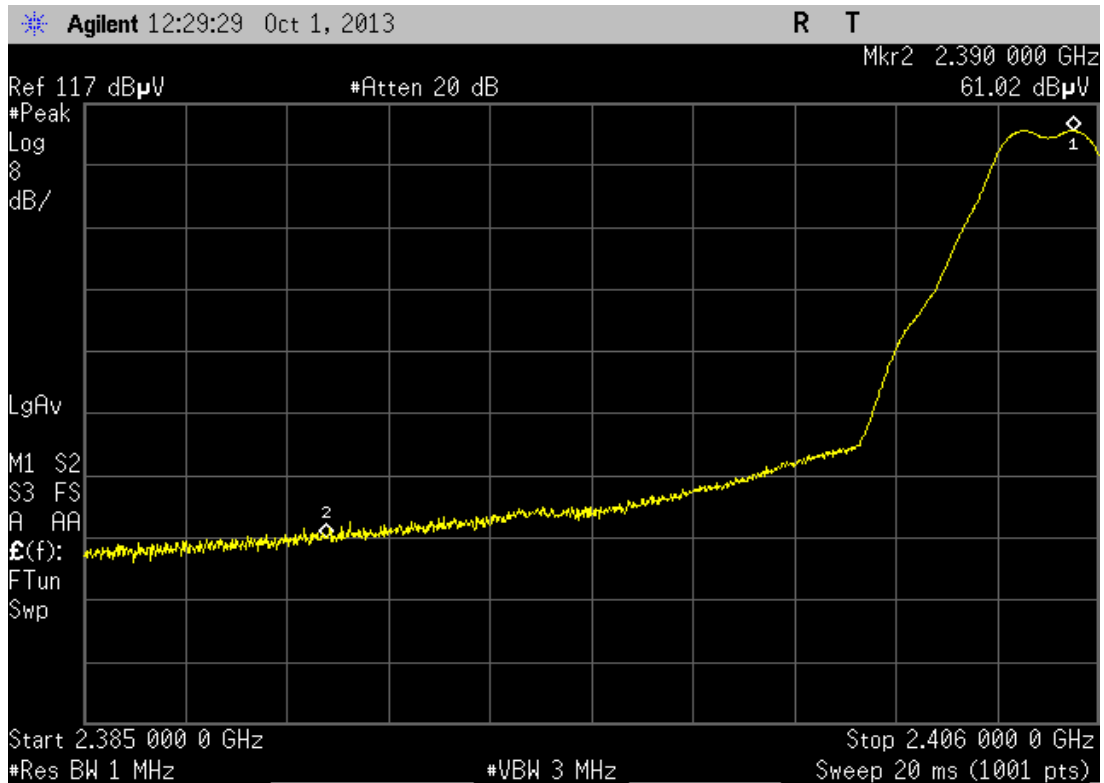

Figure 8, Hopping off, Channel 0, Band-edge compliance, low end

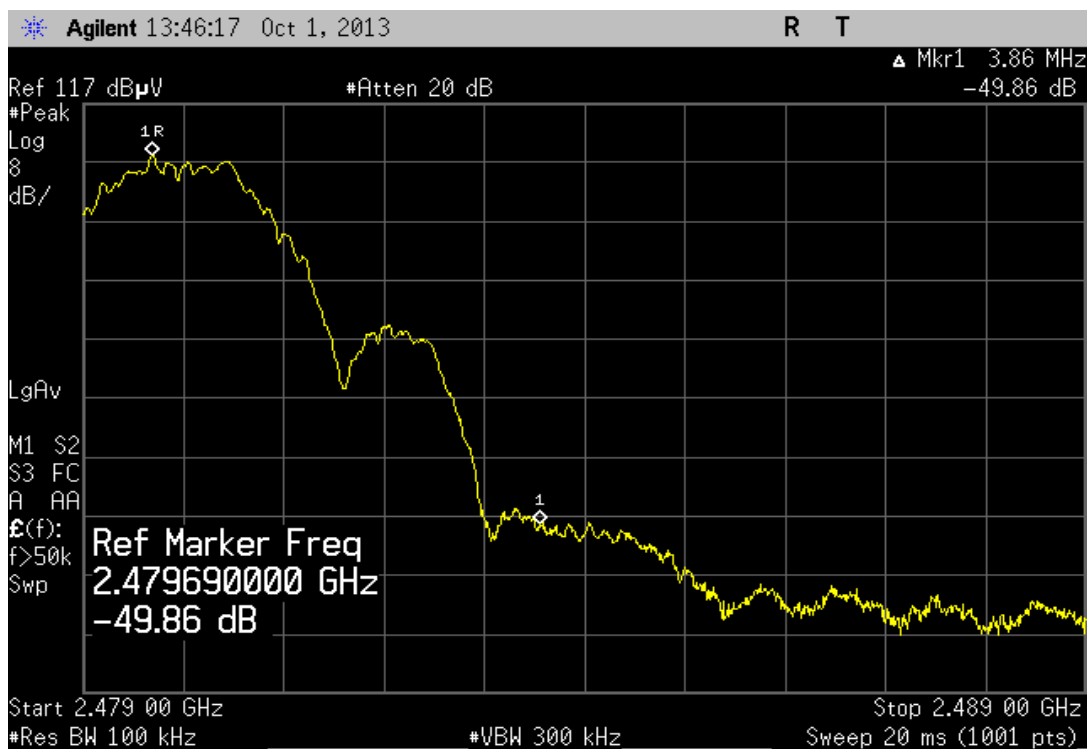

Figure 9, Hopping off, Channel 15, Band-edge compliance, high end

Test results EUT2
Hopping ON:

Below 2400 MHz:

<i>Detector (RBW: 100kHz)</i>	<i>P (dBc)</i>	<i>Result</i>
Peak	-52.04	PASS

Below 2390 MHz:

<i>Detector (RBW: 1MHz)</i>	<i>E (dBμV/m)</i>	<i>Result</i>
Peak	55.85	PASS
Average	34.58	PASS

Above 2483.5 MHz:

<i>Detector (RBW: 100kHz)</i>	<i>P (dBc)</i>	<i>E (dBμV/m)</i>	<i>Result</i>
Peak	-49.41	61.09	PASS
Average	-49.41	39.82	PASS

 Radiated field strength of the fundamental (RBW 1MHz, VBW 3MHz) is 110.5 dB(μ V/m)@3m

Hopping OFF

Channel 0:

Below 2400 MHz:

<i>Detector (RBW: 100kHz)</i>	<i>P (dBc)</i>	<i>Result</i>
Peak	-51.80	PASS

Below 2390 MHz:

<i>Detector (RBW: 1MHz)</i>	<i>E (dBμV/m)</i>	<i>Result</i>
Peak	57.08	PASS
Average	35.81	PASS

Channel 15:

Above 2483.5 MHz:

<i>Detector (RBW: 100kHz)</i>	<i>P (dBc)</i>	<i>E (dBμV/m)</i>	<i>Result</i>
Peak	-48.62	61.88	PASS
Average	-48.62	40.61	PASS

 Radiated field strength of the fundamental (RBW 1MHz, VBW 3MHz) is 110.5 dB(μ V/m)@3m

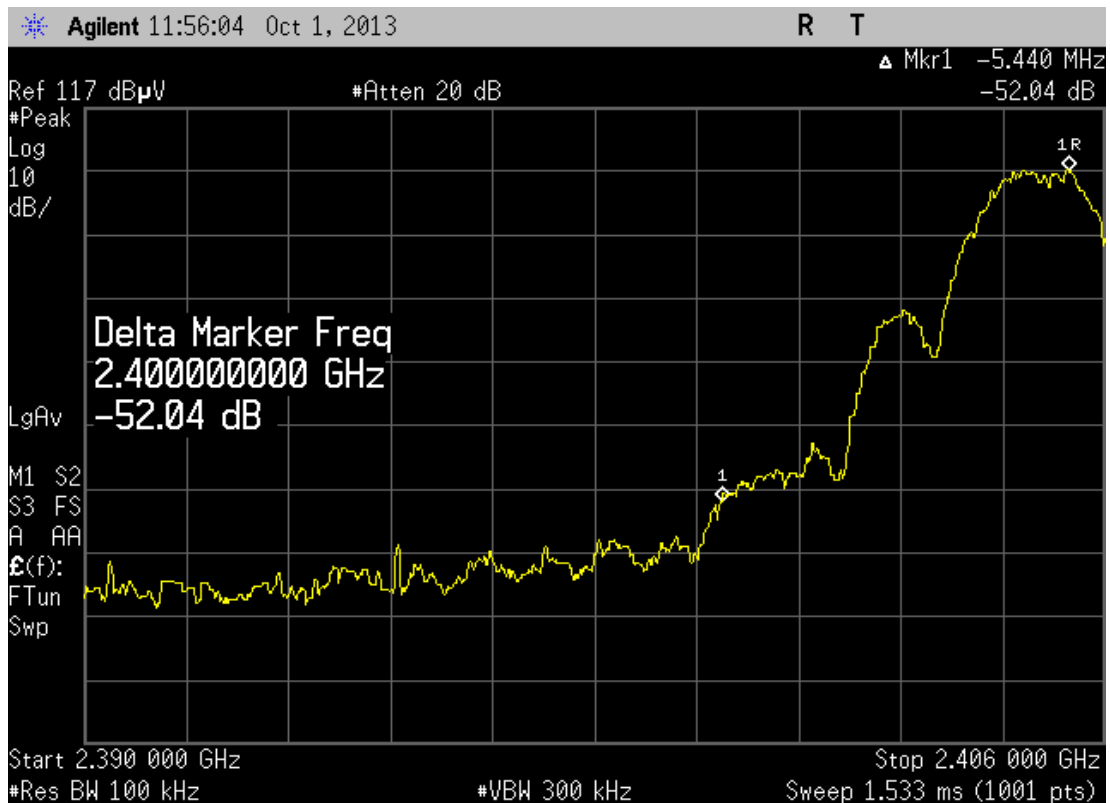

Figure 10, Hopping on, Band-edge compliance, low end <2400MHz

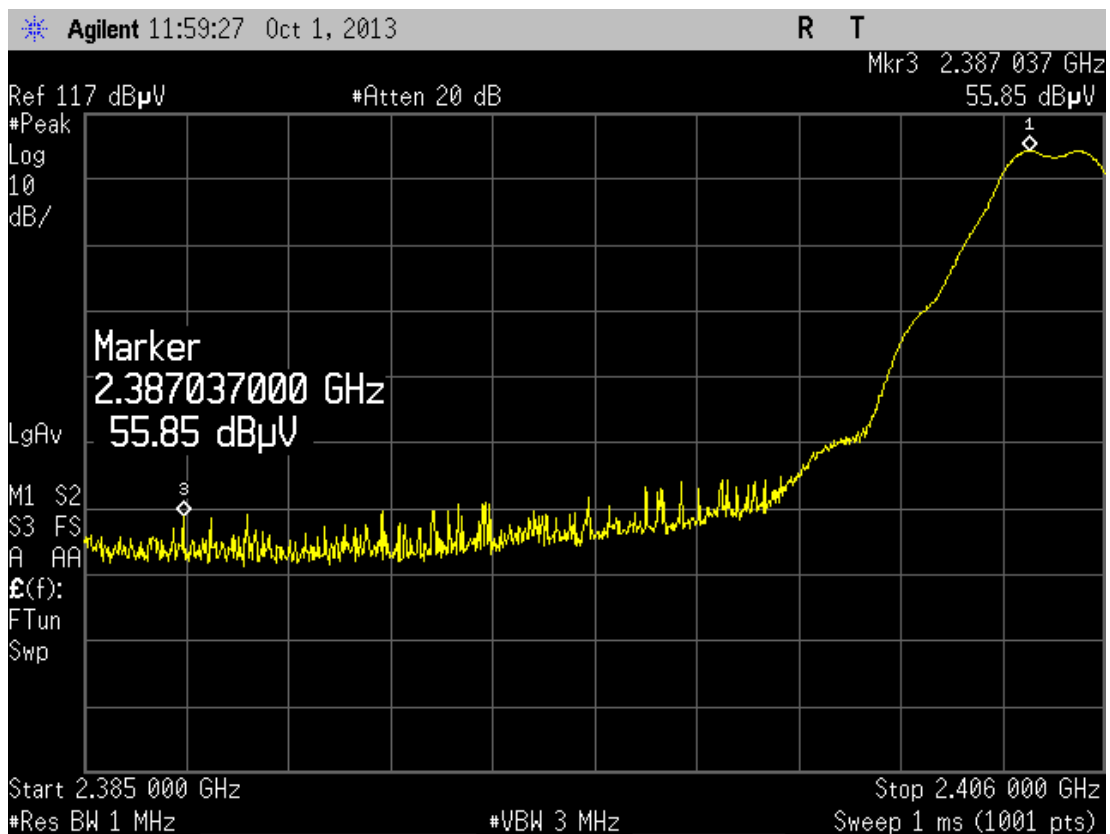

Figure 11, Hopping on, Band-edge compliance, low end <2390MHz

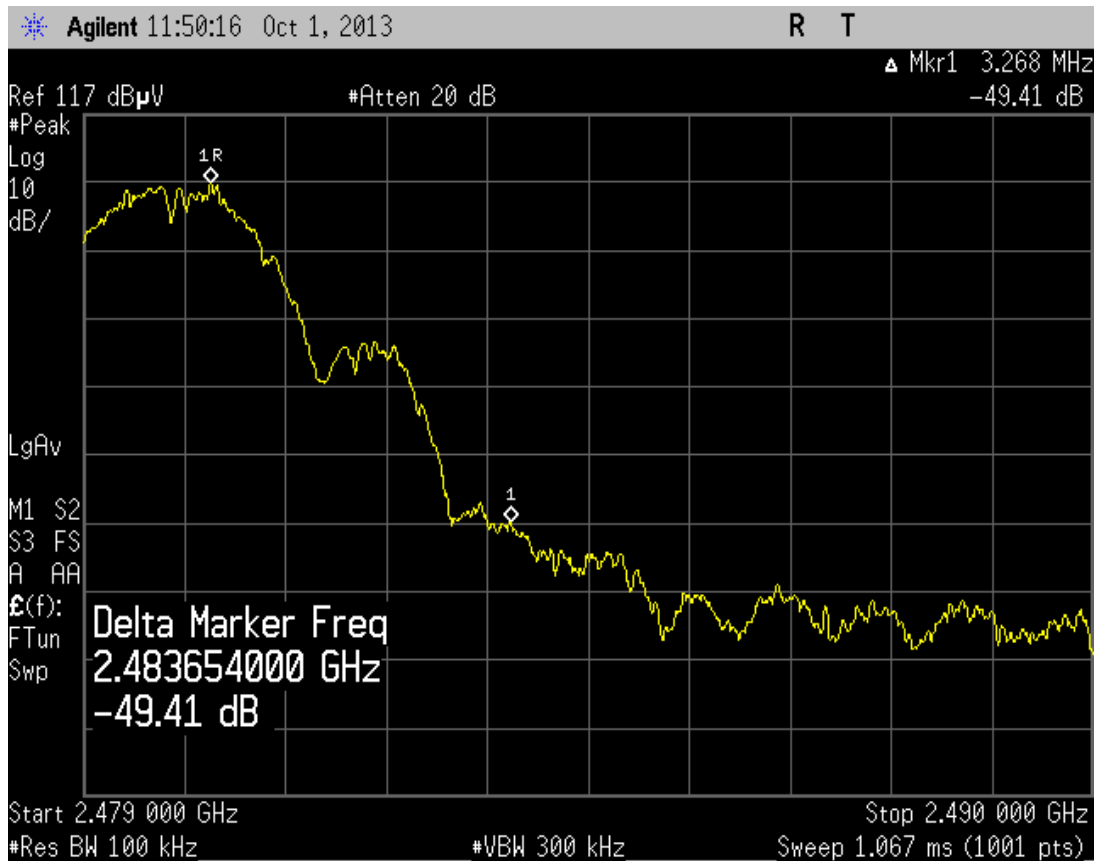

Figure 12, Hopping on, Band-edge compliance, high end

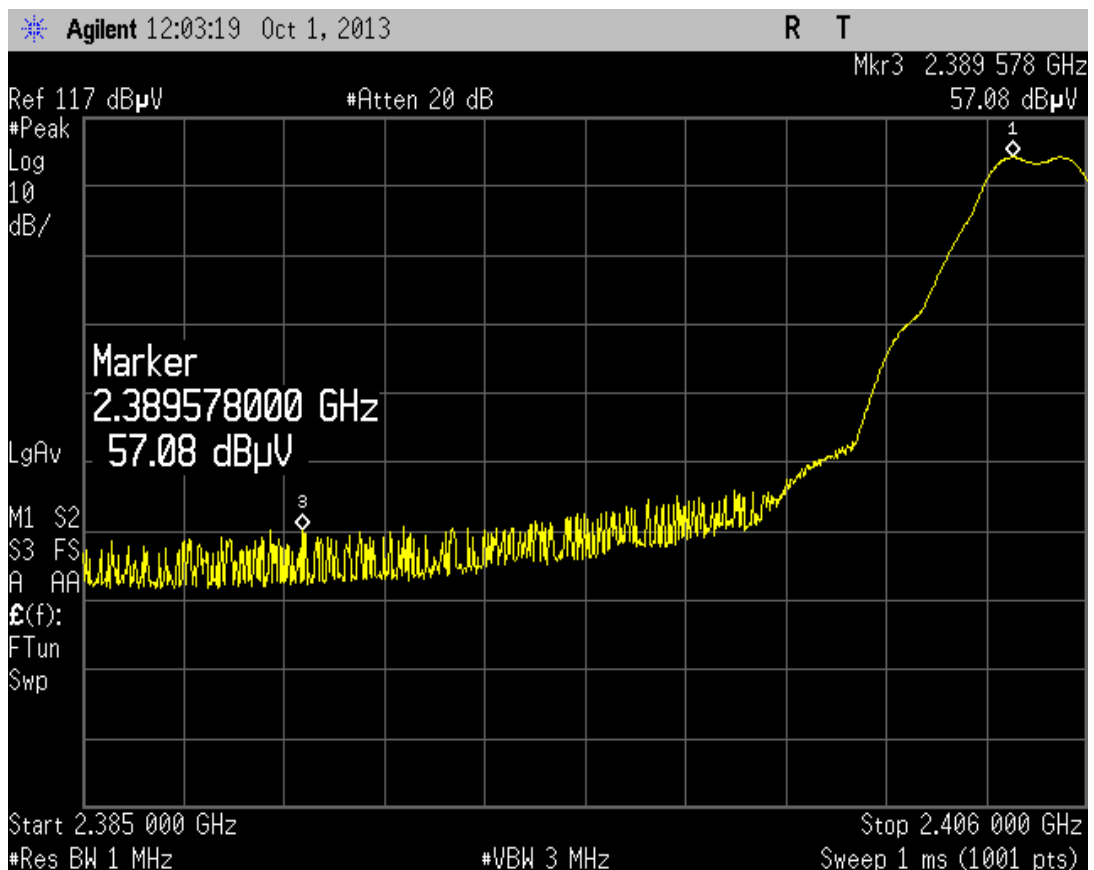

Figure 13, Hopping off, Channel 0, Band-edge compliance, low end

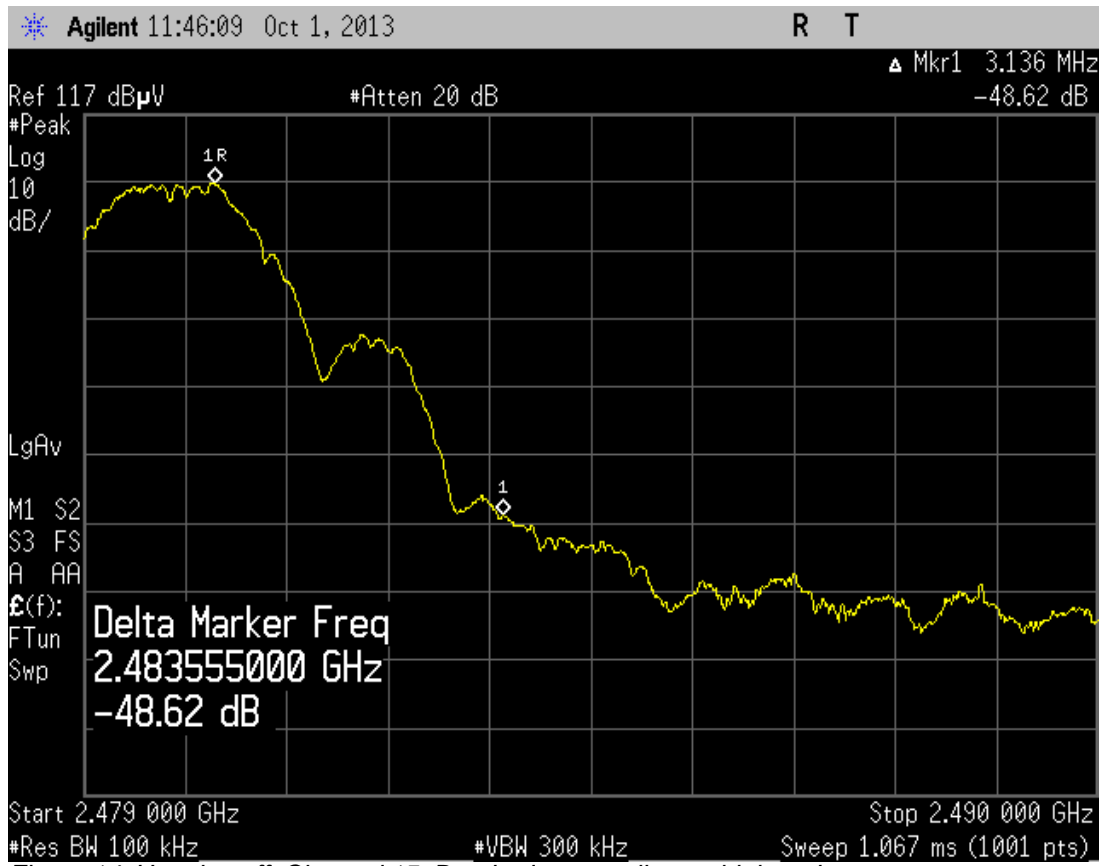

Figure 14, Hopping off, Channel 15, Band-edge compliance, high end

4.3 Spurious radiated emission

The test was performed as a compliance test. The test parameters concerned were as follows:

<i>EUT</i>	EUT1, setup 2
<i>Site name</i>	Nemko Oy / Perkaa
<i>FCC rule part</i>	§ 15.247 (d), § 15.209
<i>Section in RSS-210</i>	A8.5
<i>Date of testing</i>	30.09.2013
<i>Test equipment</i>	350, 319, 544, 709, 525, 559, 564, 566, 88, 710
<i>Test conditions</i>	22 °C, 31 % RH

4.3.1 EUT operation mode

<i>EUT channel</i>	Channel 0, 7 and 15
--------------------	----------------------------

4.3.2 Test method and limit

The test was performed in a semi-anechoic shielded room. The EUT was placed on a non-conductive 0.8 m high table standing on the turntable. During the test the distance from the EUT to the measuring antenna was 3 m. The excess length of the cables of the EUT was made into bundles 30-40 cm in length (see photograph 1). In order to find the maximum levels of the disturbance radiation the angle of the turntable, the height of the measuring antenna and the lay-out of the EUT cables were varied during the tests. The test was performed with the measuring antenna being both in horizontal and vertical polarizations.

Vertical and horizontal polarizations in the frequency range 30 – 1000 MHz was measured by using the peak detector. During the peak detector scan, the turntable was rotated from 0° to 360° with 30° step with the antenna heights 1.0 m and 3.0 m. The highest levels of the radiated interference field strength measured by using the quasi-peak detector were recorded.

Vertical and horizontal polarizations in the frequency range 1000 – 25000 MHz was measured by using the peak detector. During the peak detector scan, the turntable was rotated from 0° to 360° with 15° step with the antenna heights 1.0 m. The highest levels of the radiated interference field strength measured by using the average and peak detectors were recorded.

Minimum Standard: In any 100kHz bandwidth outside the frequency band in which the transmitter is operating, emissions shall be at least 20 dB below the fundamental emission or shall not exceed the following field strength limits:

Emissions falling in the restricted bands of 15.205 shall not exceed the limits shown in §15.209. At frequencies equal to or less than 1000 MHz, compliance with the limits in §15.209 shall be demonstrated using measurement instrumentation employing a CISPR quasi-peak detector. Above 1000 MHz, compliance with the emission limits in §15.209 shall be demonstrated based on the average value of the measured emissions. (below 1GHz: RBW 120kHz; above 1GHz: RBW 1MHz, VBW 3MHz)

3m measuring distance, FCC Part 15.209

<i>Frequency band MHz</i>	<i>limit, Quasi peak detector dB(μV/m)</i>
30 - 88	40
88 - 216	43.5
216 - 960	46
960 - 1000	54

<i>Frequency band MHz</i>	<i>limit, average detector dB(μV/m)</i>	<i>limit, peak detector dB(μV/m)</i>
1000 - 25000	54	74

3m measuring distance, CISPR 22, class B

<i>Frequency band MHz</i>	<i>limit, Quasi peak detector dB(μV/m)</i>
30 - 230	40
230 - 1000	47

The EUT was tested on three orthogonal axes.

The device was tested from 30 MHz to the tenth harmonic of the highest fundamental frequency per 15.33.

The device was tested on three channels per 15.31(l).

The CFR 47 Part 15. Subpart B. Class B limit of 500 μV/m has been calculated to correspond 54 dB(μV/m) as follows: $[dB(\mu V/m)] = 20 \log[\mu V/m]$.

The measurement results were obtained as described below.

$$E [dB(\mu V/m)] = U_{RX} + A_{CABLE} + AF - G_{PREAMP}$$

Where

U_{RX} receiver reading

A_{CABLE} attenuation of the cable

AF antenna factor

G_{PREAMP} gain of the preamplifier

Duty Cycle correction factor(dB) -21.27 dB was used.

4.3.3 Test results

EUT1

Above 1GHz. Channel low, (RBW 100kHz, VBW 300 kHz)

Frequency MHz	Peak dBc	Limit dBc	Margin dB	Result
7215	-40.3	-20.0	20.3	PASS
9620	-41.9	-20.0	21.9	PASS

All peak emissions were more than 30 dB below the in-band power.

Above 1GHz. Channel mid, (RBW 100kHz, VBW 300 kHz)

Frequency MHz	Peak dBc	Limit dBc	Margin dB	Result
9760	-50.6	-20.0	30.6	PASS

All peak emissions were more than 30 dB below the in-band power.

Above 1GHz. Channel high, (RBW 100kHz, VBW 300 kHz)

Frequency MHz	Peak dBc	Limit dBc	Margin dB	Result
9920	-49.9	-20.0	29.9	PASS

All peak emissions were more than 30 dB below the in-band power.

4.3.4 Test results, Radiated emissions in restricted bands 30 MHz – 25 GHz

EUT1

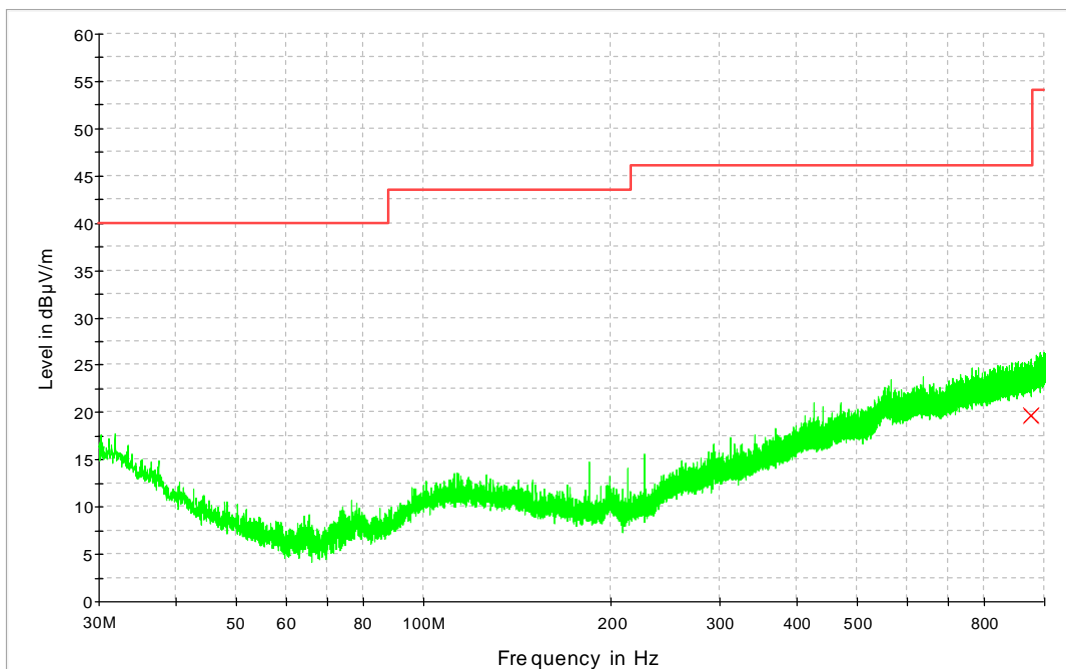

Figure 15, Spurious emissions, 30-1000 MHz, middle channel

Below 1GHz, Channel mid (RBW120kHz)

Frequency MHz	Quasi peak dB(µV/m)	Limit dB(µV/m)	Margin dB	Result
950.020	19.7	46.0	26.3	PASS

TX on channel low/2405 MHz, EUT1

(RBW 1MHz, VBW 3MHz)

Frequency MHz	Average (Av)			Peak		
	Result dB(μ V/m)	Limit dB(μ V/m)	Margin dB	Result dB(μ V/m)	Limit dB(μ V/m)	Margin dB
4810	28.8	54	25.2	50.1	74.0	23.9
12025	35.8	54	18.2	57.1	74.0	16.9

TX on channel middle/2440 MHz, EUT1

(RBW 1MHz, VBW 3MHz)

Frequency MHz	Average (Av)			Peak		
	Result dB(μ V/m)	Limit dB(μ V/m)	Margin dB	Result dB(μ V/m)	Limit dB(μ V/m)	Margin dB
4880	30.2	54	23.9	51.42	74.0	22.6
7320	42.9	54	11.1	64.17	74.0	9.8
12200	36.1	54	17.9	57.38	74.0	16.6

TX on channel high/2480 MHz, EUT1

(RBW 1MHz, VBW 3MHz)

Frequency MHz	Average (Av)			Peak		
	Result dB(μ V/m)	Limit dB(μ V/m)	Margin dB	Result dB(μ V/m)	Limit dB(μ V/m)	Margin dB
4960	31.2	54	22.8	52.5	74.0	21.5
7440	42.0	54	12.0	63.3	74.0	10.7
12400	35.2	54	18.8	56.5	74.0	17.5

The average was obtained from the peak using the duty cycle correction factor -21.27. The peak was measured using a peak detector.

Test results, EUT2

Above 1GHz. Channel low, (RBW 100kHz, VBW 300 kHz)

Frequency MHz	Peak dBc	Limit dBc	Margin dB	Result
7215	-48.8	-20.0	28.8	PASS
9620	-44.1	-20.0	24.1	PASS

All peak emissions were more than 30 dB below the in-band power.

Above 1GHz. Channel mid, (RBW 100kHz, VBW 300 kHz)

Frequency MHz	Peak dBc	Limit dBc	Margin dB	Result
9760	-43.0	-20.0	23.0	PASS

All peak emissions were more than 30 dB below the in-band power.

Above 1GHz. Channel high, (RBW 100kHz, VBW 300 kHz)

Frequency MHz	Peak dBc	Limit dBc	Margin dB	Result
9920	-42.0	-20.0	22.0	PASS

All peak emissions were more than 30 dB below the in-band power.

Test results, Radiated emissions in restricted bands 30 MHz – 25 GHz (TX and RX) EUT2

Figure 16, Spurious emissions, 30-1000 MHz, middle channel

Below 1GHz, Channel mid (RBW120kHz)

Frequency MHz	Quasi peak dB(µV/m)	Limit dB(µV/m)	Margin dB	Result
31.020	12.1	40.0	27.9	PASS
890.340	19.4	46.0	26.6	PASS

TX on channel low/2405 MHz, EUT2

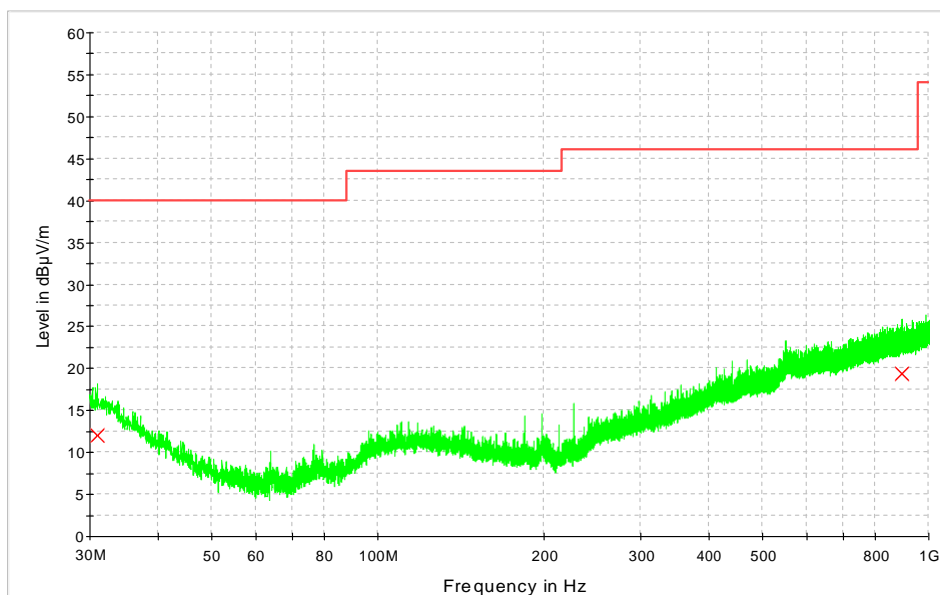
(RBW 1MHz, VBW 3MHz)

Frequency MHz	Average (Av)			Peak		
	Result dB(μ V/m)	Limit dB(μ V/m)	Margin dB	Result dB(μ V/m)	Limit dB(μ V/m)	Margin dB
4810	29.9	54	24.1	51.2	74.0	22.8
12025	33.2	54	20.8	54.5	74.0	19.5

TX on channel middle/2440 MHz, EUT2

(RBW 1MHz, VBW 3MHz)

Frequency MHz	Average (Av)			Peak		
	Result dB(μ V/m)	Limit dB(μ V/m)	Margin dB	Result dB(μ V/m)	Limit dB(μ V/m)	Margin dB
4880	30.0	54	24.0	51.3	74.0	22.7
7320	40.4	54	13.6	61.7	74.0	12.3
12200	33.2	54	20.8	54.5	74.0	19.5

TX on channel high/2480 MHz, EUT2

(RBW 1MHz, VBW 3MHz)

Frequency MHz	Average (Av)			Peak		
	Result dB(μ V/m)	Limit dB(μ V/m)	Margin dB	Result dB(μ V/m)	Limit dB(μ V/m)	Margin dB
4960	32.5	54	21.5	53.8	74.0	20.2
7440	39.0	54	15.0	60.3	74.0	13.7
12400	34.8	54	19.2	56.1	74.0	17.9

The average was obtained from the peak using the duty cycle correction factor -21.27. The peak was measured using a peak detector.

4.4 Duty cycle correction factor

Spectrum analyzer with zero span was used to investigate spectrum.

15.35(c) Unless otherwise specified, e.g. § 15.255(b), when the radiated emission limits are expressed in terms of the average value of the emission, and pulsed operation is employed, the measurement field strength shall be determined by averaging over one complete pulse train, including blanking intervals, as long as the pulse train does not exceed 0.1 seconds. As an alternative (provided the transmitter operates for longer than 0.1 seconds) or in cases where the pulse train exceeds 0.1 seconds, the measured field strength shall be determined from the average absolute voltage during a 0.1 second interval during which the field strength is at its maximum value. The exact method of calculating the average field strength shall be submitted with any application for certification or shall be retained in the measurement data file for equipment subject to notification or verification.

4.4.2 Test data

The average time of occupancy on any channel shall not be greater than 0.4 seconds within a period of 0.4 seconds multiplied by the number of hopping channels employed.

Number of hopping channels 16

Channel occupancy: During $0.4s \cdot 16 = 6.4s$ 67 hits at 2440 MHz. Assuming equal use of channels on average this is $67 \times 16 / 6.4 = 167.5$ hops per second. Pulse period (T) = $16 / 167.5 = 95.5$ ms

Pulse period (T) = $6.4s / 67 = 95.5ms$

Pulses/100ms=2

Length of one pulse = 4.32ms

DutyCycleCorrectionFactor = $20 \cdot \log(T_{occ}/100) = 20 \cdot \log(2 \cdot 4.32/100) = -21.27dB$

4.5 AC power line conducted emissions

The test was performed as a compliance test. The test parameters concerned were as follows:

<i>EUT</i>	EUT1
<i>Site name</i>	Nemko / Perkaa
<i>FCC rule part</i>	§ 15.207
<i>Test method</i>	CISPR 22 /ANSI C63.4-2009
<i>Date of testing</i>	01.10.2013
<i>Test equipment</i>	348, 745, 694
<i>Test conditions</i>	22 °C, 40 % RH

4.5.1 Test method and limit

The measurement is made according to ANSI C63.4-2009. The test was performed inside a shielded room where the floor and one of the walls of the test site comprised the reference ground plane (RGP). For the duration of the test the EUT was placed on a non-conductive table 0.8 m high standing on the reference ground plane (see photograph 3). The excess length of the cables of the EUT were made into bundles 30-40 cm in length. The power input cable of the EUT was connected to an artificial mains network. The test was performed separately on the phase and also on the neutral wire.

The disturbances were first examined by performing a spectrum scan by using a peak detector. The general procedure in the conducted disturbance emission test is that no further measurements are necessary if the disturbance levels measured by using the peak detector are below the limit value defined for the measurement performed by using an average detector.

If not, then at the test frequencies concerned the measurement is performed also by using a quasi-peak detector. If the disturbance levels measured by using the quasi-peak detector are below the limit value defined for the measurement performed by using an average detector, then measurements by using the average detector are not necessary.

CISPR 22, class B limits

<i>Frequency band MHz</i>	<i>Quasi-peak dB(μV)</i>	<i>Average limit dB(μV)</i>
0.15 – 0.5	66 – 56	56 – 46
0.5 – 5	56	46
5 - 30	60	50

4.5.2 EUT operation mode

<i>EUT operation mode</i>	Transmitter on
<i>EUT channel</i>	hopping
<i>Power supply operation voltage¹⁾</i>	115 V / 60 Hz

Note ¹⁾ Typical laboratory DC power supply Oltronix B603 D/F was used.

4.5.3 Test results

Line N

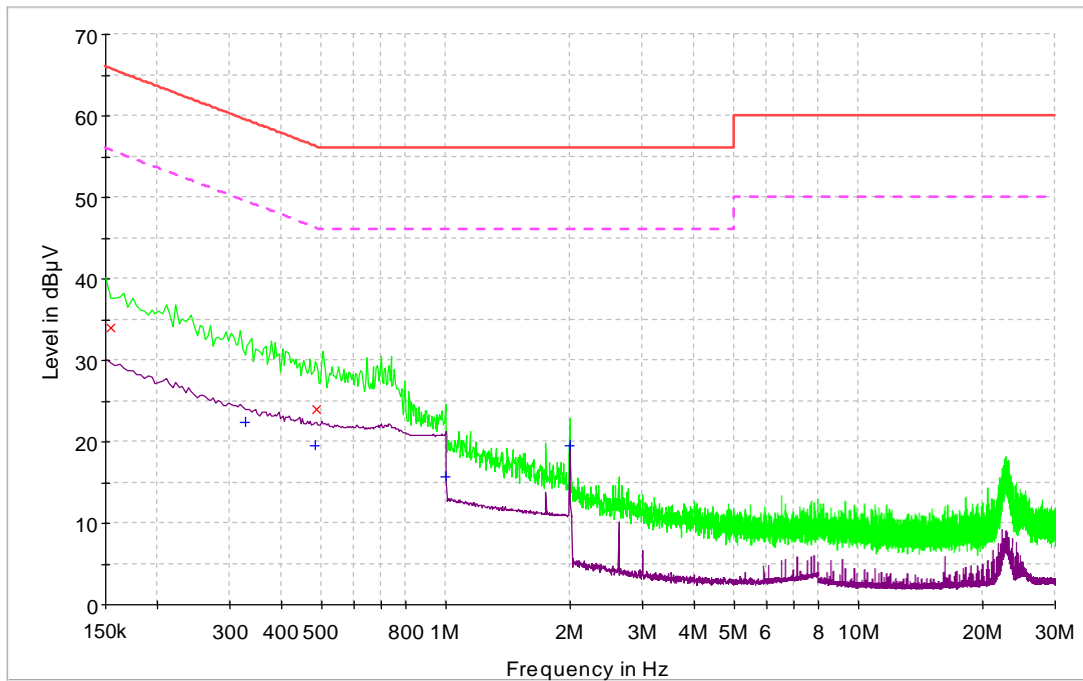

Figure 10. AC powerline emissions, Line N

Highest emissions (BW 10kHz):

Frequency MHz	Quasi-peak dB(µV)	Limit value dB(µV)	Margin dB	Line	Result
0.154	34.0	65.8	31.8	N	Pass
0.486	24.0	56.2	32.2	N	Pass

Frequency MHz	Average dB(µV)	Limit value dB(µV)	Margin dB	Line	Result
0.327	22.3	49.5	27.2	N	Pass
0.484	19.5	46.3	26.8	N	Pass
0.999	15.7	46.0	30.3	N	Pass
2.000	19.5	46.0	26.5	N	Pass

Line L

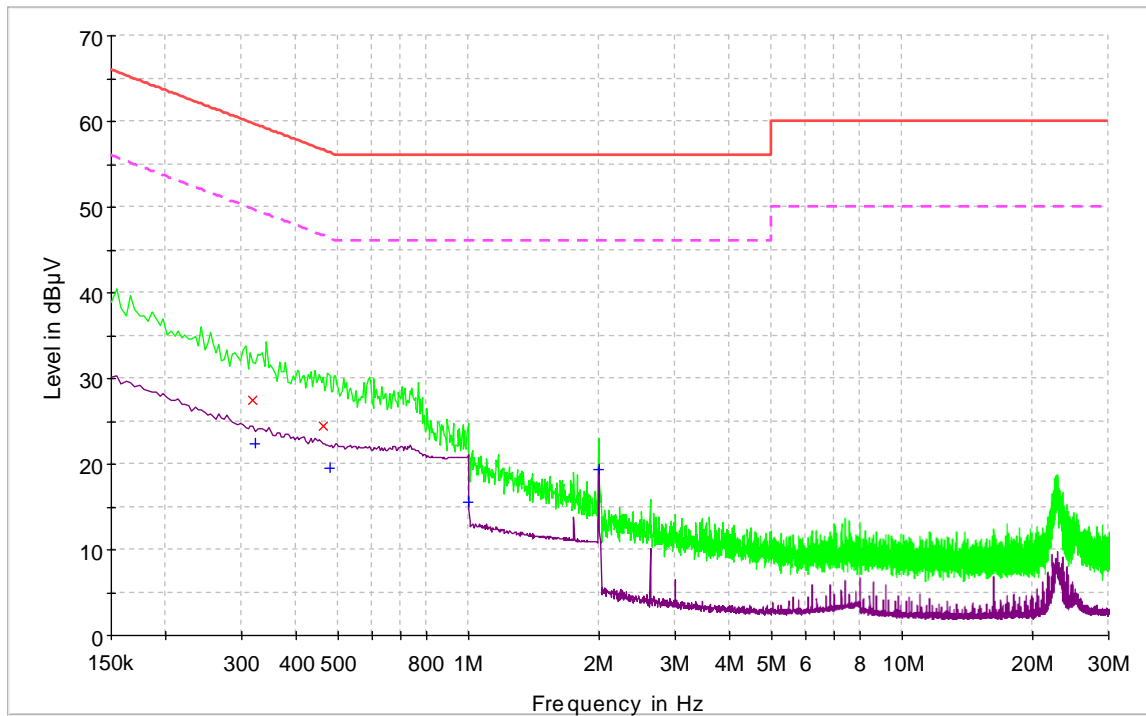

Figure 11. AC powerline emissions, Line L

Highest emissions (BW 10kHz):

Frequency MHz	Quasi-peak dB(µV)	Limit value dB(µV)	Margin dB	Line	Result
0.317	27.5	59.8	32.3	L	Pass
0.462	24.5	56.7	32.2	L	Pass

Frequency MHz	Average dB(µV)	Limit value dB(µV)	Margin dB	Line	Result
0.322	22.5	49.7	27.2	L	Pass
0.481	19.5	46.3	26.8	L	Pass
0.999	15.6	46.0	30.4	L	Pass
1.999	19.3	46.0	26.7	L	Pass

5. List of test equipment

Each active test equipment is calibrated once a year, antennas every 18 months and other passive equipment every 24 months.

Nr.	Equipment	Type	Manufacturer	Serial number	Cal date	Cal due
390	RF attenuator PAD	WA2-10	Weinschel	3784	10.12.2011	12.2013
694	EMI Test Receiver	ESPC	Rohde & Schwarz	842888/023	11.12.2012	12.2013
566	Spectrum analyzer	E4448A	Agilent	US42510236	17.4.2013	4.2014
709	EMI test receiver	ESU8	Rohde & Schwarz	100297	24.07.2013	7.2014
567	RF generator	E8257C	Agilent	MY43320736	25.2.2013	2.2014
544	RF-amplifier	ZFL-2000VH2	Mini-Circuits	QA0749010	9.1.2013	1.2014
564	RF amplifier	CA018-4010	CIAO Wireless	132	9.1.2013	1.2014
710	RF-amplifier	ALS 1826-41-12	ALC Microwave Inc.	0011	28.10.2011	10.2013
745	2-Line V-Network	ENV216	Rohde & Schwarz	101466	11.6.2013	06.2014
319	Antenna	CBL6112	Chase	2018	12.7.2012	1.2014
525	Double-Ridged Horn	3115	Emco	6691	10.10.2012	4.2014
542	Double-Ridged Horn	3115	Emco	00023905	10.10.2012	4.2014
559	Highpass filter	WHKX3.0/18G-10ss	Wainwright	1	7.12.2011	2.2013
88	Waveguide horn	638	Narda	8003	-	-
371	AC Power source	500i-400	California Instr.	HK 52064	23.5.2012	5.2013
350	Semianechoic shielded room	RFD-F-100	Euroshield Oy	1327	26.10.2012	10.2014

6. Photographs



Photograph 1: Test setup, EUT 1

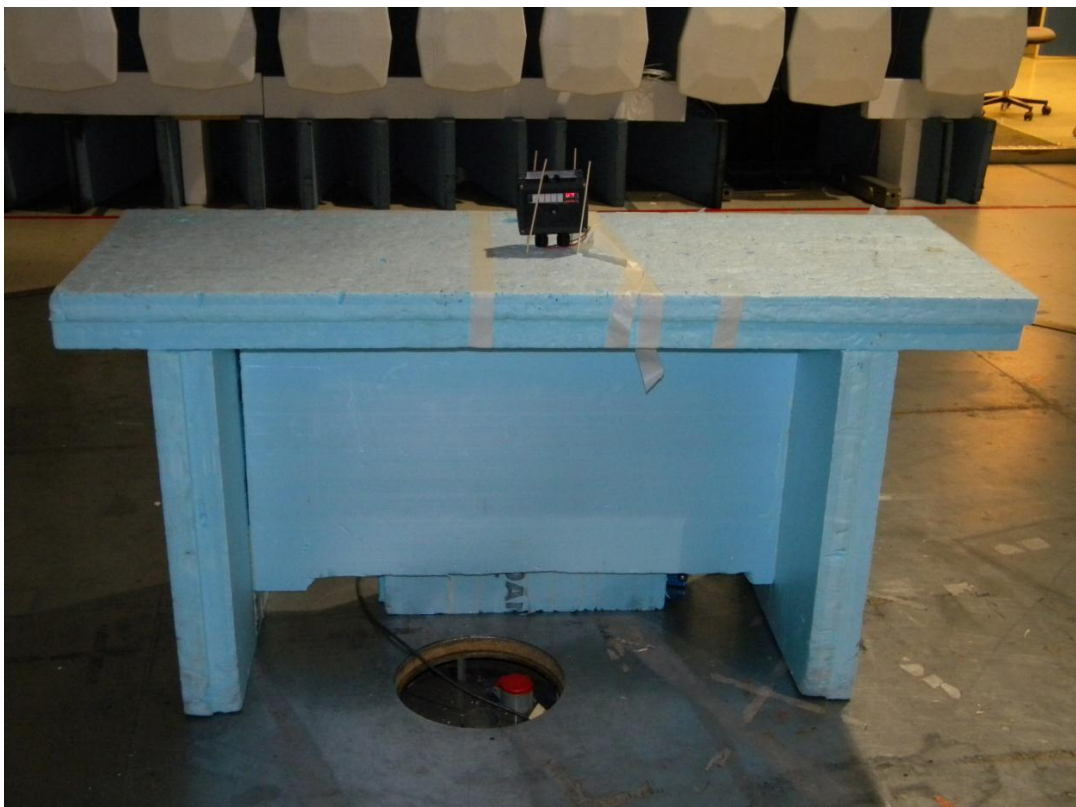

Photograph 1: Test setup, EUT 2



Photograph 3: AC power line conducted emissions test setup, EUT 1