

SDR-ICS-43 User Manual

VERSION 0.28

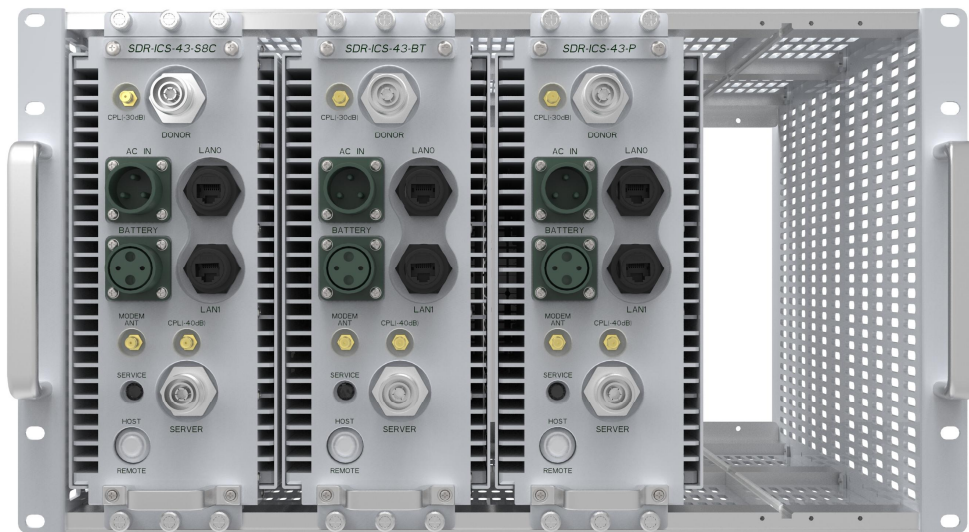

3116 West Vanowen St.
Burbank, CA 91505
Tel: 818-840-8131
Fax: 818-840-8138

www.adrftech.com

*Information in this document is subject to change without notice.
Advanced RF Technologies, Inc. 1996-2017.
All rights reserved.*

- Please send comments to:

E-Mail: info@adrfttech.com

Phone: (818) 840-8131
(800) 313-9345

Fax: (818) 840-8138

- Address:

Advanced RF Technologies, Inc.
Attention: Technical Publications Department
3116 Vanowen St.
Burbank, CA 91505
USA
www.adrfttech.com

REVISION HISTORY

Version	Author	Descriptions	Date
0.1	ADRF	Initial Release	11/07/ 2017
0.2	CK ,CHO	Update	05/14/ 2018
0.21	CK ,CHO	Update, Model name changed	07/10/ 2018
0.22	CK ,CHO	Update	07/18/ 2018
0.23	CK ,CHO	AWS Bandwidth Change	08/31/ 2018
0.25	CK ,CHO	7FN,WCS Band Add	11/29/ 2018
0.26	CK ,CHO	7FN Update	12/10/2018
0.28	CK ,CHO	Regulatory Warning Statement update	01/23/2019
0.28	CK ,CHO	Regulatory Warning Statement update	01/28/2019

CHANGE LIST

Version	Change list	Contents

TABLE OF CONTENTS

1.	Introduction.....	8
1.1	Highlights.....	8
1.2	Parts List.....	9
1.3	Repeater Quick View.....	10
1.4	Warnings and Hazards.....	10
2.	Overview.....	15
2.1	LED.....	15
2.2	Host/Remote Switch.....	15
2.3	Ethernet Port.....	15
2.3.1	AC Power.....	16
2.3.2	Back Up Battery Port.....	16
2.4	RF Ports.....	17
3.	Alarms.....	18
3.1	Message Board Alarms and Notification.....	18
3.2	Alarms.....	19
4.	Installation.....	20
4.1	Installation Procedures.....	20
4.1.1	Wall Mount Procedure.....	20
4.2	Grounding.....	20
4.3	Antenna Separation/Isolation.....	21
4.4	Line of Sight.....	22
5.	SDR-ICS-43 Web-GUI Setup.....	23
5.1	Repeater/PC Connection Using Web-GUI.....	23
5.2	Status Tab.....	24
5.2.1	Band.....	24
5.2.2	Power & Gain.....	24
5.2.3	Alarm.....	25
5.2.4	Message Board.....	25
5.2.5	Install, Power and modem Status.....	26
5.2.6	Repeater Info / Repeater Location / Technical Support / Installer Contact Info.....	26
5.3	Control Tab.....	28
5.3.1	General Setting.....	28
5.3.2	System.....	29
5.3.3	SNMP Trap.....	29
5.3.4	Gain Control.....	29
5.3.5	ICS Control.....	30
5.3.6	Alarm Setting.....	30
5.4	Install Tab.....	31
5.4.1	Install.....	31
5.4.2	SNMP.....	32
5.4.3	Location.....	32

5.4.4	Remote Ethernet Settings.....	32
5.4.5	Auto Installation.....	33
5.4.6	Date & Time.....	34
5.4.7	Band Selection.....	35
5.5	System.....	35
5.5.1	System: Account.....	35
5.5.1.1	System: Account- Account Management.....	35
5.5.1.2	System: Account- New Account.....	35
5.5.1.3	System: Account- Change Password.....	36
5.5.2	System- Closeout Package.....	37
5.5.3	System- User Log.....	37
5.5.4	System: Update.....	38
5.5.5	System- Backup.....	38
5.6	Help.....	39
5.7	Logout.....	39
6.	Maintenance Guide for SDR-ICS-43 Repeater.....	39
6.1	Periodic Inspection Checklist.....	39
6.2	Preventive Measures for Optimal Operation.....	39
6.2.1	Recommendations.....	39
6.2.2	Precautions.....	39
7.	Warranty and Repair Policy.....	40
7.1	General Warranty.....	40
7.2	Limitations of Warranty.....	40
7.3	Limitation of Damages.....	40
7.4	No Consequential Damages.....	40
7.5	Additional Limitation on Warranty.....	40
7.6	Return Material Authorization (RMA).....	40
8.	Specifications.....	41
8.1	Electrical Specifications.....	41
	SDR-ICS-43_Sprint Specifications.....	41
	SDR-ICS-43_Verizon Specifications.....	42
	Mechanical Specifications.....	오류! 책갈피가 정의되어 있지 않습니다.
	Environmental Specifications.....	오류! 책갈피가 정의되어 있지 않습니다.
	Power Specifications.....	오류! 책갈피가 정의되어 있지 않습니다.
	Other Specifications.....	오류! 책갈피가 정의되어 있지 않습니다.
9.	Appendix.....	45
9.1	Shutdown Retry Logic.....	45

FIGURES

Figure 1-1	SDR-ICS-43 Repeater Parts List.....	9
Figure 2-1	LED.....	15
Figure 2-2	Host/Remote Switch.....	15

Figure 2-3	AC Input Port.....	16
Figure 2-5	Battery Backup Port.....	16
Figure 2-6	RF port.....	17
Figure 4-1	SDR-ICS-43 Wall Mount.....	20
Figure 4-2	Ground Cable Connection.....	20
Figure 4-3	RF Repeater Oscillation.....	21
Figure 4-4	Line of Sight to the eNode-B(or BTS).....	22
Figure 5-1	Login page.....	23
Figure 5-2	Status Tab.....	24
Figure 5-3	Band Display.....	24
Figure 5-4	Power & Gain Display.....	25
Figure 5-5	Alarm Display.....	25
Figure 5-6	Message Board.....	26
Figure 5-7	Install, Power and modem Status.....	26
Figure 5-8	Repeater Info / Repeater Location / Technical Support / Installer Contact Info.....	27
Figure 5-9	Control page.....	28
Figure 5-10	General Setting.....	28
Figure 5-11	System.....	29
Figure 5-12	Pop-up message when Reboot button is pressed.....	29
Figure 5-13	Pop-up message when Factory Setting button is pressed.....	29
Figure 5-14	SNMP Trap.....	29
Figure 5-15	Gain Control Setting.....	30
Figure 5-16	ICS Control Setting.....	30
Figure 5-17	Alarm Threshold Setting.....	30
Figure 5-18	Install page.....	31
Figure 5-19	SNMP.....	32
Figure 5-20	Location Setting.....	32
Figure 5-21	Remote Ethernet Settings.....	33
Figure 5-22	Auto Installation.....	33
Figure 5-23	Repeater Location Info / Repeater Installer Info.....	34
Figure 5-24	Date & Time Setting.....	34
Figure 5-25	Band Selection.....	35
Figure 5-26	System: Account- Account Management.....	35
Figure 5-27	System: Account- New Account.....	36
Figure 5-29	System: Account- Change Password.....	36
Figure 5-30	System- Closeout Package.....	37
Figure 5-31	System- Closeout Package after the file upload.....	37
Figure 5-32	System – User Log.....	37
Figure 5-33	System – Update.....	38
Figure 5-35	System Backup.....	39
Figure 5-36	Help.....	39

TABLES

Table 1-1	Parts List.....	9
Table 2-1	RF Module LED Specifications.....	15
Table 3-1	Message Board Alarms and Notification.....	18
Table 3-2	Alarms Threshold.....	19
Table 8-1	Electrical Specifications.....	오류! 책갈피가 정의되어 있지 않습니다.

Terms and Abbreviations

The following is a list of abbreviations and terms used throughout this document.

Abbreviation/Term	Definition
AGC	Automatic Gain Control
ALC	Automatic Level Control
AROMS	ADRF' Repeater Operation and Management System
BDA	Bi-Directional Amplifier
BTS	Base Transceiver Station
CDMA	Code Division Multiple Access
CFR	Crest Factor Reduction
CP	Cyclic Prefix
CW	Continuous Wave (un-modulated signal)
DAS	Distributed Antenna System
DL	Downlink
eNode-B	Evolved Node B which is the element in E-UTRA of LTE that is the evolution of the element Node B in UTRA of UMTS
HPA	High Power Amplifier
HW	Hardware
ICS	Interference Cancellation System
ILC	Interference Level Control
IF	Intermediate Frequency
LNA	Low Noise Amplifier
LTE	Long Term Evolution
MS	Mobile Station
OFDM	Orthogonal Frequency-Division Multiplexing
OFDMA	Orthogonal Frequency-Division Multiple Access
PAR (PAPR)	Peak to Average Power Ratio (Crest Factor)
PLL	Phase Locked Loop
PSU	Power Supply Unit
QAM	Quadrature Amplitude Modulation
QPSK	Quadrature Phase Shift Keying
RB	Resource Block
RF	Radio Frequency
SC-FDMA	Single Carrier-Frequency Division Multiple Access
SQE	Signal Quality Estimate
SW	Software
eUE	LTE User Equipment (LTE Mobile Station)
UL	Uplink
VSWR	Voltage Standing Wave Ratio

1. INTRODUCTION

The SDR-ICS-43 is an over-the-air high power repeater. SDR-ICS-43 supports SMR800+Cellular, PCS, BRS-TDLTE band.

1.1 Highlights

- Active ICS (Interference Cancellation System)
- Band Selectable
- Digital filtering with sharp roll-off (>50dBc @ ± 1 MHz from sub-band edge)
- Remote monitoring and control capability using our Web-based GUI
- 95 dB of max gain and 43/30dBm (DL/UL) Composite power
- Support optional internal modem box for remote access and alarming
- Configurable network setting in order to interface with 3rd party external modem boxes
- Adjustable ALC Output Power Level
- Supports SNMP v1, v2, v3 (get, set & traps)
- Incremental Automatic Shutdown/Resumption Time: SDR-ICS-43 gradually increases the time span between automatic shutdown and resumption before it permanently shuts itself down
- Versatility and Usability: SDR-ICS-43 gives total control to the user. Most of the control parameters, e.g., gain, output power, alarm threshold, etc. can be changed using the Web-GUI so that the user can adjust the system perfectly to the given RF environment
- Web-GUI connectivity via DHCP
- Supports DHCP; No 3rd party GUI software required
- Automated installation
- Remote update support

1.2 Parts List

Table 1-1 Parts List

Label	Quantity	Description
SDR-ICS-43		
A	1	SDR-ICS-43
B	1	Wall Mount Bracket
C	1	Mounting Bracket Template
D	1	AC Power Cable
E	1	Ethernet Cable (Crossover)
F	6	Anchor Bolt
G	1	Ground Cable
H	1	Documentation CD*
Optional SDR-ICS-43 Modem Package		
I	1	Modem
J	1	Modem Connection Cable
K	1	19inch Chassis
L	1	Ethernet Cable (Crossover)

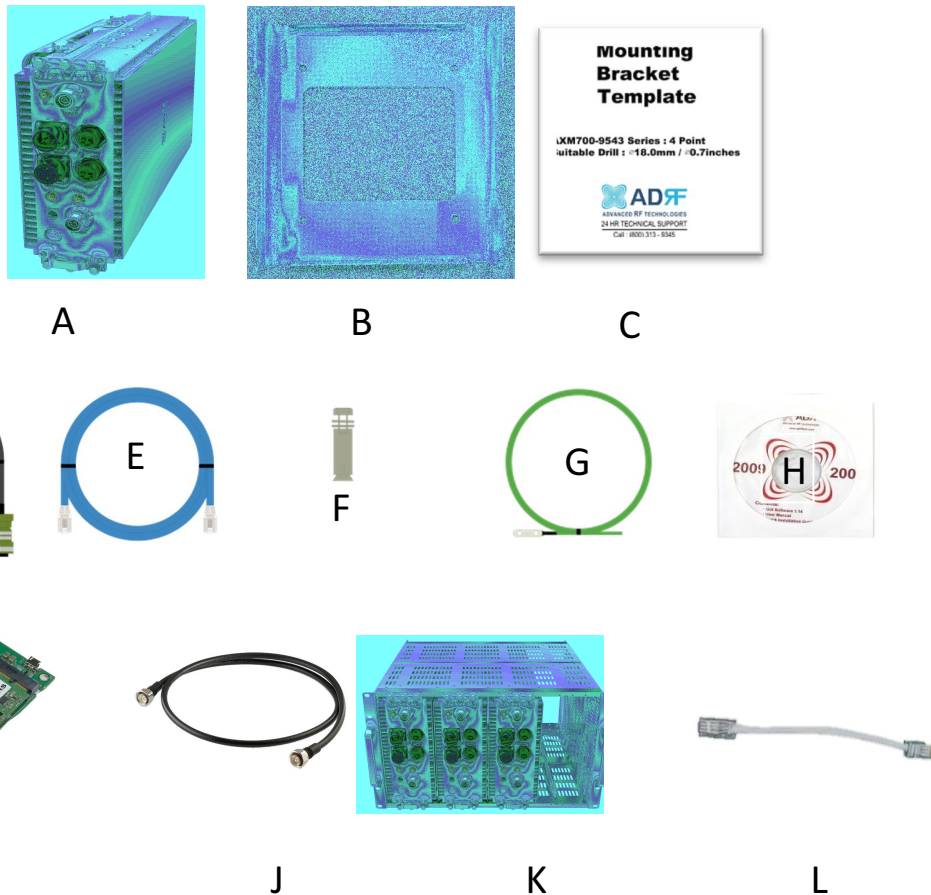
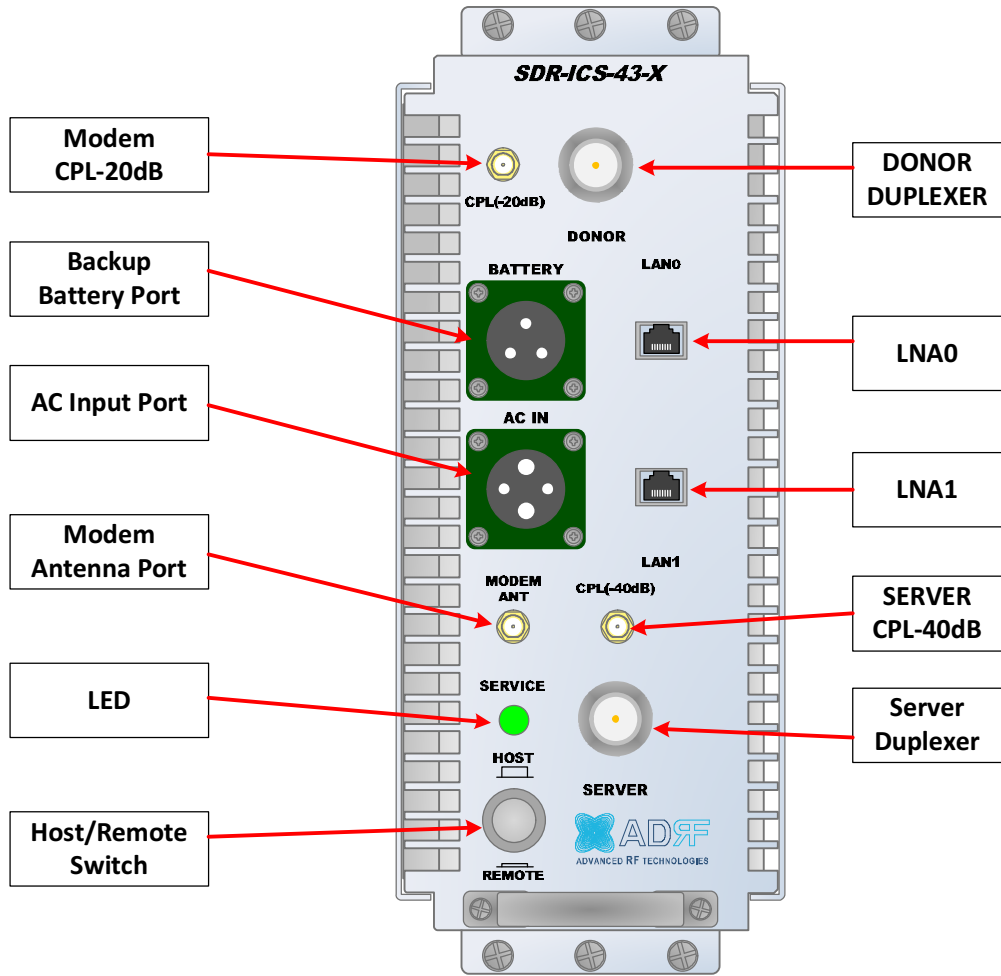

Figure 1-1 SDR-ICS-43 Repeater Parts List

* CD includes: User Manual, Quick-Start Guide, and Troubleshooting Guide

1.3 Repeater Quick View



1.4 Warnings and Hazards



WARNING! ELECTRIC SHOCK

Opening the SDR-ICS-43 could result in electric shock and may cause severe injury.



WARNING! EXPOSURE TO RF

Working with the repeater while in operation, may expose the technician to RF electromagnetic fields that exceed FCC rules for human exposure. Visit the FCC website at www.fcc.gov/oet/rfsafety to learn more about the effects of exposure to RF electromagnetic fields.

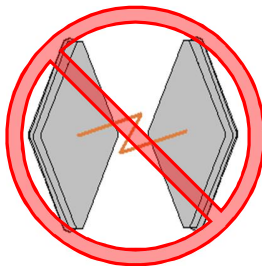

WARNING! DAMAGE TO REPEATER

Operating the SDR-ICS-43 with antennas in very close proximity facing each other could lead to severe damage to the repeater.

RF EXPOSURE & ANTENNA PLACEMENT Guidelines

Actual separation distance is determined upon gain of antenna used.

Please maintain a minimum safe distance of at least 211.3 cm while operating near the donor and the server antennas. Also, the donor antenna needs to be mounted outdoors on a permanent structure.

WARRANTY

Opening or tampering the SDR-ICS-43 will void all warranties.

Lithium Battery: CAUTION. RISK OF EXPLOSION IF BATTERY IS REPLACED BY INCORRECT TYPE. DISPOSE OF USED BATTERIES ACCORDING TO INSTRUCTIONS.

Ethernet Instructions: This equipment is for indoor use only. All cabling should be limited to inside the building.

FCC Part 15 Class A

NOTE: This equipment has been tested and found to comply with the limits for a Class A digital device, pursuant to part 15 of the FCC Rules. These limits are designed to provide reasonable protection against harmful interference when the equipment is operated in a commercial environment. This equipment generates, uses, and can radiate radio frequency energy and, if not installed and used in accordance with the instruction manual, may cause harmful interference to radio communications. Operation of this equipment in a residential area is likely to cause harmful interference in which case the user will be required to correct the interference at their own expense.

CAUTION

Double Pole/Neutral Fusing.

CAUTION

Circuit Breaker Installation in the Box for Overcurrent Protection

Must install the circuit breaker between the system and main AC source for separation.

Make sure to install the circuit breaker on the place to operate easily.

Circuit breaker is able to operate up to 20A.

◆ LABEL WARNING ◆

WARNING.

This is NOT a CONSUMER device. It is designed for installation by FCC LICENSEES and QUALIFIED INSTALLERS. You MUST have an FCC LICENSE or express consent of an FCC Licensee to operate this device. Unauthorized use may result in significant forfeiture penalties, including penalties in excess of \$100,000 for each continuing violation.

Regulatory Warning Statement

FCC RF Radiation Exposure Statement:

This equipment complies with FCC RF radiation exposure limits set forth for an uncontrolled environment. This equipment should be installed and operated with a minimum distance of **410** cm between the radiator and your body. This transmitter must not be co-located or operating in conjunction with any other antenna or transmitter.

RSS-102 RF Exposure

*L'antenne (ou les antennes) doit être installée de façon à maintenir à tout instant une distance minimum de au moins **410** cm entre la source de radiation (l'antenne) et toute personne physique. Cet appareil ne doit pas être installé ou utilisé en conjonction avec une autre antenne ou émetteur.*

Power Reduction Warning Statement

This 3.5dB back off is only required when multiple carriers are present in the pass-band.

WARNING! Hot surface



RSS-131 Warning Statement

The passband gain shall not exceed the nominal gain by more than 1.0 dB. The 20 dB bandwidth shall not exceed the nominal bandwidth that is stated by the manufacturer. Outside of the 20 dB bandwidth, the gain shall not exceed the gain at the 20 dB point.

2. OVERVIEW

2.1 LED

SDR-ICS-43 has an LED in the Lower left corner as shown in figure below.

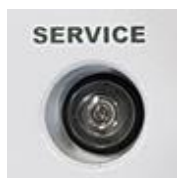

Figure 2-1 LED

Table 2-1 RF Module LED Specifications

LED Indicator		Specifications
Service	Green	System is Normal
	Orange	Soft Fail
	Red	Hard Fail

2.2 Host/Remote Switch



Figure 2-2 Host/Remote Switch

The Host/Remote Switch allows the user to switch the default Repeater IP, Subnet Mask, and Gateway of the LOCAL port of the repeater to an alternative setup. These settings can be adjusted by logging into the repeater in HOST mode and configuring the settings under the Modem Box Setting section on the Install Page(section 오류! 참조 원본을 찾을 수 없습니다.).

Once the settings are set, Push the switch to the REMOTE position will reboot the repeater with the new alternate settings. *Please note that when the repeater is set to the REMOTE position, DHCP is disabled and the repeater will not automatically assign an IP address to any device that connects directly to the repeater.*

- Host IP: 192.168.63.1 (Fixed IP, unable to modify this IP address)
- Remote IP: 192.168.63.5 (Default IP, but can be modified in Host mode)

2.3 Ethernet Port



Figure 2-3 Ethernet Port

- **LAN0** – The Local port can be used to communicate directly with the SDR-ICS-43 using a RJ-45 crossover cable or can also be used to connect the SDR-ICS-43 to an external modem box or the optional internal Digi Transport WR-21.
- **LAN0** and **LAN1** support cascade communication for modem and Web-GUI

2.3.1 AC Power



Figure 2-3 AC Input Port

The SDR-ICS-43 PSU can operate at 110V AC to 220V AC. The user should verify that the AC input voltage is the correct voltage before powering on the SDR-ICS-43.

2.3.2 Back Up Battery Port



Figure 2-4 Battery Backup Port

The SDR-ICS-43 can be connected to an ADRF-BBU (ADRF Battery Backup) to provide power during a power failure. If an ADRF-BBU is utilized, connect the ADRF-BBU to the SDR-ICS-43 via the external battery port.

(WARNING: The circuit switch on the ADRF-BBU must be set to OFF before connecting the ADRF-BBU to the SDR-ICS-43 to prevent damage to the repeater or the ADRF-BBU and personal injury.)

Note: Please contact ADRF Technical Support for assistance if you are unfamiliar with the installation procedure of our battery box.

2.4 RF Ports

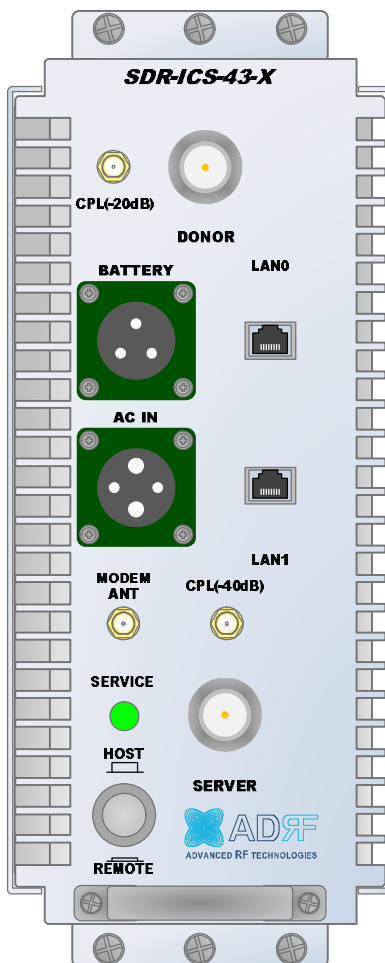

Figure 2-5 RF port

- **DONOR** – 4.3-10 female which is used to connect the donor antenna
- **DONOR_Modem CPL (20dB)** – SMA female 20 dB coupling port which is used to Modem
- **MODEM_ANT** – SMA female port which is used to provide RF signal to the optional external modem box or connect the **DONOR_CPL** port.
- **SERVER_CPL (30dB)** – SMA female 30 dB coupling port which is used to monitor the amplified DL signal
- **SERVER** – 4.3-10 female which is used to connect the server antenna

3. ALARMS

3.1 Message Board Alarms and Notification

Table 3-1 Message Board Alarms and Notification

Parameters	Remark
AC Fail	Power supply is not operating within specs
DC Fail	Power supply is not operating within specs
Fan[1/2] Fail	System has detected an issue with the fan1 and fan2
Temperature	Module is above the normal operating temperature
Current	Power supply is not operating within specs
System Halt	System is in a shutdown state due to a hard fail alarm
DSP Fault	System has detected an issue with the internal DSP chip
OSC	Oscillation detected
DL Signal not detected	DL signal is below the specified level
DL Signal Low	DL signal is below the specified level
Input Overload	Incoming in-band DL or UL signal is too strong
Out of band Overload	Incoming out-band DL or UL signal is too strong
Synthesizer Lock Fail	Issue with internal PLL
DL RF Power	Input + gain does not match the output level (above delta of 6 dB)
Overpower	Output level is above the max output levels
VSWR	Power is being reflected back to the repeater
Heartbeat	Heartbeat
Reboot	Reboot
Factory setting	Factory setting
Sync Fail(SDR-ICS-43-BT only)	Sync Signal Not Detect, Sync Fail

3.2 Alarms

Table 3-2 Alarms Threshold

Parameters	Remark
AC Fail	Power supply is not operating within specs. (4 seconds)
DC Fail	Power supply is not operating within specs. (4 seconds)
Fan1, Fan2 Fail	System has detected an issue with each fan. (4 seconds)
Temperature	Module is above the normal operating temperature. (4 seconds) Over Temperature [Soft fail: 80~87 C, Hard fail: Above 87 C]
Current	Power supply is not operating within specs. (4 Second) Over Current [Hard fail: Above 20A]
System Halt	System is in a shutdown state due to a hard fail alarm. (10 times)
DSP Fault	System has detected an issue with the internal DSP chip. (Cannot communication with DSP)
OSC	Oscillation detected. Alarm is only present when one-time oscillation check is performed.
DL Signal not detected	DL signal is below the specified level. (default: -90dBm, 4 seconds)
DL Signal Low	DL signal is below the specified level. (default: -85dBm, 4 seconds)
Input Overload	Input signal is above the threshold. (4 seconds) (Soft fail: DL -10dBm/UL -12dBm, Hard fail: DL -8dBm/UL -10dBm)
Out of band Overload	Out of band signal is above the threshold. (4 seconds) (Soft fail: DL -10dBm/UL -12dBm, Hard fail: DL -8dBm/UL -10dBm)
Synthesizer Lock Fail	Issue with internal PLL(4 seconds)
DL RF Power	Input + gain does not match the output level (default delta of 6 dB)
Overpower	Output level is above the max output levels AGC On case(Soft: AGC Level+ 1~2dB, Hard: AGC Level + >2dB) AGC Off case(Soft: max output level+ 1~2dB, Hard: max output level + >2dB)
VSWR	Power is being reflected back to the repeater. Threshold = output power - 8dB. For example, if the repeater is outputting 24dBm, then if the system detects 16dBm of return power, then the VSWR will be triggered.(Triggered in case of over +15dBm output power)
Sync(SDR-ICS-43-BT only)	Sync alarm set : Sync Fail Sync alarm clear : Sync

4. INSTALLATION

4.1 Installation Procedures

4.1.1 Wall Mount Procedure

- Verify that the SDR-ICS-43 and mounting hole are in good condition
- Place the SDR-ICS-43 mounting template up against the wall and mark of mount holes
- Mount the SDR-ICS-43 to wall use the six (6) mounting hole on the wall mount bracket
- Connect the GND cable
- Connect the Antenna cable
- Connect the Power cable

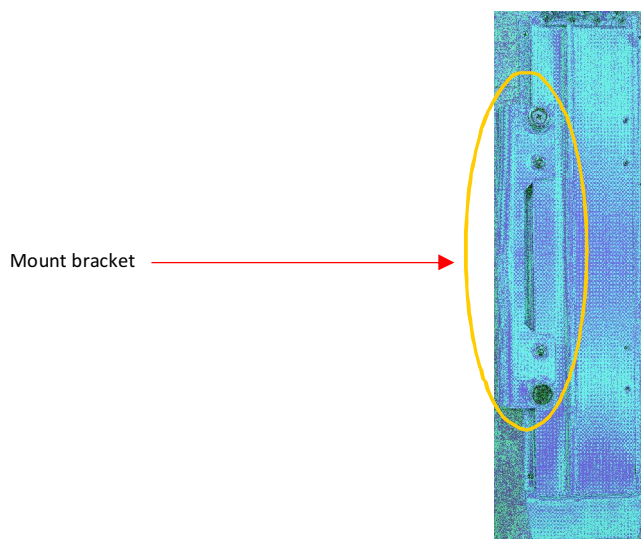

Figure 4-1 SDR-ICS-43 Wall Mount

4.2 Grounding

- Install the ground cable that is included in the package at the side of the repeater as show in the figure below.
- The grounding terminal is located at lower right-hand side of the BDA. The grounding cable should be properly connected before powering on the equipment.



Figure 4-2 Ground Cable Connection

- Ground terminals located on the side consisted of a 16mm²(6AWG) and should be permanently connected to earth(Protective earthing conductor).

4.3 Antenna Separation/Isolation

Separation between the antennas is necessary to prevent oscillation. Oscillation occurs when the signal entering the system continually reenters, due to the lack of separation between the donor and server antennas. In other words, the signal is being fed back into the system. This creates a constant amplification of the same signal. As a result, the noise level rises above the signal level.

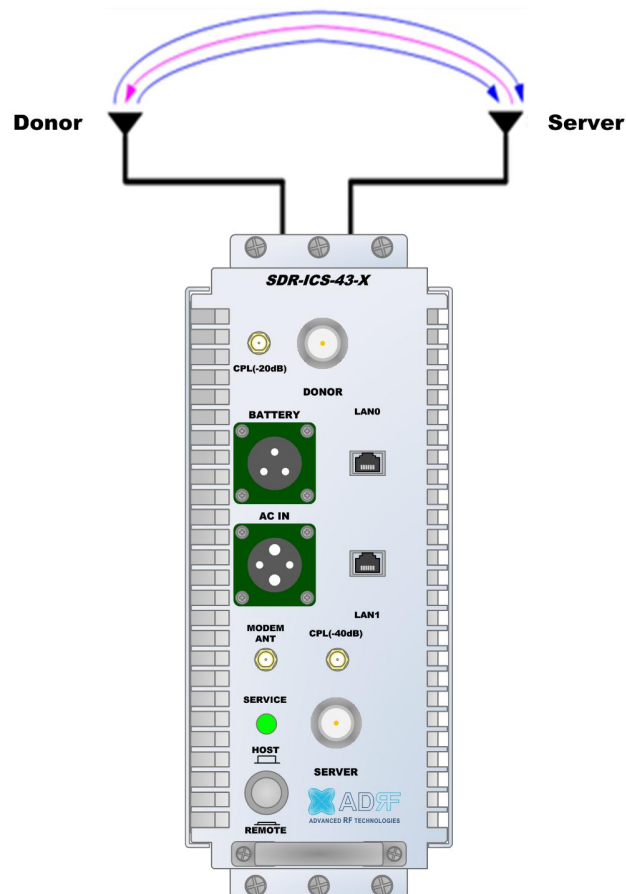

Figure 4-3 RF Repeater Oscillation

To prevent feedback, the donor and server antennas must be separated by an appropriate distance to provide sufficient isolation. Isolation is attained by separating antennas a sufficient distance so that the output of one antenna does not reach the input of the other. This distance is dependent on the gain of the repeater.

With ICS enabled, the recommended isolation value is 5dB greater than the maximum gain of the repeater. For example, if the gain of the repeater is 50 dB, then an isolation of 55dB or greater is required. In the same manner, because the SDR-ICS-43 has a maximum gain of 95dB in case of SDR-ICS-43, it requires isolation of at least 100dB.

With ICS disabled, the recommended isolation value is 20dB greater than the maximum gain of the repeater. For example, if the gain of the repeater is 50 dB, then an isolation of 70dB or greater is required. In the same manner, because the SDR-ICS-43 has a maximum gain of 95dB in case of SDR-ICS-43, it requires isolation of at least 115dB.

WARNING: Inserting a CW signal into the SDR-ICS-43 when ICS is enabled will cause the system to generate a false alarm. The false alarm will cause the system to go into a shutdown state. If a CW signal needs to be injected into the repeater for testing purposes, the ICS routine must be turned off.

4.4 Line of Sight

The donor antenna which points towards the eNode-B typically has a narrow beam antenna pattern. As a result, a slight deviation away from the direction of the eNode-B can lead to less than optimum results. In addition, obstacles between the repeater and the eNode-B may impair the repeater from obtaining any eNode-B signal. As a result, the repeater cannot transmit signal to the coverage area. Therefore, a direct line of sight to the eNode-B for the donor antenna is vital to the function of a repeater. For the same reason, placing the server antenna in direct line of sight of the coverage area is also necessary.

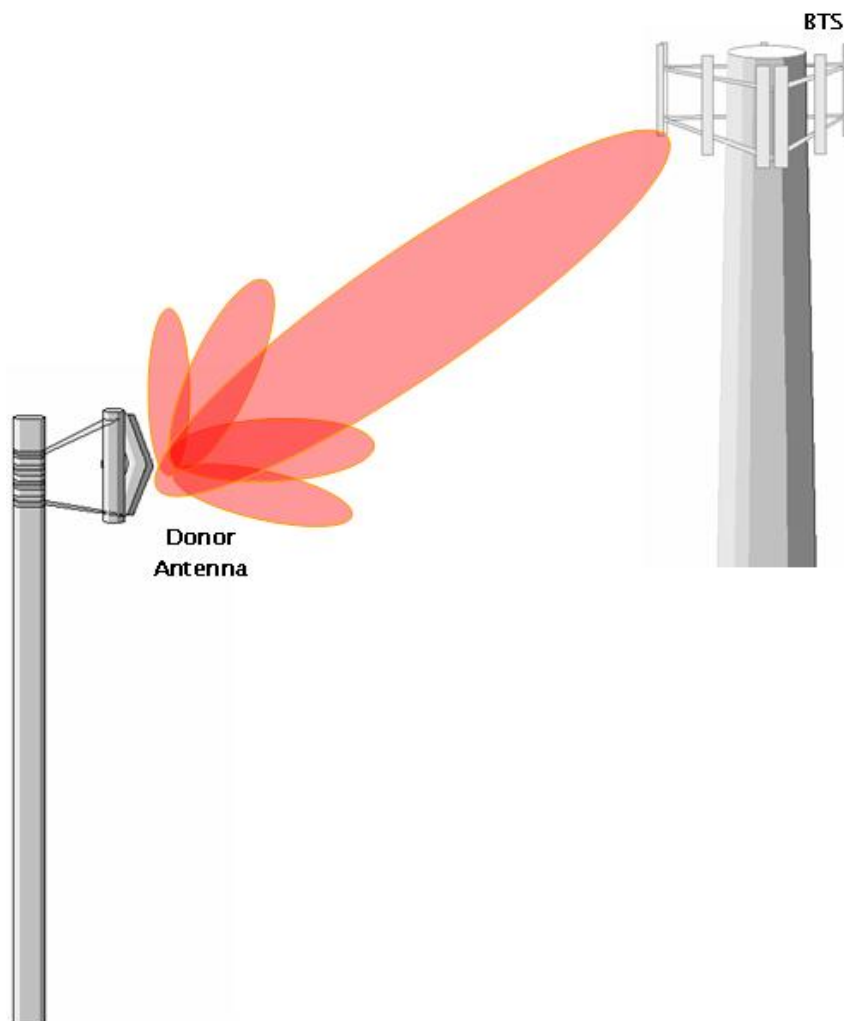

Figure 4-4 Line of Sight to the eNode-B(or BTS)

5. SDR-ICS-43 WEB-GUI SETUP

The Web-GUI allows the user to communicate with the repeater either locally or remotely. To connect to the repeater locally, you will need a laptop with an Ethernet port and a RJ-45 crossover cable. To connect to the repeater remotely, you will need to have an active internet connection and the repeater must have either an internal modem or an external modem box connected to the repeater.

5.1 Repeater/PC Connection Using Web-GUI

- Verify that your Local Area Connection is set to **Obtain an IP address automatically** under the Internet Protocol (TCP/IP) properties
 - If you are connecting to the unit remotely (use of a modem), then skip steps above.
- Connect the RJ-45 crossover cable between the laptop's Ethernet port and the repeater's Ethernet port
- Launch an Internet Browser
- Type the following IP address into the address bar of Microsoft Internet Explorer: <http://192.168.63.1>
 - If you are connecting to the unit remotely, then type the IP address of the modem to connect to the unit
- The following login screen will appear:

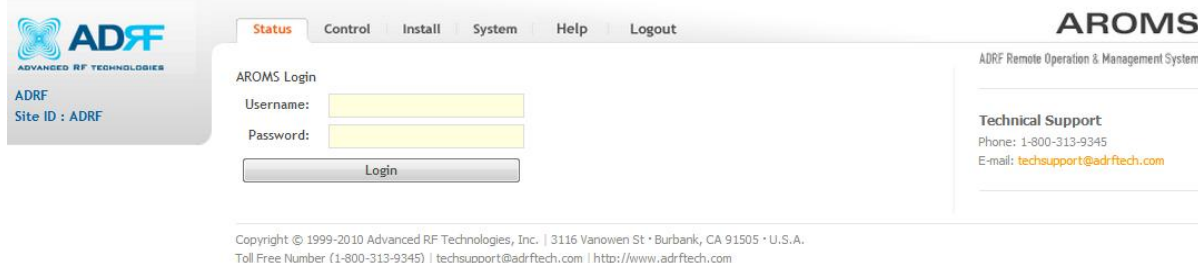

Figure 5-1 Login page

If you are not the Administrator, please type in your assigned username & password which you should have received from the Administrator.

The default username and password for the General User is **adrf** & **adrf**, respectively.

The default Administrator login is **admin** & **admin**, respectively.

5.2 Status Tab

The screenshot displays the ADRF Status Tab interface. At the top left, it shows the ADRF logo and site information: SDR-ICS-43-S8C, Site ID: ADRF. A green padlock icon and an 'Unlock System' button are visible. Below this are 'Expand All' and 'Collapse All' links, and a progress bar for '43-S8C'. The main content area is divided into several sections:

- S8C Band:** A table showing bandwidth, downlink, and uplink frequencies.
- Power & Gain:** A table showing various power and gain metrics for downlink and uplink.
- Message Board:** A scrollable log of system events and alarms.
- Alarm:** A section with tabs for System, RF Alarm, and Power Alarm, displaying active alarms like 'Over Temperature', 'Fan Fail #1', 'System Halt', and 'Out of Sync'.
- Information:** A table with fields for Serial Number, Latitude, Longitude, Firmware, and Web GUI.
- Location Description:** A section for location details.
- Technical Support:** Contact information including phone and email.
- Installer Contact Info:** Fields for company, installer, phone, and email.
- Modem Status:** Icons for 'Not Installed', 'Power', and 'Modem Disabled'.
- Uptime/Scan Time:** 'Uptime : 34 days 21:04:29' and 'Scan Time : 0.1 sec'.

At the bottom, there is a legend for alarm types: Normal (green), Soft Fail (orange), Hard Fail (red), and Link Fail (grey).

Copyright 1999 Advanced RF Technologies, Inc. | 3116 Vanowen St • Burbank, CA 91505 • U.S.A.
Toll Free Number (1-800-313-9345) | techsupport@adrfttech.com | http://www.adrfttech.com

Figure 5-2 Status Tab

5.2.1 Band

S8C Band		
Bandwidth	Downlink	Uplink
20.00-L	872.000 MHz	827.000 MHz
10.00-L	889.000 MHz	844.000 MHz

Figure 5-3 Band Display

5.2.2 Power & Gain

This section displays the Input, Gain, and Output for both downlink and uplink.

Power & Gain

---		Downlink	Uplink
Outband [dBm]		---	---
Composite Input[dBm]		---	---
Gain[dB]	User Set	95.0	95.0
	ALC	95.0	95.0
	ILC	0.0	0.0
	Actual	95.0	95.0
Output[dBm]		---	---
Isolation [dB]		---	---

Figure 5-4 Power & Gain Display

- Input [dBm] – Displays the in-band Downlink/Uplink signal level. The system will display “--.” when the input level is < -90 dBm.
- Gain [dB]
 - User Set: Displays the amount of gain that user set.
 - ALC: Displays the amount of gain that is attenuated by ALC function.
 - ILC: Displays the amount of gain that is attenuated by ILC function.
 - Actual: Displays the actual amount of gain that is currently in use.
- Output [dB] – Displays the Downlink/Uplink output power levels. The system will display “--.” when the output level is < +5 dBm.
- Isolation [dB] – Displays the measured isolation value. The value inside of the parenthesis is the “actual gain - measured isolation value”. When the “actual gain – measured isolation value” is less than -15dB, then “MAX” will be displayed.

5.2.3 Alarm

This section displays the alarm status for System alarms, RF Alarms, and Power alarms. If an alarm is present in the system, then the color of the alarm tab will change according to the type of failure.

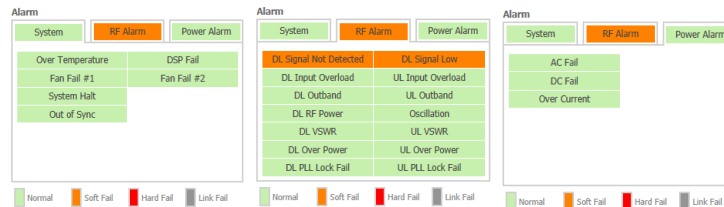

Figure 5-5 Alarm Display

5.2.4 Message Board

Displays the 30 most recent events.

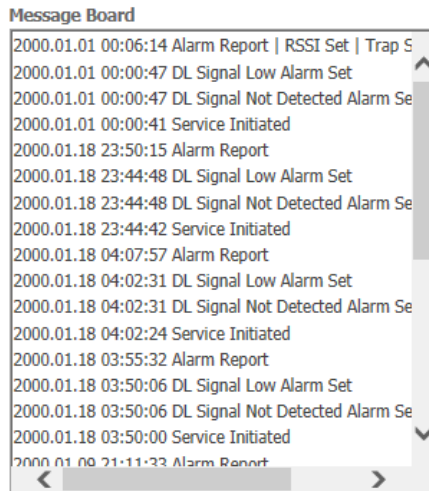

Figure 5-6 Message Board

- **Log File:** Downloads the system Log File (events and alarms) to your computer

5.2.5 Install, Power and modem Status



Figure 5-7 Install, Power and modem Status

- **Installation:** Displays whether or not the installation routine has been run (Not Installed or Installed)
- **Power:** Displays the power source that is currently being used
- **Modem:** Display the modem is not-exist, connected or not-connected.

5.2.6 Repeater Info / Repeater Location / Technical Support / Installer Contact Info

ADRF Remote Operation & Management System

Information

Serial Number	SAMPLE
Latitude	N034.142570
Longitude	W118.223190
Firmware	81005201AF0060
Web GUI	x1.0.16

Location
Description

Technical Support
Phone: 1-800-313-9345
E-mail: techsupport@adrftech.com

Installer Contact Info
Company:
Installer:
Phone:
E-mail:

Figure 5-8 Repeater Info / Repeater Location / Technical Support / Installer Contact Info

- **Repeater Info:** Displays the serial number, latitude, longitude, firmware version, Web-GUI version
- **Repeater Location:** Displays the address where the repeater is installed
- **Technical Support:** Displays ADRF’s Technical Support contact information
- **Installer Contact Info:** Displays the installer’s name, phone and e-mail address

Note: Once successfully logged in, the repeater model name and the site/cascade ID will be displayed on the top of all the windows (except for the Main Window).

5.3 Control Tab

The screenshot displays the ADRF Control Tab interface. At the top, there are navigation tabs: Status, Control (selected), Install, System, Help, and Logout. The main content area is divided into several panels:

- General Setting:** Contains checkboxes for ICS ON, DL HPA ON, ILC ON, and UL HPA ON, with an Apply button.
- Gain Setting:** Contains a checked checkbox for Gain Balance ON and dropdown menus for DL Gain [dB] (95.0), UL Gain [dB] (95.0), DL ALC Level [dBm] (43.0), UL ALC Level [dBm] (30.0), and DL ALC Offset [dB] (7.0), with an Apply button.
- System:** Contains Reboot and Factory Settings buttons.
- SNMP Trap:** Contains a checked checkbox for SNMP Trap, a dropdown for Heartbeat Interval [min] (20.0), and a section for Last heartbeat sent out with two timestamps (02/04/2000 21:02:50 and 02/04/2000 20:42:50), with an Apply button.
- Alarm Report Time:** Contains dropdown menus for Over Current [Min] (5.0), Over Temperature [Min] (5.0), VSWR [dBm] (5.0), RSSI at Donor (5.0), and RF Power (5.0), with an Apply button.
- Alarm Setting:** Contains a checked checkbox for VSWR ON and dropdown menus for DL Signal Low [dBm] (-85.0), DL Signal Not Detected [dBm] (-90.0), and DL RF Power [dB] (6.0), with an Apply button.
- ICS Control:** Contains a dropdown for DL ILC Level (-5.0) and an Apply button.

On the right side, there is a 'User Log' section with a list of user actions and their timestamps.

Copyright 1999 Advanced RF Technologies, Inc. | 3116 Vanowen St - Burbank, CA 91505 - U.S.A.
 Toll Free Number (1-800-313-9345) | techsupport@adrftech.com | http://www.adrftech.com

Figure 5-9 Control page

5.3.1 General Setting

This is a close-up view of the General Setting panel. It features four checkboxes arranged in a 2x2 grid: ICS ON, DL HPA ON, ILC ON, and UL HPA ON. All checkboxes are currently checked. An 'Apply' button is located at the bottom right of the panel.

Figure 5-10 General Setting

- **ICS ON:** Enables or disables the Interference Cancellation System (ICS)
- **ILC ON:** Enables or disables the Interference Level Control (ILC)
- **Downlink HPA ON:** Enables or disables the DL HPA (High Power Amplifier)
- **Uplink HPA ON:** Enables or disabled the UL HPA (High Power Amplifier)

To enable any of the settings, click on the checkbox and click the Apply button.

WARNING: Inserting a CW signal into the SDR-ICS-43 when ICS is enabled will cause the system to generate a false alarm. The false alarm will cause the system to go into a shutdown state. If a CW signal needs to be injected into the repeater for testing purposes, the ICS routine must be turned off.

5.3.2 System

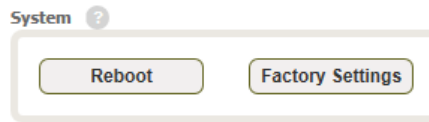

Figure 5-11 System

- **Reboot:** Clicking the reboot button will have the following popup show up:

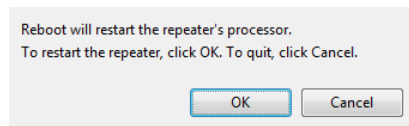

Figure 5-12 Pop-up message when Reboot button is pressed

Click OK to reboot the repeater or click Cancel to exit out

- **Factory Setting:** Resets the repeater to the original factory settings

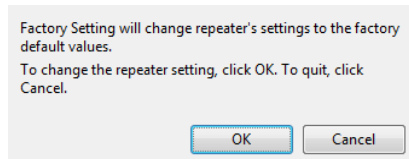

Figure 5-13 Pop-up message when Factory Setting button is pressed

5.3.3 SNMP Trap

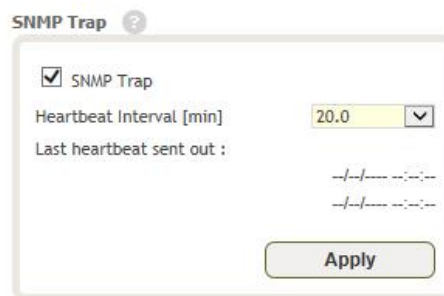

Figure 5-14 SNMP Trap

- **SNMP Trap ON** – Enables or Disables SNMP traps from being sent out when an alarm is triggered.
- **Heartbeat Periodic Time [min]** – Specifies the amount time between heartbeats

5.3.4 Gain Control

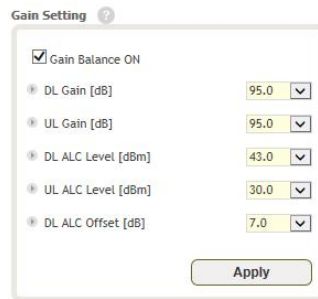

Figure 5-15 Gain Control Setting

- **Downlink Gain/Uplink Gain:** Allows the UL gain to be adjusted manually when ALC is OFF
- **DL Output ALC Level:** Prevents the output power from exceeding the specified value
- **DL Output ALC Offset:** When the incoming signal level increases, the system will not adjust the attenuation levels until the delta reaches the level specified
- **DL /UL Gain Balance ON:** Allows the user to enable or disable the gain balance. When gain balance is enabled, the delta value between the downlink and uplink gains remain constant

5.3.5 ICS Control

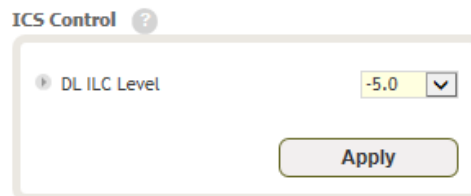

Figure 5-16 ICS Control Setting

- **DL ILC Level:** Allows the user to specify the interference level control. The measured isolation value + ILC Level will provide you with the MAX gain level. When the ILC Level + User Set Gain Level is larger than the measured isolation value, ILC will adjust the gains levels to match the measure isolation value.

5.3.6 Alarm Setting

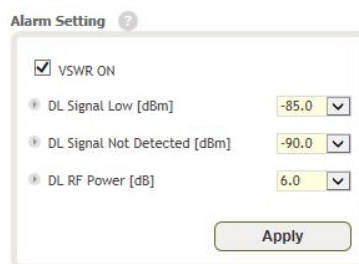

Figure 5-17 Alarm Threshold Setting

- **Downlink Signal Low:** Allows the user to specify how low the signal can be before triggering a “Downlink Signal Low” soft-fail alarm
- **Downlink Signal Not Detected:** Allows the user to specify how low the signal can be before triggering a “Downlink Signal Not Detected” soft-fail alarm
- **Downlink RF Power:** Allows the user to set a maximum deviation value for the downlink RF power
 - For example, if the input signal is -50 dBm and the gain is set to 60 dB, the expected output power should be 10 dBm. If the Downlink RF Power alarm value is set to 6dB, then if the output power is below 4 dBm, then this will trigger a soft-fail alarm

- **VSWR ON:** Allows the user to enable/disable the VSWR alarm check

5.4 Install Tab

5.4.1 Install

Band Selection

Channel 1: 862 MHz - 894 MHz
Channel 2: 817 MHz - 849 MHz

Channel	Frequency (MHz)	Bandwidth (MHz)	Set	Downlink Frequency (MHz)		
				Start	Center	End
Channel 1	872.000	20.00-L	set	862.000	872.000	882.000
Channel 2	889.000	10.00-L	set	884.000	889.000	894.000

Custom Bandwidth Setting

ID	Bandwidth (MHz)	Description
<input type="checkbox"/> C1	5.000000	sample 5MHz
<input type="checkbox"/> C2	10.000000	sample 10MHz
<input type="checkbox"/> C3	15.000000	sample 15MHz
<input type="checkbox"/> C4	20.000000	sample 20MHz

Band Equalization

Channel	Reference	Equalization	DL Band Input	Filter Gain	DL Band Output
Channel 1	<input checked="" type="radio"/>	<input checked="" type="checkbox"/> Autose	-122.1	0.0	-122.1
Channel 2	<input type="radio"/>	<input checked="" type="checkbox"/> Autose	-137.5	0.0	-137.5

SNMP

Site ID: ADRF
Description:
Manager IP: 192.168.100.56

Remote Ethernet Settings (LAN 0)

Use the following IP address
 Obtain an IP address automatically

IP Address: 192.168.70.81
Subnet Mask: 255.255.255.0
Gateway: 192.168.70.254

Ethernet Settings (LAN 1)

Obtain an IP address automatically
 Use the following IP address

DHCPD
IP Address: 192.168.71.1
Subnet Mask: 255.255.255.0

Location

Latitude: N +034 142570
Longitude: W +118 223190

Auto Installation

Progress:
Apply

User Log

ADRF Remote Operation & Management System

Figure 5-18 Install page

5.4.2 SNMP

The image shows a web-based configuration form for SNMP. It has a title 'SNMP' with a help icon. There are three input fields: 'Site ID' containing 'ADRF', 'Description' which is empty, and 'Manager IP' containing '192.168.100.56'. Below the fields is an 'Apply' button.

Figure 5-19 SNMP

The SNMP section allows you to specify the Site ID, Description and Manager IP. The Site-ID is the code that is used to identify a particular module. The Description is separate field for user. The Manager IP field is where the user inputs the IP address of the NOC system that is being used to monitor the SNMP traps.

5.4.3 Location

This section allows the user to input the latitude and the longitude of the repeater.

The image shows a web-based configuration form for Location. It has a title 'Location' with a help icon. There are two rows of input fields. The first row is for Latitude, with a dropdown set to 'N', a field containing '+034', and a field containing '142570'. The second row is for Longitude, with a dropdown set to 'W', a field containing '+118', and a field containing '223190'. Below the fields is an 'Apply' button.

Figure 5-20 Location Setting

5.4.4 Remote Ethernet Settings

This section allows the user to specify an alternative Repeater IP, Subnet Mask, and Gateway settings. These settings are enabled when the Host/Remote switch is set to the Remote position.

Remote Ethernet Settings (LAN 0) ?

Use the following IP address
 Obtain an IP address automatically

IP Address: 192.168.70.81
 Subnet Mask: 255.255.255.0
 Gateway: 192.168.70.254

Apply

Ethernet Settings (LAN 1) ?

Obtain an IP address automatically
 Use the following IP address
 DHCPD

IP Address: 192.168.71.1
 Subnet Mask: 255.255.255.0

Apply

Figure 5-21 Remote Ethernet Settings

5.4.5 Auto Installation

Auto Installation ?

Progress :

Apply

Figure 5-22 Auto Installation

The Auto Installation routine can be run by clicking on the Install button. The Auto Installation routine runs basic system checks to ensure proper functionality.

Repeater Location Info / Repeater Installer Info

This section allows the user to specify the address of the repeater and also the information of the installer.

Location Info

Company

Address1

Address2

City

State ▼

ZIP Code

Installer Info

Company

Name

Phone

E-mail

Date & Time

Date

Time ▼ ▼ ▼

Figure 5-23 Repeater Location Info / Repeater Installer Info

5.4.6 Date & Time

This section allows the user to specify the current date and time.

Date & Time

Date

Time ▼ ▼ ▼

Figure 5-24 Date & Time Setting

5.4.7 Band Selection

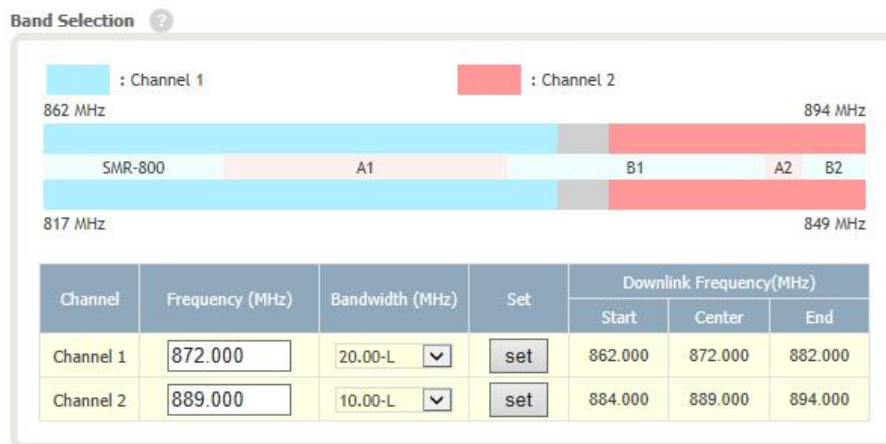

Figure 5-25 Band Selection

Band selection allows the user specify the desired frequencies.

5.5 System

The System tab allows the user to perform firmware updates, upload closeout packages, view any changes to the system, backup existing configuration, and add/remove user accounts, and change the login credentials of the Administrator.

5.5.1 System: Account

5.5.1.1 System: Account- Account Management

The Account Management section allows the Administrator to delete any user account. Please note that the Account Management section is only available if you are logged into the system as the Administrator. To delete a user account click on the Account Management link and under the Delete column, click on the delete button.

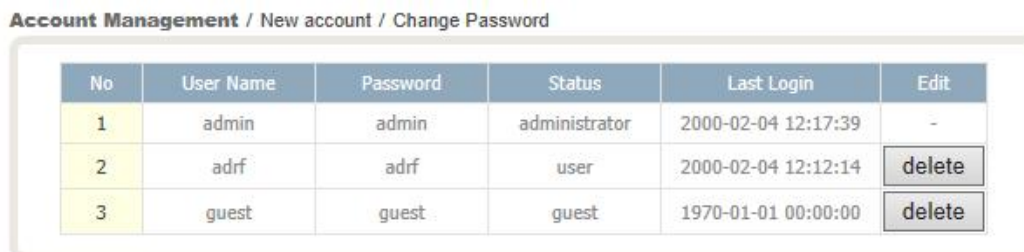

Figure 5-26 System: Account- Account Management

5.5.1.2 System: Account- New Account

The New account section allows the Administrator to create a new user account. Please note that the New account section is only available if you are logged into the system as the Administrator. To create a new user account click on the new account link and fill in the fields highlighted in yellow as shown below.

Account Management / **New account** / Change Password

User Name	<input type="text"/>
User Group	user <input type="button" value="v"/>
Password	<input type="text"/>
Confirm password	<input type="text"/>

Figure 5-27 System: Account- New Account

5.5.1.3 System: Account- Change Password

The Change Password section allows the current user who is logged into the system to change their login credentials.

Account Management / New account / **Change Password**

User Name	admin
New User Name	<input type="text" value="admin"/>
Confirm New User Name	<input type="text" value="admin"/>
Password	<input type="text"/>
Confirm password	<input type="text"/>

Please enter new password.

Figure 5-28 System: Account- Change Password

5.5.2 System- Closeout Package

The closeout package section will allow the user to upload documents to the module. The maximum file size for each upload is limited to 10 MB. The total amount of space available for uploading document is 100 MB. Please do not use this section as the primary storage location of your documents. Documents may become unavailable if the system goes down.

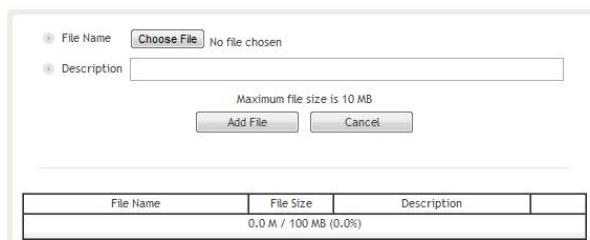

Figure 5-29 System- Closeout Package

To upload documents to the module, click on the “Choose File” or “Browse” button and locate the file that you would like to upload, then enter in a Description of the file being uploaded. Afterwards, click on the “Add File” button to upload the file. Below is what you will see after the file upload. To delete the file, click on the delete button located in the last column.

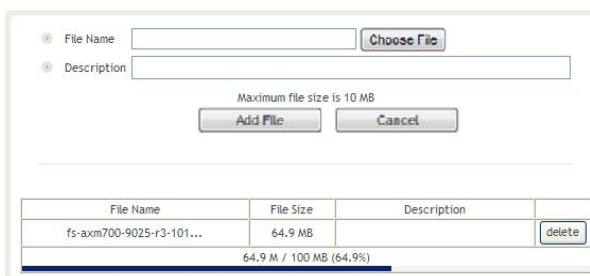

Figure 5-30 System- Closeout Package after the file upload

5.5.3 System- User Log

This section displays system events that have taken place. The User Log displays who has made the changes, the time and date of when the event took place, and what changes were made to the system.

Event Log / User Log

Seq.	Date / Time	Source	Description	Username	Log Message
1	2000.02.04 21:07:32	SDR-ICS-43-S8C		adrf	User System Reset
2	2000.02.04 21:04:30	SDR-ICS-43-S8C		adrf	User System Site ID Set ADRF
3	2000.02.04 21:04:30	SDR-ICS-43-S8C		adrf	User System Description Set
4	2000.02.04 21:04:07	SDR-ICS-43-S8C		adrf	User System Description Set
5	2000.02.04 21:04:01	SDR-ICS-43-S8C		adrf	User System Description Set
6	2000.02.04 21:03:49	SDR-ICS-43-S8C	TEST	adrf	Installer(Email) Set
7	2000.02.04 21:03:49	SDR-ICS-43-S8C	TEST	adrf	Installer(Email) Set

Figure 5-31 System – User Log

5.5.4 System: Update

- To perform a firmware update, click on the System tab and the following screen will appear.

Update Main Device

Update File Upload

File List

U-UPDATE-SDR-TEST-AF0060_x1.0.16.dat

U-UPDATE-SDR-TEST-AF005F_x1.0.16.dat

Check the available boxes below to select the device to be firmware updated.
Click the UPDATE button at the bottom of this section to begin the firmware update process.

	Description	Current	Filename	Progress	Comment
<input type="checkbox"/>	43-S8C	81005201AF0060	-	-	-

Update Slave Devices

Check the available boxes below to select the device to be firmware updated.
Click the UPDATE button at the bottom of this section to begin the firmware update process.

	Description	Current	Available	Progress	Comment	
<input type="checkbox"/>	43-S8C	81005201AF0060	-	-	-	
<input type="checkbox"/>	APD	APD Device	APD-1.4.03	APD-1.4.03	-	Not Needed
<input type="checkbox"/>	FPGA-NoneICS	FW for NoneICS	-	FPGA-NoneICS-20170707	-	Not Activated
<input type="checkbox"/>	FPGA-ICS	FW for ICS	FPGA-ICS-120004	-	-	Update N/A

Figure 5-32 System – Update

- Update File Upload
 - Click on the Browse... button and locate the firmware file
 - Click on the Upload button to the firmware file upload.
 - Once the firmware upload is complete, File List will update.
- Update Main Device
 - Select update file on file list.
 - Check the boxes the device to be firmware updated.
 - Click Update button at Update Main Device section
- Update Slave Device
 - Check the available boxes to select the device to be firmware updated.
 - Click update button at Update Slave Devices section to begin the firmware update process.

5.5.5 System- Backup

The backup section allows the user to save the settings of the module.

Click the Save button to perform the backup. To restore the settings to your system, select the file and click the Restore button. To download the file, select it and click the download button. To delete a file, select it and click the Delete button.

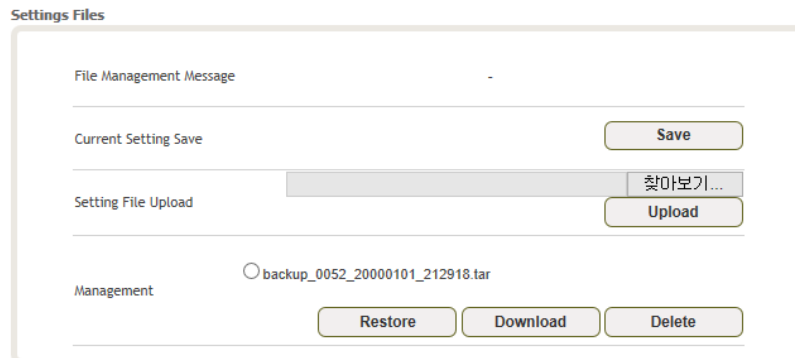

Figure 5-33 System Backup

5.6 Help

If an internet connection is available, clicking on the Help Tab will redirect the user to our Technical Support page.



Figure 5-34 Help

5.7 Logout

Clicking the Logout button will log the current user off the system.

6. MAINTENANCE GUIDE FOR SDR-ICS-43 REPEATER

6.1 Periodic Inspection Checklist

- Check for loose connections between the repeater and antennas. If connections are loose, make sure that all connections are tightly fastened properly.
- Cables and connectors are in good condition.
- Ensure that the repeater brackets are in good condition and that the repeater is securely fastened

6.2 Preventive Measures for Optimal Operation

6.2.1 Recommendations

- Perform the *Periodic Inspection Checklist* quarterly or semi-annually.

6.2.2 Precautions

- Do not operate the repeater with the antennas in extremely close proximity to one another as this may cause damage to the repeater.
- Do not change the parameters unless instructed to do so by an authorized supervisor.
- Do not move the repeater unless instructed to do so by an authorized supervisor.
- Do not detach any cables to the repeater unless repair of respective components is necessary.

7. WARRANTY AND REPAIR POLICY

7.1 General Warranty

The SDR-ICS-43 carries a Standard Warranty period of two (2) years unless indicated otherwise on the package or in the acknowledgment of the purchase order.

7.2 Limitations of Warranty

Your exclusive remedy for any defective product is limited to the repair or replacement of the defective product. Advanced RF Technologies, Inc. may elect which remedy or combination of remedies to provide in its sole discretion. Advanced RF Technologies, Inc. shall have a reasonable time after determining that a defective product exists to repair or replace the problem unit. Advanced RF Technologies, Inc. warranty applies to repaired or replaced products for the balance of the applicable period of the original warranty or ninety days from the date of shipment of a repaired or replaced product, whichever is longer.

7.3 Limitation of Damages

The liability for any defective product shall in no event exceed the purchase price for the defective product.

7.4 No Consequential Damages

Advanced RF Technologies, Inc. has no liability for general, consequential, incidental or special damages.

7.5 Additional Limitation on Warranty

Advanced RF Technologies, Inc. standard warranty does not cover products which have been received improperly packaged, altered, or physically damaged. For example, broken warranty seal, labels exhibiting tampering, physically abused enclosure, broken pins on connectors, any modifications made without Advanced RF Technologies, Inc. authorization, will void all warranty.

7.6 Return Material Authorization (RMA)

No product may be returned directly to Advanced RF Technologies, Inc. without first getting an approval from Advanced RF Technologies, Inc. If it is determined that the product may be defective, you will be given an RMA number and instructions in how to return the product. An unauthorized return, i.e., one for which an RMA number has not been issued, will be returned to you at your expense. Authorized returns are to be shipped to the address on the RMA in an approved shipping container. You will be given our courier information. It is suggested that the original box and packaging materials should be kept if an occasion arises where a defective product needs to be shipped back to Advanced RF Technologies, Inc. To request an RMA, please call (800) 313-9345 or send an email to techsupport@adrftech.com.

8. SPECIFICATIONS

8.1 Electrical Specifications

SDR-ICS-43_Sprint Specifications

Specifications		SDR-ICS-43-S8C	SDR-ICS-43-P	SDR-ICS-43-BT	Comments
Frequency	Downlink	862~894MHz	1930~1995MHz	2496~2690MHZ	
	Uplink	817~849MHz	1850~1915MHz	2496~2690MHZ	
Band Selection per Filter (ICS Mode)		LTE- 20 MHz	LTE- 20 MHz	TD-LTE- 20 MHz	
Band Selection per Filter (SDR Mode)		LTE- 20 MHz	LTE- 20 MHz	TD-LTE-20 MHz	
Simultaneous Filter Support	SDR	3			Mode selection
	ICS	2			
Gain Flatness	Full Band	±1.5dB		±2dB	
	Each Band	±1.5dB			
Gain	Range	55 ~ 95dB			
	Step	0.5dB			
	Tolerance	±1dB			
Frequency Error		±0.05ppm			
ALC Range		Max output power - 20dB			
Spurious Emissions		Meet 3GPP 36.106, 3GPP TS 36.141			
Out Band Spurious Emissions		-13dBm/1kHz; 9KHz<f<150KHz			
		-13dBm/10kHz; 150KHz<f<30MHz			
		-13dBm/100kHz; 30MHz<f<1GHz			
		-13dBm/1MHz; 1GHz<f<12.75GHz			
Composite Output Power		+43dBm/+30dBm			DL/UL
Required Minimum Isolation		Gain-15dB		Gain-10dB	Direct feedback signals
Roll Off		> 50dBc@ 1MHz Outside pass-band			
Noise Figure(UL)		≤ 5dB @ 95dB Gain ≤ 8dB @73dB Gain ≤ 12dB @ 65dB Gain			
Delay		< 7.2us		< 4.0us	
Sync Detection Level				≥ -85dBm	BRS Band
EVM		Meet 3GPP 36.106, 3GPP TS 36.141			
VSWR		1.5:1			
Remote Alarm / Network		Web-GUI, SNMP,SNMP-Traps			With Modem or Ethernet connection

SDR-ICS-43_Verizon Specifications

Specifications		SDR-ICS-43-7L	SDR-ICS-43-7U	SDR-ICS-43-S8C	SDR-ICS-43-P	SDR-ICS-43-A	Comments
Frequency	Downlink	728~746MHz z	746~757MHz z	862~894MHz z	1930~1995 MHz	2110~2155 MHZ	
	Uplink	698~716MHz z	776~787MHz z	817~849MHz z	1850~1915 MHz	1710~1755 MHZ	
Band Selection per Filter (ICS Mode)		LTE- 10 MHz	LTE- 10 MHz	LTE- 20 MHz	LTE- 20 MHz	LTE- 20 MHz	
Band Selection per Filter (SDR Mode)		LTE- 10 MHz	LTE- 10 MHz	LTE- 20 MHz	LTE- 20 MHz	LTE- 20 MHz	
Simultaneous Filter Support	SDR	3					Mode selection
	ICS	2					
Gain Flatness	Full Band	±1.5dB					
	Each Band	±1.5dB					
Gain	Range	55 ~ 95dB					
	Step	0.5dB					
	Tolerance	±1dB					
Frequency Error		±0.05ppm					
ALC Range		Max output power - 20dB					
Spurious Emissions		Meet 3GPP 36.106, 3GPP TS 36.141					
Out Band Spurious Emissions	-13dBm/1kHz; 9KHz<f<150KHz						
	-13dBm/10kHz; 150KHz<f<30MHz						
	-13dBm/100kHz; 30MHz<f<1GHz						
	-13dBm/1MHz; 1GHz<f<12.75GHz						
Composite Output Power		+43dBm/+30dBm					DL/UL
Required Minimum Isolation		Gain-15dB					Direct feedback signals
Roll Off		> 50dBc@ 1MHz Outside pass-band					
Noise Figure(UL)		≤ 5dB @ 95dB Gain ≤ 8dB @73dB Gain ≤ 12dB @ 65dB Gain					
Delay		< 7.2us					
EVM		Meet 3GPP 36.106, 3GPP TS 36.141					
VSWR		1.5:1					
Remote Alarm / Network		Web-GUI, SNMP,SNMP-Traps					With Modem or Ethernet connection

SDR-ICS-43_7F/7FN/ WCS Specifications

Specifications		SDR-ICS-43-7F	SDR-ICS-43-7FN	SDR-ICS-43-W	Comments
Frequency	Downlink	728~757MHz	758~768MHz	2350~2360MHz	
	Uplink	698~716MHz 776~787MHz	788~798MHz	2305~2315MHz	
Band Selection per Filter (ICS Mode)		LTE- 10 MHz	LTE- 10 MHz	LTE- 10 MHz	
Band Selection per Filter (SDR Mode)		LTE- 10 MHz	LTE- 10 MHz	LTE- 10 MHz	
Simultaneous Filter Support	SDR	3			Mode selection
	ICS	2			
Gain Flatness	Full Band	±1.5dB			
	Each Band	±1.5dB			
Gain	Range	55 ~ 95dB			
	Step	0.5dB			
	Tolerance	±1dB			
Frequency Error		±0.05ppm			
ALC Range		Max output power - 20dB			
Spurious Emissions		Meet 3GPP 36.106, 3GPP TS 36.141			
Out Band Spurious Emissions		-13dBm/1kHz; 9KHz<f<150KHz			
		-13dBm/10kHz; 150KHz<f<30MHz			
		-13dBm/100kHz; 30MHz<f<1GHz			
		-13dBm/1MHz; 1GHz<f<12.75GHz			
Composite Output Power		+43dBm/+30dBm			DL/UL
Required Minimum Isolation		Gain-15dB			Direct feedback signals
Roll Off		> 50dBc@ 1MHz Outside pass-band			
Noise Figure(UL)		≤ 5dB @ 95dB Gain ≤ 8dB @73dB Gain ≤ 12dB @ 65dB Gain			
Delay		< 7.2us			
EVM		Meet 3GPP 36.106, 3GPP TS 36.141			
VSWR		1.5:1			
Remote Alarm / Network		Web-GUI, SNMP,SNMP-Traps			With Modem or Ethernet connection

Mechanical Specifications

Parameters	Specifications	Comments
Dimension of chassis	19.0 X 10.50 X 17.00 Inches	482 X 266.5 X 430 mm (W*H*D)
Dimension of repeater	7L/7U/S8C/P/A/BT/W	106 X 262.5 X 450 mm (W*H*D)
	7F/7FN	134 X 262.5 X 450 mm (W*H*D)
Weight	7L/7U/S8C/P/A/BT/W	30.5 lbs
	7F/7FN	39.68 lbs
RF Ports	4.3-10 Female	Donor & Server Antenna Ports
Local Interface	RJ-45(Ethernet)	
Cooling	FAN	
Weather Resistance	IP66	
Mounting Type	19" Rack / Wall / Pole Mounting	
Ground	External Threaded Stud	

Environmental Specifications

Parameters	Specifications	Comments
Operating Temperature	-40°F to +131°F (-40°C to +55°C)	-
Relative Humidity	5~90%	

Power Specifications

Parameters	Specifications	Comments
AC Power	AC 100 ~ 240V	Free Voltage
AC Frequency	45~65Hz	
AC Voltage Protection	Circuit Protector	
Battery Backup	+24V	
Power Consumption	< 250Watt	Except battery charging capacity.

Other Specifications

Parameters	Specifications	Comments
MTBF	> 100,000 Hours	
Warranty	3 Years	

9. APPENDIX

9.1 Shutdown Retry Logic

The function of the built-in shutdown routine is to protect the repeater from any further damage from a hard-fail that the system may be experiencing.

Within 5 seconds of a hard-fail alarm being detected, the repeater will start the shutdown routine. The repeater will shut down by powering of the HPAs (high-powered amplifiers) for 30 seconds.

After 30 seconds have elapsed, the repeater will power on the HPAs and check to see if the hard-fail alarm still exist. If the hard-fail alarm still exists, then the repeater will shut down for 1 minute (double the time of the previous shutdown time).

After 1 minute has elapsed, the repeater will power on the HPAs and check to see if the hard-fail alarm still exist. If the hard-fail alarm still exists, then the repeater will shut down for 2 minutes (double the time of the previous shutdown time).

The shutdown routine will repeat itself a total of 10 times. If the hard-fail alarm still exists after the 10th retry, then the repeater will turn off its HPAs permanently until a reset is performed or factory set is executed.

INDEX

AGC.....	9, 10, 31	LNA.....	9
ALC.....	9, 31	LTE.....	9
AROMS.....	9	MS.....	9
BTS.....	9	PLL.....	9
CDMA.....	9	PS.....	9
CW.....	9	RF.....	2, 9, 10, 16, 18, 22, 26, 31, 41
DAS.....	9	SQE.....	9
DL.....	9, 29, 31	SW.....	9
Downlink.....	9, 29, 31	UL.....	9, 29, 31
HPA.....	9, 29	Uplink.....	29, 31
HW.....	9	VSWR.....	9, 32
IF.....	9		