



# FCC TEST REPORT

Product Name	Repeater
Model Name	SDR-ICS-43-A
Applicant	ADRF KOREA INC.
FCC ID	N52-SDR-ICS-43-A

## ESTECH CO., LTD

Rm. 1015 World Venture Center, 426-5 Gasan-dong, Geumcheon-gu,  
Seoul, 153-803, Korea. Tel:82-2-867-3201, Fax:82-2-867-3204

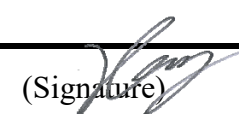
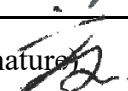

# FCC Test Report

Report Number	ESTRFC1807-003			
Applicant	Company Name	ADRF Korea, inc		
	Address	5-5, Mojeon-Ri, Backsa-Myun, Icheon-City, Kyunggi-Do, Korea		
Product	Product Name	Repeater		
	Model No.	SDR-ICS-43A	Manufacturer	ADRF Korea, inc
	Serial No.	Non	Country of origin	KOREA
Other	Issued Date	2018-07-27	Tested Date	2018-07-14~ 2018-07-21
Test Result	<b>Pass</b>			
Standard	<b>FCC PART 27</b>			
Tested by	Engineering Manager I.K. Hong		(Signature) 	
Approved by	Engineering manager Keum-Bum Lee		(Signature) 	
<h2>ESTECH CO., LTD</h2> <p>Rm. 1015 World Venture Center, 426-5 Gasan-dong, Geumcheon-gu,          Seoul, 153-803, Korea. Tel:82-2-867-3201, Fax:82-2-867-3204</p>				
<p>o This is certified that the above mentioned products have been tested for the sample provided by client.</p> <p>o No part of this document may not be duplicated or reproduced by any means without the express written permission of Estech Co., Ltd.</p>				



## Contents

<b>1. General Information</b>	Page 4
<b>2. Laboratory Information</b>	Page 5
<b>3. Summary of Test Results</b>	Page 5
<b>4. Measuring AGC threshold level Power and Conducted RF Output Power</b>	Page 6
<b>5. Occupied Bandwidth</b>	Page 10
<b>6. Out of Band Rejection</b>	Page 14
<b>7. Spurious Emission at Antenna Terminal</b>	Page 17
<b>8. Radiated Spurious Emission</b>	Page 34

## 1. General Information

### 1.1 EUT Description

FCC ID	N52-SDR-ICS-43-A
Product Name	Repeater
Model Name	SDR-ICS-43A
Frequency	Downlink : 2 110.00MHz ~ 2 155.00 MHz
	Uplink : 1 710.00MHz ~ 1 755.00 MHz
Duty	100 %
Power Rating	Input: 110~240VAC 50~60Hz
Antenna Gain	Manufacturer does not Provide antenna
Mode of the test	LTE 20 MHz
conducted output power	Downlink : 43 dBm , Uplink : 30 dBm
Gain	55 ~ 95 dB

## 2. Laboratory Information

- 2.1 Laboratory Name** Estech Co., Ltd.
- 2.2 Location**
- Head Office** Rm. 1015, World Venture Center II, 426-5 Gasan-dong  
 Geumcheon-gu, Seoul, 153-803. Korea.
- EMC Lab(Yanggi)** 97-1, Hooeok-Ri Majang-Myon, Icheon-city, KyungKi-Do, Korea
- 2.3 Quality System** Accredited by KOLAS(ISO/IEC 17025)

**2.4 Major Accredited Mark**



## 3. Summary of Test Results

Test Item	Standard	Result
Conducted RF Output Power	2.1046	PASS
Measuring AGC threshold level	935210 D05 v01r02	PASS
Occupied Bandwidth	2.1049	PASS
Out of Band Rejection	935210 D05 v01r02	PASS
Spurious Emission at Antenna Terminal	2.1051	PASS
Radiated Spurious Emission	2.1053	PASS

Note : Evaluation was performed in accordance with KDB 935210 and Washington Laboratories Test Plan (Document WLL Job #13257) and Correspondence with FCC.

## 4. Measuring AGC threshold level Power and Conducted RF Output

### 4.1 Test Procedure according to KDB935210 D5 3.2

- a) Connect a signal generator to the input of the EUT.
- b) Connect a spectrum analyzer or power meter to the output of the EUT using appropriate attenuation as necessary.
- c) The signal generator should initially be configured to produce either of the required test signals (i.e., broadband or narrowband).
- d) Set the signal generator frequency to the center frequency of the EUT operating band.
- e) While monitoring the output power of the EUT, measured using the methods of 3.5.3 or 3.5.4, increase the input level until a 1 dB increase in the input signal power no longer causes a 1 dB increase in the output signal power.
- f) Record this level as the AGC threshold level.
- g) Repeat the procedure with the remaining test signal.

### 2. Test setup for RF Conducted measurement

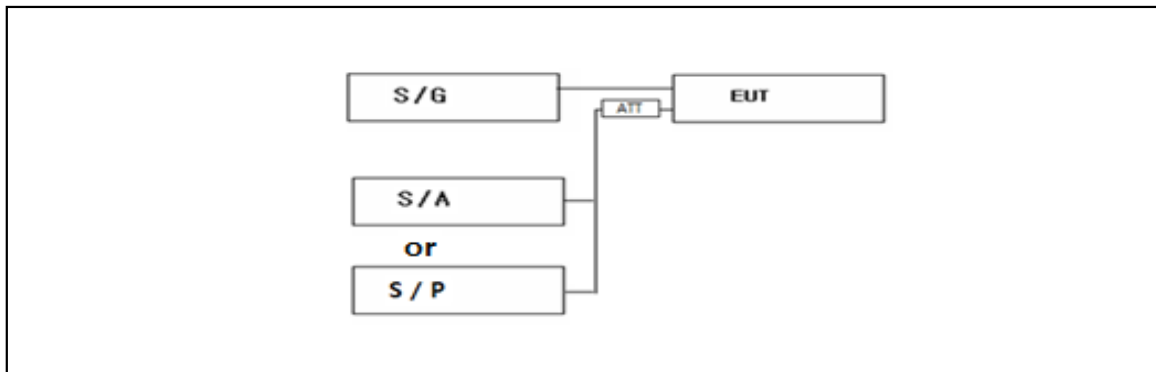

### 4.2 Test Equipments

The following test equipments are used during tests

Equipment	Manufacturer	Model	Next Cal.
Spectrum Analyzer	Agilent	E4440A	2018-12-27
Spectrum Analyzer	ROHDE&SCHWARZ	FSV40	2018-12-27
Signal Generator	ROHDE&SCHWARZ	SMBV100A	2018-12-26
Signal Generator	ROHDE&SCHWARZ	SMB100	2018-12-27
Attenuator	SRT	F04-K1830-01	2018-12-26
Attenuator	Bird Electronic Corp	100-SA-MFN-30	2018-12-26
Power Meter	Agilent	N1912A	2018-12-26
Power Sensor	Agilent	N1912A	2018-12-26

4.3 Test Results : Pass

Downlink

Freq (MHz)	Input Level (dBm)	Output (dBm)	Gain (dB)
2 130	-52.00	42.77	94.77
<b>2 130</b>	<b>-51.24</b>	<b>42.87</b>	<b>94.11</b>
2 130	-50.00	42.83	92.83
2 130	-49.00	42.79	91.79
2 130	-40.00	42.75	82.75
2 130	-30.00	42.81	72.81
2 130	-20.00	42.80	62.80
2 130	-13.00	42.77	55.77

Uplink

Freq (MHz)	Input Level (dBm)	Output (dBm)	Gain (dB)
1 930	-65.00	29.66	94.66
<b>1 930</b>	<b>-64.77</b>	<b>29.87</b>	<b>94.64</b>
1 930	-50.00	29.78	79.78
1 930	-40.00	29.82	69.82
1 930	-30.00	29.79	59.79
1 930	-25.00	29.83	54.83

4.4 Test Plot of Spectrum

Downlink  
Input Signal

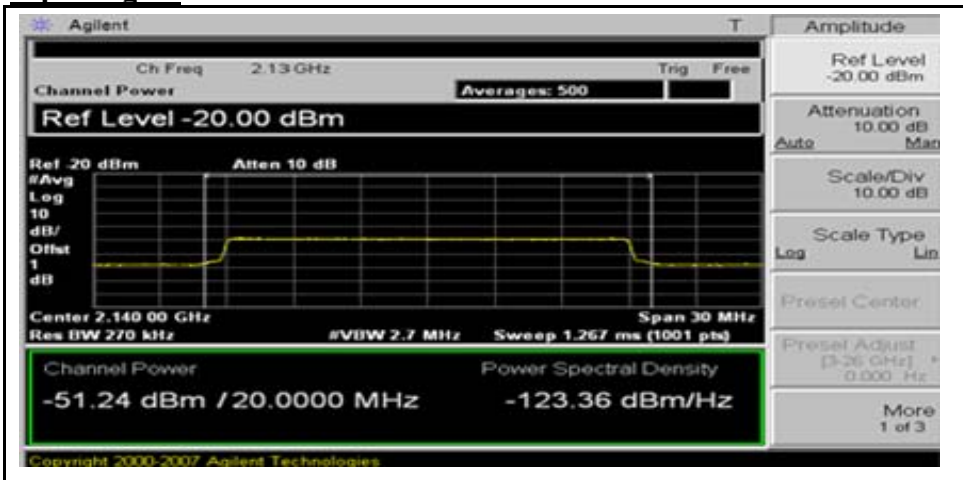

Output Signal

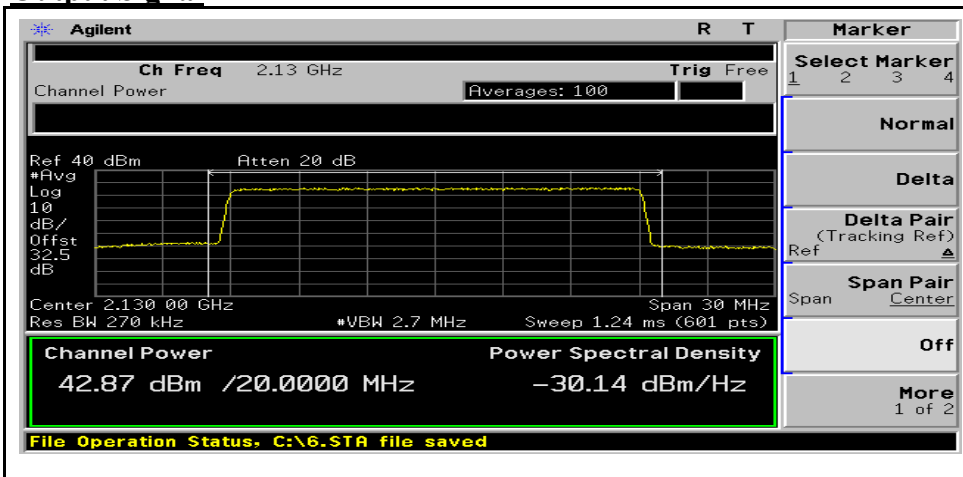





**Uplink**  
**Input Signal**

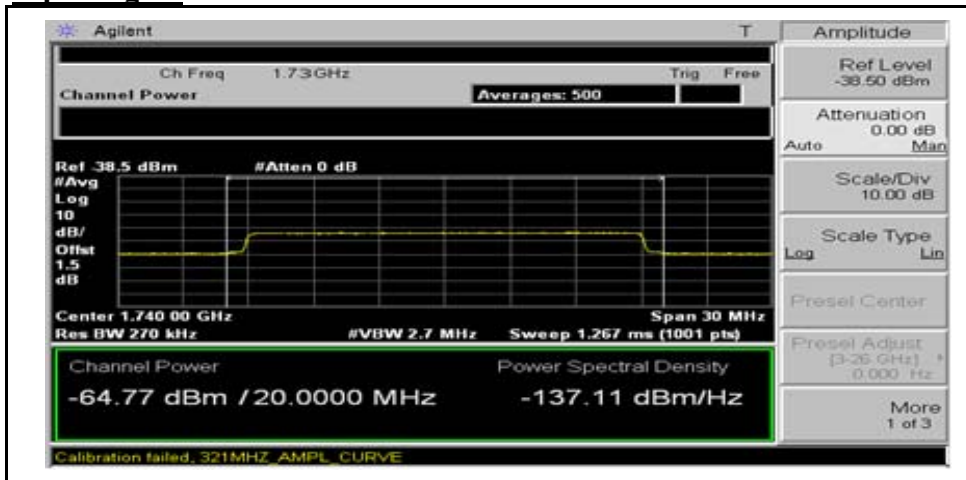

**Output Signal**

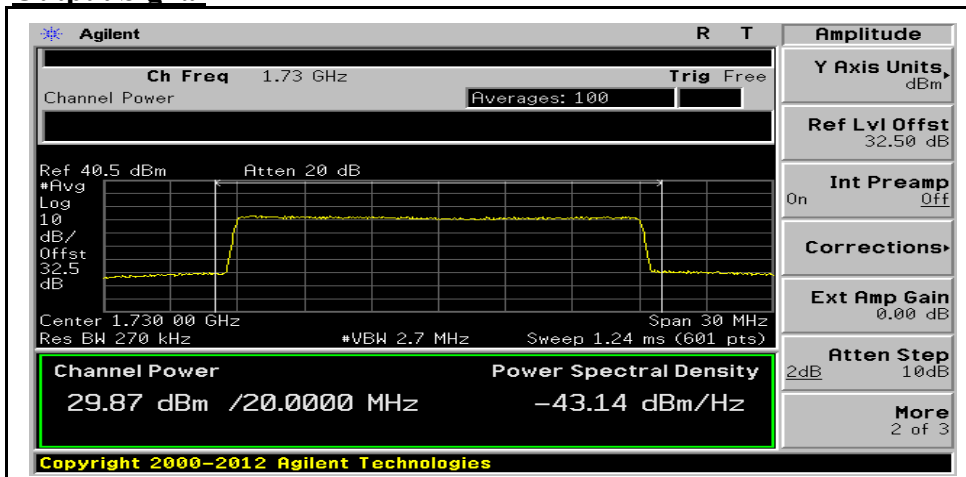

## 5. Occupied Bandwidth

### 5.1 Test Procedure according to KDB935210 D5 3.4

- a) Connect a signal generator to the input of the EUT.
- b) Configure the signal generator to transmit the AWGN signal.
- c) Configure the signal amplitude to be just below the AGC threshold level (see 3.2), but not more than 0.5 dB below.
- d) Connect a spectrum analyzer to the output of the EUT using appropriate attenuation.
- e) Set the spectrum analyzer center frequency to the center frequency of the operational band under test. The span range of the spectrum analyzer shall be between 2 times to 5 times the emission bandwidth (EBW) or alternatively, the OBW.
- f) The nominal RBW shall be in the range of 1 % to 5 % of the anticipated OBW, and the VBW shall be  $\geq 3 \times \text{RBW}$ .
- g) Set the reference level of the instrument as required to preclude the signal from exceeding the maximum spectrum analyzer input mixer level for linear operation. In general, the peak of the spectral envelope must be more than  $[10 \log (\text{OBW} / \text{RBW})]$  below the reference level. Steps f) and g) may require iteration to enable adjustments within the specified tolerances.
- h) The noise floor of the spectrum analyzer at the selected RBW shall be at least 36 dB below the reference level.
- i) Set spectrum analyzer detection function to positive peak.
- j) Set the trace mode to max hold.
- k) Determine the reference value: Allow the trace to stabilize. Set the spectrum analyzer marker to the highest amplitude level of the displayed trace (this is the reference value) and record the associated frequency as  $f_0$ .
- l) Place two markers, one at the lowest and the other at the highest frequency of the envelope of the spectral display, such that each marker is at or slightly below the  $-26$  dB down amplitude. The 26 dB EBW (alternatively OBW) is the positive frequency difference between the two markers. If the spectral envelope crosses the  $-26$  dB down amplitude at multiple points, the lowest or highest frequency shall be selected as the frequencies that are the furthest removed from the center frequency at which the spectral envelope crosses the  $-26$  dB down amplitude point.
- m) Repeat steps e) to l) with the input signal connected directly to the spectrum analyzer (i.e., input signal measurement).
- n) Compare the spectral plot of the input signal (determined from step m) to the output signal (determined from step l) to affirm that they are similar (in passband and rolloff characteristic features and relative spectral locations), and include plot(s) and descriptions in test report.
- o) Repeat the procedure [steps e) to n)] with the input signal amplitude set to 3 dB above the AGC threshold.
- p) Repeat steps e) to o) with the signal generator set to the narrowband signal.
- q) Repeat steps e) to p) for all frequency bands authorized for use by the EUT.

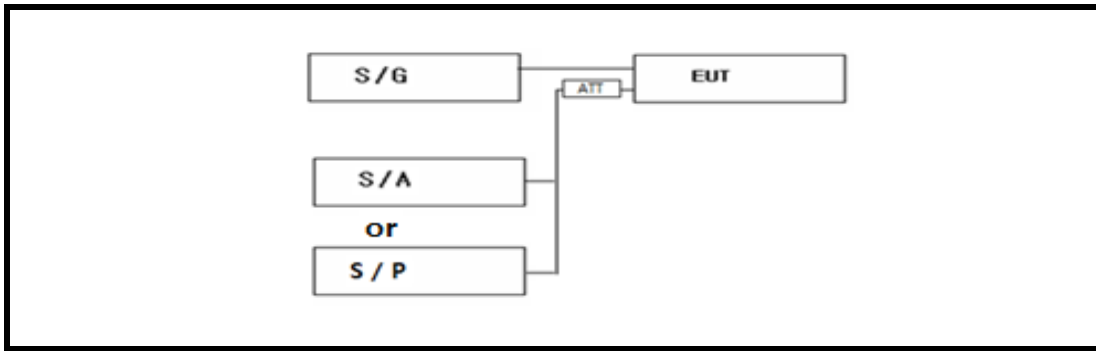

## 5.2 Test Equipments

The following test equipments are used during tests

Equipment	Manufacturer	Model	Next Cal.
Spectrum Analyzer	Agilent	E4440A	2018-12-27
Spectrum Analyzer	ROHDE&SCHWARZ	FSV40	2018-12-27
Signal Generator	ROHDE&SCHWARZ	SMBV100A	2018-12-26
Signal Generator	HP	N5182A	2018-06-16
Signal Generator	ROHDE&SCHWARZ	SMB100	2018-12-27
Attenuator	SRT	F04-K1830-01	2018-12-26
Attenuator	Bird Electronic Corp	100-SA-MFN-30	2018-12-26
Power Meter	Agilent	N1912A	2018-12-26
Power Sensor	Agilent	N1912A	2018-12-26

5.3 Test Results : Pass

Downlink  
Input Signal

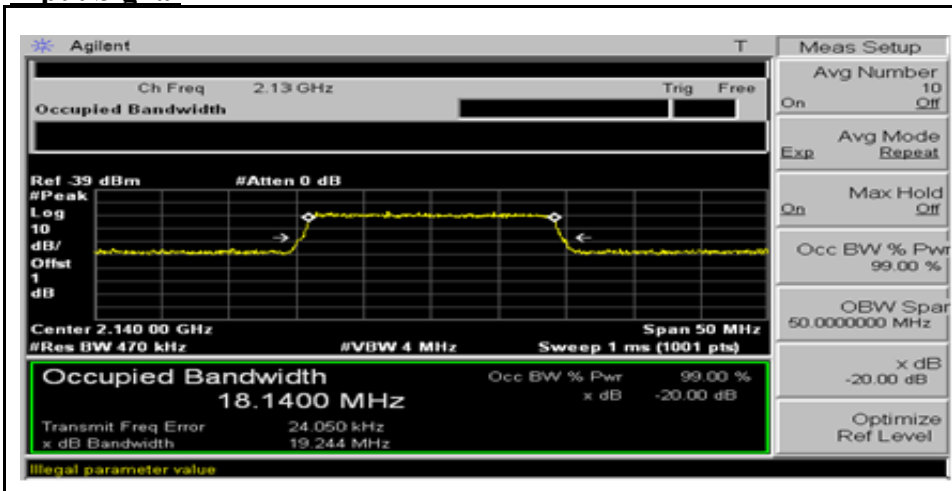

Output Signal

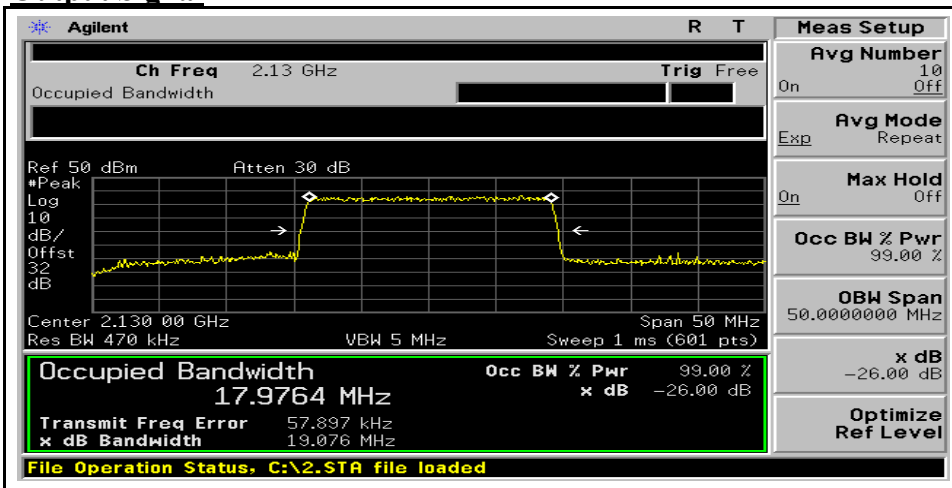



**Uplink  
 Input Signal**

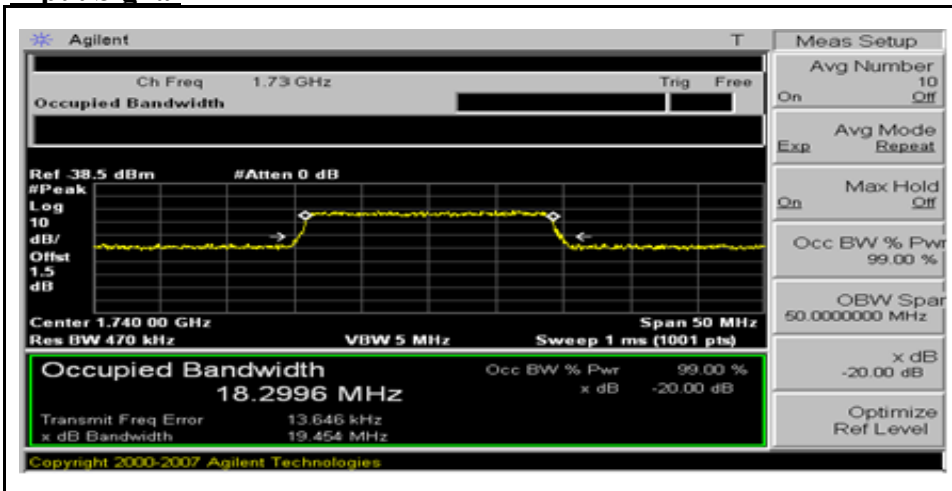

**Output Signal**

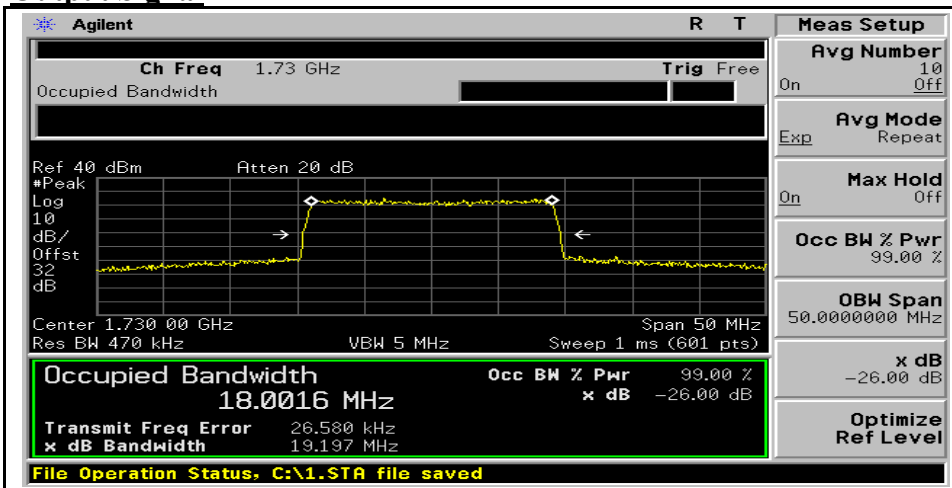

## 6. Out of Band Rejection

### 6.1 Test Procedure

- a) Connect a signal generator to the input of the EUT.
- b) Configure a swept CW signal with the following parameters:
  - 1) Frequency range =  $\pm 250\%$  of the passband, for each applicable CMRS band (see also KDB Publication 935210 D02 [R7] and KDB Publication 634817 [R5] about selection of frequencies for testing and for grant listings).
  - 2) Level = a sufficient level to affirm that the out-of-band rejection is  $> 20$  dB above the noise floor and will not engage the AGC during the entire sweep.
  - 3) Dwell time = approximately 10 ms.
  - 4) Number of points =  $\text{SPAN}/(\text{RBW}/2)$ .
- c) Connect a spectrum analyzer to the output of the EUT using appropriate attenuation.
- d) Set the span of the spectrum analyzer to the same as the frequency range of the signal generator.
- e) Set the resolution bandwidth (RBW) of the spectrum analyzer to be 1 % to 5 % of the EUT passband, and the video bandwidth (VBW) shall be set to  $\geq 3 \times \text{RBW}$ .
- f) Set the detector to Peak Max-Hold and wait for the spectrum analyzer's spectral display to fill.
- g) Place a marker to the peak of the frequency response and record this frequency as  $f_0$ .
- h) Place two markers, one at the lowest and the other at the highest frequency of the envelope of the spectral display, such that each marker is at or slightly below the  $-20$  dB down amplitude, to determine the 20 dB bandwidth.
- i) Capture the frequency response of the EUT.
- j) Repeat for all frequency bands applicable for use by the EUT.

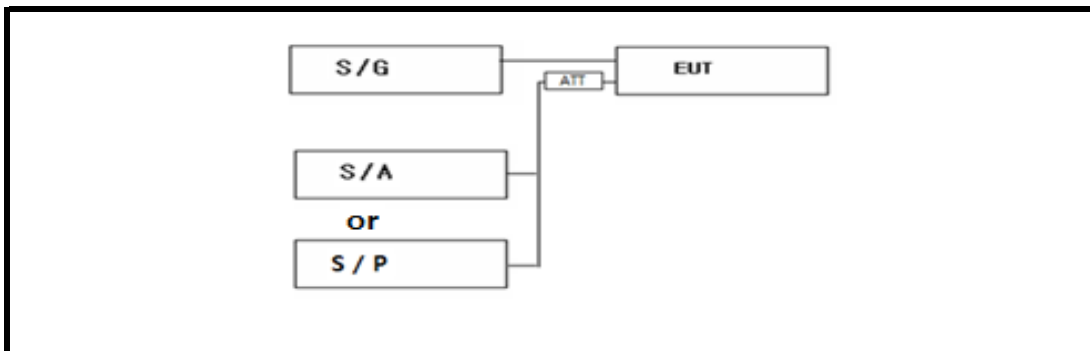

## 6.2 Test Equipments

The following test equipments are used during tests

Equipment	Manufacturer	Model	Next Cal.
Spectrum Analyzer	Agilent	E4440A	2018-12-27
Spectrum Analyzer	ROHDE&SCHWARZ	FSV40	2018-12-27
Signal Generator	ROHDE&SCHWARZ	SMBV100A	2018-12-26
Signal Generator	HP	N5182A	2018-06-16
Signal Generator	ROHDE&SCHWARZ	SMB100	2018-12-27
Attenuator	SRT	F04-K1830-01	2018-12-26
Attenuator	Bird Electronic Corp	100-SA-MFN-30	2018-12-26
Power Meter	Agilent	N1912A	2018-12-26
Power Sensor	Agilent	N1912A	2018-12-26

6.3 Test Results : Pass

Test Plot of Uplink

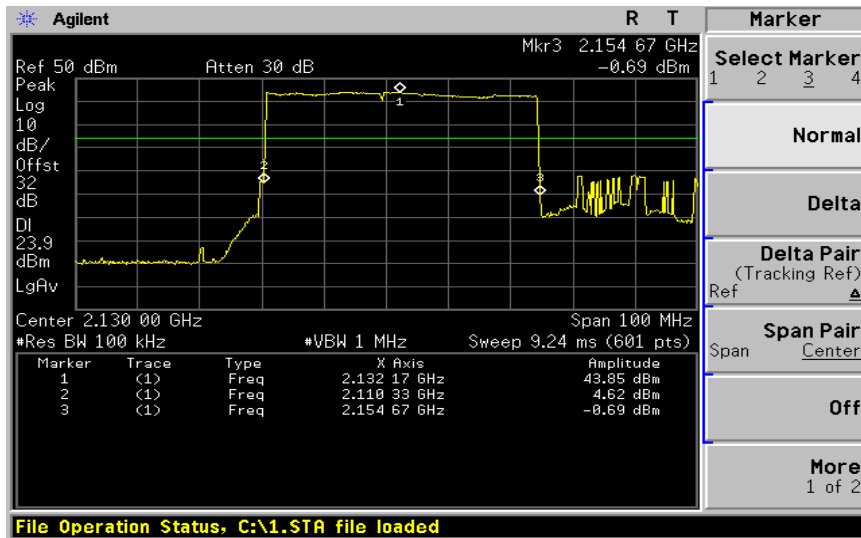

	Frequency (MHz)
marker 2	2110.33
marker 3	2154.67

Test Plot of Downlink

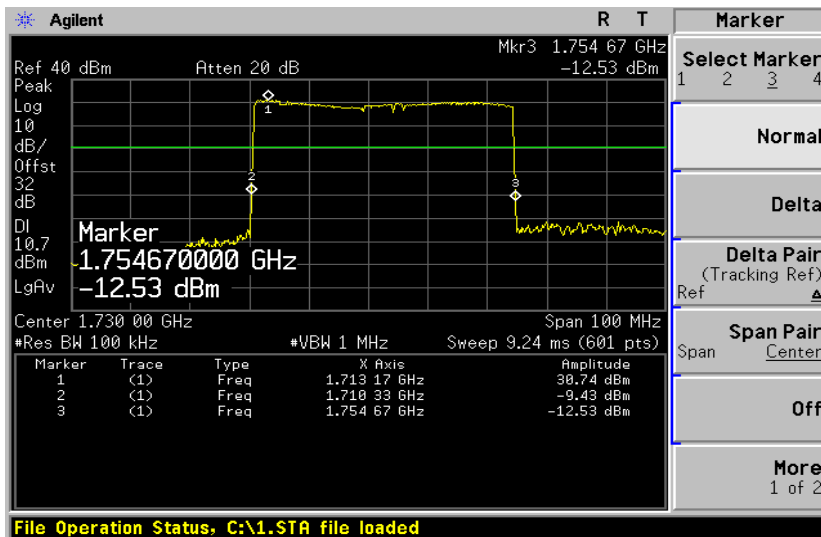

	Frequency (MHz)
marker 2	1710.33
marker 3	1754.67



## 7. Spurious Emission at Antenna Terminal

### 7.1 Test Procedure

- a) Connect a signal generator to the input of the EUT.
- b) Set the signal generator to produce the broadband test signal as previously described (i.e., 4.1 MHz OBW AWGN).
- c) Set the center frequency of the test signal to the lowest available channel within the frequency band or block.
- d) Set the EUT input power to a level that is just below the AGC threshold (see 3.2), but not more than 0.5 dB below.
- e) Connect a spectrum analyzer to the output of the EUT using appropriate attenuation as necessary.
- f) Set the RBW = reference bandwidth in the applicable rule section for the supported frequency band of operation (e.g., reference bandwidth is typically 100 kHz or 1 MHz).
- g) Set the VBW  $\geq 3 \times$  RBW.
- h) Set the Sweep time = auto-couple.
- i) Set the spectrum analyzer start frequency to the lowest RF signal generated in the equipment, without going below 9 kHz, and the stop frequency to the lower band/block edge frequency minus 100 kHz or 1 MHz, as specified in the applicable rule part.

The number of measurement points in each sweep must be  $\geq (2 \times \text{span}/\text{RBW})$ , which may require that the measurement range defined by the start and stop frequencies be subdivided, depending on the available number of measurement points provided by the spectrum analyzer.<sup>4</sup>

- j) Select the power averaging (rms) detector function.
- k) Trace average at least 10 traces in power averaging (rms) mode.
- l) Use the peak marker function to identify the highest amplitude level over each measured frequency range. Record the frequency and amplitude and capture a plot for inclusion in the test report.
- m) Reset the spectrum analyzer start frequency to the upper band/block edge frequency plus 100 kHz or 1 MHz, as specified in the applicable rule part, and the spectrum analyzer stop frequency to 10 times the highest frequency of the fundamental emission (see Section 2.1057). The number of measurement points in each sweep must be  $\geq (2 \times \text{span}/\text{RBW})$ , which may require that the measurement range defined by the start and stop frequencies be subdivided, depending on the available number of measurement points provided by the spectrum analyzer.
- n) Trace average at least 10 traces in power averaging (rms) mode.
- o) Use the peak marker function to identify the highest amplitude level over each of the measured frequency ranges. Record the frequency and amplitude and capture a plot for inclusion in the test report; also provide tabular data, if required.
- p) Repeat steps i) to o) with the input test signals firstly tuned to a middle band/block frequency/channel, and then tuned to a high band/block frequency/channel.
- q) Repeat steps b) to p) with the narrowband test signal.
- r) Repeat steps b) to q) for all authorized frequency bands/blocks used by the EUT.

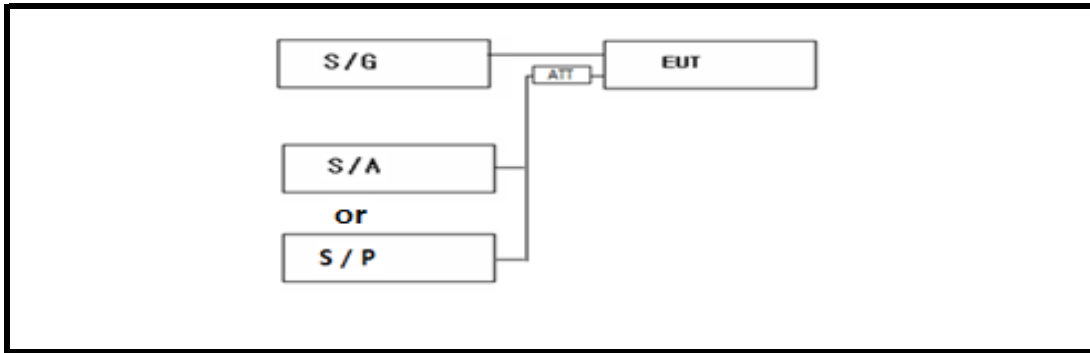

## 6.2 Test Equipments

The following test equipments are used during tests

Equipment	Manufacturer	Model	Next Cal.
Spectrum Analyzer	Agilent	E4440A	2018-12-27
Spectrum Analyzer	ROHDE&SCHWARZ	FSV40	2018-12-27
Signal Generator	ROHDE&SCHWARZ	SMBV100A	2018-12-26
Signal Generator	ROHDE&SCHWARZ	SMB100	2018-12-27
Attenuator	SRT	F04-K1830-01	2018-12-26
Attenuator	Bird Electronic Corp	100-SA-MFN-30	2018-12-26
Power Meter	Agilent	N1912A	2018-12-26
Power Sensor	Agilent	N1912A	2018-12-26

6.3 Test Results : Pass

Test Plot of Downlink  
Low channel

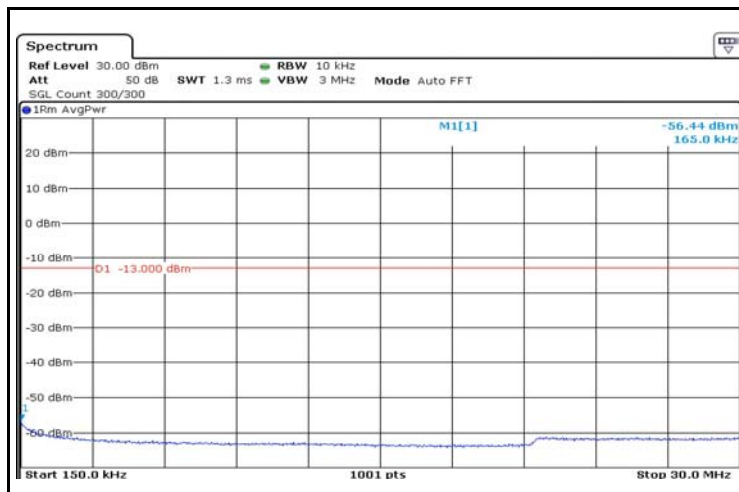
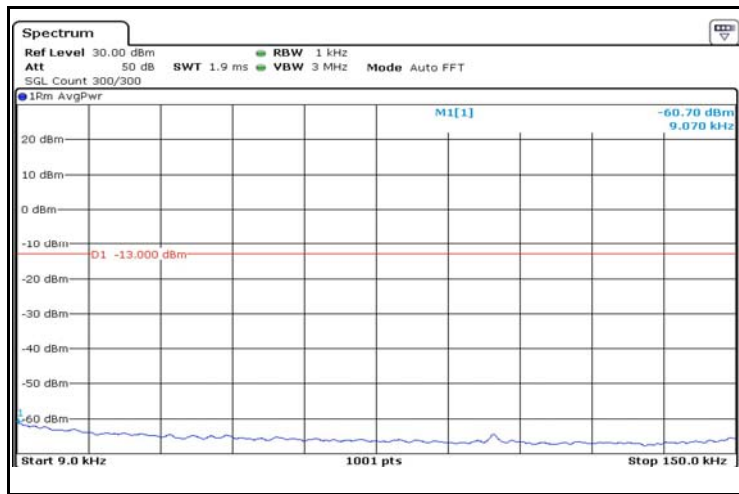

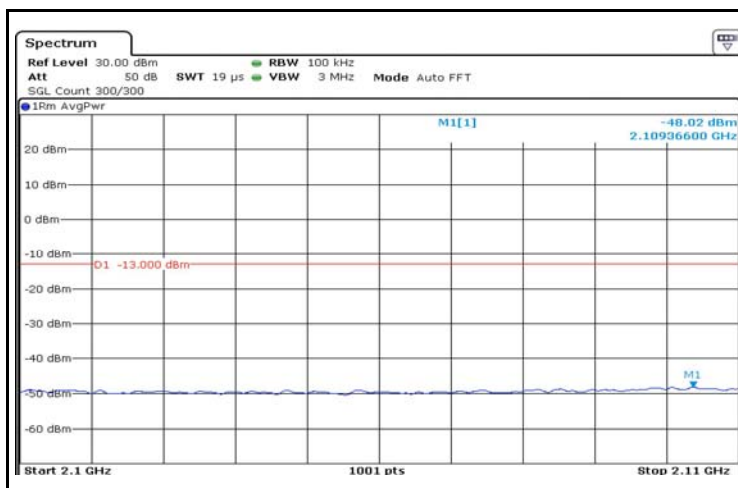
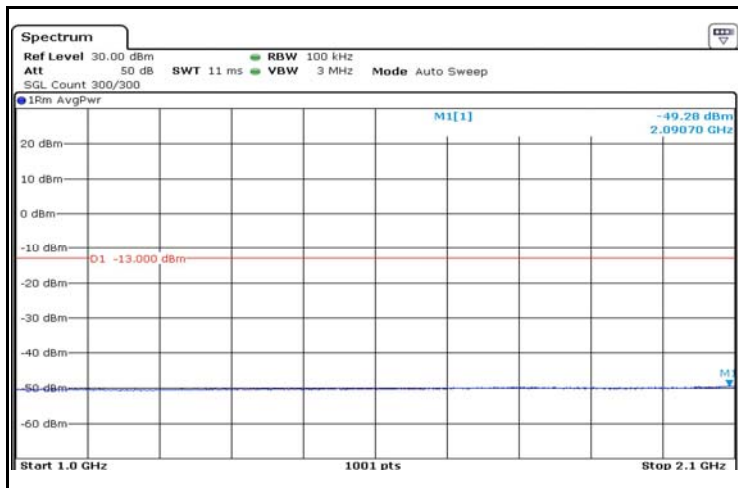
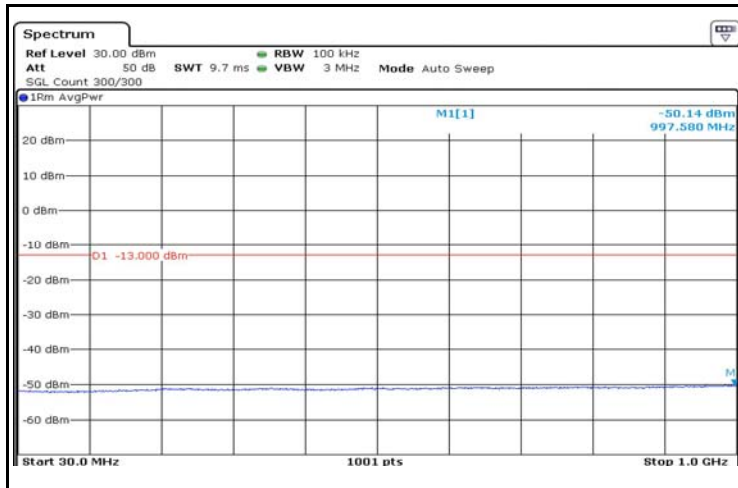

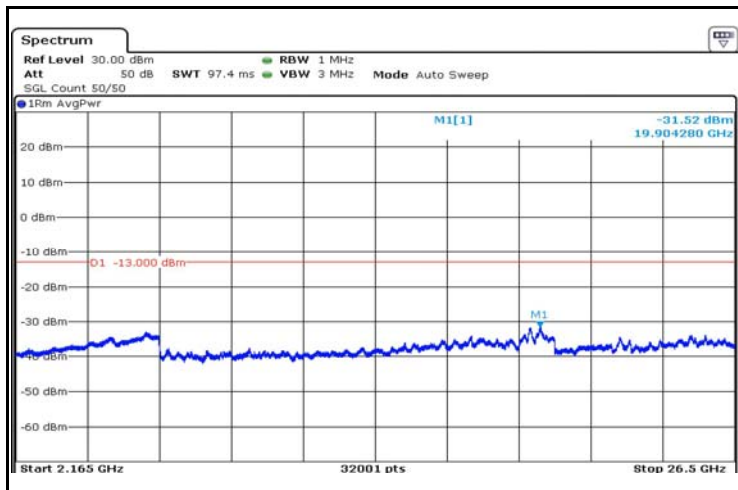
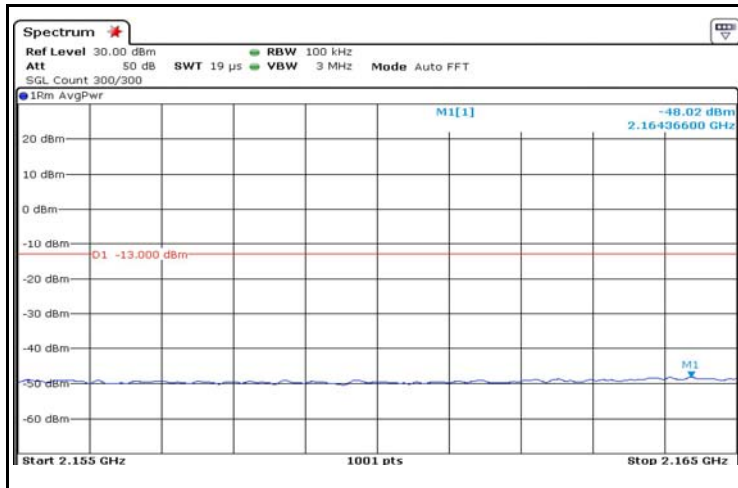



### Test Plot of Downlink High channel

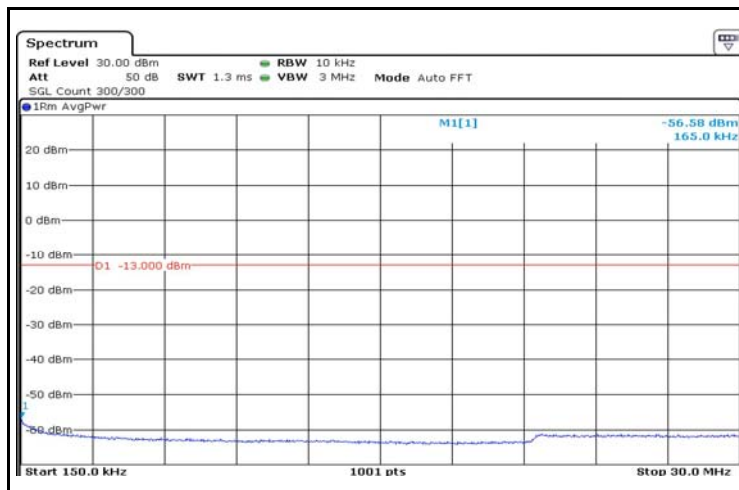
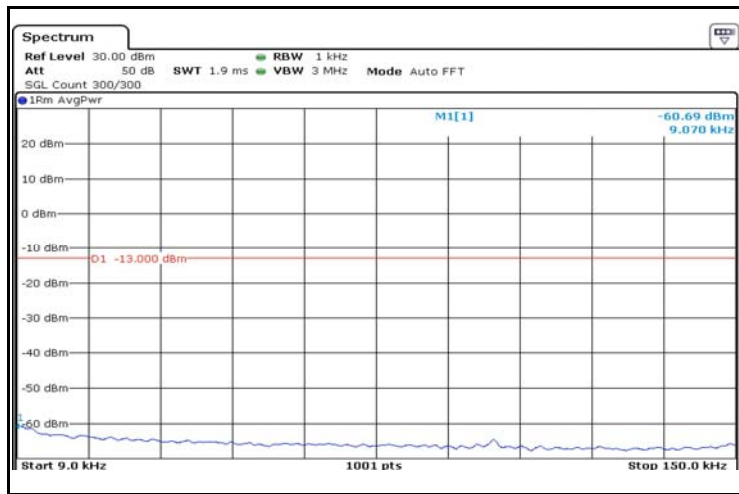

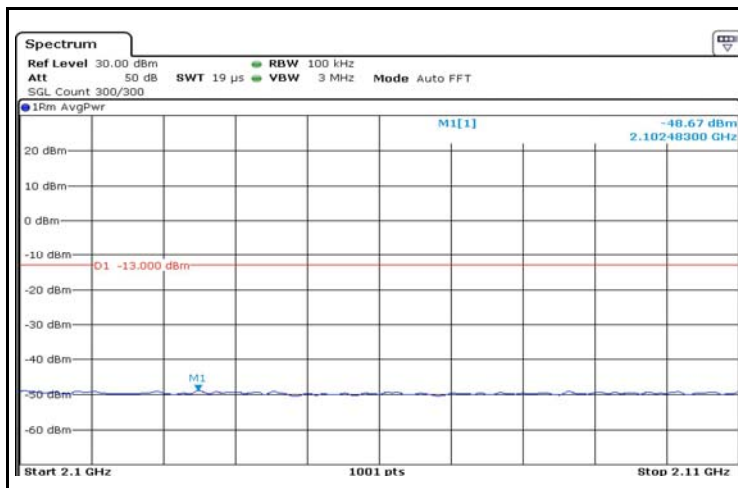
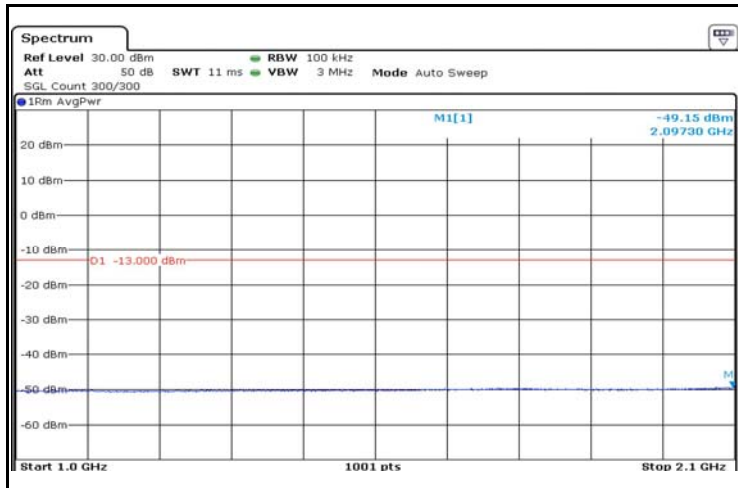
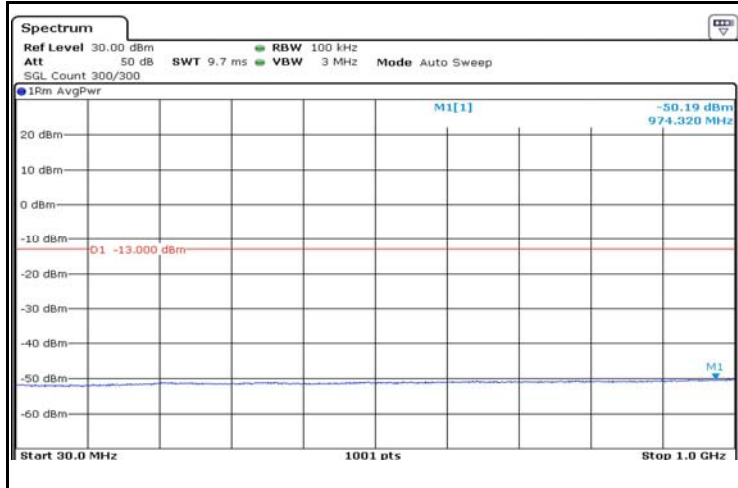

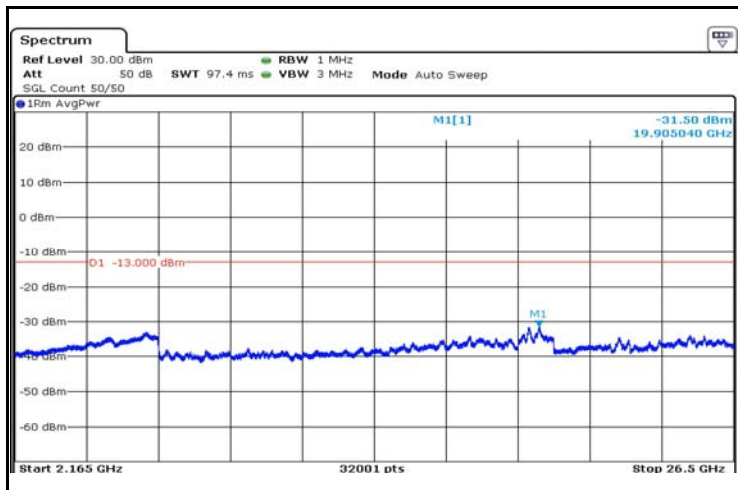
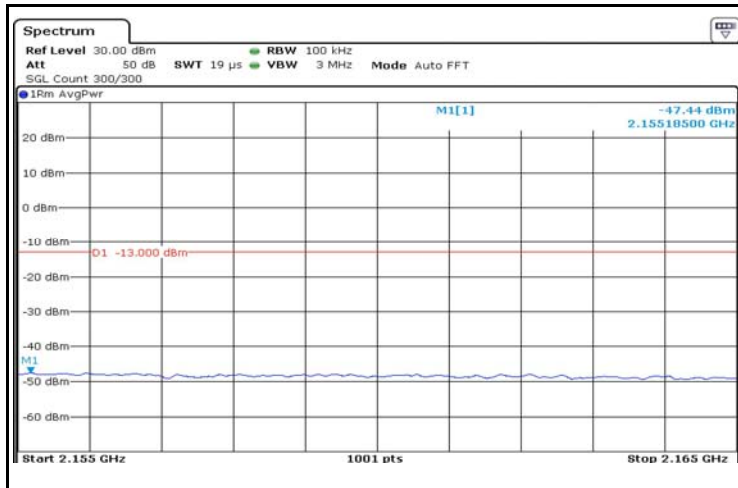





### Test Plot of Uplink Low channel

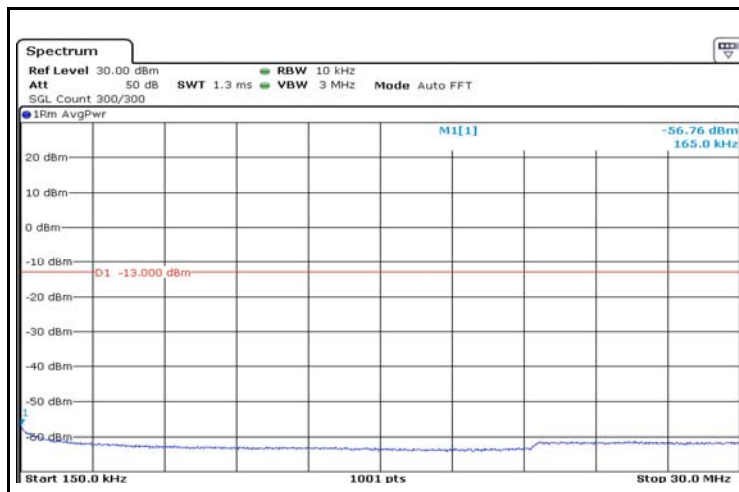
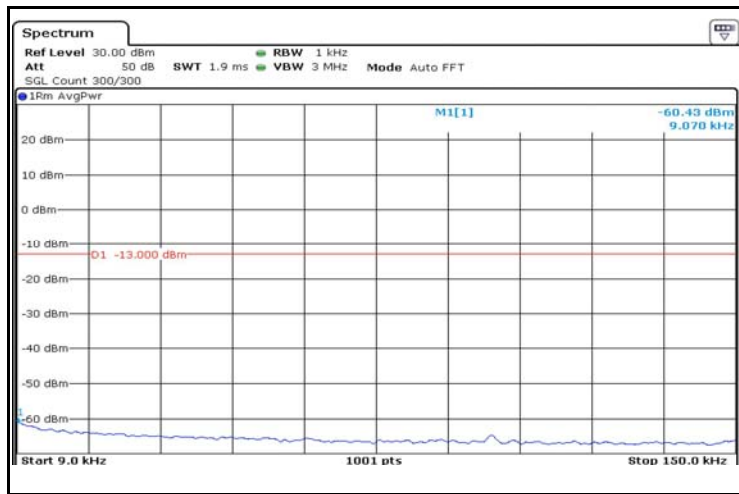

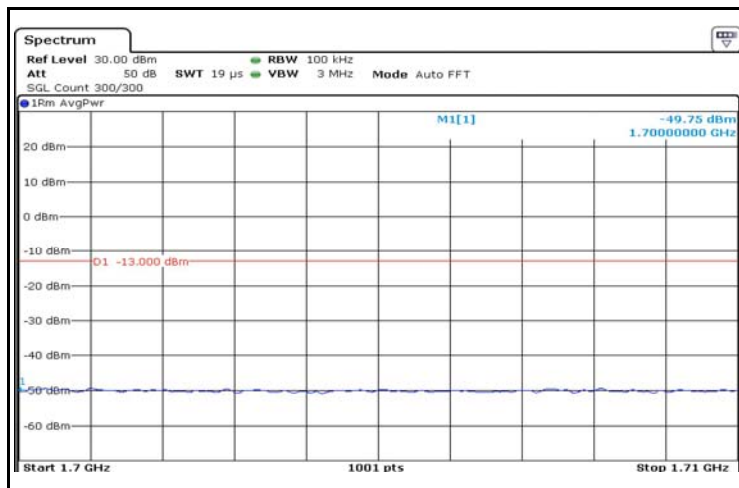
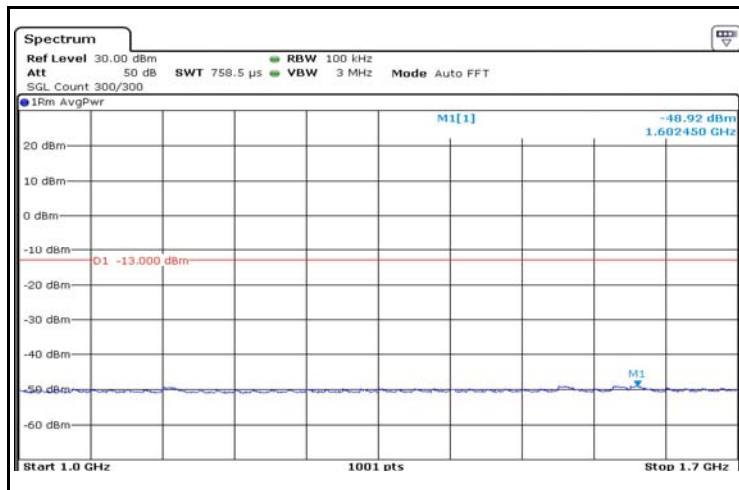
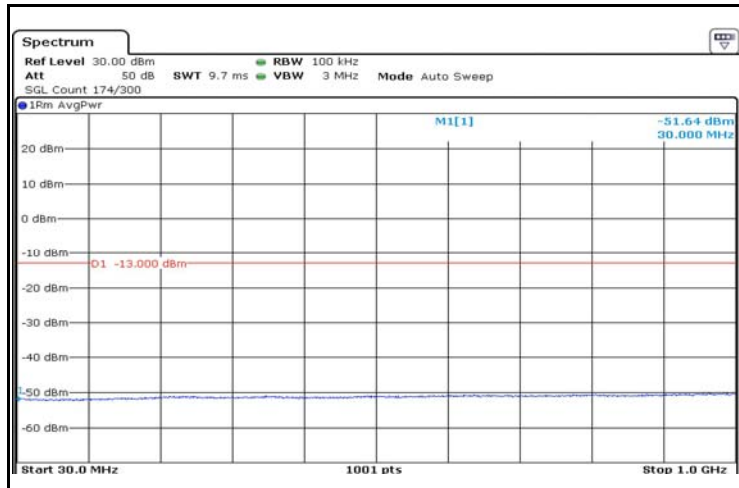

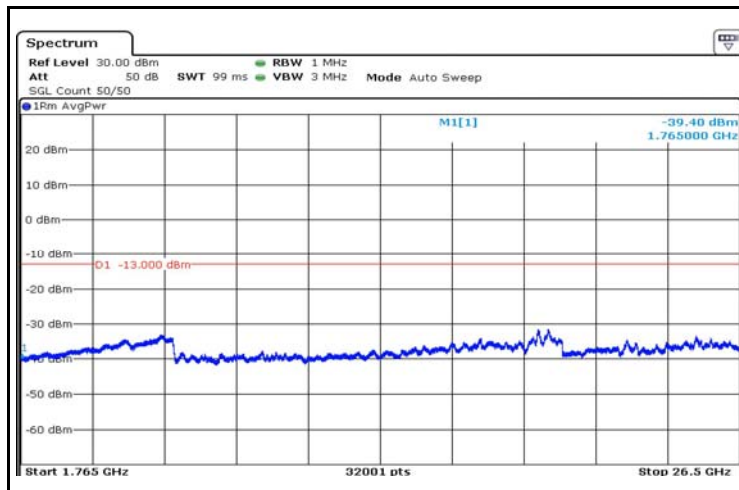
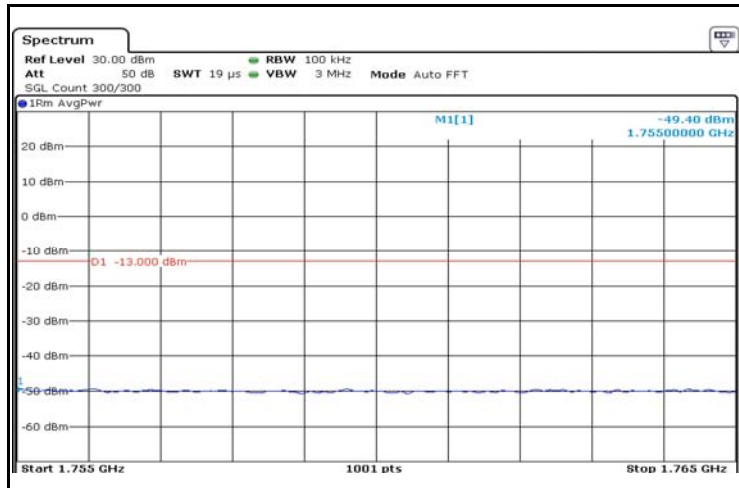



### Test Plot of Uplink High channel

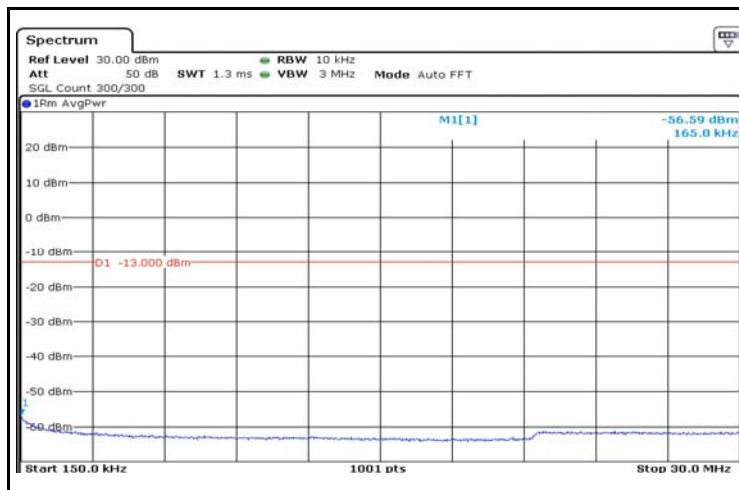
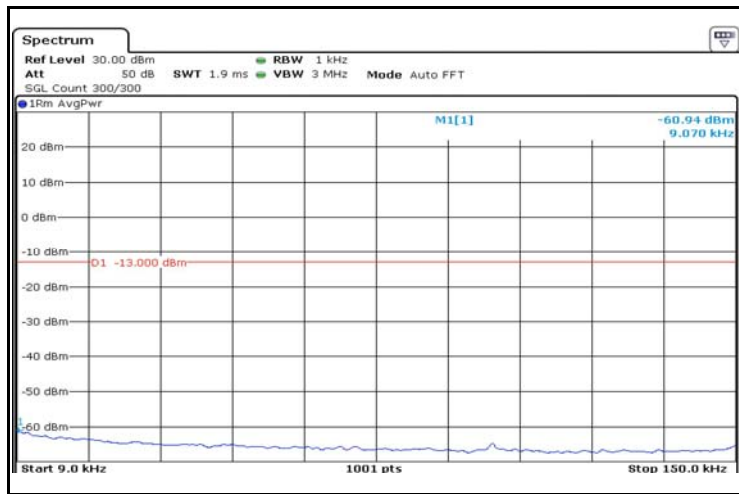

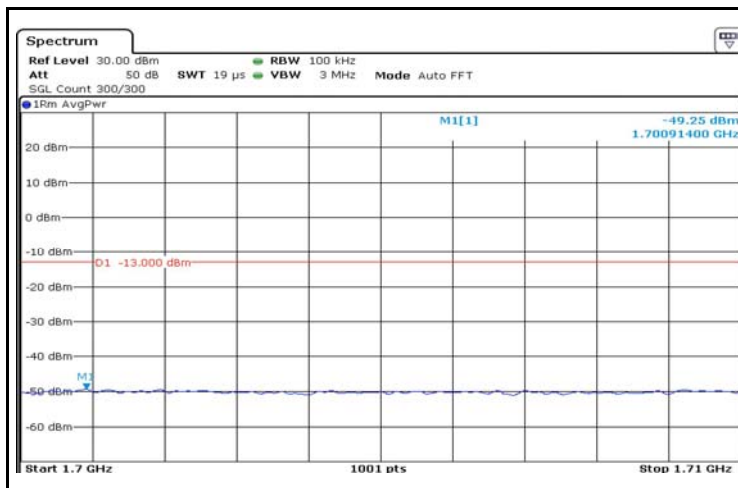
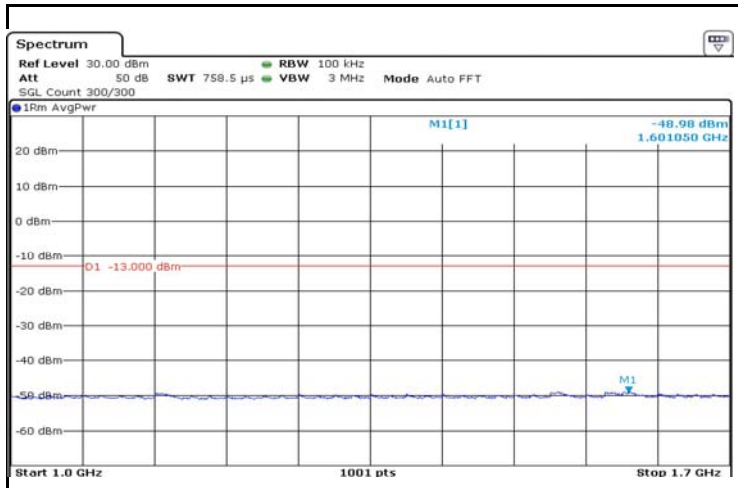
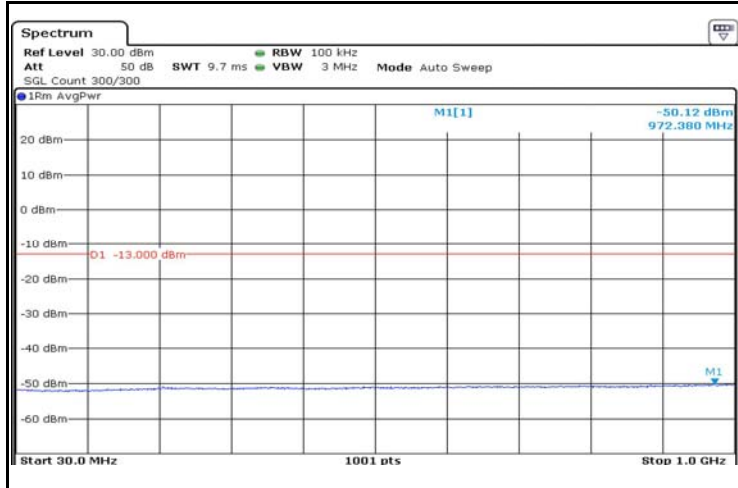

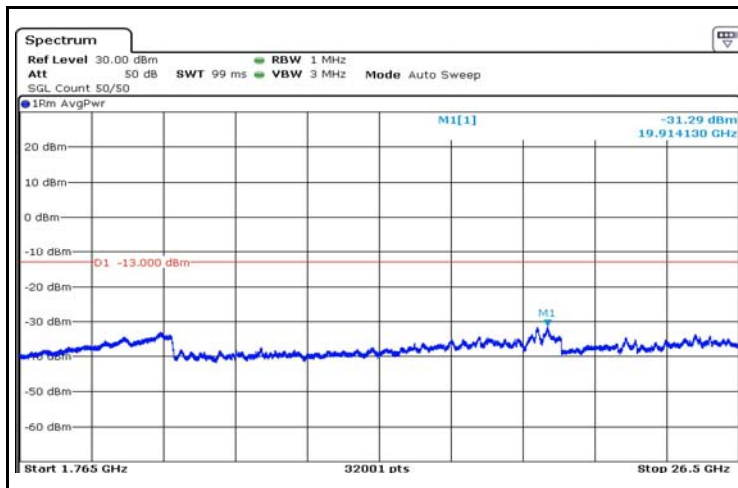
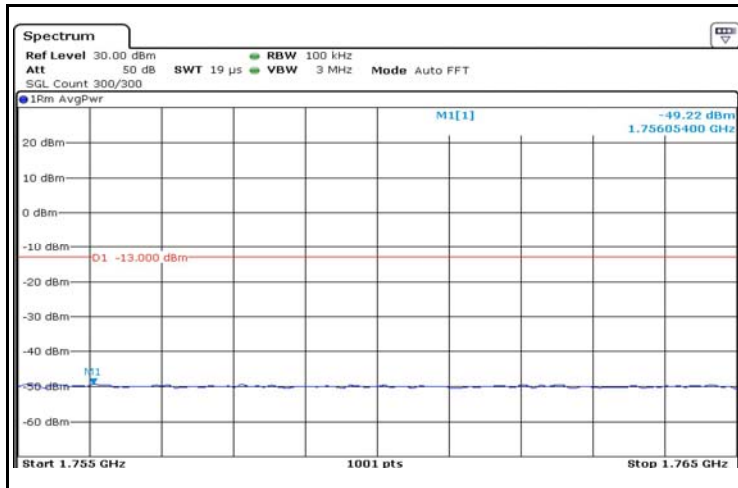

### Test Plot of Intermodulation

#### Output Signal of Downlink

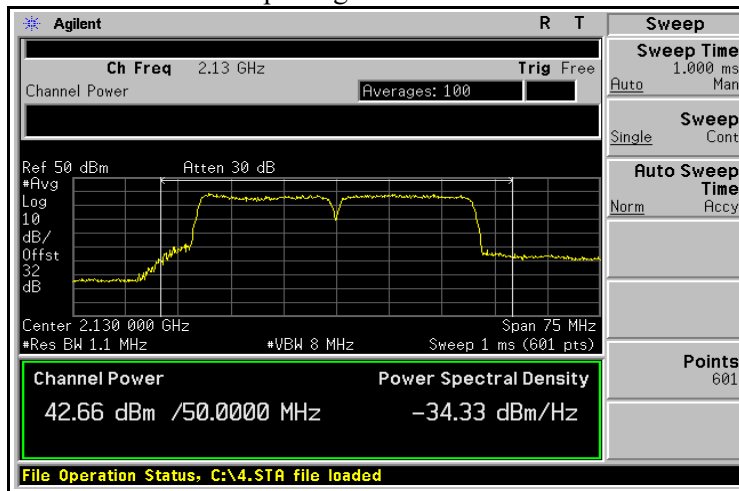

#### Output Signal of Uplink

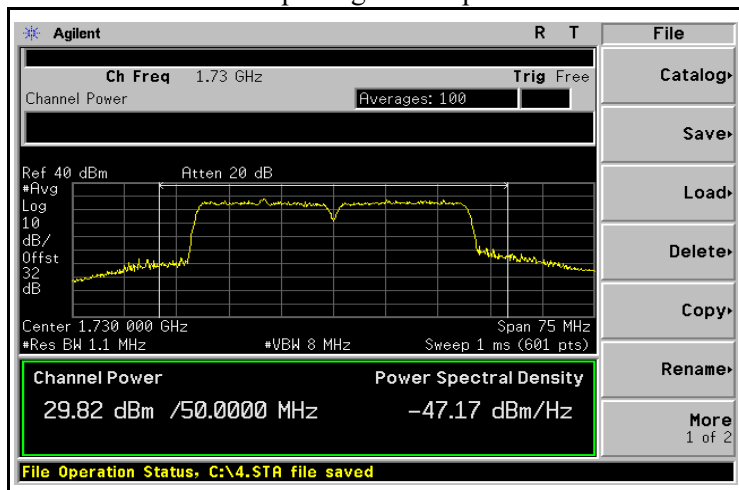

**Test results of Downlink**

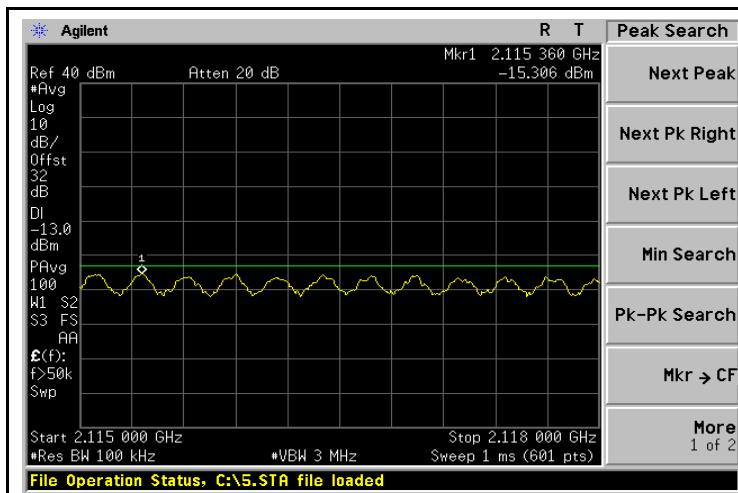
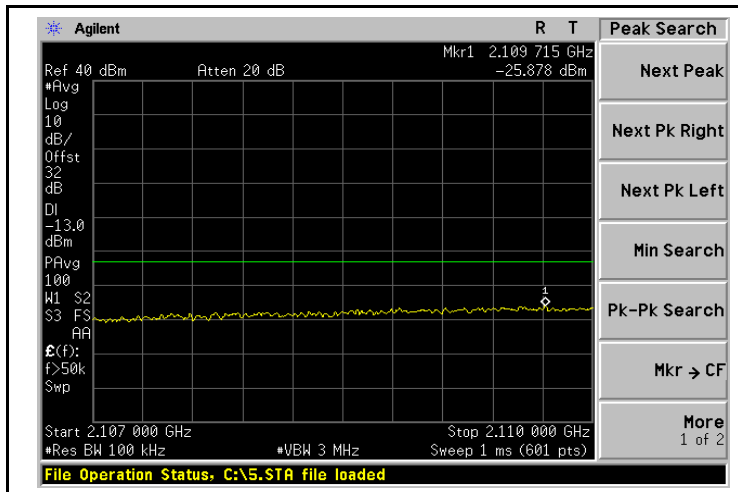



**Test results of Uplink**

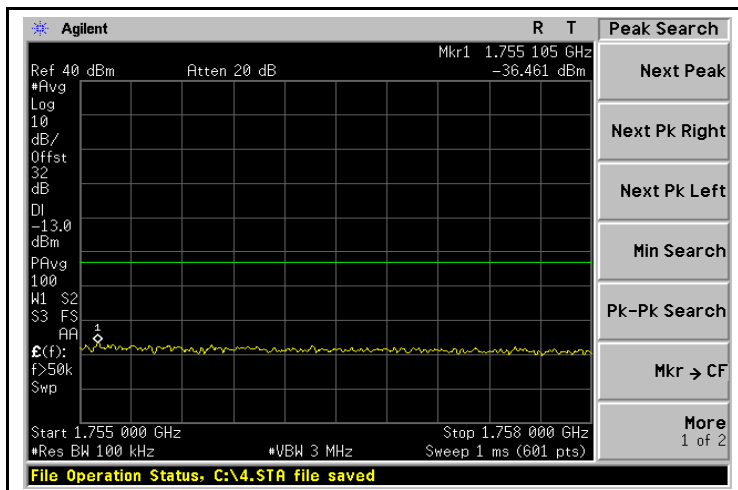
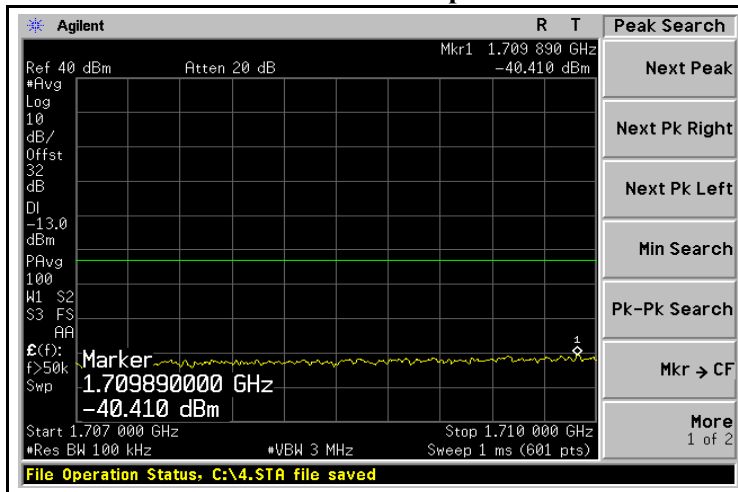

## 8. Radiated Spurious Emission

### 8.1 Test Procedure according to KDB935210 D5 3.4

This measurement is intended to produce test data necessary to demonstrate compliance to the radiated spurious emission requirements specified in Section 2.1053 of the FCC rules. This test is intended to capture any emissions that radiate directly from the case, cabinet, control circuits, etc., instead of via the antenna output port, and thus would not be captured in conducted spurious emission measurements. See KDB Publication 971168 [R8] for measurement procedure guidance.

### 8.2 Test Equipments

The following test equipments are used during tests

Equipment	Manufacturer	Model		Next Cal.
Spectrum Analyzer	ADVANTEST	R3273	110600592	2018-10-10
Signal Generator	ROHDE&SCHWARZ	SMBV100A	2566633	2018-12-26
TEST Receiver	ROHDE & SCHWARZ	ESCI7	100185	2018-10-31
Logbicon Antenna	SCHWARZBECK	VULB 9168	237	2018-10-31
PREAMPLIFIER	AGILENT	8449B	3008A00595	2018-10-31
Signal Generator	HP	E4432B	GB40050840	2018-12-26
Signal Generator	ROHDE & SCHWARZ	SMB 100A	177653	2018-12-26
Horn Antenna	SCHWARZBECK	BBHA 9120 D	469	2018-08-25
Loop Antenna	ROHDE&SCHWARZ	HFH2-Z2	100188	2018-08-22

### 8.3 Test Setup

Test setup for 30 MHz to 1 GHz

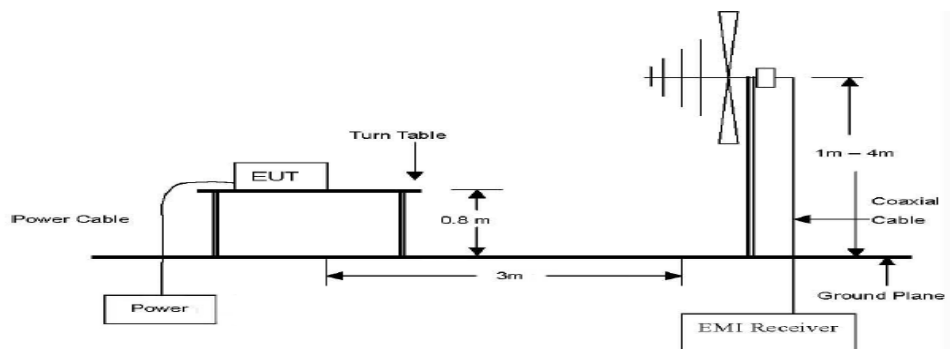

Test setup for above 1 GHz

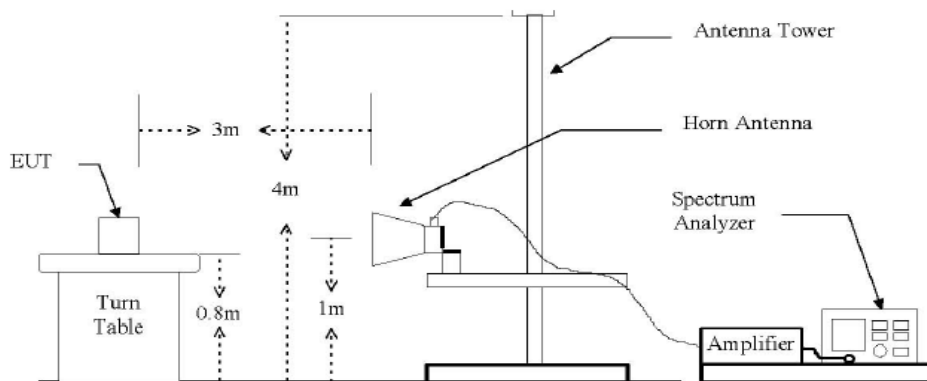



**8.4 Test Results : Pass**

**Downlink**

**9 kHz ~150 kHz**

Frequency (MHz)	Receiver Reading (dBuV)	Correction Factor(dB)		Total(dBm)		Limit(dBm)	Polarity
		AG(dBi)	CL(dB)	SG Reading	Result		
No Critical Peak							

**150 kHz ~30 MHz**

Frequency (MHz)	Receiver Reading (dBuV)	Correction Factor(dB)		Total(dBm)		Limit(dBm)	Polarity
		AG(dBd)	CL(dB)	SG Reading	Result		
No Critical Peak							

**30 MHz ~1 GHz**

Frequency (MHz)	Receiver Reading (dBuV)	Correction Factor(dB)		Total(dBm)		Limit(dBm)	Polarity
		AG(dBd)	CL(dB)	SG Reading	Result		
No Critical Peak							

**1 GHz ~26.5 GHz**

Frequency (MHz)	Receiver Reading (dBuV)	Correction Factor(dB)		Total(dBm)		Limit(dBm)	Polarity
		AG(dBd)	CL(dB)	SG Reading	Result		
No Critical Peak							



**Uplink**

**9 kHz ~150 kHz**

Frequency (MHz)	Receiver Reading (dBuV)	Correction Factor(dB)		Total(dBm)		Limit(dBm)	Polarity
		AG(dBi)	CL(dB)	SG Reading	Result		
No Critical Peak							

**150 kHz ~30 MHz**

Frequency (MHz)	Receiver Reading (dBuV)	Correction Factor(dB)		Total(dBm)		Limit(dBm)	Polarity
		AG(dBd)	CL(dB)	SG Reading	Result		
No Critical Peak							

**30 MHz ~1 GHz**

Frequency (MHz)	Receiver Reading (dBuV)	Correction Factor(dB)		Total(dBm)		Limit(dBm)	Polarity
		AG(dBd)	CL(dB)	SG Reading	Result		
No Critical Peak							

**1 GHz ~26.5 GHz**

Frequency (MHz)	Receiver Reading (dBuV)	Correction Factor(dB)		Total(dBm)		Limit(dBm)	Polarity
		AG(dBd)	CL(dB)	SG Reading	Result		
No Critical Peak							

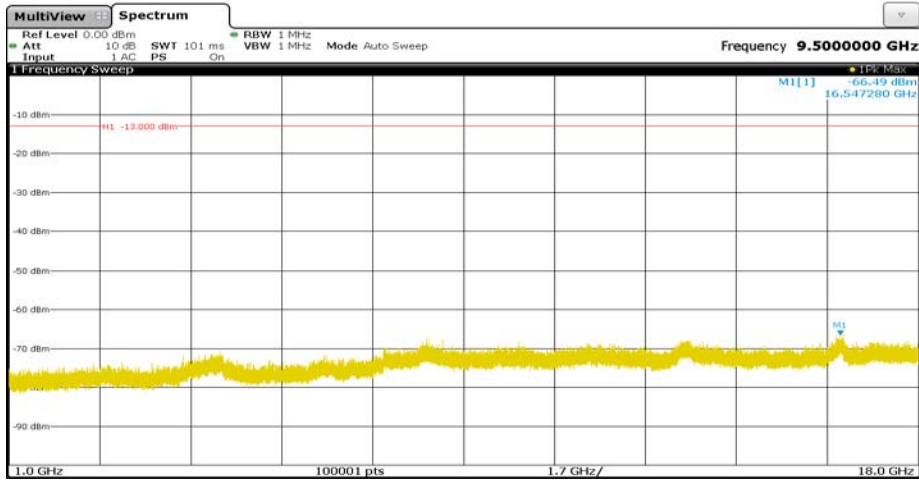
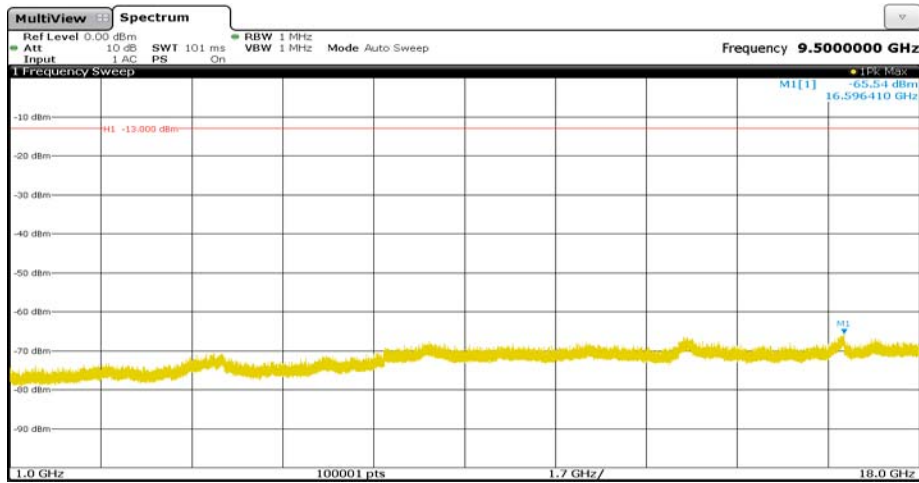



### Appendix 1. Uncertainty

Description	Frequency Range	Uncertainty
Conducted RF Output Power	25 to 7000 MHz	$\pm 0.45$ dB
Occupied Bandwidth	25 to 7000 MHz	$\pm 41$ kHz
Out of Band Rejection	25 to 7000 MHz	$\pm 0.48$ MHz
Spurious Emissions at Antenna Terminals	-	$\pm 1.31$ dB
Radiated Spurious Emissions	25 to 1000 MHz	$\pm 3.5$ dB
	1000 to 40000 MHz	$\pm 5.2$ dB