

TEST REPORT

FCC Test for SDR-AF
Class II Permissive Change

APPLICANT
ADRF KOREA, Inc.

REPORT NO.
HCT-RF-2301-FC032

DATE OF ISSUE
January 13, 2023

Tested by
Sang Su Lee



Technical Manager
Jong Seok Lee



HCT CO., LTD.
Bongjai Huh
BongJai Huh / CEO

HCT Co., Ltd.

74, Seoicheon-ro 578beon-gil, Majang-myeon, Icheon-si, Gyeonggi-do, 17383 KOREA
Tel. +82 31 634 6300 Fax. +82 31 645 6401

TEST REPORT

FCC Test for
SDR-AF

REPORT NO.
HCT-RF-2301-FC032

DATE OF ISSUE
January 13, 2023

Additional Model
-

Applicant **ADRF KOREA, Inc.**
5-5, Mojeon-Ri, Backsa-Myun, Icheon-Citi, Kyunggi-Do, Korea

Eut Type REPEATER
Model Name SDR-AF

FCC ID N52-SDR-AF

Output Power 33 dBm

Date of Test November 16, 2022 ~ January 13, 2023

FCC Rule Parts: CFR 47 Part 2, Part 27

The result shown in this test report refer only to the sample(s) tested unless otherwise stated.
This test results were applied only to the test methods required by the standard.

REVISION HISTORY

The revision history for this test report is shown in table.

Revision No.	Date of Issue	Description
0	January 13, 2023	Initial Release

The measurements shown in this report were made in accordance with the procedures indicated, and the emissions from this equipment were found to be within the limits applicable. I assume full responsibility for the accuracy and completeness of these measurements, and for the qualifications of all persons taking them. It is further stated that upon the basis of the measurements made, the equipment tested is capable of operation in accordance with the requirements of the FCC Rules under normal use and maintenance.

If this report is required to confirmation of authenticity, please contact to www.hct.co.kr

CONTENTS

1. GENERAL INFORMATION	5
1.1. APPLICANT INFORMATION	5
1.2. PRODUCT INFORMATION	5
1.3. TEST INFORMATION	5
2. FACILITIES AND ACCREDITATIONS	6
2.1. FACILITIES	6
2.2. EQUIPMENT	6
3. TEST SPECIFICATIONS	7
3.1. STANDARDS	7
3.2. ADDITIONAL DESCRIPTIONS ABOUT TEST	8
3.3. MEASUREMENT UNCERTAINTY	10
3.4. STANDARDS ENVIRONMENTAL TEST CONDITIONS	10
3.5. TEST DIAGRAMS	11
4. TEST EQUIPMENTS	12
5. TEST RESULT	13
5.1. AGC THRESHOLD	13
5.2. OUT-OF-BAND REJECTION	15
5.3. INPUT-VERSUS-OUTPUT SIGNAL COMPARISON	17
5.4. INPUT/OUTPUT POWER AND AMPLIFIER/BOOSTER GAIN	24
5.5. OUT-OF-BAND/OUT-OF-BLOCK EMISSIONS AND SPURIOUS EMISSIONS	31
5.6. RADIATED SPURIOUS EMISSIONS	51
5.7. FREQUENCY STABILITY	56
6. Annex A_EUT AND TEST SETUP PHOTO	60

1. GENERAL INFORMATION

1.1. APPLICANT INFORMATION

Company Name	ADRF KOREA, Inc.
Company Address	5-5, Mojeon-Ri, Backsa-Myun, Icheon-Citi, Kyunggi-Do, Korea

1.2. PRODUCT INFORMATION

EUT Type	REPEATER		
EUT Serial Number	SDR33-AF22XXXX		
Power Supply	100-130 VAC or 210~240 VAC, 50/60 Hz / 24 VDC		
Frequency Range	Band Name	Uplink (MHz)	Downlink (MHz)
	AWS	1 710 ~ 1 755	2 110 ~ 2 180
Tx Output Power	33 dBm		
Antenna Peak Gain	*Uplink: -4.9 dBi Downlink: 3 dBi		

*19.1 dBi - 24 dB = -4.9 dBi (Total Antenna Peak Gain = Antenna Peak Gain + Cable Loss)

1.3. TEST INFORMATION

FCC Rule Parts	CFR 47 Part 2, Part 27
Measurement Standards	KDB 935210 D05 v01r04, ANSI C63.26-2015, KDB 971168 D01 v03r01
Test Location	HCT CO., LTD. 74, Seoicheon-ro 578beon-gil, Majang-myeon, Icheon-si, Gyeonggi-do, 17383, Rep. of KOREA

2. FACILITIES AND ACCREDITATIONS

2.1. FACILITIES

The SAC(Semi-Anechoic Chamber) and conducted measurement facility used to collect the radiated data are located at the 74, Seoicheon-ro 578beon-gil, Majang-myeon, Icheon-si, Gyeonggi-do, 17383, Rep. of KOREA.

The site is constructed in conformance with the requirements of ANSI C63.4 (Version: 2014) and CISPR Publication 22.

Detailed description of test facility was submitted to the Commission and accepted dated April 02, 2018 (Registration Number: KR0032).

2.2. EQUIPMENT

Radiated emissions are measured with one or more of the following types of linearly polarized antennas: tuned dipole, bi-conical, log periodic, bi-log, and/or ridged waveguide, horn. Spectrum analyzers with pre-selectors and quasi-peak detectors are used to perform radiated measurements.

Calibrated wideband preamplifiers, coaxial cables, and coaxial attenuators are also used for making measurements.

All receiving equipment conforms to CISPR Publication 16-1, "Radio Interference Measuring Apparatus and Measurement Methods."

3. TEST SPECIFICATIONS

3.1. STANDARDS

The following tests were conducted on a sample of the equipment for the purpose of demonstrating compliance with FCC Part 2 and Part 27.

Description	Reference	Results
AGC threshold	KDB 935210 D05 v01r04 3.2	Compliant
Out-of-band rejection	KDB 935210 D05 v01r04 3.3	Compliant
Input-versus-output signal comparison	§ 2.1049	Compliant
Input/output power and amplifier/booster gain	§ 2.1046, § 27.50 (d)	Compliant
Out-of-band/out-of-block emissions and spurious emissions	§ 2.1051, § 27.53 (h)	Compliant
Spurious emissions radiated	§ 2.1053, § 27.53 (h)	Compliant
Frequency Stability	§ 2.1055 § 27.54	Compliant

3.2. ADDITIONAL DESCRIPTIONS ABOUT TEST

Except for the following cases, EUT was tested under normal operating conditions.

: Out-of-band rejection test requires maximum gain condition without AGC.

The test was generally based on the method of KDB 935210 D05 v01r04 and only followed ANSI C63.26-2015 if there was no test method in KDB standard.

EUT was tested with following modulated signals provide by applicant.

Band Name	Tested signals
AWS	5G NR 20 MHz

All power supplies of operation were investigated and the worst case configuration results are reported.

- Mode: 100~130 VAC or 210~240 VAC, 50/60 Hz / 24 VDC

- Worst case: 100~130 VAC or 210~240 VAC, 50/60 Hz

The tests results included actual loss value for attenuator and cable combination as shown in the table below.

: Input Path

Correction factor table			
Frequency (MHz)	Factor (dB)	Frequency (MHz)	Factor (dB)
1 500	1.289	2 250	1.566
1 550	1.330	2 300	1.467
1 600	1.424	2 350	1.384
1 650	1.349	2 400	1.504
1 700	1.560	2 450	1.307
1 750	1.577	2 500	1.373
1 800	1.650	2 550	1.434
1 850	1.668	2 600	1.244
1 900	1.685	2 650	1.619
1 950	1.900	2 700	1.165
2 000	1.893	2 750	1.461
2 050	1.786	2 800	1.547
2 100	1.959	2 850	1.467
2 150	1.732	2 900	1.520
2 200	1.635	-	-

: Output Path

Correction factor table

Frequency (MHz)	Factor (dB)	Frequency (MHz)	Factor (dB)
2	30.547	6 500	32.871
10	29.555	7 000	33.234
20	29.558	7 500	33.204
30	29.333	8 000	33.782
40	29.439	8 500	33.348
50	29.473	9 000	33.272
100	29.320	9 500	33.142
200	30.001	10 000	33.195
300	29.871	11 000	34.278
400	30.017	12 000	34.561
500	30.454	13 000	34.791
600	30.178	14 000	34.920
700	30.269	15 000	35.375
800	30.339	16 000	35.724
900	30.622	17 000	36.466
1 000	30.716	18 000	36.622
1 200	30.859	19 000	36.510
1 400	30.848	20 000	37.091
1 600	31.089	21 000	37.383
1 800	31.461	22 000	39.794
2 000	31.535	23 000	38.790
2 500	31.142	24 000	39.754
3 000	31.686	25 000	39.684
3 500	31.859	26 000	38.648
4 000	31.917	26 500	42.920
4 500	32.340	-	-
5 000	32.424	-	-
5 500	32.372	-	-
6 000	32.630	-	-

3.3. MEASUREMENT UNCERTAINTY

Description	Condition	Uncertainty
Radiated Disturbance	9 kHz ~ 30 MHz	± 3.40 dB
	30 MHz ~ 1 GHz	± 4.80 dB
	1 GHz ~ 18 GHz	± 5.70 dB
	18 GHz ~ 40 GHz	± 5.05 dB

* Coverage factor k = 2, Confidence levels of 95 %

3.4. STANDARDS ENVIRONMENTAL TEST CONDITIONS

Temperature	+15 °C to +35 °C
Relative humidity	30 % to 60 %
Air pressure	860 mbar to 1 060 mbar

3.5. TEST DIAGRAMS

Conducted Test

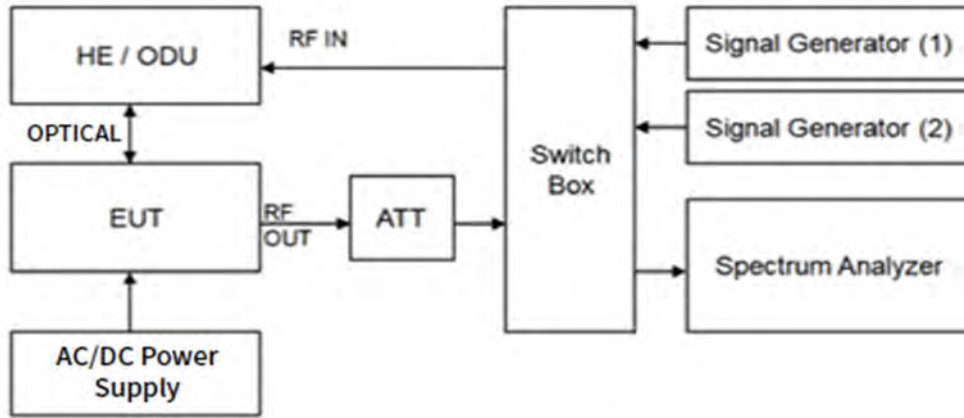

Radiated Test

30 MHz ~ 1 GHz

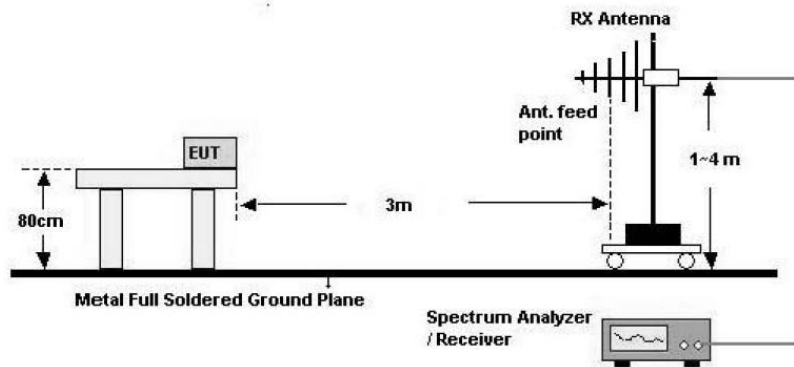

Above 1 GHz

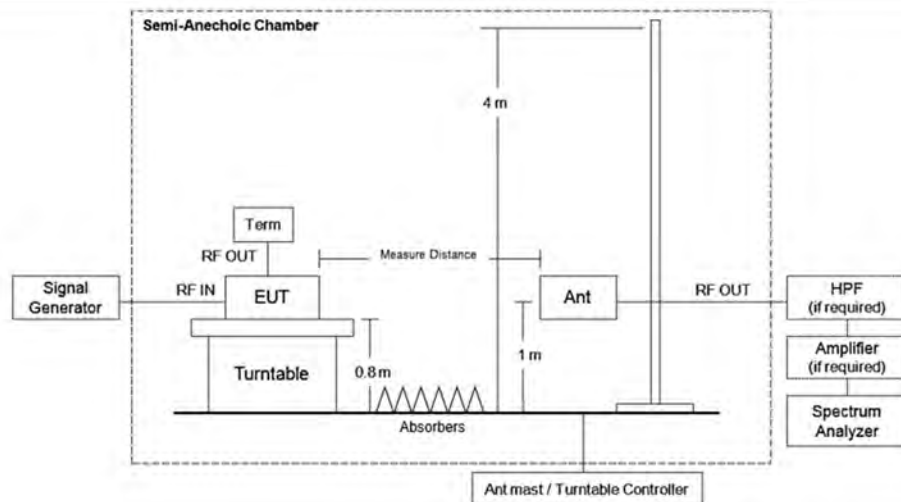

※ EUT position is adopted by placement of floor-standing refer to section 5.5.2.3.2 of ANSI C63.26-2015

4. TEST EQUIPMENTS

Equipment	Model	Manufacturer	Serial No.	Due to Calibration	Calibration Interval
MXA Signal Analyzer	N9020A	Keysight	MY46471250	07/22/2023	Annual
PXA Signal Analyzer	N9030A	Keysight	MY49431434	01/05/2023	Annual
MXG Vector Signal Generator	N5182A	Agilent	MY50140312	08/18/2023	Annual
MXG Vector Signal Generator	N5182A	Agilent	MY50141649	08/16/2023	Annual
30 dB Attenuator	WA93-30-33	Weinschel Associates	0190	03/28/2023	Annual
50Ω Termination	908A	H.P.	N/A	N/A	N/A
AC Power Supply	PCR2000MA	KIKUSUI	ZL002530	01/03/2023	Annual
Switch	S46-SV11	KEITHLEY	1035126	N/A	N/A
Controller (Antenna Mast & Turn Table)	CO3000	Innco systems	CO3000/1251/48920320/P	N/A	N/A
Antenna Position Tower	MA4640/800-XP-EP	Innco system	N/A	N/A	N/A
Turn Table	DS2000-S	Innco systems	N/A	N/A	N/A
Turn Table	Turn Table	Ets	N/A	N/A	N/A
Amp & Filter Bank Switch Controller	FBSM-01B	TNM system	TM20090002	N/A	N/A
Loop Antenna	FMZB 1513	Schwarzbeck	1513-333	03/17/2024	Biennial
Trilog Super Broadband Antenna	VULB 9168	Schwarzbeck	9168-0895	08/16/2024	Biennial
Horn Antenna	BBHA 9120D	Schwarzbeck	02296	05/18/2024	Biennial
Horn Antenna	BBHA 9170	Schwarzbeck	BBHA9170342	09/29/2024	Biennial
HPF (3 ~ 18 GHz) + LNA(0.1 ~ 18 GHz)	FBSR-04C	TNM system	N/A	08/23/2023	Annual
Low Noise Amplifier	LLAU1183540Q	LTC Microwave	100	08/23/2023	Annual
Low Noise Amplifier	TK-PA1840H	TESTEK	170011-L	10/24/2023	Annual
High Pass Filter	WHKX12-2805-3000-18000-40SS	Wainwright Instruments	45	08/23/2023	Annual

Note:

1. Equipment listed above that calibrated during the testing period was set for test after the calibration.
2. Equipment listed above that has a calibration due date during the testing period, the testing is completed before equipment expiration date.

5. TEST RESULT

5.1. AGC THRESHOLD

Test Requirement:

KDB 935210 D05 v01r04

Testing at and above the AGC threshold is required.

Test Procedures:

Measurements were in accordance with the test methods section 3.2 of KDB 935210 D05 v01r04.

In the case of fiber-optic distribution systems, the RF input port of the equipment under test (EUT) refers to the RF input of the supporting equipment RF to optical convertor; see also descriptions and diagrams for typical DAS booster systems in KDB Publication 935210 D02

Devices intended to be directly connected to an RF source (donor port) only need to be evaluated for any over-the-air transmit paths.

- a) Connect a signal generator to the input of the EUT.
- b) Connect a spectrum analyzer or power meter to the output of the EUT using appropriate attenuation as necessary.
- c) The signal generator should initially be configured to produce either of the required test signals.
- d) Set the signal generator frequency to the center frequency of the EUT operating band.
- e) While monitoring the output power of the EUT, measured using the methods of ANSI C63.26-2015 subclause 5.2.4.4.1, increase the input level until a 1 dB increase in the input signal power no longer causes a 1 dB increase in the output signal power.
- f) Record this level as the AGC threshold level.
- g) Repeat the procedure with the remaining test signal.

Output power measurement in subclause 5.2.4.4.1 of ANSI C63.26

- a) Set span to $2 \times$ to $3 \times$ the OBW.
- b) Set RBW = 1% to 5% of the OBW.
- c) Set VBW $\geq 3 \times$ RBW.
- d) Set number of measurement points in sweep $\geq 2 \times$ span / RBW.
- e) Sweep time: auto-couple
- f) Detector = power averaging (rms).
- g) If the EUT can be configured to transmit continuously, then set the trigger to free run.
- h) Omit
- i) Trace average at least 100 traces in power averaging (rms) mode if sweep is set to auto-couple. To accurately determine the average power over multiple symbols, it can be necessary to increase the number of traces to be averaged above 100 or, if using a manually configured sweep time, increase the sweep time.

- j) Compute the power by integrating the spectrum across the OBW of the signal using the instrument's band or channel power measurement function, with the band/channel limits set equal to the OBW band edges. If the instrument does not have a band or channel power function, then sum the spectrum levels (in linear power units) at intervals equal to the RBW extending across the entire OBW of the spectrum.

Test Results:

Test Band	Link	Signal	Center Frequency (MHz)	AGC Threshold Level (dBm)	Output Level (dBm)
AWS	Uplink	5G NR 20 MHz	1 732.50	-62	32.87
	Downlink	5G NR 20 MHz	2 145.00	-62	32.94

5.2. OUT-OF-BAND REJECTION

Test Requirement:

KDB 935210 D05 v01r04

Out-of-band rejection required.

Test Procedures:

Measurements were in accordance with the test methods section 3.3 of KDB 935210 D05 v01r04.

A signal booster shall reject amplification of other signals outside of its passband. Adjust the internal gain control of the EUT (if so equipped) to the maximum gain for which equipment certification is sought.

- a) Connect a signal generator to the input of the EUT.
- b) Configure a swept CW signal with the following parameters:
 - 1) Frequency range = $\pm 250\%$ of the passband, for each applicable CMRS band.
 - 2) Level = a sufficient level to affirm that the out-of-band rejection is > 20 dB above the noise floor and will not engage the AGC during the entire sweep.
 - 3) Dwell time = approximately 10 ms.
 - 4) Number of points = $\text{SPAN}/(\text{RBW}/2)$.
- c) Connect a spectrum analyzer to the output of the EUT using appropriate attenuation.
- d) Set the span of the spectrum analyzer to the same as the frequency range of the signal generator.
- e) Set the resolution bandwidth (RBW) of the spectrum analyzer to be 1 % to 5 % of the EUT passband, and the video bandwidth (VBW) shall be set to $\geq 3 \times \text{RBW}$.
- f) Set the detector to Peak Max-Hold and wait for the spectrum analyzer's spectral display to fill.
- g) Place a marker to the peak of the frequency response and record this frequency as f_0 .
- h) Place two markers, one at the lowest and the other at the highest frequency of the envelope of the spectral display, such that each marker is at or slightly below the -20 dB down amplitude, to determine the 20 dB bandwidth.
- i) Capture the frequency response of the EUT.
- j) Repeat for all frequency bands applicable for use by the EUT.

Test Results:

AWS / Uplink

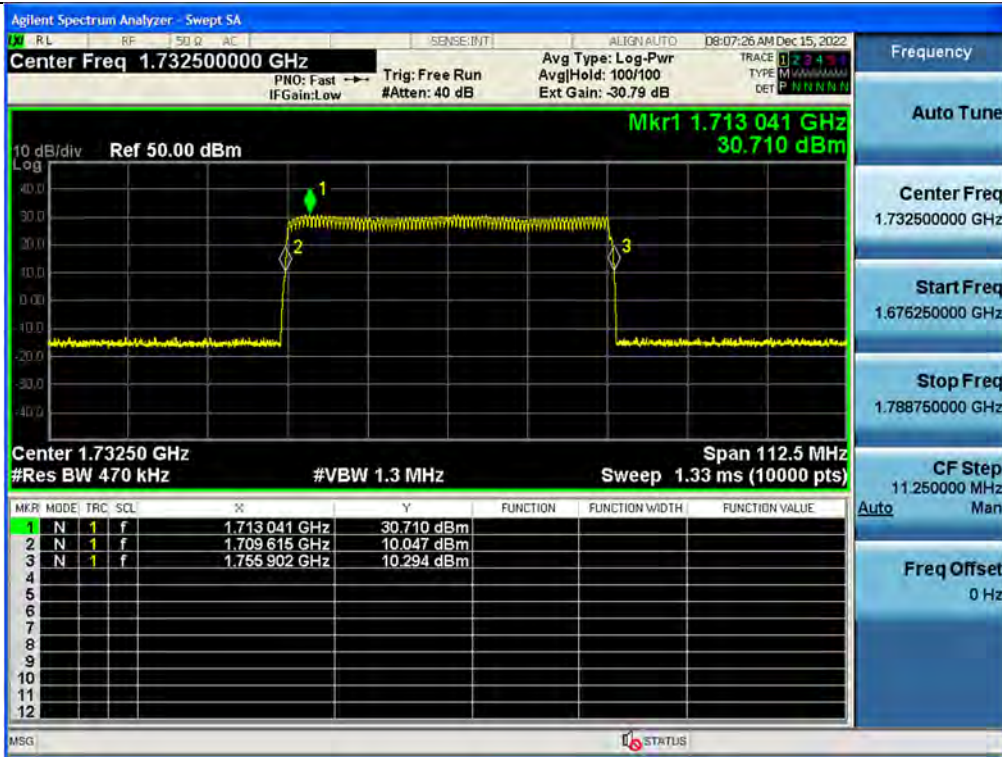

AWS / Downlink

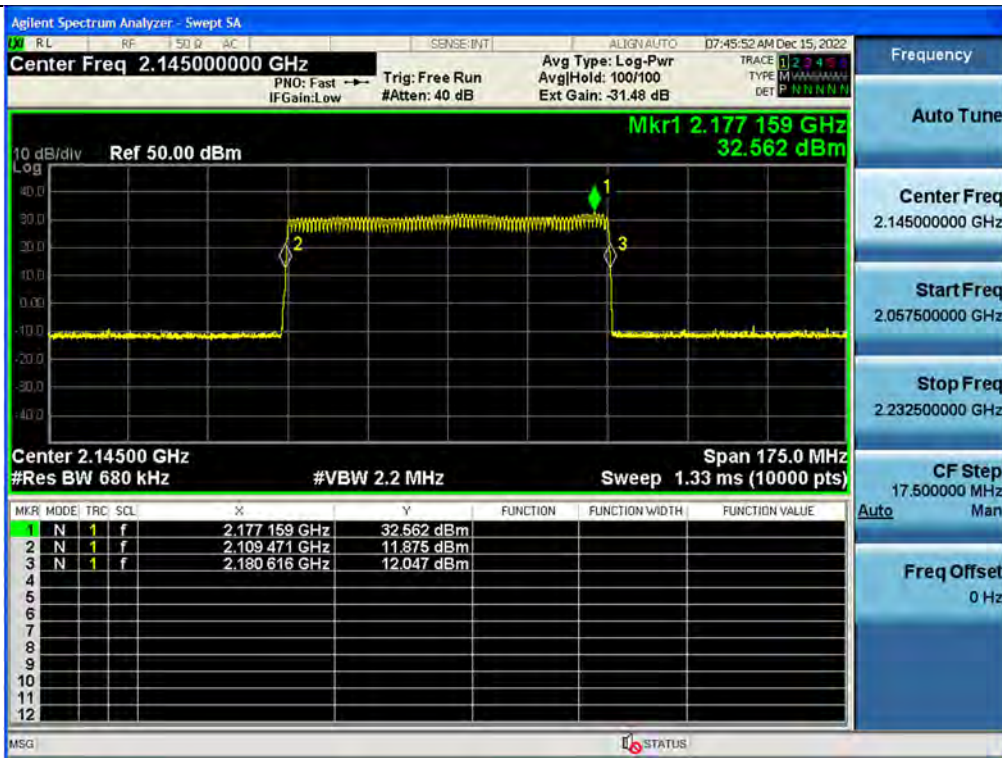

5.3. INPUT-VERSUS-OUTPUT SIGNAL COMPARISON

Test Requirement:

§ 2.1049 Measurements required: Occupied bandwidth.

The occupied bandwidth, that is the frequency bandwidth such that, below its lower and above its upper frequency limits, the mean powers radiated are each equal to 0.5 percent of the total mean power radiated by a given emission shall be measured under the specified conditions of § 2.1049 (a) through (i) as applicable.

Test Procedures:

Measurements were in accordance with the test methods section 3.4 of KDB 935210 D05 v01r04.

A 26 dB bandwidth measurement shall be performed on the input signal and the output signal; alternatively, the 99% OBW can be measured and used. See KDB Publication 971168 [R8] for more information on measuring OBW.

- a) Connect a signal generator to the input of the EUT.
- b) Configure the signal generator to transmit the AWGN signal.
- c) Configure the signal amplitude to be just below the AGC threshold level (see 3.2), but not more than 0.5 dB below.
- d) Connect a spectrum analyzer to the output of the EUT using appropriate attenuation.
- e) Set the spectrum analyzer center frequency to the center frequency of the operational band under test. The span range of the spectrum analyzer shall be between 2 times to 5 times the emission bandwidth (EBW) or alternatively, the OBW.
- f) The nominal RBW shall be in the range of 1 % to 5 % of the anticipated OBW, and the VBW shall be $\geq 3 \times$ RBW.
- g) Set the reference level of the instrument as required to preclude the signal from exceeding the maximum spectrum analyzer input mixer level for linear operation. In general, the peak of the spectral envelope must be more than $[10 \log (\text{OBW} / \text{RBW})]$ below the reference level. Steps f) and g) may require iteration to enable adjustments within the specified tolerances.
- h) The noise floor of the spectrum analyzer at the selected RBW shall be at least 36 dB below the reference level.
- i) Set spectrum analyzer detection function to positive peak.
- j) Set the trace mode to max hold.
- k) Determine the reference value: Allow the trace to stabilize. Set the spectrum analyzer marker to the highest amplitude level of the displayed trace (this is the reference value) and record the associated frequency.
- l) Place two markers, one at the lowest and the other at the highest frequency of the envelope of the spectral display, such that each marker is at or slightly below the -26 dB down amplitude. The 26 dB EBW (alternatively OBW) is the positive frequency difference between the two markers. If the spectral envelope crosses the -26 dB down amplitude at multiple points, the lowest or highest frequency shall be selected as the frequencies that are the furthest removed from the center frequency at which the spectral envelope crosses the -26 dB down amplitude point.
- m) Repeat steps e) to l) with the input signal connected directly to the spectrum analyzer (i.e., input signal

measurement).

- n) Compare the spectral plot of the input signal (determined from step m) to the output signal (determined from step l) to affirm that they are similar (in passband and rolloff characteristic features and relative spectral locations), and include plot(s) and descriptions in test report.
- o) Repeat the procedure [steps e) to n)] with the input signal amplitude set to 3 dB above the AGC threshold.
- p) Repeat steps e) to o) with the signal generator set to the narrowband signal.
- q) Repeat steps e) to p) for all frequency bands authorized for use by the EUT.

Test Results:

Tabular data of Output Occupied Bandwidth

Test Band	Link	Signal	Center Frequency (MHz)	99 % OBW (MHz)	26 dB OBW (MHz)
AWS	Uplink	5G NR 20 MHz	1 732.50	18.239	19.462
	Downlink	5G NR 20 MHz	2 145.00	18.240	19.415

Tabular data of Input Occupied Bandwidth

Test Band	Link	Signal	Center Frequency (MHz)	99 % OBW (MHz)	26 dB OBW (MHz)
AWS	Uplink	5G NR 20 MHz	1 732.50	18.296	19.424
	Downlink	5G NR 20 MHz	2 145.00	18.320	19.428

Tabular data of 3 dB above the AGC threshold Output Occupied Bandwidth

Test Band	Link	Signal	Center Frequency (MHz)	99 % OBW (MHz)	26 dB OBW (MHz)
AWS	Uplink	5G NR 20 MHz	1 732.50	18.248	19.347
	Downlink	5G NR 20 MHz	2 145.00	18.245	19.418

Tabular data of 3 dB above the AGC threshold Input Occupied Bandwidth

Test Band	Link	Signal	Center Frequency (MHz)	99 % OBW (MHz)	26 dB OBW (MHz)
AWS	Uplink	5G NR 20 MHz	1 732.50	18.271	19.370
	Downlink	5G NR 20 MHz	2 145.00	18.288	19.426

Measured Occupied Bandwidth Comparison

Test Band	Link	Signal	Variant of Input and output Occupied Bandwidth (%)	Variant of Input and 3 dB above the AGC threshold output Occupied Bandwidth (%)
AWS	Uplink	5G NR 20 MHz	0.196	-0.119
	Downlink	5G NR 20 MHz	-0.067	-0.041

* Change in input-output OBW is less than $\pm 5\%$.

Plot data of Occupied Bandwidth

Output / AWS / Uplink / 5G NR 20 MHz

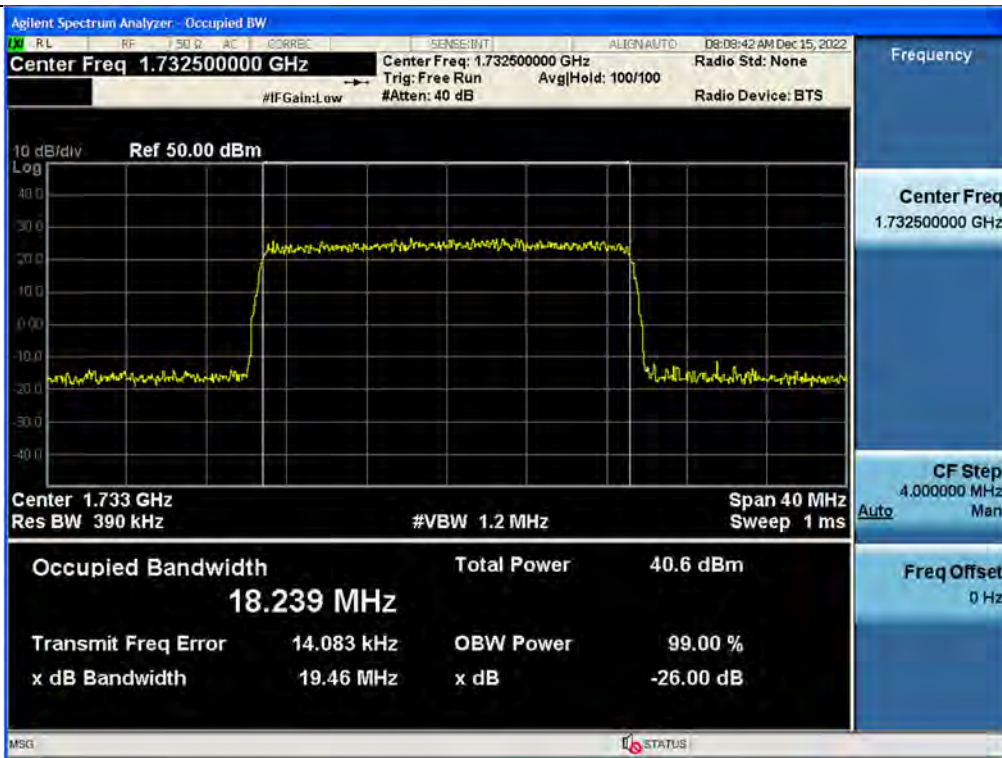

Input / AWS / Uplink / 5G NR 20 MHz

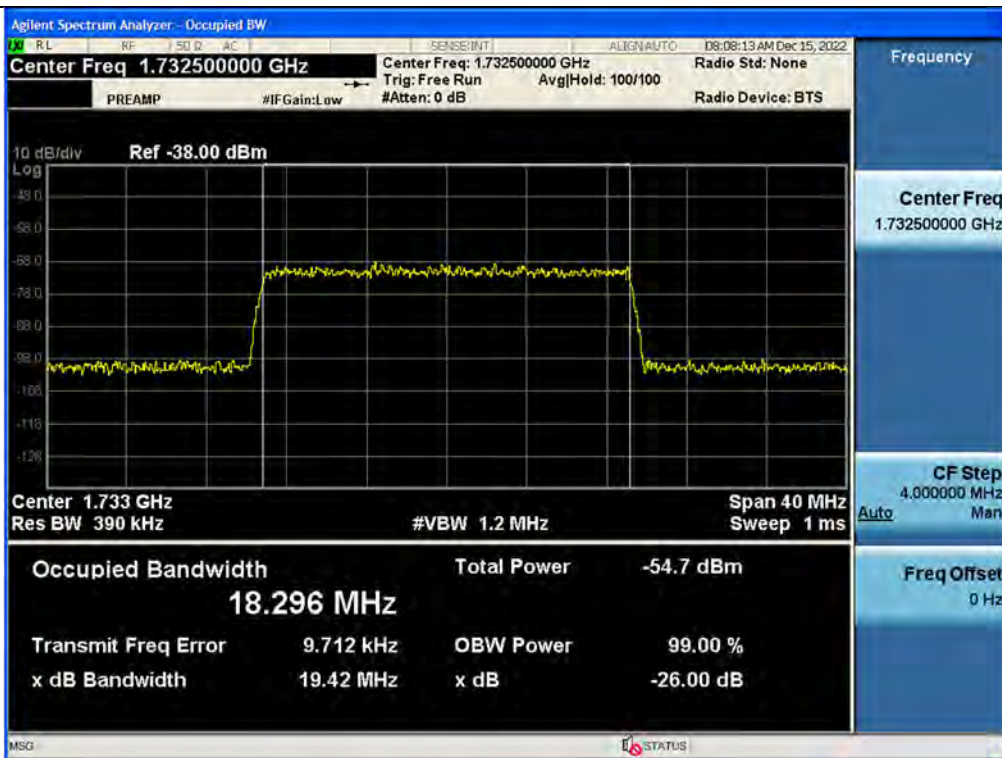

3 dB above the AGC threshold output / AWS / Uplink / 5G NR 20 MHz

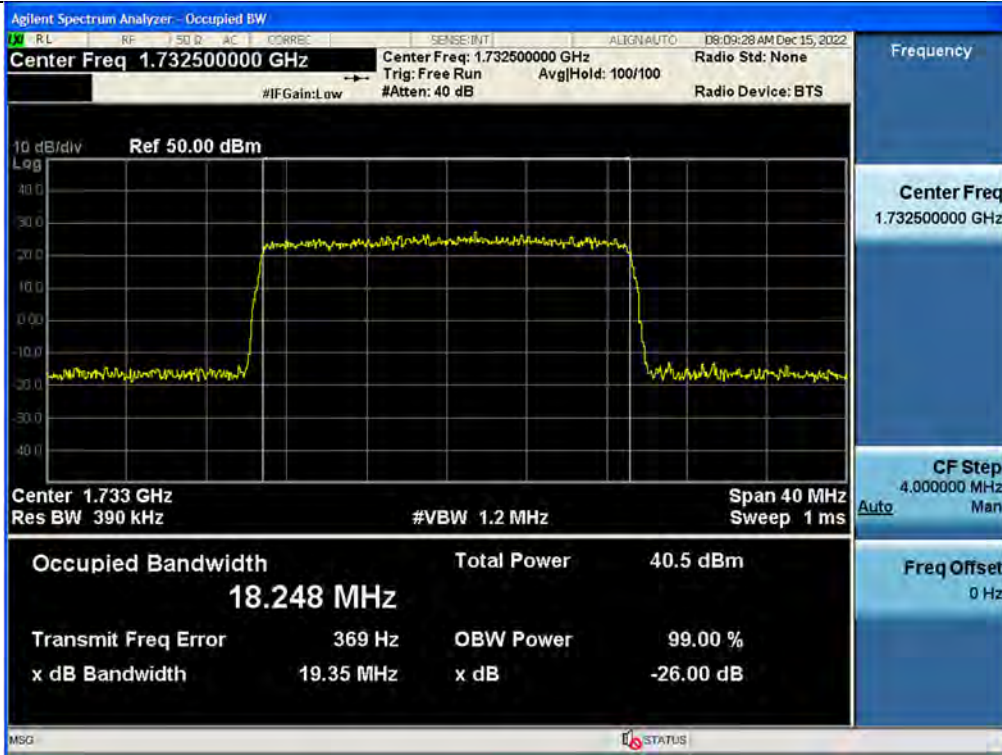

3 dB above the AGC threshold Input / AWS / Uplink / 5G NR 20 MHz

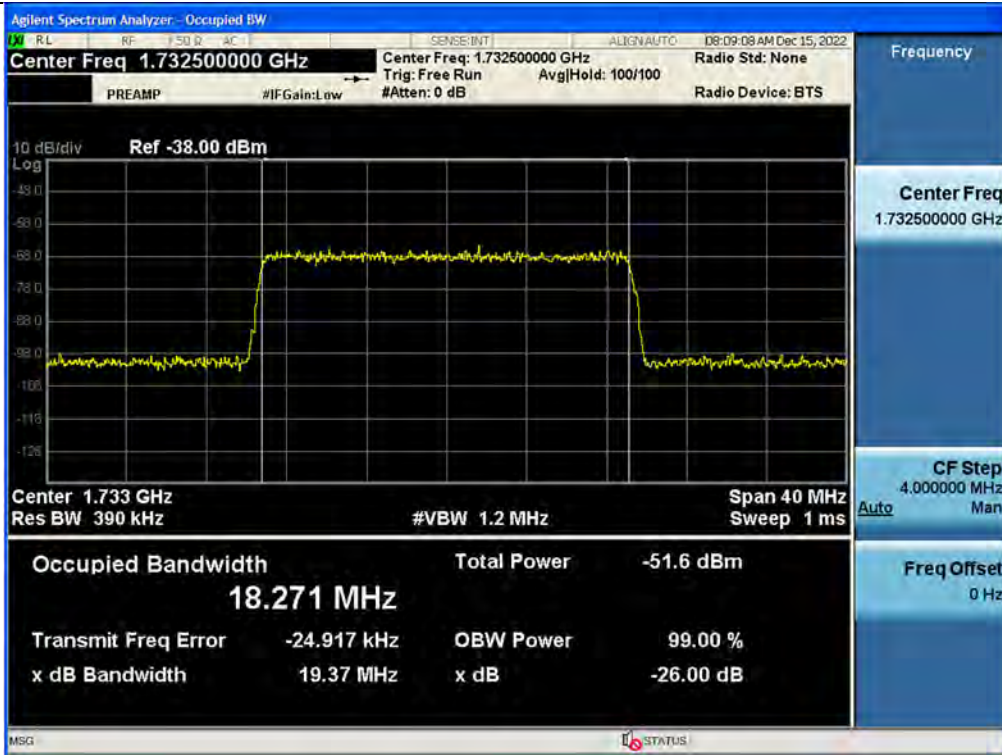

Output / AWS / Downlink / 5G NR 20 MHz

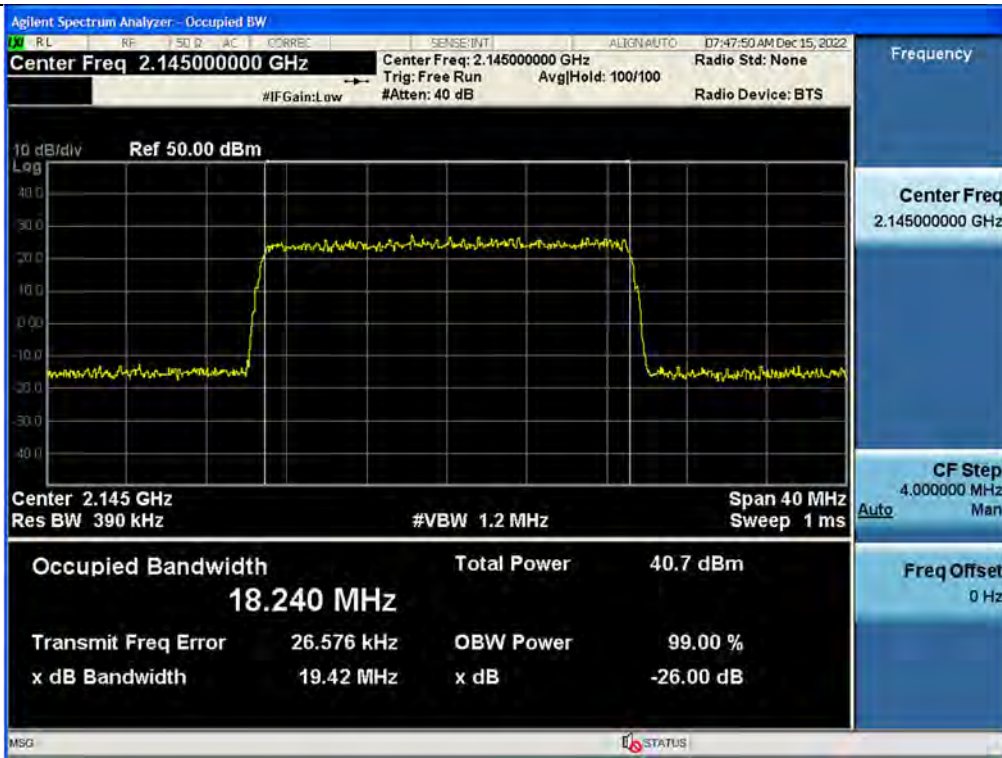

Input / AWS / Downlink / 5G NR 20 MHz

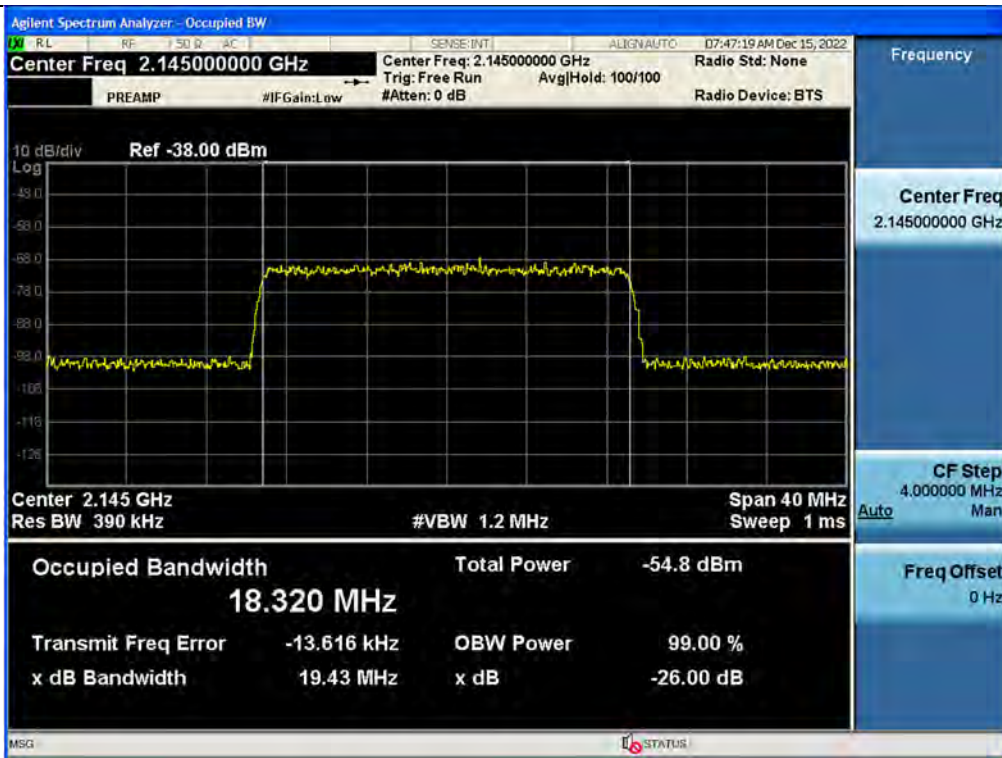

3 dB above the AGC threshold output / AWS / Downlink / 5G NR 20 MHz

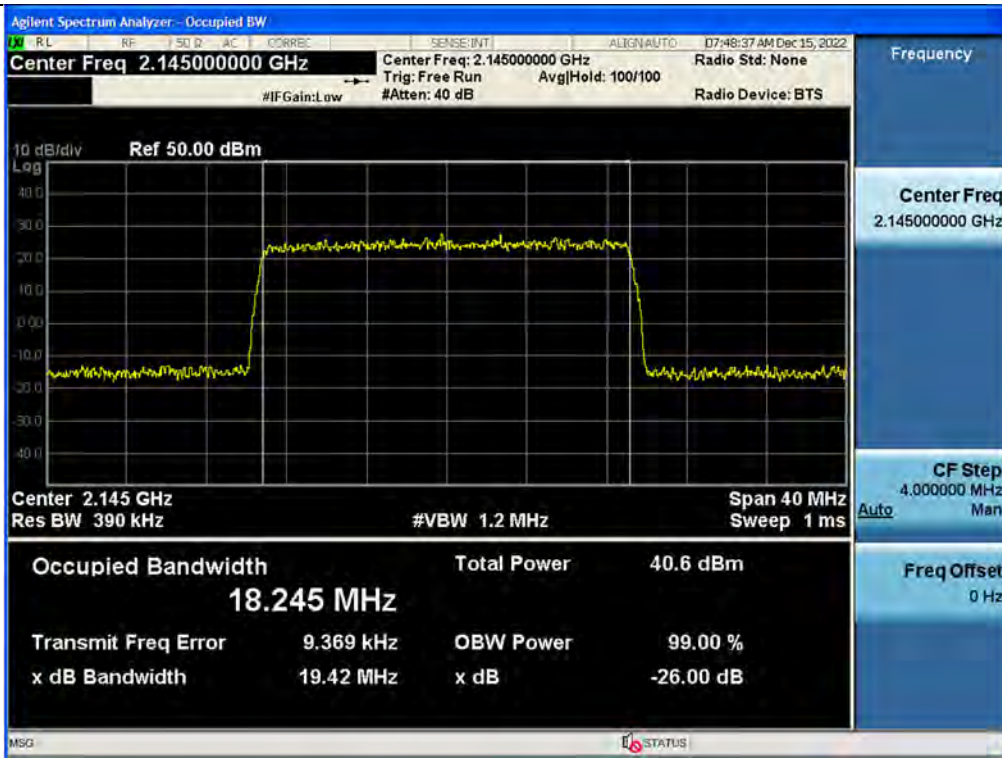

3 dB above the AGC threshold Input / AWS / Downlink / 5G NR 20 MHz

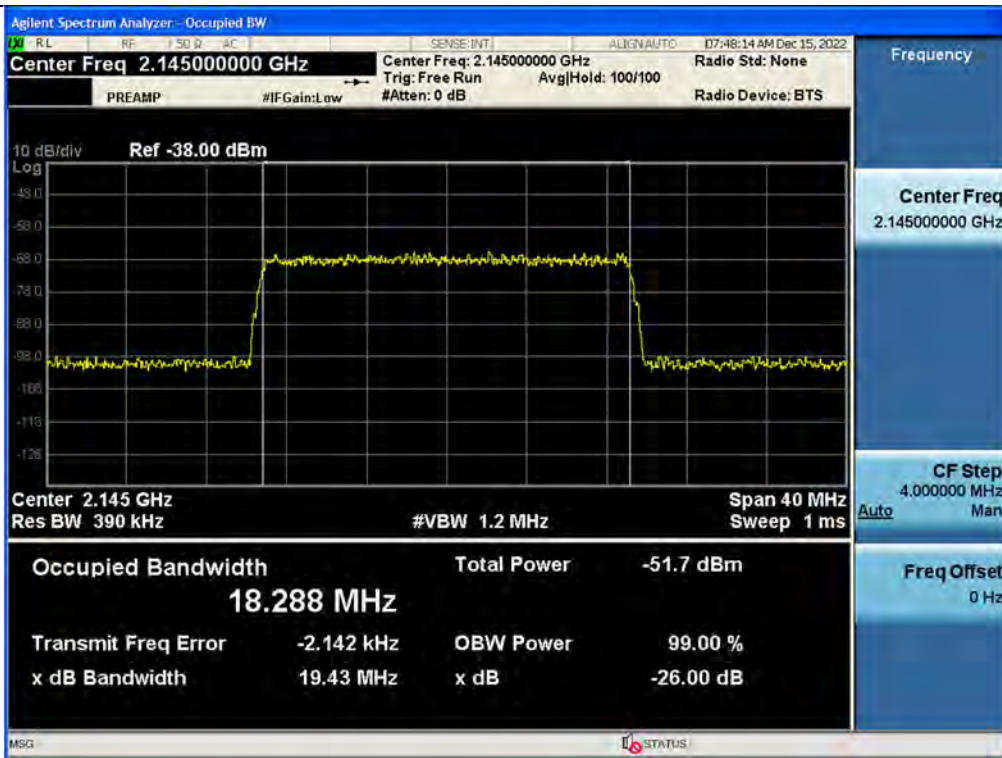

5.4. INPUT/OUTPUT POWER AND AMPLIFIER/BOOSTER GAIN

Test Requirement:

§ 2.1046 Measurements required: RF power output.

- (a) For transmitters other than single sideband, independent sideband and controlled carrier radiotelephone, power output shall be measured at the RF output terminals when the transmitter is adjusted in accordance with the tune-up procedure to give the values of current and voltage on the circuit elements specified in § 2.1033(c)(8). The electrical characteristics of the radio frequency load attached to the output terminals when this test is made shall be stated.
- (b) For single sideband, independent sideband, and single channel, controlled carrier radiotelephone transmitters the procedure specified in paragraph (a) of this section shall be employed and, in addition, the transmitter shall be modulated during the test as specified and applicable in § 2.1046 (b) (1-5). In all tests, the input level of the modulating signal shall be such as to develop rated peak envelope power or carrier power, as appropriate, for the transmitter.
- (c) For measurements conducted pursuant to paragraphs (a) and (b) of this section, all calculations and methods used by the applicant for determining carrier power or peak envelope power, as appropriate, on the basis of measured power in the radio frequency load attached to the transmitter output terminals shall be shown. Under the test conditions specified, no components of the emission spectrum shall exceed the limits specified in the applicable rule parts as necessary for meeting occupied bandwidth or emission limitations.

§ 27.50 Power limits and duty cycle.

- (d) The following power and antenna height requirements apply to stations transmitting in the 1695-1710 MHz, 1710-1755 MHz, 1755-1780 MHz, 1915-1920 MHz, 1995-2000 MHz, 2000-2020 MHz, 2110-2155 MHz, 2155-2180 MHz and 2180-2200 MHz bands:
- (1) The power of each fixed or base station transmitting in the 1995-2000 MHz, 2110-2155 MHz, 2155-2180 MHz or 2180-2200 MHz band and located in any county with population density of 100 or fewer persons per square mile, based upon the most recently available population statistics from the Bureau of the Census, is limited to:
 - (i) An equivalent isotropically radiated power (EIRP) of 3280 watts when transmitting with an emission bandwidth of 1 MHz or less;
 - (ii) An EIRP of 3280 watts/MHz when transmitting with an emission bandwidth greater than 1 MHz.
 - (2) The power of each fixed or base station transmitting in the 1995-2000 MHz, the 2110-2155 MHz 2155-2180 MHz band, or 2180-2200 MHz band and situated in any geographic location other than that described in paragraph (d)(1) of this section is limited to:
 - (i) An equivalent isotropically radiated power (EIRP) of 1640 watts when transmitting with an emission bandwidth of 1 MHz or less;
 - (ii) An EIRP of 1640 watts/MHz when transmitting with an emission bandwidth greater than 1 MHz.
 - (3) A licensee operating a base or fixed station in the 2110-2155 MHz band utilizing a power greater than 1640 watts EIRP and greater than 1640 watts/MHz EIRP must coordinate such operations in advance with all Government and non-Government satellite entities in the 2025-2110 MHz band. A licensee operating a base or fixed station in the 2110-2180 MHz band utilizing power greater than 1640 watts EIRP and greater than 1640 watts/MHz EIRP must be coordinated in advance with the following licensees authorized to operate within 120 kilometers (75 miles) of the base or fixed station operating in this band: All Broadband Radio Service (BRS) licensees authorized under this part in the 2155-2160 MHz band and all advanced wireless services (AWS) licensees authorized to operate on adjacent frequency blocks in the 2110-2180 MHz band.
 - (4) Fixed, mobile, and portable (hand-held) stations operating in the 1710-1755 MHz band and mobile and portable stations operating in the 1695-1710 MHz and 1755-1780 MHz bands are limited to 1 watt EIRP. Fixed stations operating in the 1710-1755 MHz band are limited to a maximum antenna height of 10 meters above ground. Mobile and portable stations operating in these bands must employ a means for limiting power to the minimum necessary for successful communications.
 - (5) Equipment employed must be authorized in accordance with the provisions of § 24.51. Power measurements for transmissions by stations authorized under this section may be made either in accordance with a Commission-approved average power technique or in compliance with paragraph (d)(6) of this section. In measuring transmissions in this band using an average power technique, the peak-to-average ratio (PAR) of the transmission may not exceed 13 dB.
 - (6) Peak transmit power must be measured over any interval of continuous transmission using instrumentation calibrated in terms of an rms-equivalent voltage. The measurement results shall be properly adjusted for any instrument limitations, such as detector response times, limited resolution bandwidth capability when compared to the emission bandwidth, sensitivity, etc., so as to obtain a true peak measurement for the emission in question over the full bandwidth of the channel.

Test Procedures:

Measurements were in accordance with the test methods section 3.5 of KDB 935210 D05 v01r04.

Adjust the internal gain control of the EUT to the maximum gain for which the equipment certification is being sought. Any EUT attenuation settings shall be set to their minimum value.

Input power levels (uplink and downlink) should be set to maximum input ratings while confirming that the device is not capable of operating in saturation (non-linear mode) at the rated input levels, including during the performance of the input/output power measurements.

3.5.2 Measuring the EUT mean input and output power

- a) Connect a signal generator to the input of the EUT.
- b) Configure to generate the test signal.
- c) The frequency of the signal generator shall be set to the frequency f_0 as determined from out-of-band rejection test.
- d) Connect a spectrum analyzer or power meter to the output of the EUT using appropriate attenuation as necessary.
- e) Set the signal generator output power to a level that produces an EUT output level that is just below the AGC threshold, but not more than 0.5 dB below.
- f) Measure and record the output power of the EUT; use ANSI C63.26-2015 subclause 5.2.4.4.1, for power measurement.
- g) Remove the EUT from the measurement setup. Using the same signal generator settings, repeat the power measurement at the signal generator port, which was used as the input signal to the EUT, and record as the input power. EUT gain may be calculated as described in 3.5.5.
- h) Repeat steps f) and g) with input signal amplitude set to 3 dB above the AGC threshold level.
- i) Repeat steps e) to h) with the narrowband test signal.
- j) Repeat steps e) to i) for all frequency bands authorized for use by the EUT.

3.5.5 Calculating amplifier, repeater, or industrial booster gain

After the input and output power levels have been measured as described in the preceding subclauses, the gain of the EUT can be determined from:

$$\text{Gain (dB)} = \text{output power (dBm)} - \text{input power (dBm)}.$$

Report the gain for each authorized operating frequency band, and each test signal stimulus.

Note: If f_0 that determined from out-of-band test is smaller or greater than difference of test signal's center frequency and operation band block, test is performed at the lowest or the highest frequency that test signals can be passed.

Test Results:

Tabular data of Input / Output Power and Gain

Test Band	Link	Signal	f ₀ Frequency (MHz)	Input Power (dBm)	Output Power (dBm)	Gain (dB)	E.I.R.P.		
							(dBm)	(W/MHz)	(W)
AWS	Uplink	5G NR 20 MHz	1 720.00	-62.03	33.34	95.37	28.44	0.03	0.70
	Downlink	5G NR 20 MHz	2 170.00	-61.98	33.37	95.35	36.37	0.22	4.34

*E.I.R.P.(dBm) = Output Power(dBm) + Ant. Gain

Tabular data of Input / 3 dB above AGC threshold Output Power and Gain

Test Band	Link	Signal	f ₀ Frequency (MHz)	Input Power (dBm)	Output Power (dBm)	Gain (dB)	E.I.R.P.		
							(dBm)	(W/MHz)	(W)
AWS	Uplink	5G NR 20 MHz	1 720.00	-59.09	33.39	92.48	28.49	0.04	0.71
	Downlink	5G NR 20 MHz	2 170.00	-59.07	33.31	92.38	36.31	0.21	4.28

*E.I.R.P.(dBm) = Output Power(dBm) + Ant. Gain

Tabular data of PSD

Test Band	Link	Signal	f ₀ Frequency (MHz)	Output PSD (dBm)	Ant. Gain (dB)	E.I.R.P. (dBm/MHz)	Calculated (W/MHz)	Limit (W/MHz)
AWS	Uplink	5G NR 20 MHz	1 720.00	22.37	3.0	17.47	0.06	1640
	Downlink	5G NR 20 MHz	2 170.00	22.30	19.1	25.30	0.34	1640

Tabular data of 3 dB above AGC threshold PSD

Test Band	Link	Signal	f ₀ Frequency (MHz)	Output PSD (dBm)	Ant. Gain (dB)	E.I.R.P. (dBm/MHz)	Calculated (W/MHz)	Limit (W/MHz)
AWS	Uplink	5G NR 20 MHz	1 720.00	22.45	3.0	17.55	0.06	1640
	Downlink	5G NR 20 MHz	2 170.00	22.25	19.1	25.25	0.33	1640

Tabular data of PAPR

Test Band	Link	Signal	f ₀ Frequency (MHz)	0.1 % PAPR (dB)
AWS	Uplink	5G NR 20 MHz	1 720.00	8.47
	Downlink	5G NR 20 MHz	2 170.00	8.35

Plot data of PSD

PSD / AWS / Uplink / 5G NR 20 MHz



3 dB above the AGC threshold PSD / AWS / Uplink / 5G NR 20 MHz



PSD / AWS / Downlink / 5G NR 20 MHz



3 dB above the AGC threshold PSD / AWS / Downlink / 5G NR 20 MHz



Plot data of PAPR

PAPR / AWS / Uplink / 5G NR 20 MHz

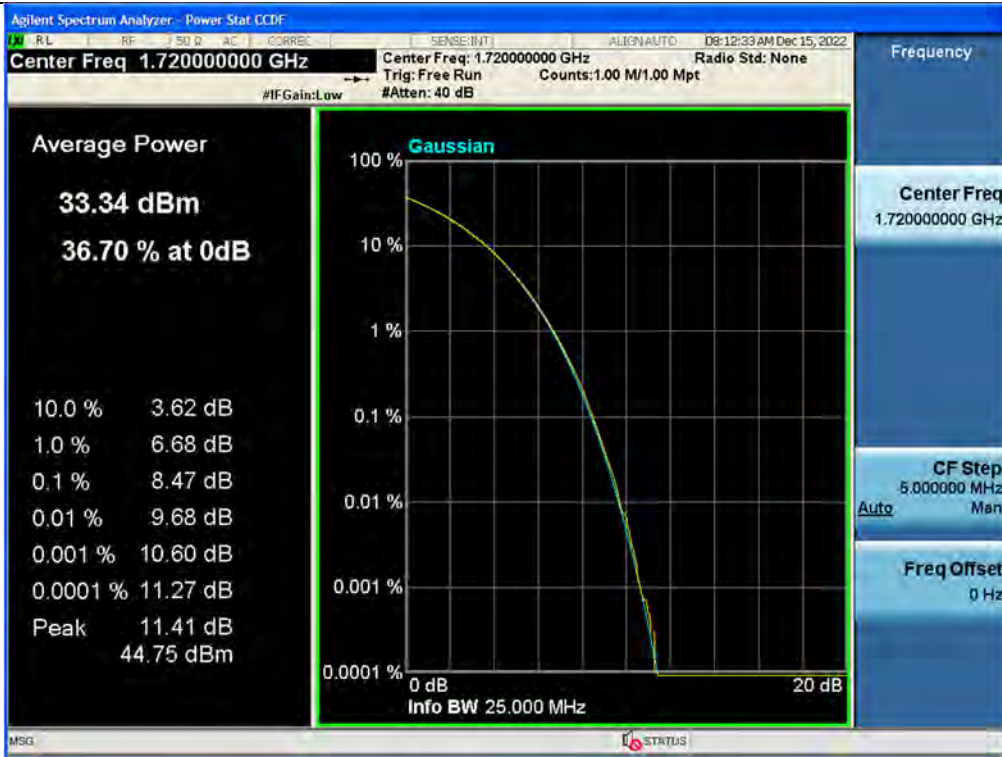

PAPR / AWS / Downlink / 5G NR 20 MHz

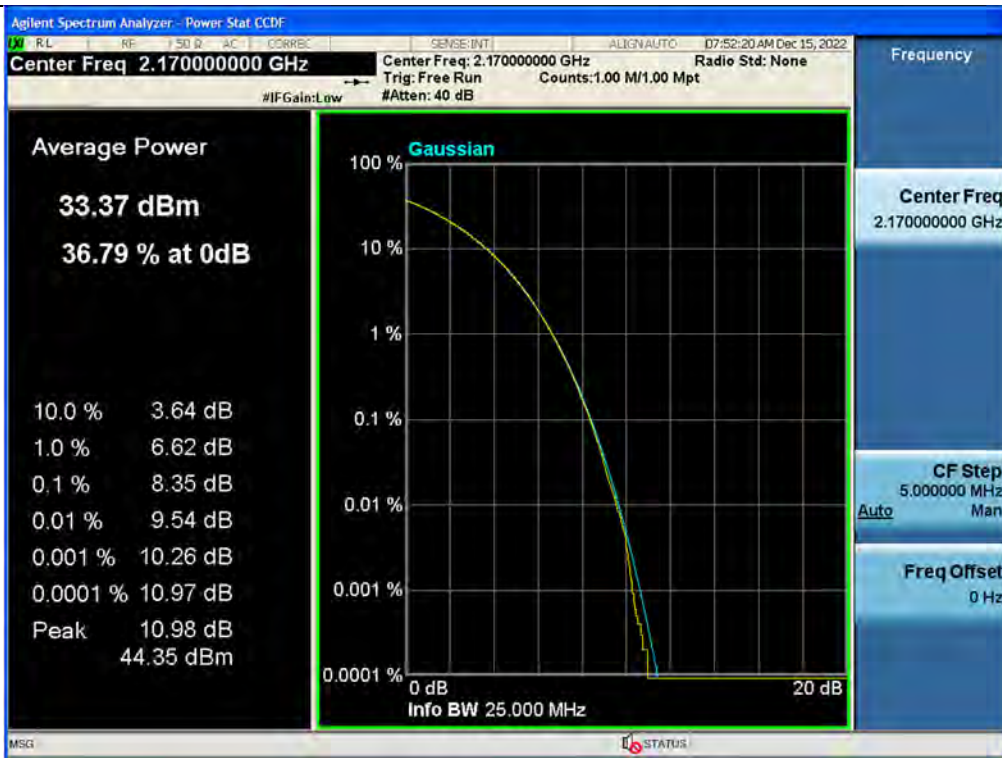

5.5. OUT-OF-BAND/OUT-OF-BLOCK EMISSIONS AND SPURIOUS EMISSIONS

Test Requirements:

§ 2.1051 Measurements required: Spurious emissions at antenna terminals.

The radio frequency voltage or powers generated within the equipment and appearing on a spurious frequency shall be checked at the equipment output terminals when properly loaded with a suitable artificial antenna. Curves or equivalent data shall show the magnitude of each harmonic and other spurious emission that can be detected when the equipment is operated under the conditions specified in § 2.1049 as appropriate. The magnitude of spurious emissions which are attenuated more than 20 dB below the permissible value need not be specified.

§ 27.53 Emission limits.

(h) AWS emission limits

(1) General protection levels. Except as otherwise specified below, for operations in the 1695-1710 MHz, 1710-1755 MHz, 1755-1780 MHz, 1915-1920 MHz, 1995-2000 MHz, 2000-2020 MHz, 2110-2155 MHz, 2155-2180 MHz, and 2180-2200 bands, the power of any emission outside a licensee's frequency block shall be attenuated below the transmitter power (P) in watts by at least $43 + 10 \log_{10}(P)$ dB.

(3) Measurement procedure.

(i) Compliance with this provision is based on the use of measurement instrumentation employing a resolution bandwidth of 1 megahertz or greater. However, in the 1 megahertz bands immediately outside and adjacent to the licensee's frequency block, a resolution bandwidth of at least one percent of the emission bandwidth of the fundamental emission of the transmitter may be employed. The emission bandwidth is defined as the width of the signal between two points, one below the carrier center frequency and one above the carrier center frequency, outside of which all emissions are attenuated at least 26 dB below the transmitter power.

(ii) When measuring the emission limits, the nominal carrier frequency shall be adjusted as close to the licensee's frequency block edges, both upper and lower, as the design permits.

(iii) The measurements of emission power can be expressed in peak or average values, provided they are expressed in the same parameters as the transmitter power.

Test Procedures:

Measurements were in accordance with the test methods section 3.6 of KDB 935210 D05 v01r04.

Spurious emissions shall be measured using a single test signal sequentially tuned to the low, middle, and high channels or frequencies within each authorized frequency band of operation.

Out-of-band/out-of-block emissions (including intermodulation products) shall be measured under each of the following two stimulus conditions:

- a) two adjacent test signals sequentially tuned to the lower and upper frequency band/block edges;
- b) a single test signal, sequentially tuned to the lowest and highest frequencies or channels within the frequency band/block under examination.

NOTE—Single-channel boosters that cannot accommodate two simultaneous signals within the passband may be excluded from the test stipulated in step a).

3.6.2 Out-of-band/out-of-block emissions conducted measurements

- a) Connect a signal generator to the input of the EUT.
If the signal generator is not capable of generating two modulated carriers simultaneously, then two discrete signal generators can be connected with an appropriate combining network to support this two-signal test.
- b) Set the signal generator to produce two AWGN signals as previously described.
- c) Set the center frequencies such that the AWGN signals occupy adjacent channels, as defined by industry standards such as 3GPP or 3GPP2, at the upper edge of the frequency band or block under test.
- d) Set the composite power levels such that the input signal is just below the AGC threshold, but not more than 0.5 dB below. The composite power can be measured using the procedures provided in KDB Publication 971168, but it will be necessary to expand the power integration bandwidth so as to include both of the transmit channels.
- e) Connect a spectrum analyzer to the output of the EUT using appropriate attenuation as necessary.
- f) Set the RBW = reference bandwidth in the applicable rule section for the supported frequency band.
- g) Set the VBW = $3 \times$ RBW.
- h) Set the detector to power averaging (rms) detector.
- i) Set the Sweep time = auto-couple.
- j) Set the spectrum analyzer start frequency to the upper block edge frequency, and the stop frequency to the upper block edge frequency plus 300 kHz or 3 MHz, for frequencies below and above 1 GHz, respectively.
- k) Trace average at least 100 traces in power averaging (rms) mode.
- l) Use the marker function to find the maximum power level.
- m) Capture the spectrum analyzer trace of the power level for inclusion in the test report.
- n) Repeat steps k) to m) with the composite input power level set to 3 dB above the AGC threshold.
- o) Reset the frequencies of the input signals to the lower edge of the frequency block or band under test.
- p) Reset the spectrum analyzer start frequency to the lower block edge frequency minus 300 kHz or 3 MHz, for frequencies below and above 1 GHz, respectively, and the stop frequency to the lower band or block edge frequency.

- q) Repeat steps k) to n).
- r) Repeat steps a) to q) with the signal generator configured for a single test signal tuned as close as possible to the block edges.
- s) Repeat steps a) to r) with the narrowband test signal.
- t) Repeat steps a) to s) for all authorized frequency bands or blocks used by the EUT.

3.6.3 Spurious emissions conducted measurements

- a) Connect a signal generator to the input of the EUT.
- b) Set the signal generator to produce the broadband test signal as previously described.
- c) Set the center frequency of the test signal to the lowest available channel within the frequency band or block.
- d) Set the EUT input power to a level that is just below the AGC threshold, but not more than 0.5 dB below.
- e) Connect a spectrum analyzer to the output of the EUT using appropriate attenuation as necessary.
- f) Set the RBW = reference bandwidth in the applicable rule section for the supported frequency band of operation.
- g) Set the VBW $\geq 3 \times$ RBW.
- h) Set the Sweep time = auto-couple.
- i) Set the spectrum analyzer start frequency to the lowest RF signal generated in the equipment, without going below 9 kHz, and the stop frequency to the lower band/block edge frequency minus 1 MHz.
The number of measurement points in each sweep must be $\geq (2 \times \text{span}/\text{RBW})$, which may require that the measurement range defined by the start and stop frequencies be subdivided, depending on the available number of measurement points provided by the spectrum analyzer.
- j) Select the power averaging (rms) detector function.
- k) Trace average at least 10 traces in power averaging (rms) mode.
- l) Use the peak marker function to identify the highest amplitude level over each measured frequency range. Record the frequency and amplitude and capture a plot for inclusion in the test report.
- m) Reset the spectrum analyzer start frequency to the upper band/block edge frequency plus 1 MHz, and the spectrum analyzer stop frequency to 10 times the highest frequency of the fundamental emission. The number of measurement points in each sweep must be $\geq (2 \times \text{span}/\text{RBW})$, which may require that the measurement range defined by the start and stop frequencies be subdivided, depending on the available number of measurement points provided by the spectrum analyzer.
- n) Trace average at least 10 traces in power averaging (rms) mode.
- o) Use the peak marker function to identify the highest amplitude level over each of the measured frequency ranges. Record the frequency and amplitude and capture a plot for inclusion in the test report; also provide tabular data, if required.
- p) Repeat steps i) to o) with the input test signals firstly tuned to a middle band/block frequency/channel, and then tuned to a high band/block frequency/channel.
- q) Repeat steps b) to p) with the narrowband test signal.
- r) Repeat steps b) to q) for all authorized frequency bands/blocks used by the EUT.

Note

1. In 9 kHz-150 kHz, 150 kHz-30 MHz bands, and from edge to edge±10 MHz, narrow RBW was applied, so correction factor was used according to section 5.7.2 of ANSI C63.26-2015

Band	9 kHz ~ 150 kHz Correction	150 kHz ~ 30 MHz Correction	From Edge to Edge±10 MHz Correction
Above 1 GHz (Ref. RBW: 1 MHz)	30 dB	20 dB	10 dB

2. Measurement bandwidth specified in the applicable rule section for the supported frequency band.

Test Results: Plot data of Out-of-band/out-of-block emissions

Out-of-band (two adjacent test signals) / AWS / Uplink / 5G NR 20 MHz / Lower

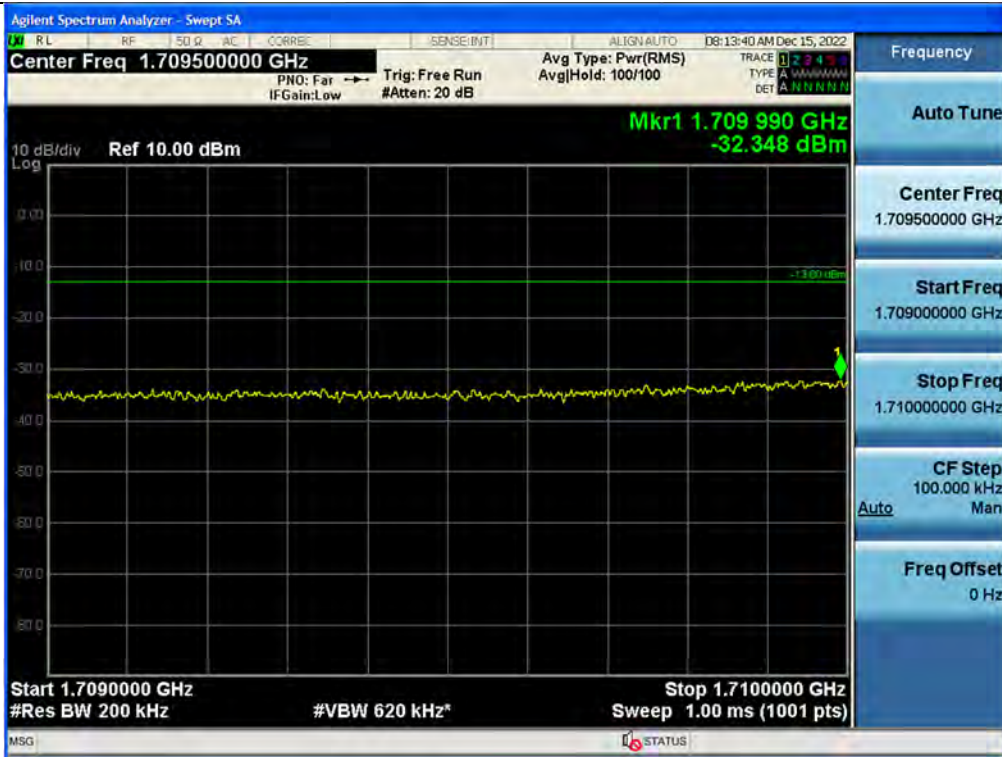

Out-of-band (two adjacent test signals) / AWS / Uplink / 5G NR 20 MHz / Upper

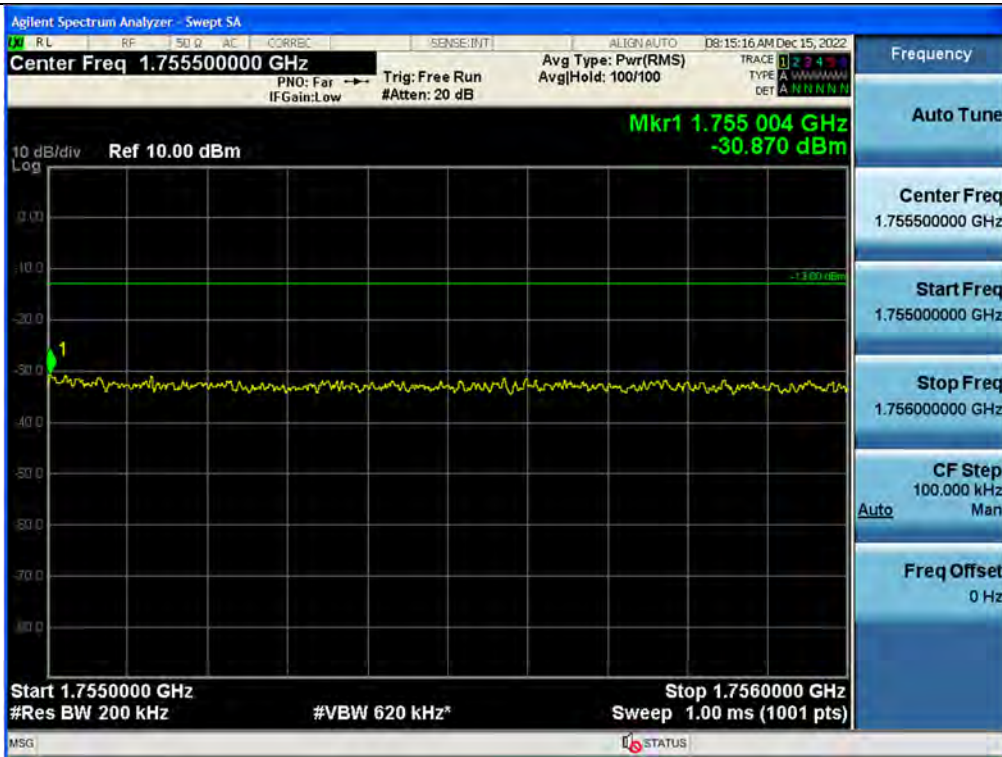

+3 dB above Out-of-band (two adjacent test signals) / AWS / Uplink / 5G NR 20 MHz / Lower

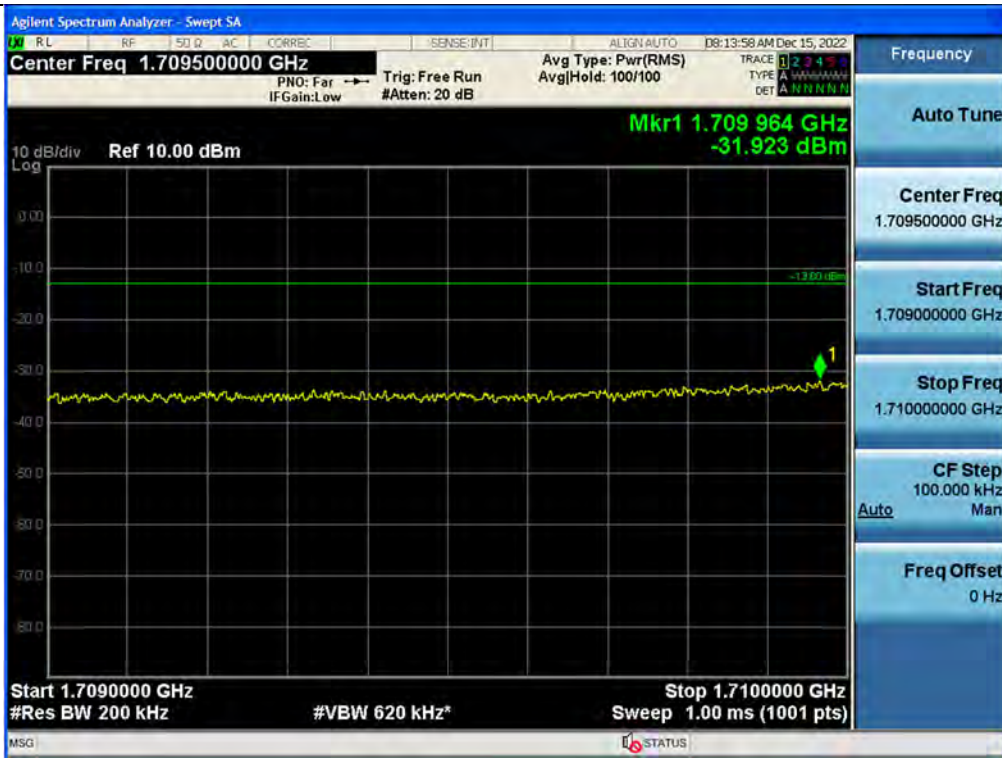

+3 dB above Out-of-band (two adjacent test signals) / AWS / Uplink / 5G NR 20 MHz / Upper

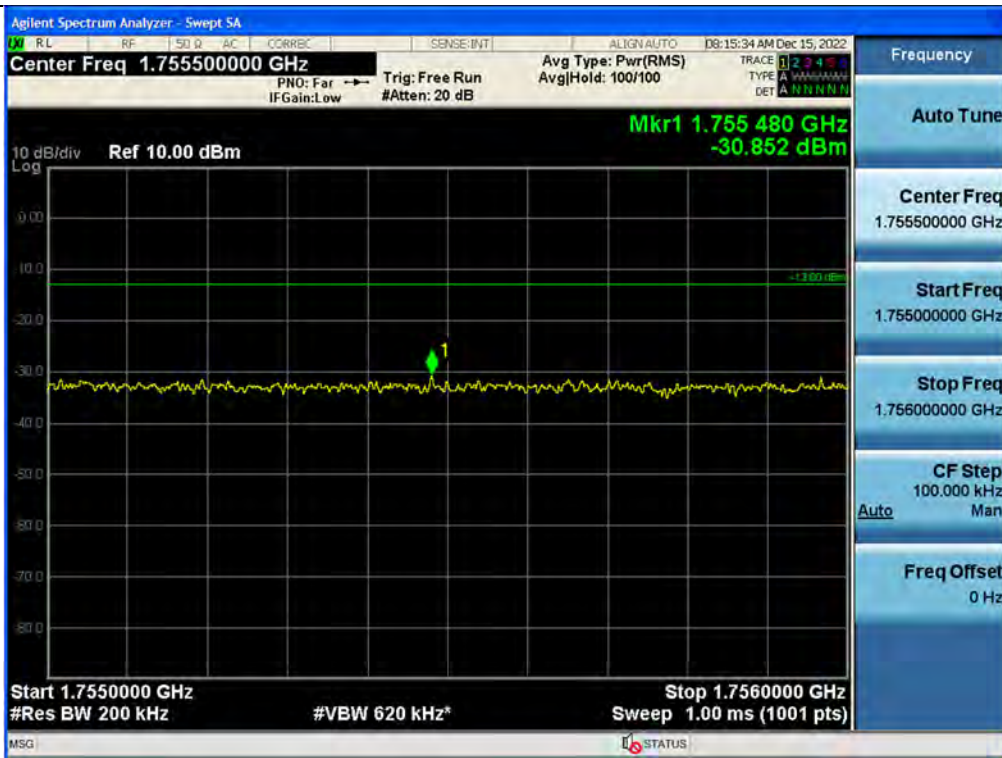

Out-of-band (two adjacent test signals) / AWS / Downlink / 5G NR 20 MHz / Lower

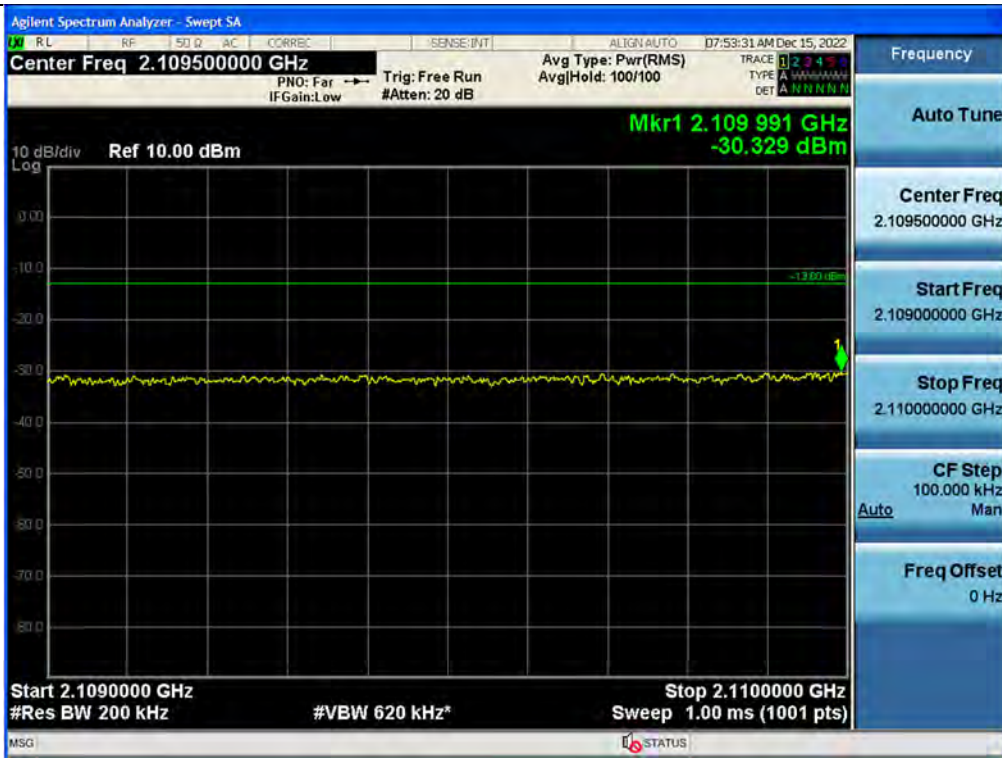

Out-of-band (two adjacent test signals) / AWS / Downlink / 5G NR 20 MHz / Upper



+3 dB above Out-of-band (two adjacent test signals) / AWS / Downlink / 5G NR 20 MHz / Lower

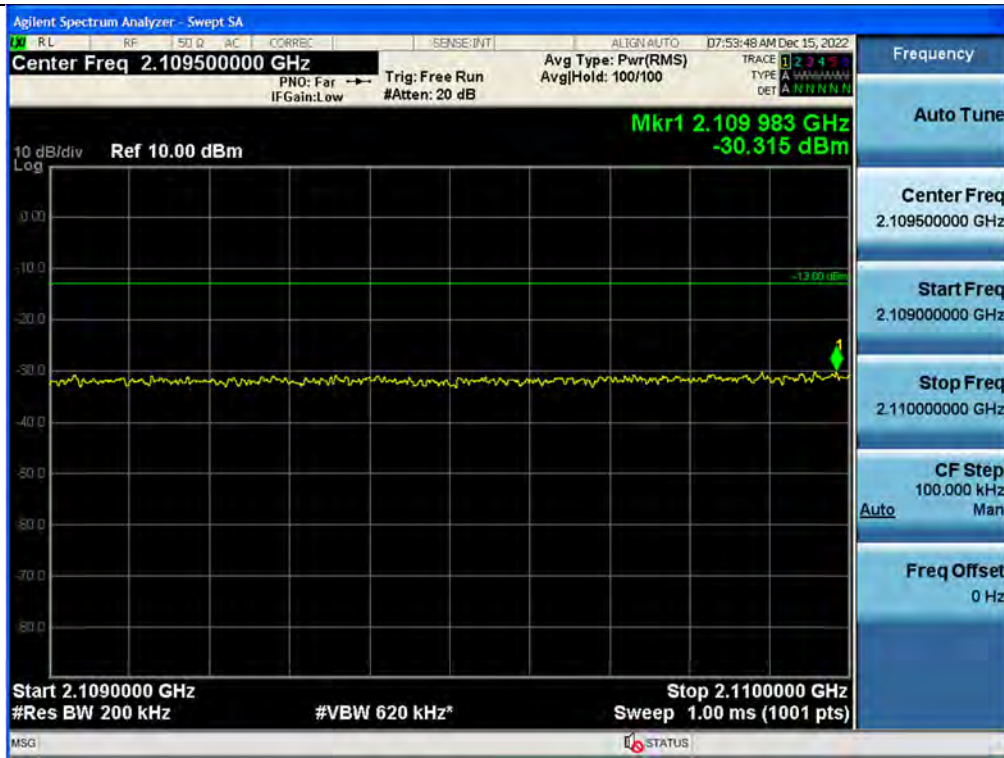

+3 dB above Out-of-band (two adjacent test signals) / AWS / Downlink / 5G NR 20 MHz / Upper

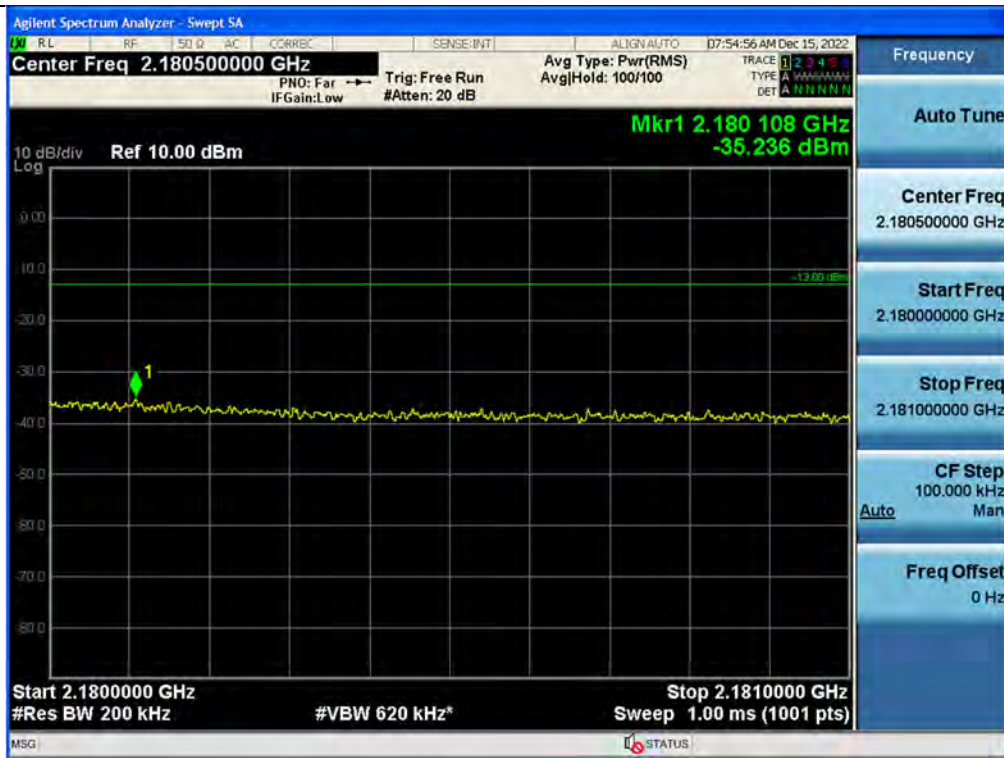

Out-of-band (single test signal) / AWS / Uplink / 5G NR 20 MHz / Lower

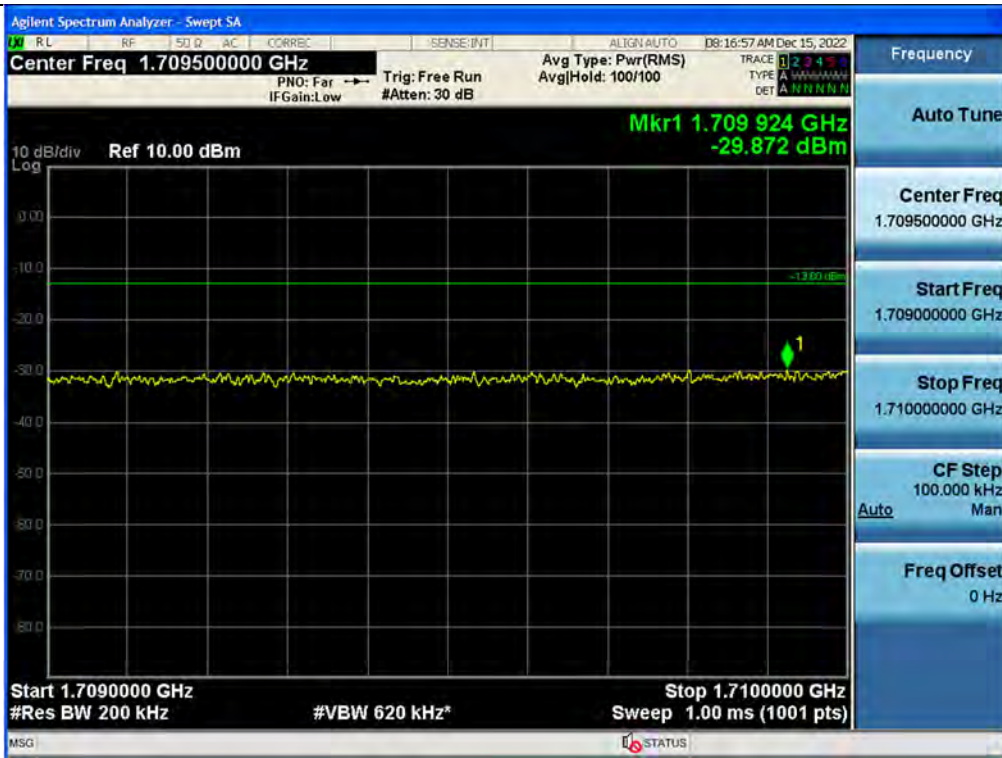

Out-of-band (single test signal) / AWS / Uplink / 5G NR 20 MHz / Upper

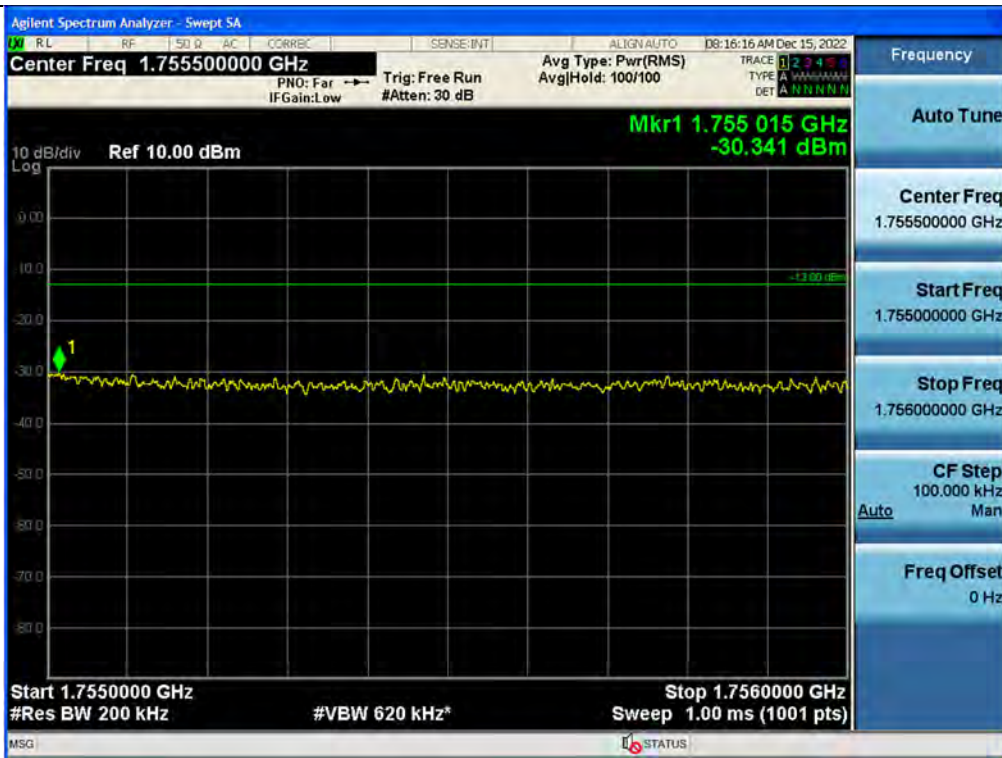

+3 dB above Out-of-band (single test signal) / AWS / Uplink / 5G NR 20 MHz / Lower

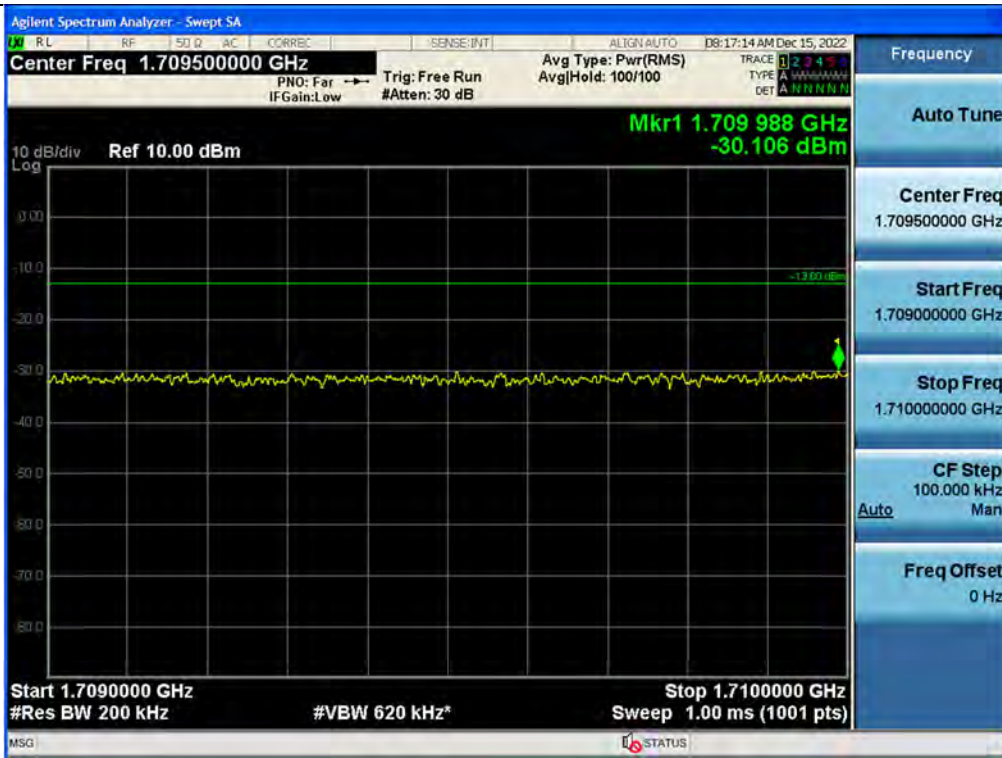

+3 dB above Out-of-band (single test signal) / AWS / Uplink / 5G NR 20 MHz / Upper

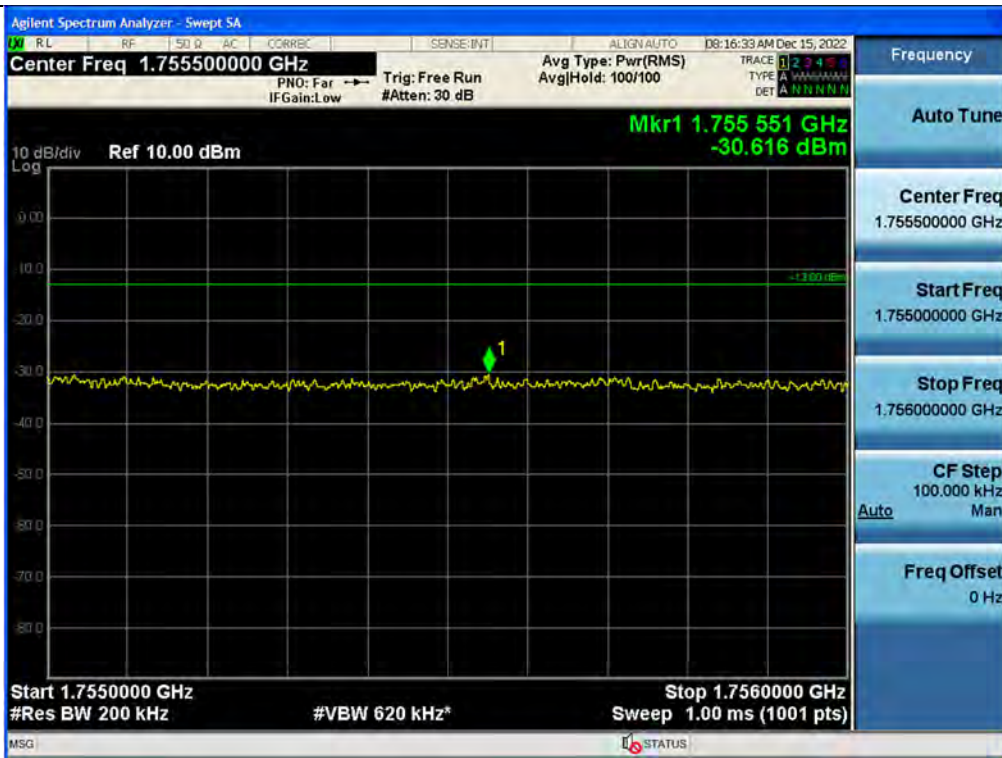

Out-of-band (single test signal) / AWS / Downlink / 5G NR 20 MHz / Lower

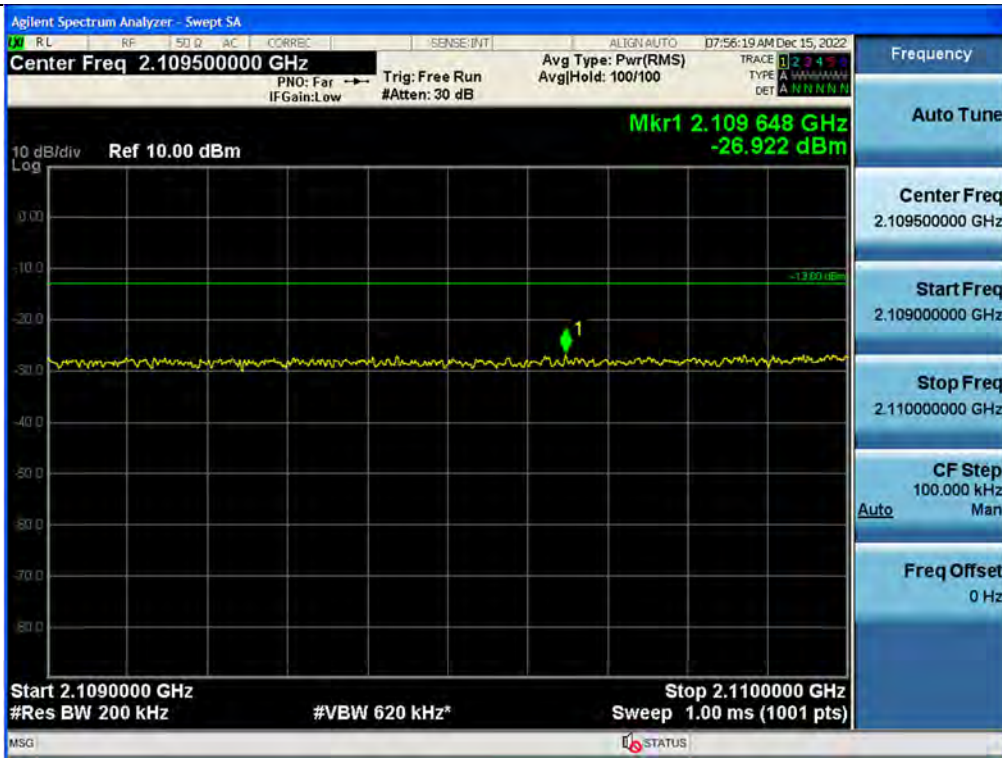

Out-of-band (single test signal) / AWS / Downlink / 5G NR 20 MHz / Upper

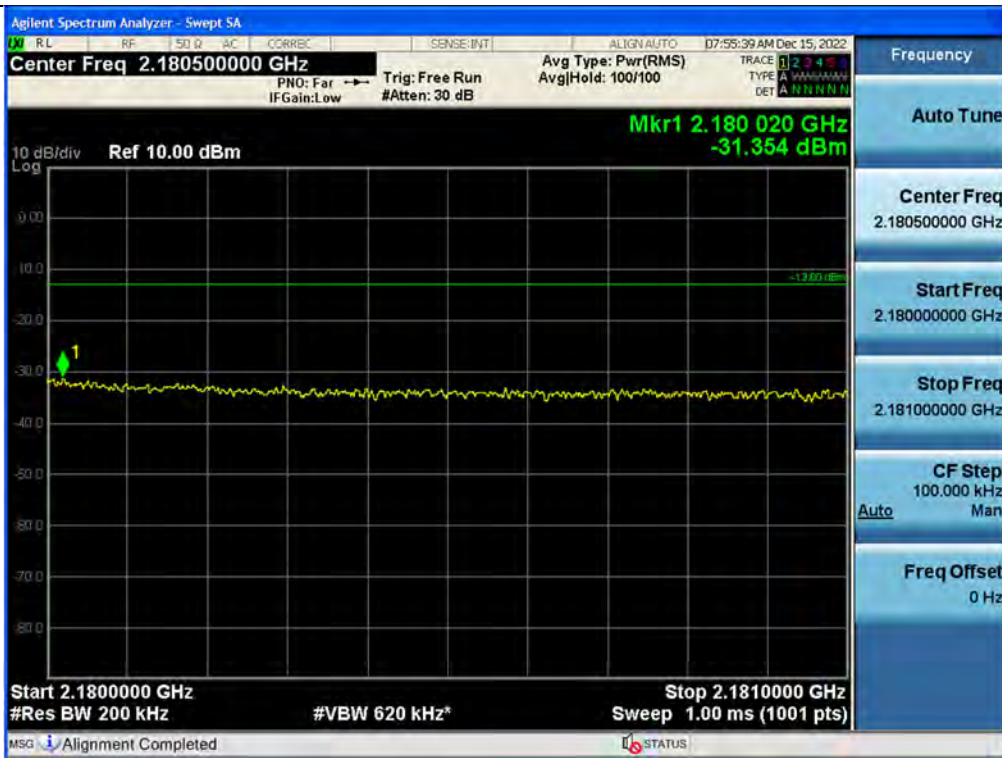

+3 dB above Out-of-band (single test signal) / AWS / Downlink / 5G NR 20 MHz / Lower

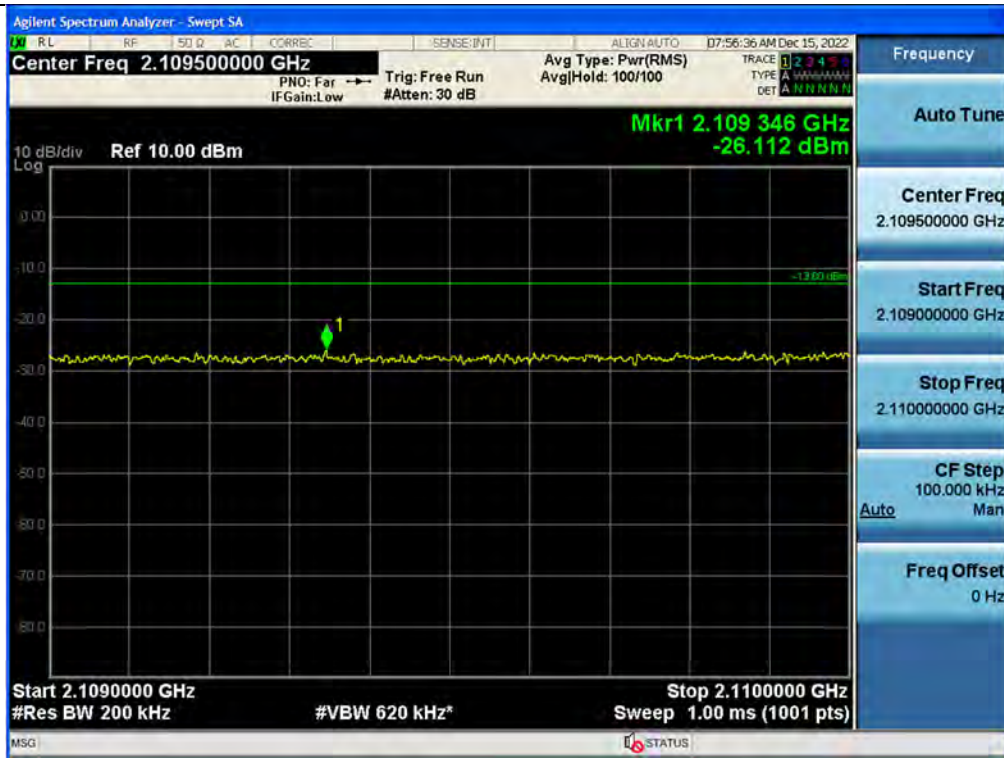

+3 dB above Out-of-band (single test signal) / AWS / Downlink / 5G NR 20 MHz / Upper

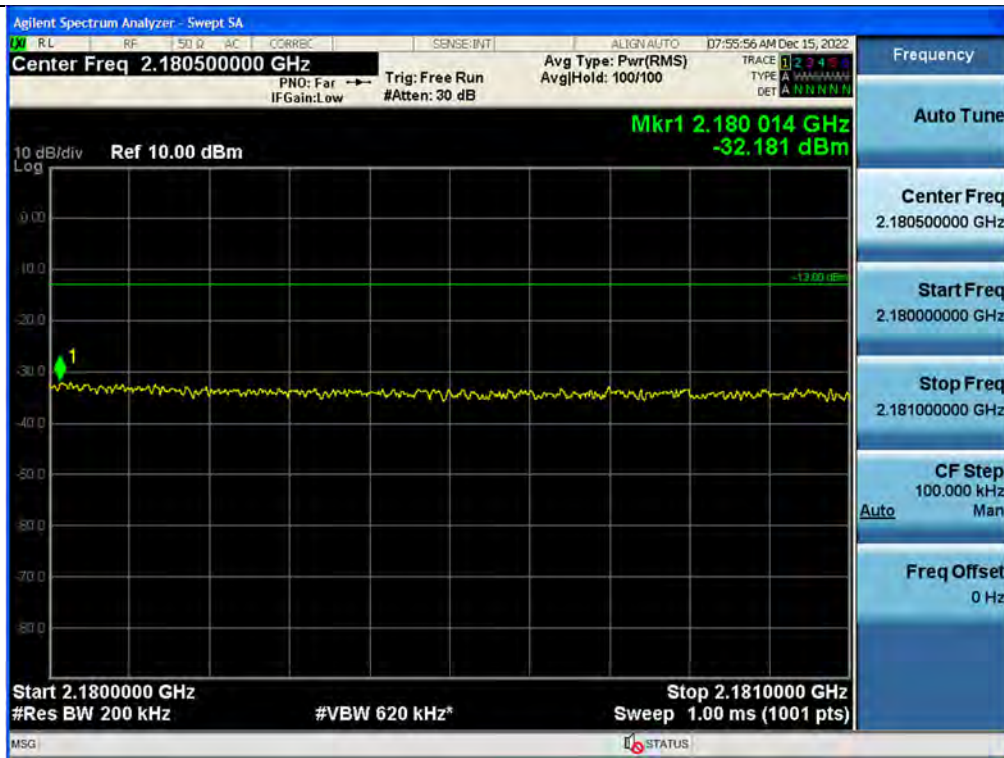

Test Results: Plot data of Out-of-band/out-of-block emissions (Simultaneous)

Spurious / AWS / Uplink / 5G NR 20 MHz / High / 9 kHz ~ 150 kHz



Spurious / AWS / Uplink / 5G NR 20 MHz / High / 150 kHz ~ 30 MHz

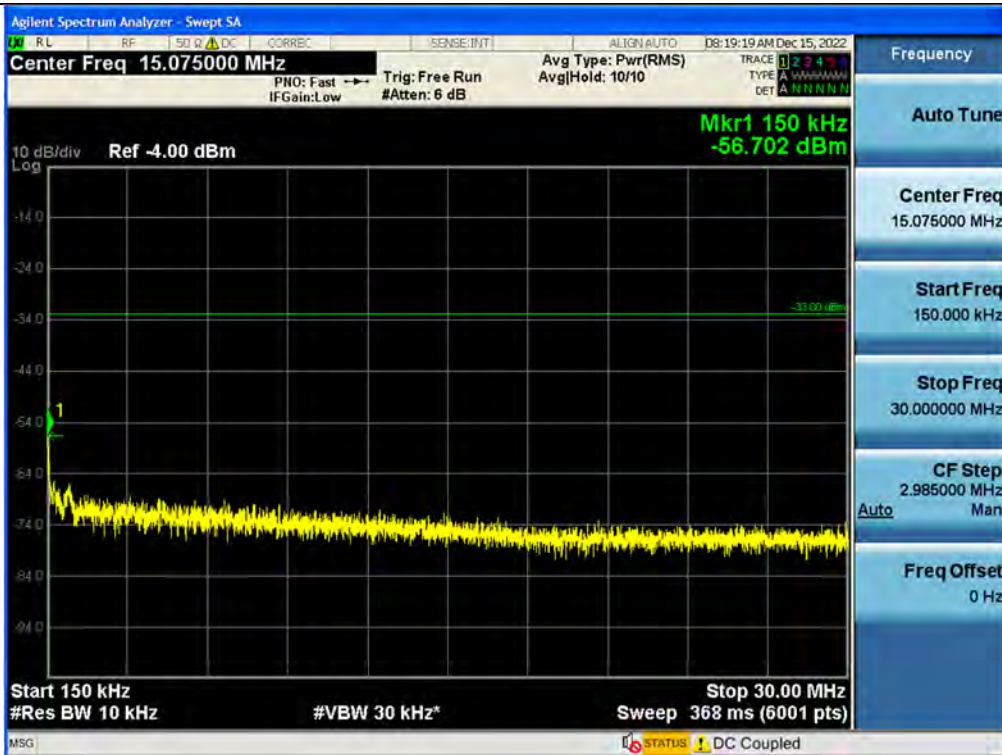

Spurious / AWS / Uplink / 5G NR 20 MHz / Low / 30 MHz ~ Low Edge - 10 MHz

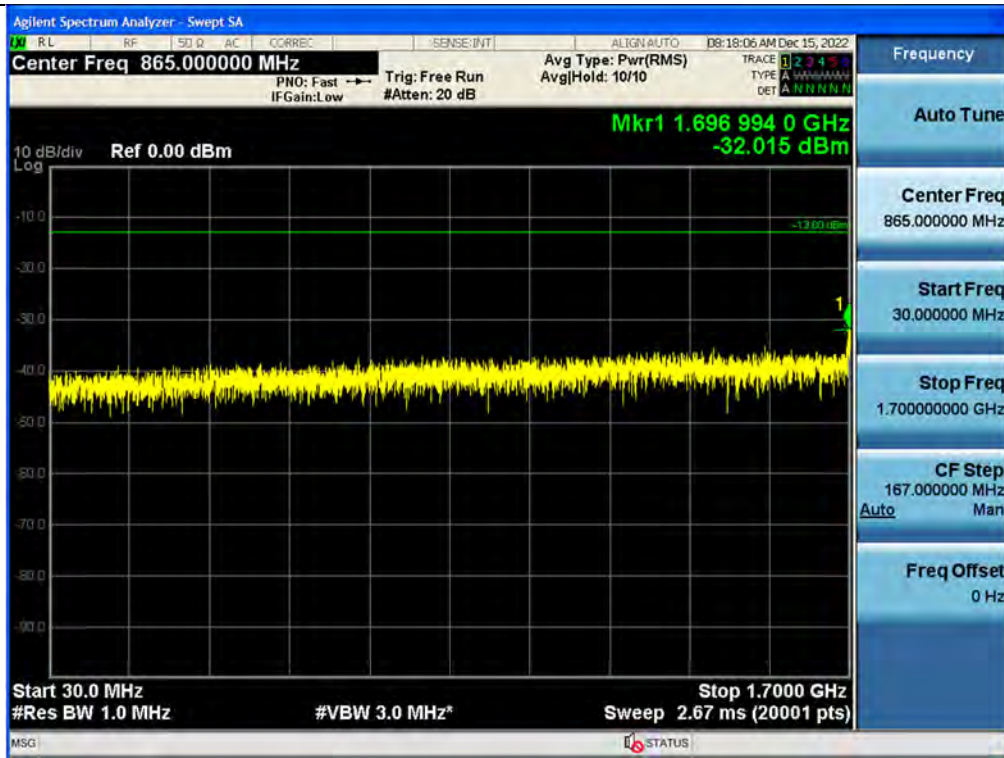

Spurious / AWS / Uplink / 5G NR 20 MHz / Low / Low Edge - 10 MHz ~ Low Edge

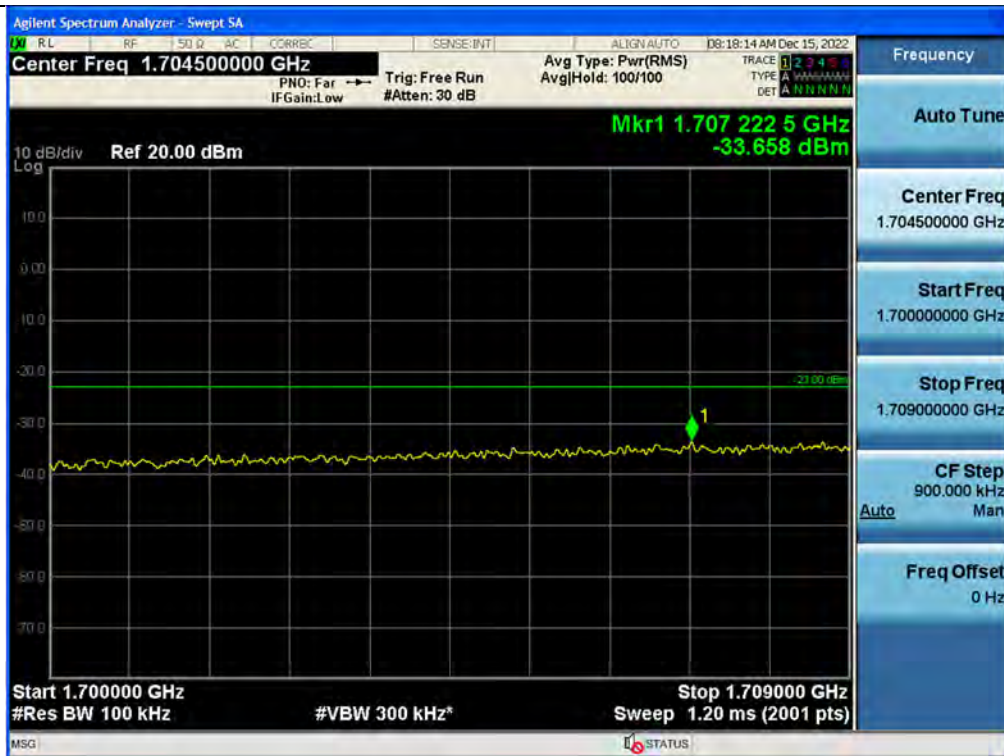

Spurious / AWS / Uplink / 5G NR 20 MHz / High / High Edge ~ High Edge + 10 MHz



Spurious / AWS / Uplink / 5G NR 20 MHz / High / High Edge + 10 MHz ~ 10 GHz

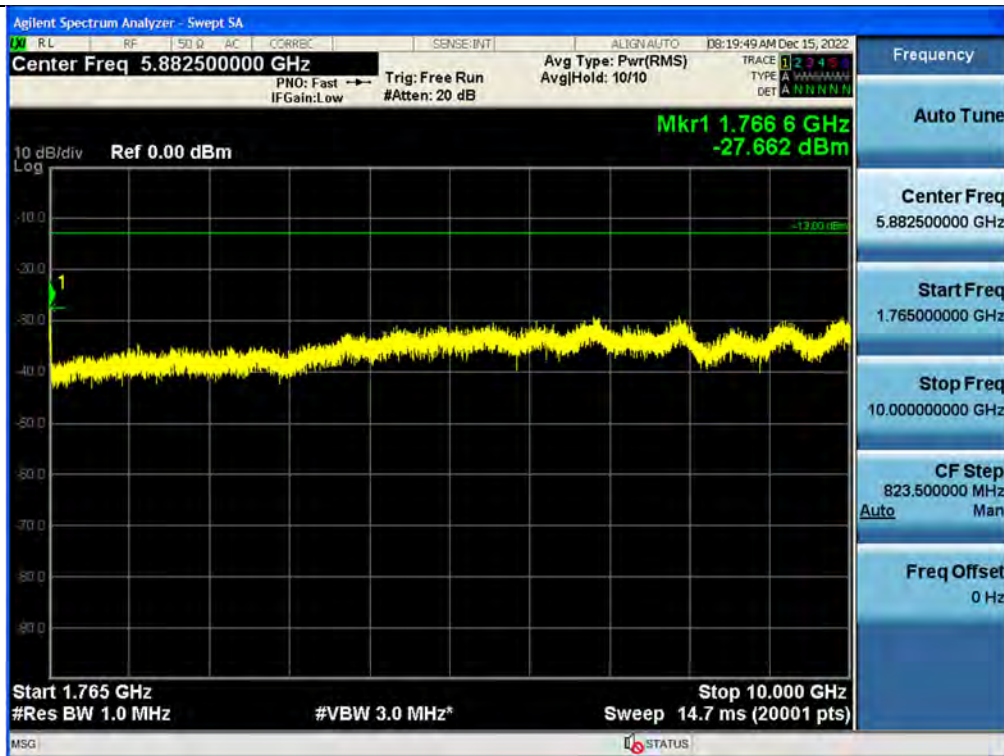

Spurious / AWS / Uplink / 5G NR 20 MHz / Middle / 10 GHz ~ 26.5 GHz



Spurious / AWS / Downlink / 5G NR 20 MHz / Low / 9 kHz ~ 150 kHz



Spurious / AWS / Downlink / 5G NR 20 MHz / Low / 150 kHz ~ 30 MHz

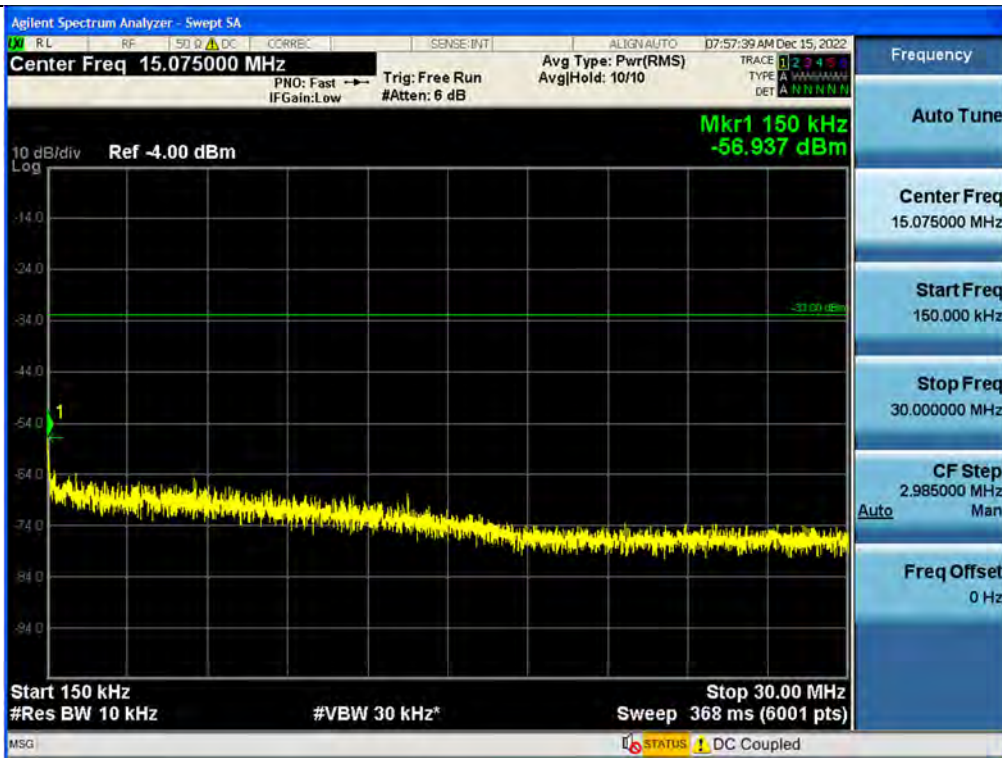

Spurious / AWS / Downlink / 5G NR 20 MHz / Low / 30 MHz ~ Low Edge - 10 MHz

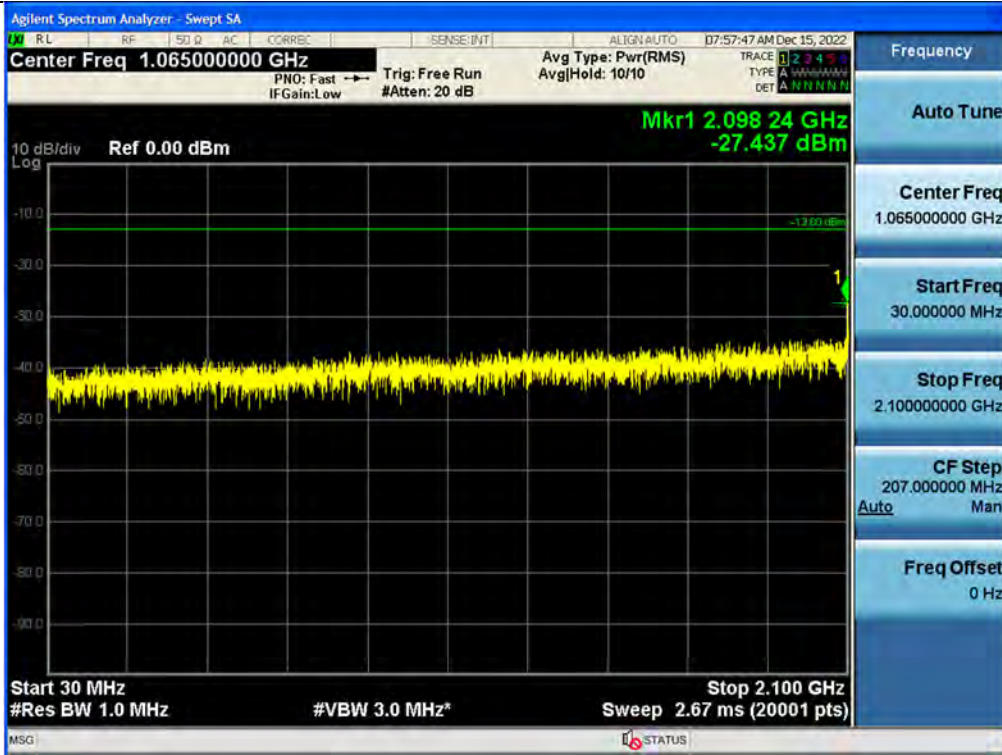

Spurious / AWS / Downlink / 5G NR 20 MHz / Low / Low Edge - 10 MHz ~ Low Edge

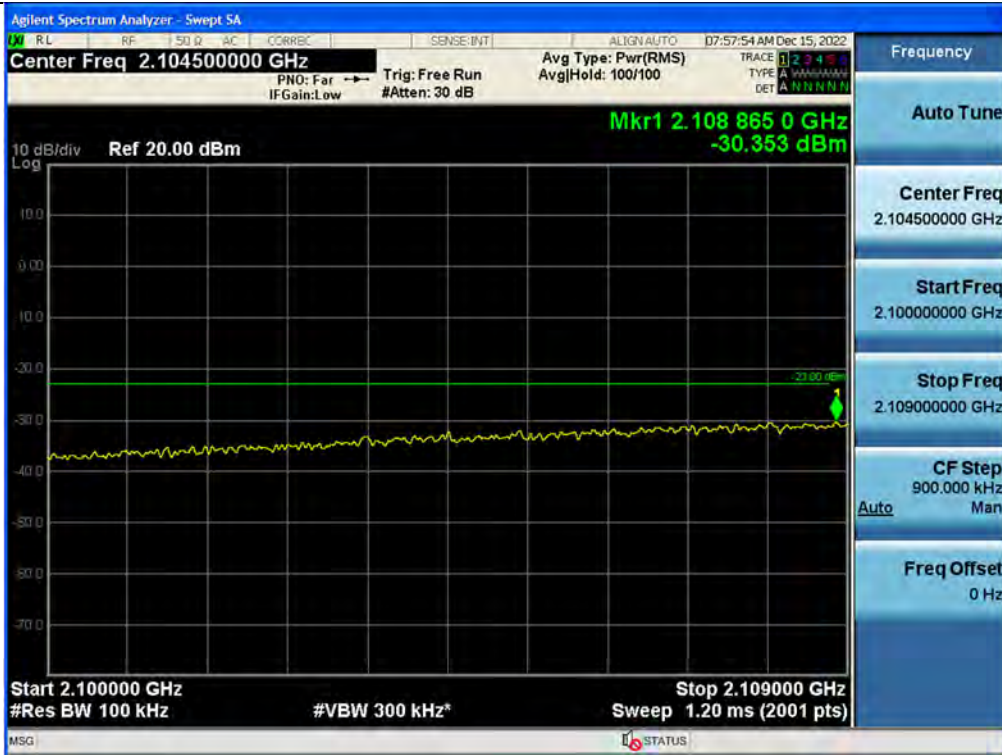

Spurious / AWS / Downlink / 5G NR 20 MHz / Low / High Edge ~ High Edge + 10 MHz

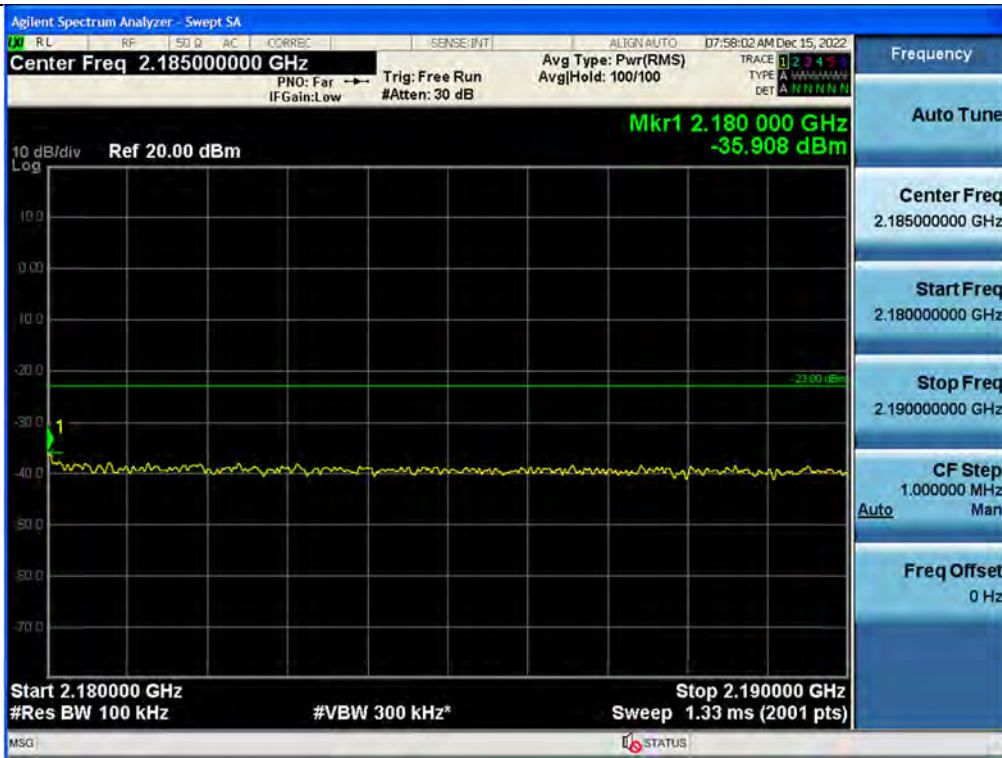

Spurious / AWS / Downlink / 5G NR 20 MHz / Middle / High Edge + 10 MHz ~ 10 GHz

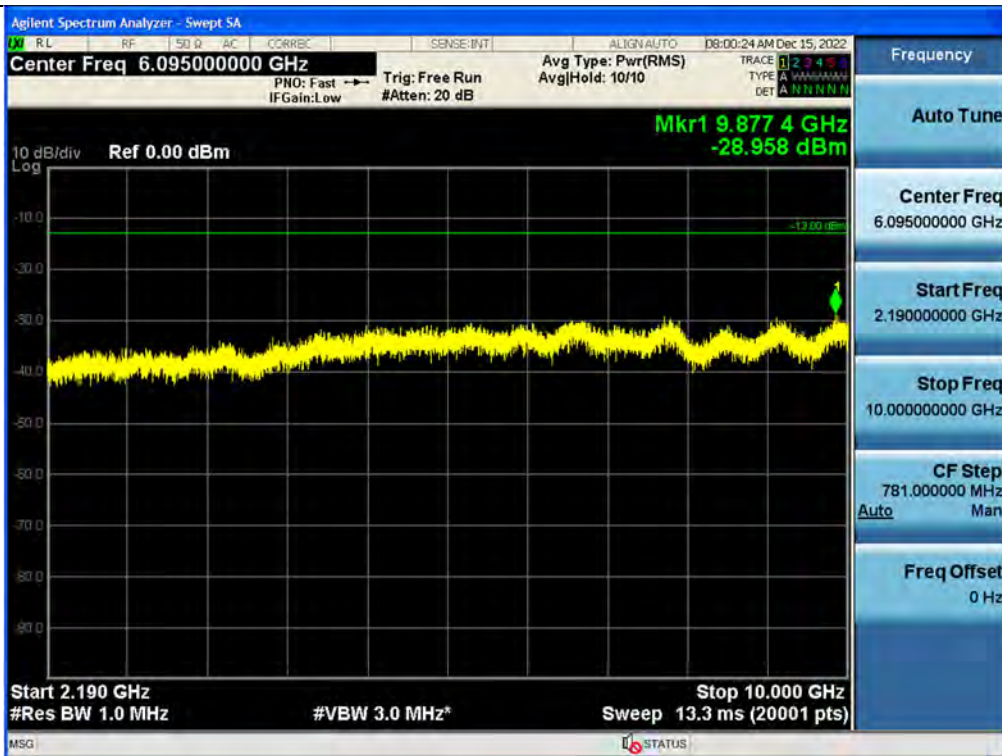

Spurious / AWS / Downlink / 5G NR 20 MHz / Low / 10 GHz ~ 26.5 GHz



Note : Only the worst case Spurious Emissions plots are attached for each frequency range.

5.6. RADIATED SPURIOUS EMISSIONS

Test Requirements:

§ 2.1053 Measurements required: Field strength of spurious radiation.

- (a) Measurements shall be made to detect spurious emissions that may be radiated directly from the cabinet, control circuits, power leads, or intermediate circuit elements under normal conditions of installation and operation. Curves or equivalent data shall be supplied showing the magnitude of each harmonic and other spurious emission. For this test, single sideband, independent sideband, and controlled carrier transmitters shall be modulated under the conditions specified in paragraph (c) of § 2.1049, as appropriate. For equipment operating on frequencies below 890 MHz, an open field test is normally required, with the measuring instrument antenna located in the far-field at all test frequencies. In the event it is either impractical or impossible to make open field measurements (e.g. a broadcast transmitter installed in a building) measurements will be accepted of the equipment as installed. Such measurements must be accompanied by a description of the site where the measurements were made showing the location of any possible source of reflections which might distort the field strength measurements. Information submitted shall include the relative radiated power of each spurious emission with reference to the rated power output of the transmitter, assuming all emissions are radiated from halfwave dipole antennas.
- (b) The measurements specified in paragraph (a) of this section shall be made for the following equipment:
- (1) Those in which the spurious emissions are required to be 60 dB or more below the mean power of the transmitter.
 - (2) All equipment operating on frequencies higher than 25 MHz.
 - (3) All equipment where the antenna is an integral part of, and attached directly to the transmitter.
 - (4) Other types of equipment as required, when deemed necessary by the Commission.

Test Procedures:

Because KDB 935210 D05 procedure does not provide this requirement, measurements were in accordance with the test methods section 5.5 of ANSI C63.26-2015

- a) Place the EUT in the center of the turntable. The EUT shall be configured to transmit into the standard non-radiating load (for measuring radiated spurious emissions), connected with cables of minimal length unless specified otherwise. If the EUT uses an adjustable antenna, the antenna shall be positioned to the length that produces the worst case emission at the fundamental operating frequency.
- b) Each emission under consideration shall be evaluated:
 - 1) Raise and lower the measurement antenna in accordance 5.5.2, as necessary to enable detection of the maximum emission amplitude relative to measurement antenna height.
 - 2) Rotate the EUT through 360° to determine the maximum emission level relative to the axial position.
 - 3) Return the turntable to the azimuth where the highest emission amplitude level was observed.
 - 4) Vary the measurement antenna height again through 1 m to 4 m again to find the height associated with the maximum emission amplitude.
 - 5) Record the measured emission amplitude level and frequency using the appropriate RBW.
- c) Repeat step b) for each emission frequency with the measurement antenna oriented in both the horizontal and vertical polarizations to determine the orientation that gives the maximum emissions amplitude.

Test Result:

Uplink_ AWS DC Battery

Mode	Frequency (MHz)	Measured Level (dBuV)	Ant. Factor (dB/m)	A.G.+C.L.+H.P.F. (dB)	Pol.	Measured Power (dBm)	Result (dBm/m)
5G NR 20 MHz	3 600.50	54.57	29.50	41.02	H	-40.63	-52.15

* C.L.: Cable Loss / A.G.: Amp. Gain / H.P.F.: High Pass Filter

Downlink_ AWS DC Battery

Mode	Frequency (MHz)	Measured Level (dBuV)	Ant. Factor (dB/m)	A.G.+C.L.+H.P.F. (dB)	Pol.	Measured Power (dBm)	Result (dBm/m)
5G NR 20 MHz	3 150.00	53.88	29.50	40.68	H	-41.32	-52.50

* C.L.: Cable Loss / A.G.: Amp. Gain / H.P.F.: High Pass Filter

Uplink_ AWS AC Powered

Mode	Frequency (MHz)	Measured Level (dBuV)	Ant. Factor (dB/m)	A.G.+C.L.+H.P.F. (dB)	Pol.	Measured Power (dBm)	Result (dBm/m)
5G NR 20 MHz	3 150.50	55.36	29.50	40.68	H	-39.84	-51.02
	3 600.50	55.07	29.50	41.02	H	-40.13	-51.65

* C.L.: Cable Loss / A.G.: Amp. Gain / H.P.F.: High Pass Filter

Downlink_ AWS AC Powered

Mode	Frequency (MHz)	Measured Level (dBuV)	Ant. Factor (dB/m)	A.G.+C.L.+H.P.F. (dB)	Pol.	Measured Power (dBm)	Result (dBm/m)
5G NR 20 MHz	3 150.50	55.66	29.50	40.68	H	-39.54	-50.72
	3 600.00	56.64	29.50	41.02	H	-38.56	-50.08

* C.L.: Cable Loss / A.G.: Amp. Gain / H.P.F.: High Pass Filter

Note:

1. We have done horizontal and vertical polarization in detecting antenna.
2. Measure distance = 3 m
3. The amplitude of the spurious domain emission attenuated by more than 20 dB over the permissible value was not recorded according to ANSI C63.26, clause 5.1.1., c).
4. Test data were only the worst case.

Plot data of radiated spurious emissions

Uplink / AWS



Downlink / AWS



Note : Only the worst case plots for Radiated Spurious Emissions.

5.7. FREQUENCY STABILITY

Test Requirements:

§ 2.1055 Measurements required: Frequency stability.

(a) The frequency stability shall be measured with variation of ambient temperature as follows:

- (1) From -30° to $+50^{\circ}$ centigrade for all equipment except that specified in paragraphs (a) (2) and (3) of this section.

§ 27.54 Frequency stability.

The frequency stability shall be sufficient to ensure that the fundamental emissions stay within the authorized bands of operation.

Test Procedures:

The measurement is performed in accordance with Section 5.6.3, 5.6.4 and 5.6.5 of ANSI C63.26.

5.6.3 Procedure for frequency stability testing

Frequency stability is a measure of the frequency drift due to temperature and supply voltage variations, with reference to the frequency measured at $+20^{\circ}\text{C}$ and rated supply voltage.

The operating carrier frequency shall be set up in accordance with the manufacturer's published operation and instruction manual prior to the commencement of these tests. No adjustment of any frequency determining circuit element shall be made subsequent to this initial set-up. Frequency stability is tested:

- a) At 10°C intervals of temperatures between -30°C and $+50^{\circ}\text{C}$ at the manufacturer's rated supply voltage, and
- b) At $+20^{\circ}\text{C}$ temperature and $\pm 15\%$ supply voltage variations. If a product is specified to operate over a range of input voltage then the -15% variation is applied to the lowermost voltage and the $+15\%$ is applied to the uppermost voltage.

During the test all necessary settings, adjustments and control of the EUT have to be performed without disturbing the test environment, i.e., without opening the environmental chamber. The frequency stabilities can be maintained to a lesser temperature range provided that the transmitter is automatically inhibited from operating outside the lesser temperature range. For handheld equipment that is only capable of operating from internal batteries and the supply voltage cannot be varied, the frequency stability tests shall be performed at the nominal battery voltage and the battery end point voltage specified by the manufacturer. An external supply voltage can be used and set at the internal battery nominal voltage, and again at the battery operating end point voltage which shall be specified by the equipment manufacturer.

If an unmodulated carrier is not available, the mean frequency of a modulated carrier can be obtained by using a frequency counter with gating time set to an appropriately large multiple of bit periods (gating time depending on the required accuracy). Full details on the choice of values shall be included in the test report.

5.6.4 Frequency stability over variations in temperature

- a) Supply the EUT with a nominal 60 Hz ac voltage, dc voltage, or install a new or fully charged battery in the EUT.
- b) If possible a dummy load should be connected to the EUT because an antenna near the metallic walls of an environmental test chamber could affect the output frequency of the EUT. If the EUT is equipped with a permanently attached, adjustable-length antenna, the EUT should be placed in the center of the chamber with the antenna adjusted to the shortest length possible.
- c) Turn on the EUT, and tune it to the center frequency of the operating band.
- d) Couple the transmitter output to the measuring instrument through a suitable attenuator and coaxial cable. If connection to the EUT output is not possible, make the measurement by connecting an antenna to the measuring instrument with a suitable length of coaxial cable and placing the measuring antenna near the EUT (e.g., 15 cm away).

NOTE—An instrument that has an adequate level of accuracy as specified by the procuring or regulatory authority is the recommended measuring instrument.

- e) Adjust the location of the measurement antenna and the controls on the measurement instrument to obtain a suitable signal level (i.e., a level that will not overload the measurement instrument, but is strong enough to allow measurement of the operating or fundamental frequency of the EUT). Adjust the detector bandwidth and span settings to achieve a resolution capable of accurate frequency measurements over the applicable frequency stability limits.
- f) Turn the EUT off, and place it inside the environmental temperature chamber. For devices that have oscillator heaters, energize only the heater circuit.
- g) Set the temperature control on the chamber to the Highest temperature specified in the regulatory requirements for the type of device, and allow the oscillator heater and the chamber temperature to stabilize. Unless otherwise instructed by the regulatory authority, this temperature should be 50 °C.
- h) While maintaining a constant temperature inside the environmental chamber, turn on the EUT and allow sufficient time for the EUT temperature to stabilize.
- i) Measure the frequency.
- j) Switch off the EUT, but do not switch off the oscillator heater.
- k) Lower the chamber temperature to the next level that is required by the standard and allow the temperature inside the chamber to stabilize. Unless otherwise instructed by the regulators, this temperature step should be 10 °C.
- l) Repeat step h) through step k) down to the lowest specified temperature. Unless otherwise instructed by the regulators, this temperature should be –30 °C. When the frequency stability limit is stated as being sufficient such that the fundamental emissions stay within the authorized bands of operation, a reference point shall be established at the applicable unwanted emissions limit using a RBW equal to the RBW required by the unwanted emissions specification of the applicable regulatory standard. These reference points measured using the lowest and Highest channel of operation shall be identified as f_L and f_H respectively. The worst-case frequency offset determined in the above methods shall be added or subtracted from the values of f_L and f_H and the resulting frequencies must remain within the band.
- m) Omitted

5.6.5 Frequency stability when varying supply voltage

- a) Couple the transmitter output to the measuring instrument through a suitable attenuator and coaxial cable. If connection to the EUT output is not possible make the measurement by connecting an antenna to the measuring instrument with a suitable length of coaxial cable and placing the measuring antenna near the EUT (e.g., 15 cm away)
- b) Supply the EUT with nominal ac or dc voltage. The supply voltage shall be measured at the input to the cable normally provided with the equipment, or at the power supply terminals if cables are not normally provided. Effects on frequency of transmitter keying (except for broadcast transmitters) and any heating element cycling at the nominal supply voltage and at each extreme also shall be shown.
- c) Turn on the EUT, and couple its output to a frequency counter or other frequency-measuring instrument.
- d) Tune the EUT to the center frequency of the operating band. Adjust the location of the measurement antenna and the controls on the measurement instrument to obtain a suitable signal level (i.e., a level that will not overload the measurement instrument, but is strong enough to allow measurement of the operating or fundamental frequency of the EUT). Adjust the detector bandwidth and span settings to achieve a resolution capable of accurate frequency measurements over the applicable frequency stability limits.

NOTE—An instrument that has an adequate level of accuracy as specified by the procuring or regulatory authority is the recommended measuring instrument.

- e) Measure the frequency.
- f) Unless otherwise specified, vary primary supply voltage from 85% to 115% of the nominal value for other than hand carried battery equipment.
- g) For hand carried, battery powered equipment, reduce the primary ac or dc supply voltage to the battery operating end point, which shall be specified by the manufacturer.
- h) Repeat the frequency measurement.

NOTE—For band-edge compliance, it can be required to make these measurements at the low and High channel of the operating band.

Note: The results of the frequency stability test shown above the frequency deviation measured values are very small and similar trend for each port, so we are attached only the worst case data.

Test Results:

Reference: 110 Vac at 20°C Freq. = 1,732,500,000 Hz

Voltage (%)	Temp. (°C)	Frequency (Hz)	Frequency Error (Hz)	Deviation (Hz)	ppm
100 %	+20(Ref)	1 732 500 000	0.169	0.000	0.00000
	-30	1 732 500 007	6.422	6.253	0.00361
	-20	1 732 500 009	8.426	8.257	0.00477
	-10	1 732 500 010	9.451	9.282	0.00536
	0	1 732 500 004	4.083	3.914	0.00226
	+10	1 732 500 004	3.549	3.380	0.00195
	+30	1 732 500 005	5.121	4.952	0.00286
	+40	1 732 500 008	7.914	7.745	0.00447
	+50	1 732 500 001	0.485	0.316	0.00018
115 %	+20	1 732 500 000	0.012	-0.157	-0.00009
85 %	+20	1 732 500 004	3.386	3.217	0.00186

Reference: 110 Vac at 20°C Freq. = 2,145,000,000 Hz

Voltage (%)	Temp. (°C)	Frequency (Hz)	Frequency Error (Hz)	Deviation (Hz)	ppm
100 %	+20(Ref)	2 145 000 008	7.627	0.000	0.00000
	-30	2 145 000 016	8.316	0.689	0.00032
	-20	2 145 000 013	5.457	-2.170	-0.00101
	-10	2 145 000 015	7.149	-0.478	-0.00022
	0	2 145 000 011	3.485	-4.142	-0.00193
	+10	2 145 000 017	9.195	1.568	0.00073
	+30	2 145 000 016	8.527	0.900	0.00042
	+40	2 145 000 016	8.330	0.703	0.00033
	+50	2 145 000 011	3.535	-4.092	-0.00191
115 %	+20	2 145 000 010	2.221	-5.406	-0.00252
85 %	+20	2 145 000 010	2.652	-4.975	-0.00232

6. Annex A_EUT AND TEST SETUP PHOTO

Please refer to test setup photo file no. as follows;

No.	Description
1	HCT-RF-2301-FC032-P