

FCC REPORT

Certification

Applicant Name:
ADVANCED RF TECHNOLOGIES, INC**Address:**
3116 WEST VANOWEN STREET, BURBANK, CA
91505, USA**Date of Issue:**
March 21, 2019**Location of test lab:**
HCT CO., LTD.,
74, Seoicheon-ro 578beon-gil, Majang-myeon,
Icheon-si, Gyeonggi-do, 17383, Rep. of KOREA**Report No.:** HCT-RF-1903-FC002-R1**FCC ID:** N52-SDR-AF**APPLICANT:** ADVANCED RF TECHNOLOGIES, INC**Model:** SDR-AF**EUT Type:** REPEATER**Frequency Range:**

Band Name	Downlink (MHz)	Uplink (MHz)
AWS	2 110 ~ 2 180	1 710 ~ 1 755

Output Power: 33 dBm**Date of Test:** February 20, 2019 ~ March 21, 2019**FCC Rule Parts:** CFR 47 Part 2, Part 27

The measurements shown in this report were made in accordance with the procedures indicated, and the emissions from this equipment were found to be within the limits applicable. I assume full responsibility for the accuracy and completeness of these measurements, and for the qualifications of all persons taking them. It is further stated that upon the basis of the measurements made, the equipment tested is capable of operation in accordance with the requirements of the FCC Rules under normal use and maintenance.



Report prepared by : Kyung Soo Kang
Engineer of telecommunication testing center

Approved by : Kwon Jeong
Manager of telecommunication testing center

This report only responds to the tested sample and may not be reproduced, except in full, without written approval of the HCT Co., Ltd.

Version

TEST REPORT NO.	DATE	DESCRIPTION
HCT-RF-1903-FC002	March 08, 2019	- First Approval Report
HCT-RF-1903-FC002-R1	March 21, 2019	- Revised the test results in section 5.3. - Added a note about the measurement bandwidth specified in the applicable rule section for the supported frequency band. (in section 5.5)

Table of Contents

1. GENERAL INFORMATION.....	4
1.1. APPLICANT INFORMATION.....	4
1.2. PRODUCT INFORMATION	4
1.3. TEST INFORMATION	4
2. FACILITIES AND ACCREDITATIONS	5
2.1. FACILITIES.....	5
2.2. EQUIPMENT	5
3. TEST SPECIFICATIONS.....	6
3.1. STANDARDS	6
3.2. ADDITIONAL DESCRIPTIONS ABOUT TEST	7
3.3. MEASUREMENT UNCERTAINTY.....	9
3.4. STANDARDS ENVIRONMENTAL TEST CONDITIONS.....	9
3.5. TEST DIAGRAMS.....	10
4. TEST EQUIPMENTS.....	11
5. TEST RESULT	12
5.1. AGC THRESHOLD	12
5.2. OUT-OF-BAND REJECTION.....	14
5.3. INPUT-VERSUS-OUTPUT SIGNAL COMPARISON	16
5.4. INPUT/OUTPUT POWER AND AMPLIFIER/BOOSTER GAIN	23
5.5. OUT-OF-BAND/OUT-OF-BLOCK EMISSIONS AND SPURIOUS EMISSIONS.....	28
5.6. RADIATED SPURIOUS EMISSIONS	62
6. Annex A_EUT AND TEST SETUP PHOTO	64

1. GENERAL INFORMATION

1.1. APPLICANT INFORMATION

Company Name	ADVANCED RF TECHNOLOGIES, INC
Company Address	3116 WEST VANOWEN STREET, BURBANK, CA 91505, USA

1.2. PRODUCT INFORMATION

EUT Type	REPEATER		
Power Supply	110~120V AC / 210~240V AC		
Frequency Range	Band Name	Downlink (MHz)	Uplink (MHz)
	AWS	2 110 ~ 2 180	1 710 ~ 1 755
Tx Output Power	33 dBm		
Antenna Specification		Antenna type	Peak Gain (dBi)
	Downlink	Panel Antenna	19.1
	Uplink	Omni Antenna	3.0
		*The donor antenna cable must be used with 24 dB Loss.	

1.3. TEST INFORMATION

FCC Rule Parts	CFR 47 Part 2, Part 27
Measurement Standards	KDB 935210 D05 v01r02, ANSI C63.26-2015
Test Location	HCT CO., LTD. 74, Seoicheon-ro 578beon-gil, Majang-myeon, Icheon-si, Gyeonggi-do, 17383, Rep. of KOREA

2. FACILITIES AND ACCREDITATIONS

2.1. FACILITIES

The SAC(Semi-Anechoic Chamber) and conducted measurement facility used to collect the radiated data are located at the 74, Seoicheon-ro 578beon-gil, Majang-myeon, Icheon-si, Gyeonggi-do, 17383, Rep. of KOREA.

The site is constructed in conformance with the requirements of ANSI C63.4 (Version: 2014) and CISPR Publication 22.

Detailed description of test facility was submitted to the Commission and accepted dated April 02, 2018 (Registration Number: KR0032).

2.2. EQUIPMENT

Radiated emissions are measured with one or more of the following types of linearly polarized antennas: tuned dipole, bi-conical, log periodic, bi-log, and/or ridged waveguide, horn. Spectrum analyzers with pre-selectors and quasi-peak detectors are used to perform radiated measurements.

Calibrated wideband preamplifiers, coaxial cables, and coaxial attenuators are also used for making measurements.

All receiving equipment conforms to CISPR Publication 16-1, "Radio Interference Measuring Apparatus and Measurement Methods."

3. TEST SPECIFICATIONS

3.1. STANDARDS

The following tests were conducted on a sample of the equipment for the purpose of demonstrating compliance with FCC Part 2 and Part 27.

Description	Reference	Results
AGC threshold	KDB 935210 D05 v01r02 3.2	Compliant
Out-of-band rejection	KDB 935210 D05 v01r02 3.3	Compliant
Input-versus-output signal comparison	§2.1049	Compliant
Input/output power and amplifier/booster gain	§2.1046, §27.50(d)	Compliant
Out-of-band/out-of-block emissions and spurious emissions	§2.1051, §27.53(h)	Compliant
Spurious emissions radiated	§2.1053	Compliant

3.2. ADDITIONAL DESCRIPTIONS ABOUT TEST

Except for the following cases, EUT was tested under normal operating conditions.

: Out-of-band rejection test requires maximum gain condition without AGC.

The test was generally based on the method of KDB 935210 D05 v01r02 and only followed ANSI C63.26-2015 if there was no test method in KDB standard.

EUT was tested with following modulated signals provide by applicant.

Band Name	Tested signals
AWS	LTE 20 MHz

The frequency stability measurement has been omitted in accordance with section 3.7 of KDB 935210 D05 v01r02.

: It can be confirmed through input-versus-output signal comparison test that EUT does not alter the input signal.

The tests results included actual loss value for attenuator and cable combination as shown in the table below.

: Input Path

Correction factor table			
Frequency (MHz)	Factor (dB)	Frequency (MHz)	Factor (dB)
1 500	0.675	2 250	0.930
1 550	0.828	2 300	0.836
1 600	0.870	2 350	0.910
1 650	0.876	2 400	1.079
1 700	0.786	2 450	1.096
1 750	0.750	2 500	0.920
1 800	0.567	2 550	1.021
1 850	0.664	2 600	1.095
1 900	0.776	2 650	1.261
1 950	0.825	2 700	1.210
2 000	0.750	2 750	1.322
2 050	0.699	2 800	1.266
2 100	0.749	2 850	1.240
2 150	0.794	2 900	1.397
2 200	0.747		

: Output Path

Correction factor table			
Frequency (MHz)	Factor (dB)	Frequency (MHz)	Factor (dB)
2	30.577	6 000	33.852
10	30.163	7 000	34.302
30	29.738	8 000	34.987
50	29.900	9 000	35.361
100	30.097	10 000	35.579
200	30.189	11 000	35.227
300	30.469	12 000	35.910
400	30.657	13 000	35.654
500	30.732	14 000	36.205
600	30.788	15 000	36.990
700	30.859	16 000	36.392
800	30.905	17 000	37.445
900	31.204	18 000	37.751
1 000	31.239	19 000	38.248
1 700	31.799	20 000	35.848
1 800	31.661	21 000	35.009
2 000	31.826	22 000	34.080
2 100	31.946	23 000	36.083
2 200	31.983	24 000	40.146
3 000	32.628	25 000	38.544
4 000	33.535	26 000	37.031
5 000	33.414	26 500	37.794

3.3. MEASUREMENT UNCERTAINTY

Description	Reference	Results
AGC threshold	-	±0.87 dB
Out-of-band rejection	-	±0.58 MHz
Input-versus-output signal comparison	OBW > 5 MHz	±0.58 MHz
Input/output power and amplifier/booster gain	-	±0.87 dB
Out-of-band/out-of-block emissions and spurious emissions	-	±1.08 dB
Spurious emissions radiated	f ≤ 1 GHz	±4.80 dB
	f > 1 GHz	±6.07 dB

* Coverage factor $k = 2$, Confidence levels of 95 %

3.4. STANDARDS ENVIRONMENTAL TEST CONDITIONS

Temperature	-10 °C to +50 °C
Relative humidity	5 % to 90 %
Air pressure	860 mbar to 1 060 mbar

3.5. TEST DIAGRAMS

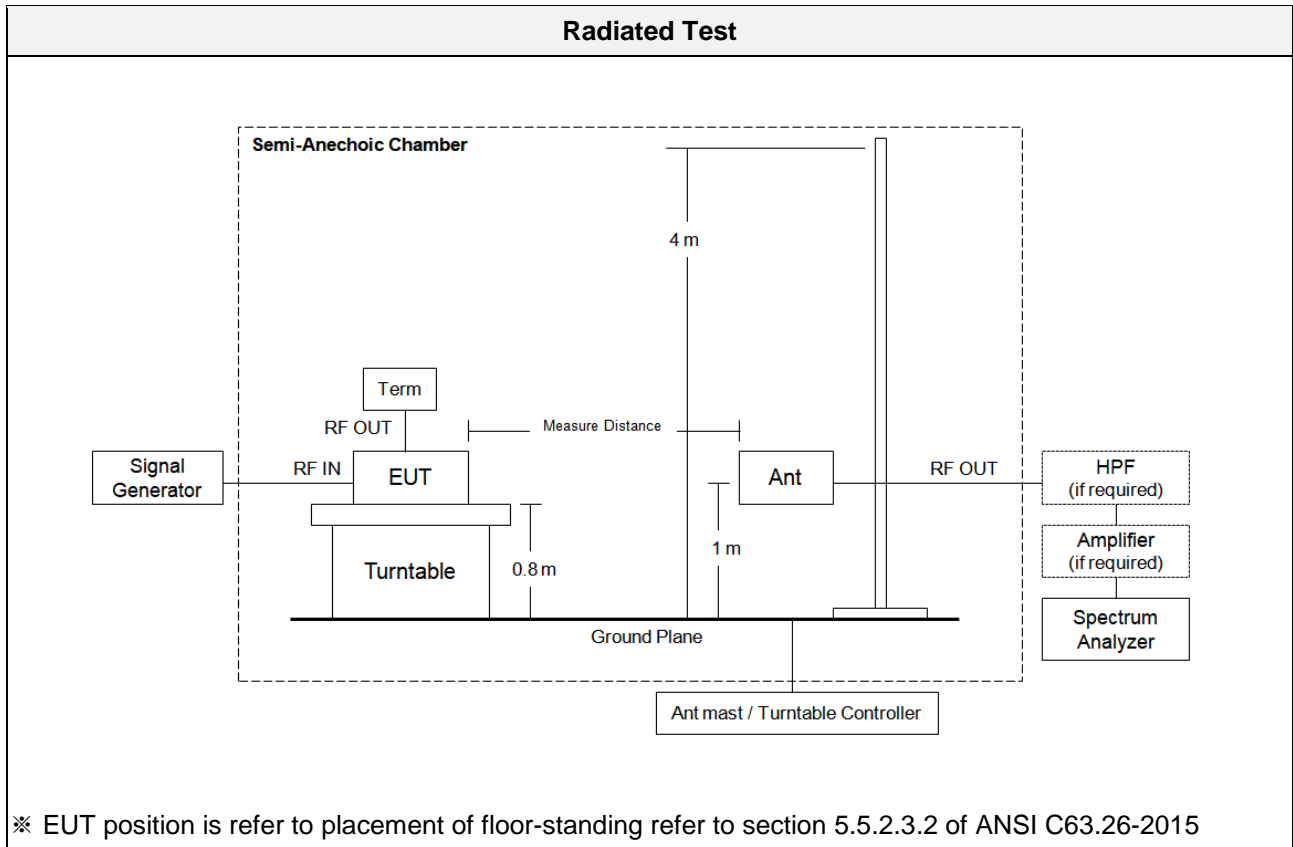
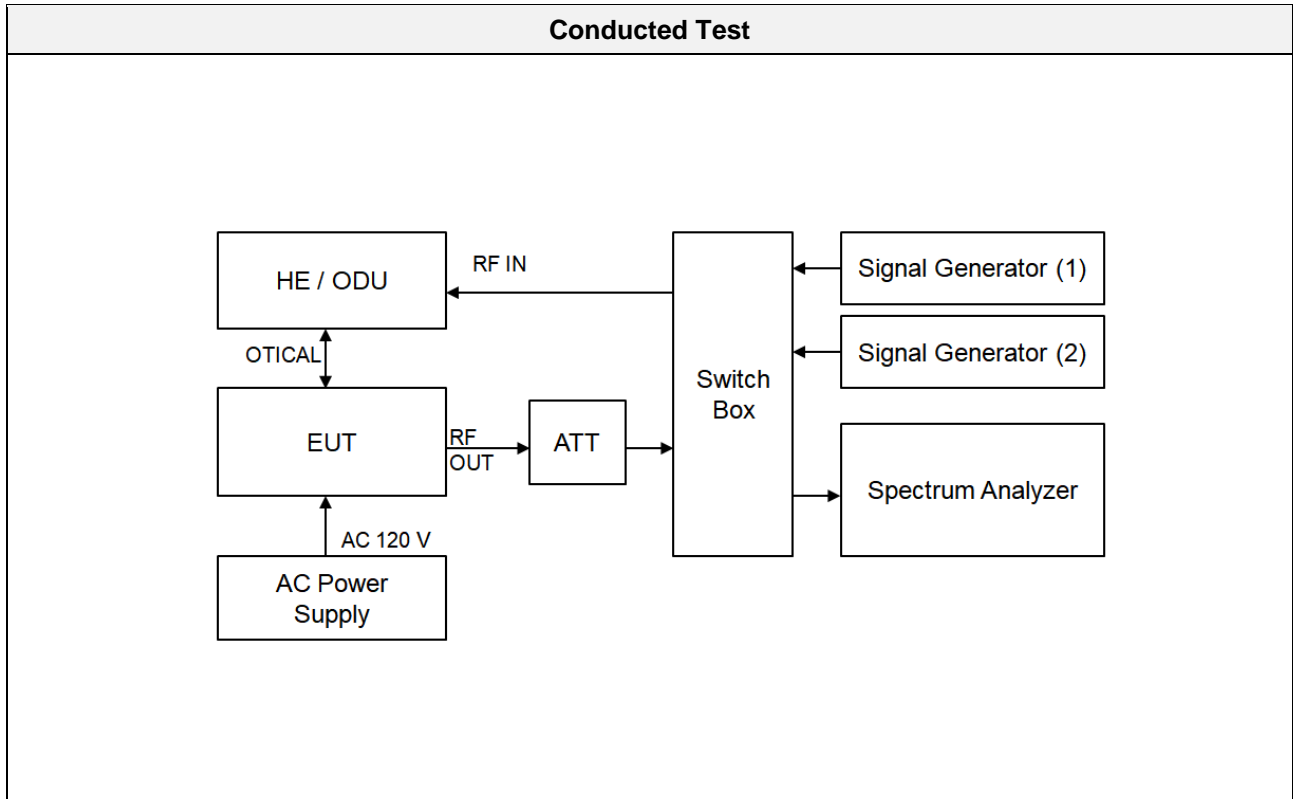

4. TEST EQUIPMENTS

Manufacturer	Model / Equipment	Calibration Date	Calibration Interval	Serial No.
Agilent	N9020A / MXA Signal Analyzer	08/29/2018	Annual	MY52440870
Agilent	N5182A / Signal Generator	08/09/2018	Annual	MY50140312
Agilent	N5182A / Signal Generator	08/30/2018	Annual	MY50142996
Agilent	8498A / High Power Attenuator	02/18/2019	Annual	51161
KEITHLEY	S46 / Switch	N/A	N/A	1088024
Deayoung ENT	DFSS60 / AC Power Supply	04/05/2018	Annual	1003030-1
Innco system	CO3000 / Controller(Antenna mast)	N/A	N/A	CO3000-4p
Innco system	MA4640/800-XP-EP / Antenna Position Tower	N/A	N/A	N/A
Emco	2090 / Controller	N/A	N/A	060520
Ets	- / Turn Table	N/A	N/A	N/A
Rohde&Schwarz	- / Loop Antenna	08/23/2018	Biennial	1513-175
Schwarzbeck	VULB 9168 / Hybrid Antenna	04/06/2017	Biennial	760
Schwarzbeck	BBHA 9120D / Horn Antenna	06/30/2017	Biennial	9120D-1300
Schwarzbeck	BBHA9170 / Horn Antenna(15 GHz ~ 40 GHz)	04/25/2017	Biennial	BBHA9170124
Rohde&Schwarz	FSP / Spectrum Analyzer	09/19/2018	Annual	836650/016
Wainwright Instruments	WHKX10-900-1000-15000-40SS / High Pass Filter	07/20/2018	Annual	5
Wainwright Instruments	WHKX10-2700-3000-18000-40SS / High Pass Filter	07/20/2018	Annual	3
CERNEX	CBLU1183540 / Power Amplifier	07/10/2018	Annual	22964
CERNEX	CBL06185030 / Power Amplifier	07/10/2018	Annual	22965
CERNEX	CBL26405040 / Power Amplifier	07/10/2018	Annual	19660

5. TEST RESULT

5.1. AGC THRESHOLD

Test Requirement:

KDB 935210 D05 v01r02

Testing at and above the AGC threshold is required.

Test Procedures:

Measurements were in accordance with the test methods section 3.2 of KDB 935210 D05 v01r02.

In the case of fiber-optic distribution systems, the RF input port of the equipment under test (EUT) refers to the RF input of the supporting equipment RF to optical convertor; see also descriptions and diagrams for typical DAS booster systems in KDB Publication 935210 D02

Devices intended to be directly connected to an RF source (donor port) only need to be evaluated for any over-the-air transmit paths.

- a) Connect a signal generator to the input of the EUT.
- b) Connect a spectrum analyzer or power meter to the output of the EUT using appropriate attenuation as necessary.
- c) The signal generator should initially be configured to produce either of the required test signals.
- d) Set the signal generator frequency to the center frequency of the EUT operating band.
- e) While monitoring the output power of the EUT, measured using the methods of ANSI C63.26-2015 subclause 5.2.4.4.1, increase the input level until a 1 dB increase in the input signal power no longer causes a 1 dB increase in the output signal power.
- f) Record this level as the AGC threshold level.
- g) Repeat the procedure with the remaining test signal.

Output power measurement in subclause 5.2.4.4.1 of ANSI C63.26

- a) Set span to $2 \times$ to $3 \times$ the OBW.
- b) Set RBW = 1% to 5% of the OBW.
- c) Set VBW $\geq 3 \times$ RBW.
- d) Set number of measurement points in sweep $\geq 2 \times$ span / RBW.
- e) Sweep time: auto-couple
- f) Detector = power averaging (rms).
- g) If the EUT can be configured to transmit continuously, then set the trigger to free run.
- h) Omit
- i) Trace average at least 100 traces in power averaging (rms) mode if sweep is set to auto-couple. To

accurately determine the average power over multiple symbols, it can be necessary to increase the number of traces to be averaged above 100 or, if using a manually configured sweep time, increase the sweep time.

j) Compute the power by integrating the spectrum across the OBW of the signal using the instrument's band or channel power measurement function, with the band/channel limits set equal to the OBW band edges. If the instrument does not have a band or channel power function, then sum the spectrum levels (in linear power units) at intervals equal to the RBW extending across the entire OBW of the spectrum.

Test Results:

Test Band	Link	Signal	Center Frequency (MHz)	AGC Threshold Level (dBm)	Output Level (dBm)
AWS	Uplink	LTE 20M	1 732.50	-62	32.70
	Downlink	LTE 20M	2 145.00	-62	32.84

5.2. OUT-OF-BAND REJECTION

Test Requirement:

KDB 935210 D05 v01r02

Out-of-band rejection required.

Test Procedures:

Measurements were in accordance with the test methods section 3.3 of KDB 935210 D05 v01r02.

Adjust the internal gain control of the EUT to the maximum gain for which equipment certification is sought.

- a) Connect a signal generator to the input of the EUT.
- b) Configure a swept CW signal with the following parameters:
 - 1) Frequency range = $\pm 250\%$ of the passband, for each applicable CMRS band.
 - 2) Level = a sufficient level to affirm that the out-of-band rejection is > 20 dB above the noise floor and will not engage the AGC during the entire sweep.
 - 3) Dwell time = approximately 10 ms.
 - 4) Number of points = $\text{SPAN}/(\text{RBW}/2)$.
- c) Connect a spectrum analyzer to the output of the EUT using appropriate attenuation.
- d) Set the span of the spectrum analyzer to the same as the frequency range of the signal generator.
- e) Set the resolution bandwidth (RBW) of the spectrum analyzer to be 1 % to 5 % of the EUT passband, and the video bandwidth (VBW) shall be set to $\geq 3 \times \text{RBW}$.
- f) Set the detector to Peak Max-Hold and wait for the spectrum analyzer's spectral display to fill.
- g) Place a marker to the peak of the frequency response and record this frequency as f_0 .
- h) Place two markers, one at the lowest and the other at the highest frequency of the envelope of the spectral display, such that each marker is at or slightly below the -20 dB down amplitude, to determine the 20 dB bandwidth.
- i) Capture the frequency response of the EUT.
- j) Repeat for all frequency bands applicable for use by the EUT.

Test Results:

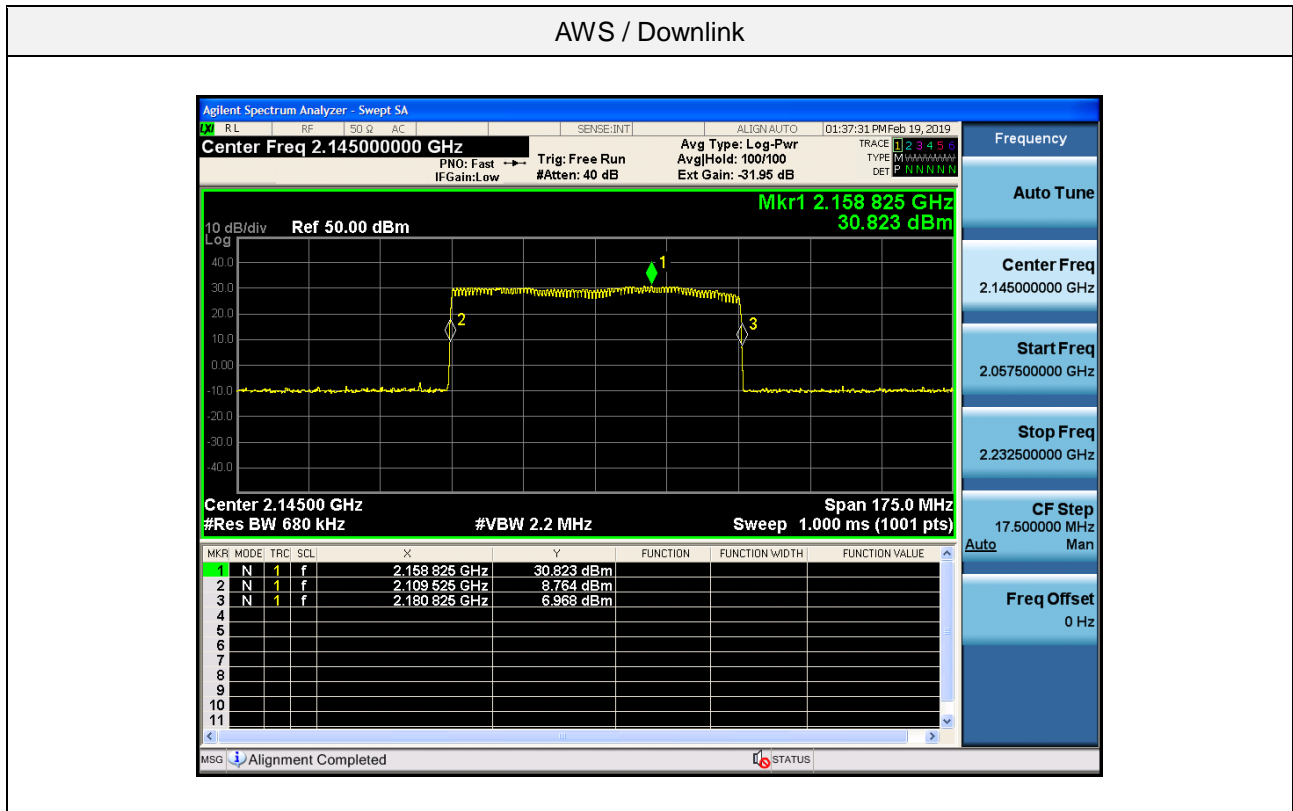
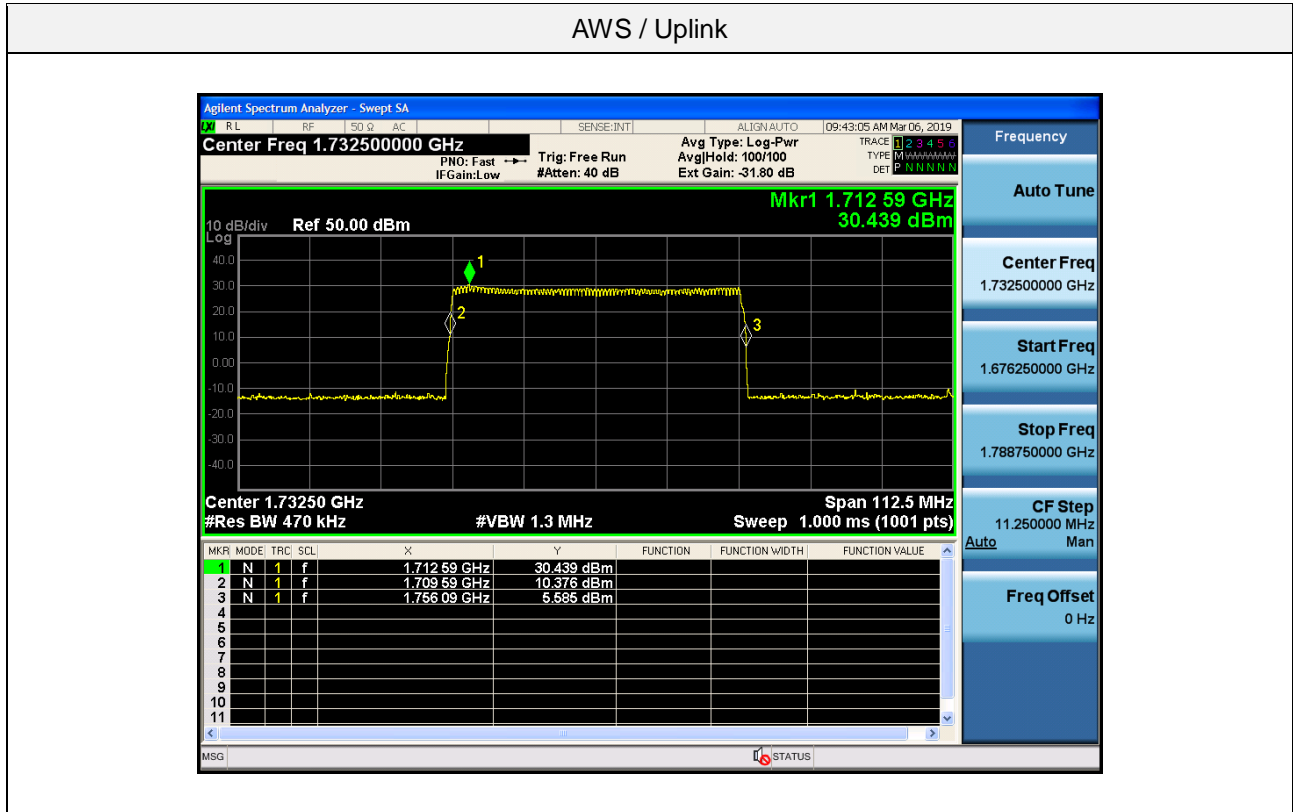

5.3. INPUT-VERSUS-OUTPUT SIGNAL COMPARISON

Test Requirement:**§2.1049 Measurements required: Occupied bandwidth.**

The occupied bandwidth, that is the frequency bandwidth such that, below its lower and above its upper frequency limits, the mean powers radiated are each equal to 0.5 percent of the total mean power radiated by a given emission shall be measured under the specified conditions of § 2.1049 (a) through (i) as applicable.

Test Procedures:

Measurements were in accordance with the test methods section 3.4 of KDB 935210 D05 v01r02.

- a) Connect a signal generator to the input of the EUT.
- b) Configure the signal generator to transmit the AWGN signal.
- c) Configure the signal amplitude to be just below the AGC threshold level (see 3.2), but not more than 0.5 dB below.
- d) Connect a spectrum analyzer to the output of the EUT using appropriate attenuation.
- e) Set the spectrum analyzer center frequency to the center frequency of the operational band under test. The span range of the spectrum analyzer shall be between 2 times to 5 times the emission bandwidth (EBW) or alternatively, the OBW.
- f) The nominal RBW shall be in the range of 1 % to 5 % of the anticipated OBW, and the VBW shall be $\geq 3 \times$ RBW.
- g) Set the reference level of the instrument as required to preclude the signal from exceeding the maximum spectrum analyzer input mixer level for linear operation. In general, the peak of the spectral envelope must be more than $[10 \log (OBW / RBW)]$ below the reference level. Steps f) and g) may require iteration to enable adjustments within the specified tolerances.
- h) The noise floor of the spectrum analyzer at the selected RBW shall be at least 36 dB below the reference level.
- i) Set spectrum analyzer detection function to positive peak.
- j) Set the trace mode to max hold.
- k) Determine the reference value: Allow the trace to stabilize. Set the spectrum analyzer marker to the highest amplitude level of the displayed trace (this is the reference value) and record the associated frequency as f_0 .
- l) Place two markers, one at the lowest and the other at the highest frequency of the envelope of the spectral display, such that each marker is at or slightly below the -26 dB down amplitude. The 26 dB EBW (alternatively OBW) is the positive frequency difference between the two markers. If the spectral envelope crosses the -26 dB down amplitude at multiple points, the lowest or highest frequency shall be selected as the frequencies that are the furthest removed from the center frequency at which the spectral envelope crosses the -26 dB down amplitude point.

- m) Repeat steps e) to l) with the input signal connected directly to the spectrum analyzer (i.e., input signal measurement).
- n) Compare the spectral plot of the input signal (determined from step m) to the output signal (determined from step l) to affirm that they are similar (in passband and rolloff characteristic features and relative spectral locations), and include plot(s) and descriptions in test report.
- o) Repeat the procedure [steps e) to n)] with the input signal amplitude set to 3 dB above the AGC threshold.
- p) Repeat steps e) to o) with the signal generator set to the narrowband signal.
- q) Repeat steps e) to p) for all frequency bands authorized for use by the EUT.

Test Results:

Tabular data of Output Occupied Bandwidth

Test awBand	Link	Signal	Center Frequency (MHz)	99 % OBW (MHz)	26 dB OBW (MHz)
AWS	Uplink	LTE 20M	1 732.50	17.953	19.44
	Downlink	LTE 20M	2 145.00	17.942	19.47

Tabular data of Input Occupied Bandwidth

Test Band	Link	Signal	Center Frequency (MHz)	99 % OBW (MHz)	26 dB OBW (MHz)
AWS	Uplink	LTE 20M	1 732.50	17.978	19.79
	Downlink	LTE 20M	2 145.00	17.952	19.93

Tabular data of 3 dB above the AGC threshold Output Occupied Bandwidth

Test Band	Link	Signal	Center Frequency (MHz)	99 % OBW (MHz)	26 dB OBW (MHz)
AWS	Uplink	LTE 20M	1 732.50	17.931	19.32
	Downlink	LTE 20M	2 145.00	17.967	19.53

Measured Occupied Bandwidth Comparison

Test Band	Link	Signal	Variant of Input and output Occupied Bandwidth (%)	Variant of Input and 3 dB above the AGC threshold output Occupied Bandwidth (%)
AWS	Uplink	LTE 20M	-1.769	-2.375
	Downlink	LTE 20M	-2.308	-2.007

* Change in input-output OBW is less than $\pm 5\%$.

Plot data of Occupied Bandwidth

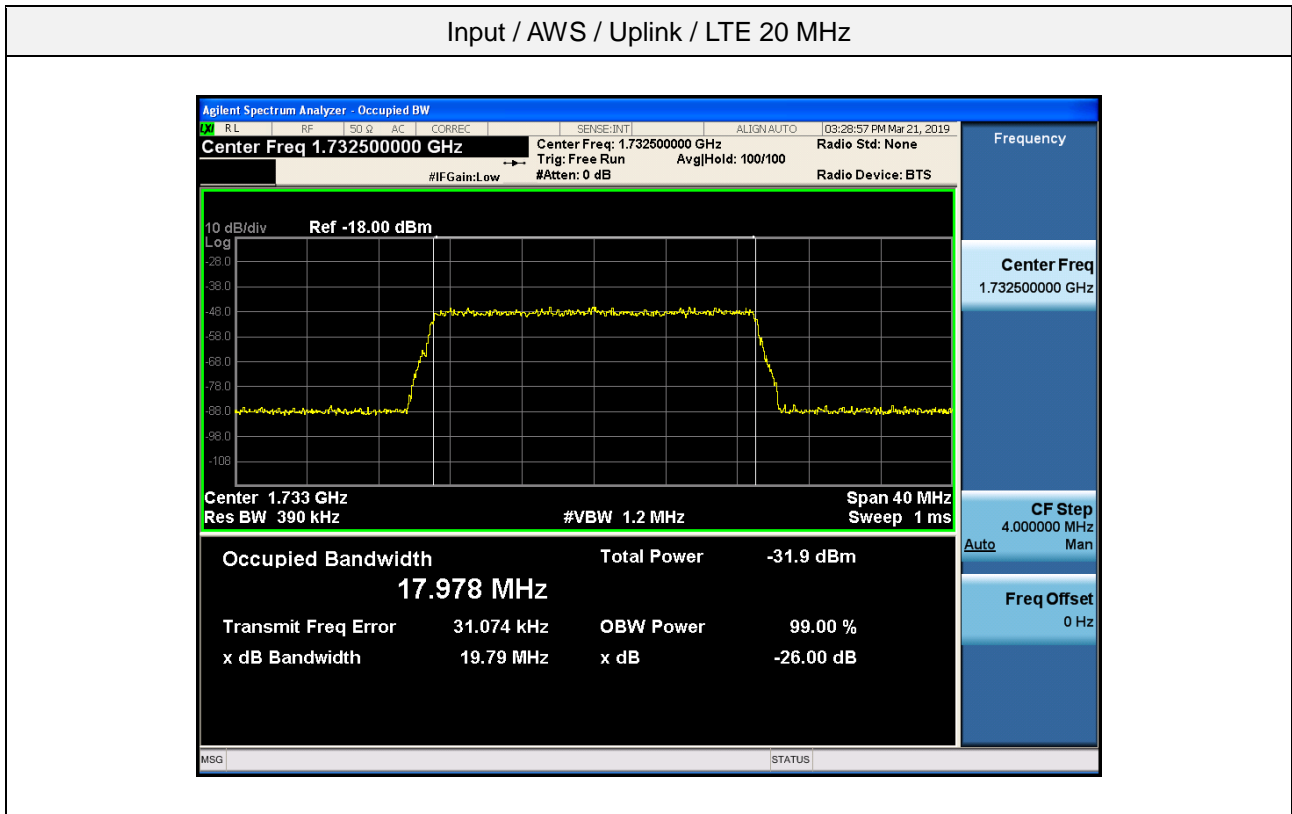
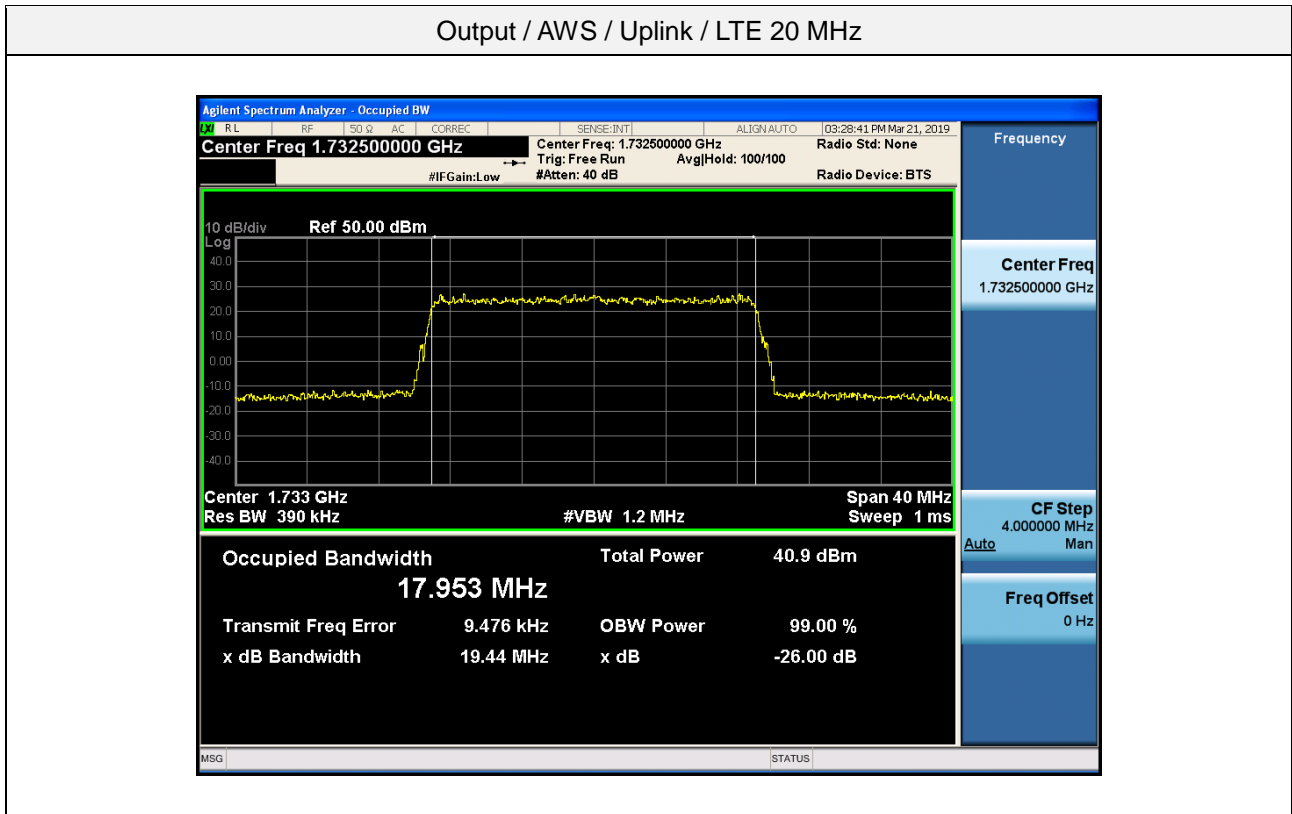

3 dB above the AGC threshold output / AWS / Uplink / LTE 20 MHz

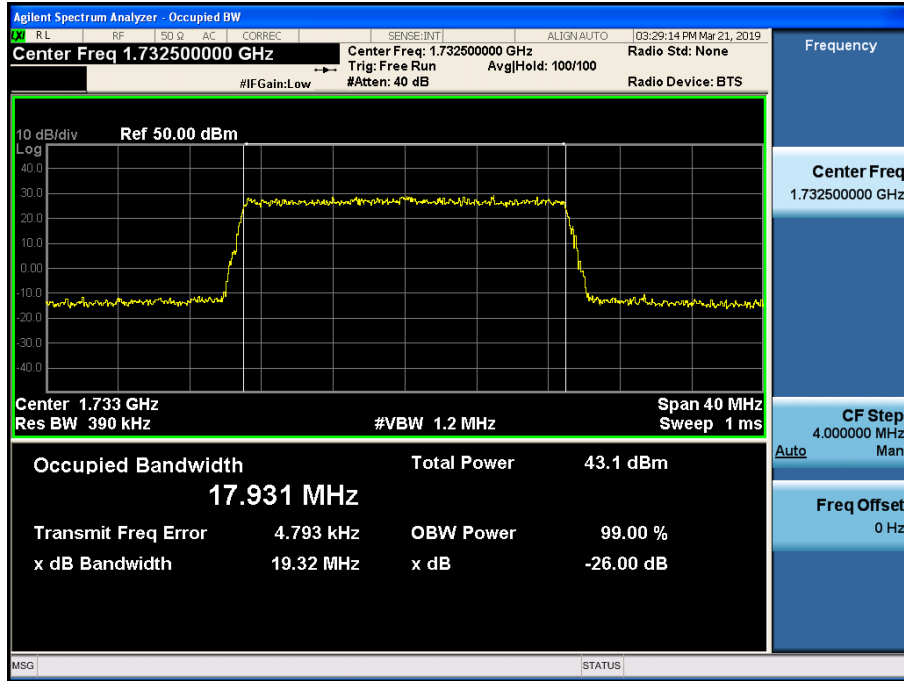

Output / AWS / Downlink / LTE 20 MHz

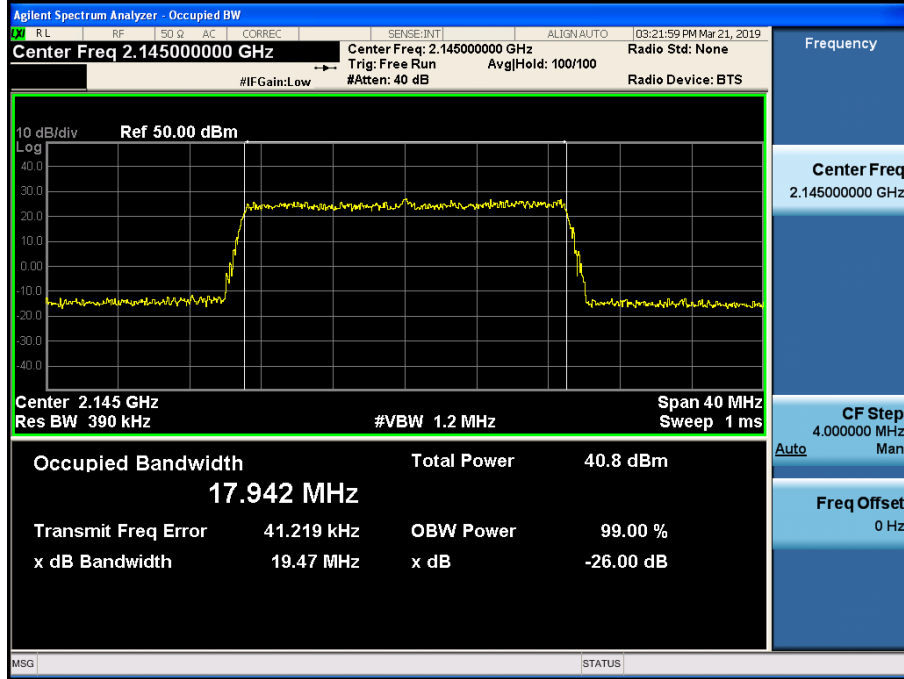

Input / AWS / Downlink / LTE 20 MHz

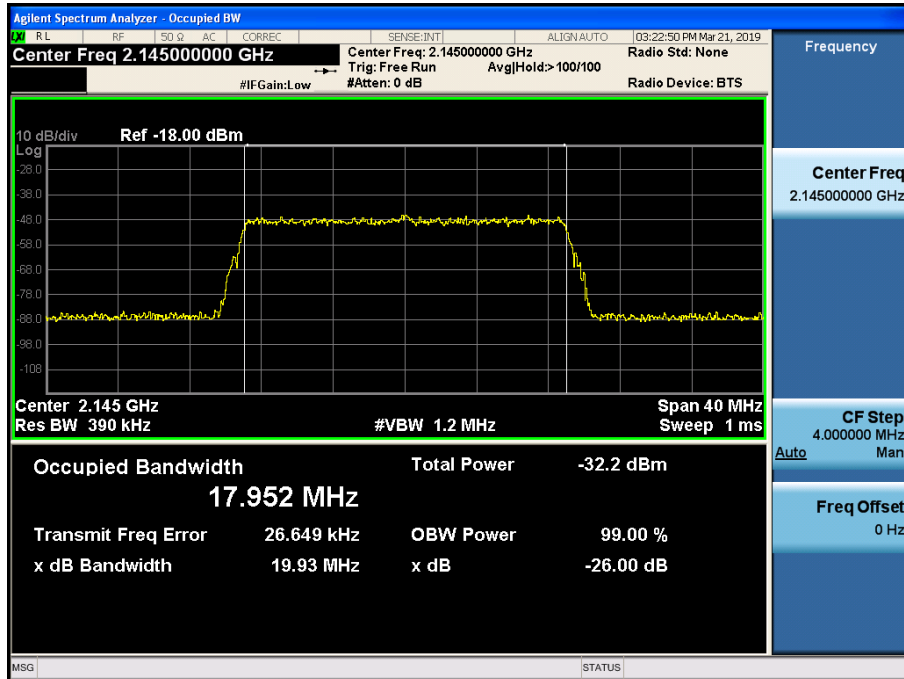

3 dB above the AGC threshold output / AWS / Downlink / LTE 20 MHz

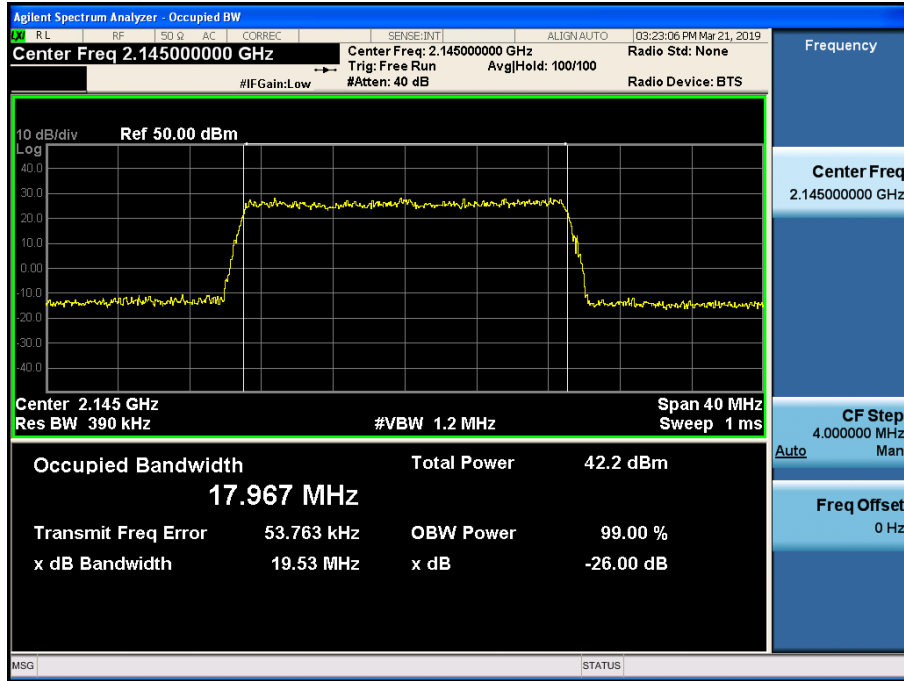

5.4. INPUT/OUTPUT POWER AND AMPLIFIER/BOOSTER GAIN

Test Requirement:

§2.1046 Measurements required: RF power output.

(a) For transmitters other than single sideband, independent sideband and controlled carrier radiotelephone, power output shall be measured at the RF output terminals when the transmitter is adjusted in accordance with the tune-up procedure to give the values of current and voltage on the circuit elements specified in §2.1033(c)(8). The electrical characteristics of the radio frequency load attached to the output terminals when this test is made shall be stated.

(b) For single sideband, independent sideband, and single channel, controlled carrier radiotelephone transmitters the procedure specified in paragraph (a) of this section shall be employed and, in addition, the transmitter shall be modulated during the test as specified and applicable in § 2.1046 (b) (1-5). In all tests, the input level of the modulating signal shall be such as to develop rated peak envelope power or carrier power, as appropriate, for the transmitter.

(c) For measurements conducted pursuant to paragraphs (a) and (b) of this section, all calculations and methods used by the applicant for determining carrier power or peak envelope power, as appropriate, on the basis of measured power in the radio frequency load attached to the transmitter output terminals shall be shown. Under the test conditions specified, no components of the emission spectrum shall exceed the limits specified in the applicable rule parts as necessary for meeting occupied bandwidth or emission limitations.

§27.50 Power limits and duty cycle.

(d) The following power and antenna height requirements apply to stations transmitting in the 1695-1710 MHz, 1710-1755 MHz, 1755-1780 MHz, 1915-1920 MHz, 1995-2000 MHz, 2000-2020 MHz, 2110-2155 MHz, 2155-2180 MHz and 2180-2200 MHz bands:

(1) The power of each fixed or base station transmitting in the 1995-2000 MHz, 2110-2155 MHz, 2155-2180 MHz or 2180-2200 MHz band and located in any county with population density of 100 or fewer persons per square mile, based upon the most recently available population statistics from the Bureau of the Census, is limited to:

(i) An equivalent isotropically radiated power (EIRP) of 3280 watts when transmitting with an emission bandwidth of 1 MHz or less;

(ii) An EIRP of 3280 watts/MHz when transmitting with an emission bandwidth greater than 1 MHz.

(2) The power of each fixed or base station transmitting in the 1995-2000 MHz, the 2110-2155 MHz 2155-2180 MHz band, or 2180-2200 MHz band and situated in any geographic location other than that described in paragraph (d)(1) of this section is limited to:

(i) An equivalent isotropically radiated power (EIRP) of 1640 watts when transmitting with an emission bandwidth of 1 MHz or less;

(ii) An EIRP of 1640 watts/MHz when transmitting with an emission bandwidth greater than 1 MHz.

(3) A licensee operating a base or fixed station in the 2110-2155 MHz band utilizing a power greater than 1640 watts EIRP and greater than 1640 watts/MHz EIRP must coordinate such operations in advance with all Government and non-Government satellite entities in the 2025-2110 MHz band. A licensee operating a base or fixed station in the 2110-2180 MHz band utilizing power greater than 1640 watts EIRP and greater than 1640 watts/MHz EIRP must be coordinated in advance with the following licensees authorized to operate within 120 kilometers (75 miles) of the base or fixed station operating in this band: All Broadband Radio Service (BRS) licensees authorized under this part in the 2155-2160 MHz band and all advanced wireless services (AWS) licensees authorized to operate on adjacent frequency blocks in the 2110-2180 MHz band.

(4) Fixed, mobile, and portable (hand-held) stations operating in the 1710-1755 MHz band and mobile and portable stations operating in the 1695-1710 MHz and 1755-1780 MHz bands are limited to 1 watt EIRP. Fixed stations operating in the 1710-1755 MHz band are limited to a maximum antenna height of 10 meters above ground. Mobile and portable stations operating in these bands must employ a means for limiting power to the minimum necessary for successful communications.

(5) Equipment employed must be authorized in accordance with the provisions of §24.51. Power measurements for transmissions by stations authorized under this section may be made either in accordance with a Commission-approved average power technique or in compliance with paragraph (d)(6) of this section. In measuring transmissions in this band using an average power technique, the peak-to-average ratio (PAR) of the transmission may not exceed 13 dB.

(6) Peak transmit power must be measured over any interval of continuous transmission using instrumentation calibrated in terms of an rms-equivalent voltage. The measurement results shall be properly adjusted for any instrument limitations, such as detector response times, limited resolution bandwidth capability when compared to the emission bandwidth, sensitivity, etc., so as to obtain a true peak measurement for the emission in question over the full bandwidth of the channel.

Test Procedures:

Measurements were in accordance with the test methods section 3.5 of KDB 935210 D05 v01r02.

Adjust the internal gain control of the EUT to the maximum gain for which the equipment certification is being sought. Any EUT attenuation settings shall be set to their minimum value.

Input power levels (uplink and downlink) should be set to maximum input ratings while confirming that the device is not capable of operating in saturation (non-linear mode) at the rated input levels, including during the performance of the input/output power measurements.

3.5.2 Measuring the EUT mean input and output power

- a) Connect a signal generator to the input of the EUT.
- b) Configure to generate the test signal.
- c) The frequency of the signal generator shall be set to the frequency f_0 as determined from out-of-band rejection test.

- d) Connect a spectrum analyzer or power meter to the output of the EUT using appropriate attenuation as necessary.
- e) Set the signal generator output power to a level that produces an EUT output level that is just below the AGC threshold, but not more than 0.5 dB below.
- f) Measure and record the output power of the EUT; use ANSI C63.26-2015 subclause 5.2.4.4.1, for power measurement.
- g) Remove the EUT from the measurement setup. Using the same signal generator settings, repeat the power measurement at the signal generator port, which was used as the input signal to the EUT, and record as the input power. EUT gain may be calculated as described in 3.5.5.
- h) Repeat steps f) and g) with input signal amplitude set to 3 dB above the AGC threshold level.
- i) Repeat steps e) to h) with the narrowband test signal.
- j) Repeat steps e) to i) for all frequency bands authorized for use by the EUT.

3.5.5 Calculating amplifier, repeater, or industrial booster gain

After the input and output power levels have been measured as described in the preceding subclauses, the gain of the EUT can be determined from:

$$\text{Gain (dB)} = \text{output power (dBm)} - \text{input power (dBm)}.$$

Report the gain for each authorized operating frequency band, and each test signal stimulus.

Note1. If f_0 that determined from out-of-band test is smaller or greater than difference of test signal's center frequency and operation band block, test is performed at the lowest or the highest frequency that test signals can be passed.

Test Results:

Tabular data of Input / Output Power and Gain

Test Band	Link	Signal	f ₀ Frequency (MHz)	Input Power (dBm)	Output Power (dBm)	Gain (dB)
AWS	Uplink	LTE 20M	1 720.00	-62.12	32.70	94.82
	Downlink	LTE 20M	2 158.83	-61.66	32.74	94.40

Tabular data of Input / 3 dB above AGC threshold Output Power and Gain

Test Band	Link	Signal	f ₀ Frequency (MHz)	Input Power (dBm)	+3 dB Output Power (dBm)	Gain (dB)
AWS	Uplink	LTE 20M	1 720.00	-62.12	33.09	95.21
	Downlink	LTE 20M	2 158.83	-61.66	32.33	93.99

Tabular data of PAPR

Test Band	Link	Signal	f ₀ Frequency (MHz)	0.1 % PAPR (dB)
AWS	Uplink	LTE 20M	1 720.00	8.49
	Downlink	LTE 20M	2 158.83	8.43

Plot data of PAPR

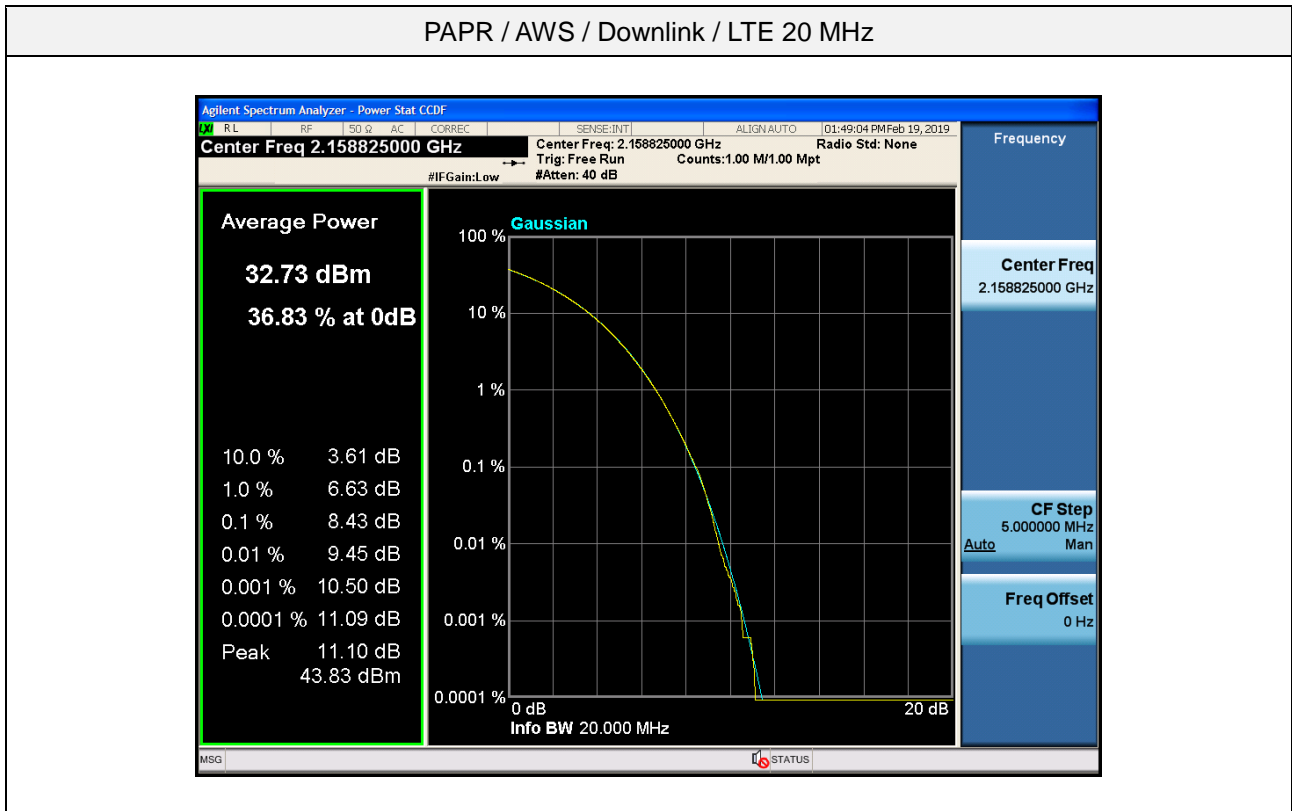
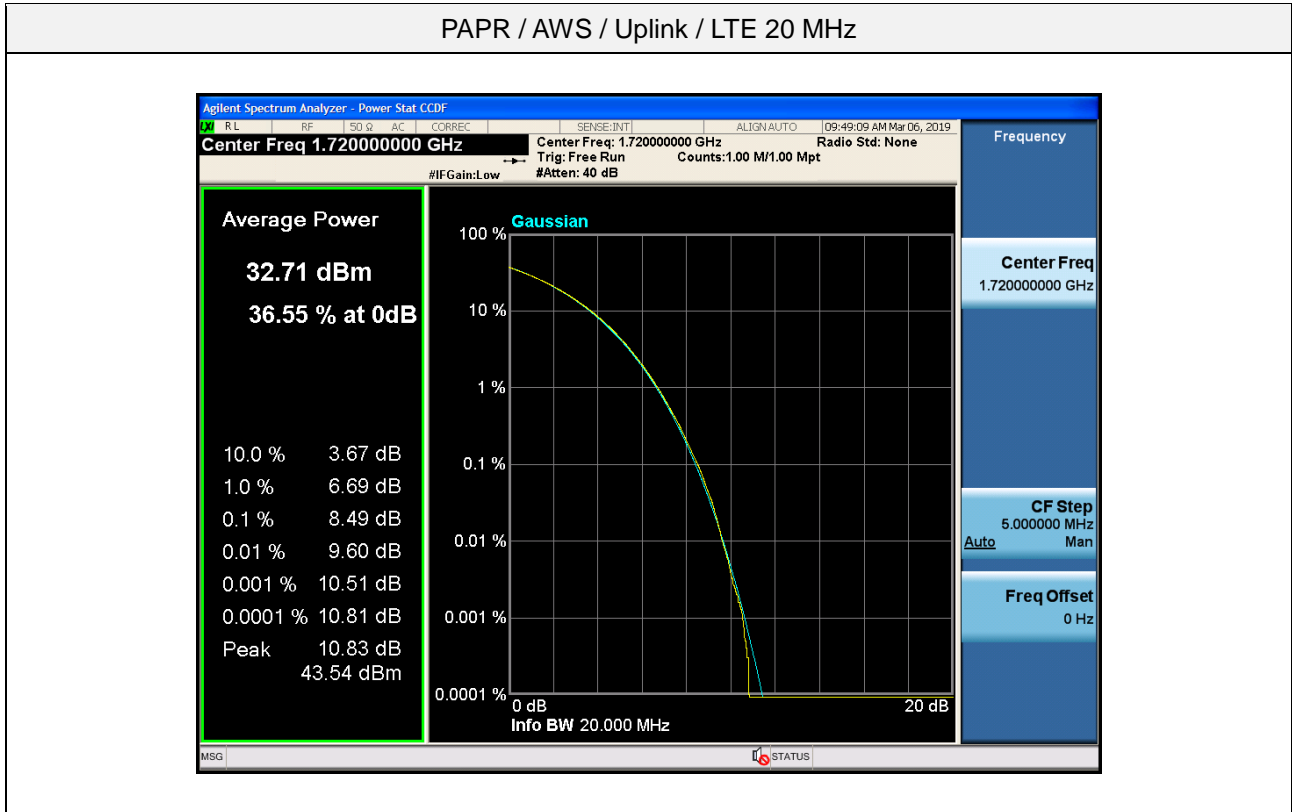

5.5. OUT-OF-BAND/OUT-OF-BLOCK EMISSIONS AND SPURIOUS EMISSIONS

Test Requirements:

§2.1051 Measurements required: Spurious emissions at antenna terminals.

The radio frequency voltage or powers generated within the equipment and appearing on a spurious frequency shall be checked at the equipment output terminals when properly loaded with a suitable artificial antenna. Curves or equivalent data shall show the magnitude of each harmonic and other spurious emission that can be detected when the equipment is operated under the conditions specified in §2.1049 as appropriate. The magnitude of spurious emissions which are attenuated more than 20 dB below the permissible value need not be specified.

§27.53 Emission limits.

(h) AWS emission limits

(1) General protection levels. Except as otherwise specified below, for operations in the 1695-1710 MHz, 1710-1755 MHz, 1755-1780 MHz, 1915-1920 MHz, 1995-2000 MHz, 2000-2020 MHz, 2110-2155 MHz, 2155-2180 MHz, and 2180-2200 bands, the power of any emission outside a licensee's frequency block shall be attenuated below the transmitter power (P) in watts by at least $43 + 10 \log_{10}(P)$ dB.

(3) Measurement procedure.

(i) Compliance with this provision is based on the use of measurement instrumentation employing a resolution bandwidth of 1 megahertz or greater. However, in the 1 megahertz bands immediately outside and adjacent to the licensee's frequency block, a resolution bandwidth of at least one percent of the emission bandwidth of the fundamental emission of the transmitter may be employed. The emission bandwidth is defined as the width of the signal between two points, one below the carrier center frequency and one above the carrier center frequency, outside of which all emissions are attenuated at least 26 dB below the transmitter power.

(ii) When measuring the emission limits, the nominal carrier frequency shall be adjusted as close to the licensee's frequency block edges, both upper and lower, as the design permits.

(iii) The measurements of emission power can be expressed in peak or average values, provided they are expressed in the same parameters as the transmitter power.

Test Procedures:

Measurements were in accordance with the test methods section 3.6 of KDB 935210 D05 v01r02.

Spurious emissions shall be measured using a single test signal sequentially tuned to the low, middle, and high channels or frequencies within each authorized frequency band of operation.

Out-of-band/out-of-block emissions (including intermodulation products) shall be measured under each of the following two stimulus conditions:

a) two adjacent test signals sequentially tuned to the lower and upper frequency band/block edges;

b) a single test signal, sequentially tuned to the lowest and highest frequencies or channels within the

frequency band/block under examination.

NOTE—Single-channel boosters that cannot accommodate two simultaneous signals within the passband may be excluded from the test stipulated in step a).

3.6.2 Out-of-band/out-of-block emissions conducted measurements

a) Connect a signal generator to the input of the EUT.

If the signal generator is not capable of generating two modulated carriers simultaneously, then two discrete signal generators can be connected with an appropriate combining network to support this two-signal test.

b) Set the signal generator to produce two AWGN signals as previously described.

c) Set the center frequencies such that the AWGN signals occupy adjacent channels, as defined by industry standards such as 3GPP or 3GPP2, at the upper edge of the frequency band or block under test.

d) Set the composite power levels such that the input signal is just below the AGC threshold, but not more than 0.5 dB below. The composite power can be measured using the procedures provided in KDB Publication 971168, but it will be necessary to expand the power integration bandwidth so as to include both of the transmit channels.

e) Connect a spectrum analyzer to the output of the EUT using appropriate attenuation as necessary.

f) Set the RBW = reference bandwidth in the applicable rule section for the supported frequency band.

g) Set the VBW = 3 × RBW.

h) Set the detector to power averaging (rms) detector.

i) Set the Sweep time = auto-couple.

j) Set the spectrum analyzer start frequency to the upper block edge frequency, and the stop frequency to the upper block edge frequency plus 300 kHz or 3 MHz, for frequencies below and above 1 GHz, respectively.

k) Trace average at least 100 traces in power averaging (rms) mode.

l) Use the marker function to find the maximum power level.

m) Capture the spectrum analyzer trace of the power level for inclusion in the test report.

n) Repeat steps k) to m) with the composite input power level set to 3 dB above the AGC threshold.

o) Reset the frequencies of the input signals to the lower edge of the frequency block or band under test.

p) Reset the spectrum analyzer start frequency to the lower block edge frequency minus 300 kHz or 3 MHz, for frequencies below and above 1 GHz, respectively, and the stop frequency to the lower band or block edge frequency.

q) Repeat steps k) to n).

r) Repeat steps a) to q) with the signal generator configured for a single test signal tuned as close as possible to the block edges.

s) Repeat steps a) to r) with the narrowband test signal.

t) Repeat steps a) to s) for all authorized frequency bands or blocks used by the EUT.

3.6.3 Spurious emissions conducted measurements

- a) Connect a signal generator to the input of the EUT.
- b) Set the signal generator to produce the broadband test signal as previously described.
- c) Set the center frequency of the test signal to the lowest available channel within the frequency band or block.
- d) Set the EUT input power to a level that is just below the AGC threshold, but not more than 0.5 dB below.
- e) Connect a spectrum analyzer to the output of the EUT using appropriate attenuation as necessary.
- f) Set the RBW = reference bandwidth in the applicable rule section for the supported frequency band of operation.
- g) Set the VBW $\geq 3 \times$ RBW.
- h) Set the Sweep time = auto-couple.
- i) Set the spectrum analyzer start frequency to the lowest RF signal generated in the equipment, without going below 9 kHz, and the stop frequency to the lower band/block edge frequency minus 1 MHz. The number of measurement points in each sweep must be $\geq (2 \times \text{span}/\text{RBW})$, which may require that the measurement range defined by the start and stop frequencies be subdivided, depending on the available number of measurement points provided by the spectrum analyzer.
- j) Select the power averaging (rms) detector function.
- k) Trace average at least 10 traces in power averaging (rms) mode.
- l) Use the peak marker function to identify the highest amplitude level over each measured frequency range. Record the frequency and amplitude and capture a plot for inclusion in the test report.
- m) Reset the spectrum analyzer start frequency to the upper band/block edge frequency plus 1 MHz, and the spectrum analyzer stop frequency to 10 times the highest frequency of the fundamental emission. The number of measurement points in each sweep must be $\geq (2 \times \text{span}/\text{RBW})$, which may require that the measurement range defined by the start and stop frequencies be subdivided, depending on the available number of measurement points provided by the spectrum analyzer.
- n) Trace average at least 10 traces in power averaging (rms) mode.
- o) Use the peak marker function to identify the highest amplitude level over each of the measured frequency ranges. Record the frequency and amplitude and capture a plot for inclusion in the test report; also provide tabular data, if required.
- p) Repeat steps i) to o) with the input test signals firstly tuned to a middle band/block frequency/channel, and then tuned to a high band/block frequency/channel.
- q) Repeat steps b) to p) with the narrowband test signal.
- r) Repeat steps b) to q) for all authorized frequency bands/blocks used by the EUT.

Note1. In 9 kHz-150 kHz and 150 kHz-30 MHz bands, RBW was reduced to 1 kHz and 10 kHz and correction factor was applied according to section 5.7.2 of ANSI C63.26-2015

Band	9 ~ 150 kHz Correction	150 kHz ~ 30 MHz Correction
Above 1 GHz (Ref.RBW: 1 MHz)	30 dB	20 dB

Note2. Measurement bandwidth specified in the applicable rule section for the supported frequency band.

Band	RBW Requirements
AWS	Reference 1 MHz or greater 1 % of fundamental emission bandwidth in the 1 MHz bands immediately block outside

Test Results:

Plot data of Out-of-band/out-of-block emissions

Out-of-band (two adjacent test signals) / AWS / Uplink / LTE 20 MHz / Upper

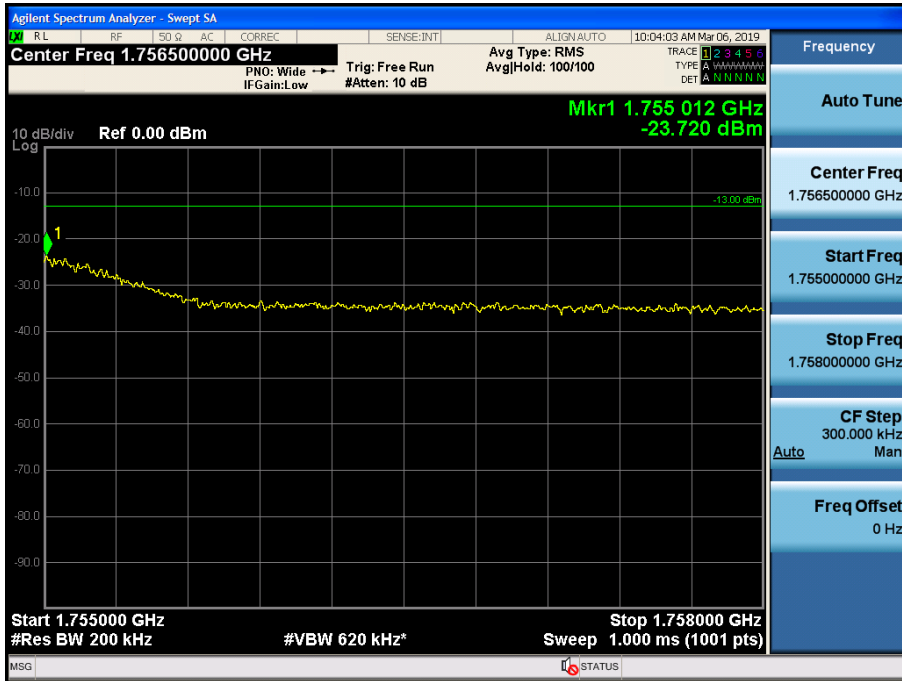

Out-of-band (two adjacent test signals) / AWS / Uplink / LTE 20 MHz / Lower

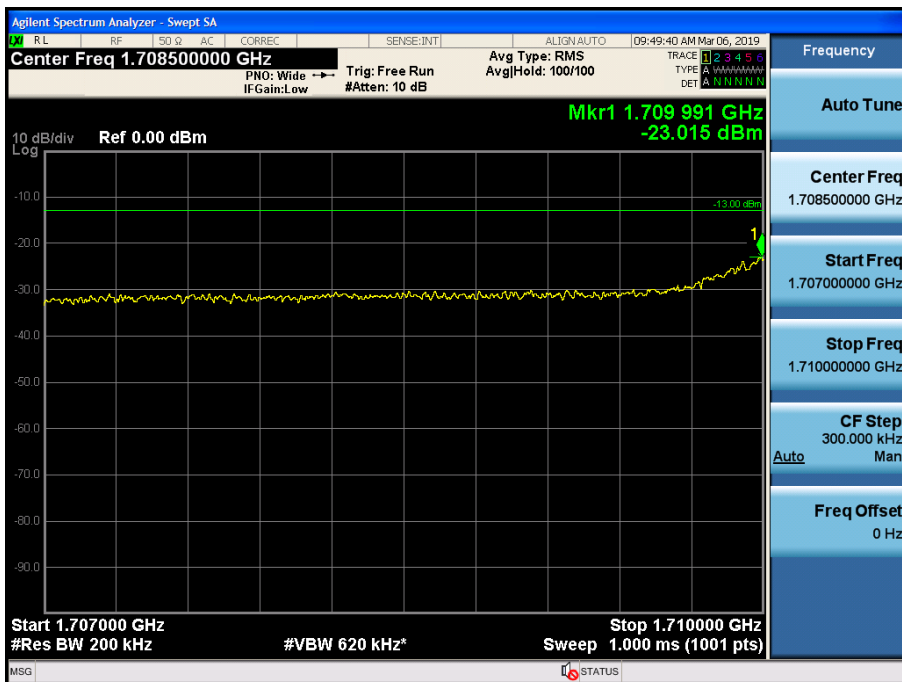

+3 dB above Out-of-band (two adjacent test signals) / AWS / Uplink / LTE 20 MHz / Upper

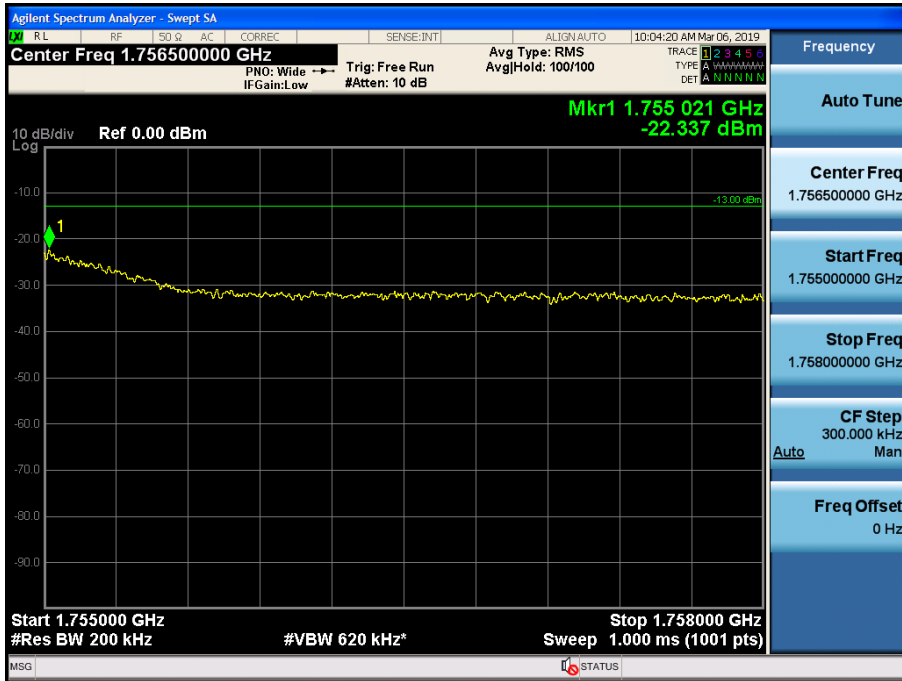

+3 dB above Out-of-band (two adjacent test signals) / AWS / Uplink / LTE 20 MHz / Lower

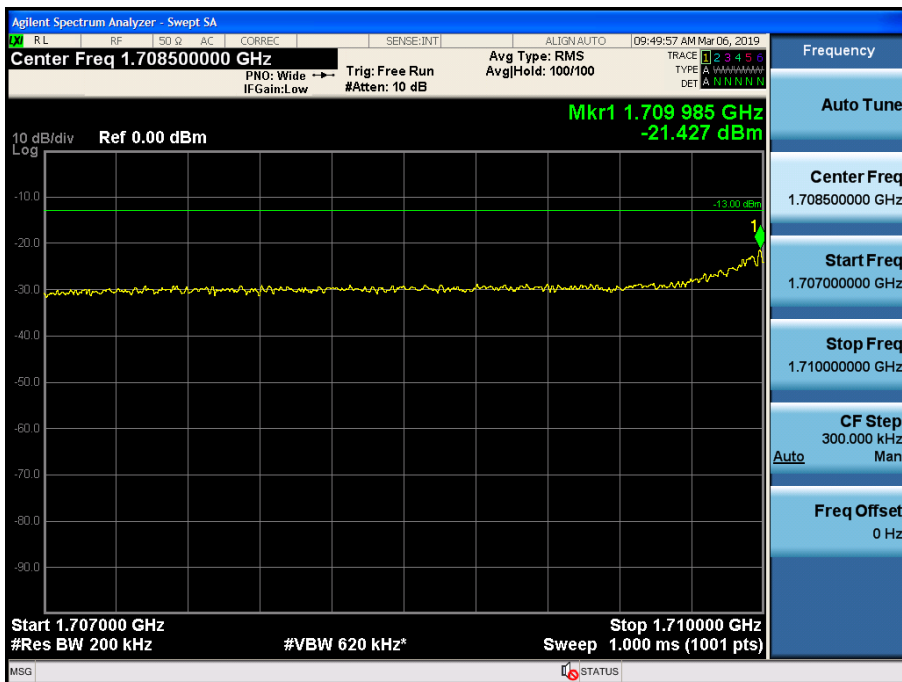

Out-of-band (two adjacent test signals) / AWS / Downlink / LTE 20 MHz / Upper

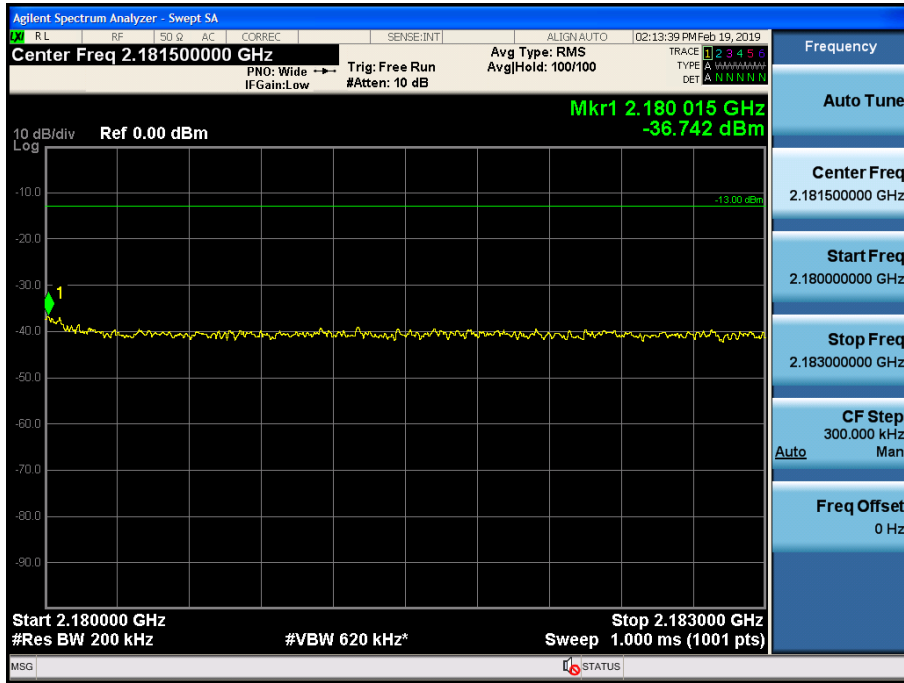

Out-of-band (two adjacent test signals) / AWS / Downlink / LTE 20 MHz / Lower

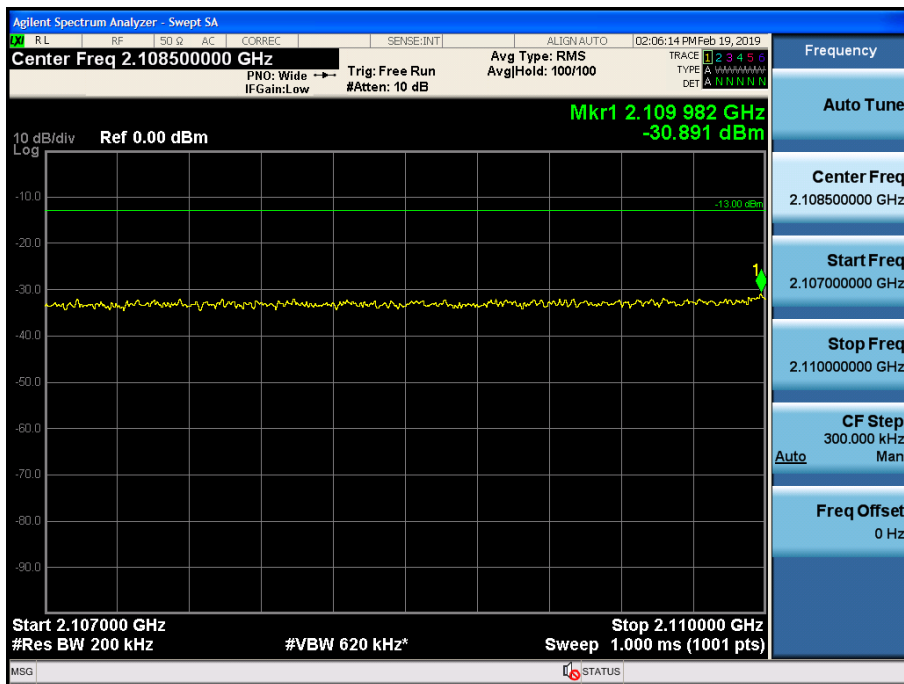

+3 dB above Out-of-band (two adjacent test signals) / AWS / Downlink / LTE 20 MHz / Upper

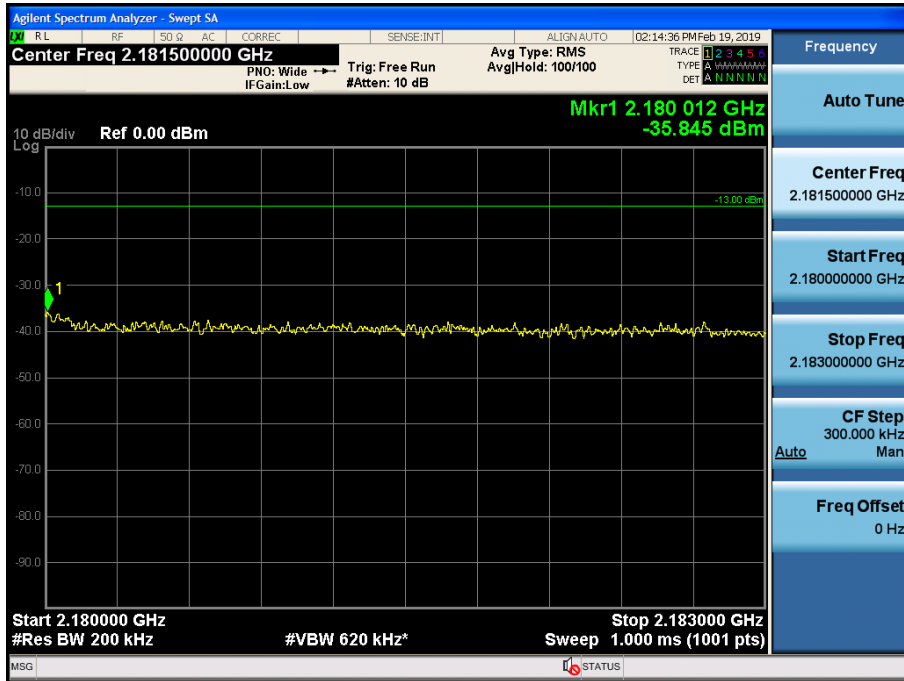

+3 dB above Out-of-band (two adjacent test signals) / AWS / Downlink / LTE 20 MHz / Lower

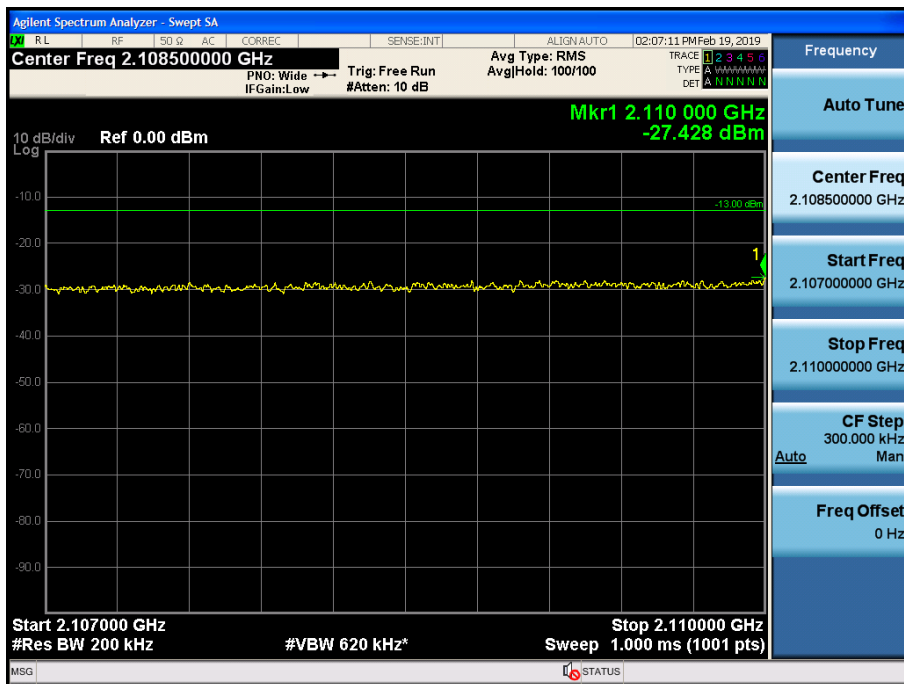

Out-of-band (single test signals) / AWS / Uplink / LTE 20 MHz / Upper

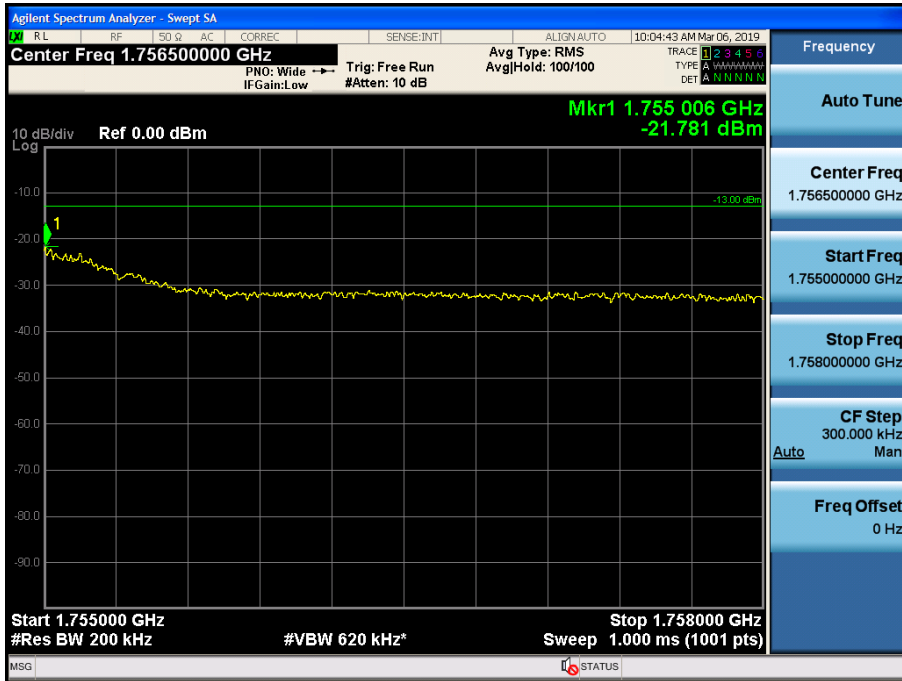

Out-of-band (single test signals) / AWS / Uplink / LTE 20 MHz / Lower

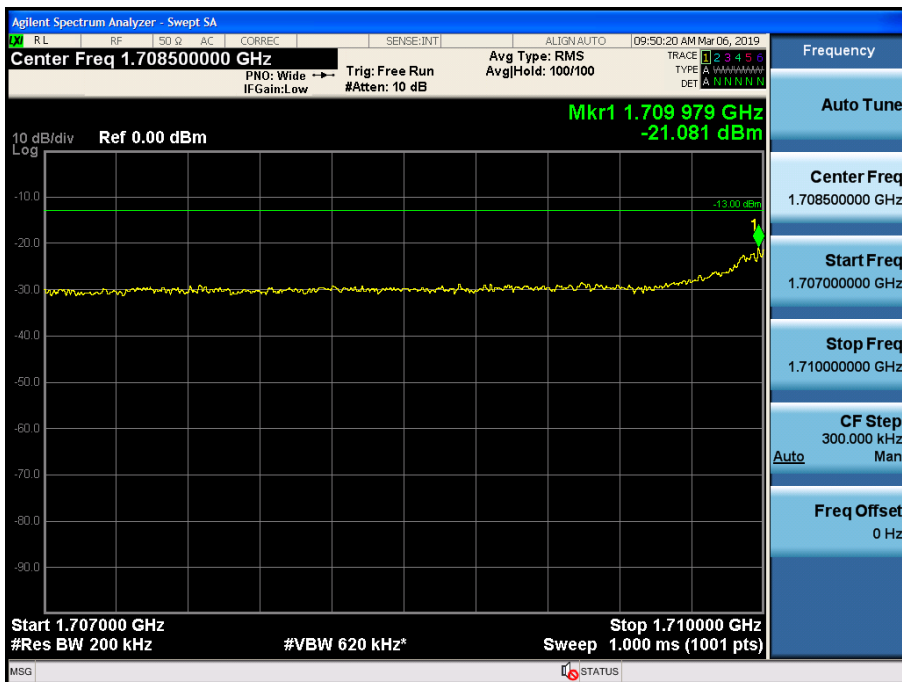

+3 dB above Out-of-band (single test signals) / AWS / Uplink / LTE 20 MHz / Upper

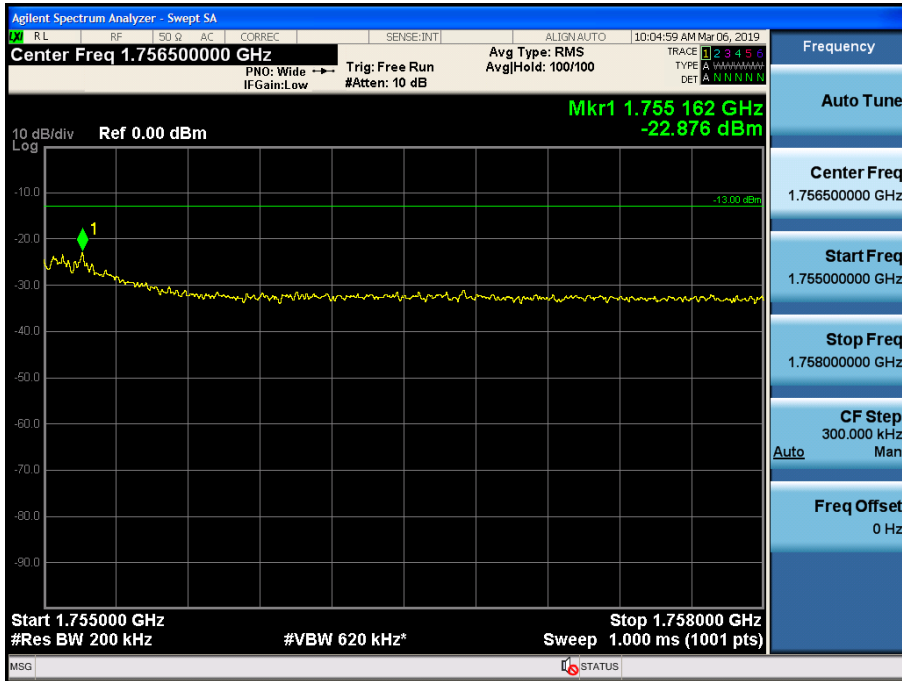

+3 dB above Out-of-band (single test signals) / AWS / Uplink / LTE 20 MHz / Lower

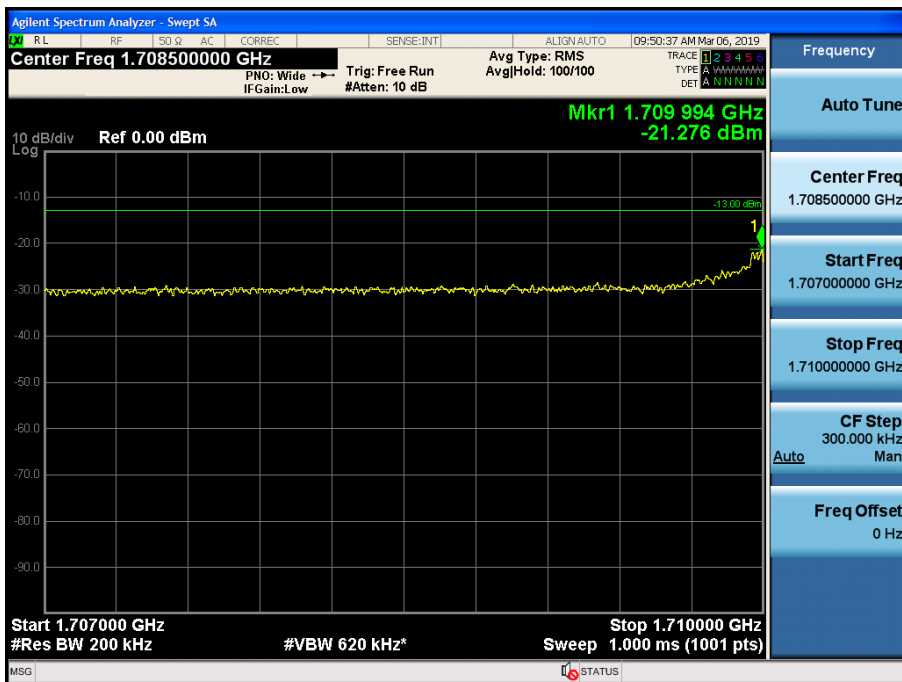

Out-of-band (single test signals) / AWS / Downlink / LTE 20 MHz / Upper

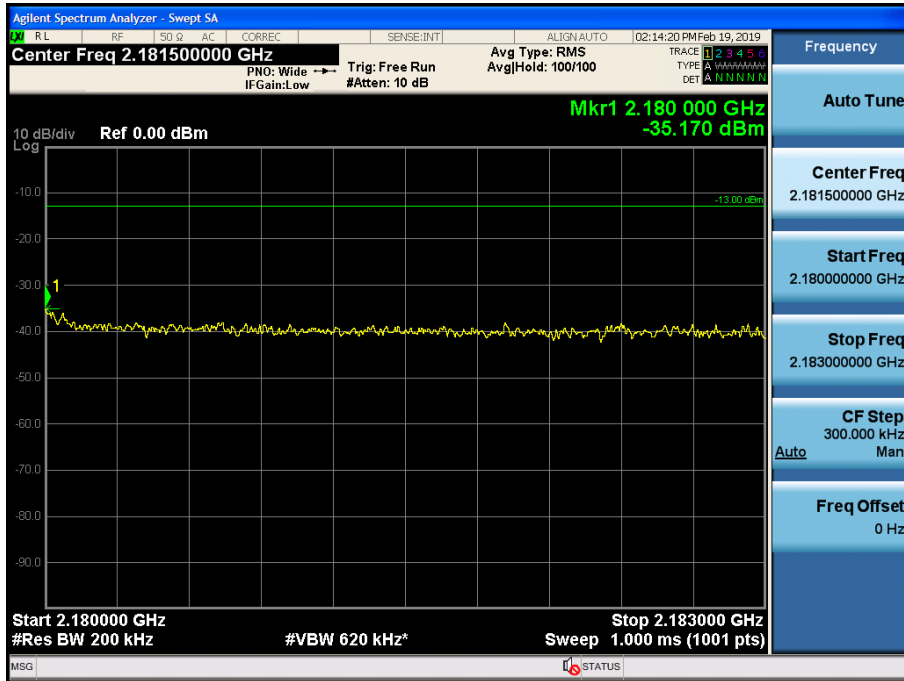

Out-of-band (single test signals) / AWS / Downlink / LTE 20 MHz / Lower

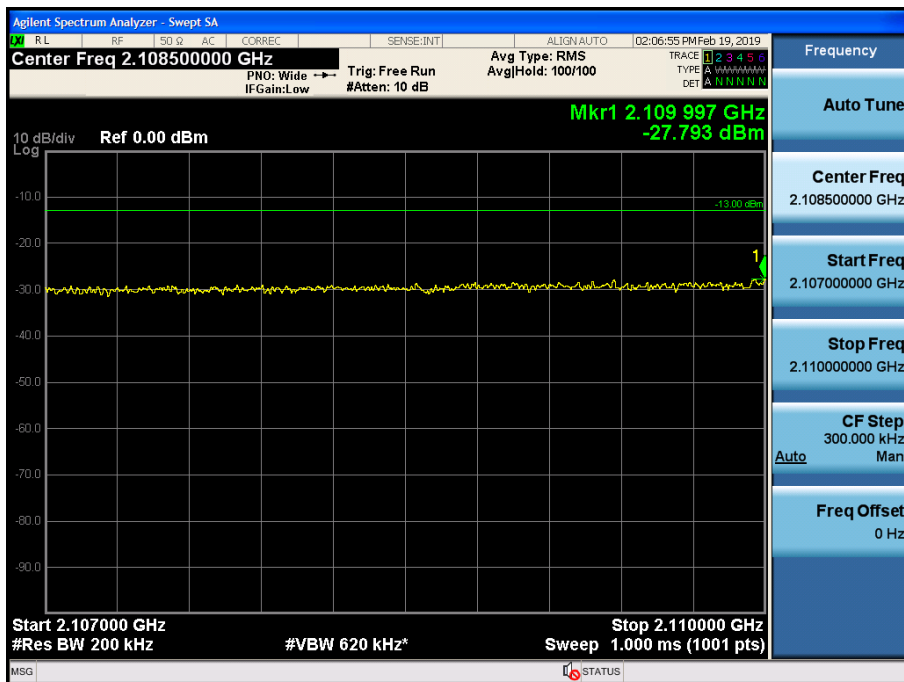

+3 dB above Out-of-band (single test signals) / AWS / Downlink / LTE 20 MHz / Upper

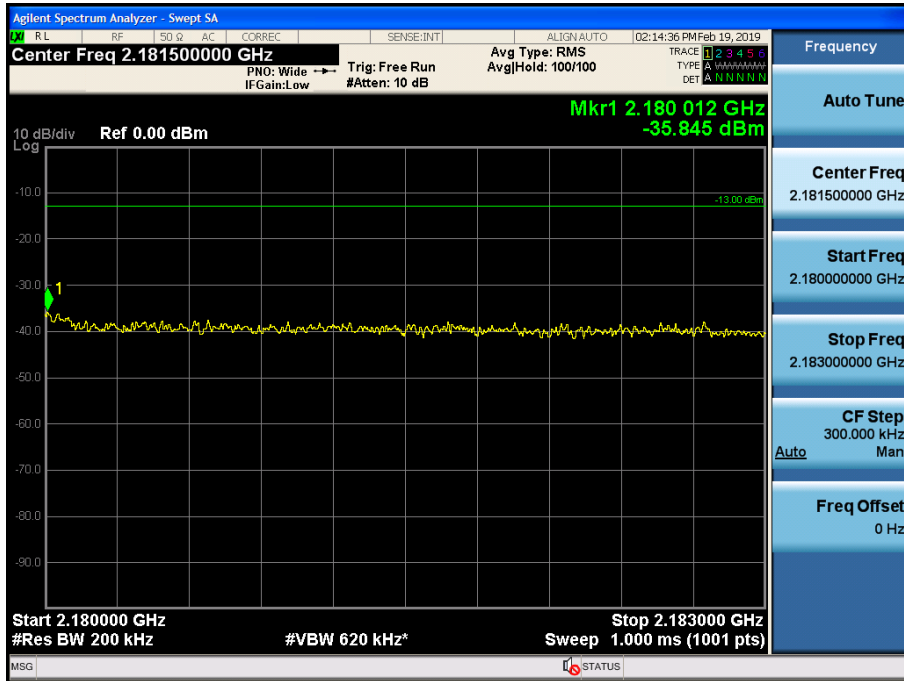

+3 dB above Out-of-band (single test signals) / AWS / Downlink / LTE 20 MHz / Lower

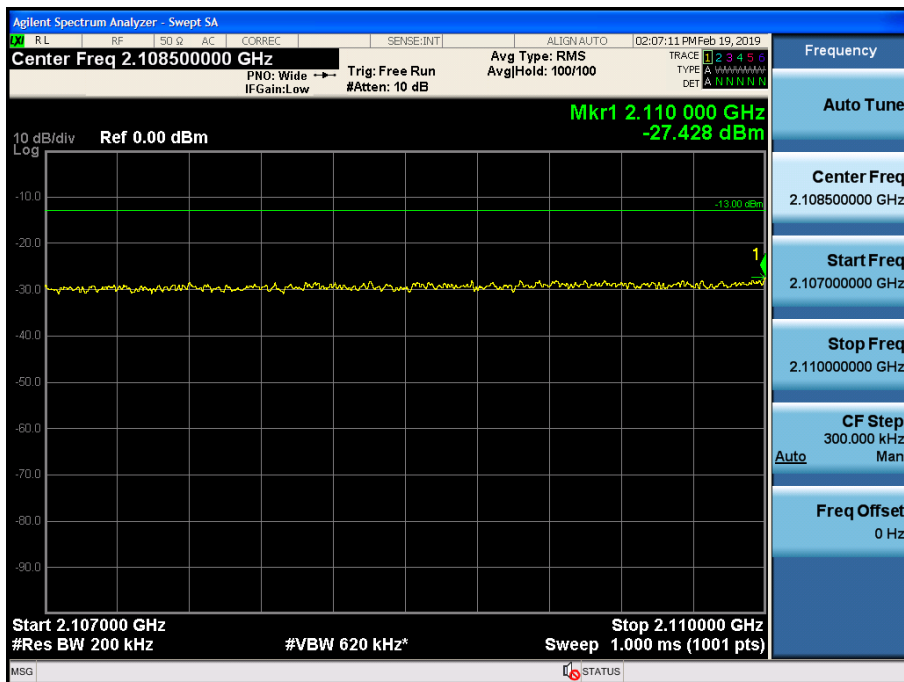

Plot data of Spurious Emissions

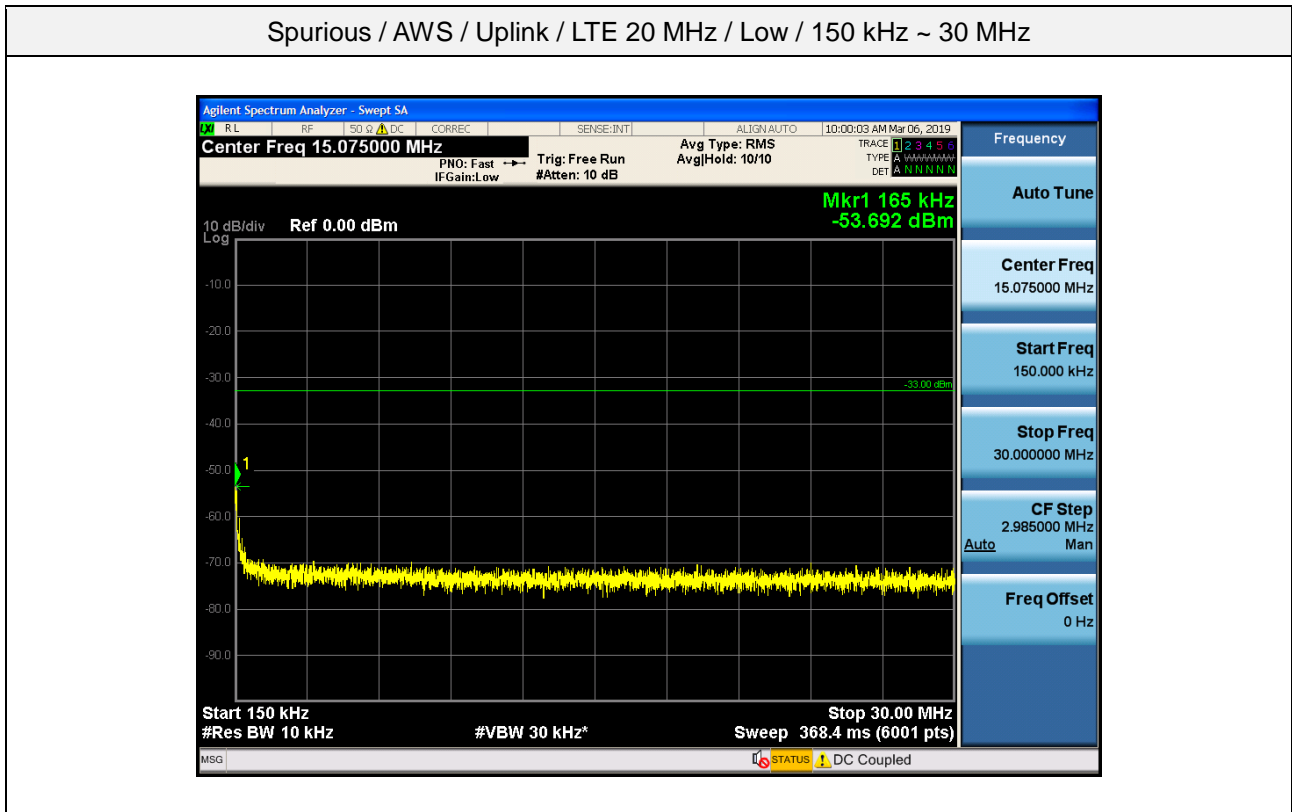
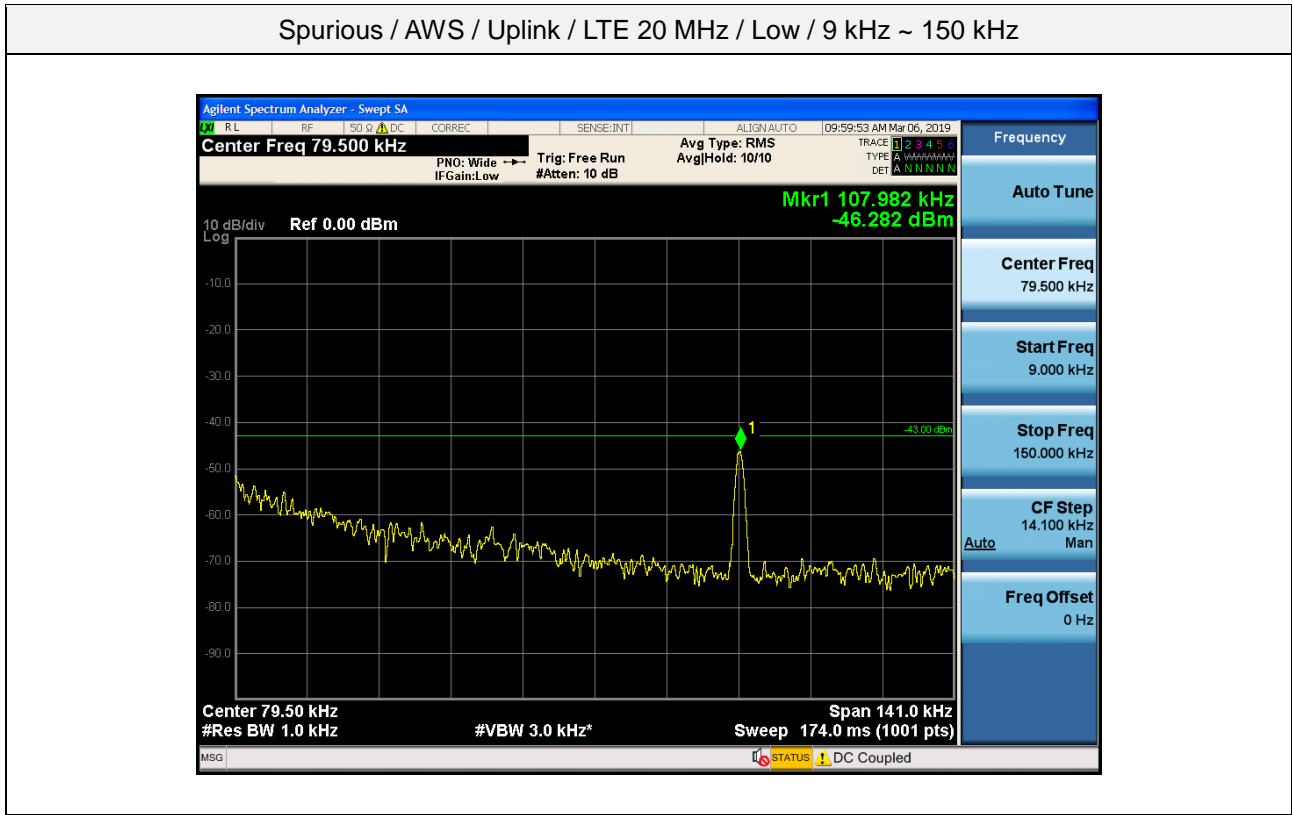

Spurious / AWS / Uplink / LTE 20 MHz / Low / 30 MHz ~ Low edge - 11 MHz

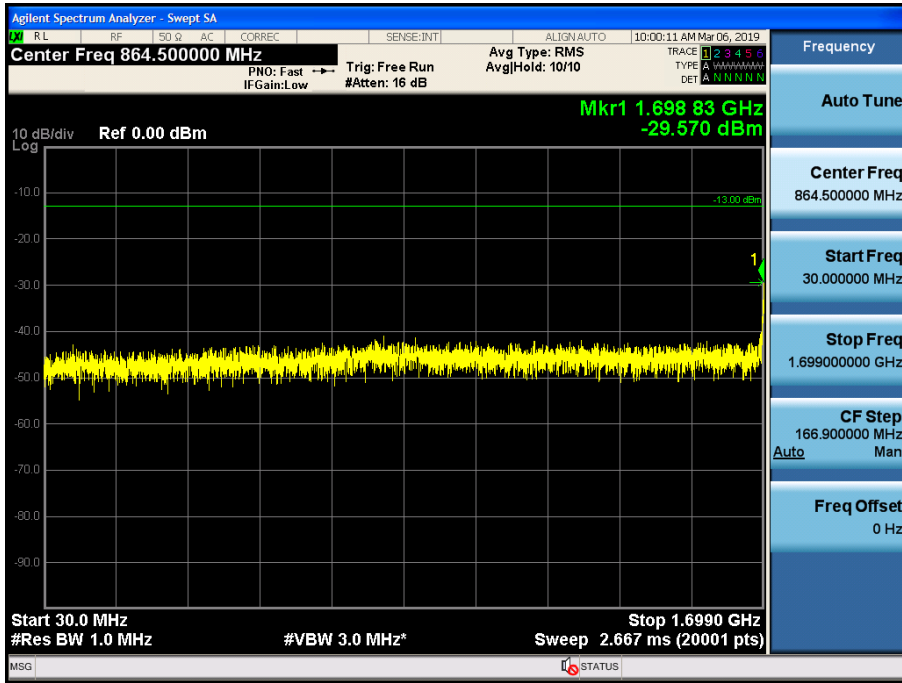

Spurious / AWS / Uplink / LTE 20 MHz / Low / Low edge - 11 MHz ~ Low edge - 1 MHz

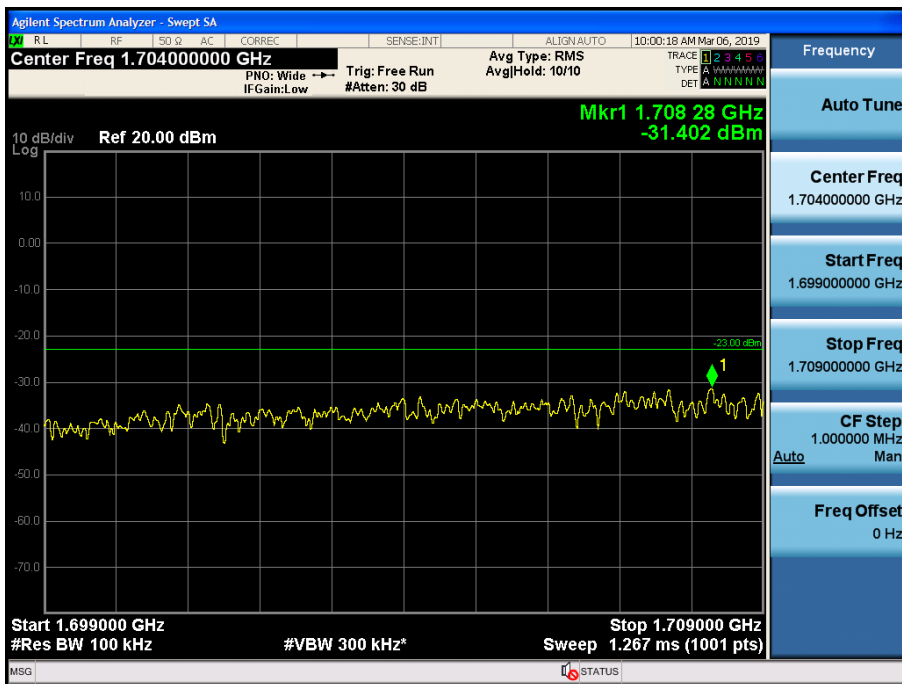

Spurious / AWS / Uplink / LTE 20 MHz / Low / High Edge + 1 MHz ~ High Edge + 11 MHz

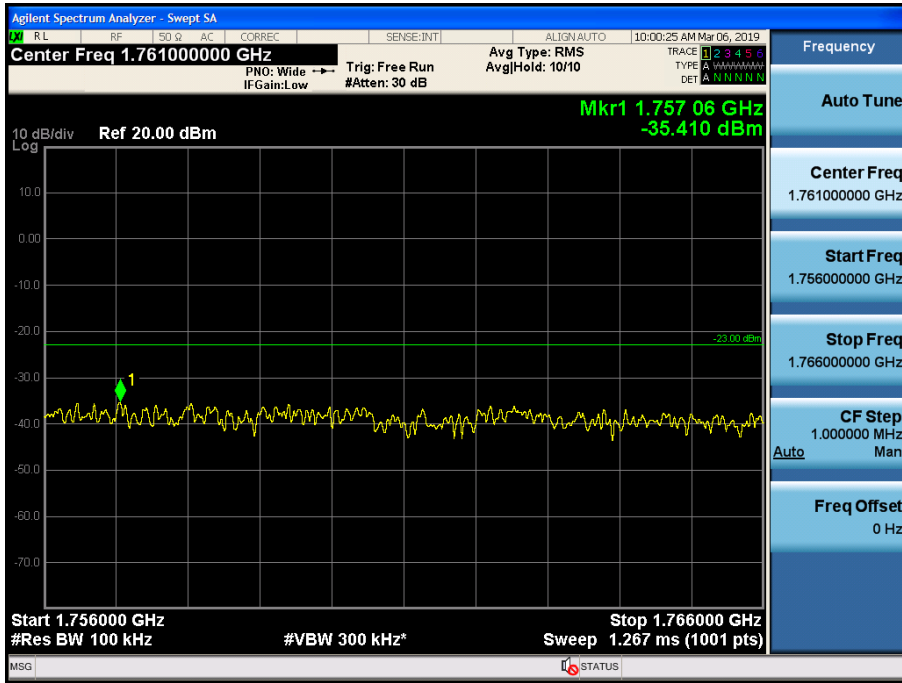

Spurious / AWS / Uplink / LTE 20 MHz / Low / High Edge + 11 MHz ~ 10 GHz

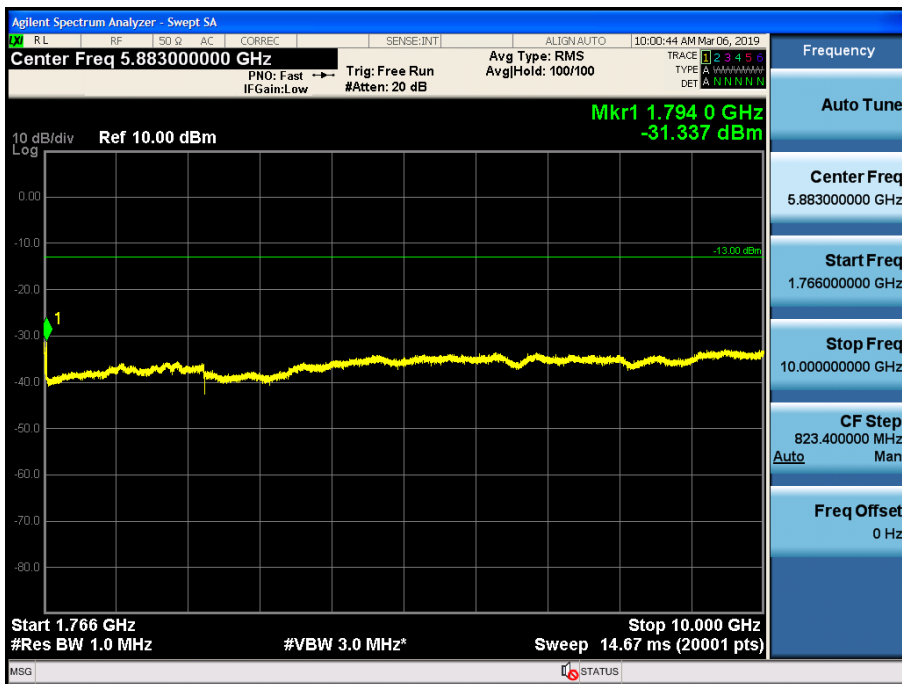

Spurious / AWS / Uplink / LTE 20 MHz / Low / 10 GHz ~ 26.5 GHz

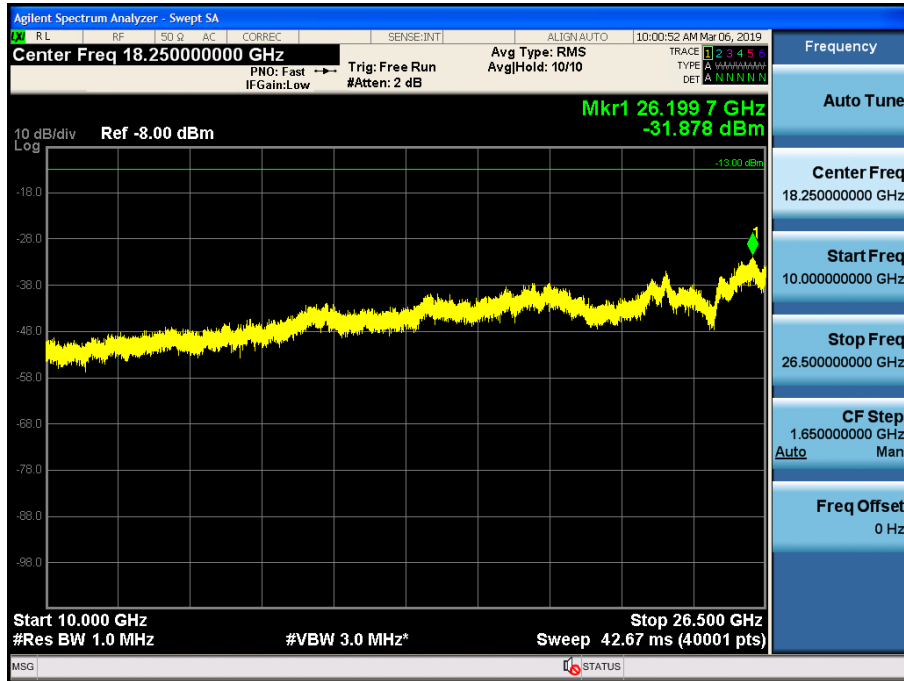

Spurious / AWS / Uplink / LTE 20 MHz / Middle / 9 kHz ~ 150 kHz

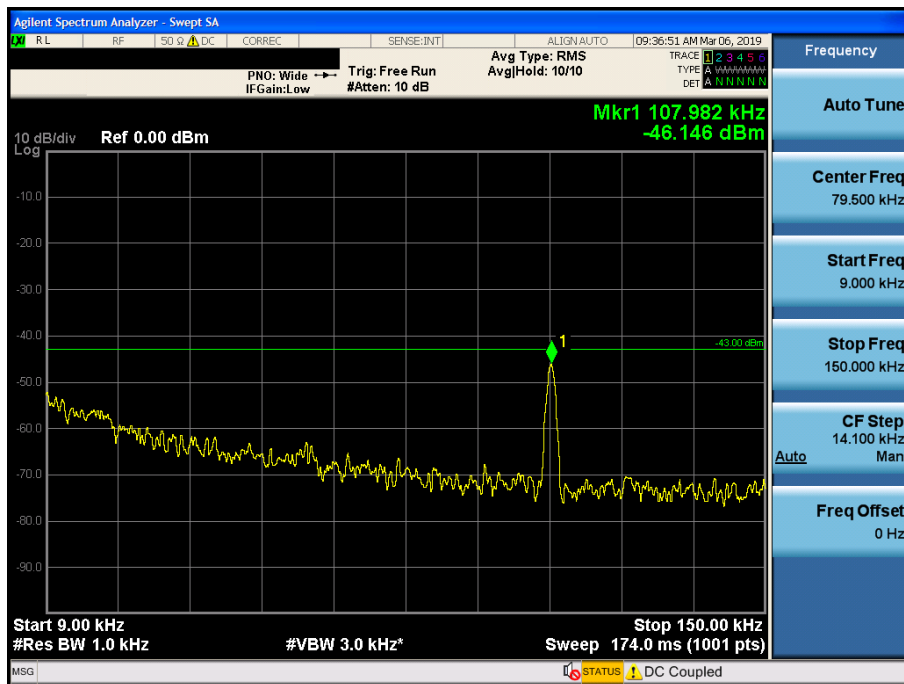

Spurious / AWS / Uplink / LTE 20 MHz / Middle / 150 kHz ~ 30 MHz

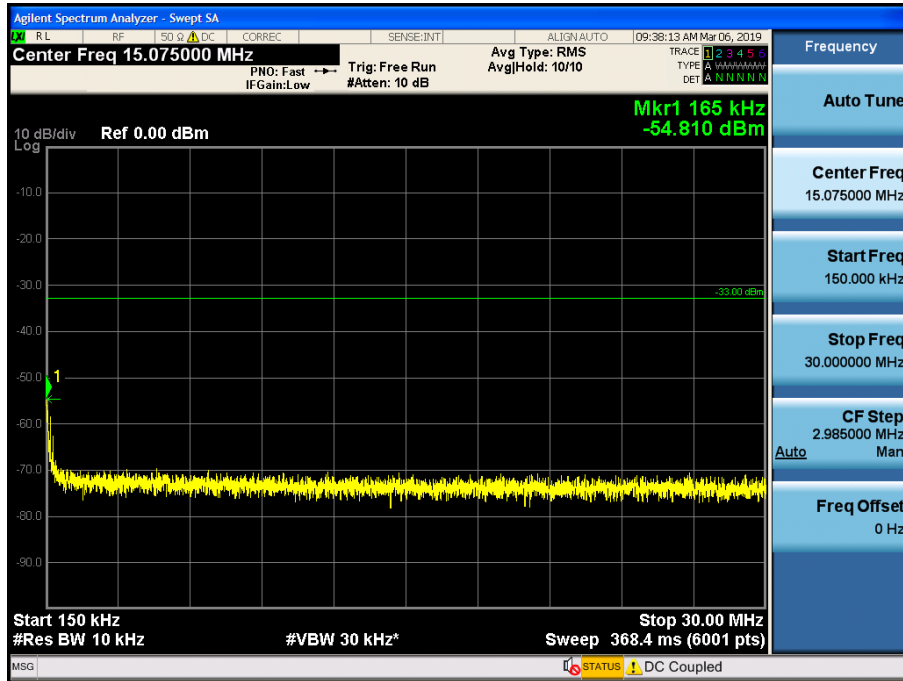

Spurious / AWS / Uplink / LTE 20 MHz / Middle / 30 MHz ~ Low edge - 11 MHz

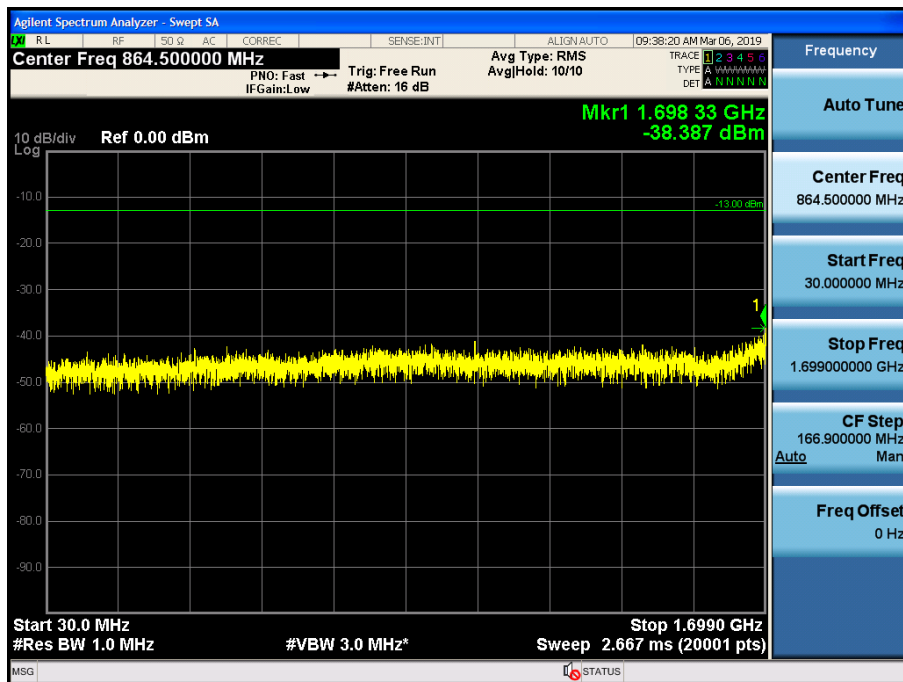

Spurious / AWS / Uplink / LTE 20 MHz / Middle / Low edge - 11 MHz ~ Low edge - 1 MHz

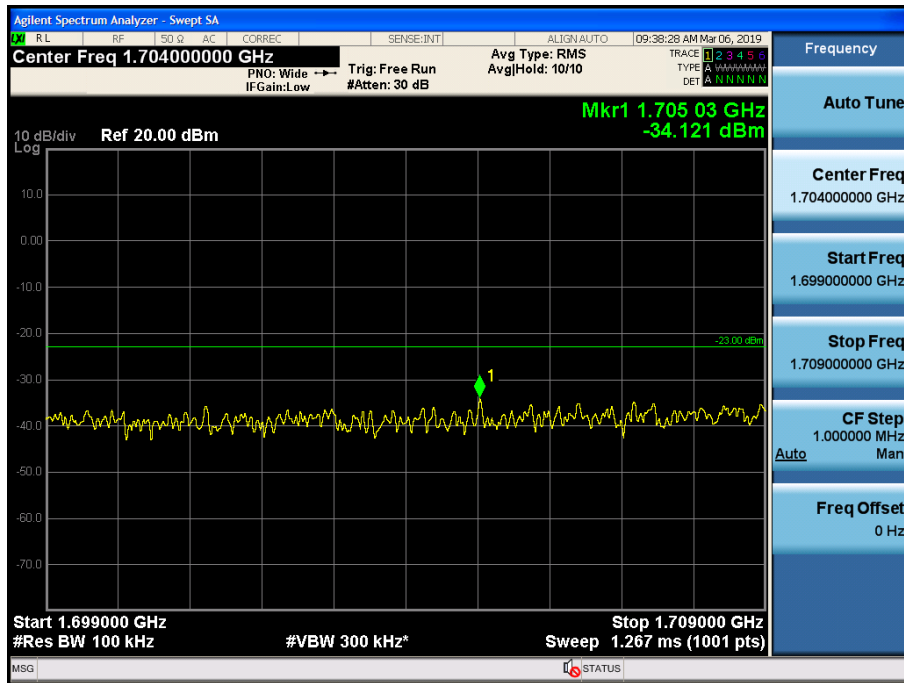

Spurious / AWS / Uplink / LTE 20 MHz / Middle / High Edge + 1 MHz ~ High Edge + 11 MHz

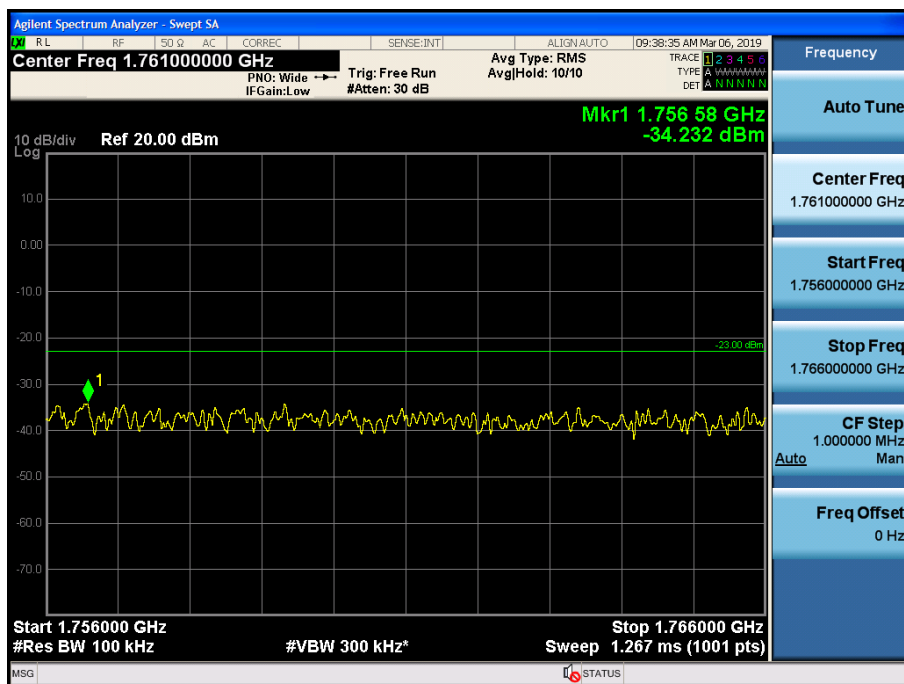

Spurious / AWS / Uplink / LTE 20 MHz / Middle / High Edge + 11 MHz ~ 10 GHz

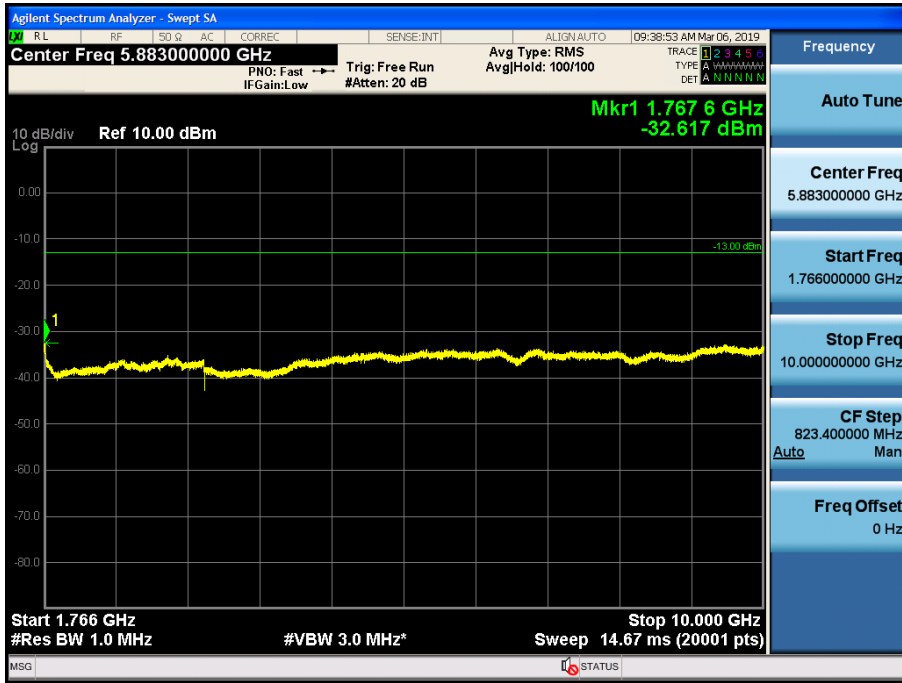

Spurious / AWS / Uplink / LTE 20 MHz / Middle / 10 GHz ~ 26.5 GHz

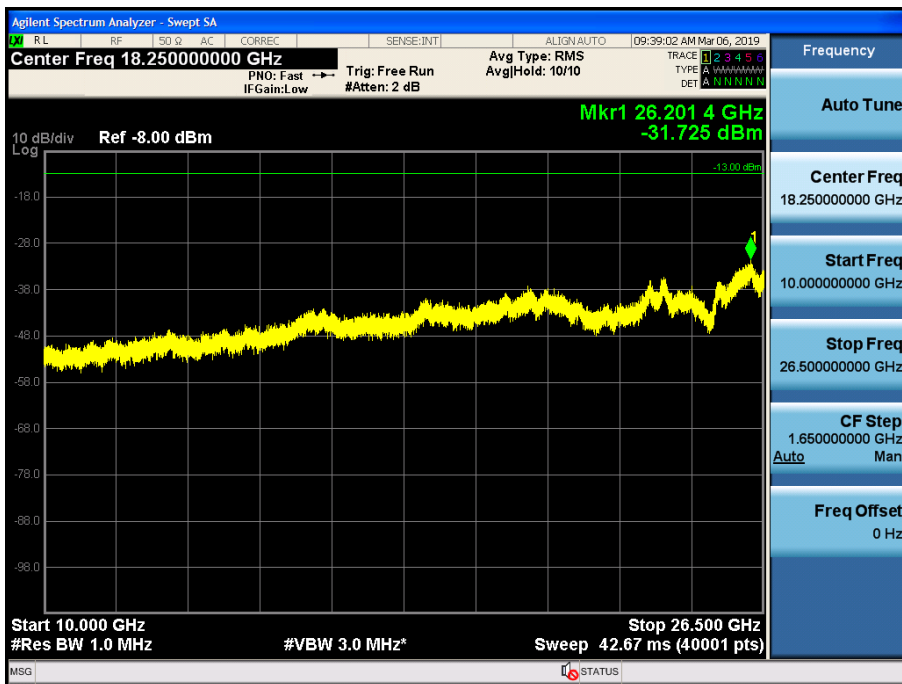

Spurious / AWS / Uplink / LTE 20 MHz / High / 9 kHz ~ 150 kHz

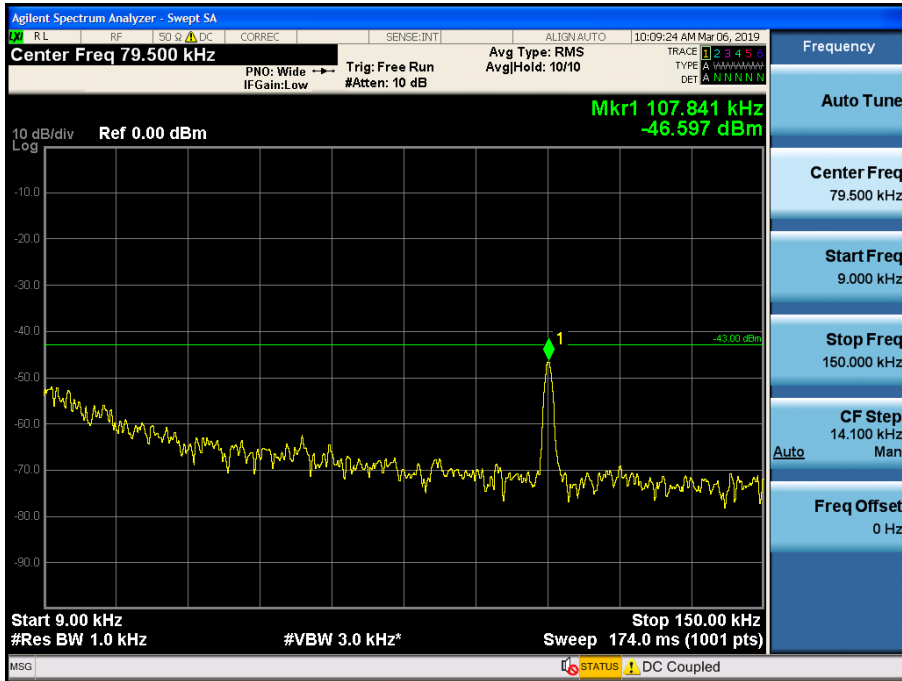

Spurious / AWS / Uplink / LTE 20 MHz / High / 150 kHz ~ 30 MHz

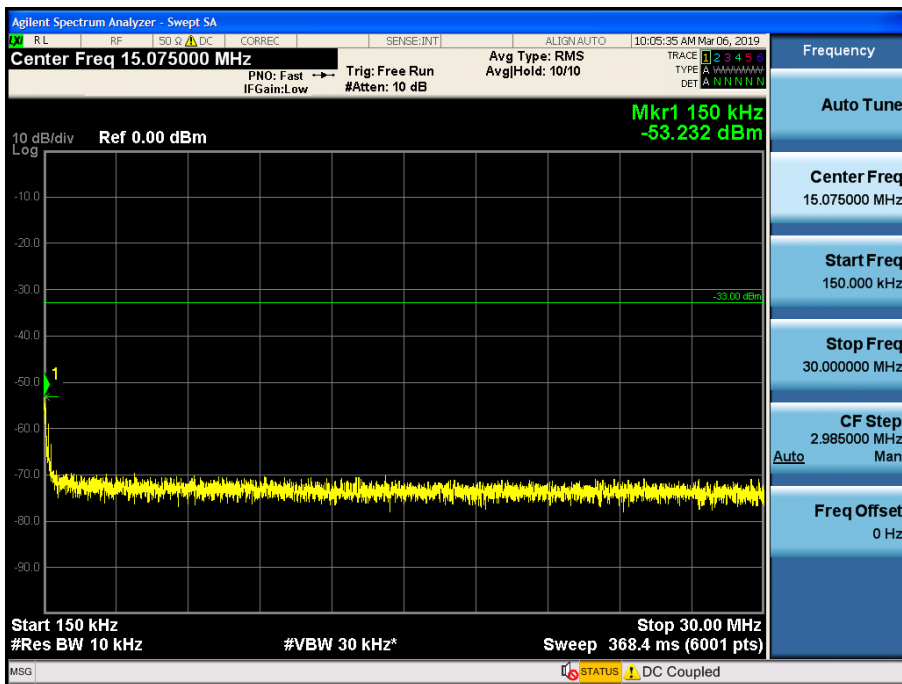

Spurious / AWS / Uplink / LTE 20 MHz / High / 30 MHz ~ Low edge - 11 MHz

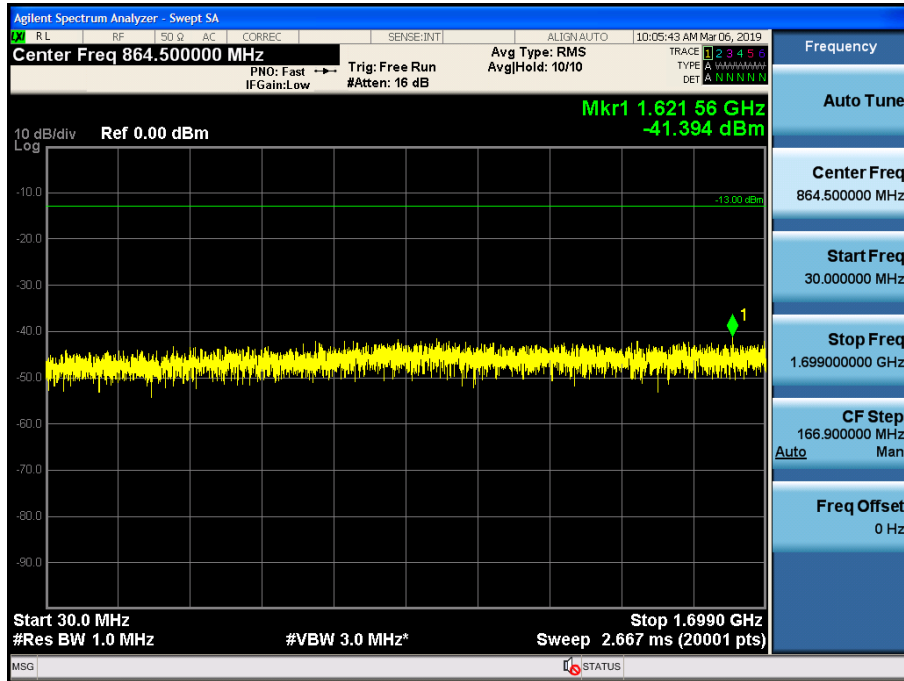

Spurious / AWS / Uplink / LTE 20 MHz / High / Low edge - 11 MHz ~ Low edge - 1 MHz

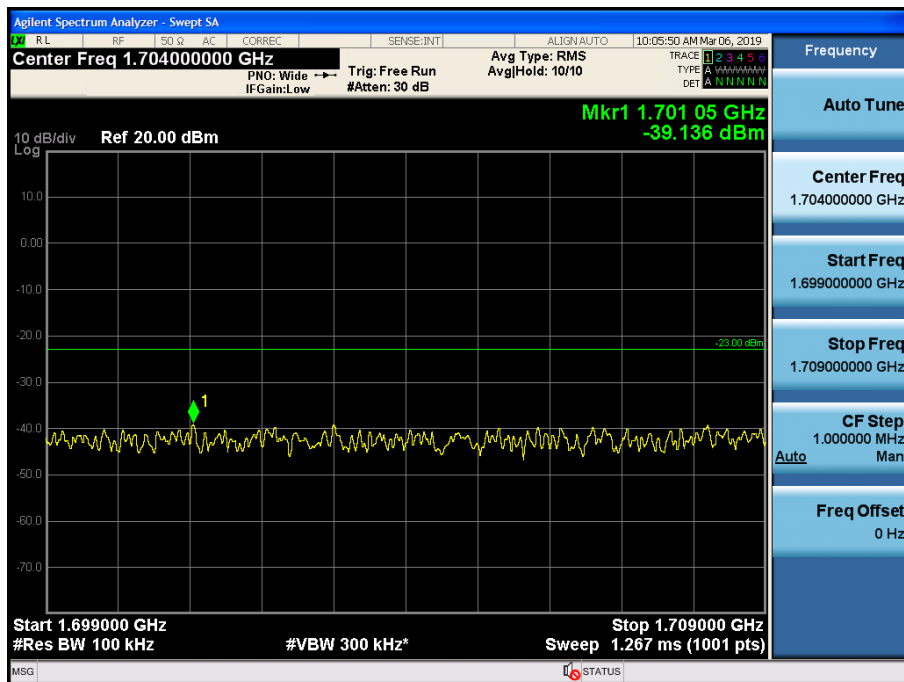

Spurious / AWS / Uplink / LTE 20 MHz / High / High Edge + 1 MHz ~ High Edge + 11 MHz

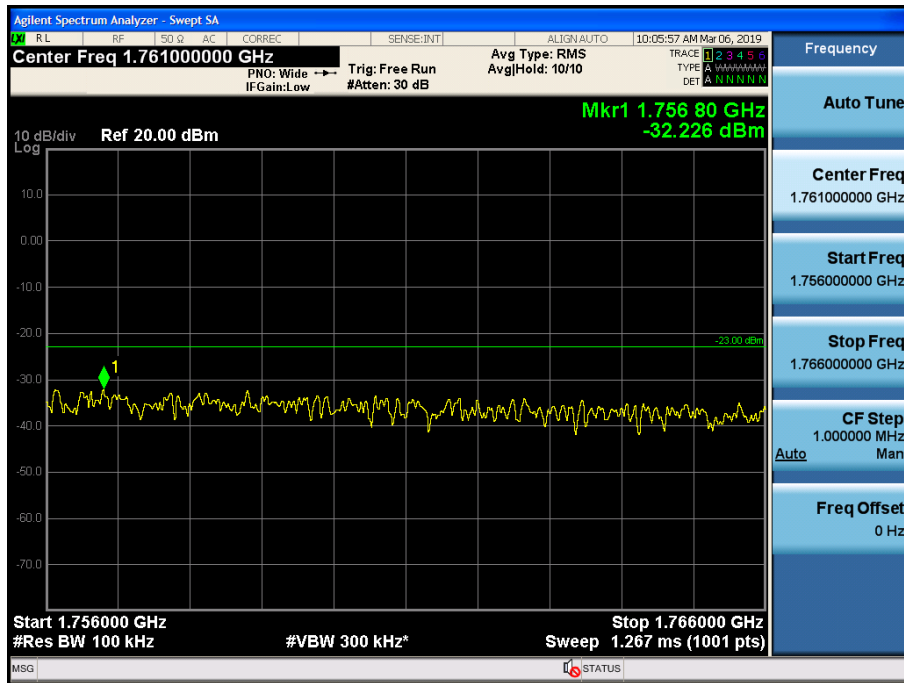

Spurious / AWS / Uplink / LTE 20 MHz / High / High Edge + 11 MHz ~ 10 GHz

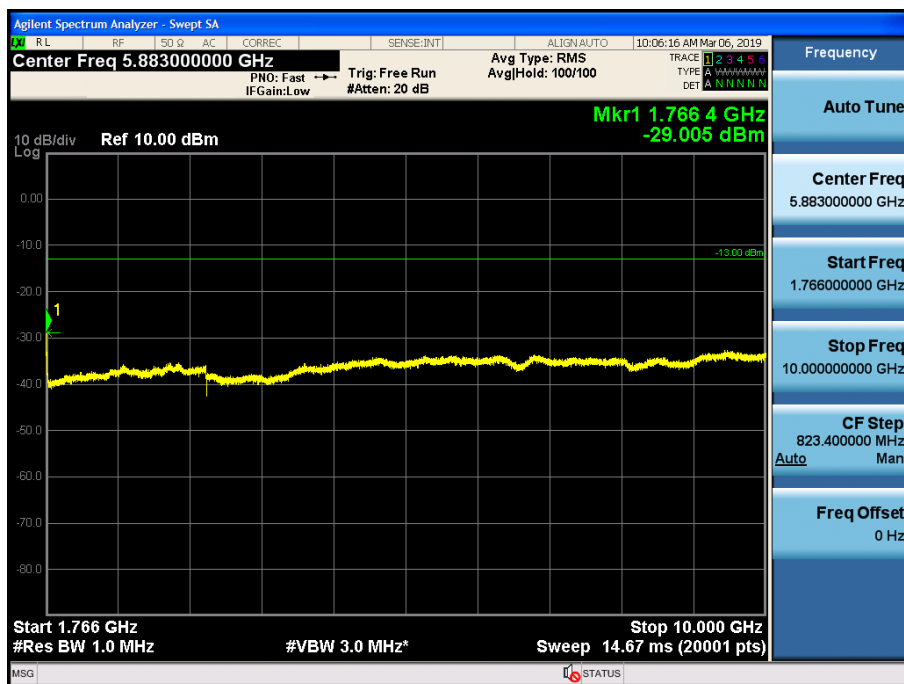

Spurious / AWS / Uplink / LTE 20 MHz / High / 10 GHz ~ 26.5 GHz

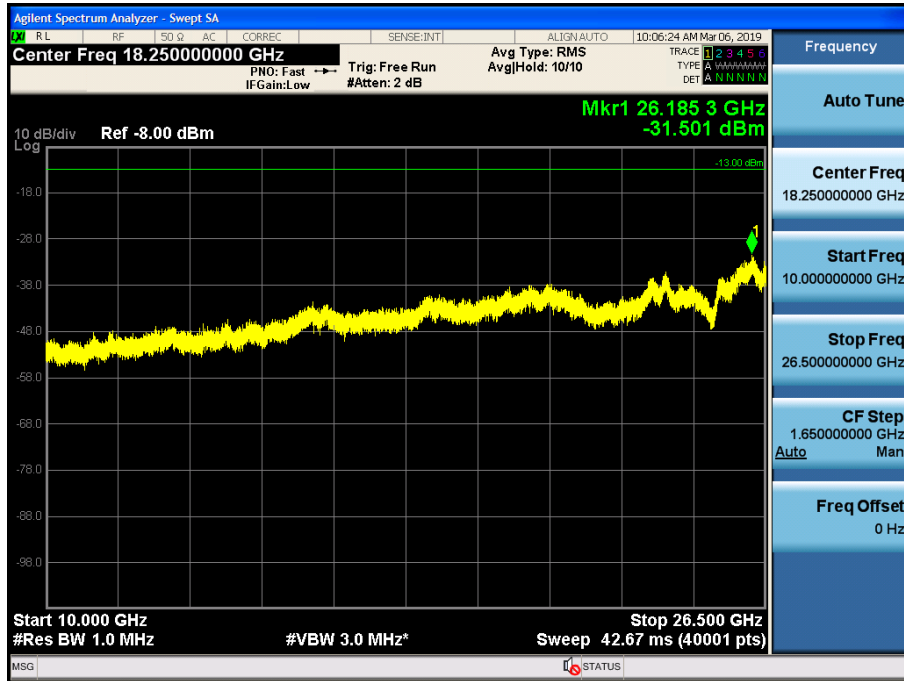

Spurious / AWS / Downlink / LTE 20 MHz / Low / 9 kHz ~ 150 kHz

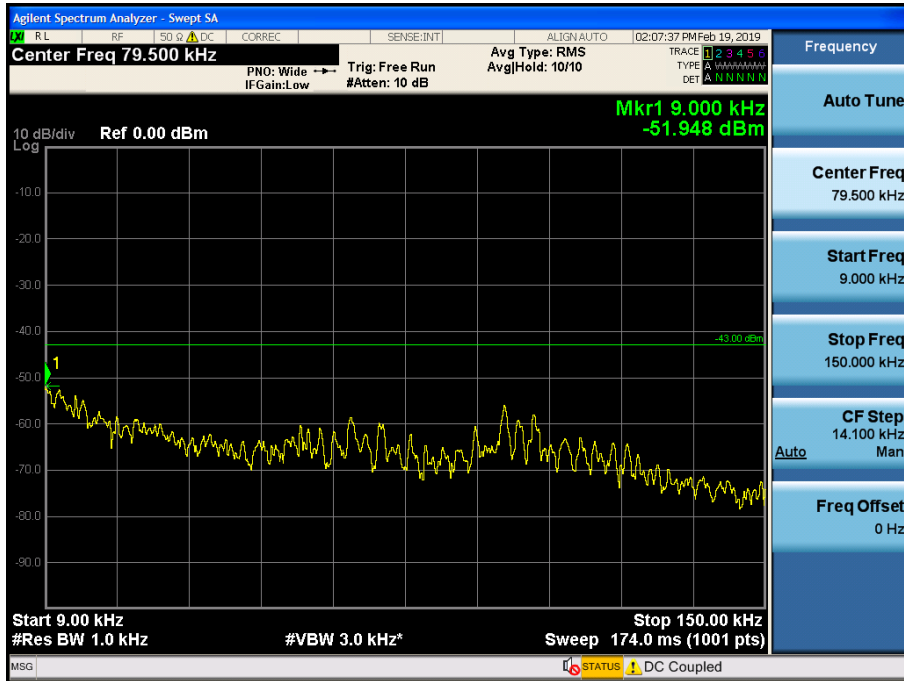

Spurious / AWS / Downlink / LTE 20 MHz / Low / 150 kHz ~ 30 MHz

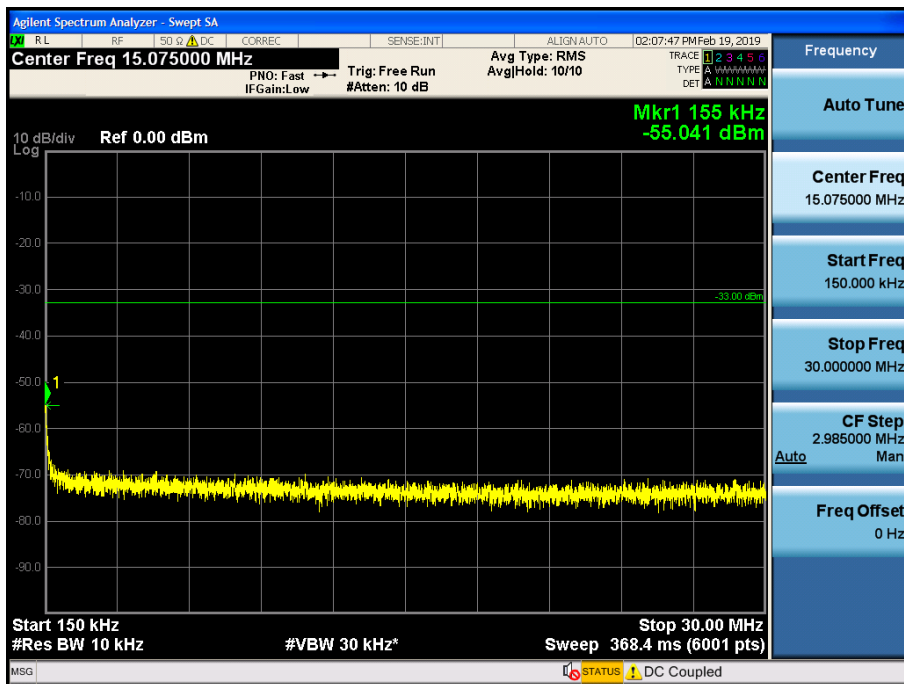

Spurious / AWS / Downlink / LTE 20 MHz / Low / 30 MHz ~ Low edge - 11 MHz

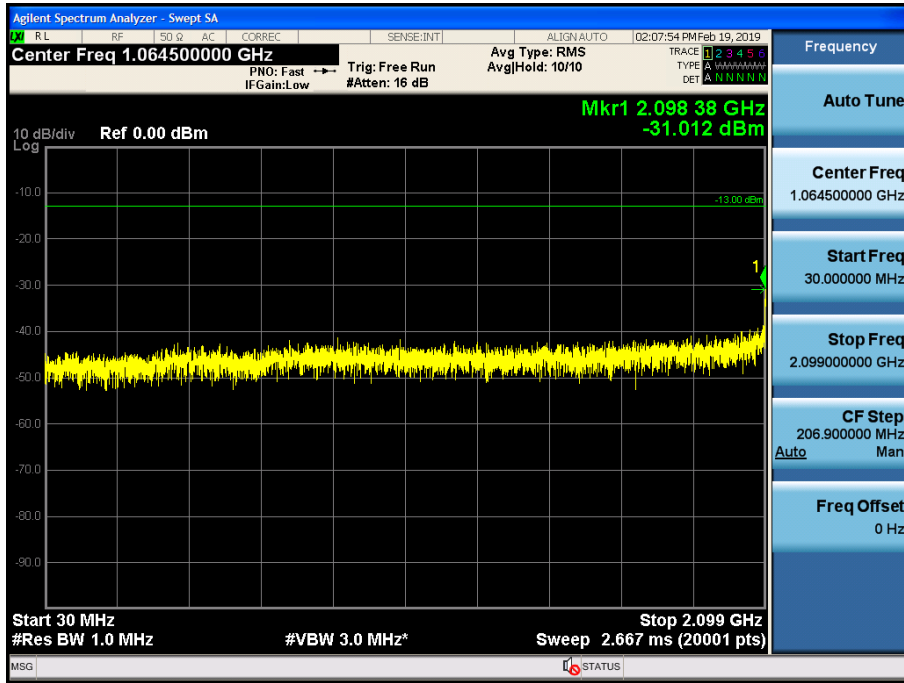

Spurious / AWS / Downlink / LTE 20 MHz / Low / Low edge - 11 MHz ~ Low edge - 1 MHz

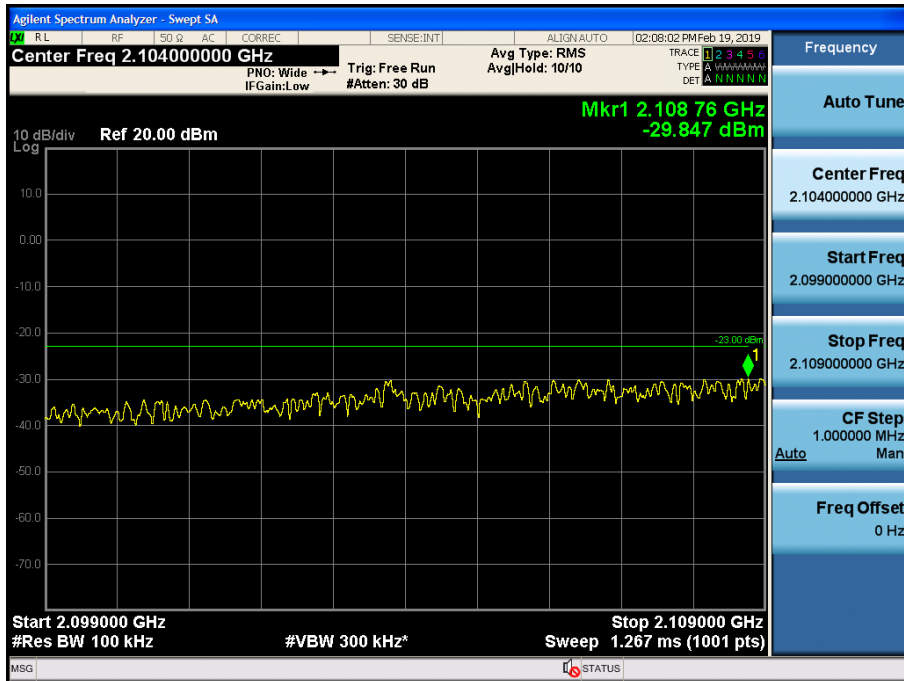

Spurious / AWS / Downlink / LTE 20 MHz / Low / High Edge + 1 MHz ~ High Edge + 11 MHz

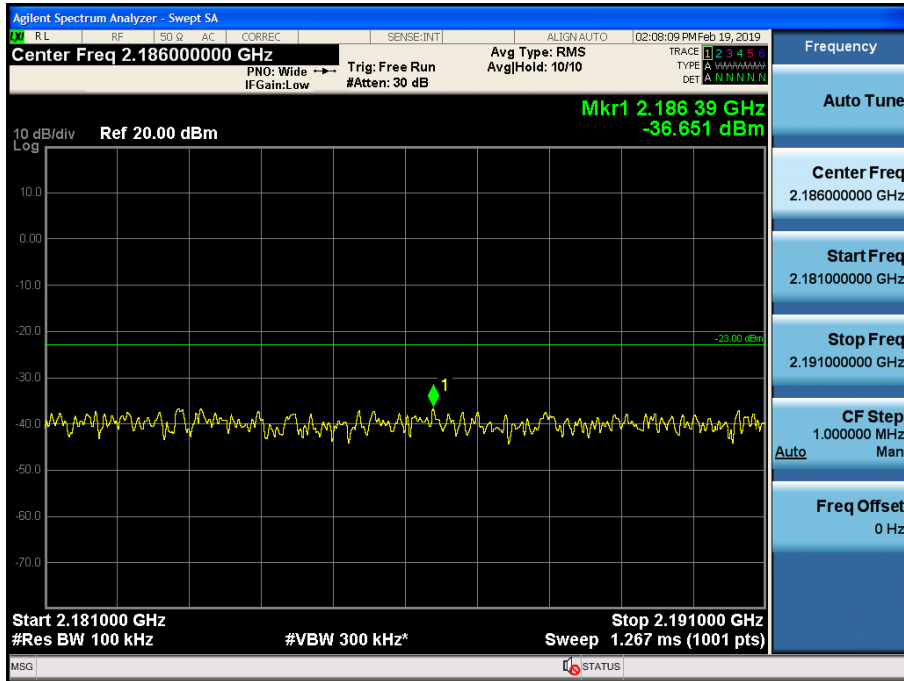

Spurious / AWS / Downlink / LTE 20 MHz / Low / High Edge + 11 MHz ~ 10 GHz



Spurious / AWS / Downlink / LTE 20 MHz / Low / 10 GHz ~ 26.5 GHz

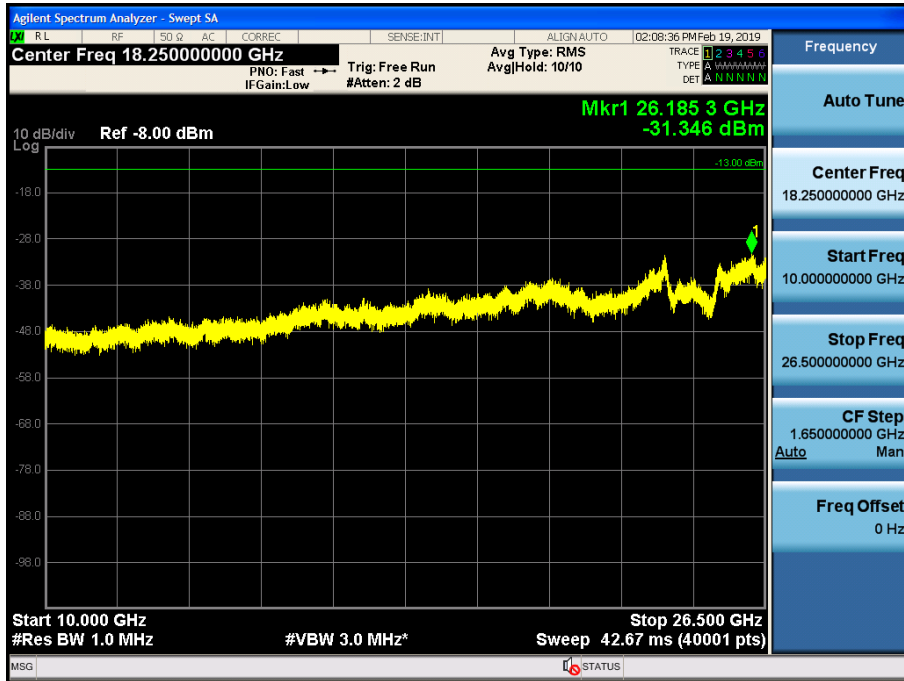

Spurious / AWS / Downlink / LTE 20 MHz / Middle / 9 kHz ~ 150 kHz

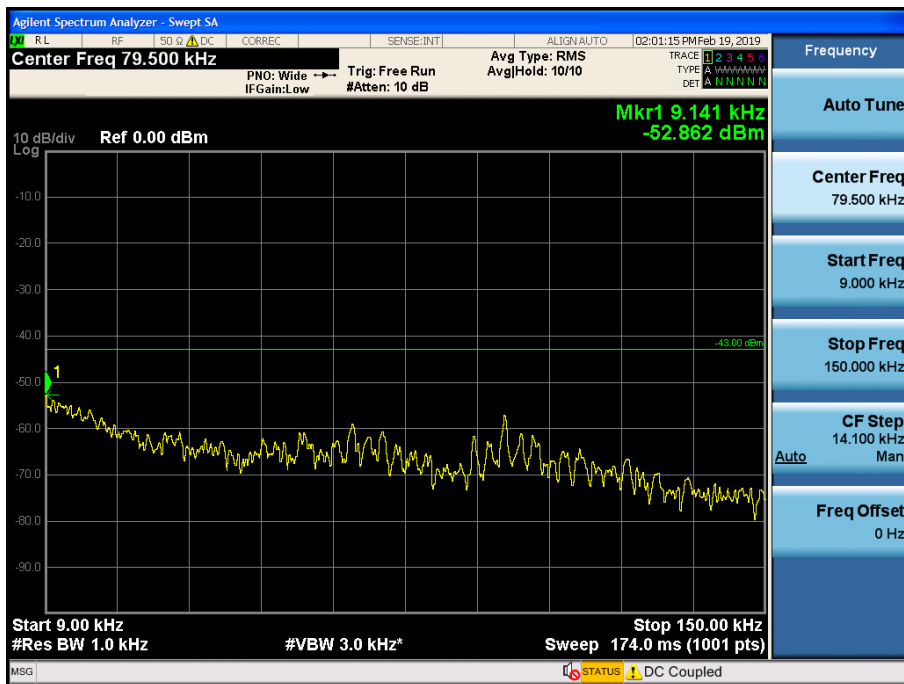

Spurious / AWS / Downlink / LTE 20 MHz / Middle / 150 kHz ~ 30 MHz

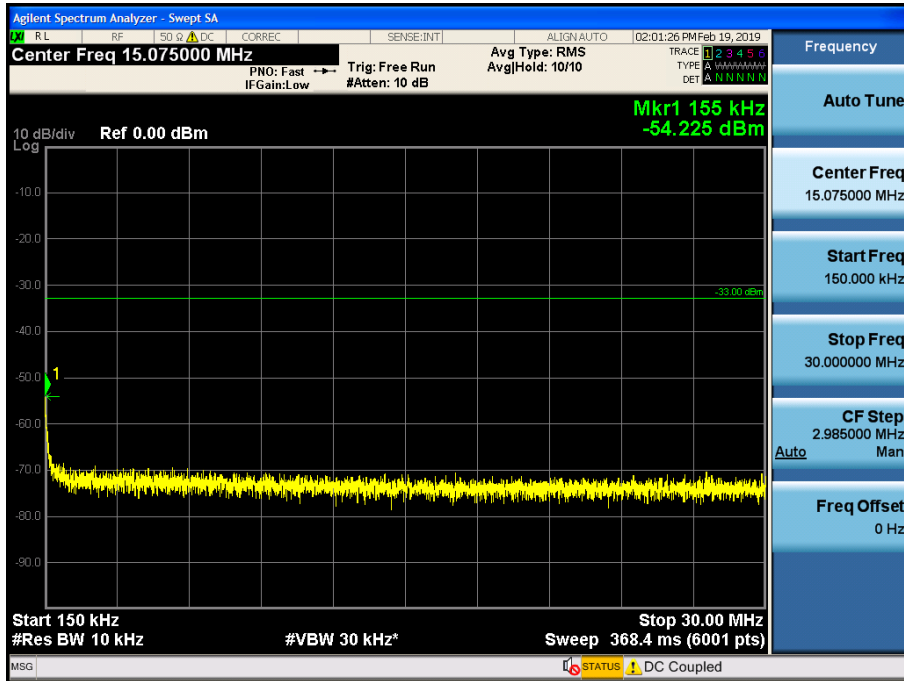

Spurious / AWS / Downlink / LTE 20 MHz / Middle / 30 MHz ~ Low edge - 11 MHz

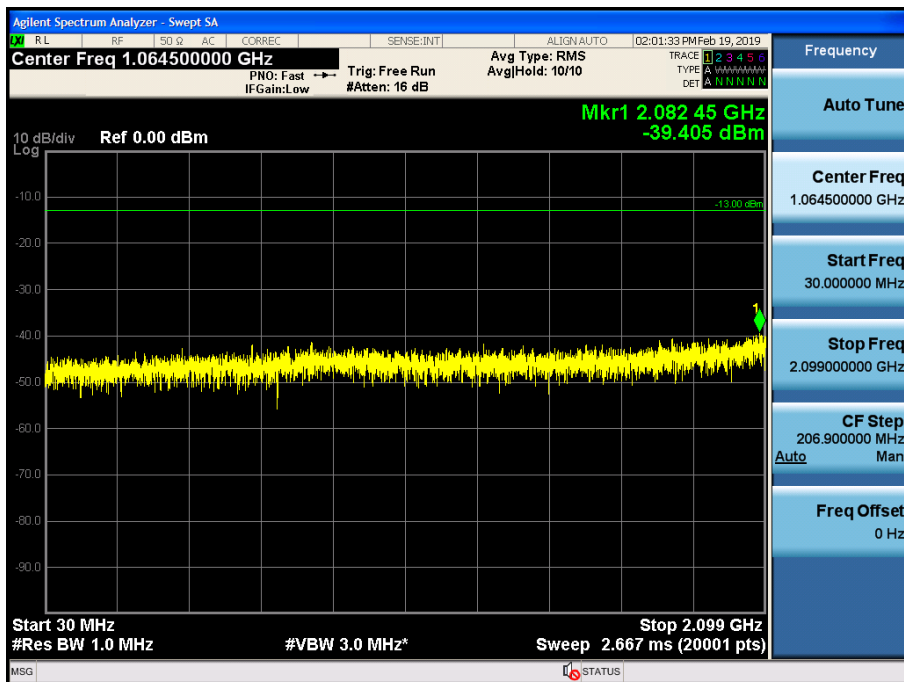

Spurious / AWS / Downlink / LTE 20 MHz / Middle / Low edge - 11 MHz ~ Low edge - 1 MHz

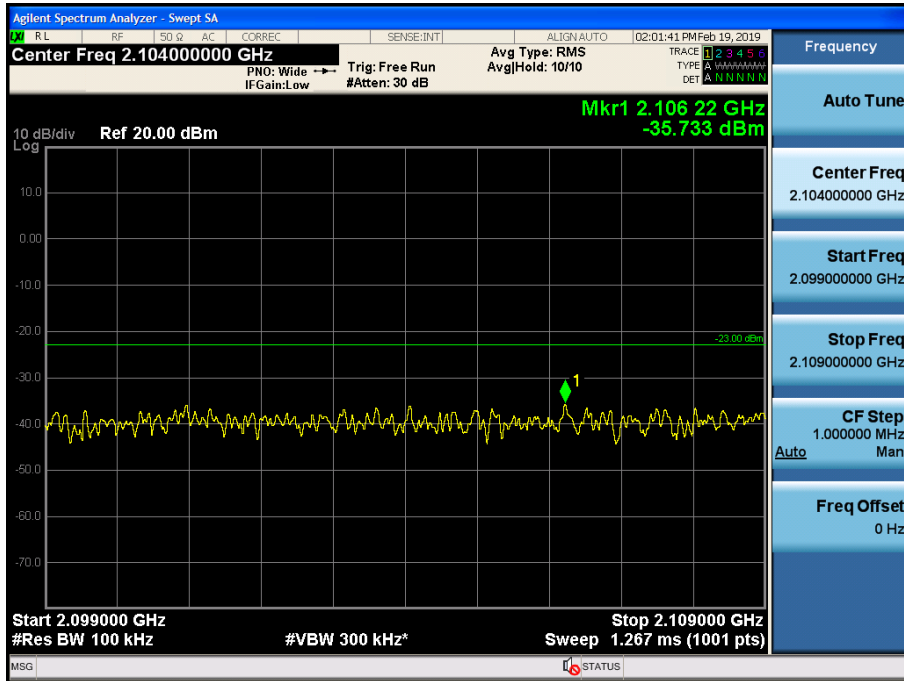

Spurious / AWS / Downlink / LTE 20 MHz / Middle / High Edge + 1 MHz ~ High Edge + 11 MHz

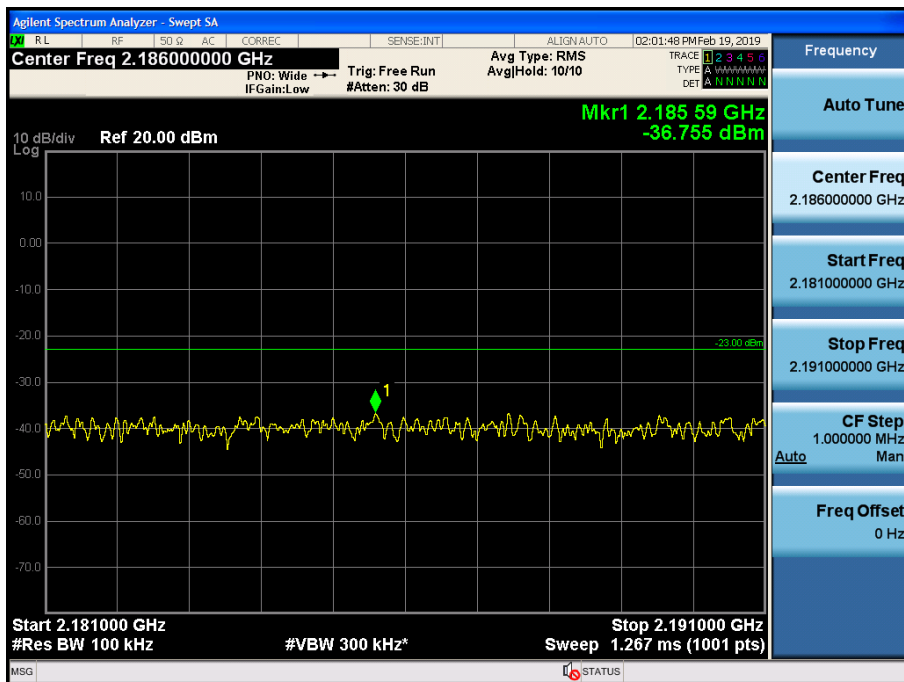

Spurious / AWS / Downlink / LTE 20 MHz / Middle / High Edge + 11 MHz ~ 10 GHz

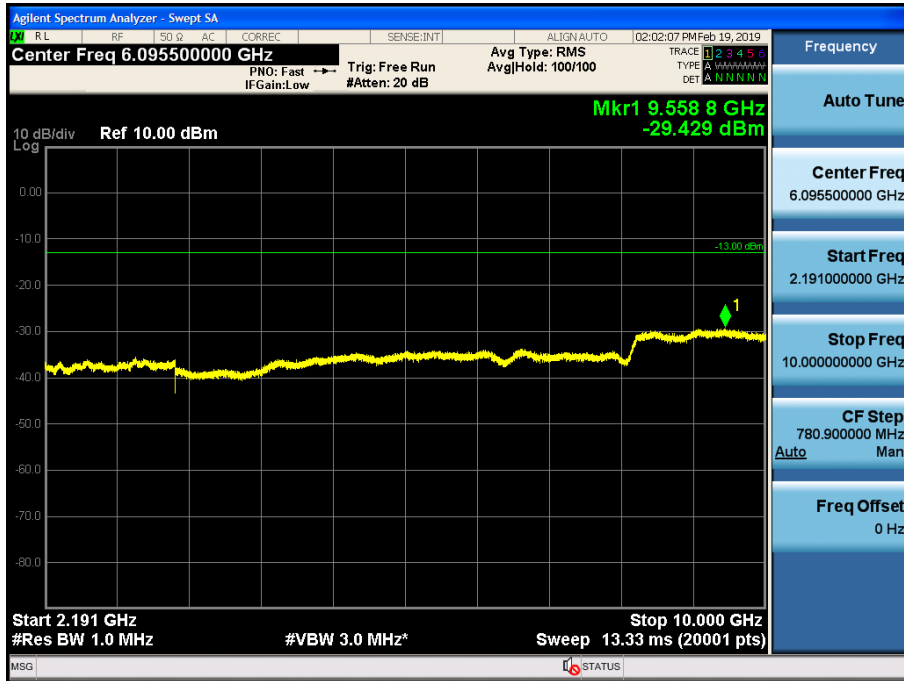

Spurious / AWS / Downlink / LTE 20 MHz / Middle / 10 GHz ~ 26.5 GHz



Spurious / AWS / Downlink / LTE 20 MHz / High / 9 kHz ~ 150 kHz

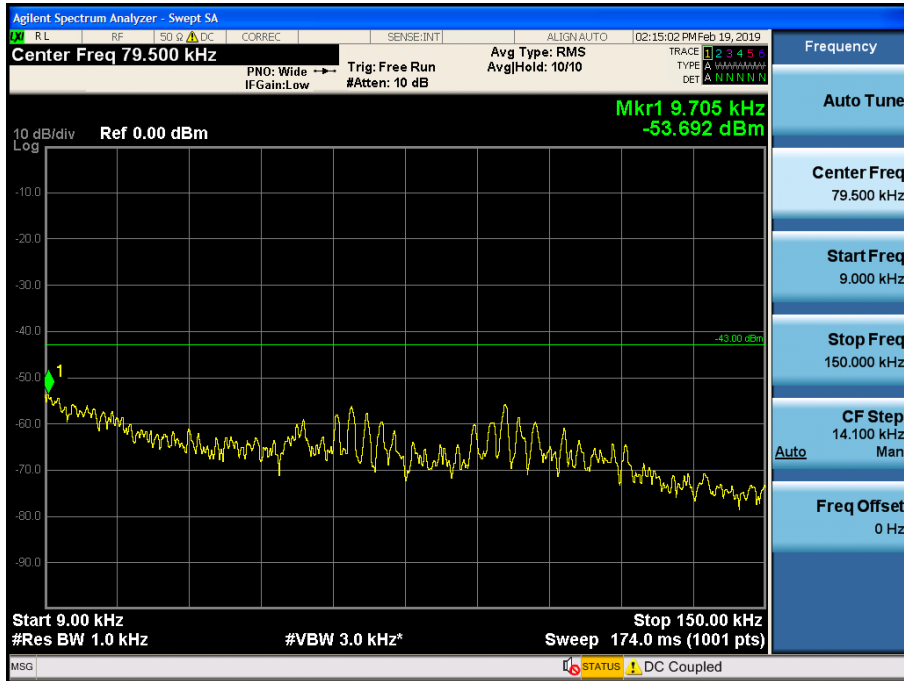

Spurious / AWS / Downlink / LTE 20 MHz / High / 150 kHz ~ 30 MHz

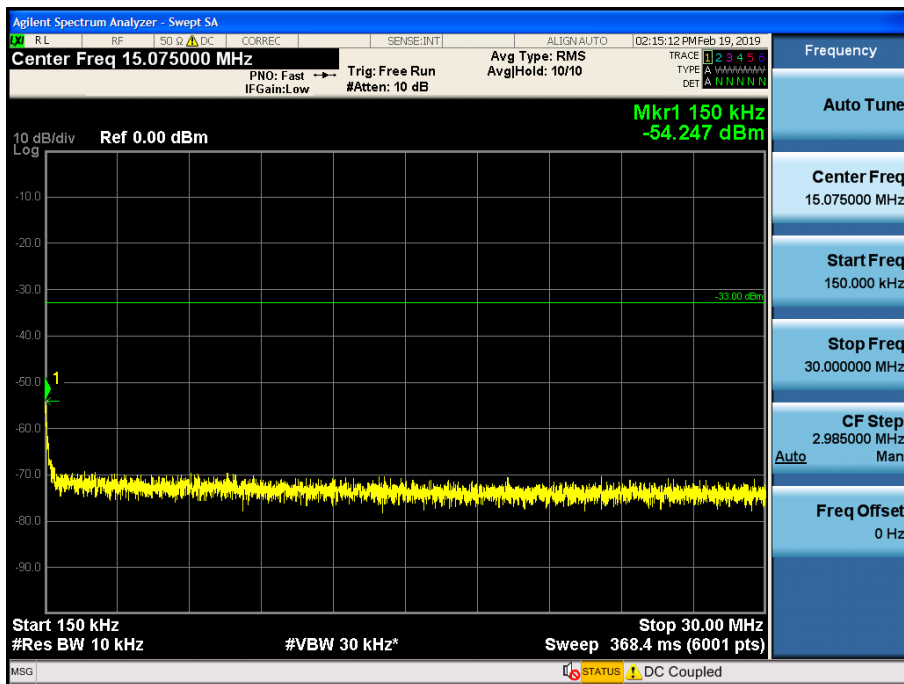

Spurious / AWS / Downlink / LTE 20 MHz / High / 30 MHz ~ Low edge - 11 MHz

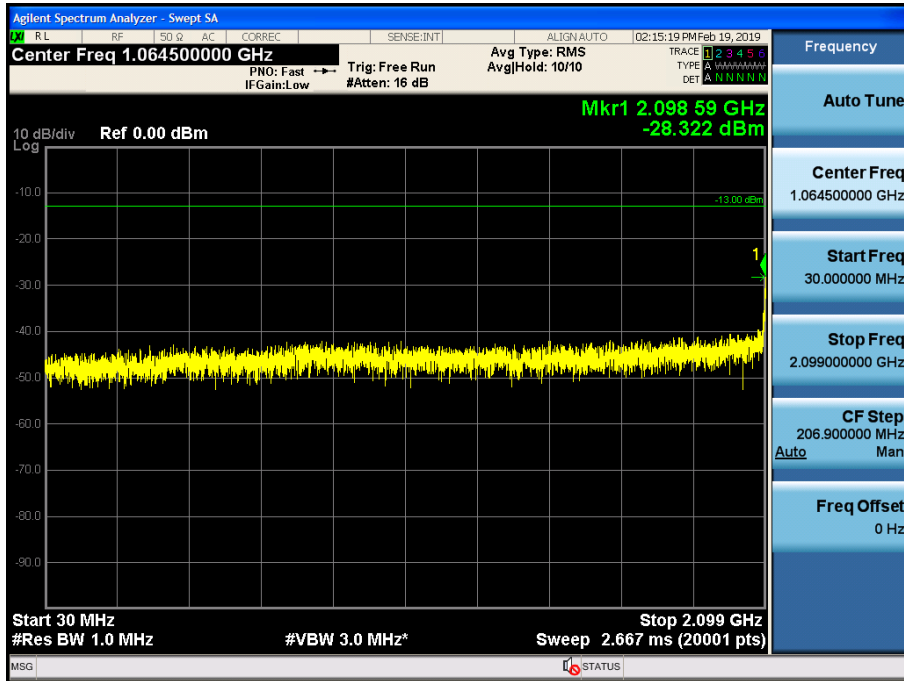

Spurious / AWS / Downlink / LTE 20 MHz / High / Low edge - 11 MHz ~ Low edge - 1 MHz

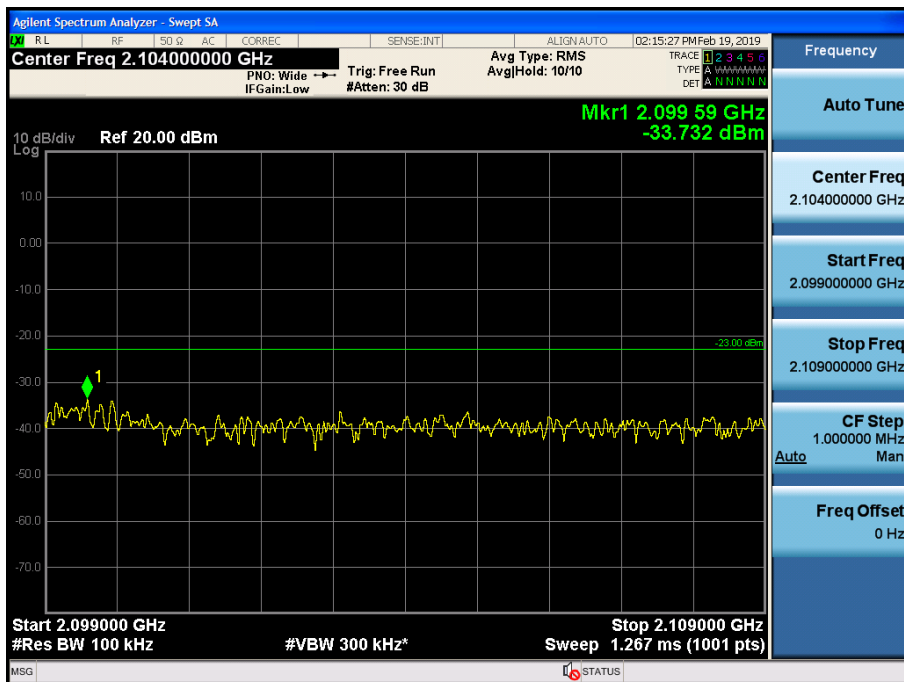

Spurious / AWS / Downlink / LTE 20 MHz / High / High Edge + 1 MHz ~ High Edge + 11 MHz

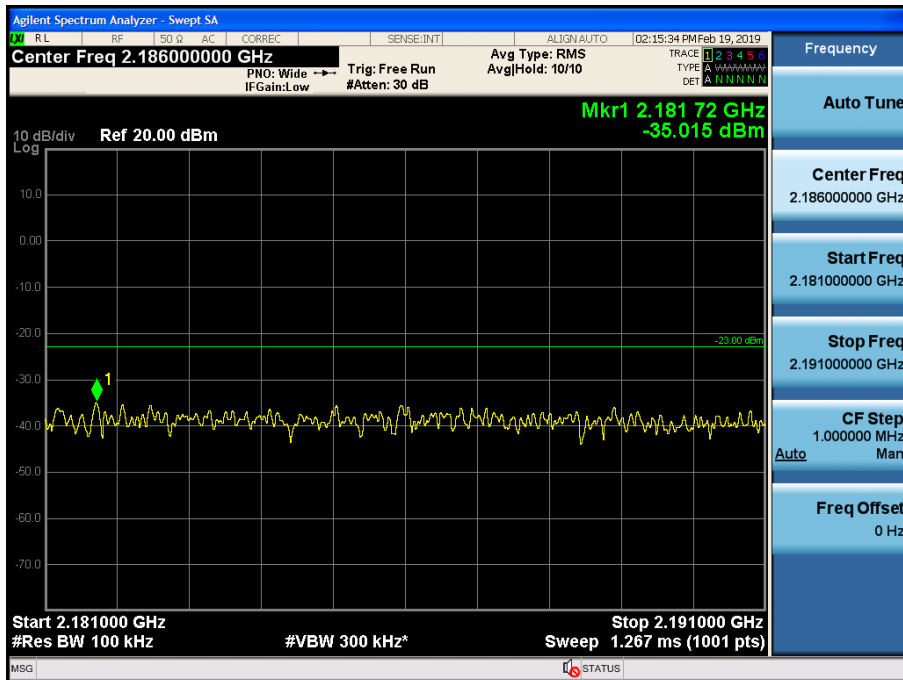

Spurious / AWS / Downlink / LTE 20 MHz / High / High Edge + 11 MHz ~ 10 GHz



Spurious / AWS / Downlink / LTE 20 MHz / High / 10 GHz ~ 26.5 GHz

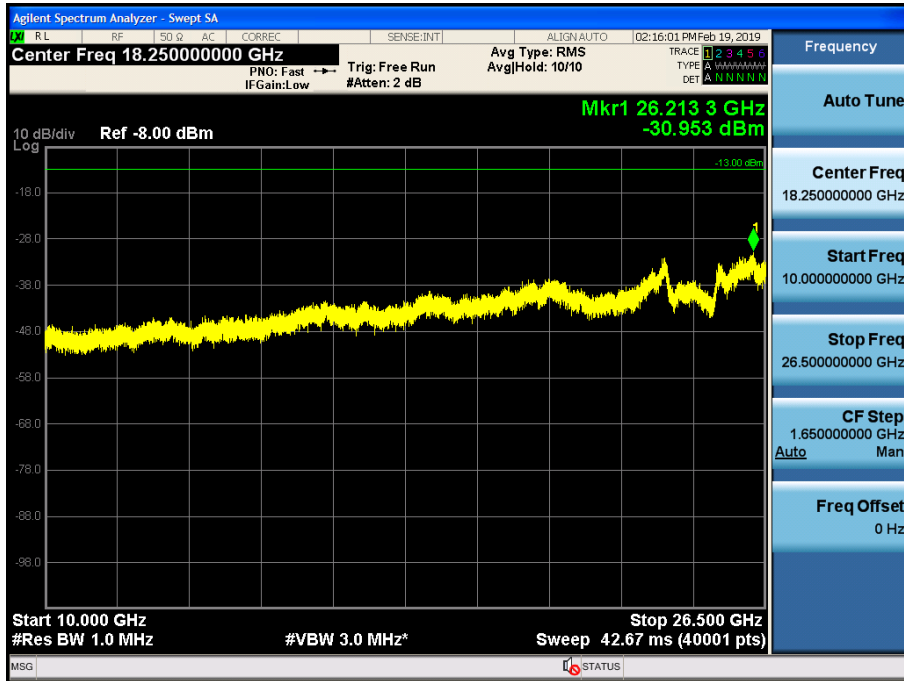

5.6. RADIATED SPURIOUS EMISSIONS

Test Requirements:

§ 2.1053 Measurements required: Field strength of spurious radiation.

(a) Measurements shall be made to detect spurious emissions that may be radiated directly from the cabinet, control circuits, power leads, or intermediate circuit elements under normal conditions of installation and operation. Curves or equivalent data shall be supplied showing the magnitude of each harmonic and other spurious emission. For this test, single sideband, independent sideband, and controlled carrier transmitters shall be modulated under the conditions specified in paragraph (c) of §2.1049, as appropriate. For equipment operating on frequencies below 890 MHz, an open field test is normally required, with the measuring instrument antenna located in the far-field at all test frequencies. In the event it is either impractical or impossible to make open field measurements (e.g. a broadcast transmitter installed in a building) measurements will be accepted of the equipment as installed. Such measurements must be accompanied by a description of the site where the measurements were made showing the location of any possible source of reflections which might distort the field strength measurements. Information submitted shall include the relative radiated power of each spurious emission with reference to the rated power output of the transmitter, assuming all emissions are radiated from halfwave dipole antennas.

(b) The measurements specified in paragraph (a) of this section shall be made for the following equipment:

- (1) Those in which the spurious emissions are required to be 60 dB or more below the mean power of the transmitter.
- (2) All equipment operating on frequencies higher than 25 MHz.
- (3) All equipment where the antenna is an integral part of, and attached directly to the transmitter.
- (4) Other types of equipment as required, when deemed necessary by the Commission.

Test Procedures:

Because KDB 935210 D05 procedure does not provide this requirement, measurements were in accordance with the test methods section 5.5 of ANSI C63.26-2015

- a) Place the EUT in the center of the turntable. The EUT shall be configured to transmit into the standard non-radiating load (for measuring radiated spurious emissions), connected with cables of minimal length unless specified otherwise. If the EUT uses an adjustable antenna, the antenna shall be positioned to the length that produces the worst case emission at the fundamental operating frequency.
- b) Each emission under consideration shall be evaluated:
 - 1) Raise and lower the measurement antenna in accordance 5.5.2, as necessary to enable detection of the maximum emission amplitude relative to measurement antenna height.
 - 2) Rotate the EUT through 360° to determine the maximum emission level relative to the axial position.
 - 3) Return the turntable to the azimuth where the highest emission amplitude level was observed.
 - 4) Vary the measurement antenna height again through 1 m to 4 m again to find the height associated with the maximum emission amplitude.
 - 5) Record the measured emission amplitude level and frequency using the appropriate RBW.
- c) Repeat step b) for each emission frequency with the measurement antenna oriented in both the horizontal and vertical polarizations to determine the orientation that gives the maximum emissions amplitude.

Test Result:

Ch.	Frequency (MHz)	Measured Level (dBuV/m)	Measured Power (dBm)	Ant. Factor (dB/m)	C.L (dB)	A.G. (dB)	D.F. (dB)	Pol.	Result (dBm)
No Critical Peaks Found									

* C.L.: Cable Loss / A.G.: Ant. Gain / D.F.: Distance Factor (3.75 m)

6. Annex A_EUT AND TEST SETUP PHOTO

Please refer to test setup photo file no. as follows;

No.	Description
1	HCT-RF-1903-FC002-P