

PSR-78-9533-UA MANUAL

VERSION 0.33



**3116 West Vanowen St.
Burbank, CA 91505
Tel: 818-840-8131
Fax: 818-840-8138**

www.adrftech.com



*Information in this document is subject to change without notice.
Advanced RF Technologies, Inc. 1996-2019.
All rights reserved.*

Please send comments to:

E-Mail: info@adrfttech.com

Phone: (818) 840-8131
(800) 313-9345

Fax: (818) 840-8138

Address:

Advanced RF Technologies, Inc.
Attention: Technical Publications Department
3116 Vanowen St.
Burbank, CA 91505
USA
www.adrfttech.com

REVISION HISTORY

Version	Author	Descriptions	Date
0.1	ADRF	Initial Release	08/07/2019
0.12	ADRF	update	09/11/2019
0.22	ADRF	B9B Update	08/04/2020
0.23	ADRF	updfate	09/04/2020
0.33	ADRF	U-Type updfate	09/23/2021

CHANGE LIST

Version	Change list	Contents

TABLE OF CONTENTS

1.	Introduction	9
1.1	Highlights	9
1.2	Parts List.....	10
1.3	Quick View	11
1.4	Warnings and Hazards	13
2.	Installation	16
2.1	Wiring Compartment	16
2.2	Wire Terminals.....	17
2.2.1	AC 100-240V Terminal Block	17
3.	Overview	18
3.1	LED	18
3.2	Host / Remote Switch	18
3.3	Cable Connection	19
3.3.1	AC Power	19
3.3.2	External Alarm	20
3.3.3	RF.....	21
3.3.4	Annunciator	21
3.3.5	Battery Backup Terminal	22
	This port connects to the ADRF-BBS/BBL-24 (24V battery backup unit) via a dedicated cable provided by the ADRF.	22
3.3.6	Grounding.....	23
4.	Alarms	24
4.1	Message Board Alarms and Notifications	24
4.2	External Alarms.....	25
4.2.1	External Alarm Output interface	25
5	Installation	26
5.1	Installation Procedures	26
5.1.1	Wall Mount Procedure	26
5.1.2	PSR-ANN Annunciator Installation	26
5.2	Antenna Separation/Isolation.....	28
6.	ADRF-BBL/BBS-U Installation	30
6.1	Installation Procedures	30
7.	PSR-78-9533-U/9537-U Web-GUI Setup introduction.....	34
7	PSR-78-9533-UA Web-GUI Setup.....	35
7.1	Repeater/PC Connection Using Web-GUI.....	35
7.2	Status Tab	36
7.2.1	Band Info	37
7.2.2	Power & Gain.....	37
7.2.3	Alarms.....	38

7.2.4	AAI	38
7.2.5	Repeater Info / Repeater Location / Technical Support / Installer Contact Info.....	39
7.3	Control Tab	40
7.3.1	General Settings	41
7.3.1.1	Emergency Power Off Switch Support	41
7.3.2	System	41
7.3.3	Manual Gain Control	42
7.3.4	Alarm Settings & Battery Alarm Settings.....	42
7.4	Install Tab.....	43
7.4.1	Technology	44
7.4.2	Band Selection	44
7.4.3	SNMP	45
7.4.4	Location	45
7.4.5	Modem Box Setting	45
7.4.6	AAI Input.....	46
7.4.7	Location Info / Installer Info	46
7.4.8	Date & Time.....	46
7.5	System	47
7.5.1	System: Account	47
7.5.1.1	System: Account – Account Management.....	47
7.5.1.2	System: Account – New Account	47
7.5.1.3	System: Account – Change Password	47
7.5.2	System – SNMP.....	48
7.5.3	System – Logs	48
7.5.4	System – Update	49
7.5.5	System – Backup / Restore.....	50
7.6	Help.....	51
7.7	Logout.....	51
8.	Maintenance Guide for PSR-78-9533-U/9537-U Repeater.....	51
8.1	Periodic Inspection Checklist	51
8.2	Preventive Measures for Optimal Operation	52
8.2.1	Recommendations.....	52
8.2.2	Precautions.....	52
9.	Warranty and Repair Policy	52
9.1	General Warranty	52
9.2	Limitations of Warranty.....	52
9.3	Limitation of Damages	52
9.4	No Consequential Damages.....	52
9.5	Additional Limitation on Warranty	52

9.6	Return Material Authorization (RMA)	52
10.	Specifications	53
10.1	Electrical Specifications	53
10.2	Mechanical Specifications	54
10.3	Power Specifications	54
10.4	ADRF-BBS-U-24 / ADRF-BBL-U-24 Runtime Calculations	54
PSR-78-9533-U (Dual Band) w/ (1) ADRF-BBL-U-24		55
PSR-78-9533-U (Dual Band) w/ (2) ADRF-BBS-U-24 + ADRF-BBX-U-CBL-21P		55
PSR-78-9537-U (Dual Band) w/ (1) ADRF-BBL-U-24	오류! 책갈피가 정의되어 있지 않습니다.	
10.5	Warranty & Certificates	55
11.	anical Drawing	56
12.	Appendix	60
12.1	Shutdown Retry Logic	60

FIGURES

Figure 1-1	PSR-78-9533-X/9537-X Repeater Parts List	10
Figure 1-2	PSR-78-9533-X/9537-X Quick View (Bottom)	11
Figure 1-2	PSR-ANN Annunciator	12
Figure 2-1	LED Panel	18
Figure 2-2	Host/Remote Switch	19
Figure 2-3	AC Input Port	오류! 책갈피가 정의되어 있지 않습니다.
Figure 2-4	AC On/Off Switch	19
Figure 2-5	External Alarm Port	20
Figure 2-6	RF Ports	21
Figure 2-10	Annunciator Port	22
Figure 2-7	Battery Backup Port (4-pin Female)	22
Figure 2-8	Battery Switch	22
Figure 2-9	Ground Cable Terminal	23
Figure 4-1	Wall Mount	26
Figure 4-2	PSR-ANN Repeater Mount	27
Figure 4-3	PSR-ANN Wall Mount	27
Figure 4-4	RF Repeater Oscillation	28
Figure 5-1	Login Page	35
Figure 5-2	Status Tab	36
Figure 5-3	Status Tab – Band Info Display	37
Figure 5-4	Status Tab – Power & Gain Display	37
Figure 5-5	Status Tab – Alarm Display	38
Figure 5-6	Status Tab – AAI Alarm Display (Remote Power Switch Disabled)	38
Figure 5-7	Status Tab – AAI Alarm Display (Remote Power Switch Enabled)	38
Figure 5-8	Status Tab – Repeater Info / Repeater Location / Technical Support / Installer Contact Info	39
Figure 5-9	Control Tab	40
Figure 5-10	Control Tab – General Setting	41
Figure 5-11	AAI Alarm Cable – Alarm Input	41
Figure 5-12	Control Tab – System	41
Figure 5-13	Control Tab – Manual Gain Control	42
Figure 5-14	Control Tab – Alarm & Battery Alarm Settings	42

Figure 5-15	Install Tab	43
Figure 5-16	Install Tab – Technology	44
Figure 5-17	Install Tab – Band Selection	44
Figure 5-18	Install Tab – SNMP	45
Figure 5-19	Install Tab – Location	45
Figure 5-20	Install Tab – Modem Box Setting	45
Figure 5-21	Install Tab – AAI Input	46
Figure 5-22	Install Tab – Location Info / Installer Info	46
Figure 5-23	Install Tab – Date & Time	46
Figure 5-24	System: Account – Account Management	47
Figure 5-25	System: Account – New Account	47
Figure 5-26	System: Account – Change Password	47
Figure 5-27	SNMP	48
Figure 5-28	System: Logs	49
Figure 5-29	System: Update	49
Figure 5-30	System: Update is Complete Popup Message	50
Figure 5-31	System: Backup / Restore	50
Figure 5-32	Help	51
Figure 9-1	PSR-78-9533-X Mechanical Drawing	오류! 책갈피가 정의되어 있지 않습니다.
Figure 9-2	PSR-78-9533-UA Mechanical Drawing	오류! 책갈피가 정의되어 있지 않습니다.
Figure 9-3	PSR-ANN Annunciator Mechanical Drawing	오류! 책갈피가 정의되어 있지 않습니다.

TABLES

Table 1-1	Parts List	10
Table 2-1	LED Specifications	18
Table 2-2	External Alarm Port Pin Description	20
Table 3-1	Message Board Alarms and Notifications	24
Table 3-2	Alarms	오류! 책갈피가 정의되어 있지 않습니다.
Table 8-1	Electrical Specifications	53
Table 8-2	Mechanical Specifications	54
Table 8-3	Power Specifications	54
Table 8-4	Warranty & Certificates	55

Terms and Abbreviations

The following is a list of abbreviations and terms used throughout this document.

Abbreviation/Term	Definition
AGC	Automatic Gain Control
ALC	Automatic Level Control
AROMS	ADRF Repeater Operation and Management System
BDA	Bi-Directional Amplifier
BTS	Base Transceiver Station
CDMA	Code Division Multiple Access
CFR	Crest Factor Reduction
CP	Cyclic Prefix
CW	Continuous Wave (un-modulated signal)
DAS	Distributed Antenna System
DL	Downlink
HPA	High Power Amplifier
HW	Hardware
IF	Intermediate Frequency
LNA	Low Noise Amplifier
LTE	Long Term Evolution
MS	Mobile Station
OFDM	Orthogonal Frequency-Division Multiplexing
OFDMA	Orthogonal Frequency-Division Multiple Access
PAR (PAPR)	Peak to Average Power Ratio (Crest Factor)
PLL	Phase Locked Loop
PSU	Power Supply Unit
QAM	Quadrature Amplitude Modulation
QPSK	Quadrature Phase Shift Keying
RB	Resource Block
RF	Radio Frequency
SC-FDMA	Single Carrier-Frequency Division Multiple Access
SQE	Signal Quality Estimate
SW	Software
UE	User Equipment
UL	Uplink
VSWR	Voltage Standing Wave Ratio

1. INTRODUCTION

PSR-78-9533-UA bi-directional amplifiers (BDAs) extend the coverage area of radio communications in buildings and RF shadow environments. These units feature low noise figure and wide dynamic range and are certified to UL 2524.

The PSR-78-9533-UA is a revolutionary digital public safety repeater designed to protect the lives of first responders and building occupants.

The PSR-78-9533-UA is the best-in-class public safety repeater with FirstNet support and it is fully compliant with International Fire Code (IFC) and National Fire Protection Association (NFPA).

Product Features

- NFPA 1221 2016 code compliant and FirstNet compliant
- Alarming output to supervised circuits for: antenna, amplifier, power supply, battery, and charger failure
- IP66 compliant enclosure for both indoor and outdoor environments
- Class B wideband repeater designations
- Up to 95dB of gain and up to 37 dBm downlink output power per band and up to 30 dBm uplink output power shared

1.1 Highlights

- UL 2524 Certified
- Supports both 700MHz and 800MHz Public Safety Frequencies in a single repeater
- Supports a total of 2 wide band and up to 32 non-contiguous narrow band channels (700MHz + 800MHz PS)
- Air convection cooling without fans
- Sharp Filter Roll-off performance (Wide: 60dBc @ Filter Bandwidth Edge + 1MHz | Narrow: 55dBc @ Filter Bandwidth Edge + 3 * Filter BW)
- Supports SNMP v1, v2c, v3 (get and set)
- Web-based GUI Interface; No 3rd party GUI software required
- Web-GUI connectivity via DHCP in host mode
- External Alarm Function supporting dry contacts (11 outputs, 1 input)
- Support Emergency Power Off Switch

1.2 Parts List

Table 1-1 Parts List

Label	Quantity	Description
A	1	PSR-78-9533-UA
B	1	Wall Mount Bracket
C	1	Mounting Bracket Template
D	1	AAI Alarm Cable
E	1	Ethernet Cable (Crossover)
F	4	Anchor Bolt
G	1	PSR-ANN (Annunciator Panel)

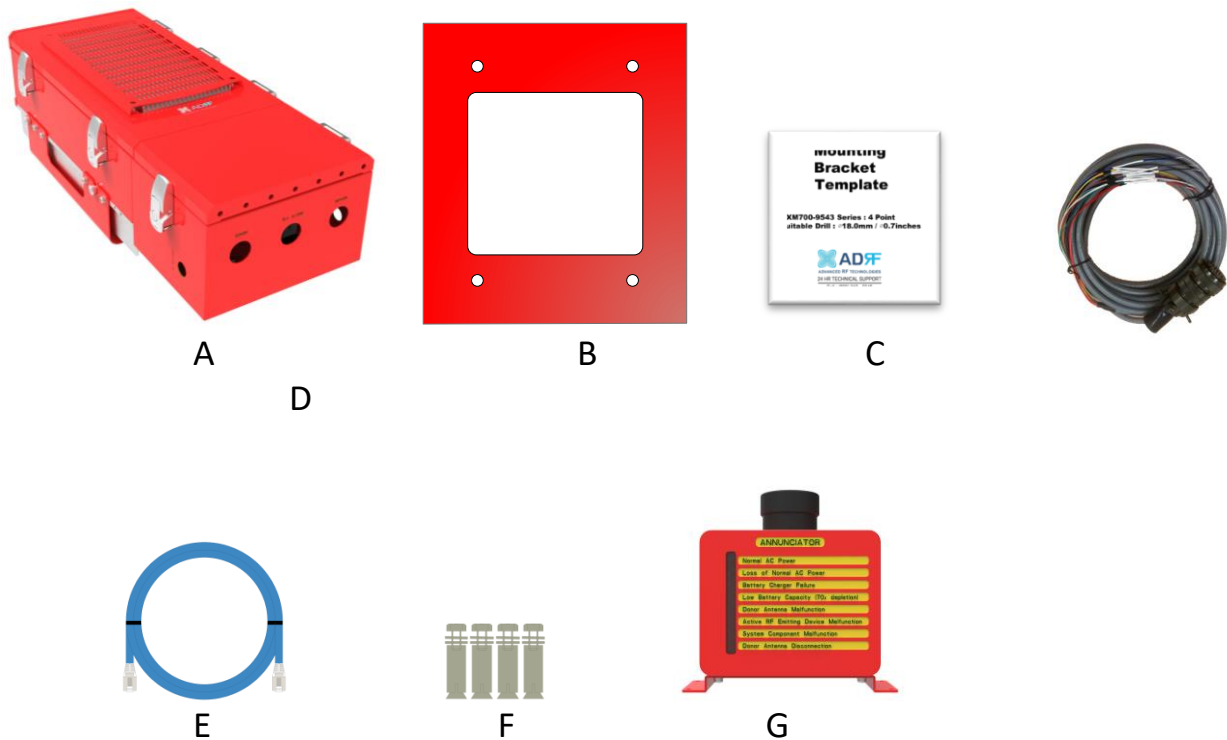

Figure 1-1 PSR-78-9533-UA Repeater Parts List

1.3 Quick View



Figure 1-2 PSR-78-9533-UA External Ground Terminal

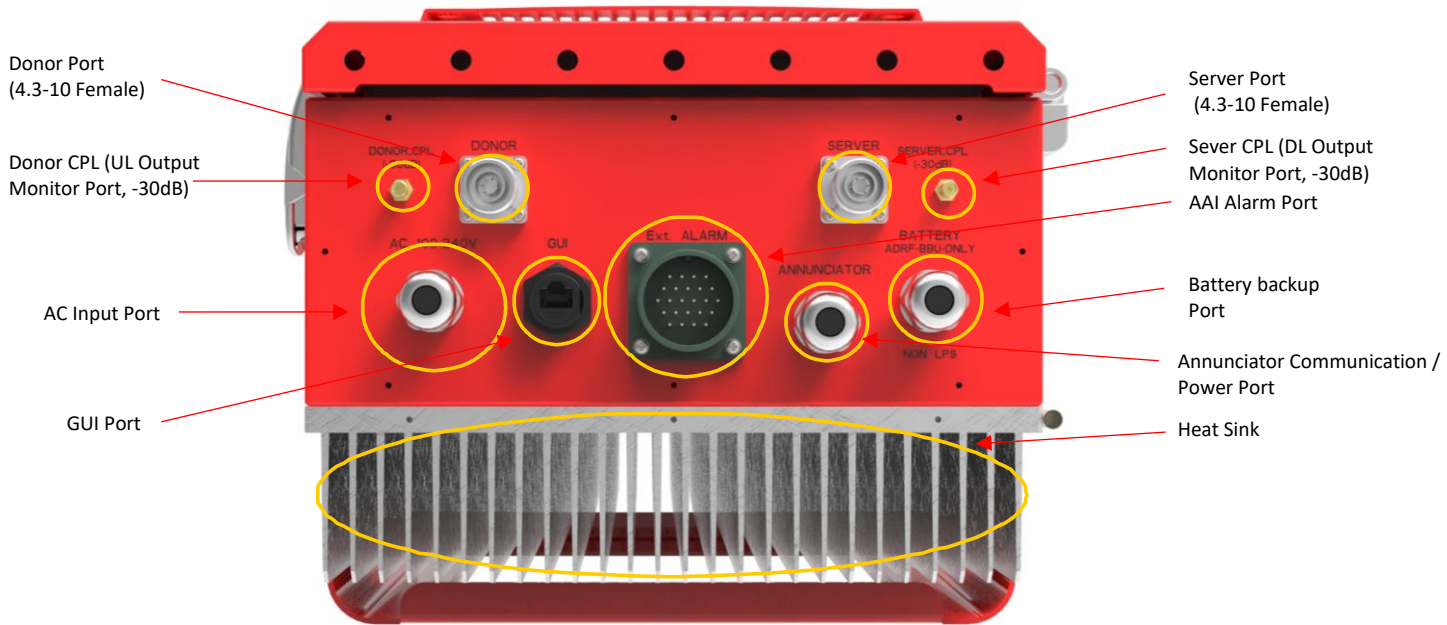

Figure 1-3 PSR-78-9533-UA Quick View (Bottom)



Figure 1-4 PSR-ANN Annunciator

1.4 Warnings and Hazards



WARNING! ELECTRIC SHOCK

Opening the PSR-78-9533-UA could result in electric shock and may cause severe injury.

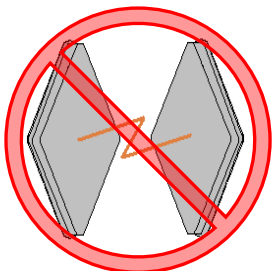

WARNING! DAMAGE TO REPEATER

Operating the PSR-78-9533-UA with antennas in very close proximity facing each other could lead to severe damage to the repeater.

RF EXPOSURE & ANTENNA PLACEMENT Guidelines

Actual separation distance is determined upon gain of antenna used.

Please maintain a minimum safe distance of 210 cm while operating near the donor and the server antennas. Also, In accordance with the FCC regulations (90.219), this device must meet 5W ERP requirements.

WARRANTY

Opening or tampering the PSR-78-9533-UA will void all warranties.

Lithium Battery: CAUTION. RISK OF EXPLOSION IF BATTERY IS REPLACED BY INCORRECT TYPE. DISPOSE OF USED BATTERIES ACCORDING TO INSTRUCTIONS.

Preclude indications that Home/ personal use are prohibited.

Use of unauthorized antennas, cables, and/or coupling devices not conforming with ERP/EIRP is prohibited.

FCC Part 15.21

Any changes or modifications not expressly approved by the party responsible for compliance could void the user's authority to operate this equipment.

FCC Part 15 Class A

NOTE: This equipment has been tested and found to comply with the limits for a Class A digital device, pursuant to part 15 of the FCC Rules. These limits are designed to provide reasonable protection against harmful interference when the equipment is operated in a commercial environment. This equipment generates, uses, and can radiate radio frequency energy and, if not installed and used in accordance with the instruction manual, may cause harmful interference to radio communications. Operation of this equipment in a residential area is likely to cause harmful interference in which case the user will be required to correct the interference at their own expense.

FCC Part 90 Class A

WARNING. THIS is NOT a CONSUMER device. It is designed for installation by FCC LICENSEES and QUALIFIED INSTALLERS. You MUST have an FCC LICENSE or express consent of an FCC Licensee to operate this device. You MUST register Class B signal boosters (as defined in 47 CFR 90.219) online at www.fcc.gov/signal-boosters/registration. Unauthorized use may result in significant forfeiture penalties, including penalties in excess of \$100,000 for each continuing violation.

Regulatory Warning Statement

FCC RF Radiation Exposure Statement:

This equipment complies with FCC RF radiation exposure limits set forth for an uncontrolled environment. This equipment should be installed and operated with a minimum distance of 210 cm between the radiator and your body. This transmitter must not be co-located or operating in conjunction with any other antenna or transmitter.

RSS-GEN (6.8 Transmit antenna)

Under Industry Canada regulations, this radio transmitter may only operate using an antenna of a type and maximum (or lesser) gain approved for the transmitter by Industry Canada. To reduce potential radio interference to other users, the antenna type and its gain should be so chosen that the equivalent isotropically radiated power (e.i.r.p.) is not more than that necessary for successful communication. (Max. peak gain: 17 dBi)

Conformément à la réglementation d'Industrie Canada, le présent émetteur radio peut fonctionner avec une antenne d'un type et d'un gain maximal (ou inférieur) approuvé pour l'émetteur par Industrie Canada.

Dans le but de réduire les risques de brouillage radioélectrique à l'intention des autres utilisateurs, il faut choisir le type d'antenne et son gain de sorte que la puissance isotroperayonnée équivalente (p.i.r.e.) ne dépasse pas l'intensité nécessaire à l'établissement d'une communication satisfaisante. (Max. peak gain: 17 dBi)

RF Radiation Exposure

This equipment complies with RF radiation exposure limits set forth for an uncontrolled environment. This equipment should be installed and operated with a minimum distance of **210 cm** between the radiator and your body. This transmitter must not be co-located or operating in conjunction with any other antenna or transmitter. RF exposure will be addressed at time of installation and the use of higher gain antennas require larger separation distances.

L'antenne (ou les antennes) doit être installée de façon à maintenir à tout instant une distance minimum de au moins **210 cm** entre la source de radiation (l'antenne) et toute personne physique. Cet appareil ne doit pas être installé ou utilisé en conjonction avec une autre antenne ou émetteur.

2. INSTALLATION

2.1 Wiring Compartment

The bottom of the PSR-78-9533-UA is a wiring compartment with pre-cut holes. These holes are designed to be used in conjunction with conduit hubs to prevent water ingress. A total of 6 pre-cut holes are available to use for the various cables that will be needed for the proper operation of the repeater.

To maintain UL 2524 Listed status, unused ports must be properly weather proofed.

Table 2-1 Pre-cut hole size and labels

Silkscreen Label	Location	Diameter
AC 100-240V	LEFT	22.2mm (7/8")
ANNUNCIATOR	RIGHT	22.2mm (7/8")
BATTERY ADRF-BBU ONLY NON LPS	RIGHT	22.2mm (7/8")
DONOR	BOTTOM	33.0mm (1-3/8")
Ext. ALARM	BOTTOM	33.0mm (1-3/8")
SERVER	BOTTOM	33.0mm (1-3/8")

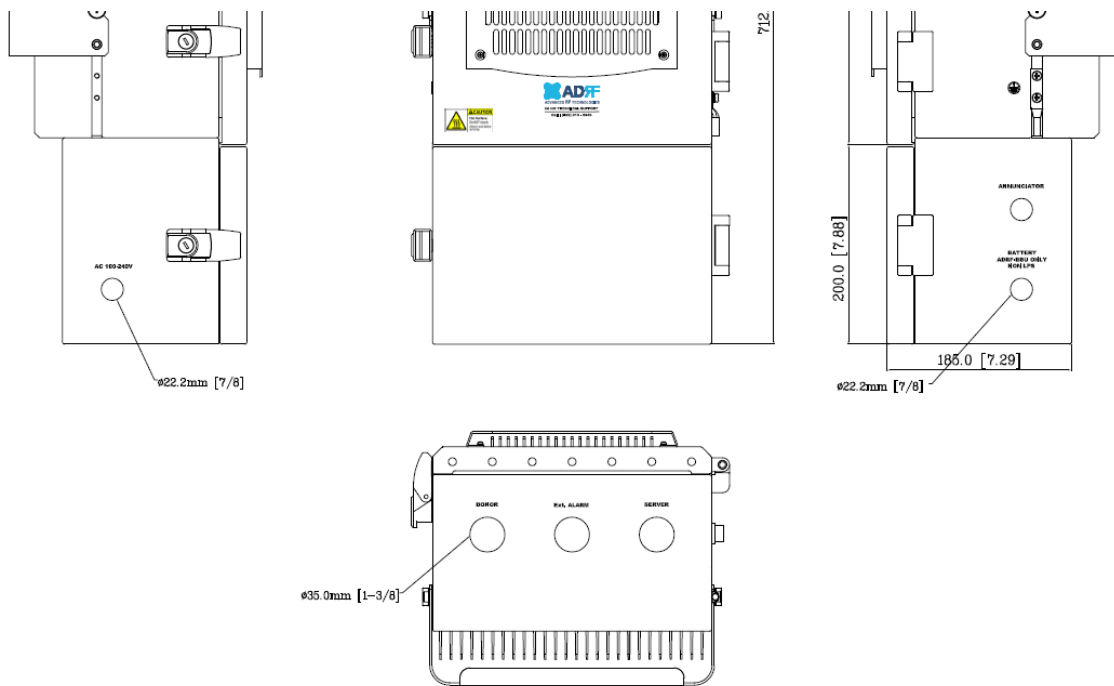

Figure 2-1 Wiring Compartment Cutout Holes

2.2 Wire Terminals

Non-power limited cables such as the AC power line and the DC battery line shown below in red must be separated by ¼" from power limited cables such as the donor/server, ext. alarm, and annunciator lines shown below in black. To maintain the ¼" spacing, route the annunciator line above the server line as shown in the picture below.

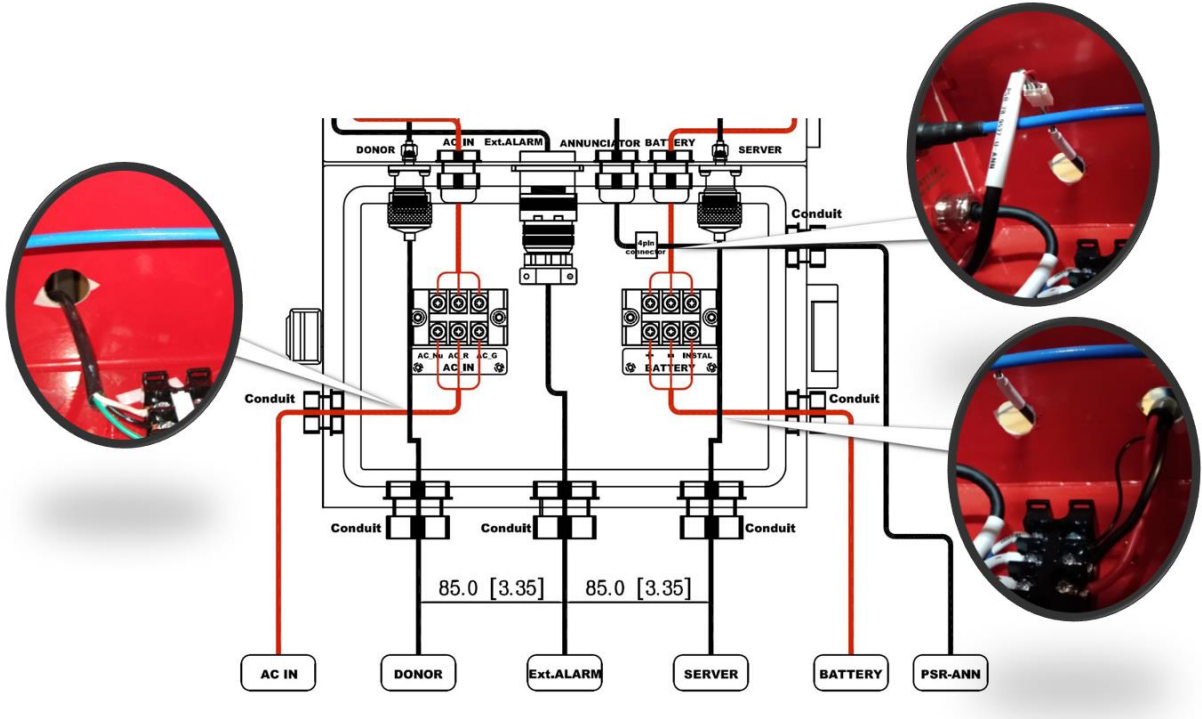

Figure 2-2 Terminal Wiring Diagram

2.2.1 AC 100-240V Terminal Block

The AC 100-240V Terminal Block is located on the left side of the wiring compartment. One side of the terminal block will be pre-wired and connected to the PSU and the chassis ground. The open terminals must be connected to an AC power source between 100-240V AC and secured in an electrical breaker box on its own circuit. The terminal block can support up to a cable gauge of 12AWG.

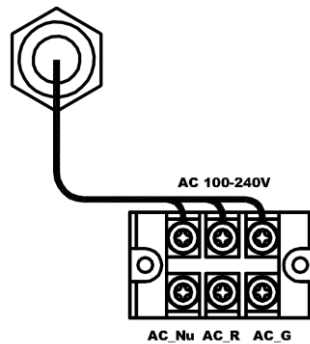

Figure 2-3 AC 100-240V Terminal Block

Table 2-2 Terminal Block Definition

Silkscreen Label	Line Type	Max Supported AWG
AC_NU	Neutral	12AWG
AC_R	Line or Hot	12AWG
AC_G	Ground	12AWG

3. OVERVIEW

3.1 LED

PSR-78-9533-UA LED indicator lights are located on the inside of the repeater towards the bottom. Below the LED indicators is a button that is used to trigger the door open alarm.



Figure 3-1 LED Panel

Table 3-1 LED Specifications

POWER	DL	UL	ALARM
AC Fail	DL Signal Not Detected	UL Out-Band Overload	Power-Related Alarms
DC Fail	DL Signal Low Detected	UL Input Overload	RF DL Path Related Alarms
Battery Fail	DL RF Power	UL DSP Over Input	RF UL Path Related Alarms
Low Battery	DL Out-Band Overload	UL Over Input	Over Temperature
Battery Not Charge	DL Input Overload	UL Over Power	DSP Communication
Battery Not Connected	DL DSP Over Input	UL Return Power	Door Open
Over Current	DL Over Input	UL PLL Fail	System Halt
	DL Over Power		
	DL Return Power		
	DL PLL Fail		

LED Indicator	Specifications
Solid Green	Normal operation
Solid Yellow	Soft Fail alarm exists in the system
Solid Red	Hard Fail alarm exists in the system

3.2 Host / Remote Switch

The Host/Remote Switch allows the user to switch the default Repeater IP, Subnet Mask, and Gateway of the Ethernet port of the repeater to an alternative setup. These settings can only be adjusted by logging into the repeater under HOST mode and configuring the settings under the Modem Box Setting section on the Install Page (section 7.4.5).

Once the settings are set, flipping the switch to the REMOTE position will reboot the repeater with the new alternate settings. *Please note that when the repeater is set to the REMOTE position, DHCP is disabled and the repeater will not automatically assign an IP address to any device that connects directly to the repeater.*

- Host IP: 192.168.63.1 (Fixed IP, unable to modify this IP address)

- Remote IP: 192.168.63.5 (Default IP, but can be modified in Host mode)



Figure 3-2 Host/Remote Switch

3.3 Cable Connection

3.3.1 AC Power

The AC Terminal is located at the bottom of the wiring compartment on the opposite side of the wiring compartment door. The repeater has a free-voltage range input of 100-240V AC. The AC terminal box can support a max gauge of 12AWG and should be connected to the breaker box on its own circuit.

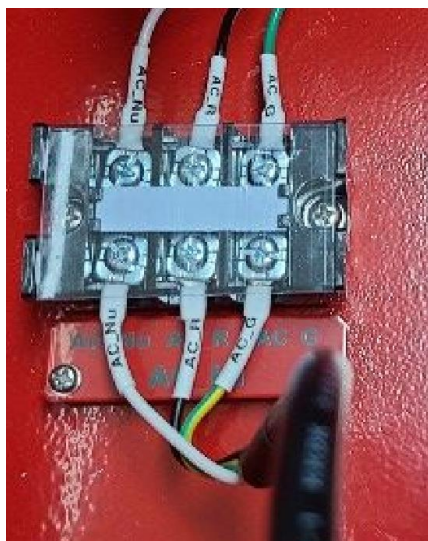

Figure 3-1 AC Terminal

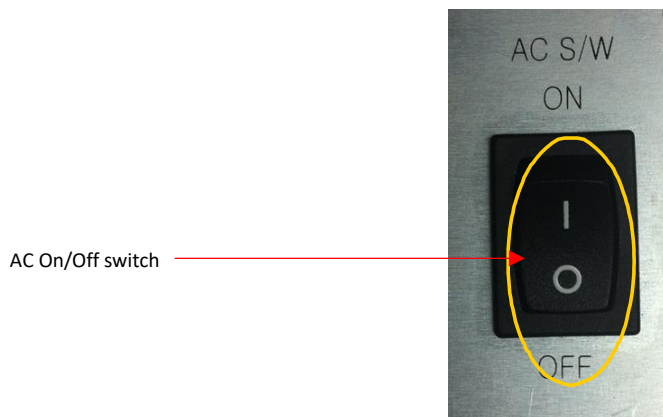

Figure 3-2 AC On/Off Switch

The AC Power on/off switch is on the left-hand side of the PSU which is located inside of the repeater.

3.3.2 External Alarm



Figure 3-3 External Alarm Port

This port should be connected only to the fire alarm control panel.

Table 3-1 External Alarm Port Pin Description

Pin	Color	Pin Description (24 pins)	ADRF External Alarm Box Pin Description	Alarm Type
A	Black	Donor antenna malfunction_P	1-POS	Output
B	Black	Donor antenna malfunction_N	1-NEG	Output
C	Brown	Active RF device malfunction_P	2-POS	Output
D	Brown	Active RF device malfunction_N	2-NEG	Output
E	Red	Low battery capacity (70%)_P	3-POS	Output
F	Red	Low battery capacity (70%)_N	3-NEG	Output
G	Orange	System component malfunction_P	4-POS	Output
H	Orange	System component malfunction_N	4-NEG	Output
J	Yellow	Normal AC Power_P	5-POS	Output
K	Yellow	Normal AC Power_N	5-NEG	Output
L	Green	Loss of normal AC Power_P	6-POS	Output
M	Green	Loss of normal AC Power_N	6-NEG	Output
N	Blue	Battery charger failure_P	7-POS	Output
P	Blue	Battery charger failure_N	7-NEG	Output
Q	Purple	Summary Alarm_P	8-POS	Output
R	Purple	Summary Alarm_N	8-NEG	Output
S	Grey	Donor Antenna Disconnect_P	9-POS	Output
T	Grey	Donor Antenna Disconnect_N	9-NEG	Output
U	White	Oscillation Alarm_P	10-POS	Output
V	White	Oscillation Alarm_N	10-NEG	Output
W	Pink	ANN Disconnection_P	11-POS	Output
X	Pink	ANN Disconnection_N	11-NEG	Output
Y	Light Blue	N.C.	-	-
Z	Light	N.C	-	-

	Blue		
--	------	--	--

3.3.3 RF

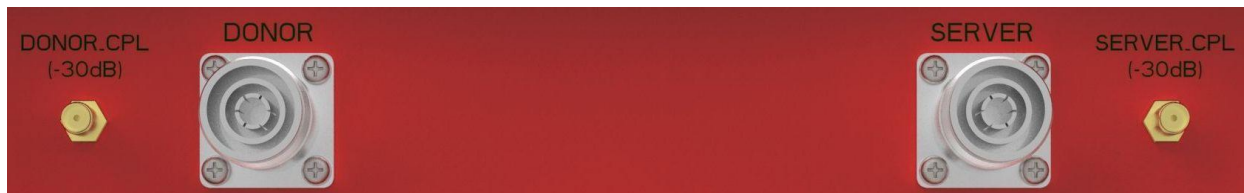

Figure 3-4 RF Ports

The RF connections are made via two 4.3-10 female connectors. The RF connector labeled “DONOR” must be connected to the antenna pointing towards the base station. The DONOR port can receive both 700 and 800MHz public safety signals. The RF connection labeled “SERVER” must be connected to the antenna facing the area to be covered by the BDA. The repeater has a single SERVER port that supports both 700 and 800MHz public safety signals.

The RF connections must be made using cables with an impedance of 50 ohms.

The separation between the antennas is necessary to prevent oscillation. Oscillation occurs when the signal entering the system continually re-enters, due to the lack of separation between the donor and server antennas. In other words, the signal is being fed back into the system. This creates a constant amplification of the same signal. As a result, the noise level rises above the signal level.

To prevent feedback, the donor and server antennas must be separated by an appropriate distance to provide sufficient isolation. Isolation is attained by separating antennas a sufficient distance so that the output of one antenna does not reach the input of the other. This distance is dependent on the gain of the repeater.

- **DONOR** – 4.3-10 female which is used to connect the donor antenna (700MHz + 800MHz PS)
- **DONOR_CPL (30dB)** – SMA female 30 dB coupling port which is used to monitor the amplified UL signal
- **SERVER_CPL (30dB)** – SMA female 30 dB coupling port which is used to monitor the amplified DL signal
- **SERVER** – 4.3-10 female which is used to connect the server antenna (700MHz + 800MHz PS)

3.3.4 Annunciator

The Annunciator port provided power and communication to the PSR-ANN annunciator box. The PSR-ANN annunciator box provides a summary status of the repeater via LED indicator lights and an audible alarm.

The default length of the cable that is provided to connect to the PSR-78-U to the PSR-ANN is 2m (6.5ft). Additional cable lengths at 10ft, 20ft, and 33ft are available. The maximum distance of the cable between the PSR-78-U repeater and the PSR-ANN annunciator is limited to 20m (66ft).



Figure 3-5 Annunciator Port

3.3.5 Battery Backup Terminal

This port connects to the ADRF-BBS/BBL-24 (24V battery backup unit) via a dedicated cable provided by the ADRF.

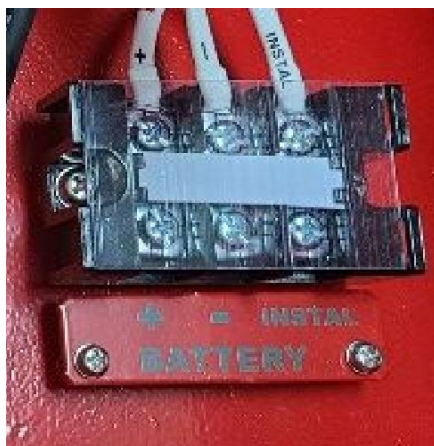

Figure 3-6 Battery Backup Port (4-pin Female)

When the ADRF-BBS/BBL-24 is connected to the repeater, the battery switch on the PSU must be switched to the ON position. This will enable the repeater to charge the ADRF-BBS/BBL-24 battery backup unit when AC power is present.



Figure 3-7 Battery Switch

The PSR-78-9533-UA can be connected to an ADRF-BBS/BBL-24 to provide power during a power failure. If an ADRF-BBS/BBL-24 is utilized, connect it to the PSR-78-9533-UA via the external battery port.

(WARNING: The circuit breaker switch on the ADRF-BBS/BBL-24 must be set to OFF before connecting it to the PSR-78-9533-UA to prevent damage to the repeater or the ADRF-BBS/BBL-24 and personal injury.)

Note: Please contact ADRF Technical Support for assistance if you are unfamiliar with the installation procedure of the battery box.

3.3.6 Grounding

The grounding terminal is located at the lower right-hand side of the BDA. A grounding cable should be properly connected before powering on the equipment.

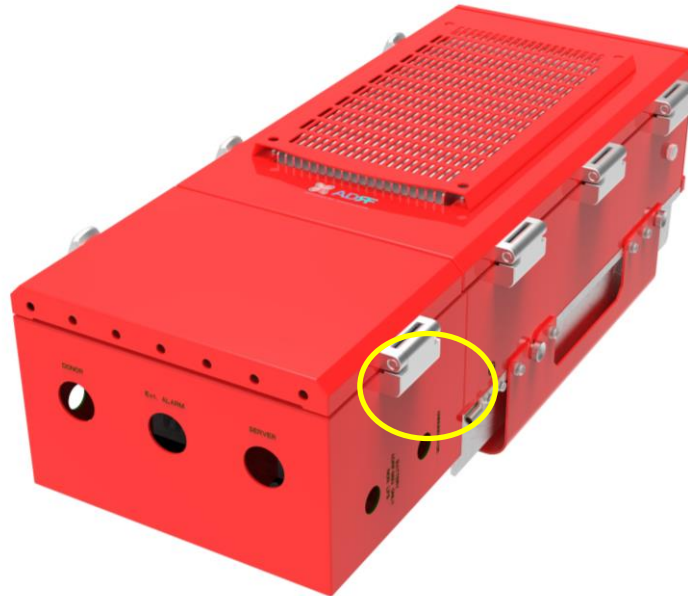

Figure 3-8 Ground Cable Terminal

Ground terminals located on the side of the repeater and can support a ground cable up to 1.25mm² (16AWG) in diameter and should be permanently connected to a grounding bar.

4. ALARMS

4.1 Message Board Alarms and Notifications

Table 4-1 Message Board Alarms and Notifications

Alarm	Alarm Description	Trigger Condition
AC Fail	AC Input is outside of operating range	The power supply is not operating within specs. (4 seconds)
DC Fail	DC Output is outside of operating range	The power supply is not operating within specs. (4 seconds)
Temperature	The module is above/below the normal operating temperature	The module is above the normal operating temperature. (4 seconds) Over Temperature [Soft: 80~87 C, Hard: Above 87 C]
Current	PSU is providing more than the max current	The power supply is not operating within specs. (4 seconds) Over Current [Hard: Above 20A]
System Halt	The system is in a shutdown state due to a hard fail alarm	The system is in a shutdown state due to a hard fail alarm. (10 cycles)
DSP Fault	The system has detected an issue with the internal DSP	The system has detected an issue with the internal DSP chip. (Cannot communicate with DSP)
OSC	Oscillation detected	Oscillation detected.
DL Signal not detected	DL signal is below the specified level	DL signal is below the specified level. (default: -90dBm, 4 seconds)
DL Signal Low	DL signal is below the specified level	DL signal is below the specified level. (default: -85dBm, 4 seconds)
Input Overload	Incoming in-band DL or UL signal is too strong	Input signal is above the threshold. (4 seconds) (Soft: DL -5dBm/UL -5dBm, Hard: DL +5dBm/UL +5dBm)
Out of band Overload	Incoming out-band DL or UL signal is too strong	Out of band signal is above the threshold. (4 seconds) (Soft: DL -5dBm/UL -5dBm, Hard: DL +5dBm/UL +5dBm)
Synthesizer Lock Fail	There is an issue with the internal PLL	There is an issue with internal PLL. (4 seconds)
DL RF Power	Input + gain does not match the output level (above delta of 6 dB)	Input + gain does not match the output level. (default delta of 6 dB)
Overpower	The output level is above the max output levels	The output level is above the max output levels. AGC On case (Soft: AGC Level + 1~2dB, Hard: AGC Level + >2dB) AGC Off case (Soft: max output level + 1~2dB, Hard: max output level + >2dB)
VSWR	Power is being reflected back to the repeater	Power is being reflected back to the repeater. Threshold = output power - 8dB. For example, if the repeater is outputting 24dBm and detects 16dBm of return power, then the VSWR will be triggered. (Alarm will only trigger when the output power is 15dBm or greater)
Heartbeat	Heartbeat is sent out to the NOC	Heartbeat sent at set interval.
Reboot	Soft reboot performed	Reboot is performed from the Control tab.
Factory setting	Factory default settings restored	Factory setting is set from the Control tab.
Door	Door alarm set/clear	Door alarm set: Door open Door alarm clear: Door close

4.2 External Alarms

The PSR-78-9533-UA supports dry contact alarms and can be connected to a fire alarm control panel. The user can program the repeater to either create an open or closed circuit when an alarm is present in the system.

4.2.1 External Alarm Output interface

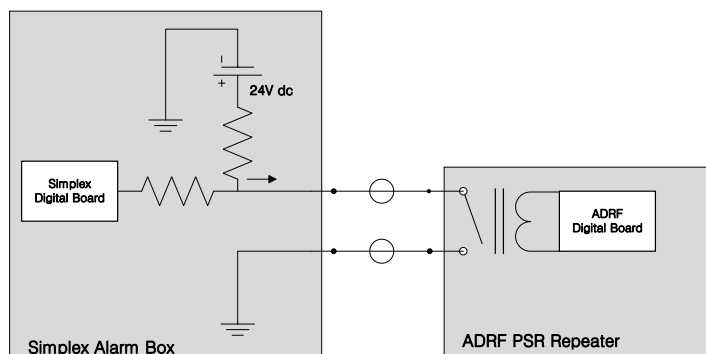

Table 4-2 External Alarm

External Alarm Name	Set Condition	Likely Causes
Donor Antenna Malfunction	- UL Return Power Hard Fail	- Damaged Donor Antenna
Active RF Device Malfunction	- RF Power Soft Fail - DL Return Power Hard Fail - DL/UL Over Power Hard Fail - DL/UL Input Overload Hard Fail	- Degrading Amplifier - Open or Disconnected Server Port - Oscillation - Strong RF Input Signal
Low Battery Capacity (70% depleted)	- Low Battery Soft Fail	- Battery Depleted
System Component Malfunction	- Over Current Hard Fail - Over Temperature Hard Fail - DSP Hard Fail - Out-band Overload Hard Fail	- Faulty or Damaged PSU - Ambient Temperature - DSP Filter Fault - Strong RF Input Signal
Normal AC Power	- AC Normal Set - AC Fail Soft Clear	- Powered by AC Power - Powered by DC Power
Loss of Normal AC Power	- AC Fail Soft Set - AC Normal Clear	- Powered by DC Power - Powered by AC Power
Battery Charger Failure	- Battery Fail Soft Fail - Battery Not Connected Soft fail - Battery Not Charge Soft Fail	- Low Battery Charging Voltage - Battery Cable Disconnected - Degraded Batteries
Summary Alarm	- Any Active Alarm	- Any Active Alarm Present in the System
Donor Antenna Disconnect	- No DL Signal Detected	- Disconnected Donor Line
Oscillation Alarm	- Oscillation Hard Fail	- Gain Set Too High or Lack of Isolation
Annunciator Disconnect	- Annunciator Disconnect Hard Fail	- Disconnected PSR-ANN

5 INSTALLATION

5.1 Installation Procedures

5.1.1 Wall Mount Procedure

- Verify that the PSR-78-9533-UA and mounting holes are in good condition
- Place the PSR-78-9533-UA mounting bracket template up against the wall and mark off mounting holes
- Drill the appropriate size holes and install the included wall anchors
- Remove the wall mount bracket from the repeater and bolt the wall mount bracket to the wall
- Place the repeater onto the wall mount bracket and secure the bracket to the repeater
- Connect the GND cable
- Connect the Antenna cables
- Connect the Power cable

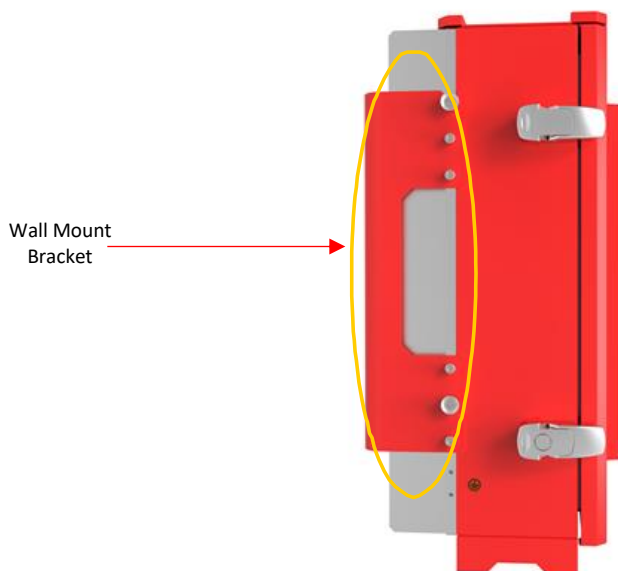

Figure 5-1 Wall Mount

5.1.2 PSR-ANN Annunciator Installation

The PSR-ANN annunciator box has been designed to either mount on top of the PSR-78-9533-UA repeater or can also be wall mounted separately. By default, the mounting bracket is configured to mount to the top of the repeater with the mounting bracket at the bottom of the PSR-ANN annunciator box. If individually wall mounting the PSR-ANN, then the bracket will need to be moved from the bottom of the box to the back of the box.

Once the PSR-ANN annunciator box has been securely mounted, connect the included power/data cable from the side of the PSR-ANN box to the port labeled Annunciator on the PSR-78-9533-UA.

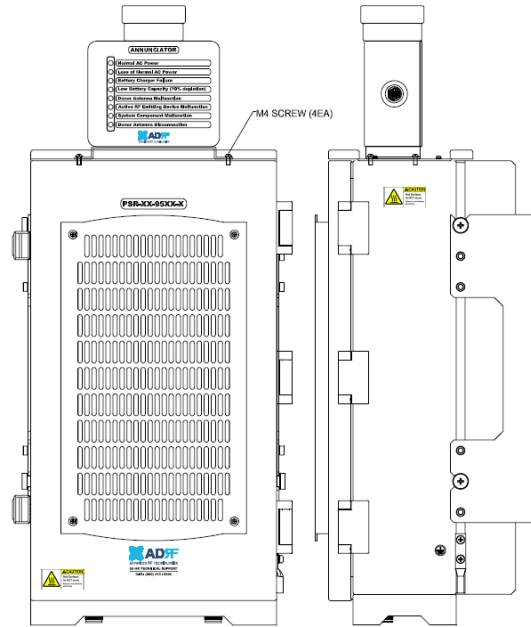

Figure 5-2 PSR-ANN Repeater Mount

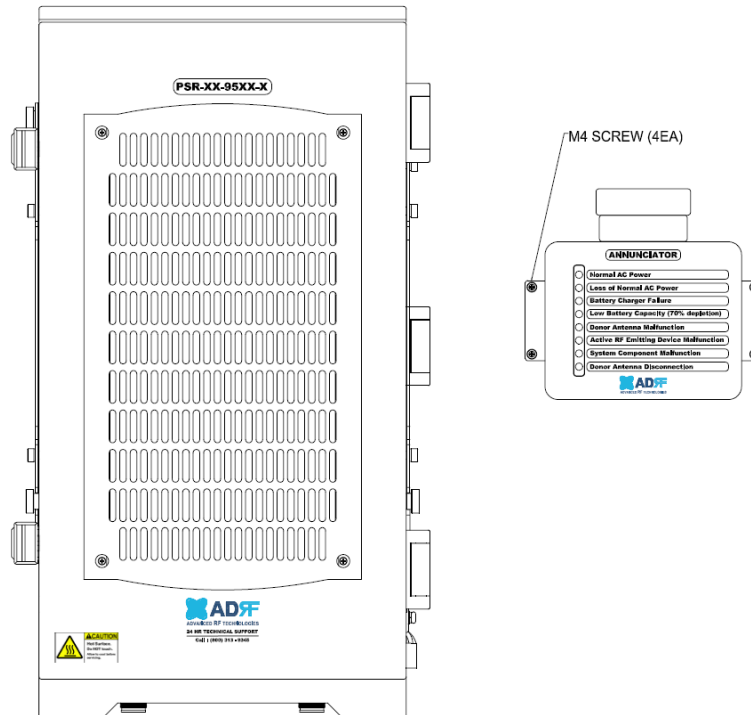

Figure 5-3 PSR-ANN Wall Mount

5.2 Antenna Separation/Isolation

The separation between the donor and server antennas is necessary to prevent oscillation. Oscillation occurs when the signal entering the system continually re-enters, due to the lack of separation between the donor and server antennas. In other words, the signal is being fed back into the system. This creates a constant amplification of the same signal. As a result, the noise level rises above the signal level.

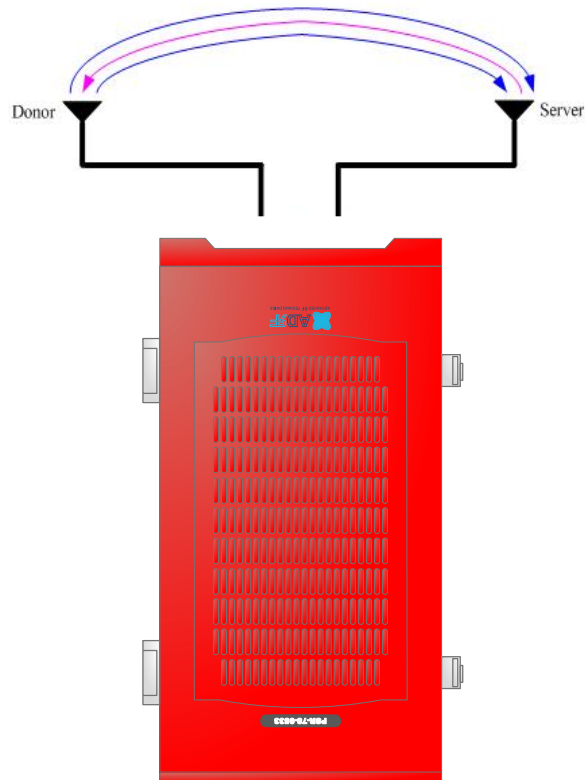

Figure 5-4 RF Repeater Oscillation

To prevent feedback, the donor and server antennas must be separated by an appropriate distance to provide sufficient isolation. Isolation can be attained by separating antennas at a sufficient distance so that the output of one antenna does not reach the input of the other. This distance is dependent on the gain of the repeater.

DO NOT APPLY AC POWER TO THE BDA UNTIL CABLES ARE CONNECTED TO BOTH PORTS OF THE BDA AND THE ANTENNAS.

1. To mount on a wall. Using appropriate screws and anchors attach the BDA to the wall at the four mounting holes.
2. Ensure that the isolation between the donor antenna and the serving antennas is at least 15 dB greater than the BDA gain.
3. Connect the cable from the donor antenna to the BDA connector labeled “DONOR” and the cable from the serving antennas to the BDA connector labeled “SERVER”.
4. Connect the AC power cord to the BDA and turn on the switch at the left of PSU.
5. Installation of the BDA is now complete. Adjust the gain controls to suit the specific signal environment through the GUI on your PC.

6. ADRF-BBL/BBS-U INSTALLATION

6.1 Installation Procedures

The ADRF-BBL/BBS-U battery backup unit houses two 12V batteries that are connected in series to have a nominal voltage of 24VDC. The battery charger is built into the PSU located inside of the PSR-78-9533/9537-U. When the system is being powered by AC, the PSU will charge the ADRF-BBL/BBS-U battery backup. When there is a loss of primary power (AC), then repeater will switch over to the secondary power (DC) provided by the battery backup. Once the primary power is restored, the PSR-78-9533/9537-U will switch back to operating with AC power and will resume charging the battery backup.

1. Verify that the repeater has been properly grounded.



2. Loosen each wheel lock by spinning the red dial to the left.



3. Move the ADRF-BBL-U-24 to the desired location and spin the red dial to the right to tighten wheel locks.

4. The brackets on the back of the ADRF-BBL/BBS-U unit can be used to secure to the wall **ONLY when it is stationed on the floor**. Due to the total weight of the ADRF-BBL/BBS-U w/ batteries, it CANNOT be wall mounted off the ground. The brackets are not designed to support the full weight of the ADRF-BBL/BBS-U when it is wall mounted without any additional support. If a wall mounting solution is needed, then an optional wall mount kit (ADRF-BBL/BBS-X-WMK) is available for purchase.



5. Use the included key to unlock the door latches to open the ADRF-BBL-U-24.
6. On the ADRF-BBL-U, set the power switch to the OFF position.

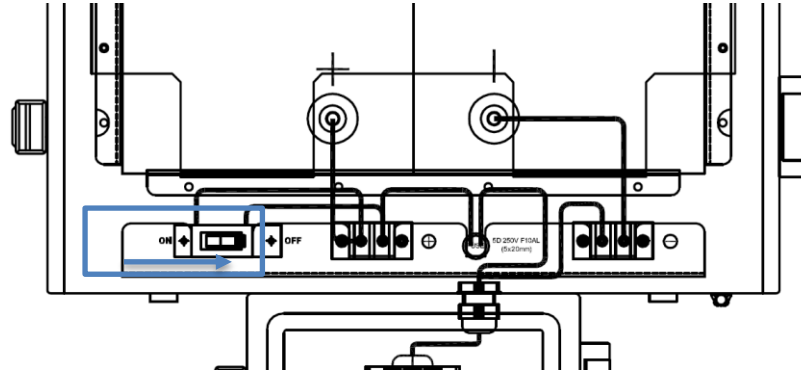

7. On the PSR-78-9533/9537-U, verify that both **AC** and **BATT** switches have been set to the OFF position.

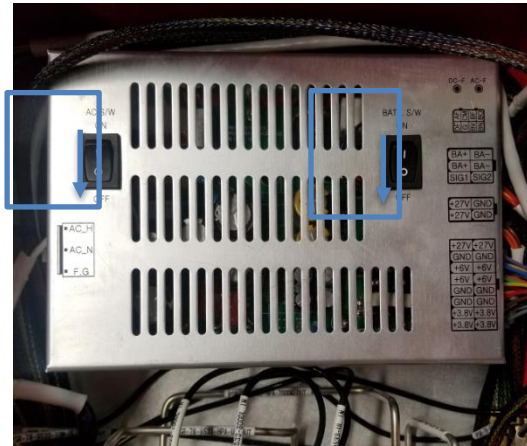

8. Use the provided battery backup cable from the ADRF-BBL-U and connect the wires to the terminal block located inside of the wiring compartment of the PSR-78-9533/9537-U.

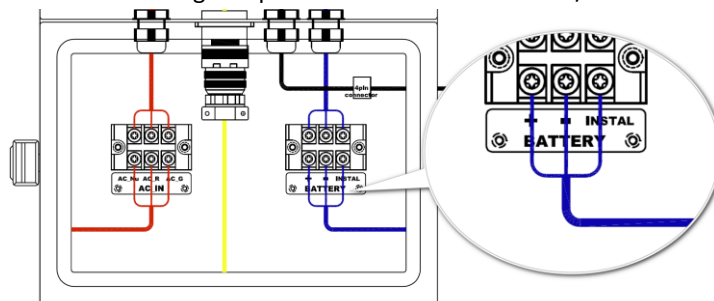

9. Install a conduit hub connector that can support 7/8" onto the PSR-78-9533-UA hole labeled BATTERY and snake the cable through the conduit.

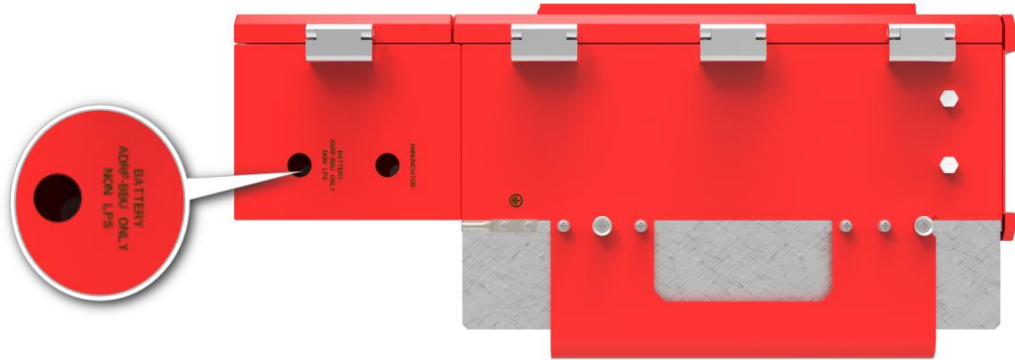

10. Install a conduit hub connector that can support 7/8" onto the ADRF-BBL-U hole labeled BATTERY.
11. Open the wiring compartment of the ADRF-BBL-U and wire the battery cable to the terminal block.

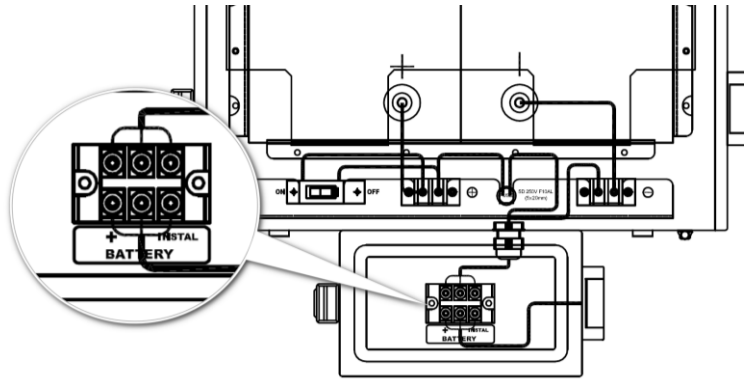

12. On the PSR-78-9537-U, wire the AC terminal block to your dedicated circuit breaker

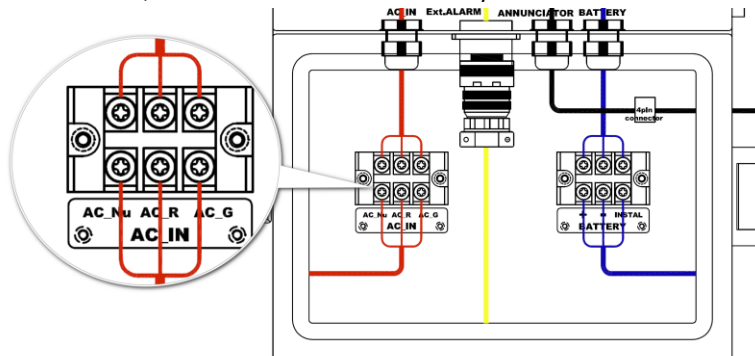

13. On the PSR-78-9533-UA, flip the **POWER** and **BATT** switch to the ON position.

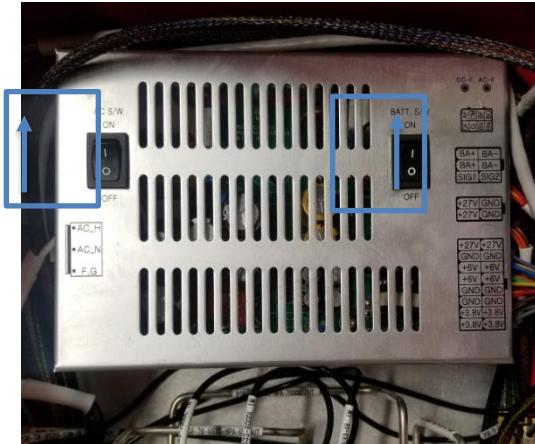

14. On the ADRF-BBL-U-24, set the circuit breaker to the ON position.

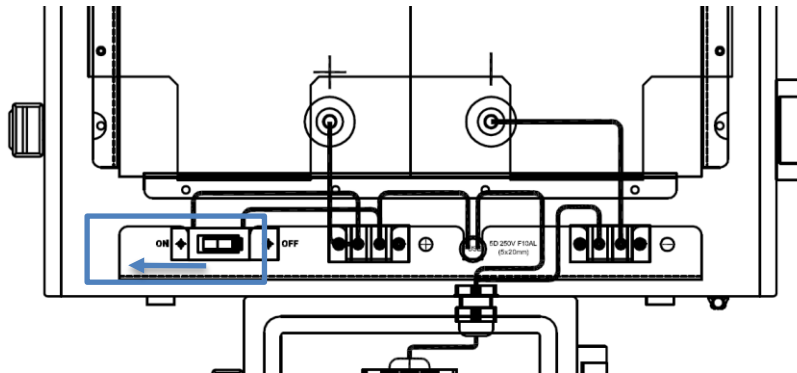

7. PSR-78-9533-UA WEB-GUI SETUP INTRODUCTION

The Web-GUI allows the user to communicate with the repeater locally. To connect to the repeater locally, you will need a laptop with an Ethernet port and an RJ-45 crossover cable.

NOTICE TO USERS, INSTALLERS, AUTHORITIES HAVING JURISDICTION, AND OTHER INVOLVED PARTIES			
This product incorporates field-programmable software. In order for the product to comply with the requirements in the Standard for in-building 2-Way Emergency Radio Communication Enhancement Systems, UL 2524 certain programming features or options must be limited to specific values or not used at all as indicated below.			
Program feature or option	Permitted in UL 2524? (Y/N)	Possible settings	Settings permitted in UL 2524
Remote Power Switch	N	Enable/Disable	Disable
Battery Not Charge Check	Y	On/Off	On
Battery Check	Y	Check All/Except Installed/Check Off	Check All
Donor Antenna Malfunction Check Time	Y	0sec, 10sec, 45sec, 90sec, 3min, 6min, 15min, 30min, 1hour, 2hour, 4hour, 8hour, 12hour, 24hour, and 48hour	0sec, 10sec, 45sec, 90sec, 3min, 6min, 15min, 30min, 1hour, 2hour, 4hour, 8hour, 12hour, and 24hour

Please note that some selections of the Donor Antenna Malfunction Check Time setting could impact the compliance of the UL 2524 code. The selections available for this option are 0sec, 10sec, 45sec, 90sec, 3min, 6min, 15min, 30min, 1hour, 2hour, 4hour, 8hour, 12hour, 24hour, and 48hour. Selection of 24 hours or less will be required to remain compliant with UL 2524.



Figure 7-1 Donor Antenna Malfunction Check Time

7 PSR-78-9533-UA WEB-GUI SETUP

The Web-GUI allows the user to communicate with the repeater either locally or remotely. To connect to the repeater locally, you will need a laptop with an Ethernet port and an RJ-45 crossover cable. To connect to the repeater remotely, you will need to have an active internet connection via an external modem or LAN.

7.1 Repeater/PC Connection Using Web-GUI

- Verify that your Local Area Network Connection is set to **obtain an IP address automatically** under the Internet Protocol (TCP/IP) properties.
- If you are connecting to the unit remotely (use of a modem), then skip the step above.
 - Connect the RJ-45 crossover cable between the laptop's Ethernet port and the repeater's Ethernet port.
 - Launch either Internet Explorer or Google Chrome.
 - Type the following IP address into the address bar of the Internet Browser: <http://192.168.63.1>
- If you are connecting to the unit remotely, then type the IP address of the modem to connect to the unit
 - The following login screen will appear:
 -

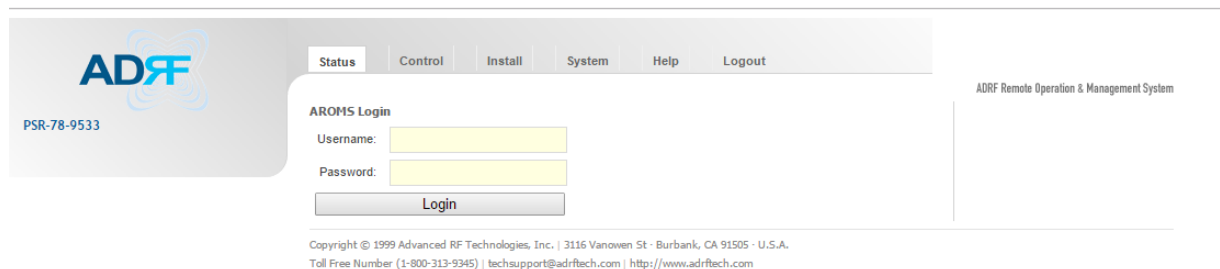

Figure 7-2 Login Page

If you are not the Administrator, please type in your assigned username & password which you should have received from the Administrator.

The default username and password for the General User is **adrf** & **adrf**, respectively.
The default Administrator login is **admin** & **admin**, respectively.

7.2 Status Tab

PSR-78-9533
Site ID : ADRF Tech
Mode :
N – P S700 (16ch) + PS800 (16ch) (758-861MHz)

The Signal For Success

Advanced RF Technologies, Inc. ("ADRF") is an established, leading provider of in-building equipment and services that improve wireless coverage and capacity for the largest service providers and enterprise customers around the world.

Status | Control | Install | System | Help | Logout

		PS700			PS800		
		Downlink			Uplink		
Power & Gain							
Input [dBm]		---			---		
OutBand [dBm]		-30.8			-54.9		
Gain [dB]	User Set	50.0			50.0		
	Actual	50.0			50.0		
Output [dBm]		---			---		
Band Info							
		Downlink			Uplink		
		Input (dBm)	Center Frequency (MHz)	BW (KHz)	Input (dBm)	Center Frequency (MHz)	BW (KHz)
Broad	Channel 1	---	--	--	---	--	--
	Channel 2	---	--	--	---	--	--
	Channel 1	---	--	--	---	--	--
	Channel 2	---	--	--	---	--	--
	Channel 3	---	--	--	---	--	--
	Channel 4	---	--	--	---	--	--
	Channel 5	---	--	--	---	--	--
Narrow	Channel 6	---	--	--	---	--	--
	Channel 7	---	--	--	---	--	--
	Channel 8	---	--	--	---	--	--
	Channel 9	---	--	--	---	--	--
	Channel 10	---	--	--	---	--	--
	Channel 11	---	--	--	---	--	--
	Channel 12	---	--	--	---	--	--
	Channel 13	---	--	--	---	--	--
	Channel 14	---	--	--	---	--	--
	Channel 15	---	--	--	---	--	--
	Channel 16	---	--	--	---	--	--

Alarms

System	PS700	PS800	Power
Over Temperature			Door Open
DSP Fail			System Halt

Normal
 Soft Fail
 Hard Fail
 Inactive

AAI

Donor Antenna Malfunction
Active RF Emitting Device Malfunction
Low Battery Capacity (70% depletion)
System Component Malfunction
Normal AC Power
Loss of Normal AC Power
Battery Charger Failure
Low Battery Capacity (70% depletion)
Donor Antenna Malfunction
Active RF Emitting Device Malfunction
System Component Malfunction
AAI Alarm In

Active
 Inactive

Figure 7-3 Status Tab

7.2.1 Band Info

The Band Info section displays frequency information along with the corresponding bandwidths that have been set from the Install tab. Input levels for each channel are also displayed in this section.

		Downlink			Uplink		
		Input (dBm)	Center Frequency (MHz)	BW (KHz)	Input (dBm)	Center Frequency (MHz)	BW (KHz)
Broad	Channel 1	--	--	--	--	--	--
	Channel 2	--	--	--	--	--	--
Narrow	Channel 1	--	--	--	--	--	--
	Channel 2	--	--	--	--	--	--
	Channel 3	--	--	--	--	--	--
	Channel 4	--	--	--	--	--	--
	Channel 5	--	--	--	--	--	--
	Channel 6	--	--	--	--	--	--
	Channel 7	--	--	--	--	--	--
	Channel 8	--	--	--	--	--	--
	Channel 9	--	--	--	--	--	--
	Channel 10	--	--	--	--	--	--
	Channel 11	--	--	--	--	--	--
	Channel 12	--	--	--	--	--	--
	Channel 13	--	--	--	--	--	--
	Channel 14	--	--	--	--	--	--
Channel 15	--	--	--	--	--	--	
Channel 16	--	--	--	--	--	--	

Figure 7-4 Status Tab – Band Info Display

7.2.2 Power & Gain

This section displays the Input, Gain, and Output for both downlink and uplink.

		Downlink	Uplink
Input [dBm]		--	--
OutBand [dBm]		--	--
Gain [dB]	User Set	50.0	50.0
	Actual	50.0	50.0
Output [dBm]		--	--

Figure 7-1 Status Tab – Power & Gain Display

- **Input [dBm]** – Displays the in-band Downlink/Uplink signal level. The system will display “--” when the input level is < -90 dBm.
- **Outband [dBm]** – Displays the out-band composite power.
- **Gain [dB]**
 - User Set: Displays the amount of gain that the user set.
 - Actual: Displays the actual amount of gain that is currently in use.
- **Output [dB]** – Displays the Downlink/Uplink composite output power levels. The system will display “--”, when the output level is < +5 dBm.

7.2.3 Alarms

This section displays the alarm status for System alarms, RF Alarms, and Power alarms. If an alarm is present in the system, then the color of the alarm tab will change according to the type of failure.

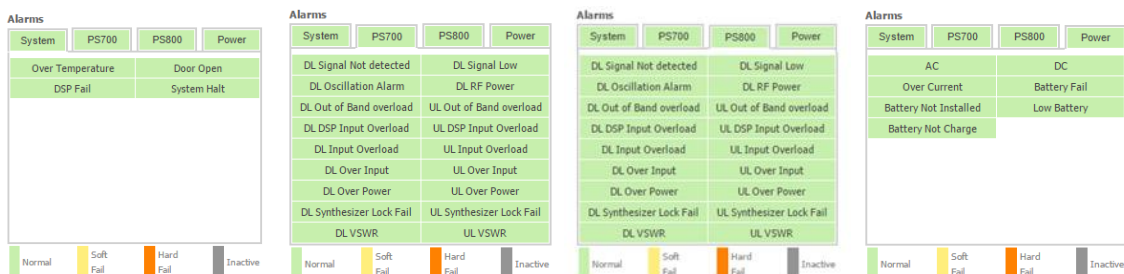

Figure 7-2 Status Tab – Alarm Display

7.2.4 AAI

This section displays the AAI alarm status for each dry contact alarm. Red indicates that the dry contact alarm is active and light blue indicates the alarm is inactive. If the Remote Power Switch function is enabled, then the AAI Alarm In status will not be present from the AAI alarm status since this function is disabled when the Remote Power Switch is enabled.

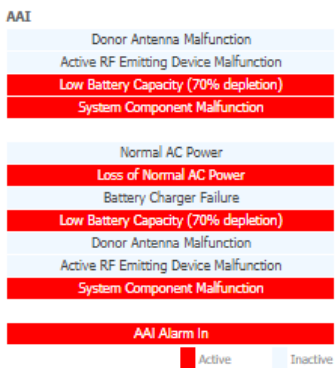

Figure 7-3 Status Tab – AAI Alarm Display (Remote Power Switch Disabled)

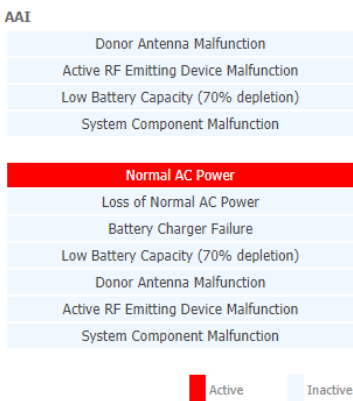

Figure 7-4 Status Tab – AAI Alarm Display (Remote Power Switch Enabled)

7.2.5 Repeater Info / Repeater Location / Technical Support / Installer Contact Info

Information	
Serial Number	
Latitude	
Longitude	
Firmware	F2.0.F
Web GUI	F2.0.0

Location	Description

Technical Support
 Phone: 1-800-313-9345
 E-mail: techsupport@adrftech.com

Installer Contact Info
 Company:
 Installer:
 Phone:
 E-mail:

Figure 7-5 Status Tab – Repeater Info / Repeater Location / Technical Support / Installer Contact Info

- **Repeater Info:** Displays the serial number, latitude, longitude, firmware version, and Web-GUI version
- **Repeater Location:** Displays the address where the repeater is installed
- **Technical Support:** Displays ADRF’s Technical Support contact information
- **Installer Contact Info:** Displays the installer’s name, phone, and e-mail address

7.3 Control Tab

General Settings

- ALC On
- PS 700 DL HPA On PS 800 DL HPA On
- PS 700+800 UL HPA On
- Remote Power Switch

Apply

System

PS700

Manual Gain Control

- DL Gain [dB] 50.0 ▼
- UL Gain [dB] 50.0 ▼
- DL ALC Level [dBm] 37.0 ▼
- UL ALC Level [dBm] 30.0 ▼
- DL ALC Offset Level [dB] 7.0 ▼
- UL ALC Offset Level [dB] 7.0 ▼
- DL /UL Gain Balance ON Off ▼

Apply

PS800

Alarm Settings

- DL Signal Low Level [dBm] -85.0 ▼
- DL Signal Not Detect Level [dBm] -90.0 ▼
- DL RF Power Level [dB] 6.0 ▼
- DL Over Power Level [dBm] 37.0 ▼
- UL Over Power Level [dBm] 30.0 ▼

Apply

Battery Alarm Settings

- Battery Check Check All ▼
- Battery Not Charge Check On ▼

Apply

AAI Test

Alarm setting Status Closed Open

Donor Antenna Malfunction Check Time 3min ▼

AAI Test On

<ul style="list-style-type: none"> Fire Alarm Donor Antenna Malfunction Normal ▼ Active RF Emitting Device Malfunction Normal ▼ Low Battery Capacity (70% depletion) Set ▼ System Component Malfunction Set ▼ 	<ul style="list-style-type: none"> System Monitoring Normal AC Power Normal ▼ Loss of Normal AC Power Set ▼ Battery Charger Failure Set ▼ Low Battery Capacity (70% depletion) Set ▼ Donor Antenna Malfunction Normal ▼ Active RF Emitting Device Malfunction Normal ▼ System Component Malfunction Set ▼
--	--

Apply

Figure 7-6 Control Tab

7.3.1 General Settings

The General Settings section allows the user to enable/disable amplifiers and the ALC routine.

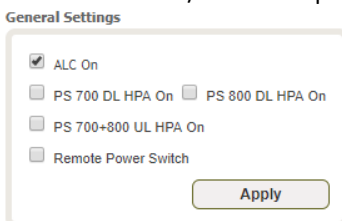

Figure 7-7 Control Tab – General Setting

- **ALC ON:** Enables or disables Automatic Level Control (ALC)
- **PSR 700 DL HPA On:** Enables or disables the Downlink High Power Amplifier (HPA) for 700MHz PS
- **PSR 800 DL HPA On:** Enables or disables the Downlink High Power Amplifier (HPA) for 800MHz PS
- **PSR 700+800 UL HPA On:** Enables or disables the Uplink High Power Amplifier (HPA) for 700+800MHz PS
- **Remote Power Switch:** Enables or disables the Remote Power Switch function

To enable/disable any of the settings, click on the checkbox and click the Apply button.

7.3.1.1 Emergency Power Off Switch Support

The PSR-78-9533-UA now support the ability to connect an extern power switch to turn on/off the high power amplifier via our Alarm Input dry contact pins. This Emergency Power Off (EPO) function is an optional feature that is only active when the function is enabled. If the EPO function is enabled, the AAI dry contact input alarm pair will no longer function. This feature is available on firmware version 2.0.33 or higher and older repeaters can be updated using a field upgradeable firmware.

On the dry contact alarming cable, if the Alarm Input-1 & GND (light blue pair) is an open circuit, the DL and UL HPA will be turned on. If this pair is shorted together (closed circuit) then the DL and UL HPA will turn off. If needed, the cable length can be extended up to approximately 300 ft. using CAT6 Shielded Twisted Pair cable.



Figure 7-8 AAI Alarm Cable – Alarm Input

7.3.2 System

Under the System section, the user is able to perform a soft reboot on the repeater and also can restore factory default settings.



Figure 7-9 Control Tab – System

- **Reboot:** Performs a soft reboot of the repeater
- **Factory Set:** Restores all settings to factory defaults

7.3.3 Manual Gain Control

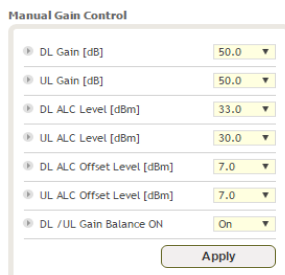

Figure 7-10 Control Tab – Manual Gain Control

- **DL/UL Gain:** Gain levels of the repeater can be specified here
- **DL/UL ALC Level:** Prevents the output power from exceeding the specified value
- **DL/UL Output ALC Offset:** If any ALC attenuation has been applied, the system will release this attenuation when the signal level drops by the specified level
- **DL /UL Gain Balance ON:** Allows the user to enable or disable the gain balance. When gain balance is enabled, the delta value between the downlink and uplink gains remain constant

7.3.4 Alarm Settings & Battery Alarm Settings

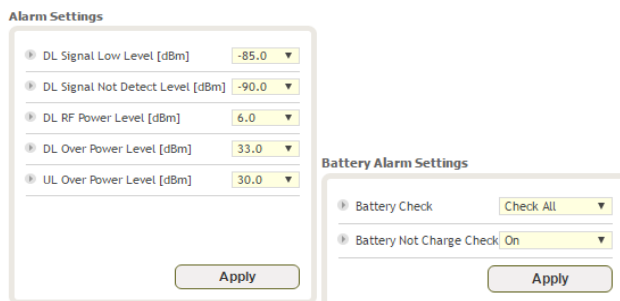

Figure 7-11 Control Tab – Alarm & Battery Alarm Settings

- **DL Signal Low Level:** Allows the user to specify how low the signal can be before triggering a “Downlink Signal Low” soft-fail alarm
- **DL Signal Not Detected Level:** Allows the user to specify how low the signal can be before triggering a “Downlink Signal Not Detected” soft-fail alarm
- **DL RF Power Level:** Allows the user to set a maximum deviation value for the downlink RF power before triggering a “DL RF Power Level” soft-fail alarm
 - For example, if the input signal is -50 dBm and the gain is set to 60 dB, the expected output power should be 10 dBm. If the Downlink RF Power alarm value is set to 6dB, then a soft-fail alarm will trigger if the output power falls below 4 dBm
- **DL Over Power Level:** DL Over Power Alarm will trigger when the DL output level exceeds this level
- **UL Over Power Level:** UL Over Power Alarm will trigger when the UL output level exceeds this level
- **Battery Check:**
 - Check All – All battery related alarms are checked which include Battery Fail, Battery Not Installed, Low Battery, and Battery Not Charge
 - Except Install – Only Battery Fail, Low Battery, and Battery Not Charge alarms are checked
 - Check Off – Does not perform any battery check
- **Battery Not Charge Check:**
 - On – Checks for the Battery Not Charge alarm
 - Off – Disables the check for the Battery Not Charge alarm

7.4 Install Tab

Status Control Install System Help Logout

Technology

N - PS700 (16ch) + PS800 (16ch) (758-861MH ▼)

Band Selection

PS700				PS800				
	Channel Center Frequency (MHz)	Bandwidth (KHz)	Downlink Gain (dB)	DSP Output Level (dBm)	Set	Downlink Freq (MHz)		
						Start	End	
Broad	PS7K ▼	--	OFF ▼	0.0 ▼	--	<input type="button" value="Apply"/>	--	--
	PS7L ▼	--	OFF ▼	0.0 ▼	--	<input type="button" value="Apply"/>	--	--
Narrow	Ch. 1	--	OFF ▼	0.0 ▼	--	<input type="button" value="Apply"/>	--	--
	Ch. 2	--	OFF ▼	0.0 ▼	--	<input type="button" value="Apply"/>	--	--
	Ch. 3	--	OFF ▼	0.0 ▼	--	<input type="button" value="Apply"/>	--	--
	Ch. 4	--	OFF ▼	0.0 ▼	--	<input type="button" value="Apply"/>	--	--
	Ch. 5	--	OFF ▼	0.0 ▼	--	<input type="button" value="Apply"/>	--	--
	Ch. 6	--	OFF ▼	0.0 ▼	--	<input type="button" value="Apply"/>	--	--
	Ch. 7	--	OFF ▼	0.0 ▼	--	<input type="button" value="Apply"/>	--	--
	Ch. 8	--	OFF ▼	0.0 ▼	--	<input type="button" value="Apply"/>	--	--
	Ch. 9	--	OFF ▼	0.0 ▼	--	<input type="button" value="Apply"/>	--	--
	Ch. 10	--	OFF ▼	0.0 ▼	--	<input type="button" value="Apply"/>	--	--
	Ch. 11	--	OFF ▼	0.0 ▼	--	<input type="button" value="Apply"/>	--	--
	Ch. 12	--	OFF ▼	0.0 ▼	--	<input type="button" value="Apply"/>	--	--
	Ch. 13	--	OFF ▼	0.0 ▼	--	<input type="button" value="Apply"/>	--	--
	Ch. 14	--	OFF ▼	0.0 ▼	--	<input type="button" value="Apply"/>	--	--
	Ch. 15	--	OFF ▼	0.0 ▼	--	<input type="button" value="Apply"/>	--	--
	Ch. 16	--	OFF ▼	0.0 ▼	--	<input type="button" value="Apply"/>	--	--

SNMP

Site ID:

Description:

Modem Box Setting

Repeater IP:

Subnet Mask:

Gateway:

Location

Latitude: + .

Longitude: + .

AAI Input

AAI Input 1:

Figure 7-12 Install Tab

7.4.1 Technology

This section allows the user to set the repeater mode to either use PS700, PS800, or PS700+PS800.

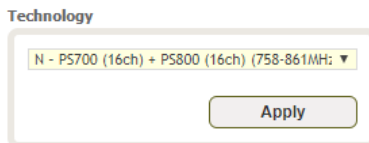

Figure 7-13 Install Tab – Technology

The following choices are available from the drop-down menu:

- N – PS700 (16ch) + PS800 (16ch) (758-861MHz)
- S1 – PS700 (12ch) + PS800 (20ch) (758-861MHz)
- S7 – PS700 (32ch) (758-775MHz)
- S8 – PS800 (32ch) (851-861MHz)

7.4.2 Band Selection

Band Selection		PS700				PS800		
		Channel Center Frequency (MHz)	Bandwidth (KHz)	Downlink Gain (dB)	DSP Output Level (dBm)	Set	Downlink Freq (MHz) Start	End
Broad	PS700 ▼	--	OFF ▼	0.0 ▼	--	Apply	--	--
	PS800 ▼	--	OFF ▼	0.0 ▼	--	Apply	--	--
Narrow	Ch. 1	--	OFF ▼	0.0 ▼	--	Apply	--	--
	Ch. 2	--	OFF ▼	0.0 ▼	--	Apply	--	--
	Ch. 3	--	OFF ▼	0.0 ▼	--	Apply	--	--
	Ch. 4	--	OFF ▼	0.0 ▼	--	Apply	--	--
	Ch. 5	--	OFF ▼	0.0 ▼	--	Apply	--	--
	Ch. 6	--	OFF ▼	0.0 ▼	--	Apply	--	--
	Ch. 7	--	OFF ▼	0.0 ▼	--	Apply	--	--
	Ch. 8	--	OFF ▼	0.0 ▼	--	Apply	--	--
	Ch. 9	--	OFF ▼	0.0 ▼	--	Apply	--	--
	Ch. 10	--	OFF ▼	0.0 ▼	--	Apply	--	--
	Ch. 11	--	OFF ▼	0.0 ▼	--	Apply	--	--
	Ch. 12	--	OFF ▼	0.0 ▼	--	Apply	--	--
	Ch. 13	--	OFF ▼	0.0 ▼	--	Apply	--	--
	Ch. 14	--	OFF ▼	0.0 ▼	--	Apply	--	--
	Ch. 15	--	OFF ▼	0.0 ▼	--	Apply	--	--
	Ch. 16	--	OFF ▼	0.0 ▼	--	Apply	--	--

Figure 7-14 Install Tab – Band Selection

Band selection allows the user to specify the desired frequencies by inputting the center frequencies and selecting the bandwidths.

- **Channel Center Frequency:** The user can input the center frequency of the pass-band.
- **Bandwidth:** Allows the user to select the desired bandwidth for the passband. Choices for wideband frequencies include 3, 5, or 10 MHz. Narrowband choices include 6.25, 12.5, 25.0, 75.0 and 200 kHz. The required frequency spacing between channels is 4x the bandwidth from center to center. For example, if there are 2 channels each at 12.5KHz, then the required frequency spacing between these 2 channels will be 50KHz (measuring from center to center). If channel bandwidths are different between the 2 channels, then the required frequency spacing will be 4x the larger bandwidth.
- **Downlink Gain:** Minor gain adjustments can be performed on a per channel basis to equalize signal levels
- **Downlink Freq - Start:** Displays the start frequency of the pass-band once the band selection has been set
- **Downlink Freq - End:** Displays the end frequency of the pass-band once the band selection has been set

7.4.3 SNMP



The image shows a form titled "SNMP" with two input fields: "Site ID" and "Description". Below the fields is an "Apply" button.

Figure 7-15 Install Tab – SNMP

The SNMP section allows you to specify the Site ID and Description. The Site-ID is the code that is used to identify the repeater.

7.4.4 Location

This section allows the user to input the latitude and the longitude of the repeater.

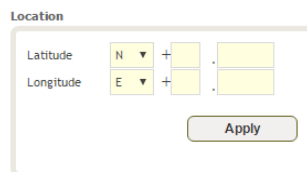

The image shows a form titled "Location" with two rows of input fields. The first row is for "Latitude" with a dropdown menu set to "N", a plus sign, and a text input field. The second row is for "Longitude" with a dropdown menu set to "E", a plus sign, and a text input field. Below the fields is an "Apply" button.

Figure 7-16 Install Tab – Location

7.4.5 Modem Box Setting

This section allows the user to specify alternative Repeater IP, Subnet Mask, and Gateway settings. These settings are enabled when the Host/Remote switch is set to the Remote position.

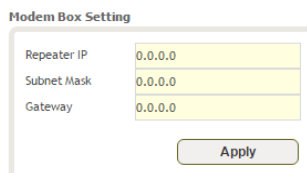

The image shows a form titled "Modem Box Setting" with three input fields: "Repeater IP", "Subnet Mask", and "Gateway". Each field contains the default value "0.0.0.0". Below the fields is an "Apply" button.

Figure 7-17 Install Tab – Modem Box Setting

7.4.6 AAI Input

The PSR-78-9533-UA can accept a dry contact input alarms. The alarm can be labeled in this section. Once the alarm is labeled, it will show up in the system with the new custom names on the Status tab. This feature is only available if the Emergency Power Off switch function is not being utilized.

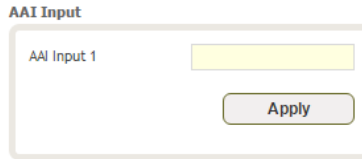

Figure 7-18 Install Tab – AAI Input

7.4.7 Location Info / Installer Info

This section allows the user to specify the address of the repeater and also the information of the installer.

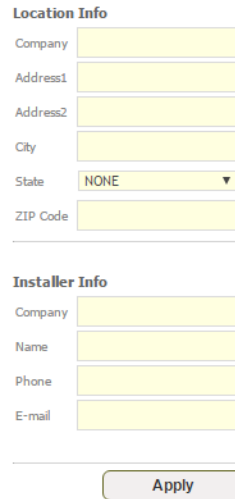

Figure7-19 Install Tab – Location Info / Installer Info

7.4.8 Date & Time

This section allows the user to specify the current date and time.

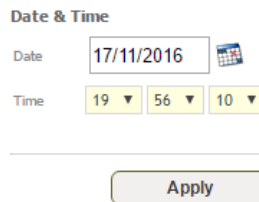

Figure 7-20 Install Tab – Date & Time

7.5 System

The System tab allows the user to perform firmware updates, upload closeout packages, view any changes to the system, backup existing configuration, add/remove user accounts, and change the login credentials of the Administrator.

7.5.1 System: Account

7.5.1.1 System: Account – Account Management

The Account Management section allows the Administrator to delete any user accounts. Please note that the Account Management section is only available if you are logged into the system as the Administrator. To delete a user account, click on the Account Management link and under the Edit column, click on the delete button.

Account Management / [New account](#) / [Change Password](#)

No	User Name	Password	Status	Last Login	Edit
1	admin	admin	administrator	2007-01-01 00:03:42	-
2	adrf	adrf	user	1970-01-01 00:00:00	delete
3	guest	guest	guest	1970-01-01 00:00:00	delete

Figure 7-21 System: Account – Account Management

7.5.1.2 System: Account – New Account

The New account section allows the Administrator to create a new user account. Please note that the New account section is only available if you are logged into the system as the Administrator. To create a new user account, click on the new account link, fill in the fields, and click Create.

[Account Management](#) / [New account](#) / [Change Password](#)

- ① User Name
- ① User Group user ▼
- ① Password
- ① Confirm password

Figure7-22 System: Account – New Account

7.5.1.3 System: Account – Change Password

The Change Password section allows the current user who is logged into the system to change their login credentials.

[Account Management](#) / [New account](#) / [Change Password](#)

- ① User Name admin
- ① New User Name
- ① Confirm New User Name
- ① Password
- ① Confirm password

Please enter new password.

Figure 7-23 System: Account – Change Password

7.5.2 System – SNMP

This section displays The SNMP section allows the user to define the parameters for SNMP v1, v2c, and v3. Community strings for v1/v2c can be specified from here and SNMP user account can be created/deleted from this section.

SNMP V1 / V2
ADD SNMP

Version	Permission	Community	Command
v2c	read/write		add

Active SNMP

Version	Permission	Community	Command
v1	read/write	public	delete
v2c	read/write	public	delete

SNMP V3
ADD SNMP

User ID	Permission	Auth Algorithm / Password	Privacy Algorithm	Command
	read/write	MD5	None	add

Active SNMP

User ID	Permission	Auth Algorithm / Password	Privacy Algorithm	Command

SNMP Monitoring

SNMP V1 / V2

Enabled	Version	Permission	Community	Command
<input type="checkbox"/>	v1	read only		set

SNMP V3

Enabled	User ID	Permission	Auth Algorithm / Password	Privacy Algorithm	Command
<input type="checkbox"/>		read only	MD5	None	set

Figure 7-24 SNMP

7.5.3 System – Logs

This section displays system events that have taken place. The Log displays the time and date of when the event took place, and what changes were made to the system.

Seq	Date	Event	Description
80	2016-11-15 07:14:15	Broad Band Freq set	Broad Band Freq changed 0.0, Bandwidth Set to 0.0
79	2016-11-15 07:14:15	700 Narrow Band Freq Set	700 Narrow Band Freq changed 0.0, Bandwidth Set to 0.0
78	2016-11-15 07:14:15	700 Narrow Band Freq Set	700 Narrow Band Freq changed 0.0, Bandwidth Set to 0.0
77	2016-11-15 07:14:15	700 Narrow Band Freq Set	700 Narrow Band Freq changed 0.0, Bandwidth Set to 0.0
76	2016-11-15 07:14:15	700 Narrow Band Freq Set	700 Narrow Band Freq changed 0.0, Bandwidth Set to 0.0
75	2016-11-15 07:14:15	700 Narrow Band Freq Set	700 Narrow Band Freq changed 0.0, Bandwidth Set to 0.0
74	2016-11-15 07:14:15	700 Narrow Band Freq Set	700 Narrow Band Freq changed 0.0, Bandwidth Set to 0.0
73	2016-11-15 07:14:15	700 Narrow Band Freq Set	700 Narrow Band Freq changed 0.0, Bandwidth Set to 0.0
72	2016-11-15 07:14:15	700 Narrow Band Freq Set	700 Narrow Band Freq changed 0.0, Bandwidth Set to 0.0
71	2016-11-15 07:14:15	700 Narrow Band Freq Set	700 Narrow Band Freq changed 0.0, Bandwidth Set to 0.0
70	2016-11-15 07:14:15	700 Narrow Band Freq Set	700 Narrow Band Freq changed 0.0, Bandwidth Set to 0.0
69	2016-11-15 07:14:15	700 Narrow Band Freq Set	700 Narrow Band Freq changed 0.0, Bandwidth Set to 0.0
68	2016-11-15 07:14:15	700 Narrow Band Freq Set	700 Narrow Band Freq changed 0.0, Bandwidth Set to 0.0
67	2016-11-15 07:14:15	700 Narrow Band Freq Set	700 Narrow Band Freq changed 0.0, Bandwidth Set to 0.0
66	2016-11-15 07:14:15	700 Narrow Band Freq Set	700 Narrow Band Freq changed 0.0, Bandwidth Set to 0.0
65	2016-11-15 07:14:15	700 Narrow Band Freq Set	700 Narrow Band Freq changed 0.0, Bandwidth Set to 0.0
64	2016-11-15 07:14:15	700 Narrow Band Freq Set	700 Narrow Band Freq changed 0.0, Bandwidth Set to 0.0
63	2016-11-15 07:14:15	700 Narrow Band Freq Set	700 Narrow Band Freq changed 0.0, Bandwidth Set to 0.0
62	2016-11-15 07:14:15	700 Narrow Band Freq Set	700 Narrow Band Freq changed 0.0, Bandwidth Set to 0.0
61	2016-11-15 07:14:15	700 Narrow Band Freq Set	700 Narrow Band Freq changed 0.0, Bandwidth Set to 0.0

1 2 3 4 5 6 7 8 9 10 11 12 13 14 15 16 17 18 19 20
 21 22 23 24 25 26 27 28 29 30 31 32 33 34 35 36 37 38 39 40
 41 42 43 44 45 46 47 48 49 50 51 52 53 54 55 56 57 58 59 60
 61 62 63 64 65 66 67 68 69 70 71 72 73 74 75 76 77 78 79 80
 81 82 83 84 85 86 87 88 89 90 91 92 93 94 95 96 97 98 99 100

Figure 7-25 System: Logs

7.5.4 System – Update

- To perform a firmware update, click on the Update tab and the following screen will appear.

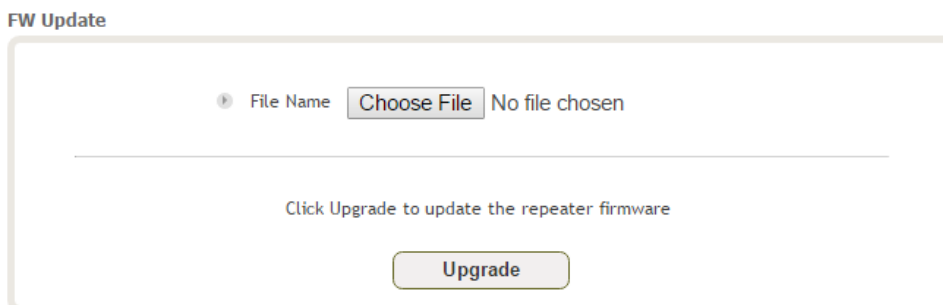

Figure 7-26 System: Update

- Click on the Choose File button and locate the firmware file.
- Click on the Upgrade button to perform the firmware update.
- Once the firmware update is complete, the following popup message will appear:

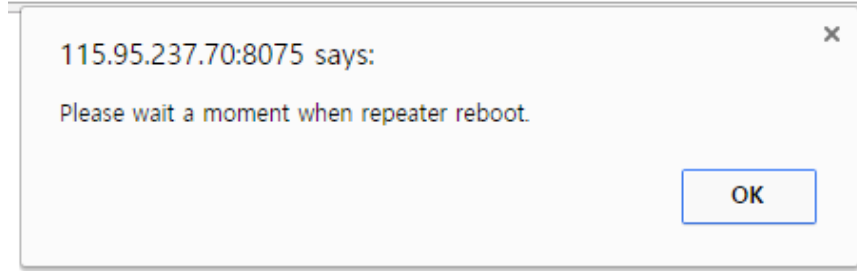

Figure 7-27 System: Update is Complete Popup Message

7.5.5 System – Backup / Restore

The Backup / Restore section allows the user to save the settings of the repeater. To perform the backup, click on the Backup button and you will be prompted to save the backup file. To restore the settings to the system, click on Choose File button, select the backup file, and click the Restore button.

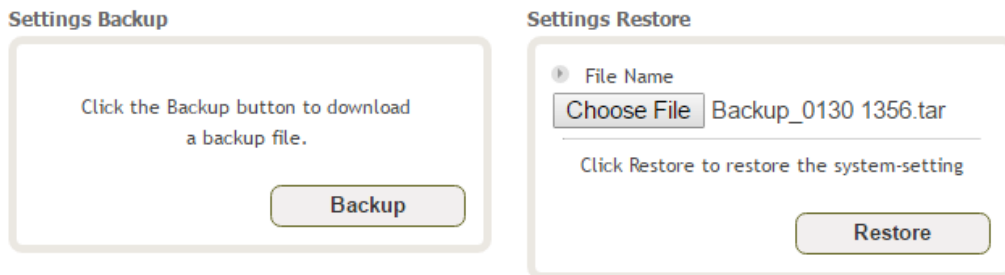

Figure 7-28 System: Backup / Restore

7.6 Help

If an internet connection is available, clicking on the Help Tab will redirect the user to our Technical Support page.

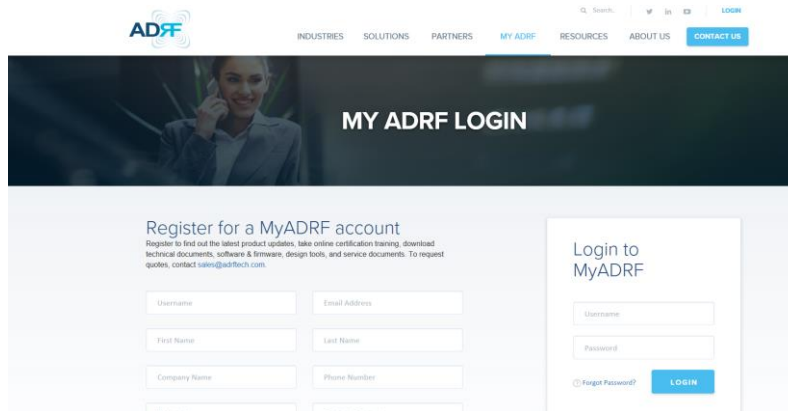

Figure 7-29 Help

7.7 Logout

Clicking the Logout button will log the current user off the system.

8. MAINTENANCE GUIDE FOR PSR-78-9533-U/9537-U REPEATER

8.1 Periodic Inspection Checklist

1. Repeater

- a. Log into the ADRF unit and check for any alarms in the system
- b. Address any outstanding alarms
- c. Check for loose connections to the repeaters/remotes and antennas. If connections are loose, make sure that all connections are tightly fastened.
- d. Check that cables and connectors are in good condition.
- e. Ensure that the repeater/remote brackets are in good condition and that the repeater/remote is securely fastened.
- f. Verify that the repeater has 3" of clearance on all sides to ensure proper ventilation.

2. Battery Backup

- a. Open the ADRF-BBL-U/BBS-U enclosure and inspect the battery terminals for any corrosion buildup
- b. Turn the circuit breaker to the off position and unscrew the fuse holder to inspect the fuse
 - i. A spare fuse is included with the purchase of the ADRF-BBL-U and can be used to replace the fuse if needed

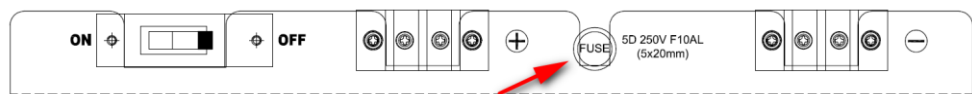

c. If the terminals need to be cleaned:

- i. Set the ADRF-BBL-U/BBS-U breaker switch to the OFF position
- ii. Disconnect the battery backup cable from the repeater
- iii. Carefully disconnect battery terminals and clean the terminal with a battery terminal cleaner
- iv. Wait for terminals to fully dry
- v. Reconnect the battery terminals and set the breaker switch to the ON position

- d. The lifespan of the batteries will vary based on the number of outages, however we approximate that with an average of 4 outages a year, the batteries should last approximately 2-3 years

8.2 Preventive Measures for Optimal Operation

8.2.1 Recommendations

- Perform the *Periodic Inspection Checklist* on a semi-annually basis.

8.2.2 Precautions

- Do not operate the repeater with the antennas in extremely close proximity to one another as this may cause damage to the repeater.
- Do not change the parameters unless instructed to do so by an authorized supervisor.
- Do not move the repeater unless instructed to do so by an authorized supervisor.
- Do not detach any cables to the repeater unless repair of respective components is necessary.

9. WARRANTY AND REPAIR POLICY

9.1 General Warranty

The PSR-78-9533-UA carries a Standard Warranty period of two (2) years unless indicated otherwise on the package or in the acknowledgment of the purchase order.

9.2 Limitations of Warranty

Your exclusive remedy for any defective product is limited to the repair or replacement of the defective product. Advanced RF Technologies, Inc. may elect which remedy or combination of remedies to provide in its sole discretion. Advanced RF Technologies, Inc. shall have a reasonable time after determining that a defective product exists to repair or replace the problem unit. Advanced RF Technologies, Inc. warranty applies to repaired or replaced products for the balance of the applicable period of the original warranty or ninety days from the date of shipment of a repaired or replaced product, whichever is longer.

9.3 Limitation of Damages

The liability for any defective product shall in no event exceed the purchase price for the defective product.

9.4 No Consequential Damages

Advanced RF Technologies, Inc. has no liability for general, consequential, incidental or special damages.

9.5 Additional Limitation on Warranty

Advanced RF Technologies, Inc. standard warranty does not cover products which have been received improperly packaged, altered, or physically damaged. For example, broken warranty seal, labels exhibiting tampering, physically abused enclosure, broken pins on connectors, any modifications made without Advanced RF Technologies, Inc. authorization, will void all warranty.

9.6 Return Material Authorization (RMA)

No product may be returned directly to Advanced RF Technologies, Inc. without first getting approval from Advanced RF Technologies, Inc. If it is determined that the product may be defective, you will be given an RMA number and instructions on how to return the product. An unauthorized return, i.e., one for which an RMA number has not been issued will be returned to you at your expense. Authorized returns are to be shipped to the address on the RMA in an approved shipping container. You will be given our courier information. It is suggested that the original box and packaging materials should be kept if an occasion arises where a defective product needs to be shipped back to Advanced RF Technologies, Inc. To request an RMA, please call (800) 313-9345 or send an email to techsupport@adrfttech.com.

10. SPECIFICATIONS

10.1 Electrical Specifications

Table 10-1 Electrical Specifications (PSR Series)

Parameters		Specifications		Remark
		DL	UL	
Frequency Range (MHz)	FirstNet + PS 700	769 - 775MHz(For FCC) (768-769MHzGuard band) 768 – 775 MHz (For ISSED)	799 - 805 MHz(For FCC) (798- 799MHz Guard band) 798 - 805 MHz (For ISSED)	APCO 25
	PS 800	851 - 861	806 - 816	APCO 25
Composite Output Power (PSR-78-9533-UA)	FirstNet / PS 700 / FirstNet + PS 700	33 dBm	30 dBm	
	PS 800	33 dBm	30 dBm	
	FirstNet + PS 700 + PS 800	36 dBm (33dBm + 33dBm)	30 dBm	
System Gain (dB)		95	95	
Filter selection		Broad / Narrow / Broad + Narrow band		
Simultaneous Filter Support numbers	Broad Band	2 (non-contiguous) @ FirstNet / PS 700 / PS 800 / FirstNet + PS 700 / FirstNet + PS 700 + PS 800		2 (non-contiguous) @ FirstNet
	Narrow Band	Up to 16 (Non-contiguous) @ PS 700 / PS 800 Up to 32 (Non-contiguous) @ PS 700 + PS 800		
Filter Bandwidth	Broad (MHz)	5, 10MHz		
	Narrow (KHz)	6.25 ~75 (6.25 x n , n= 1~12)		
Filter Roll-off	Broad (MHz)	60dBc@Filter Bandwidth Edge + 1MHz		
	Narrow (KHz)	55dBc @Filter Bandwidth Edge + 3 * Filter BW		
Spurious		FCC Rule Compliant		
Passband Ripple		±2 dB		
ALC Dynamic Range		≥ 60dB		
Gain Dynamic Range		45dB		
Channel Setting Resolution		0.025 KHz		
Noise Figure @ Max. gain		≤5dB		
System Group Delay	Broad Band	<6us		
	Narrow Band	<126us@6.25KHz BW, <67us@12.5KHz BW, <36us@25KHz BW, <10us@200KHz BW		
Power Supply		100 -240 VAC, 60 Hz (Free Voltage)		Optional battery backup
Power Consumption (PSR-78-9533-UA / 9537)		< 150 W / < 222 W		
Max RF Input Power without overdrive		-20dBm		
No damage Max Input Power		+10 dBm		
Impedance		50 Ω		
VSWR		< 1.5 : 1		
Dry Contacts		NFPA 1221 2016 Code Compliant		
Remote Alarming / Network Management		Dry Contacts, Web-GUI, SNMP, (External Wireless Modem Required)		
Humidity		5% - 95% RH Condensed		

Operating at Ambient Temperature	-40°F to +140°F (-40°C to +60°C)	
----------------------------------	----------------------------------	--

10.2 Mechanical Specifications

Table 10-2 Mechanical Specifications

PSR-78-9533-UB	Specifications	Comments
Dimensions W x D x H	11.0 x 9.0 x 21.3 in (w/o mounting bracket)	
Weight	55 lbs (w/o mounting bracket)	
RF Connector	4.3-10 (Female)	
Weather Resistances	IP66	

10.3 Power Specifications

Table 10-3 Power Specifications

Parameters	Specifications	Comments
Repeater Rating	<ul style="list-style-type: none"> PSR-78-9533-UA: 100 – 240 VAC, 50/60 Hz, 1.93-0.84A or 27VDC, 4.85A (Battery Port Only) 	
Annunciator Rating	28VDC Nominal, 108.3mA	
AC Supply Protection	Fuse & Circuit Protector	T6.3L250V
Ground	External Threaded Stud	
Battery Type	Valve Regulated, Sealed Lead Acid Rechargeable Battery	
Battery Model	ADRF-BBL-U-24: Tempest TR120-12 ADRF-BBS-U-24: Tempest TR45-12	
Battery Capacity	TR120-12: 120Ah TR45-12: 48Ah	
Maximum Current Charge	3A	
Dry Contact Relay Rating (resistive)	<ul style="list-style-type: none"> Max switching voltage: 30V DC Max switching current: 5A Min switching capacity: 10mA, 5V DC 	

10.4 ADRF-BBS-U-24 / ADRF-BBL-U-24 Runtime Calculations

PSR-78-9533-U w/ ADRF-BBL/BBS-U-24 Battery Runtime Calculations

PSR-78-9533-UA (Dual Band) w/
(1) ADRF-BBL-U-24

Repeater

- DC Power Consumption (W) – 127.16
- DC Voltage (V) – 24.02
- DC Current Draw (A) – 5.294

(1) Battery Backup

- Battery Capacity (Ah) – 120

Calculations

- Runtime (h) = Battery Capacity (Ah) / Current Draw (A)
- Runtime (h) = 120Ah / 5.294A
- Runtime (h) = 22.67h

PSR-78-9533-UB (Dual Band) w/
(2) ADRF-BBS-U-24 + ADRF-BBX-U-CBL-21P

Repeater

- DC Power Consumption (W) – 127.16
- DC Voltage (V) – 24.02
- DC Current Draw (A) – 5.294

(2) Battery Backup w/ Parallel Cable

- Battery Capacity (Ah) – 96

Calculations

- Runtime (h) = Battery Capacity (Ah) / Current Draw (A)
- Runtime (h) = 96Ah / 5.294A
- Runtime (h) = 18.13h

10.5 Warranty & Certificates

Table 10-4 Warranty & Certificates

Parameters	Specifications	Comments
MTBF	> 100,000 Hours	Ambient
Compliance	UL60950	
Warranty	2 Years	

11. ANICAL DRAWING

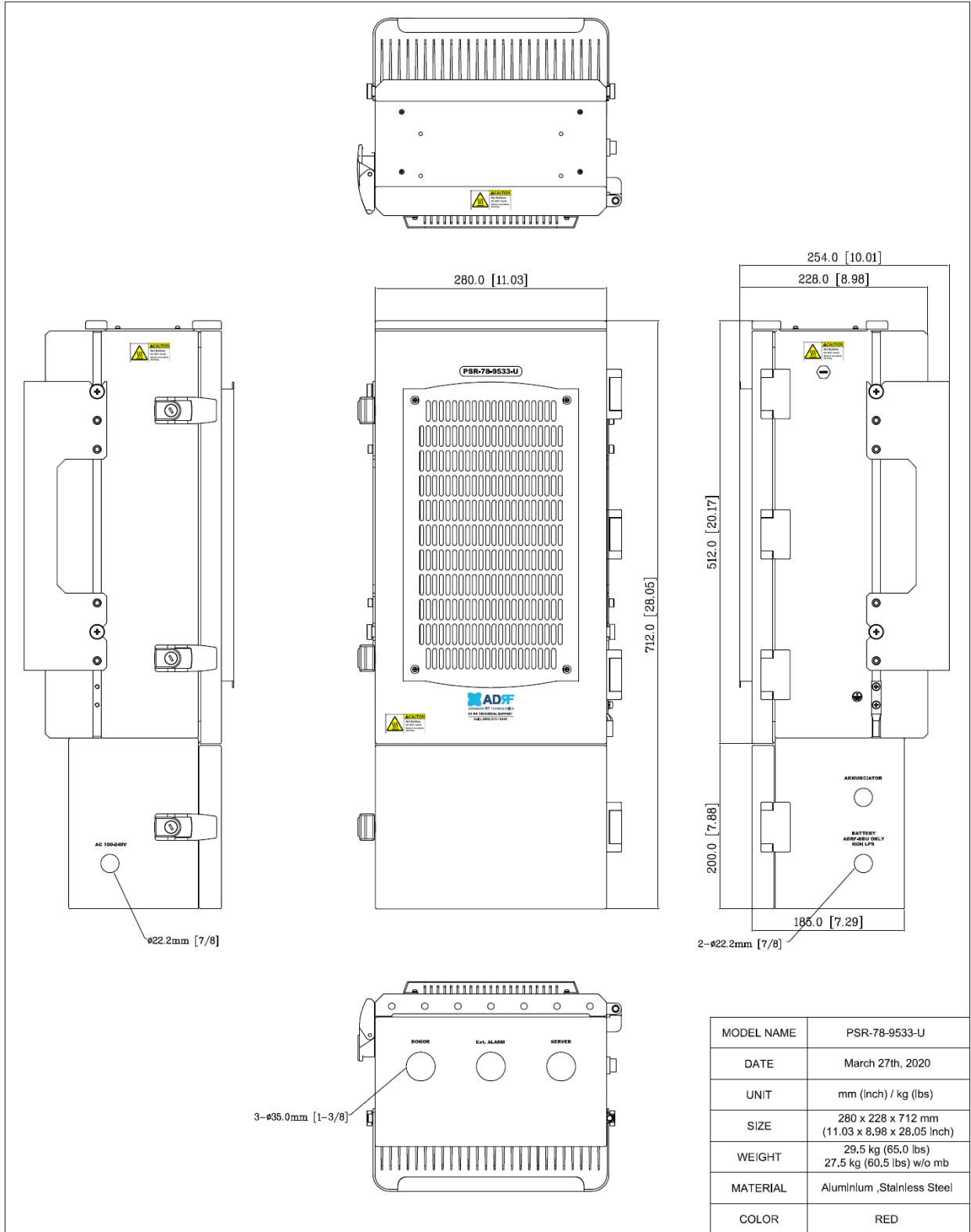

Figure 11-1 PSR-78-9533-U Mechanical Drawing

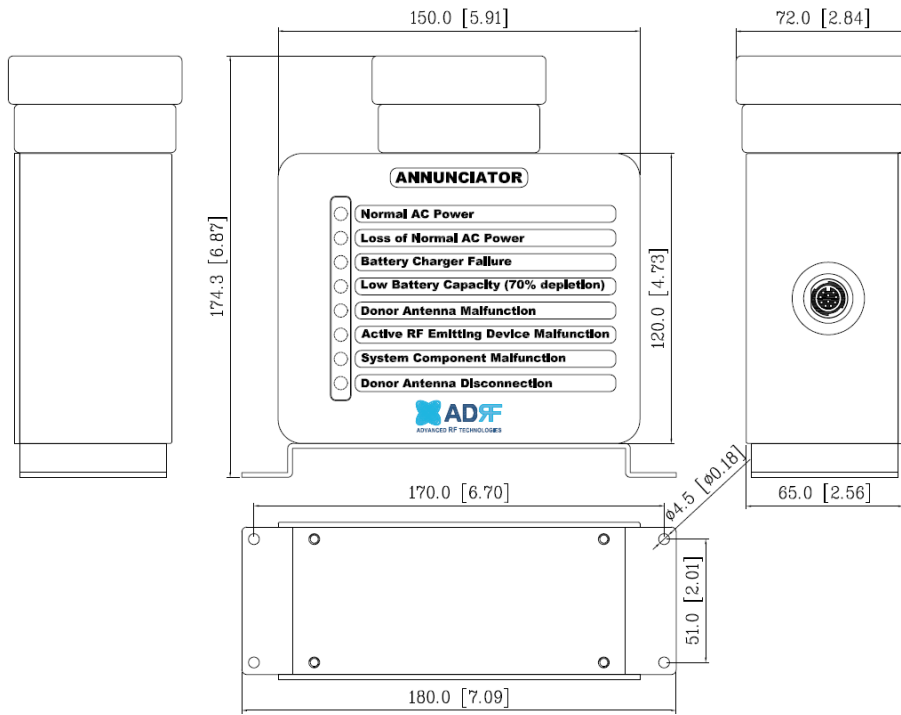

Figure 11-2 PSR-ANN Annunciator Mechanical Drawing

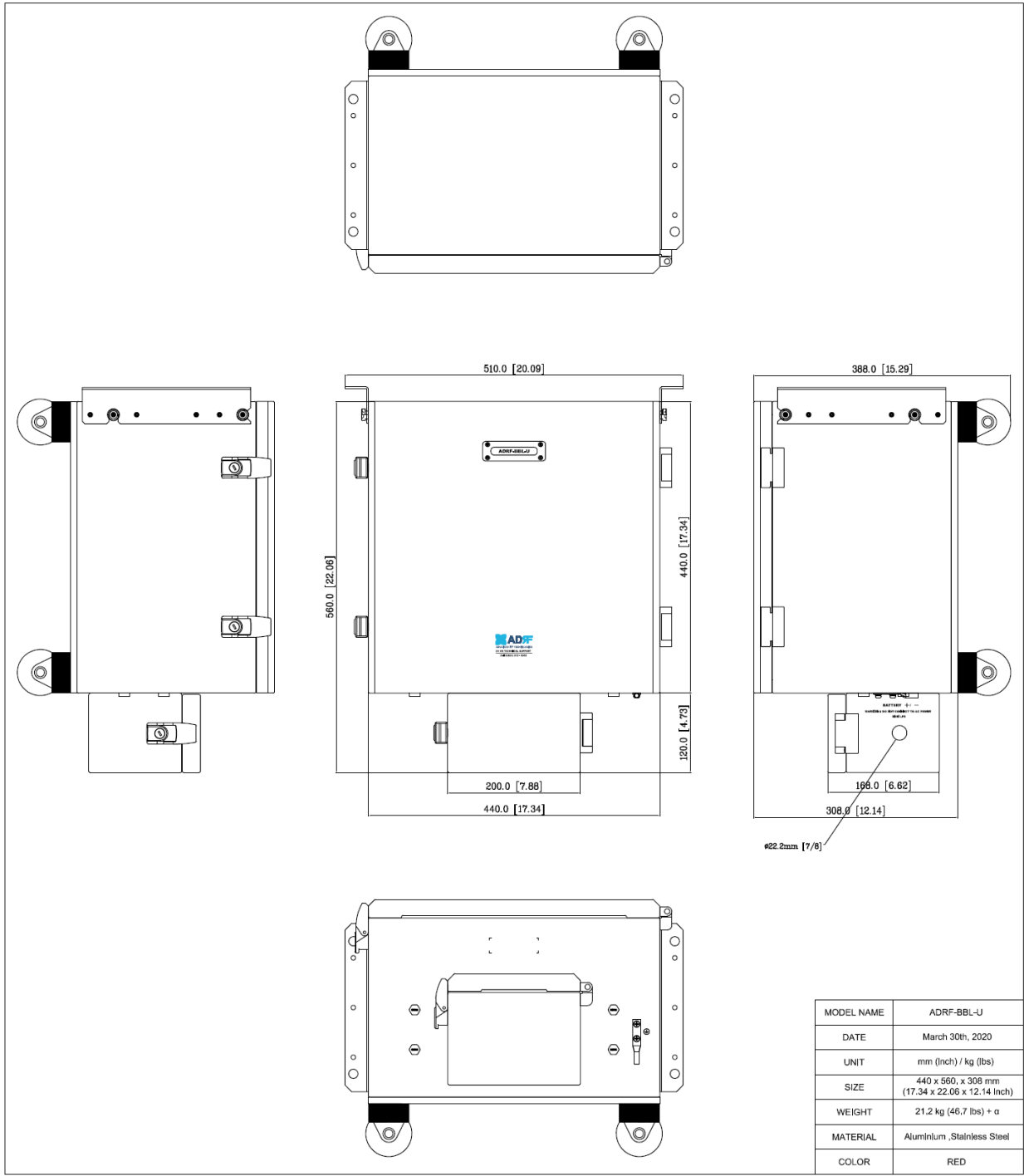

Figure 11-3 ADRF-BBL-U Mechanical Drawing

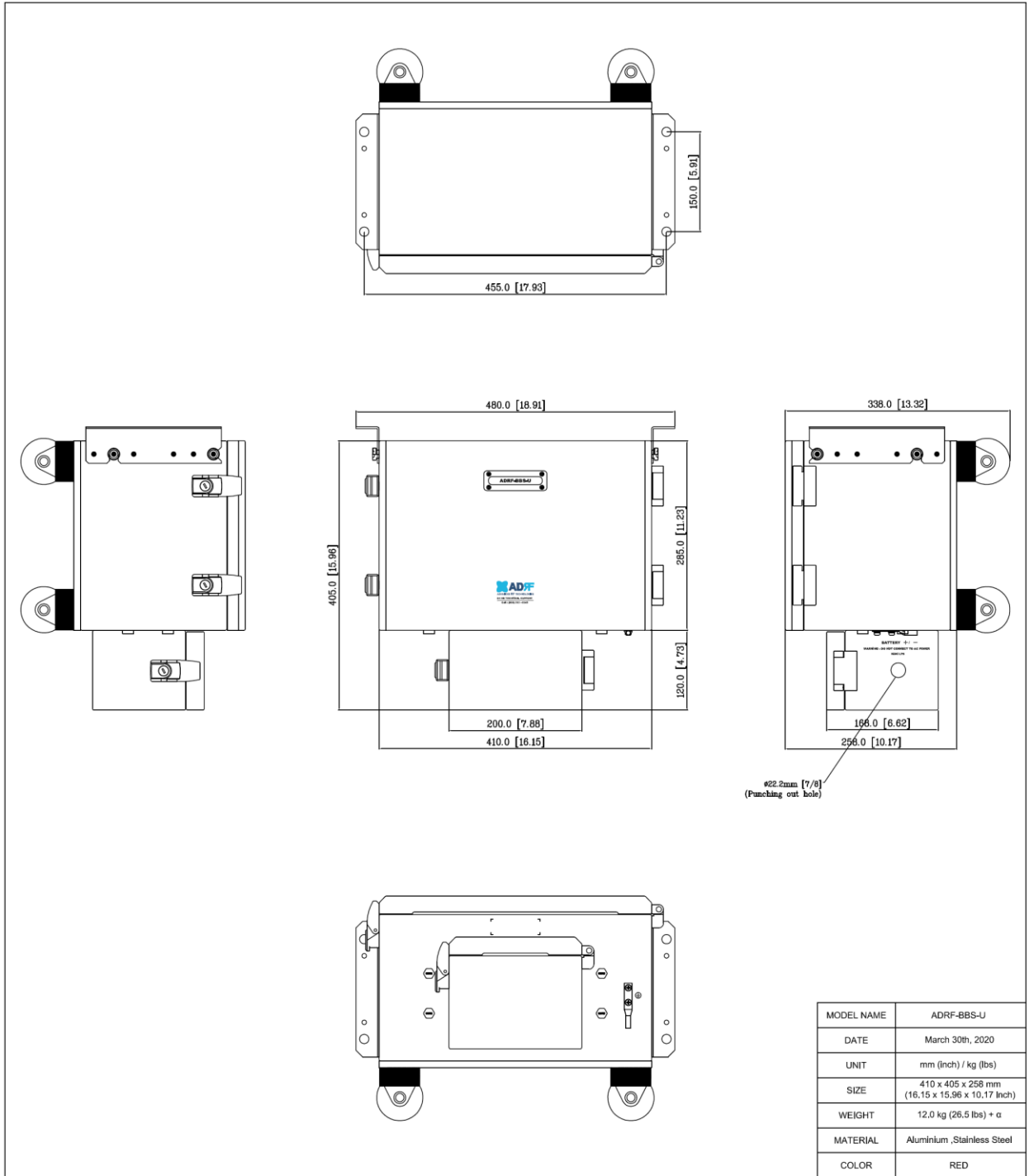

Figure 11-4 ADRF-BBS-U Mechanical Drawing

12. APPENDIX

12.1 Shutdown Retry Logic

The function of the built-in shutdown routine is to protect the repeater from any further damage from a hard-fail that the system may be experiencing.

Within 5 seconds of a hard-fail alarm being detected, the repeater will start the shutdown routine. The repeater will shut down by powering off the HPAs (high-powered amplifiers) for 30 seconds.

After 30 seconds have elapsed, the repeater will power on the HPAs and check to see if the hard-fail alarm still exists. If the hard-fail alarm still exists, then the repeater will shut down for 1 minute (double the time of the previous shutdown time).

After 1 minute has elapsed, the repeater will power on the HPAs and check to see if the hard-fail alarm still exists. If the hard-fail alarm still exists, then the repeater will shut down for 2 minutes (double the time of the previous shutdown time).

The shutdown routine will repeat itself a total of 10 times. If the hard-fail alarm still exists after the 10th retry, then the repeater will turn off its HPAs permanently until a reset is performed or factory set is executed.