

TEST REPORT

FCC Test for ADXV-R-37N77L
Certification

APPLICANT
ADRF KOREA, Inc.

REPORT NO.
HCT-RF-2303-FC003

DATE OF ISSUE
March 17, 2023

Tested by
Sang Su Lee

Technical Manager
Jong Seok Lee

HCT CO., LTD.
Bongjai Huh
BongJai Huh / CEO



HCT Co., Ltd.

74, Seoicheon-ro 578beon-gil, Majang-myeon, Icheon-si, Gyeonggi-do, 17383 KOREA
Tel. +82 31 634 6300 Fax. +82 31 645 6401

TEST REPORT

FCC Test for
ADXV-R-37N77L

REPORT NO.
HCT-RF-2303-FC003

DATE OF ISSUE
March 17, 2023

Additional Model
-

Applicant **ADRF KOREA, Inc.**
5-5, Mojeon-Ri, Backsa-Myun, Icheon-Citi, Kyunggi-Do, Korea

Eut Type DAS
Model Name ADXV-R-37N77L

FCC ID N52-ADXV-R-37N77L

Output Power Downlink: 37 dBm

Date of Test January 30, 2023 ~ March 16, 2023

FCC Rule Parts: CFR 47 Part 2, Part 27

The result shown in this test report refer only to the sample(s) tested unless otherwise stated.
This test results were applied only to the test methods required by the standard.

REVISION HISTORY

The revision history for this test report is shown in table.

Revision No.	Date of Issue	Description
0	March 17, 2023	Initial Release

The measurements shown in this report were made in accordance with the procedures indicated, and the emissions from this equipment were found to be within the limits applicable. I assume full responsibility for the accuracy and completeness of these measurements, and for the qualifications of all persons taking them. It is further stated that upon the basis of the measurements made, the equipment tested is capable of operation in accordance with the requirements of the FCC Rules under normal use and maintenance.

If this report is required to confirmation of authenticity, please contact to www.hct.co.kr

CONTENTS

1. GENERAL INFORMATION	5
1.1. APPLICANT INFORMATION	5
1.2. PRODUCT INFORMATION	5
1.3. TEST INFORMATION	5
2. FACILITIES AND ACCREDITATIONS	6
2.1. FACILITIES	6
2.2. EQUIPMENT	6
3. TEST SPECIFICATIONS	7
3.1. STANDARDS	7
3.2. ADDITIONAL DESCRIPTIONS ABOUT TEST	8
3.3. MEASUREMENT UNCERTAINTY	10
3.4. STANDARDS ENVIRONMENTAL TEST CONDITIONS	10
3.5. TEST DIAGRAMS	11
4. TEST EQUIPMENTS	13
5. TEST RESULT	14
5.1. AGC THRESHOLD	14
5.2. OUT-OF-BAND REJECTION	16
5.3. INPUT-VERSUS-OUTPUT SIGNAL COMPARISON	18
5.4. INPUT/OUTPUT POWER AND AMPLIFIER/BOOSTER GAIN	32
5.5. OUT-OF-BAND/OUT-OF-BLOCK EMISSIONS AND SPURIOUS EMISSIONS	45
5.6. RADIATED SPURIOUS EMISSIONS	101
5.7. FREQUENCY STABILITY	105
6. Annex A_EUT AND TEST SETUP PHOTO	110

1. GENERAL INFORMATION

1.1. APPLICANT INFORMATION

Company Name	ADRF KOREA, Inc.
Company Address	5-5, Mojeon-Ri, Backsa-Myun, Icheon-Citi, Kyunggi-Do, Korea

1.2. PRODUCT INFORMATION

EUT Type	DAS	
EUT Serial Number	ADXVR37N77L220000	
Power Supply	100-240 VAC, 50/60 Hz / 36~76 VDC	
Frequency Range	Band Name	Downlink (MHz)
	3.45 GHz Service	3 450 ~ 3 550
Tx Output Power	37 dBm	
Antenna Peak Gain	Maximum Directional Peak Gain: 21.3 dBi	

1.3. TEST INFORMATION

FCC Rule Parts	CFR 47 Part 2, Part 27
Measurement Standards	KDB 935210 D05 v01r04, KDB 971168 D01 v03r01, ANSI C63.26-2015
Test Location	HCT CO., LTD. 74, Seoicheon-ro 578beon-gil, Majang-myeon, Icheon-si, Gyeonggi-do, 17383, Rep. of KOREA

2. FACILITIES AND ACCREDITATIONS

2.1. FACILITIES

The SAC(Semi-Anechoic Chamber) and conducted measurement facility used to collect the radiated data are located at the 74, Seoicheon-ro 578beon-gil, Majang-myeon, Icheon-si, Gyeonggi-do, 17383, Rep. of KOREA.

The site is constructed in conformance with the requirements of ANSI C63.4 (Version: 2014) and CISPR Publication 22.

Detailed description of test facility was submitted to the Commission and accepted dated April 02, 2018 (Registration Number: KR0032).

2.2. EQUIPMENT

Radiated emissions are measured with one or more of the following types of linearly polarized antennas: tuned dipole, bi-conical, log periodic, bi-log, and/or ridged waveguide, horn. Spectrum analyzers with pre-selectors and quasi-peak detectors are used to perform radiated measurements.

Calibrated wideband preamplifiers, coaxial cables, and coaxial attenuators are also used for making measurements.

All receiving equipment conforms to CISPR Publication 16-1, "Radio Interference Measuring Apparatus and Measurement Methods."

3. TEST SPECIFICATIONS

3.1. STANDARDS

The following tests were conducted on a sample of the equipment for the purpose of demonstrating compliance with FCC Part 2, Part 27

Description	Reference	Results
AGC threshold	KDB 935210 D05 v01r04 3.2	Compliant
Out-of-band rejection	KDB 935210 D05 v01r04 3.3	Compliant
Input-versus-output signal comparison	§ 2.1049	Compliant
Input/output power and amplifier/booster gain	§ 2.1046, § 27.50(k)(2), § 27.50(k)(4)	Compliant
Out-of-band/out-of-block emissions and spurious emissions	§ 2.1051, § 27.53(n)(1)	Compliant
Spurious emissions radiated	§ 2.1053, § 27.53(n)(1)	Compliant
Frequency Stability	§ 2.1055 § 27.54	Compliant

3.2. ADDITIONAL DESCRIPTIONS ABOUT TEST

Except for the following cases, EUT was tested under normal operating conditions.

: Out-of-band rejection test requires maximum gain condition without AGC.

The test was generally based on the method of KDB 935210 D05 v01r04 and only followed ANSI C63.26-2015 if there was no test method in KDB standard.

EUT was tested with following modulated signals provide by applicant.

Band Name	Tested signals
3.45 GHz Service	5G NR 20 MHz
	5G NR 40 MHz
	5G NR 60 MHz
	5G NR 80 MHz
	5G NR 100 MHz

All power supplies of operation were investigated and the worst case configuration results are reported.

- Mode: 100~240 VAC, 50/60 Hz / 36~76 VDC

- Worst case: 100~240 VAC, 50/60 Hz

The tests results included actual loss value for attenuator and cable combination as shown in the table below.

: Input Path

Correction factor table			
Frequency (MHz)	Factor (dB)	Frequency (MHz)	Factor (dB)
3 300	1.945	3 550	1.971
3 350	1.687	3 600	2.220
3 400	2.072	3 650	2.211
3 450	1.741	3 700	2.106
3 500	1.870		

: Output Path

Correction factor table

Frequency (MHz)	Factor (dB)	Frequency (MHz)	Factor (dB)
0.009	17.540	16 000	26.440
40	18.240	17 000	26.690
80	19.000	18 000	26.910
100	19.200	19 000	27.250
200	19.540	20 000	27.400
300	19.790	21 000	27.510
400	19.960	22 000	27.580
500	20.150	23 000	27.730
600	20.210	24 000	27.980
700	20.330	25 000	28.330
800	20.310	26 000	28.370
900	20.390	27 000	28.570
1 000	20.530	28 000	28.680
2 000	21.340	29 000	28.730
3 000	22.050	30 000	28.980
4 000	22.450	31 000	29.050
5 000	22.960	32 000	29.390
6 000	23.250	33 000	29.250
7 000	23.560	34 000	29.410
8 000	23.900	35 000	29.550
9 000	24.160	36 000	29.550
10 000	24.370	37 000	29.490
11 000	24.620	38 000	29.660
12 000	24.940	39 000	29.900
13 000	25.300	40 000	29.980
14 000	25.800		
15 000	26.130		

3.3. MEASUREMENT UNCERTAINTY

Description	Condition	Uncertainty
Radiated Disturbance	9 kHz ~ 30 MHz	± 4.14 dB
	30 MHz ~ 1 GHz	± 5.82 dB
	1 GHz ~ 18 GHz	± 5.74 dB
	18 GHz ~ 40 GHz	± 5.76 dB

* Coverage factor $k=2$, Confidence levels of 95 %

3.4. STANDARDS ENVIRONMENTAL TEST CONDITIONS

Temperature	+15 °C to +35 °C
Relative humidity	30 % to 60 %
Air pressure	860 mbar to 1 060 mbar

3.5. TEST DIAGRAMS

Conducted Test

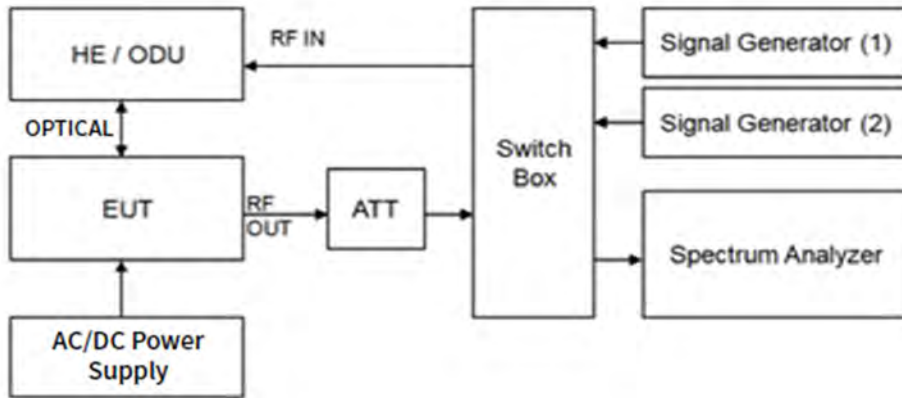

Radiated Test

30 MHz ~ 1 GHz

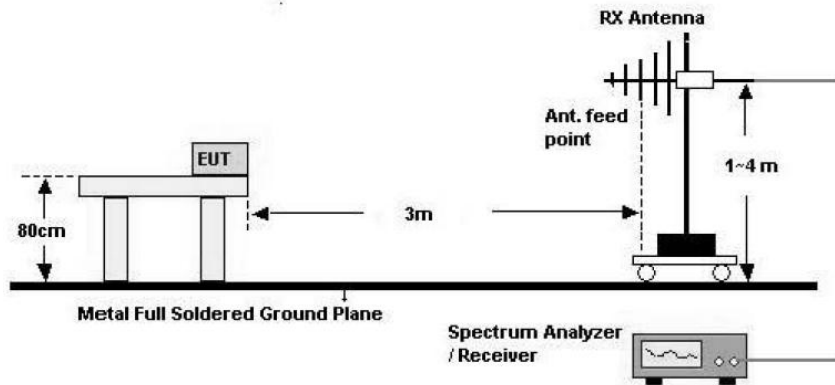

Above 1 GHz

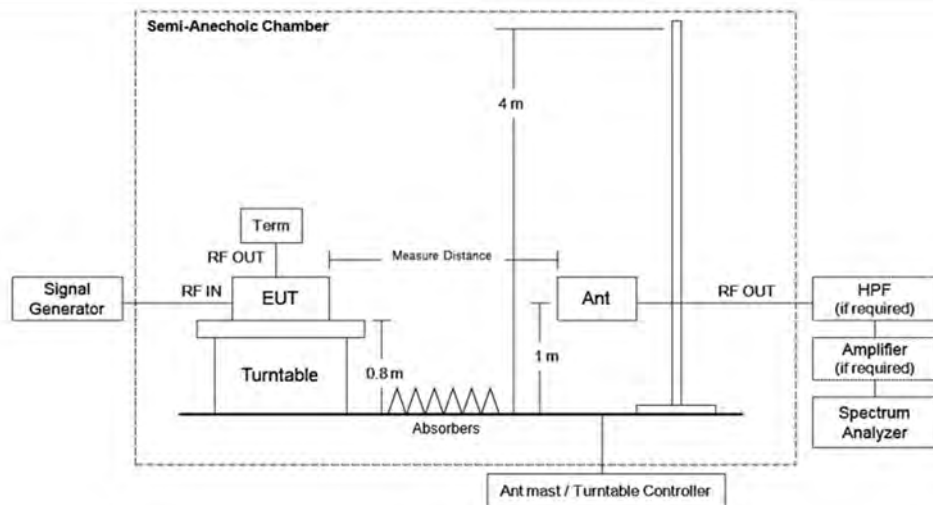

*Note: Measure distance is 3 m.

Frequency Stability

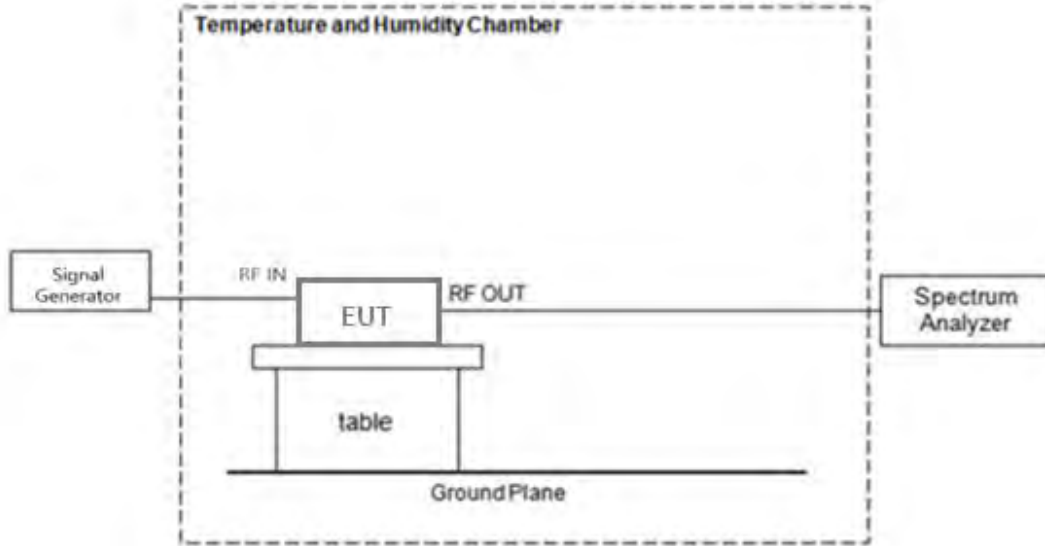

4. TEST EQUIPMENTS

Equipment	Model	Manufacturer	Serial No.	Due to Calibration	Calibration Interval
MXA Signal Analyzer	N9020A	Keysight	MY46471250	07/22/2023	Annual
PXA Signal Analyzer	N9030A	Keysight	MY49431434	01/02/2024	Annual
MXG Vector Signal Generator	N5182A	Agilent	MY46240807	12/23/2023	Annual
MXG Vector Signal Generator	N5182A	Agilent	MY50141649	08/16/2023	Annual
20 dB Attenuator	FAS-23-20	MCLI	103756	01/03/2024	Annual
30 dB Attenuator	TWAN-300-18G	Teleworld	N/A	08/22/2023	Annual
50Ω Termination	908A	H.P.	N/A	N/A	N/A
DC Power Supply	PWR800L	KIKUSUI	LJ003448	05/30/2023	Annual
AC Power Supply	PCR2000MA	KIKUSUI	ZL002530	12/28/2023	Annual
Temperature & Humidity Chamber	PL-4KP	ESPEC	14021890	10/04/2023	Annual
Switch	S46	KEITHLEY	1088024	N/A	N/A
Controller (Antenna Mast & Turn Table)	CO3000	Innco systems	CO3000/1251/48920320/P	N/A	N/A
Antenna Position Tower	MA4640/800-XP-ET	Innco systems	N/A	N/A	N/A
Turn Table	N/A	Ets	N/A	N/A	N/A
Turn Table	DS2000-S	Innco systems	N/A	N/A	N/A
Loop Antenna	FMZB 1513	Schwarzbeck	1513-333	03/17/2024	Biennial
Trilog Super Broadband Antenna	VULB 9168	Schwarzbeck	9168-0895	08/16/2024	Biennial
Horn Antenna	BBHA 9120D	Schwarzbeck	02296	05/18/2024	Biennial
Horn Antenna (15 GHz ~ 40 GHz)	BBHA9170	Schwarzbeck	BBHA9170124	04/12/2023	Biennial
Spectrum Analyzer	FSP40	Rohde & Schwarz	100843	11/08/2023	Annual
Amp & Filter Bank Switch Controller	FBSM-01B	TNM system	TM20090002	N/A	N/A
LNA(0.1~18GHz)	FBSR-04C	TNM system	N/A	08/23/2023	Annual
High Pass Filter	WHNX6.0/26.5G-6SS	Wainwright Instruments	1	01/19/2024	Annual
Power Amplifier	CBL18265035	CERNEX	22966	12/01/2023	Annual
Power Amplifier	CBL26405040	CERNEX	25956	03/02/2024	Annual

Note:

1. Equipment listed above that calibrated during the testing period was set for test after the calibration.
2. Equipment listed above that has a calibration due date during the testing period, the testing is completed before equipment expiration date.

5. TEST RESULT

5.1. AGC THRESHOLD

Test Requirement:

KDB 935210 D05 v01r04

Testing at and above the AGC threshold is required.

Test Procedures:

Measurements were in accordance with the test methods section 3.2 of KDB 935210 D05 v01r04.

In the case of fiber-optic distribution systems, the RF input port of the equipment under test (EUT) refers to the RF input of the supporting equipment RF to optical convertor; see also descriptions and diagrams for typical DAS booster systems in KDB Publication 935210 D02

Devices intended to be directly connected to an RF source (donor port) only need to be evaluated for any over-the-air transmit paths.

- a) Connect a signal generator to the input of the EUT.
- b) Connect a spectrum analyzer or power meter to the output of the EUT using appropriate attenuation as necessary.
- c) The signal generator should initially be configured to produce either of the required test signals.
- d) Set the signal generator frequency to the center frequency of the EUT operating band.
- e) While monitoring the output power of the EUT, measured using the methods of ANSI C63.26-2015 subclause 5.2.4.4.1, increase the input level until a 1 dB increase in the input signal power no longer causes a 1 dB increase in the output signal power.
- f) Record this level as the AGC threshold level.
- g) Repeat the procedure with the remaining test signal.

Output power measurement in subclause 5.2.4.4.1 of ANSI C63.26

- a) Set span to $2 \times$ to $3 \times$ the OBW.
- b) Set RBW = 1% to 5% of the OBW.
- c) Set VBW $\geq 3 \times$ RBW.
- d) Set number of measurement points in sweep $\geq 2 \times$ span / RBW.
- e) Sweep time: auto-couple
- f) Detector = power averaging (rms).
- g) If the EUT can be configured to transmit continuously, then set the trigger to free run.
- h) Omit
- i) Trace average at least 100 traces in power averaging (rms) mode if sweep is set to auto-couple. To accurately determine the average power over multiple symbols, it can be necessary to increase the number of traces to be averaged above 100 or, if using a manually configured sweep time, increase the sweep time.

- j) Compute the power by integrating the spectrum across the OBW of the signal using the instrument’s band or channel power measurement function, with the band/channel limits set equal to the OBW band edges. If the instrument does not have a band or channel power function, then sum the spectrum levels (in linear power units) at intervals equal to the RBW extending across the entire OBW of the spectrum.

Note:

All power supplies of operation were investigated and the worst case configuration results are reported.

- Mode: 100~240 VAC, 50/60 Hz / 36~76 VDC

- Worst case: 100~240 VAC, 50/60 Hz

Test Results:

Test Band	Link	Signal	Center Frequency (MHz)	AGC Threshold Level (dBm)	Output Level (dBm)
3.45 GHz Service	Downlink	5G NR 20 MHz	3 500.00	0	36.84
		5G NR 40 MHz	3 500.00	0	36.90
		5G NR 60 MHz	3 500.00	0	36.94
		5G NR 80 MHz	3 500.00	0	36.81
		5G NR 100 MHz	3 500.00	0	36.65

5.2. OUT-OF-BAND REJECTION

Test Requirement:

KDB 935210 D05 v01r04

Out-of-band rejection required.

Test Procedures:

Measurements were in accordance with the test methods section 3.3 of KDB 935210 D05 v01r04.

A signal booster shall reject amplification of other signals outside of its passband. Adjust the internal gain control of the EUT (if so equipped) to the maximum gain for which equipment certification is sought.

- a) Connect a signal generator to the input of the EUT.
- b) Configure a swept CW signal with the following parameters:
 - 1) Frequency range = $\pm 250\%$ of the passband, for each applicable CMRS band.
 - 2) Level = a sufficient level to affirm that the out-of-band rejection is > 20 dB above the noise floor and will not engage the AGC during the entire sweep.
 - 3) Dwell time = approximately 10 ms.
 - 4) Number of points = $\text{SPAN}/(\text{RBW}/2)$.
- c) Connect a spectrum analyzer to the output of the EUT using appropriate attenuation.
- d) Set the span of the spectrum analyzer to the same as the frequency range of the signal generator.
- e) Set the resolution bandwidth (RBW) of the spectrum analyzer to be 1 % to 5 % of the EUT passband, and the video bandwidth (VBW) shall be set to $\geq 3 \times \text{RBW}$.
- f) Set the detector to Peak Max-Hold and wait for the spectrum analyzer's spectral display to fill.
- g) Place a marker to the peak of the frequency response and record this frequency as f_0 .
- h) Place two markers, one at the lowest and the other at the highest frequency of the envelope of the spectral display, such that each marker is at or slightly below the -20 dB down amplitude, to determine the 20 dB bandwidth.
- i) Capture the frequency response of the EUT.
- j) Repeat for all frequency bands applicable for use by the EUT.

Test Results:

3.45 GHz Service / Downlink



5.3. INPUT-VERSUS-OUTPUT SIGNAL COMPARISON

Test Requirement:

§ 2.1049 Measurements required: Occupied bandwidth.

The occupied bandwidth, that is the frequency bandwidth such that, below its lower and above its upper frequency limits, the mean powers radiated are each equal to 0.5 percent of the total mean power radiated by a given emission shall be measured under the specified conditions of § 2.1049 (a) through (i) as applicable.

Test Procedures:

Measurements were in accordance with the test methods section 3.4 of KDB 935210 D05 v01r04.

A 26 dB bandwidth measurement shall be performed on the input signal and the output signal; alternatively, the 99% OBW can be measured and used. See KDB Publication 971168 [R8] for more information on measuring OBW.

- a) Connect a signal generator to the input of the EUT.
- b) Configure the signal generator to transmit the AWGN signal.
- c) Configure the signal amplitude to be just below the AGC threshold level (see 3.2), but not more than 0.5 dB below.
- d) Connect a spectrum analyzer to the output of the EUT using appropriate attenuation.
- e) Set the spectrum analyzer center frequency to the center frequency of the operational band under test. The span range of the spectrum analyzer shall be between 2 times to 5 times the emission bandwidth (EBW) or alternatively, the OBW.
- f) The nominal RBW shall be in the range of 1 % to 5 % of the anticipated OBW, and the VBW shall be $\geq 3 \times$ RBW.
- g) Set the reference level of the instrument as required to preclude the signal from exceeding the maximum spectrum analyzer input mixer level for linear operation. In general, the peak of the spectral envelope must be more than $[10 \log (\text{OBW} / \text{RBW})]$ below the reference level. Steps f) and g) may require iteration to enable adjustments within the specified tolerances.
- h) The noise floor of the spectrum analyzer at the selected RBW shall be at least 36 dB below the reference level.
- i) Set spectrum analyzer detection function to positive peak.
- j) Set the trace mode to max hold.
- k) Determine the reference value: Allow the trace to stabilize. Set the spectrum analyzer marker to the highest amplitude level of the displayed trace (this is the reference value) and record the associated frequency.
- l) Place two markers, one at the lowest and the other at the highest frequency of the envelope of the spectral display, such that each marker is at or slightly below the -26 dB down amplitude. The 26 dB EBW (alternatively OBW) is the positive frequency difference between the two markers. If the spectral envelope crosses the -26 dB down amplitude at multiple points, the lowest or highest frequency shall be selected as the frequencies that are the furthest removed from the center frequency at which the spectral envelope crosses the -26 dB down amplitude point.
- m) Repeat steps e) to l) with the input signal connected directly to the spectrum analyzer (i.e., input signal

measurement).

- n) Compare the spectral plot of the input signal (determined from step m) to the output signal (determined from step l) to affirm that they are similar (in passband and rolloff characteristic features and relative spectral locations), and include plot(s) and descriptions in test report.
- o) Repeat the procedure [steps e) to n)] with the input signal amplitude set to 3 dB above the AGC threshold.
- p) Repeat steps e) to o) with the signal generator set to the narrowband signal.
- q) Repeat steps e) to p) for all frequency bands authorized for use by the EUT.

Test Results:

Tabular data of Output Occupied Bandwidth

Test Band	Link	Signal	Center Frequency (MHz)	99 % OBW (MHz)	26 dB OBW (MHz)
3.45 GHz Service	Downlink	5G NR 20 MHz	3 500.00	18.226	19.384
		5G NR 40 MHz	3 500.00	37.897	39.952
		5G NR 60 MHz	3 500.00	57.704	60.872
		5G NR 80 MHz	3 500.00	77.382	81.506
		5G NR 100 MHz	3 500.00	96.593	102.281

Tabular data of Input Occupied Bandwidth

Test Band	Link	Signal	Center Frequency (MHz)	99 % OBW (MHz)	26 dB OBW (MHz)
3.45 GHz Service	Downlink	5G NR 20 MHz	3 500.00	18.282	19.386
		5G NR 40 MHz	3 500.00	37.942	39.936
		5G NR 60 MHz	3 500.00	58.027	60.881
		5G NR 80 MHz	3 500.00	77.659	81.515
		5G NR 100 MHz	3 500.00	97.293	102.413

Tabular data of 3 dB above the AGC threshold Output Occupied Bandwidth

Test Band	Link	Signal	Center Frequency (MHz)	99 % OBW (MHz)	26 dB OBW (MHz)
3.45 GHz Service	Downlink	5G NR 20 MHz	3 500.00	18.257	19.429
		5G NR 40 MHz	3 500.00	37.937	39.920
		5G NR 60 MHz	3 500.00	57.805	60.836
		5G NR 80 MHz	3 500.00	77.436	81.475
		5G NR 100 MHz	3 500.00	96.543	102.179

Tabular data of 3 dB above the AGC threshold Input Occupied Bandwidth

Test Band	Link	Signal	Center Frequency (MHz)	99 % OBW (MHz)	26 dB OBW (MHz)
3.45 GHz Service	Downlink	5G NR 20 MHz	3 500.00	18.273	19.408
		5G NR 40 MHz	3 500.00	37.921	39.908
		5G NR 60 MHz	3 500.00	57.978	60.847
		5G NR 80 MHz	3 500.00	77.577	81.480
		5G NR 100 MHz	3 500.00	97.276	102.417

Measured Occupied Bandwidth Comparison

Test Band	Link	Signal	Variant of Input and output 26 dB Occupied Bandwidth (%)	Variant of Input and 3 dB above the AGC threshold output 26 dB Occupied Bandwidth (%)
3.45 GHz Service	Downlink	5G NR 20 MHz	-0.010	0.108
		5G NR 40 MHz	0.040	0.030
		5G NR 60 MHz	-0.015	-0.018
		5G NR 80 MHz	-0.011	-0.006
		5G NR 100 MHz	-0.129	-0.232

* Change in input-output OBW is less than $\pm 5\%$.

Plot data of Occupied Bandwidth

Output / 3.45 GHz Service / Downlink / 5G NR 20 MHz

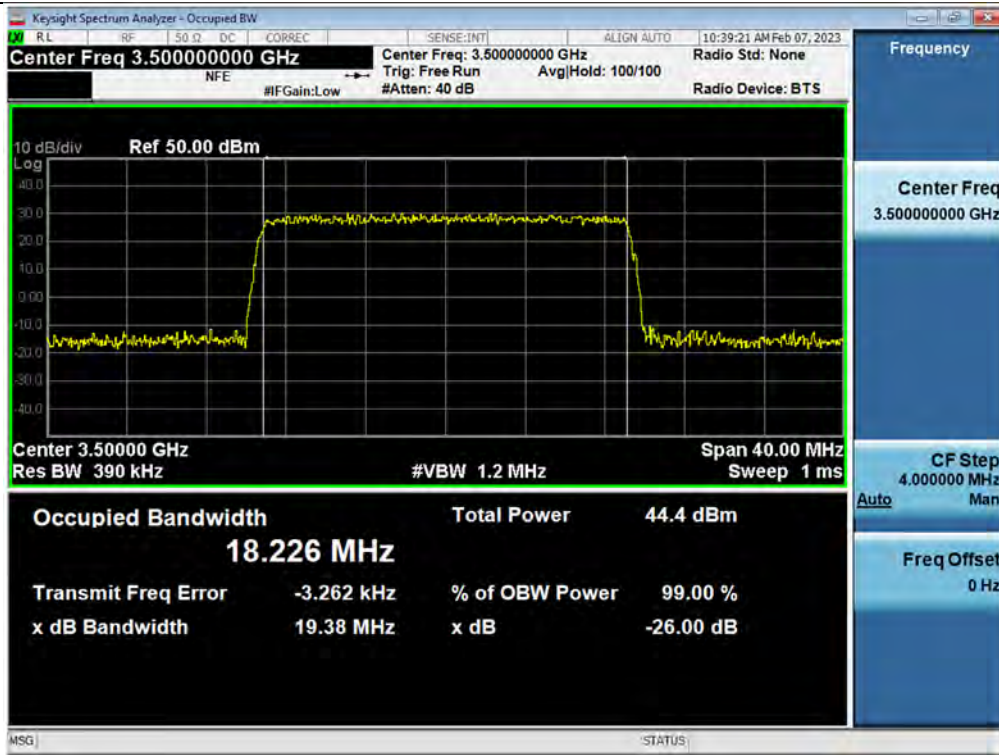

Input / 3.45 GHz Service / Downlink / 5G NR 20 MHz

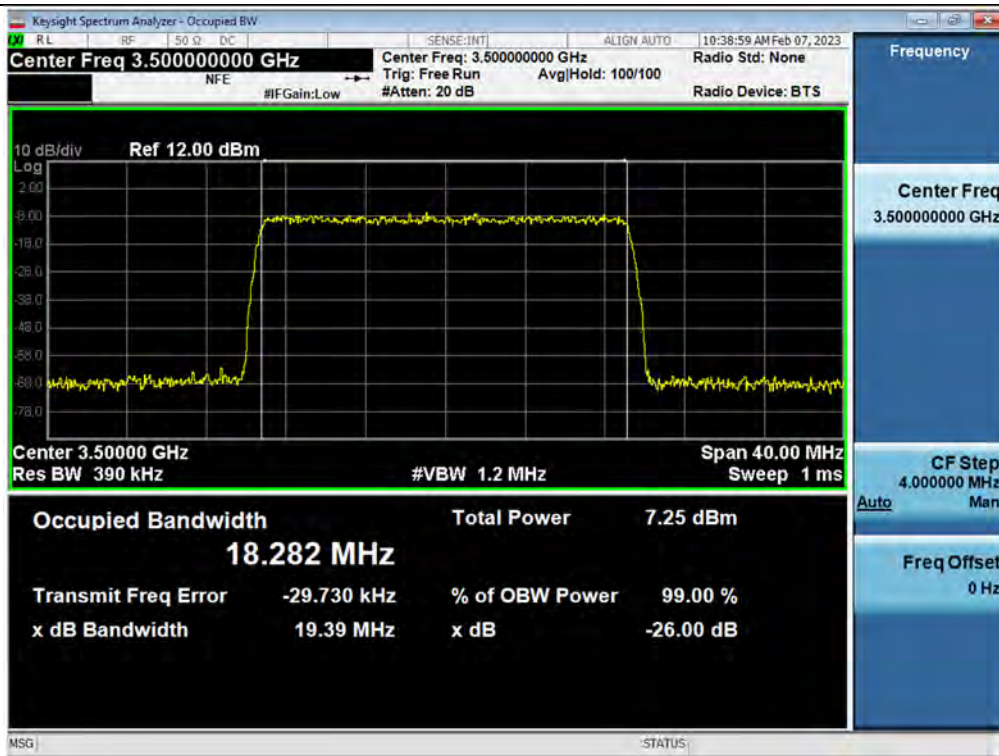

3 dB above the AGC threshold output / 3.45 GHz Service / Downlink / 5G NR 20 MHz

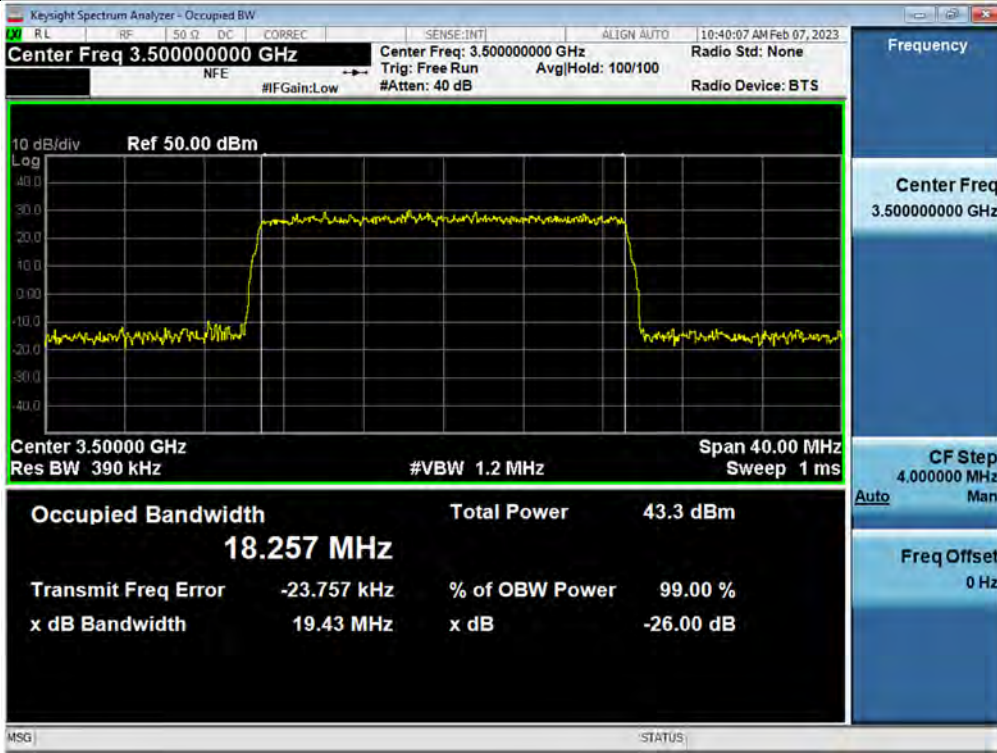

3 dB above the AGC threshold Input / 3.45 GHz Service / Downlink / 5G NR 20 MHz

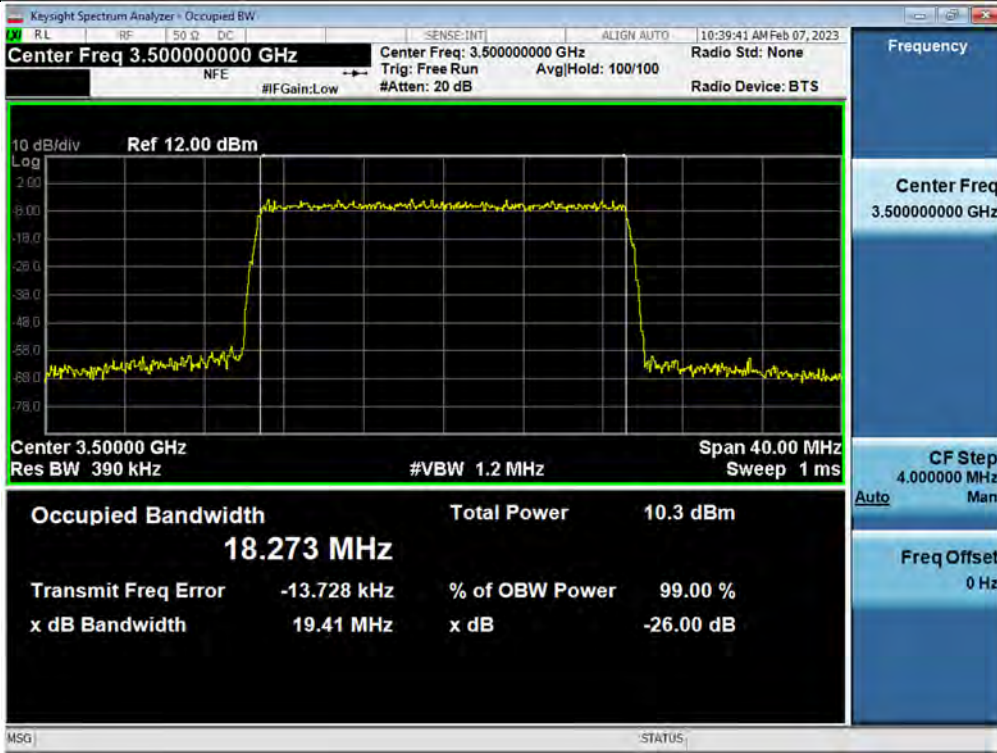

Output / 3.45 GHz Service / Downlink / 5G NR 40 MHz

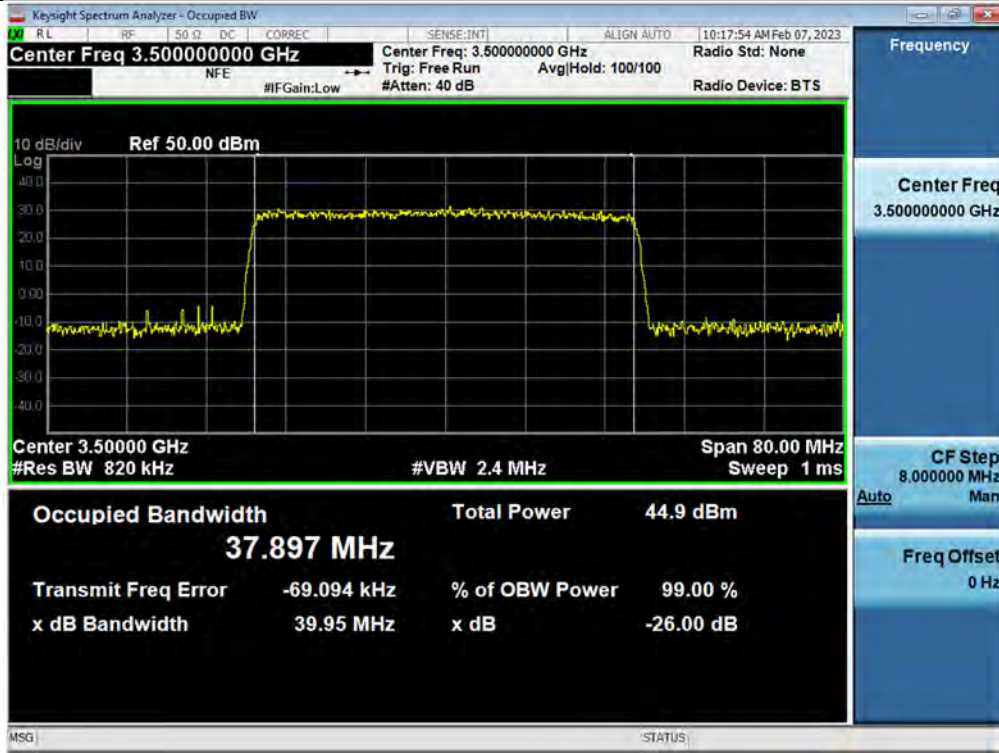

Input / 3.45 GHz Service / Downlink / 5G NR 40 MHz

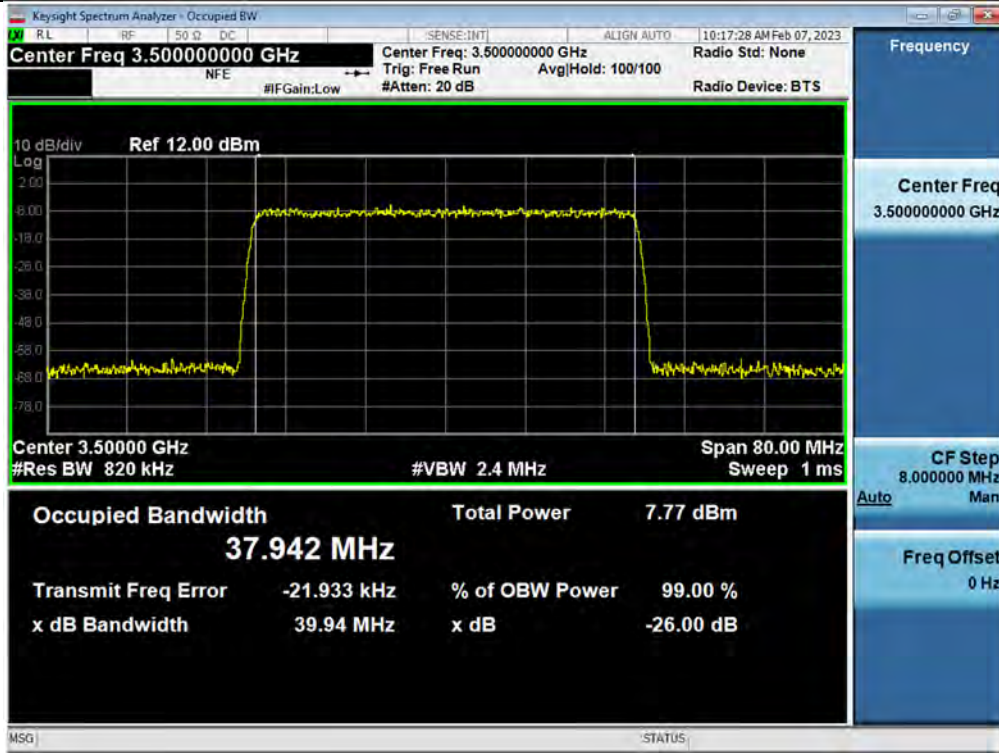

3 dB above the AGC threshold output / 3.45 GHz Service / Downlink / 5G NR 40 MHz

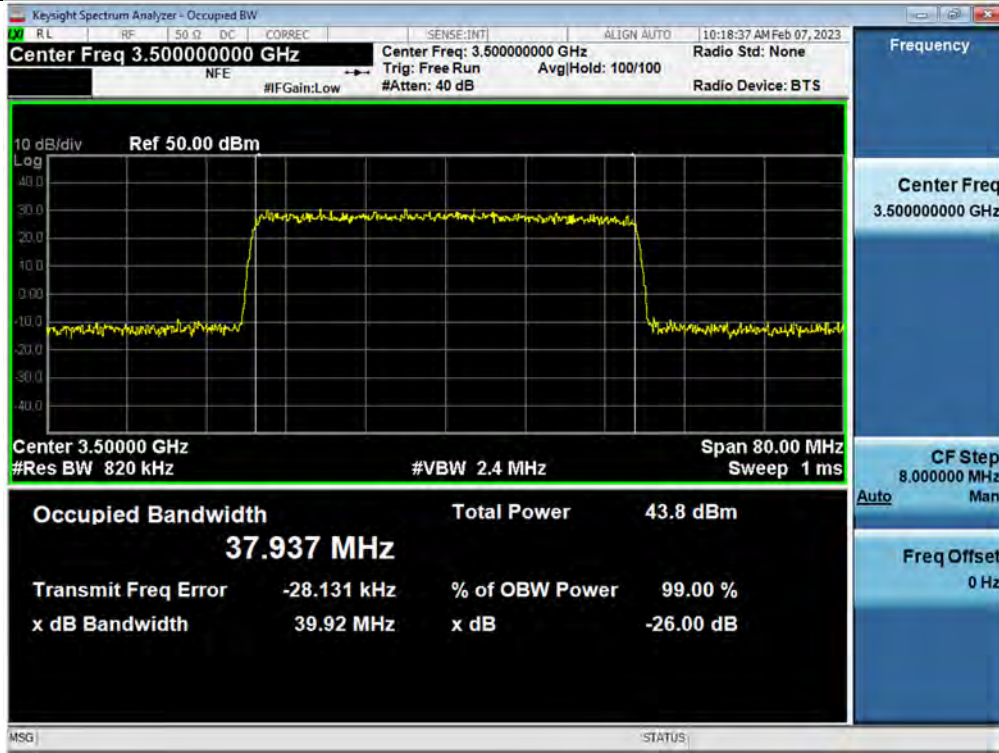

3 dB above the AGC threshold Input / 3.45 GHz Service / Downlink / 5G NR 40 MHz

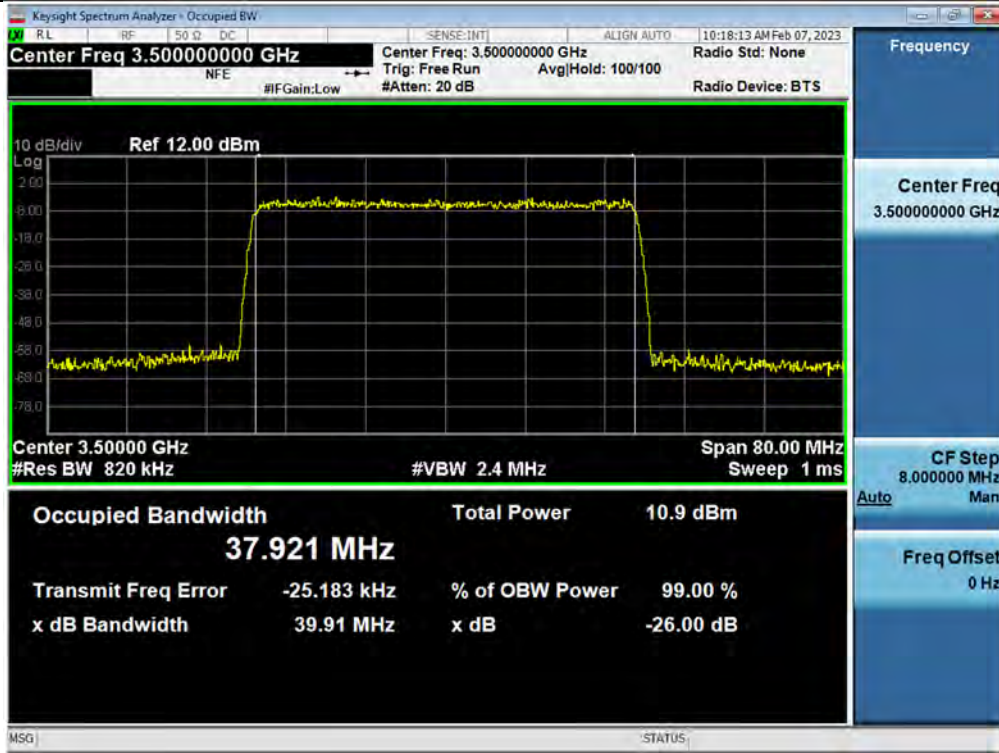

Output / 3.45 GHz Service / Downlink / 5G NR 60 MHz

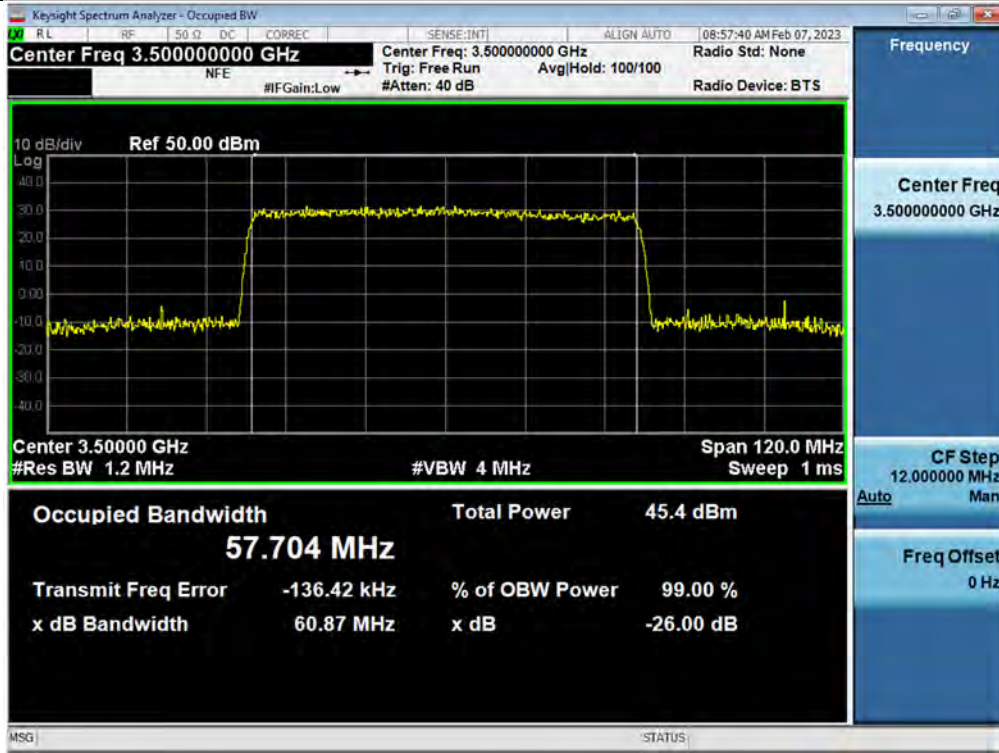

Input / 3.45 GHz Service / Downlink / 5G NR 60 MHz

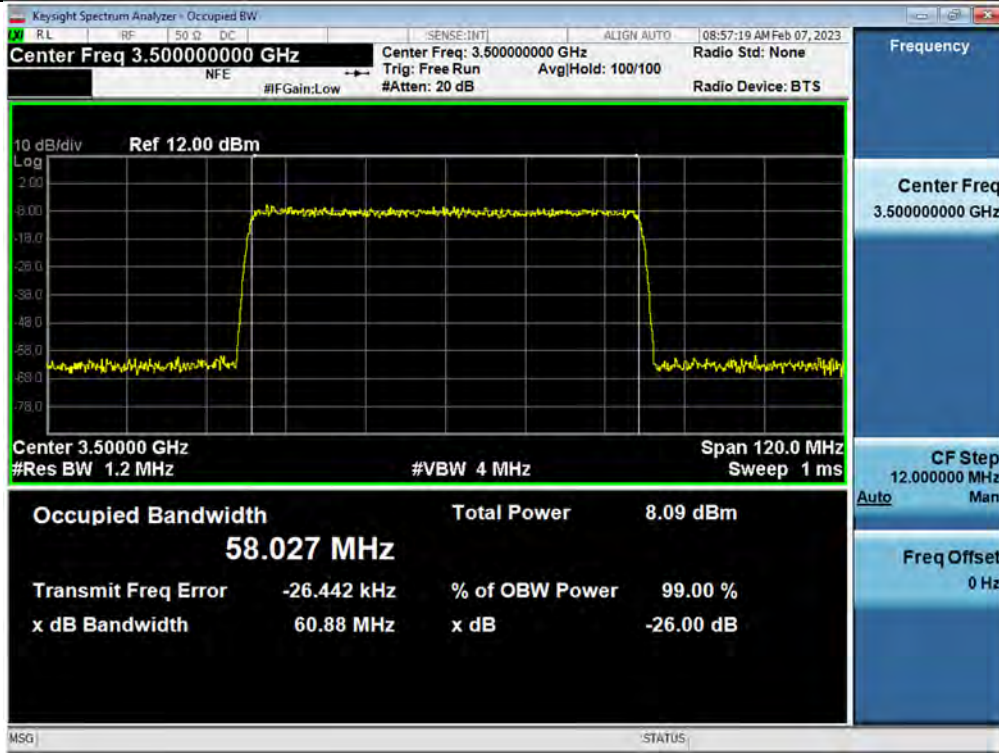

3 dB above the AGC threshold output / 3.45 GHz Service / Downlink / 5G NR 60 MHz

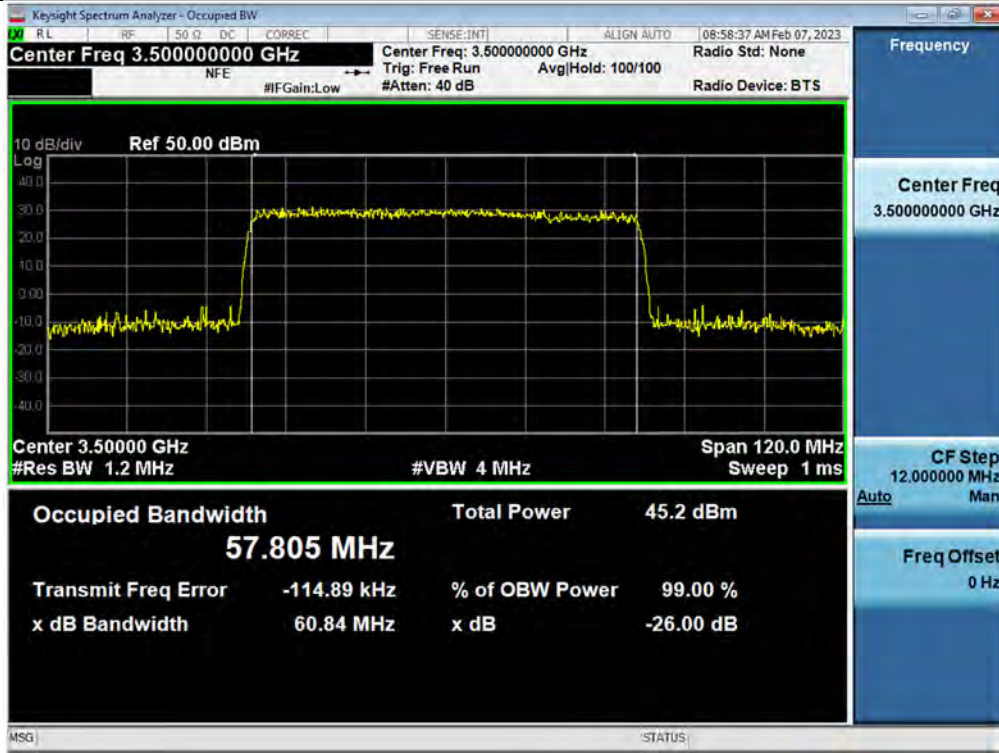

3 dB above the AGC threshold Input / 3.45 GHz Service / Downlink / 5G NR 60 MHz

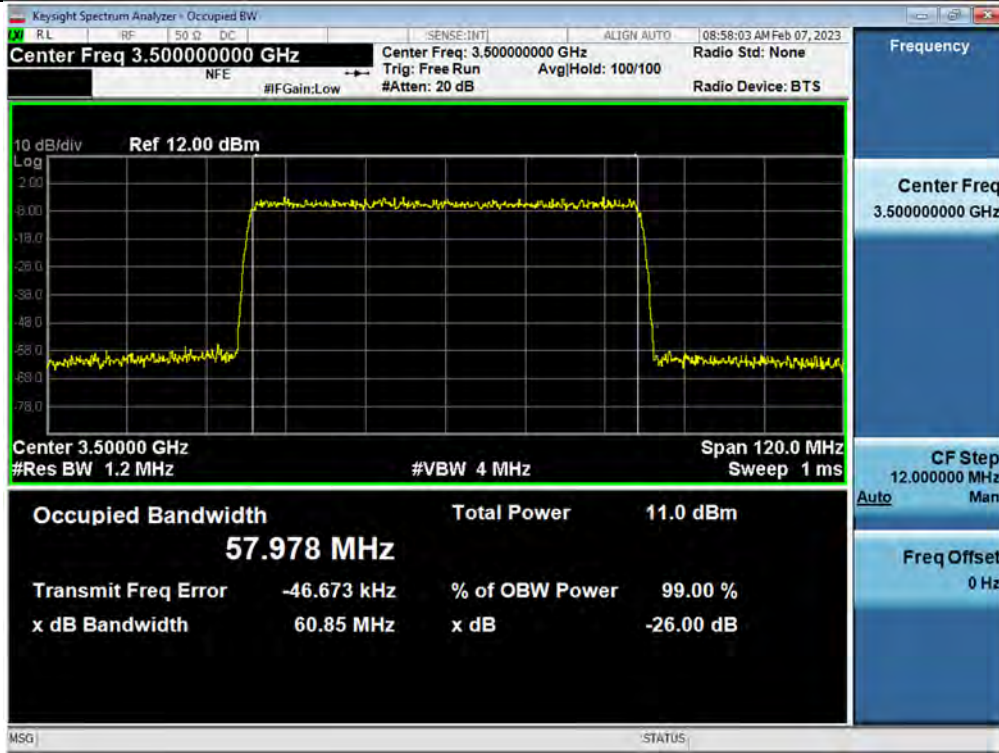

Output / 3.45 GHz Service / Downlink / 5G NR 80 MHz

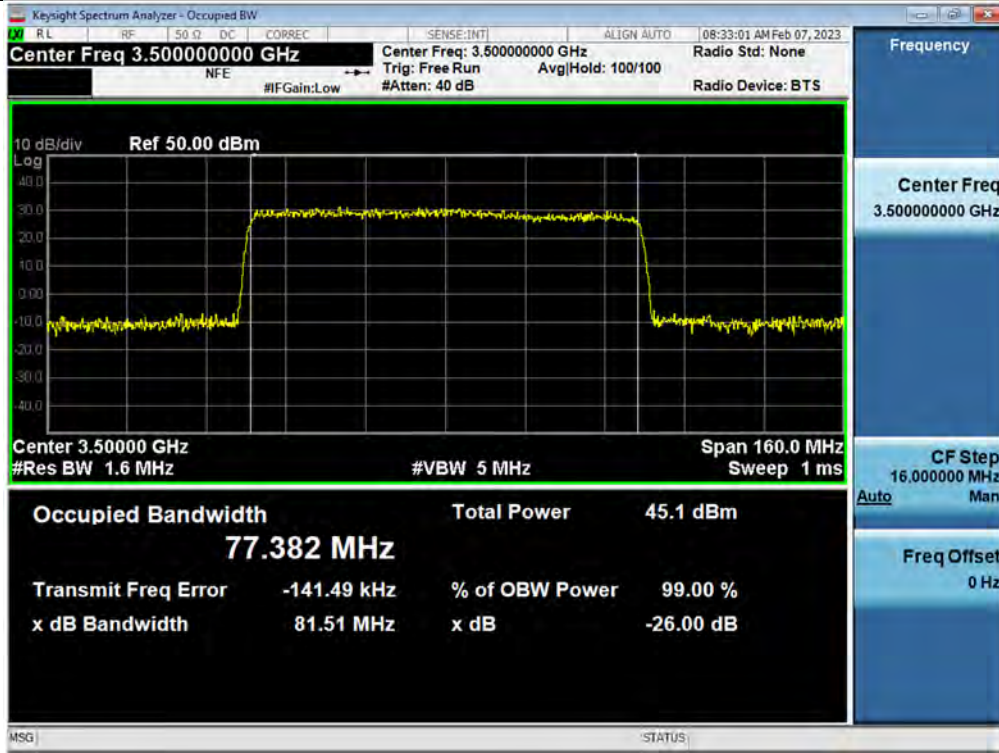

Input / 3.45 GHz Service / Downlink / 5G NR 80 MHz

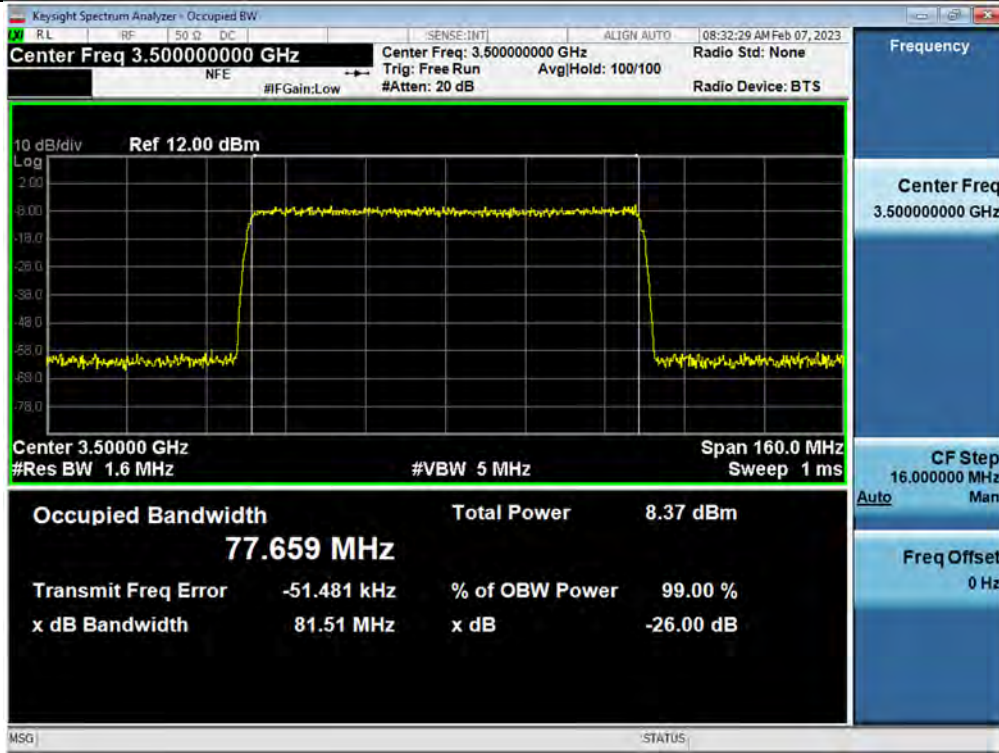

3 dB above the AGC threshold output / 3.45 GHz Service / Downlink / 5G NR 80 MHz

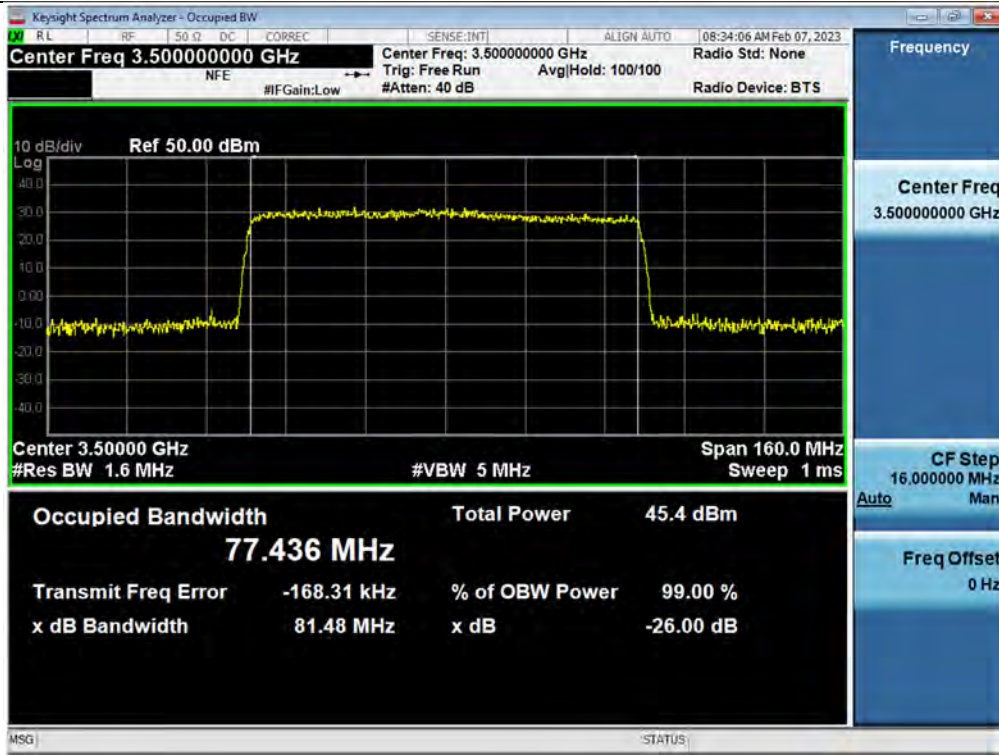

3 dB above the AGC threshold Input / 3.45 GHz Service / Downlink / 5G NR 80 MHz

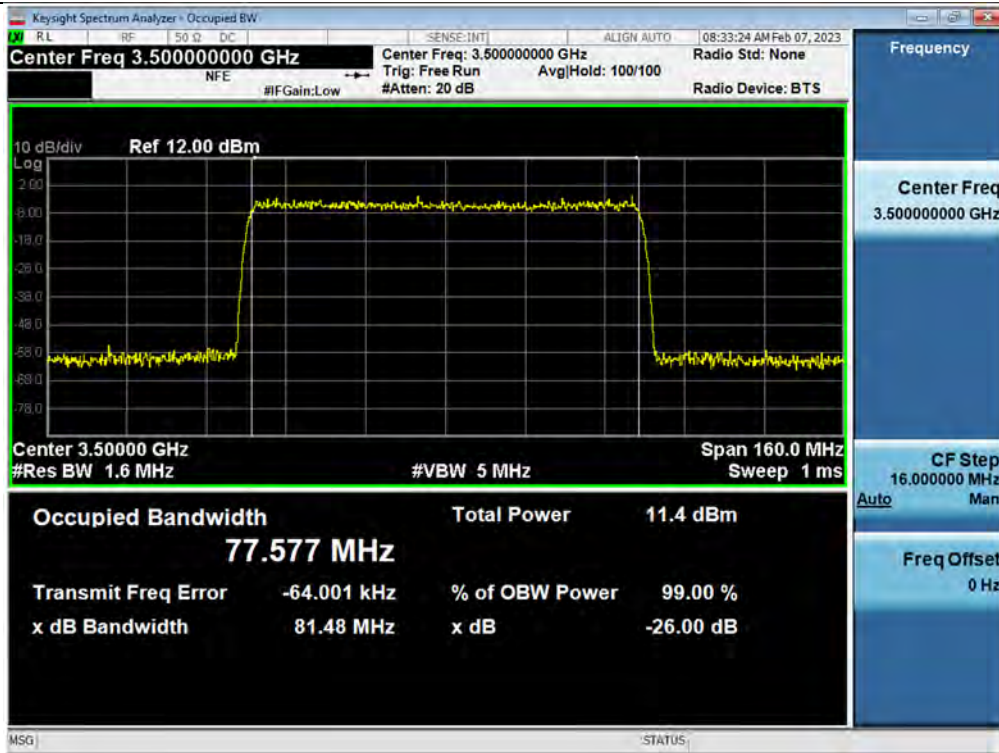

Output / 3.45 GHz Service / Downlink / 5G NR 100 MHz

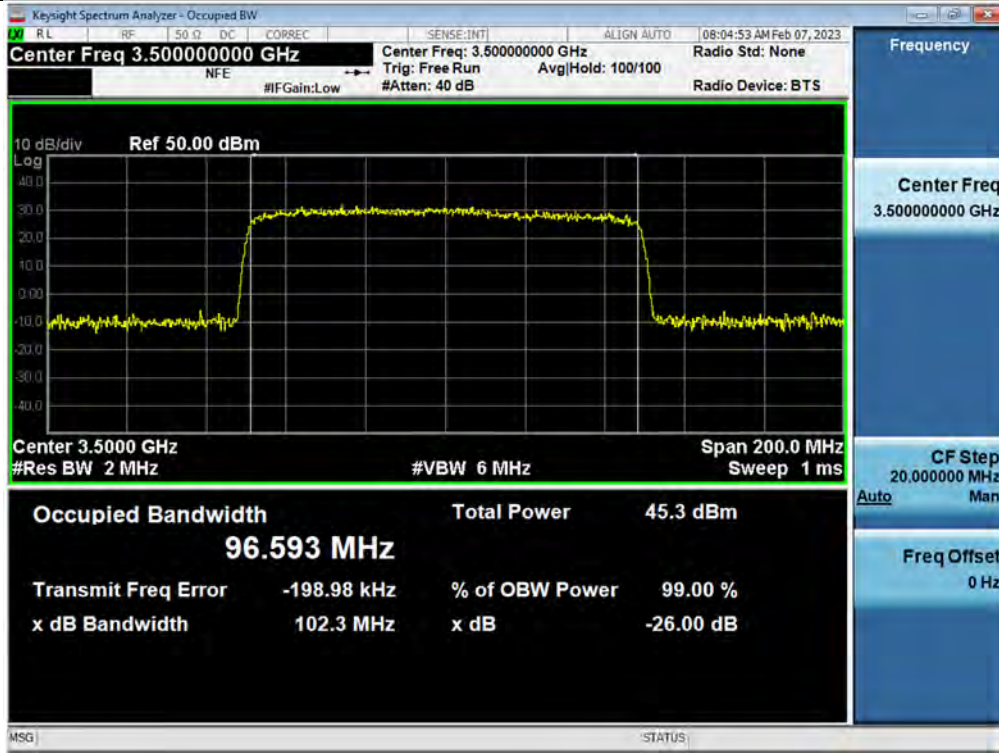

Input / 3.45 GHz Service / Downlink / 5G NR 100 MHz

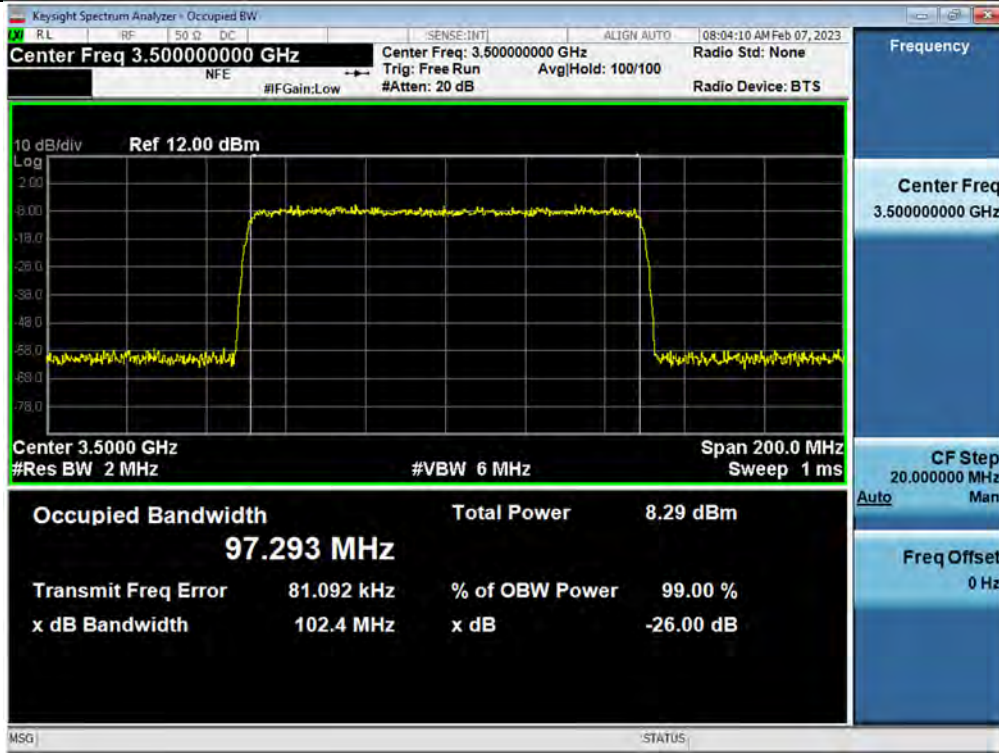

3 dB above the AGC threshold output / 3.45 GHz Service / Downlink / 5G NR 100 MHz

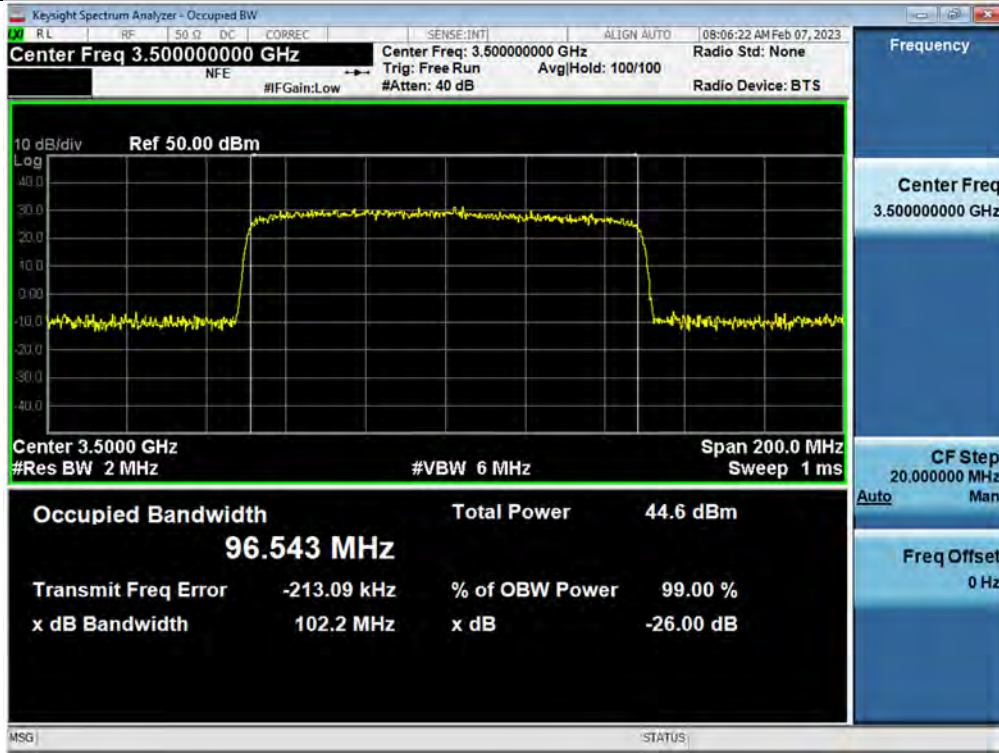

3 dB above the AGC threshold Input / 3.45 GHz Service / Downlink / 5G NR 100 MHz

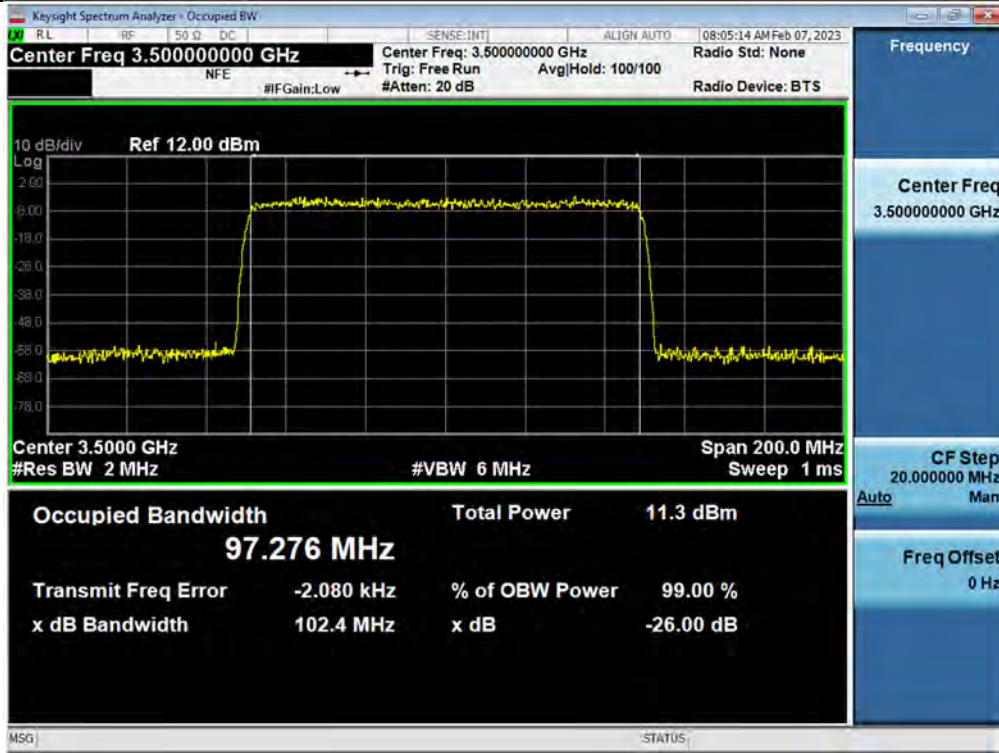

5.4. INPUT/OUTPUT POWER AND AMPLIFIER/BOOSTER GAIN

Test Requirement:

§ 2.1046 Measurements required: RF power output.

- (a) For transmitters other than single sideband, independent sideband and controlled carrier radiotelephone, power output shall be measured at the RF output terminals when the transmitter is adjusted in accordance with the tune-up procedure to give the values of current and voltage on the circuit elements specified in § 2.1033(c)(8). The electrical characteristics of the radio frequency load attached to the output terminals when this test is made shall be stated.
- (b) For single sideband, independent sideband, and single channel, controlled carrier radiotelephone transmitters the procedure specified in paragraph (a) of this section shall be employed and, in addition, the transmitter shall be modulated during the test as specified and applicable in § 2.1046 (b) (1-5). In all tests, the input level of the modulating signal shall be such as to develop rated peak envelope power or carrier power, as appropriate, for the transmitter.
- (c) For measurements conducted pursuant to paragraphs (a) and (b) of this section, all calculations and methods used by the applicant for determining carrier power or peak envelope power, as appropriate, on the basis of measured power in the radio frequency load attached to the transmitter output terminals shall be shown. Under the test conditions specified, no components of the emission spectrum shall exceed the limits specified in the applicable rule parts as necessary for meeting occupied bandwidth or emission limitations.

27.50 Power limits and duty cycle.

- (k) The following power requirements apply to stations transmitting in the 3450-3550 MHz band:
 - (1) The power of each fixed or base station transmitting in the 3450-3550 MHz band and located in any county with population density of 100 or fewer persons per square mile, based upon the most recently available population statistics from the Bureau of the Census, is limited to an equivalent isotropically radiated power (EIRP) of 3280 Watts/MHz. This limit applies to the aggregate power of all antenna elements in any given sector of a base station.
 - (2) The power of each fixed or base station transmitting in the 3450-3550 MHz band and situated in any geographic location other than that described in paragraph (k)(1) of this section is limited to an EIRP of 1640 Watts/MHz. This limit applies to the aggregate power of all antenna elements in any given sector of a base station.

(
4
)

E
q
u
i
p
m
e
n
t

Test Procedures:

Measurements were in accordance with the test methods section 3.5 of KDB 935210 D05 v01r04.

Adjust the internal gain control of the EUT to the maximum gain for which the equipment certification is being sought. Any EUT attenuation settings shall be set to their minimum value.

Input power levels (uplink and downlink) should be set to maximum input ratings while confirming that the device is not capable of operating in saturation (non-linear mode) at the rated input levels, including during the performance of the input/output power measurements.

3.5.2 Measuring the EUT mean input and output power

- a) Connect a signal generator to the input of the EUT.
- b) Configure to generate the test signal.
- c) The frequency of the signal generator shall be set to the frequency f_0 as determined from out-of-band rejection test.
- d) Connect a spectrum analyzer or power meter to the output of the EUT using appropriate attenuation as necessary.
- e) Set the signal generator output power to a level that produces an EUT output level that is just below the AGC threshold, but not more than 0.5 dB below.
- f) Measure and record the output power of the EUT; use ANSI C63.26-2015 subclause 5.2.4.4.1, for power measurement.
- g) Remove the EUT from the measurement setup. Using the same signal generator settings, repeat the power measurement at the signal generator port, which was used as the input signal to the EUT, and record as the input power. EUT gain may be calculated as described in 3.5.5.
- h) Repeat steps f) and g) with input signal amplitude set to 3 dB above the AGC threshold level.
- i) Repeat steps e) to h) with the narrowband test signal.
- j) Repeat steps e) to i) for all frequency bands authorized for use by the EUT.

3.5.5 Calculating amplifier, repeater, or industrial booster gain

After the input and output power levels have been measured as described in the preceding subclauses, the gain of the EUT can be determined from:

$$\text{Gain (dB)} = \text{output power (dBm)} - \text{input power (dBm)}.$$

Report the gain for each authorized operating frequency band, and each test signal stimulus.

Note:

1. If f_0 that determined from out-of-band test is smaller or greater than difference of test signal's center frequency and operation band block, test is performed at the lowest or the highest frequency that test signals can be passed.
 2. E.I.R.P. (W/MHz) is calculated from Output Power (W) divided by Channel Bandwidth (MHz).
 3. All power supplies of operation were investigated and the worst case configuration results are reported.
- Mode: 100~240 VAC, 50/60 Hz / 36~76 VDC
 - Worst case: 100~240 VAC, 50/60 Hz

Test Results:

Tabular data of Input / Output Power and Gain

Test Band	Signal	f ₀ Frequency	Input Power	Output Power	Gain
		(MHz)	(dBm)		(dB)
3.45 GHz Service	5G NR 20 MHz	3 493.06	-0.15	37.25	37.40
	5G NR 40 MHz	3 493.06	-0.04	37.08	37.12
	5G NR 60 MHz	3 493.06	-0.20	37.18	37.38
	5G NR 80 MHz	3 493.06	-0.13	36.95	37.08
	5G NR 100 MHz	3 500.00	-0.25	36.94	37.19

Tabular data of Input / 3 dB above AGC threshold Output Power and Gain

Test Band	Signal	f ₀ Frequency	Input Power	Output Power	Gain
		(MHz)	(dBm)		(dB)
3.45 GHz Service	5G NR 20 MHz	3 493.06	2.79	37.17	34.38
	5G NR 40 MHz	3 493.06	2.86	36.81	33.95
	5G NR 60 MHz	3 493.06	2.74	36.97	34.23
	5G NR 80 MHz	3 493.06	2.85	36.76	33.91
	5G NR 100 MHz	3 500.00	2.82	36.67	33.85

Tabular data of equivalent isotropically radiated power(E.I.R.P.)

Test Band	Signal	f ₀ Frequency (MHz)	Output PSD (dBm/MHz)	Ant. Gain (dBi)	E.I.R.P. (dBm/MHz)	Calculated (W/MHz)	Limit (W/MHz)
3.45 GHz Service	5G NR 20 MHz	3 493.06	25.871	21.3	47.171	52.131	1640
	5G NR 40 MHz	3 493.06	22.445	21.3	43.745	23.686	
	5G NR 60 MHz	3 493.06	21.203	21.3	42.503	17.795	
	5G NR 80 MHz	3 493.06	19.503	21.3	40.803	12.031	
	5G NR 100 MHz	3 500.00	18.722	21.3	40.022	10.051	

*Note: Downlink E.I.R.P.(dBm/MHz) = Output PSD(dBm/MHz) + Ant. Gain(dBi)

Tabular data of 3 dB above AGC threshold equivalent isotropically radiated power(E.I.R.P.)

Test Band	Signal	f ₀ Frequency (MHz)	Output PSD (dBm/MHz)	Ant. Gain (dBi)	E.I.R.P. (dBm/MHz)	Calculated (W/MHz)	Limit (W/MHz)
3.45 GHz Service	5G NR 20 MHz	3 493.06	25.792	21.3	47.092	51.192	1640
	5G NR 40 MHz	3 493.06	22.340	21.3	43.640	23.121	
	5G NR 60 MHz	3 493.06	20.639	21.3	41.939	15.628	
	5G NR 80 MHz	3 493.06	19.444	21.3	40.744	11.869	
	5G NR 100 MHz	3 500.00	18.664	21.3	39.964	9.917	

*Note: Downlink E.I.R.P.(dBm/MHz) = Output PSD(dBm/MHz) + Ant. Gain(dBi)

Tabular data of PAPR

Test Band	Signal	f ₀ Frequency (MHz)	0.1 % PAPR (dB)
3.45 GHz Service	5G NR 20 MHz	3 493.06	8.42
	5G NR 40 MHz	3 493.06	8.47
	5G NR 60 MHz	3 493.06	8.52
	5G NR 80 MHz	3 493.06	8.47
	5G NR 100 MHz	3 500.00	8.45

Plot data of PSD

PSD / 3.45 GHz Service / Downlink / 5G NR 20 MHz



3 dB above the AGC threshold PSD / 3.45 GHz Service / Downlink / 5G NR 20 MHz

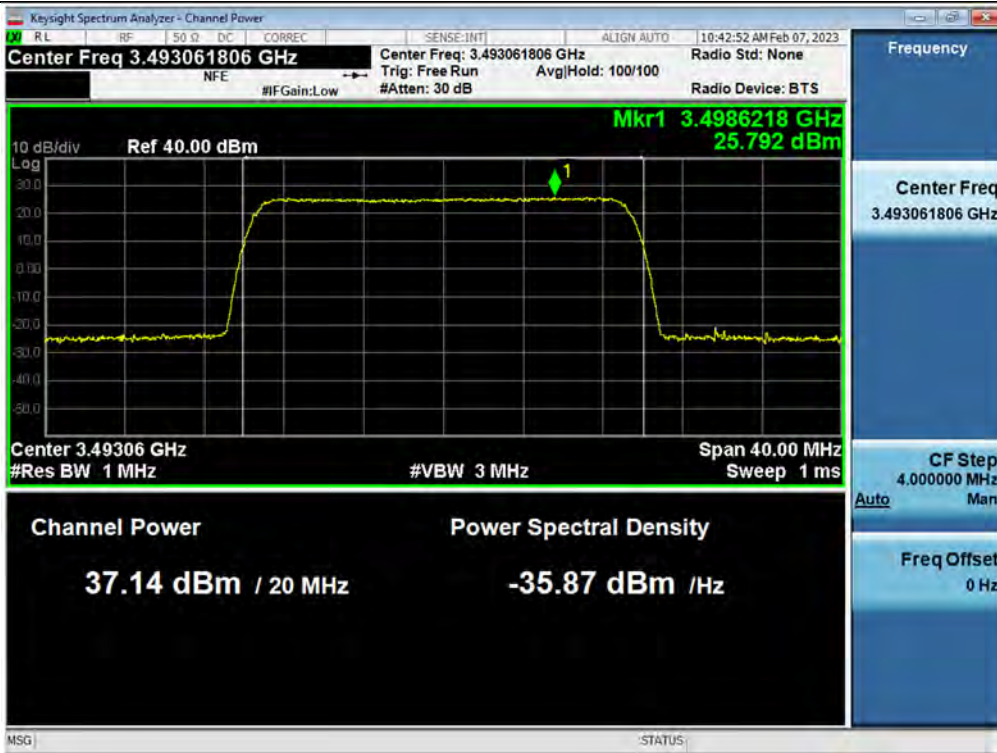

PSD / 3.45 GHz Service / Downlink / 5G NR 40 MHz



3 dB above the AGC threshold PSD / 3.45 GHz Service / Downlink / 5G NR 40 MHz



PSD / 3.45 GHz Service / Downlink / 5G NR 60 MHz



3 dB above the AGC threshold PSD / 3.45 GHz Service / Downlink / 5G NR 60 MHz



PSD / 3.45 GHz Service / Downlink / 5G NR 80 MHz



3 dB above the AGC threshold PSD / 3.45 GHz Service / Downlink / 5G NR 80 MHz



PSD / 3.45 GHz Service / Downlink / 5G NR 100 MHz

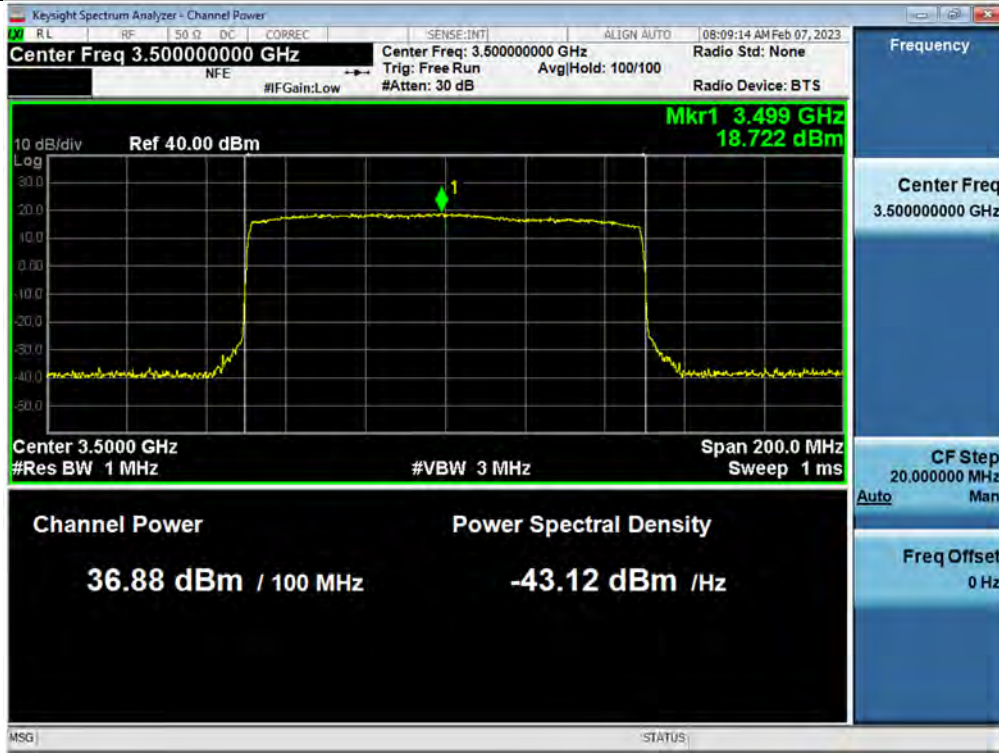

3 dB above the AGC threshold PSD / 3.45 GHz Service / Downlink / 5G NR 100 MHz



Plot data of PAPR

PAPR / 3.45 GHz Service / Downlink / 5G NR 20 MHz

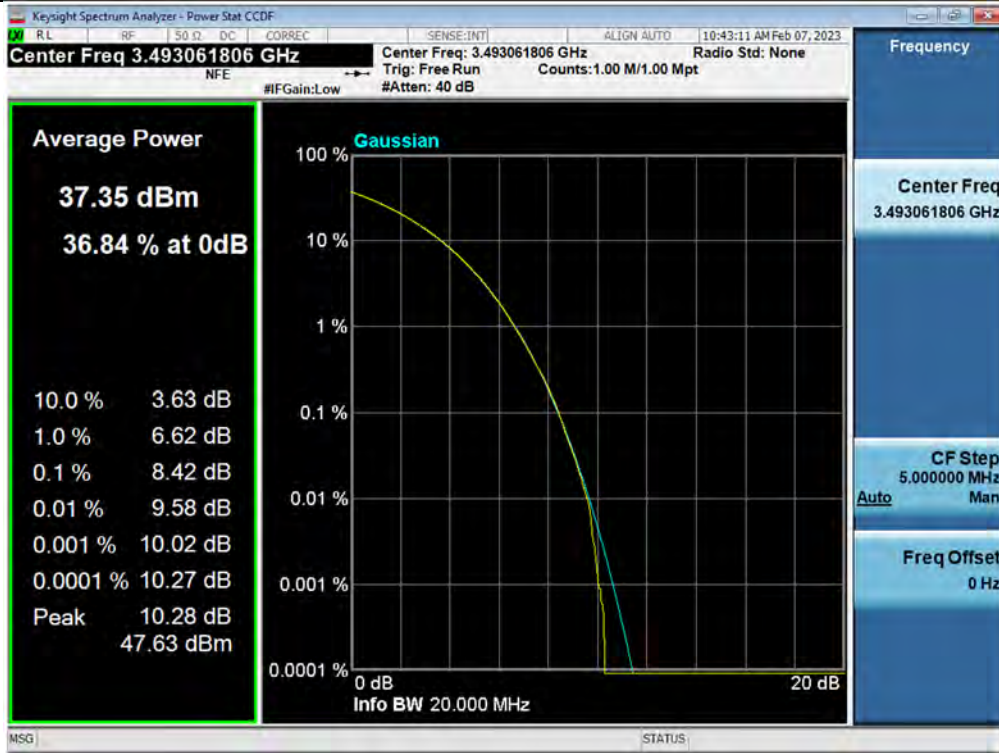

PAPR / 3.45 GHz Service / Downlink / 5G NR 40 MHz

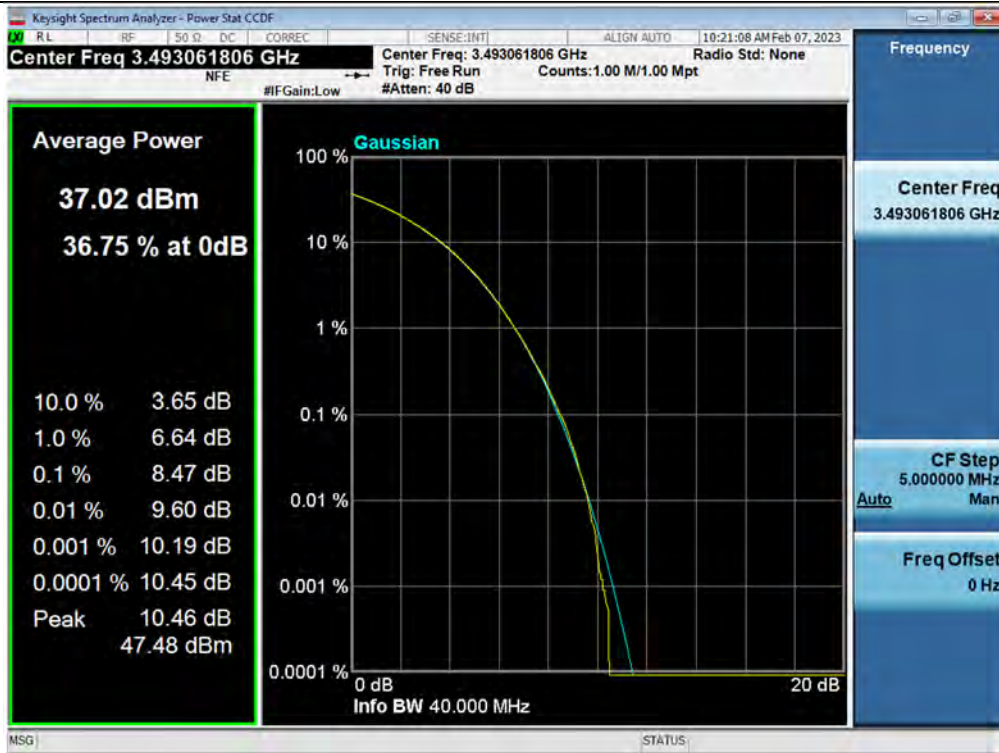

PAPR / 3.45 GHz Service / Downlink / 5G NR 60 MHz

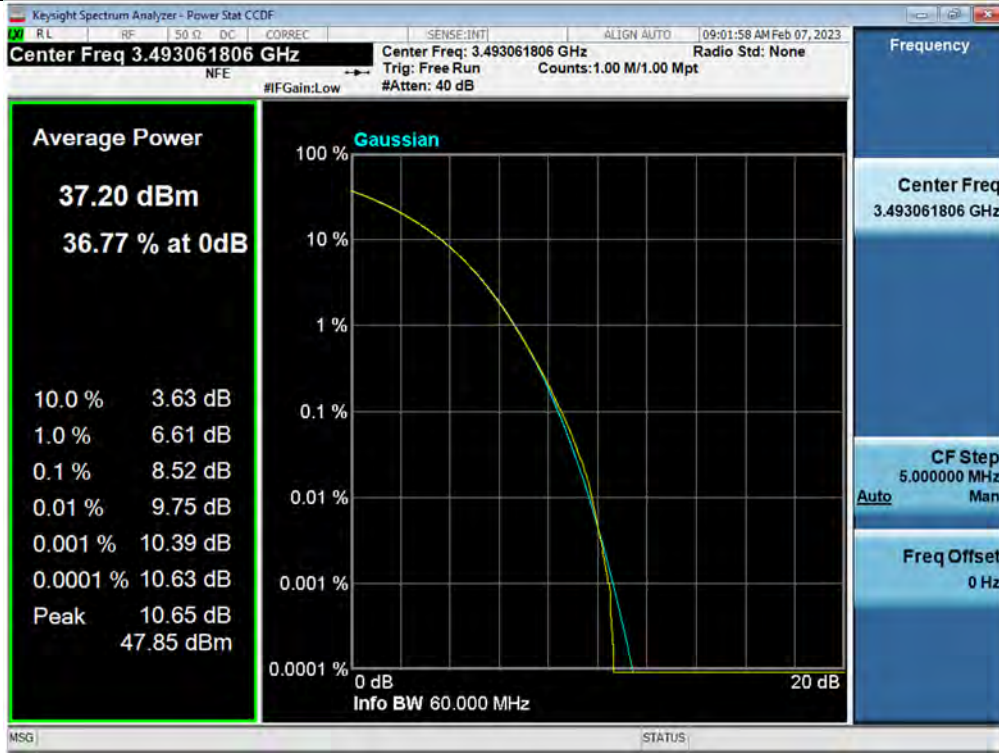

PAPR / 3.45 GHz Service / Downlink / 5G NR 80 MHz

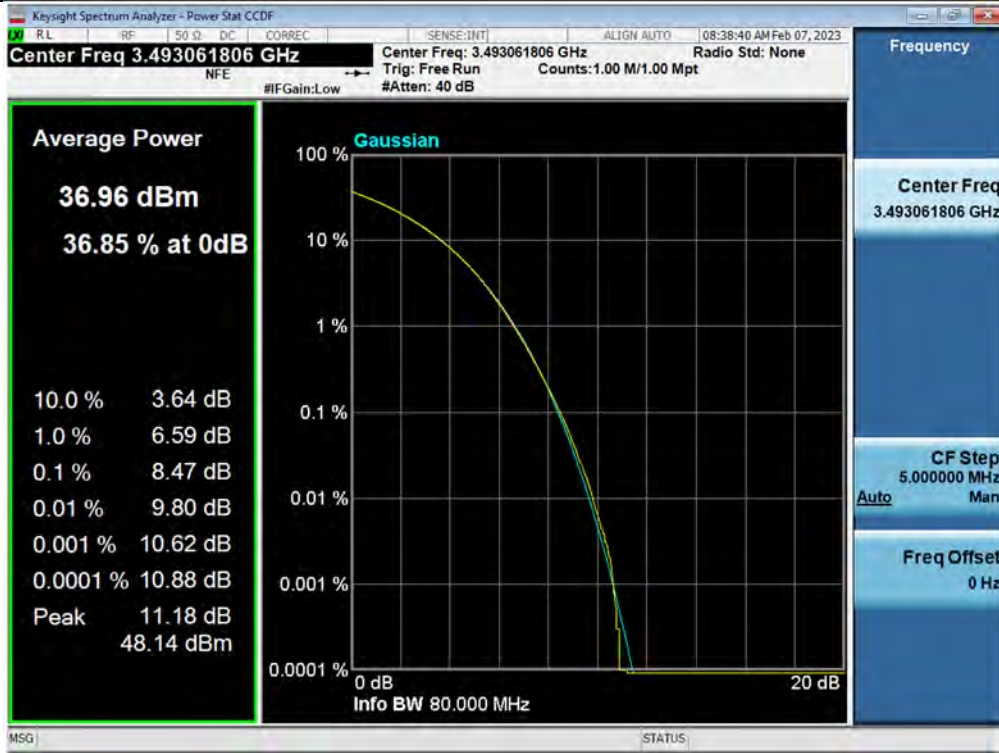

PAPR / 3.45 GHz Service / Downlink / 5G NR 100 MHz

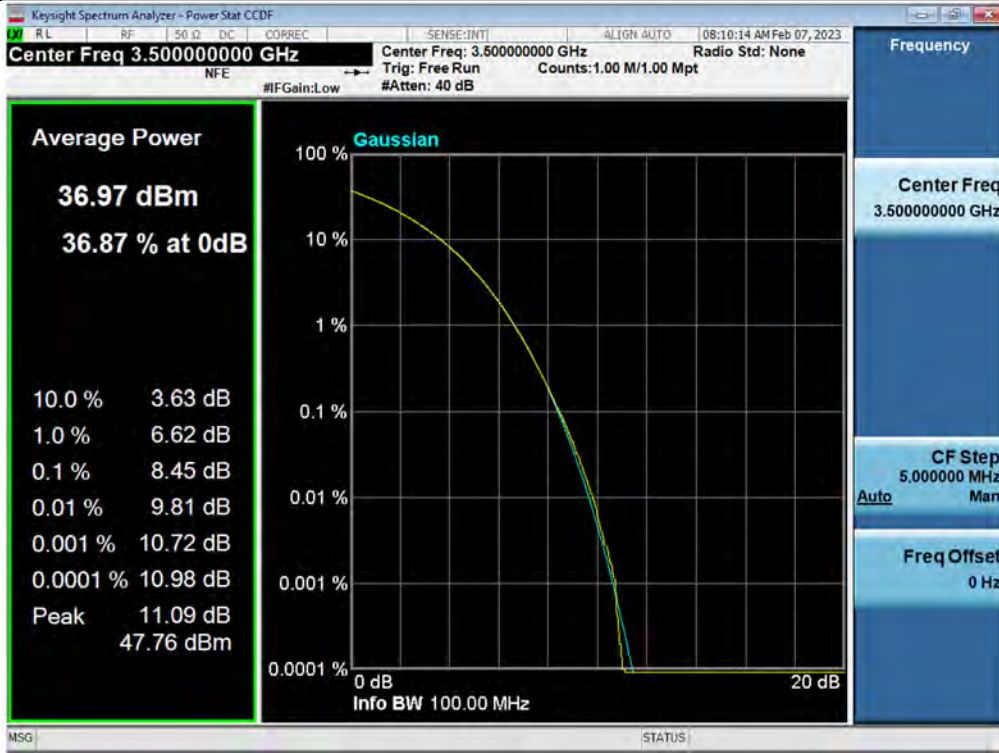

5.5. OUT-OF-BAND/OUT-OF-BLOCK EMISSIONS AND SPURIOUS EMISSIONS

Test Requirements:

§ 2.1051 Measurements required: Spurious emissions at antenna terminals:

The radio frequency voltage or powers generated within the equipment and appearing on a spurious frequency shall be checked at the equipment output terminals when properly loaded with a suitable artificial antenna. Curves or equivalent data shall show the magnitude of each harmonic and other spurious emission that can be detected when the equipment is operated under the conditions specified in § 2.1049 as appropriate. The magnitude of spurious emissions which are attenuated more than 20 dB below the permissible value need not be specified.

27.53 Emission limits.

(n) 3.45 GHz Service. The following emission limits apply to stations transmitting in the 3450-3550 MHz band:

- (1) For base station operations in the 3450-3550 MHz band, the conducted power of any emission outside the licensee's authorized bandwidth shall not exceed -13 dBm/MHz. Compliance with the provisions of this paragraph (n)(1) is based on the use of measurement instrumentation employing a resolution bandwidth of 1 megahertz or greater. However, in the 1 megahertz bands immediately outside and adjacent to the licensee's frequency block, a resolution bandwidth of at least one percent of the emission bandwidth of the fundamental emission of the transmitter may be employed, but limited to a maximum of 200 kHz. The emission bandwidth is defined as the width of the signal between two points, one below the carrier center frequency and one above the carrier center frequency, outside of which all emissions are attenuated at least 26 dB below the transmitter power. Notwithstanding the channel edge requirement of -13 dBm per megahertz, for base station operations in the 3450-3550 MHz band, the conducted power of any emission below 3440 MHz or above 3560 MHz shall not exceed -25 dBm/MHz, and the conducted power of emissions below 3430 MHz or above 3570 MHz shall not exceed -40 dBm/MHz.

Test Procedures:

Measurements were in accordance with the test methods section 3.6 of KDB 935210 D05 v01r04.

Spurious emissions shall be measured using a single test signal sequentially tuned to the low, middle, and high channels or frequencies within each authorized frequency band of operation.

Out-of-band/out-of-block emissions (including intermodulation products) shall be measured under each of the following two stimulus conditions:

- a) two adjacent test signals sequentially tuned to the lower and upper frequency band/block edges;
- b) a single test signal, sequentially tuned to the lowest and highest frequencies or channels within the frequency band/block under examination.

NOTE—Single-channel boosters that cannot accommodate two simultaneous signals within the passband may be excluded from the test stipulated in step a).

3.6.2 Out-of-band/out-of-block emissions conducted measurements

- a) Connect a signal generator to the input of the EUT.
If the signal generator is not capable of generating two modulated carriers simultaneously, then two discrete signal generators can be connected with an appropriate combining network to support this two-signal test.
- b) Set the signal generator to produce two AWGN signals as previously described.
- c) Set the center frequencies such that the AWGN signals occupy adjacent channels, as defined by industry standards such as 3GPP or 3GPP2, at the upper edge of the frequency band or block under test.
- d) Set the composite power levels such that the input signal is just below the AGC threshold, but not more than 0.5 dB below. The composite power can be measured using the procedures provided in KDB Publication 971168, but it will be necessary to expand the power integration bandwidth so as to include both of the transmit channels.
- e) Connect a spectrum analyzer to the output of the EUT using appropriate attenuation as necessary.
- f) Set the RBW = reference bandwidth in the applicable rule section for the supported frequency band.
- g) Set the VBW = $3 \times$ RBW.
- h) Set the detector to power averaging (rms) detector.
- i) Set the Sweep time = auto-couple.
- j) Set the spectrum analyzer start frequency to the upper block edge frequency, and the stop frequency to the upper block edge frequency plus 300 kHz or 3 MHz, for frequencies below and above 1 GHz, respectively.
- k) Trace average at least 100 traces in power averaging (rms) mode.
- l) Use the marker function to find the maximum power level.
- m) Capture the spectrum analyzer trace of the power level for inclusion in the test report.
- n) Repeat steps k) to m) with the composite input power level set to 3 dB above the AGC threshold.
- o) Reset the frequencies of the input signals to the lower edge of the frequency block or band under test.
- p) Reset the spectrum analyzer start frequency to the lower block edge frequency minus 300 kHz or 3 MHz, for frequencies below and above 1 GHz, respectively, and the stop frequency to the lower band or block edge frequency.
- q) Repeat steps k) to n).
- r) Repeat steps a) to q) with the signal generator configured for a single test signal tuned as close as possible to the block edges.
- s) Repeat steps a) to r) with the narrowband test signal.
- t) Repeat steps a) to s) for all authorized frequency bands or blocks used by the EUT.

3.6.3 Spurious emissions conducted measurements

- a) Connect a signal generator to the input of the EUT.
- b) Set the signal generator to produce the broadband test signal as previously described.
- c) Set the center frequency of the test signal to the lowest available channel within the frequency band or block.
- d) Set the EUT input power to a level that is just below the AGC threshold, but not more than 0.5 dB below.
- e) Connect a spectrum analyzer to the output of the EUT using appropriate attenuation as necessary.
- f) Set the RBW = reference bandwidth in the applicable rule section for the supported frequency band of operation.

- g) Set the VBW $\geq 3 \times$ RBW.
- h) Set the Sweep time = auto-couple.
- i) Set the spectrum analyzer start frequency to the lowest RF signal generated in the equipment, without going below 9 kHz, and the stop frequency to the lower band/block edge frequency minus 1 MHz.
The number of measurement points in each sweep must be $\geq (2 \times \text{span}/\text{RBW})$, which may require that the measurement range defined by the start and stop frequencies be subdivided, depending on the available number of measurement points provided by the spectrum analyzer.
- j) Select the power averaging (rms) detector function.
- k) Trace average at least 10 traces in power averaging (rms) mode.
- l) Use the peak marker function to identify the highest amplitude level over each measured frequency range. Record the frequency and amplitude and capture a plot for inclusion in the test report.
- m) Reset the spectrum analyzer start frequency to the upper band/block edge frequency plus 1 MHz, and the spectrum analyzer stop frequency to 10 times the highest frequency of the fundamental emission. The number of measurement points in each sweep must be $\geq (2 \times \text{span}/\text{RBW})$, which may require that the measurement range defined by the start and stop frequencies be subdivided, depending on the available number of measurement points provided by the spectrum analyzer.
- n) Trace average at least 10 traces in power averaging (rms) mode.
- o) Use the peak marker function to identify the highest amplitude level over each of the measured frequency ranges. Record the frequency and amplitude and capture a plot for inclusion in the test report; also provide tabular data, if required.
- p) Repeat steps i) to o) with the input test signals firstly tuned to a middle band/block frequency/channel, and then tuned to a high band/block frequency/channel.
- q) Repeat steps b) to p) with the narrowband test signal.
- r) Repeat steps b) to q) for all authorized frequency bands/blocks used by the EUT.

Note:

(1) In some bands, RBW was reduced to 0.1 %, 1 %, and 10 % of the reference bandwidth for measuring out-of-band and unwanted spurious emissions level, so the limit lines were compensated according to section 5.7.2 of ANSI C63.26-2015.

Reduced RBW	0.1 %	1 %	10 %
Limit line compensation	-30 dB	-20 dB	-10 dB

(2) All power supplies of operation were investigated and the worst case configuration results are reported.

- Mode: 100~240 VAC, 50/60 Hz / 36~76 VDC
- Worst case: 100~240 VAC, 50/60 Hz

Test Results: Plot data of Out-of-band/out-of-block emissions

Out-of-band (two adjacent test signals) / 3.45 GHz Service / Downlink / 5G NR 20 MHz / Lower



Out-of-band (two adjacent test signals) / 3.45 GHz Service / Downlink / 5G NR 20 MHz / Upper

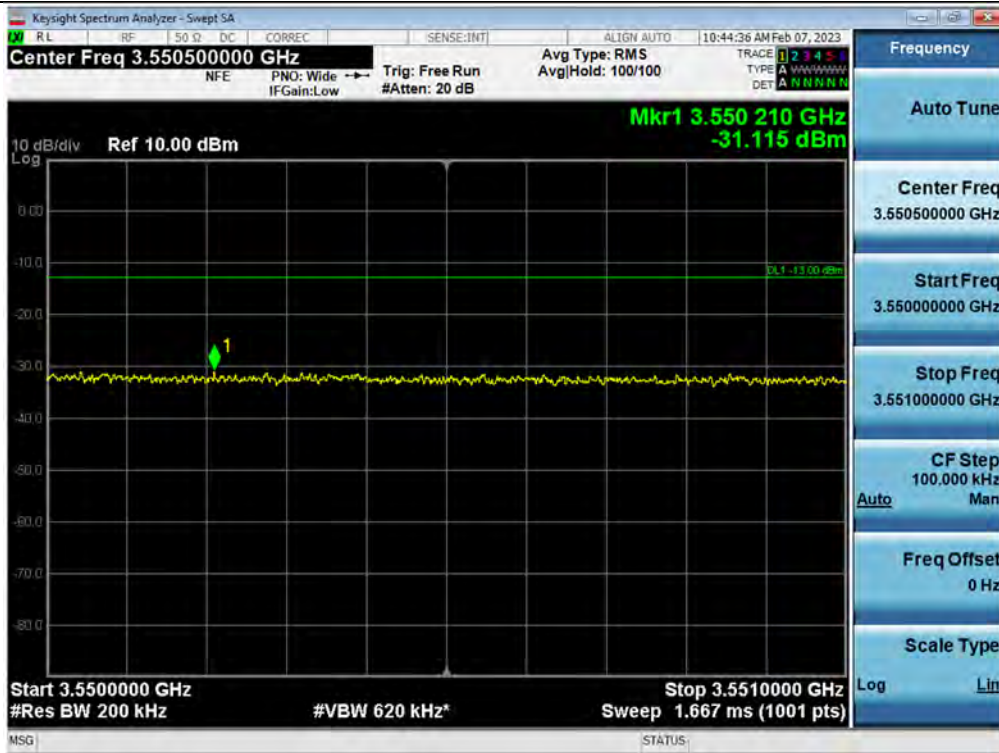

3 dB above Out-of-band (two adjacent test signals) / 3.45 GHz Service / Downlink / 5G NR 20 MHz / Lower

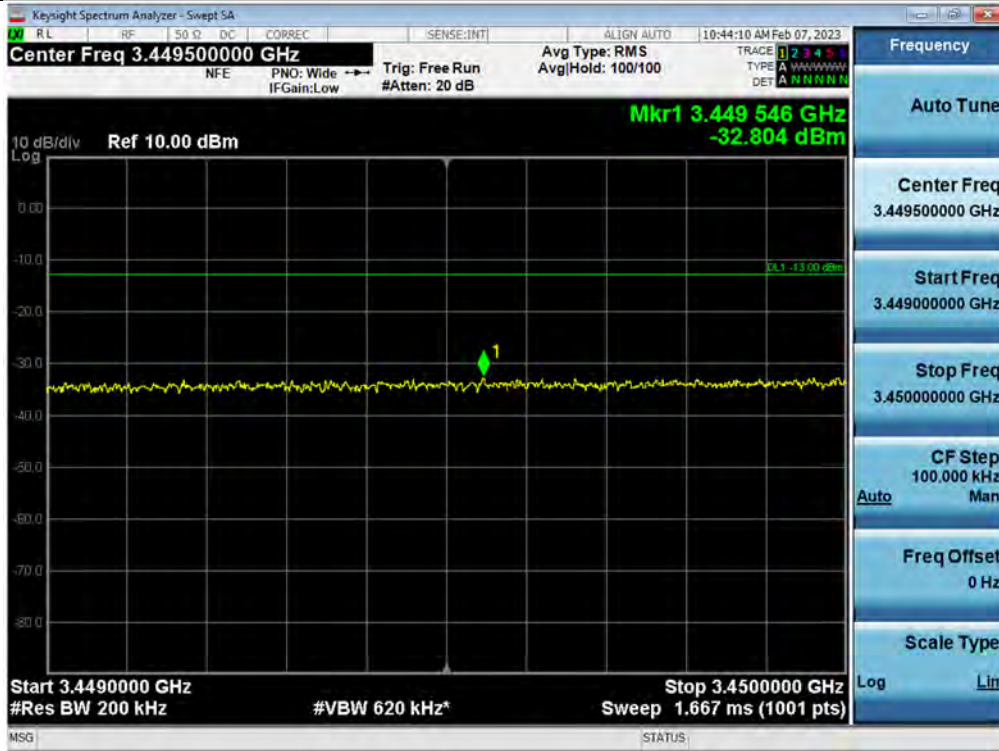

3 dB above Out-of-band (two adjacent test signals) / 3.45 GHz Service / Downlink / 5G NR 20 MHz / Upper

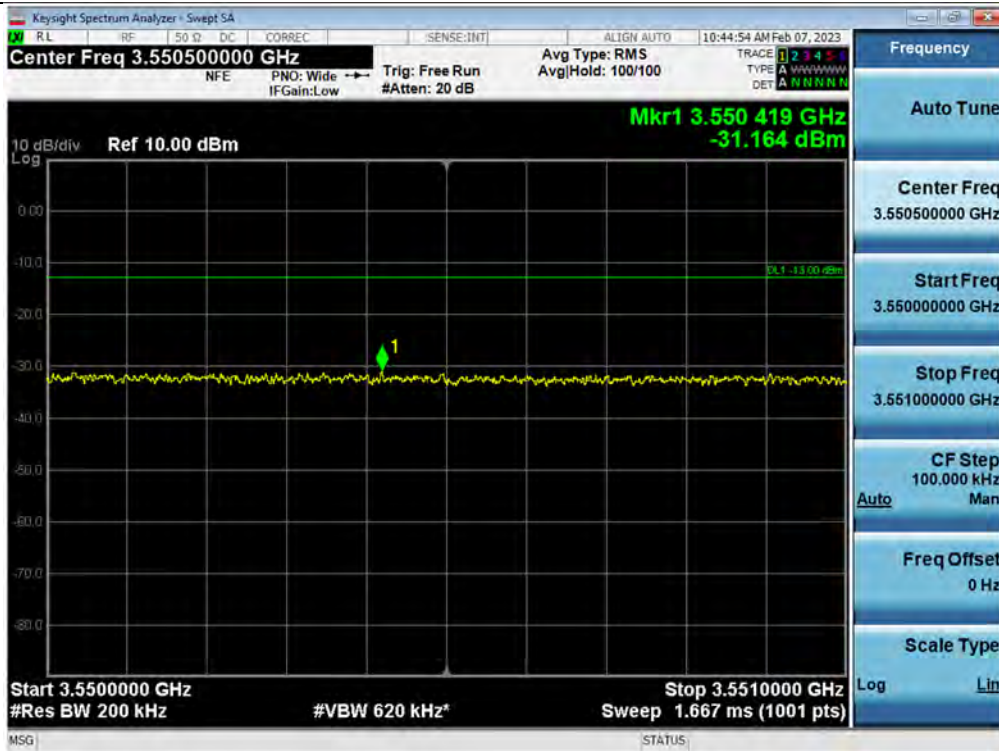

Out-of-band (two adjacent test signals) / 3.45 GHz Service / Downlink / 5G NR 40 MHz / Lower

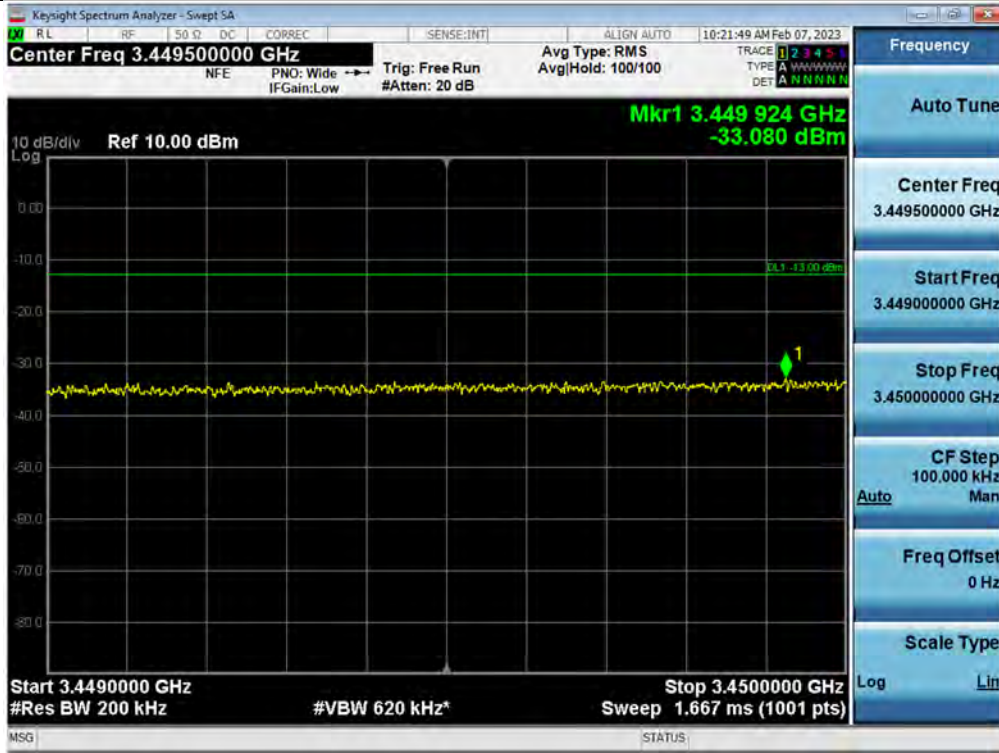

Out-of-band (two adjacent test signals) / 3.45 GHz Service / Downlink / 5G NR 40 MHz / Upper

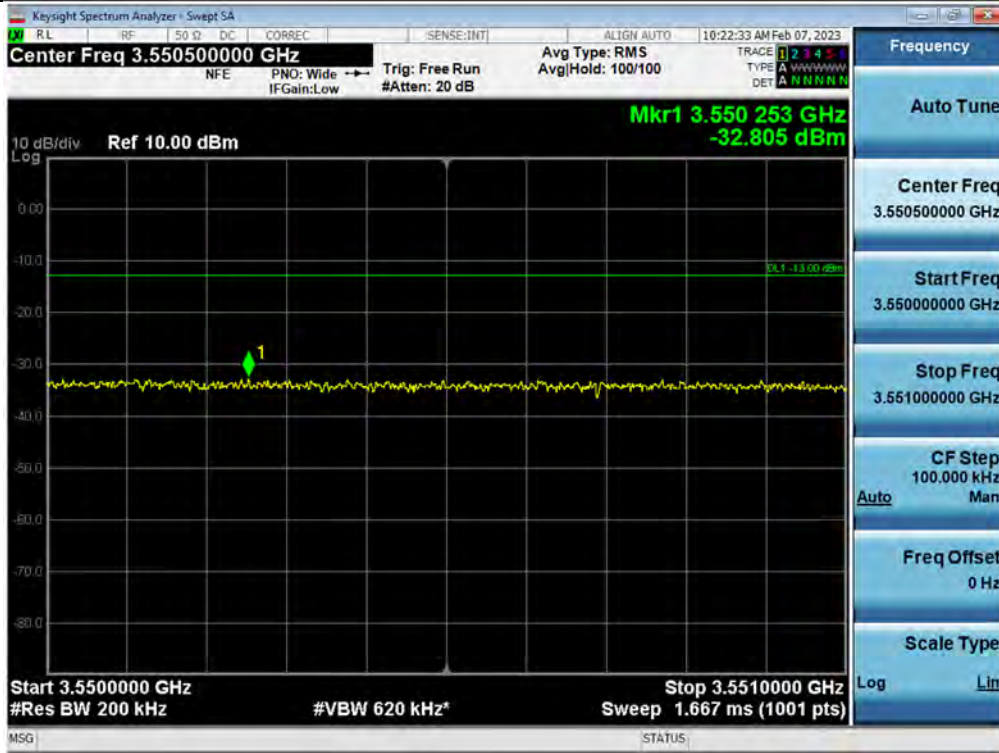

3 dB above Out-of-band (two adjacent test signals) / 3.45 GHz Service / Downlink / 5G NR 40 MHz / Lower

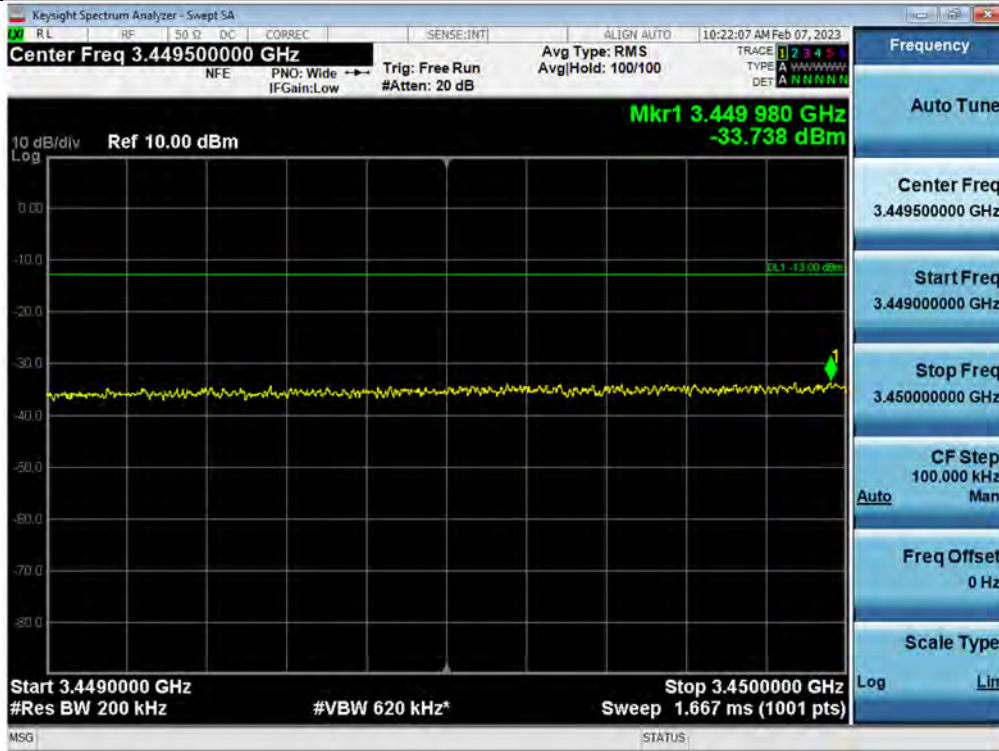

3 dB above Out-of-band (two adjacent test signals) / 3.45 GHz Service / Downlink / 5G NR 40 MHz / Upper

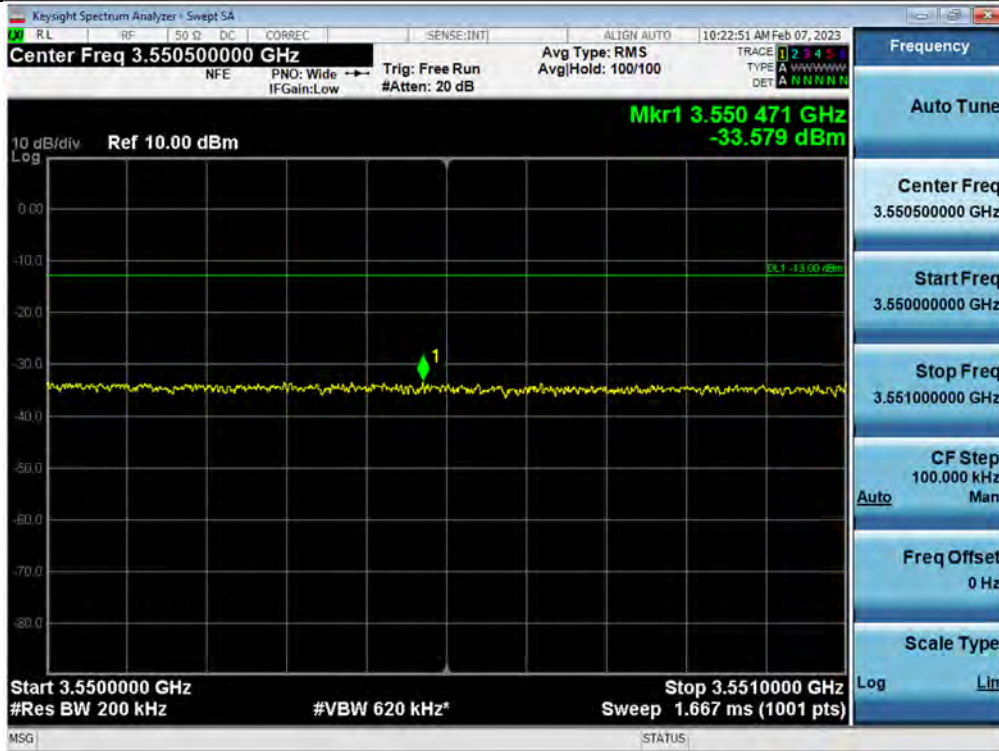

Out-of-band (single test signal) / 3.45 GHz Service / Downlink / 5G NR 20 MHz / Low / Lower

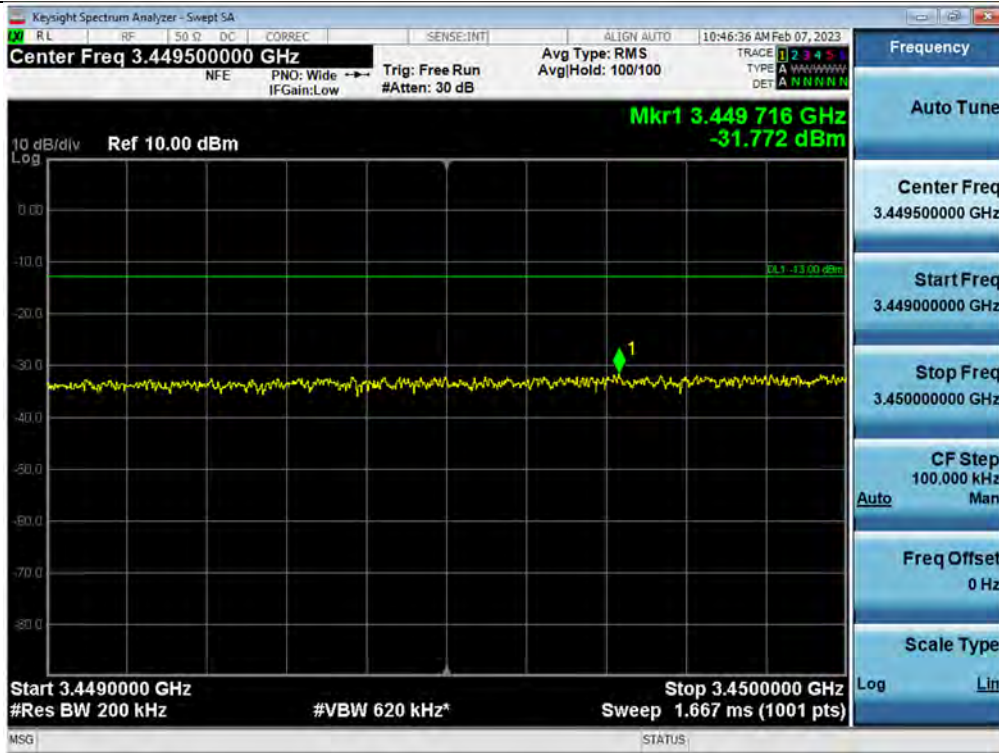

Out-of-band (single test signal) / 3.45 GHz Service / Downlink / 5G NR 20 MHz / Low / Upper

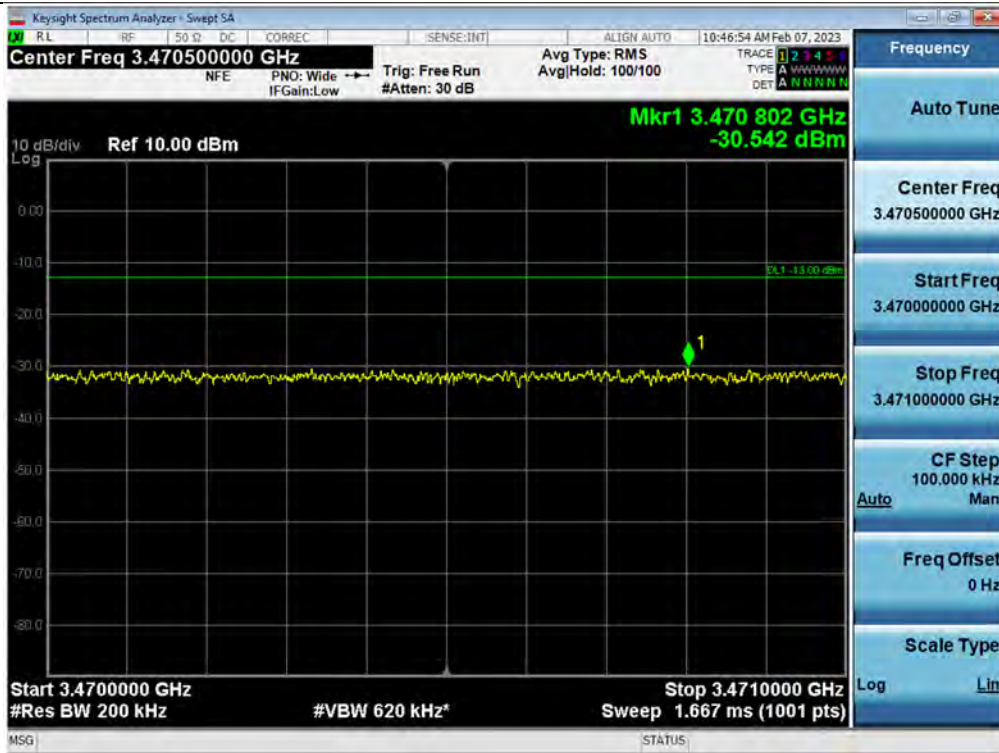

Out-of-band (single test signal) / 3.45 GHz Service / Downlink / 5G NR 20 MHz / Middle / Lower

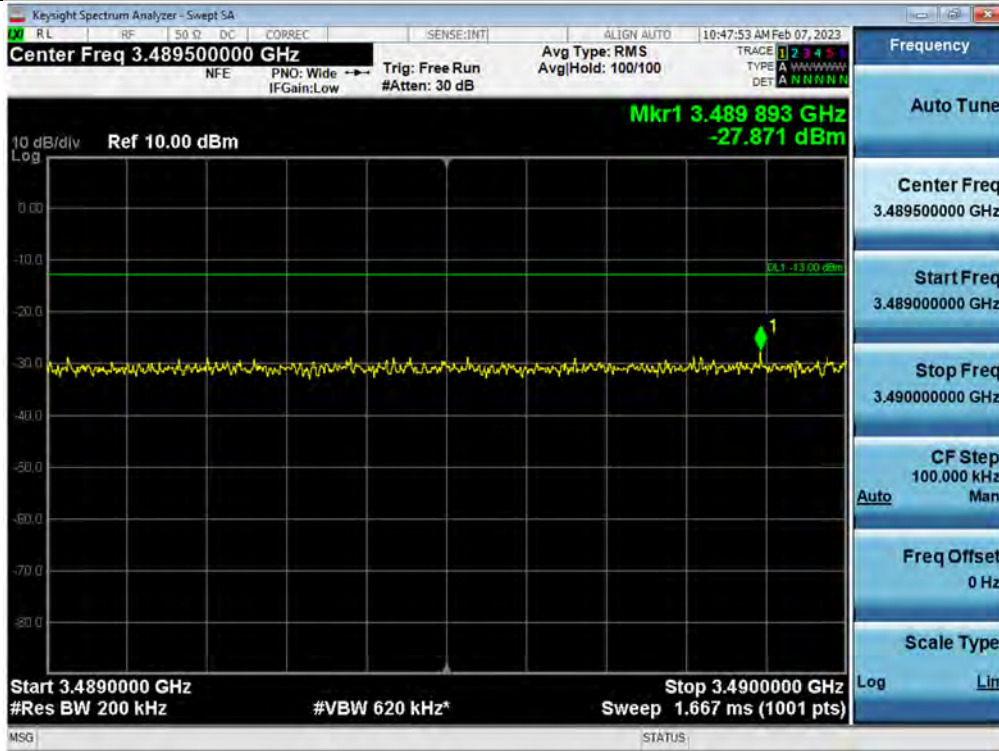

Out-of-band (single test signal) / 3.45 GHz Service / Downlink / 5G NR 20 MHz / Middle / Upper

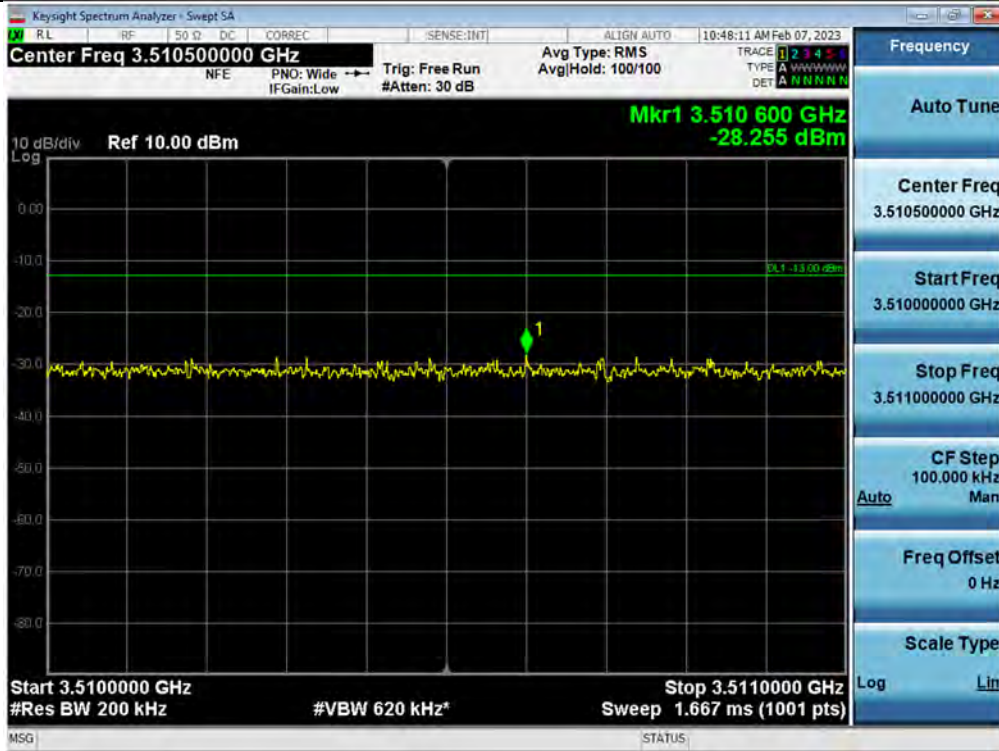

Out-of-band (single test signal) / 3.45 GHz Service / Downlink / 5G NR 20 MHz / High / Lower

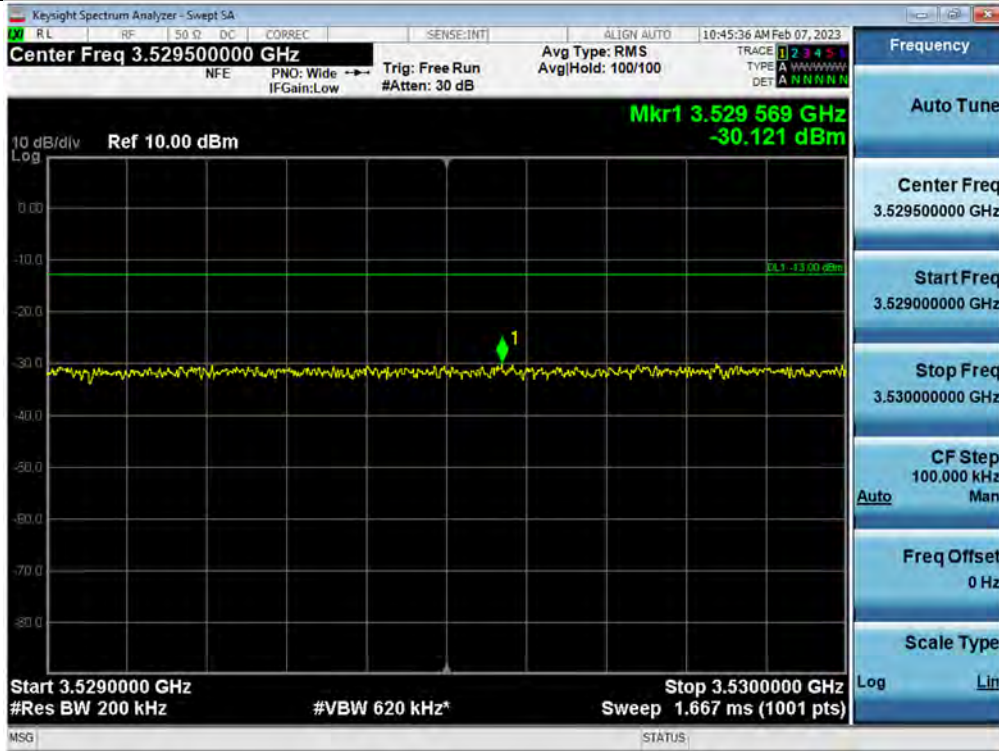

Out-of-band (single test signal) / 3.45 GHz Service / Downlink / 5G NR 20 MHz / High / Upper

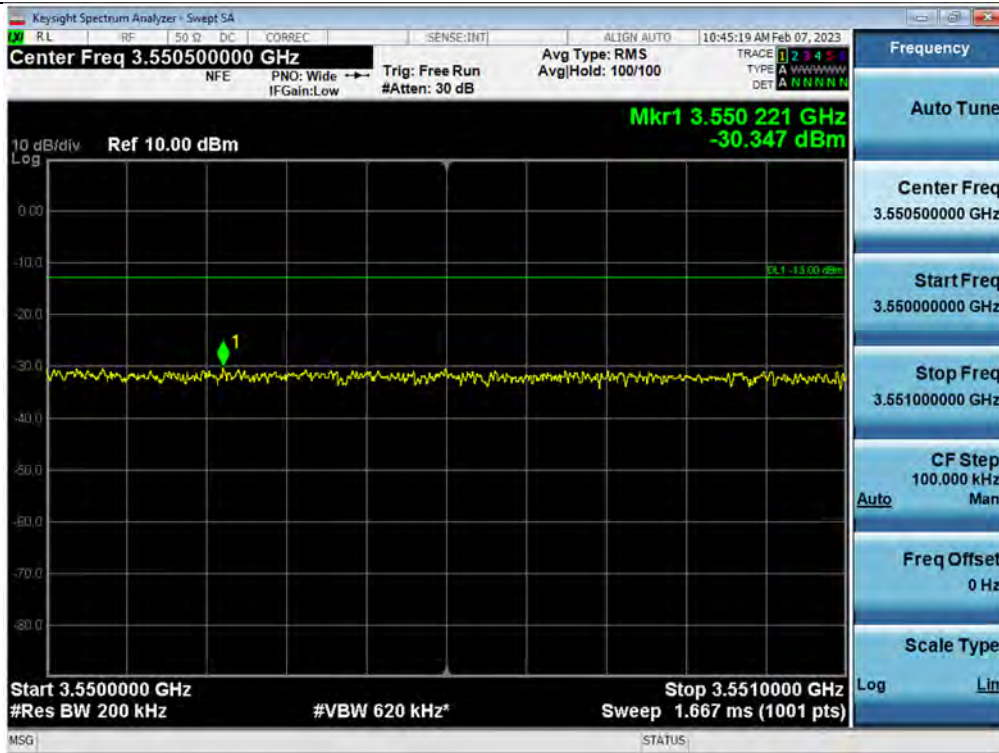

+3 dB above Out-of-band (single test signal) / 3.45 GHz Service / Downlink / 5G NR 20 MHz / Low / Lower

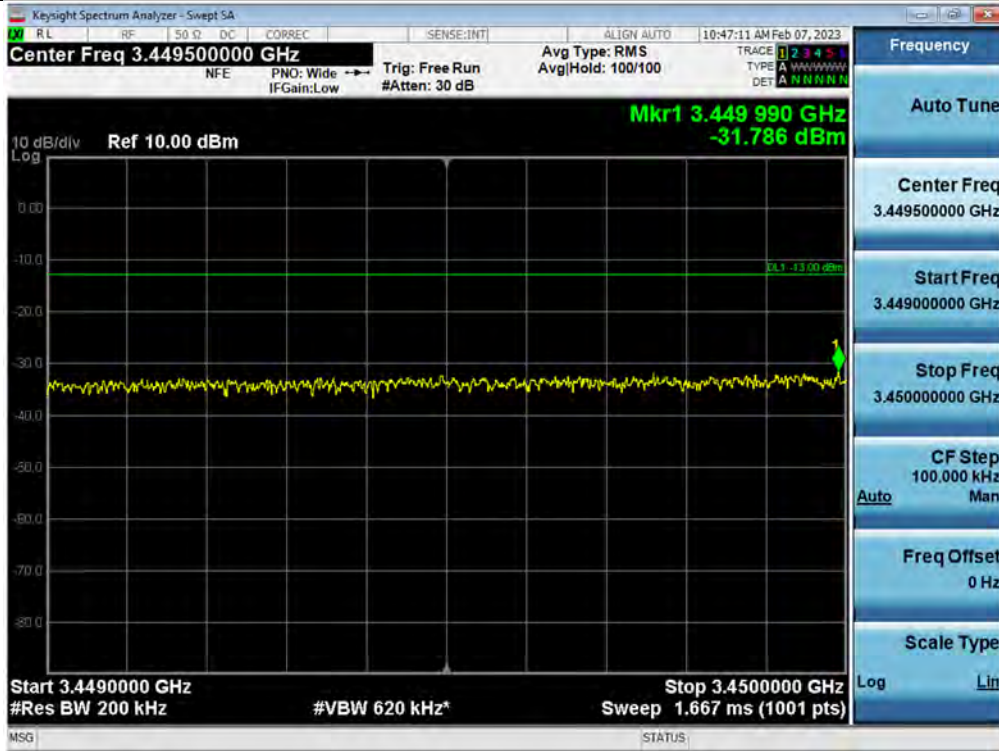

+3 dB above Out-of-band (single test signal) / 3.45 GHz Service / Downlink / 5G NR 20 MHz / Low / Upper

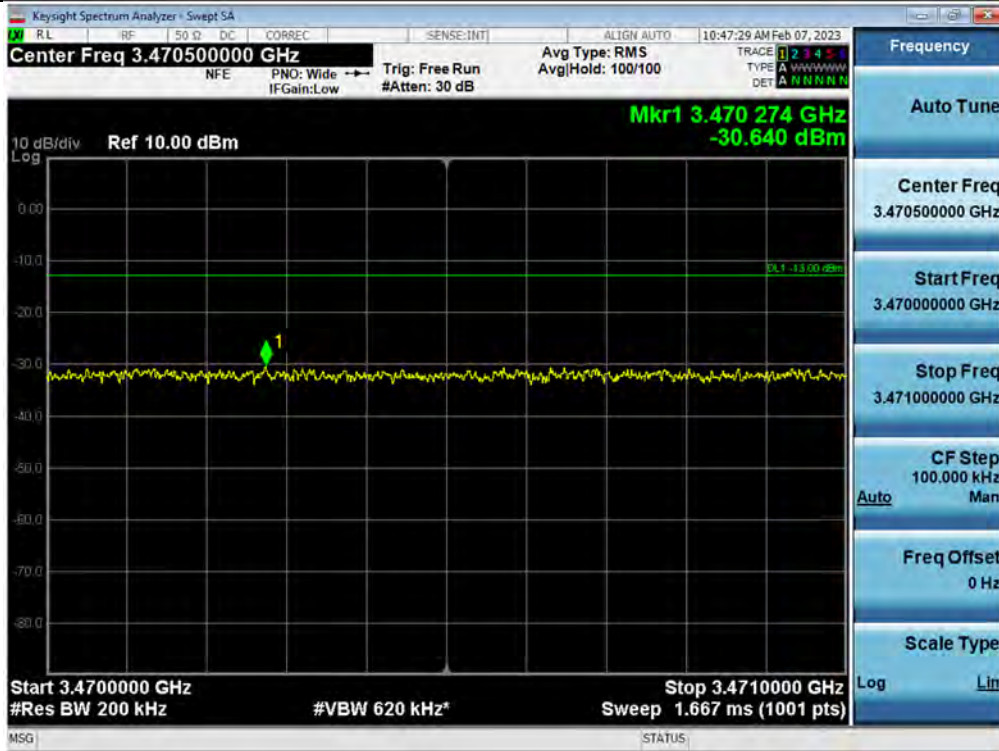

+3 dB above Out-of-band (single test signal) / 3.45 GHz Service / Downlink / 5G NR 20 MHz / Middle / Lower

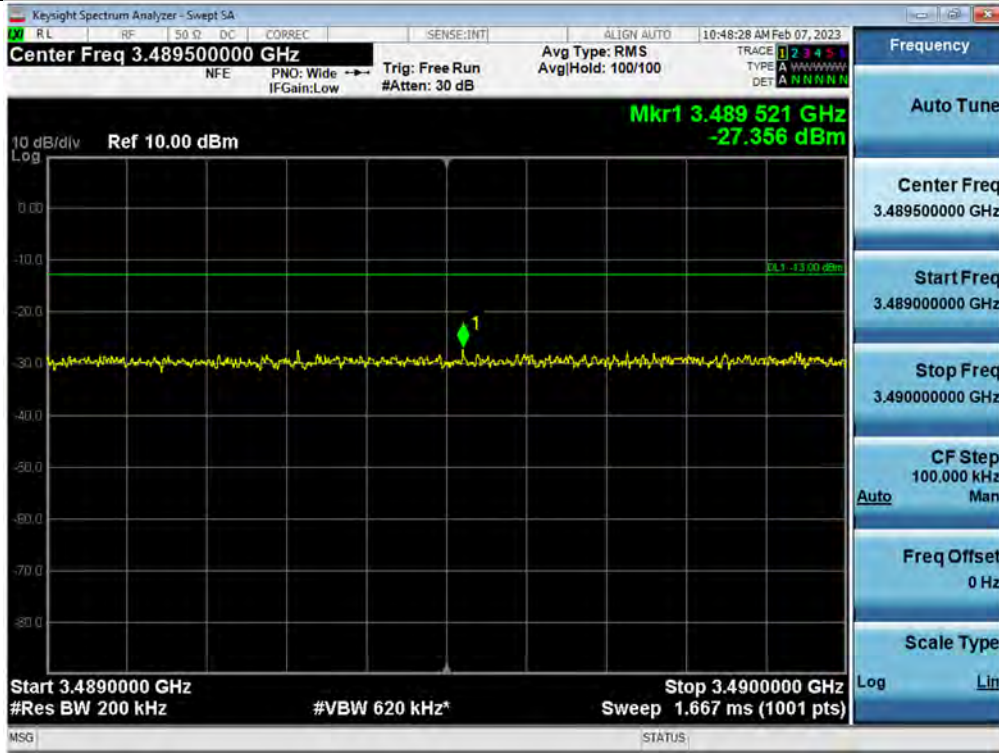

+3 dB above Out-of-band (single test signal) / 3.45 GHz Service / Downlink / 5G NR 20 MHz / Middle / Upper

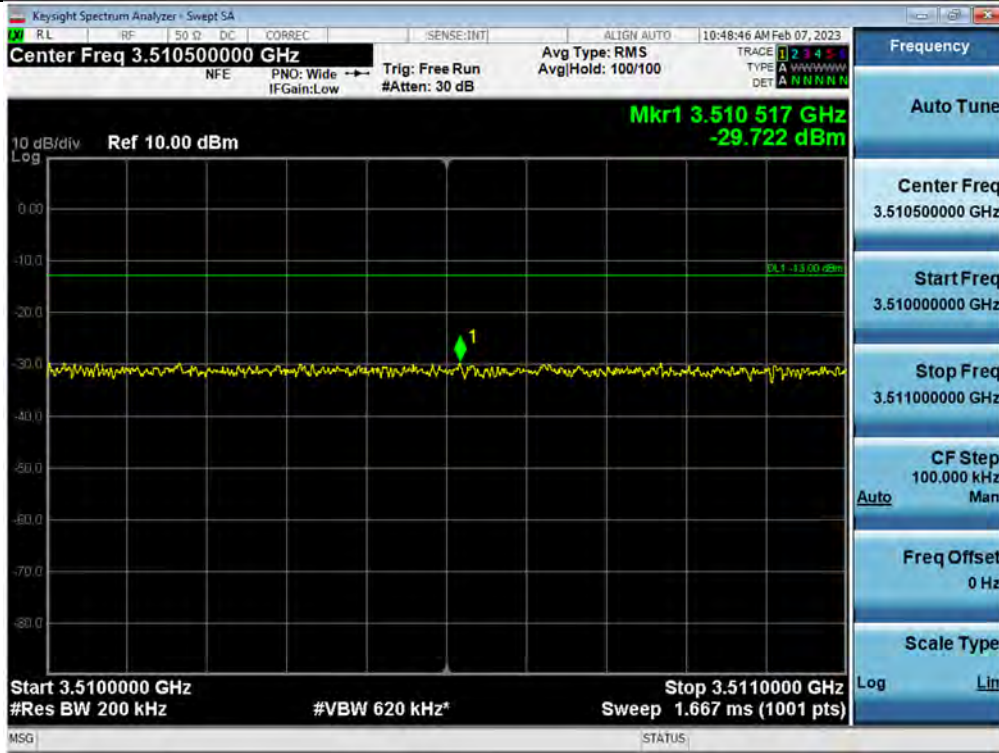

+3 dB above Out-of-band (single test signal) / 3.45 GHz Service / Downlink / 5G NR 20 MHz / High / Lower

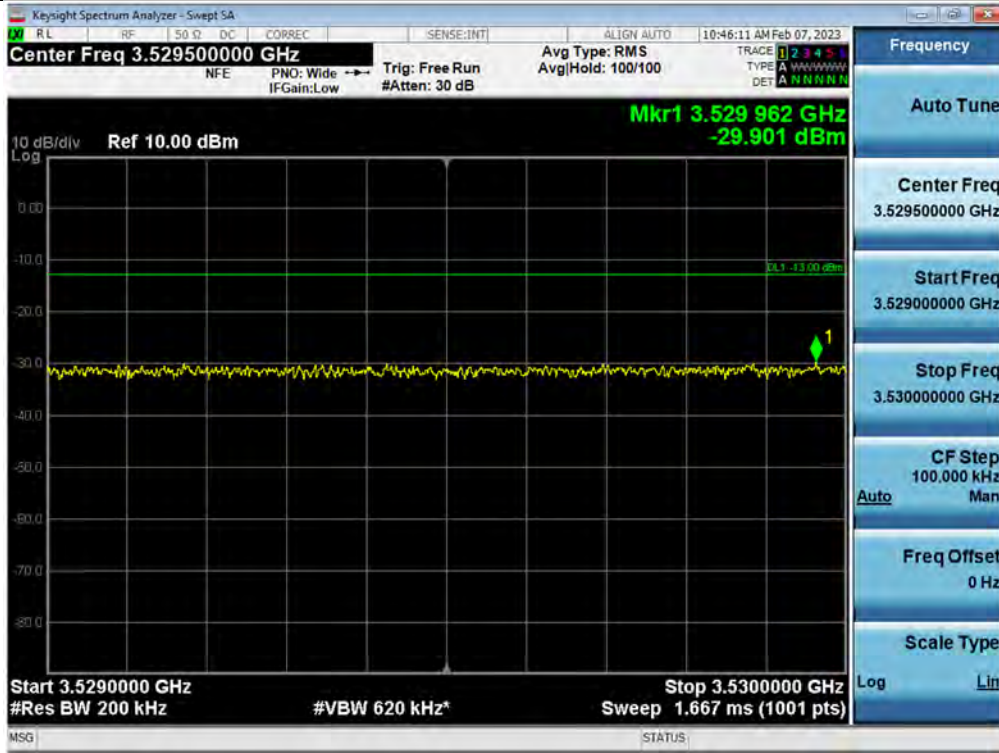

+3 dB above Out-of-band (single test signal) / 3.45 GHz Service / Downlink / 5G NR 20 MHz / High / Upper

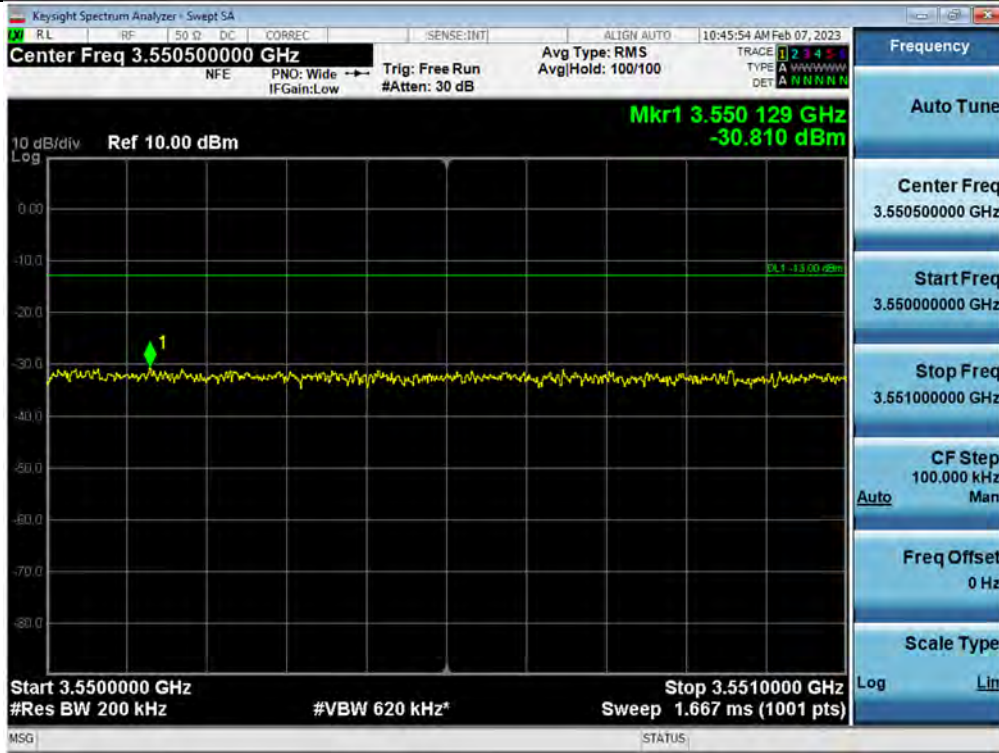

Out-of-band (single test signal) / 3.45 GHz Service / Downlink / 5G NR 40 MHz / Low / Lower

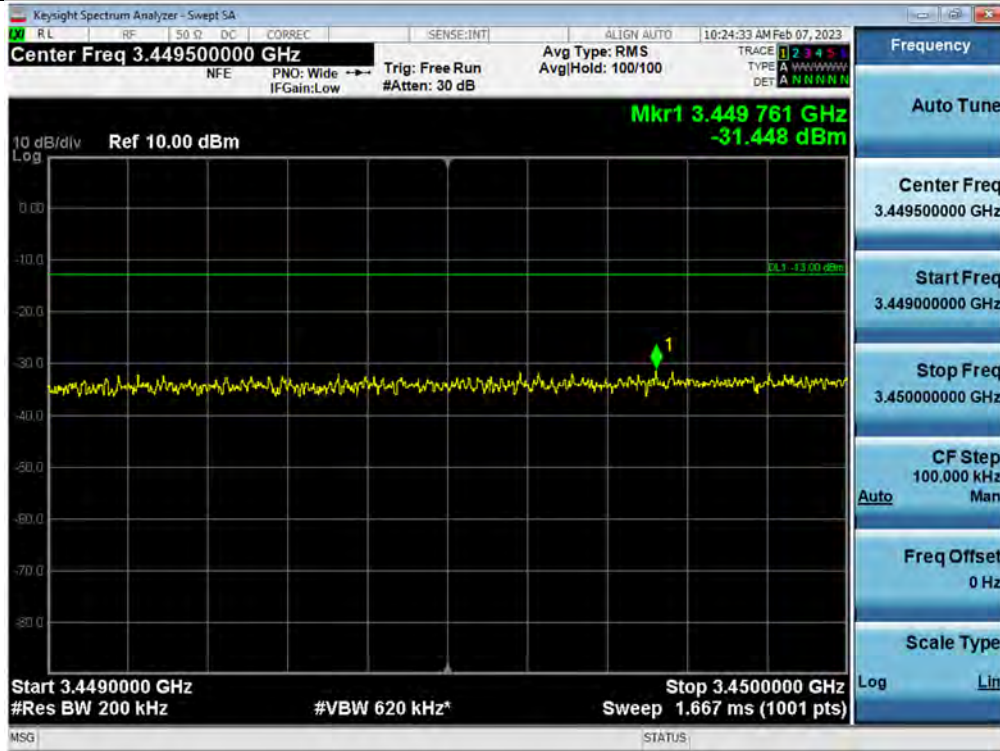

Out-of-band (single test signal) / 3.45 GHz Service / Downlink / 5G NR 40 MHz / Low / Upper

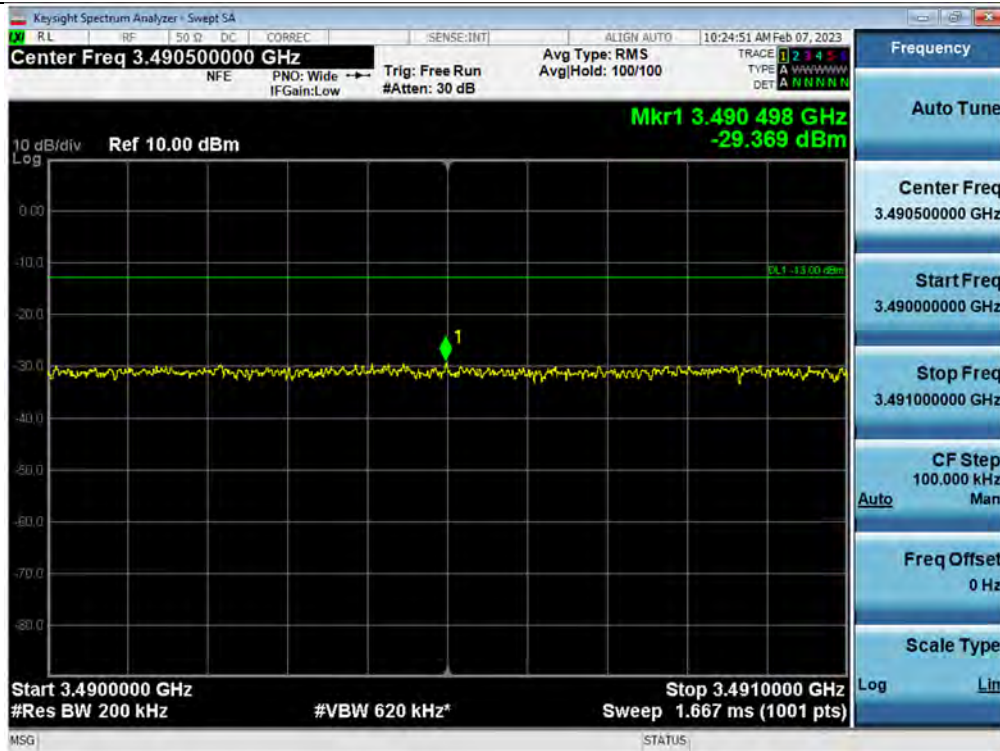

Out-of-band (single test signal) / 3.45 GHz Service / Downlink / 5G NR 40 MHz / Middle / Lower

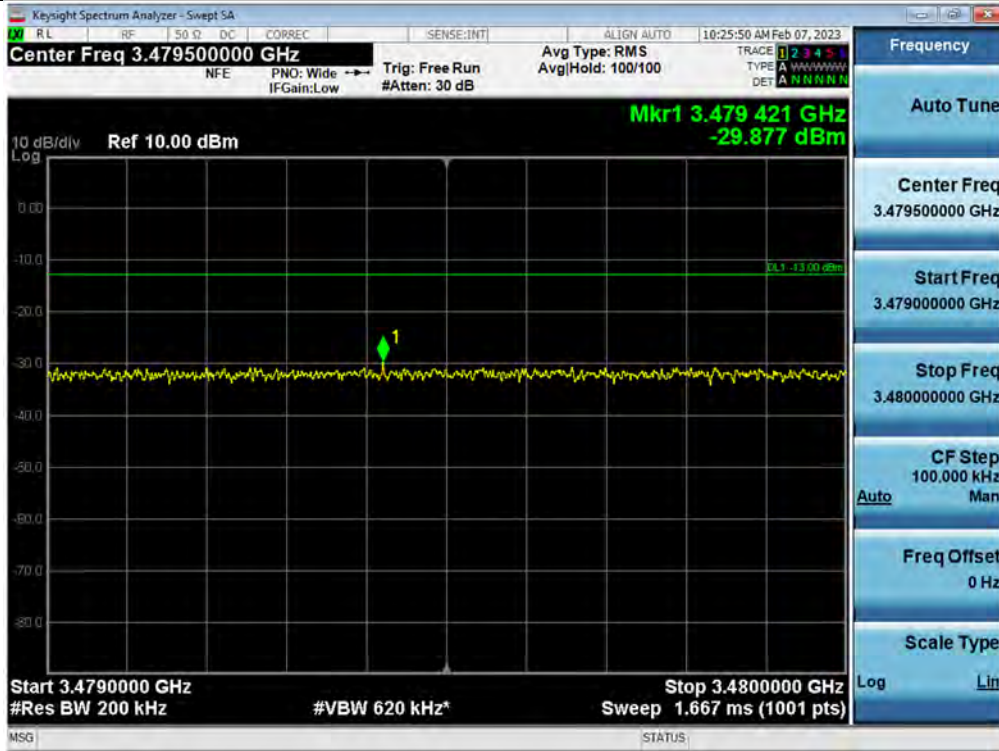

Out-of-band (single test signal) / 3.45 GHz Service / Downlink / 5G NR 40 MHz / Middle / Upper

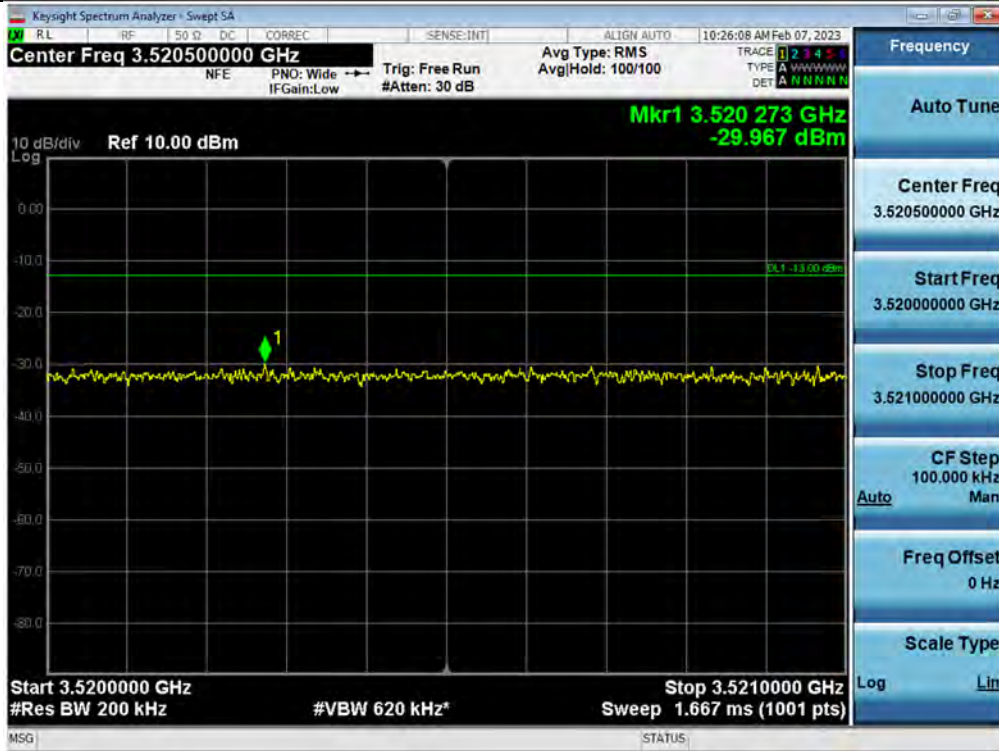

Out-of-band (single test signal) / 3.45 GHz Service / Downlink / 5G NR 40 MHz / High / Lower

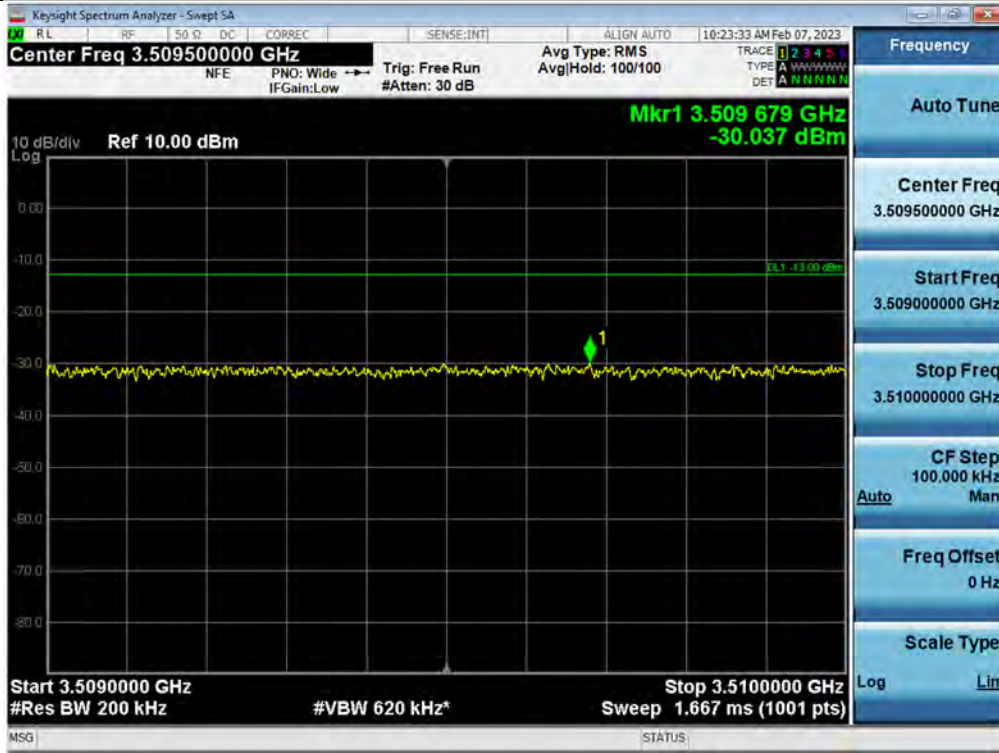

Out-of-band (single test signal) / 3.45 GHz Service / Downlink / 5G NR 40 MHz / High / Upper

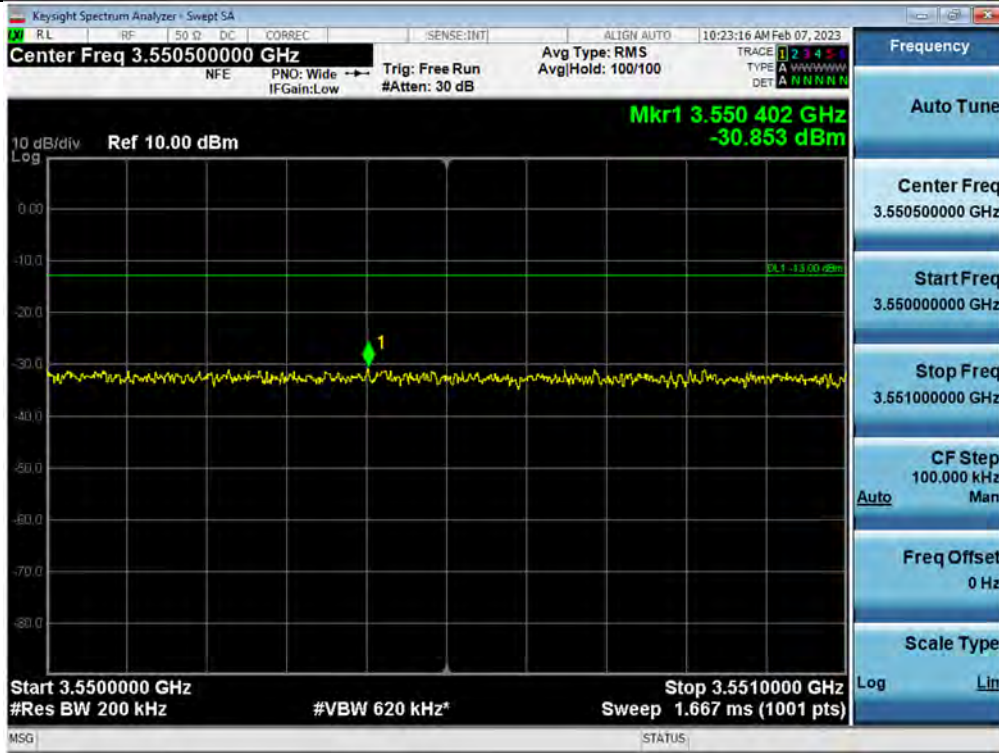

+3 dB above Out-of-band (single test signal) / 3.45 GHz Service / Downlink / 5G NR 40 MHz / Low / Lower

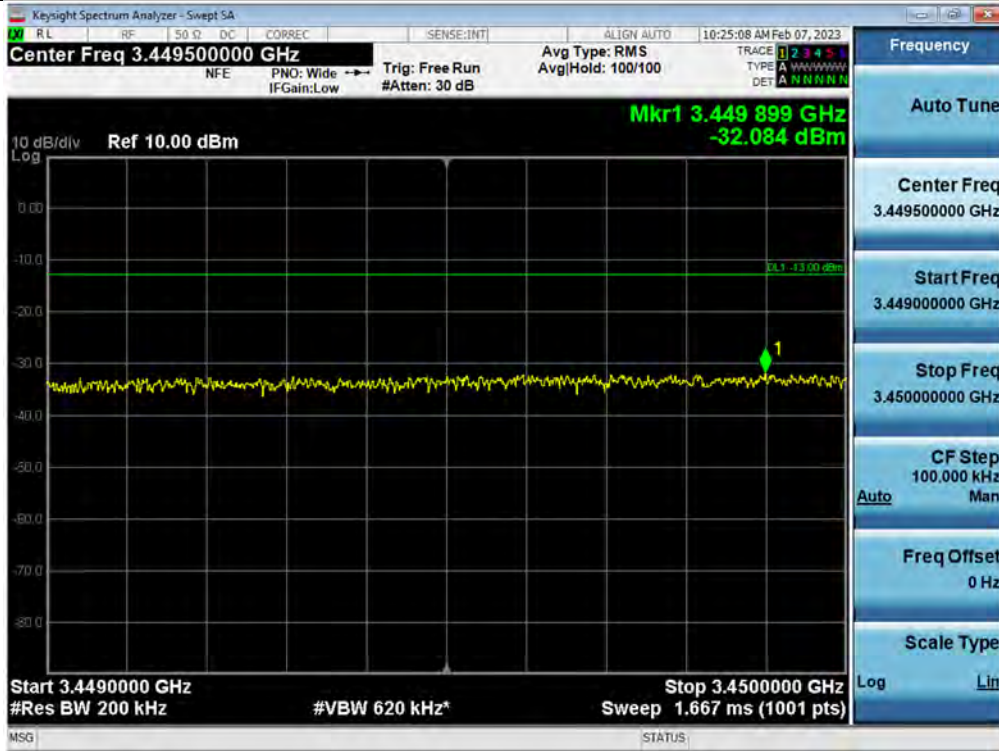

+3 dB above Out-of-band (single test signal) / 3.45 GHz Service / Downlink / 5G NR 40 MHz / Low / Upper

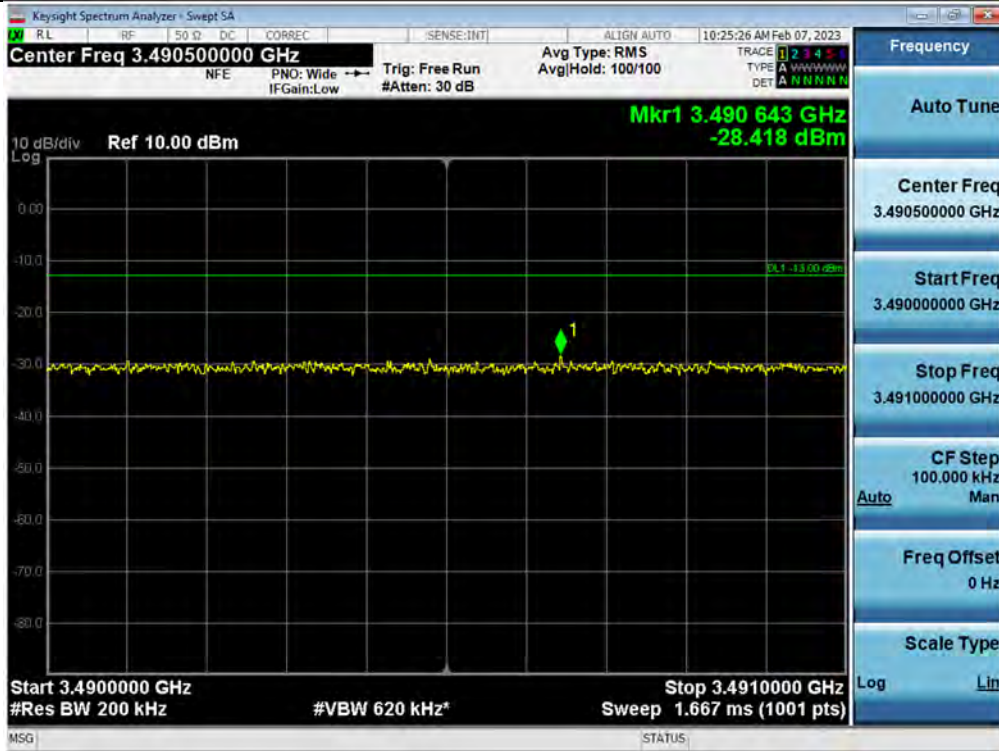

+3 dB above Out-of-band (single test signal) / 3.45 GHz Service / Downlink / 5G NR 40 MHz / Middle / Lower

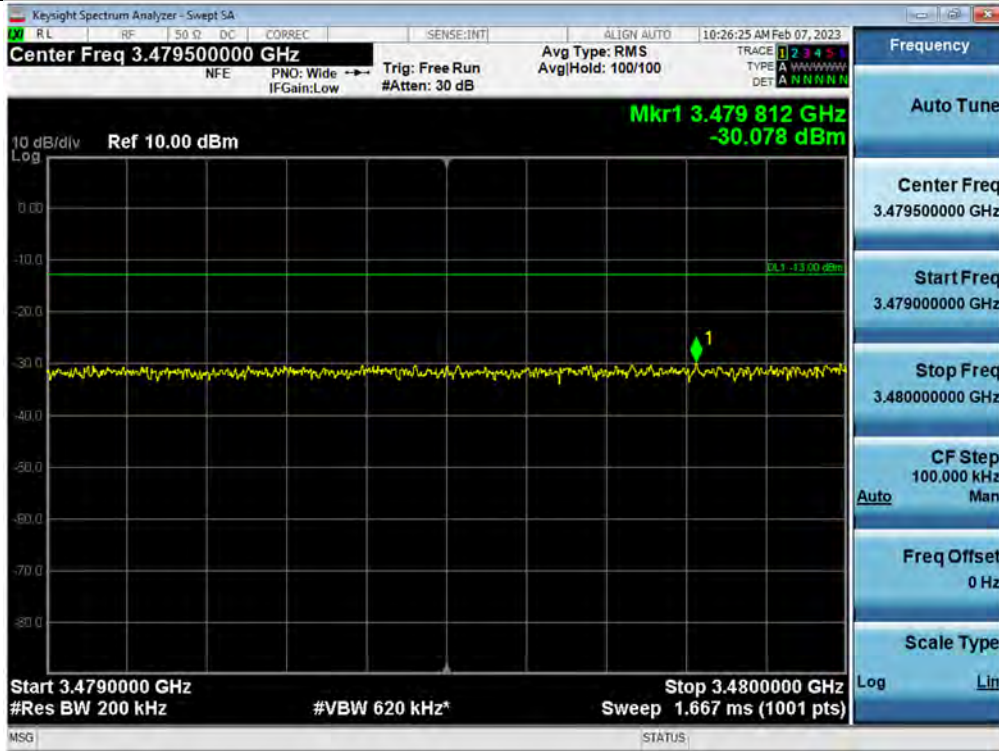

+3 dB above Out-of-band (single test signal) / 3.45 GHz Service / Downlink / 5G NR 40 MHz / Middle / Upper

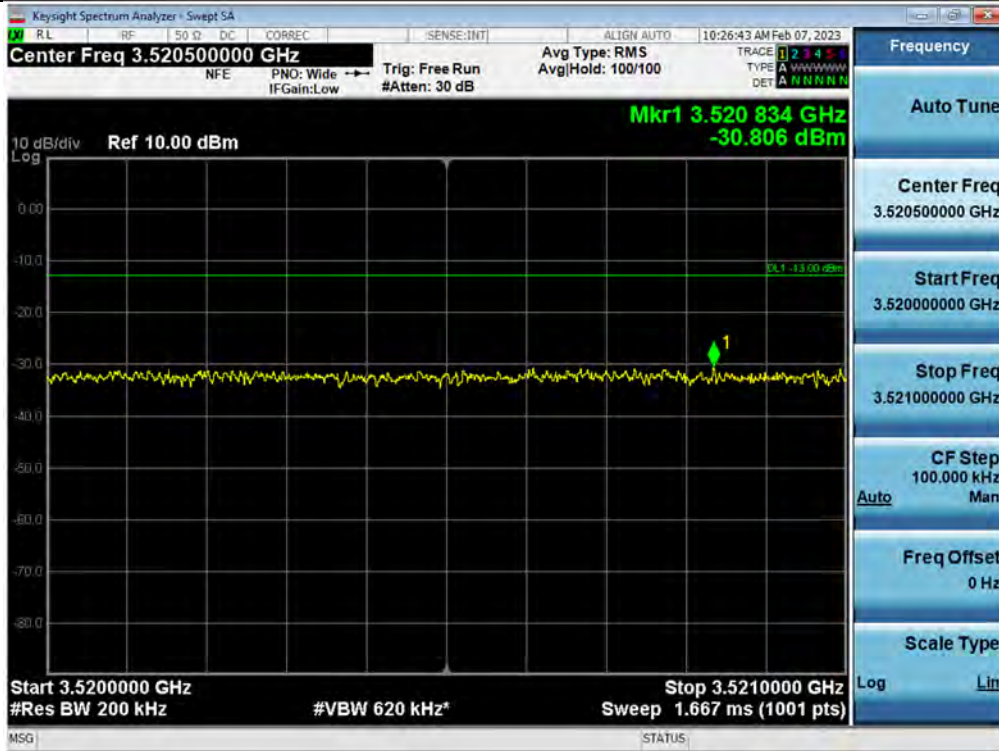

+3 dB above Out-of-band (single test signal) / 3.45 GHz Service / Downlink / 5G NR 40 MHz / High / Lower

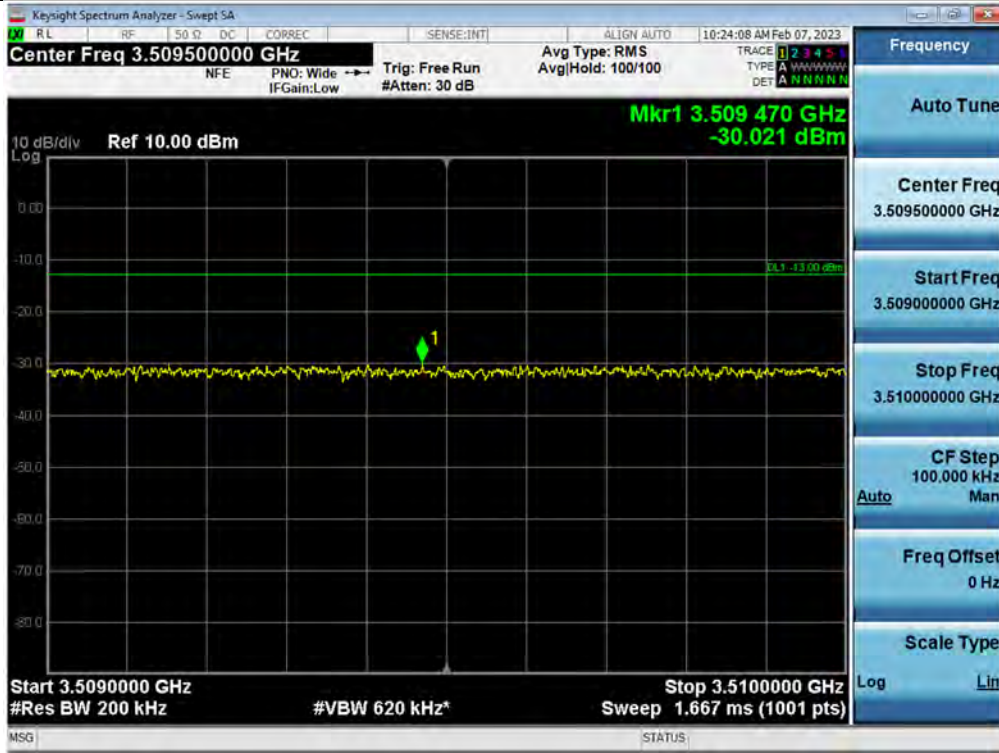

+3 dB above Out-of-band (single test signal) / 3.45 GHz Service / Downlink / 5G NR 40 MHz / High / Upper

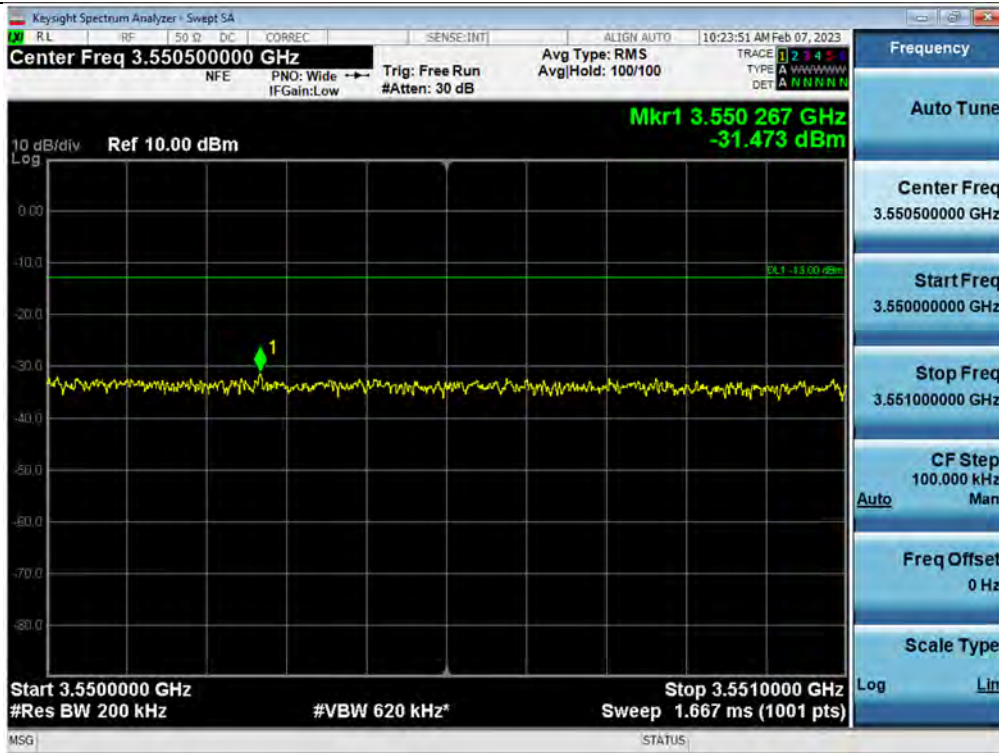

Out-of-band (single test signal) / 3.45 GHz Service / Downlink / 5G NR 60 MHz / Low / Lower

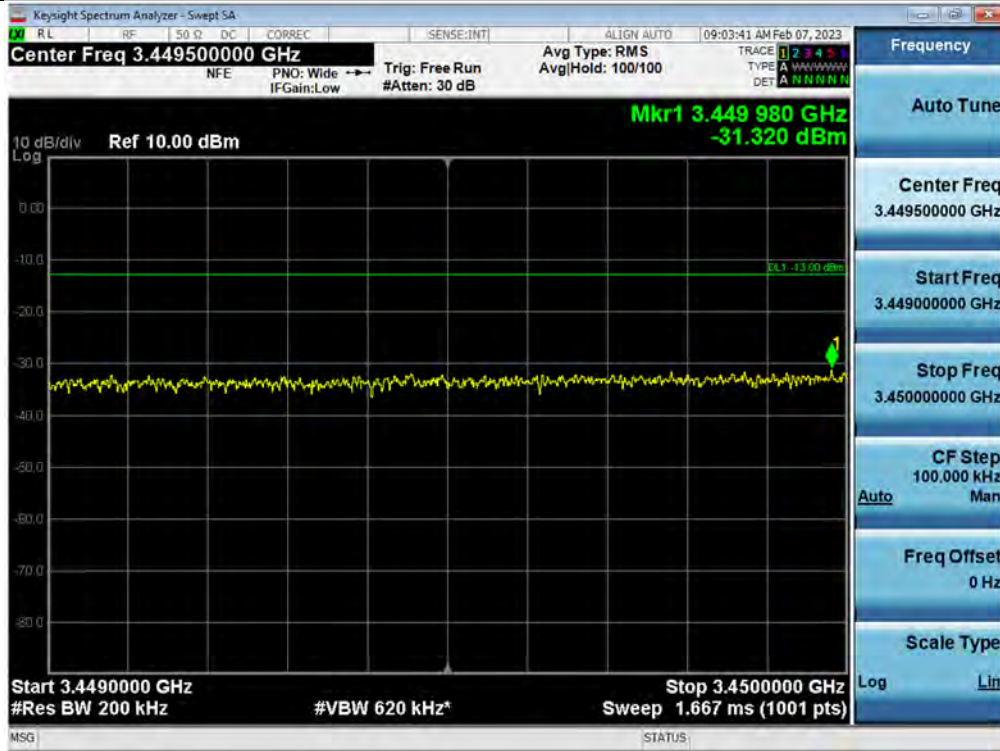

Out-of-band (single test signal) / 3.45 GHz Service / Downlink / 5G NR 60 MHz / Low / Upper

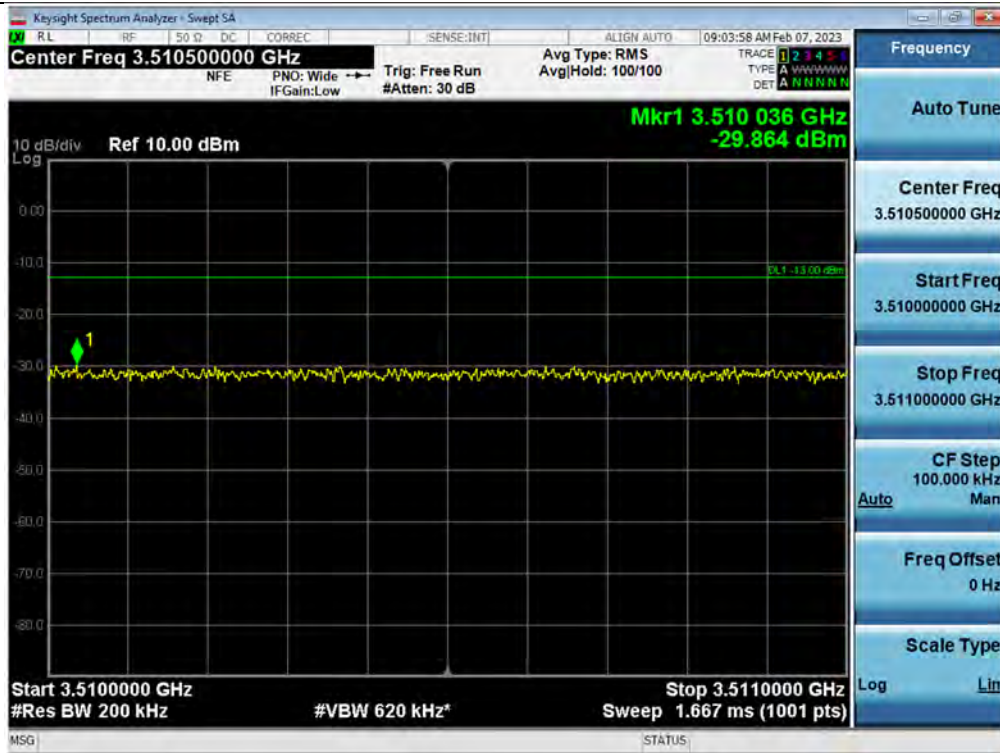

Out-of-band (single test signal) / 3.45 GHz Service / Downlink / 5G NR 60 MHz / Middle / Lower

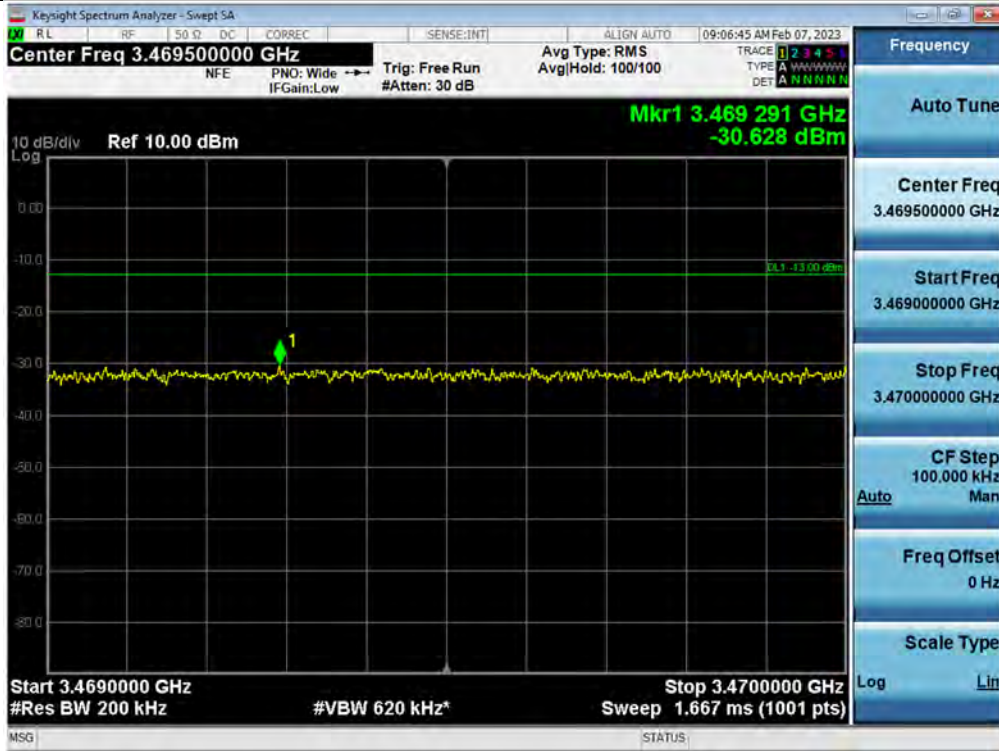

Out-of-band (single test signal) / 3.45 GHz Service / Downlink / 5G NR 60 MHz / Middle / Upper

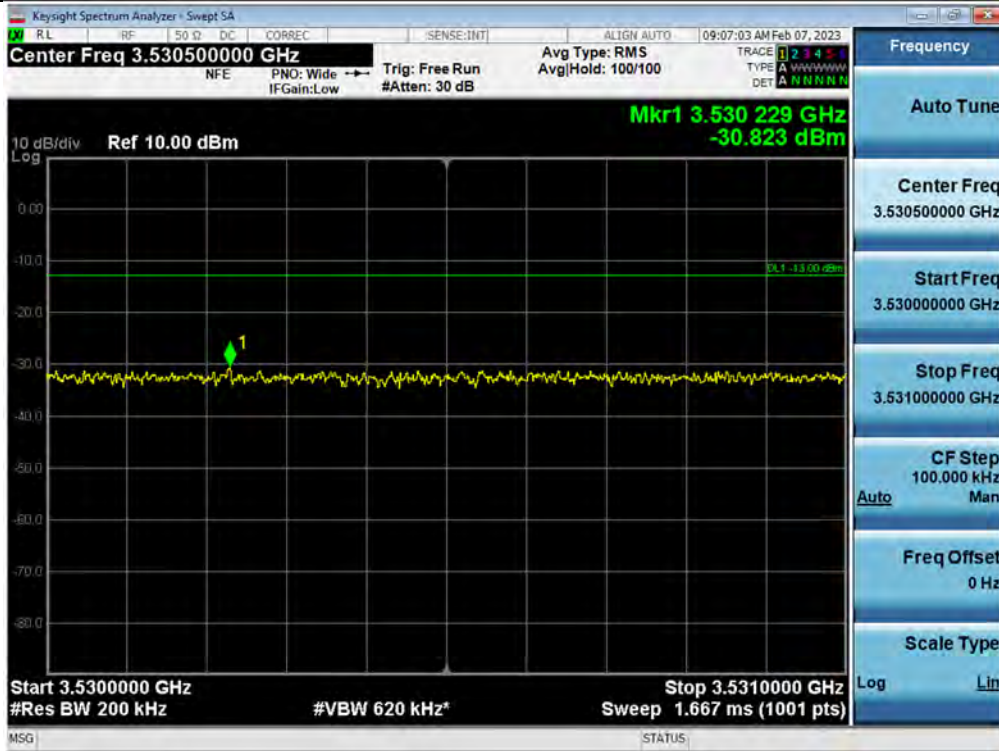

Out-of-band (single test signal) / 3.45 GHz Service / Downlink / 5G NR 60 MHz / High / Lower

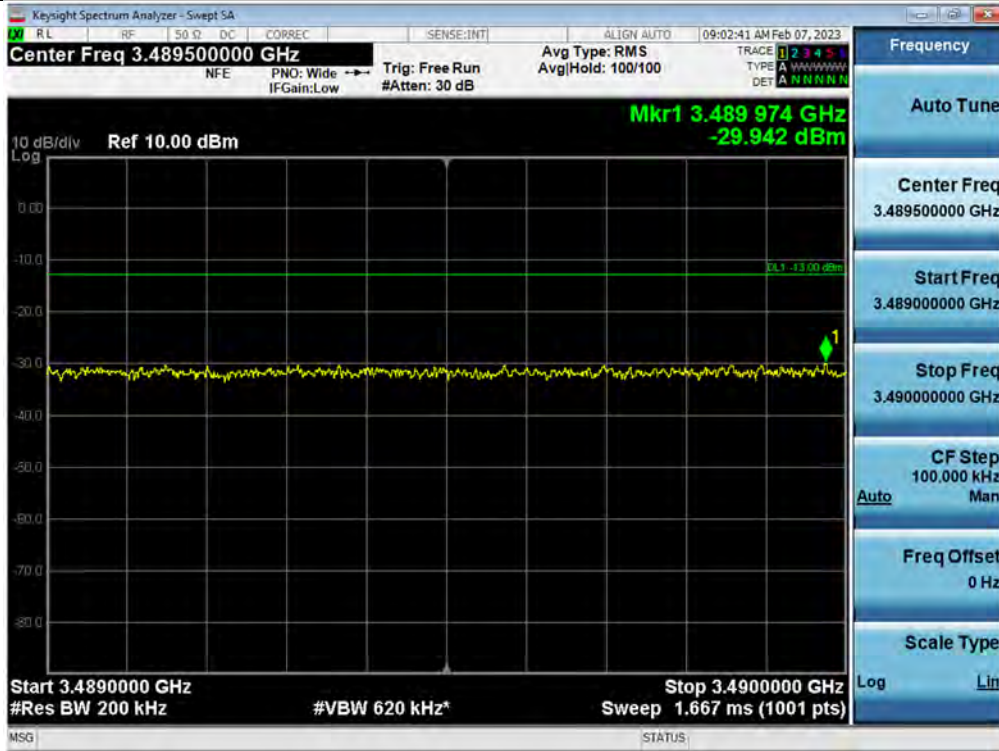

Out-of-band (single test signal) / 3.45 GHz Service / Downlink / 5G NR 60 MHz / High / Upper

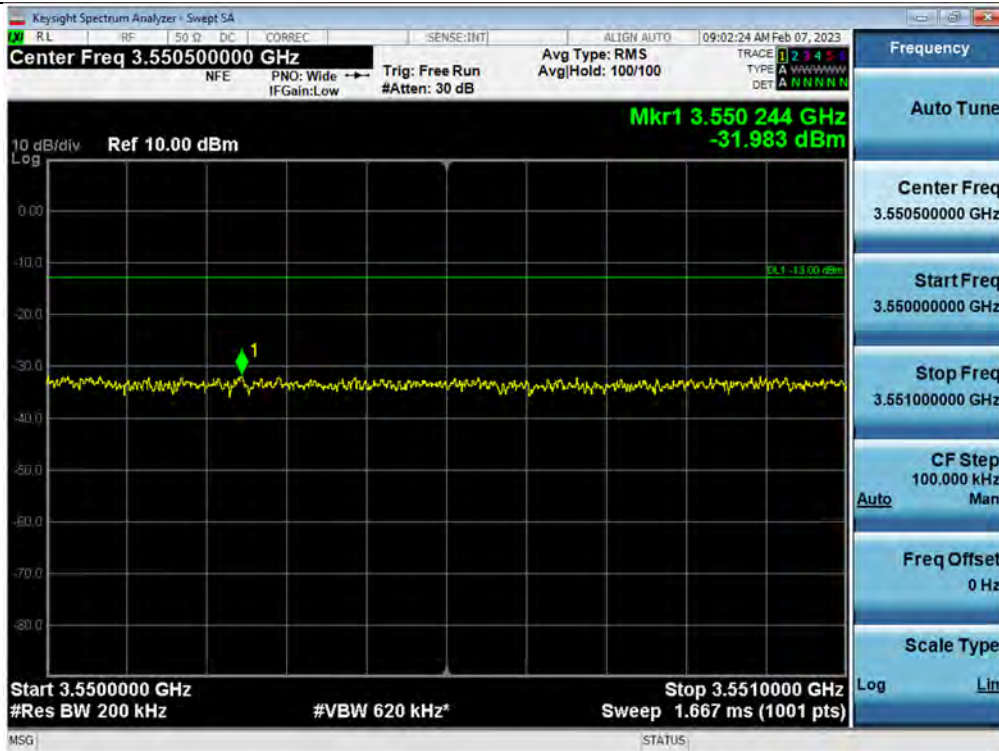

+3 dB above Out-of-band (single test signal) / 3.45 GHz Service / Downlink / 5G NR 60 MHz / Low / Lower

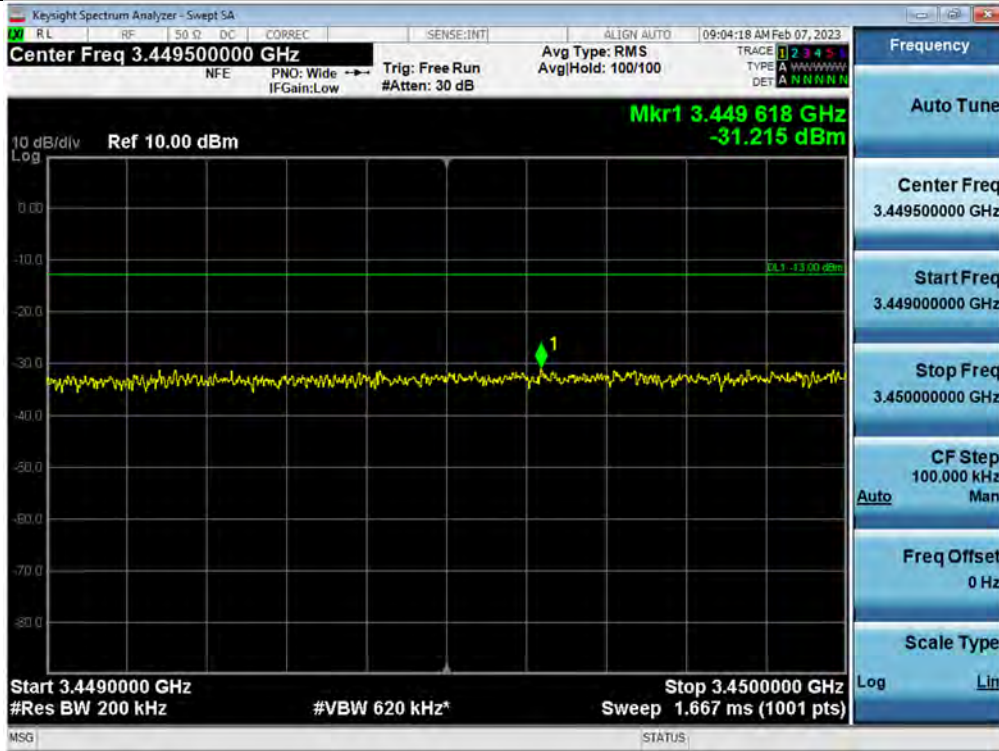

+3 dB above Out-of-band (single test signal) / 3.45 GHz Service / Downlink / 5G NR 60 MHz / Low / Upper

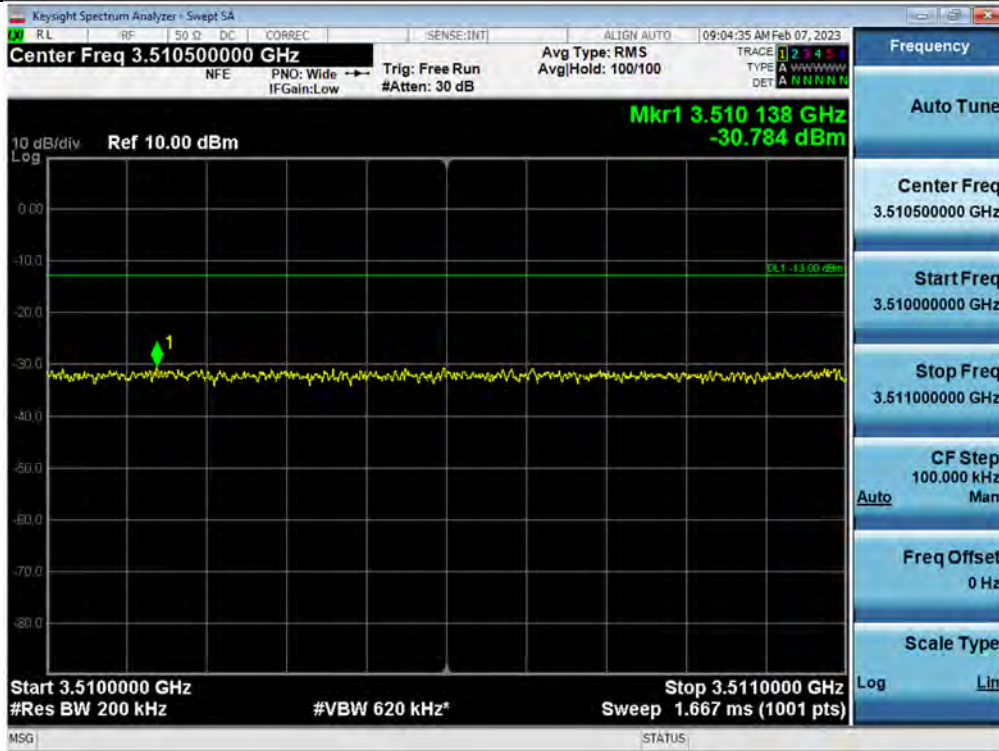

+3 dB above Out-of-band (single test signal) / 3.45 GHz Service / Downlink / 5G NR 60 MHz / Middle / Lower

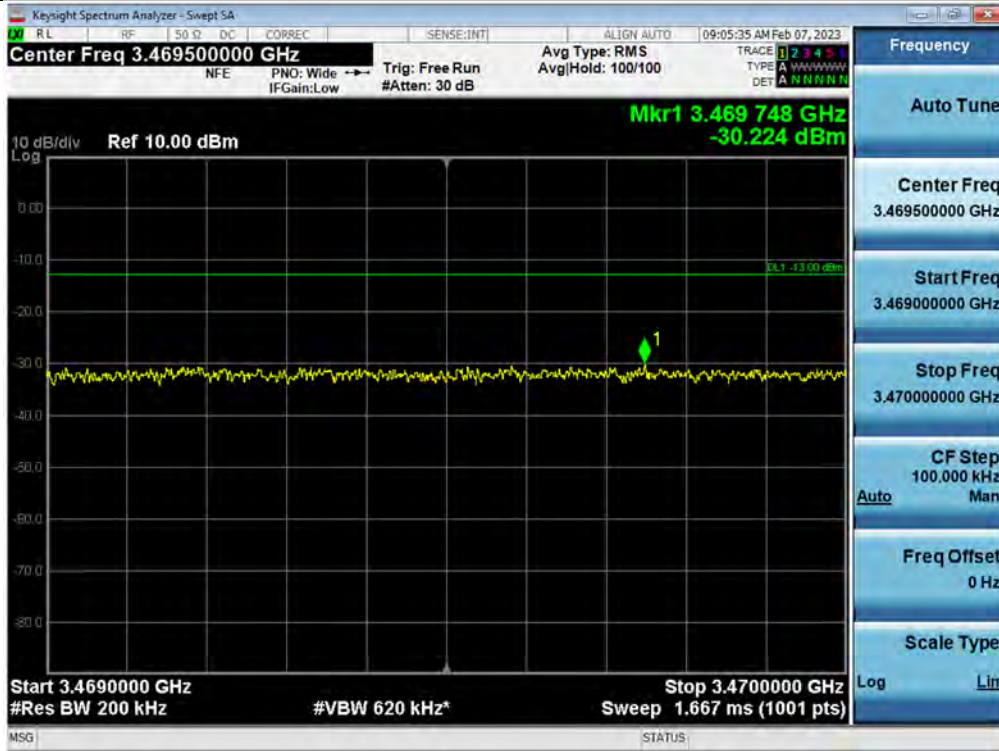

+3 dB above Out-of-band (single test signal) / 3.45 GHz Service / Downlink / 5G NR 60 MHz / Middle / Upper

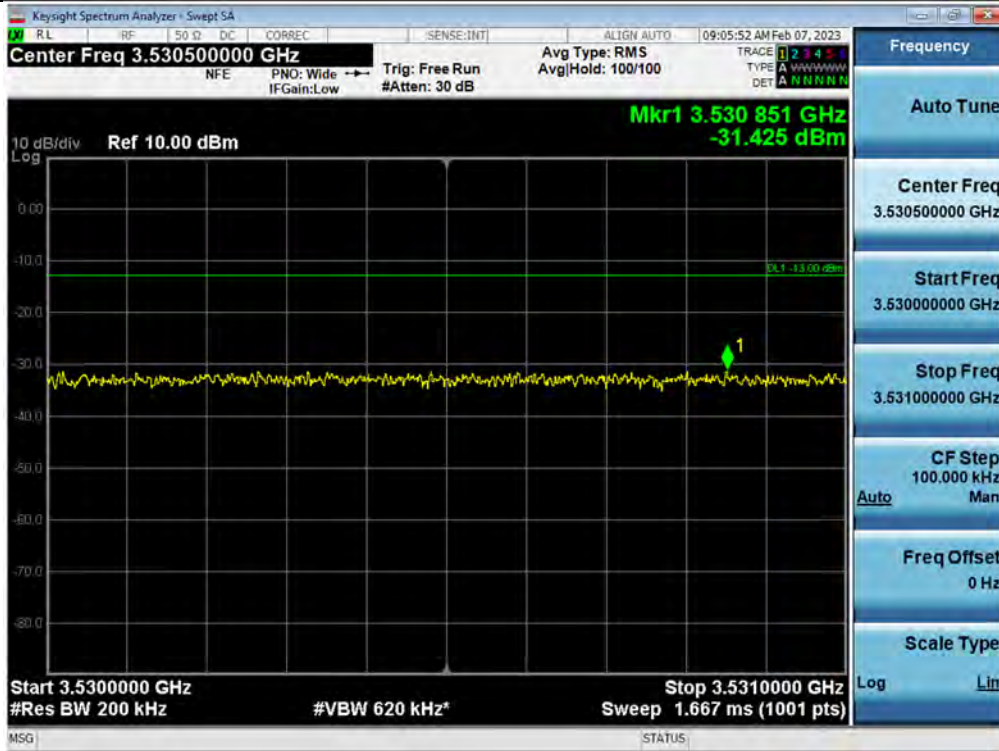

+3 dB above Out-of-band (single test signal) / 3.45 GHz Service / Downlink / 5G NR 60 MHz / High / Lower

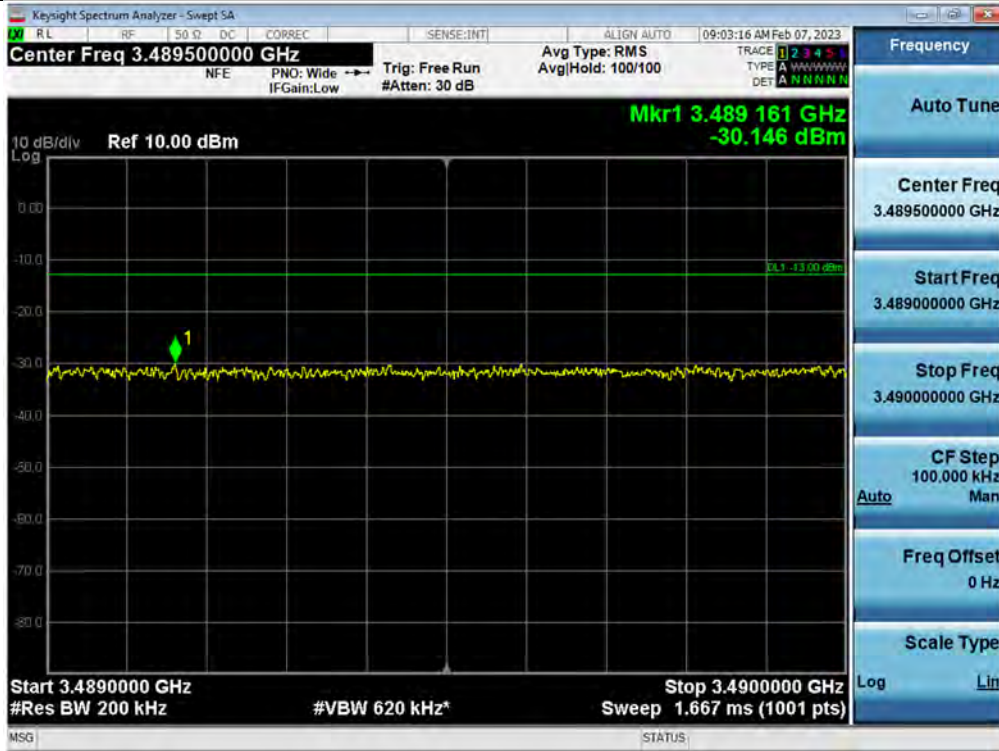

+3 dB above Out-of-band (single test signal) / 3.45 GHz Service / Downlink / 5G NR 60 MHz / High / Upper

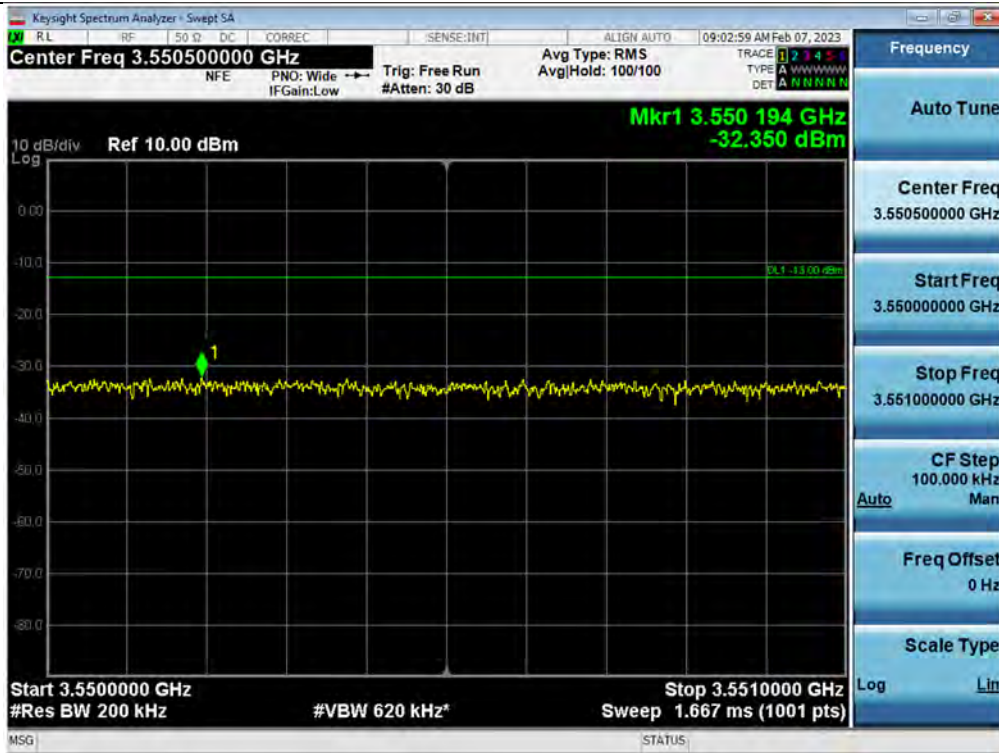

Out-of-band (single test signal) / 3.45 GHz Service / Downlink / 5G NR 80 MHz / Low / Lower

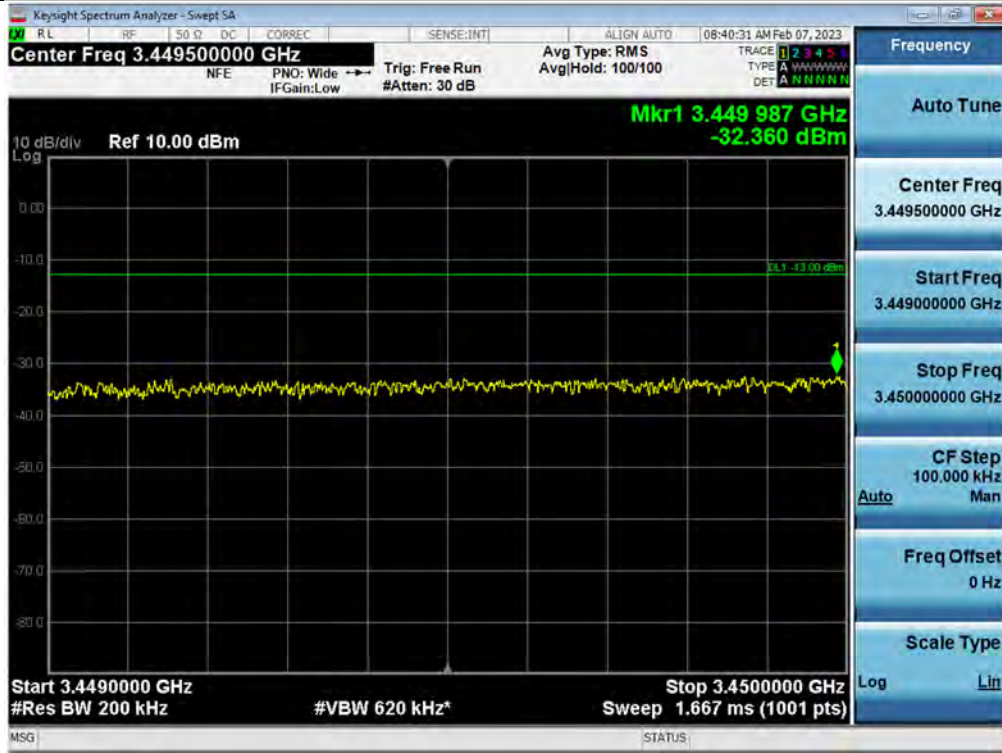

Out-of-band (single test signal) / 3.45 GHz Service / Downlink / 5G NR 80 MHz / Low / Upper

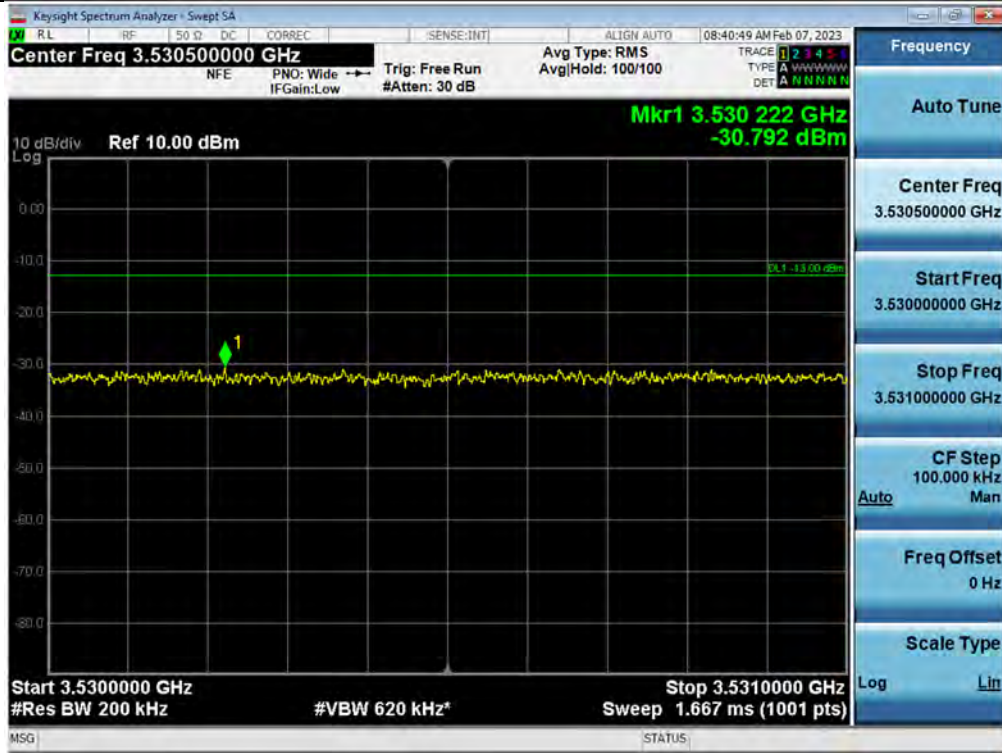

Out-of-band (single test signal) / 3.45 GHz Service / Downlink / 5G NR 80 MHz / Middle / Lower

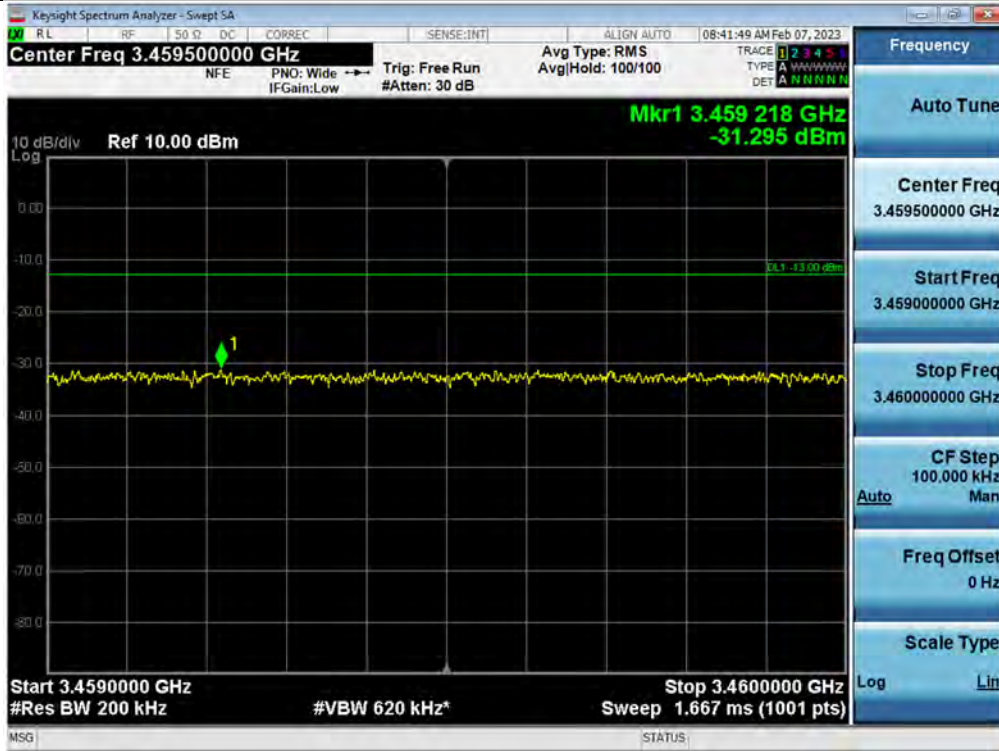

Out-of-band (single test signal) / 3.45 GHz Service / Downlink / 5G NR 80 MHz / Middle / Upper

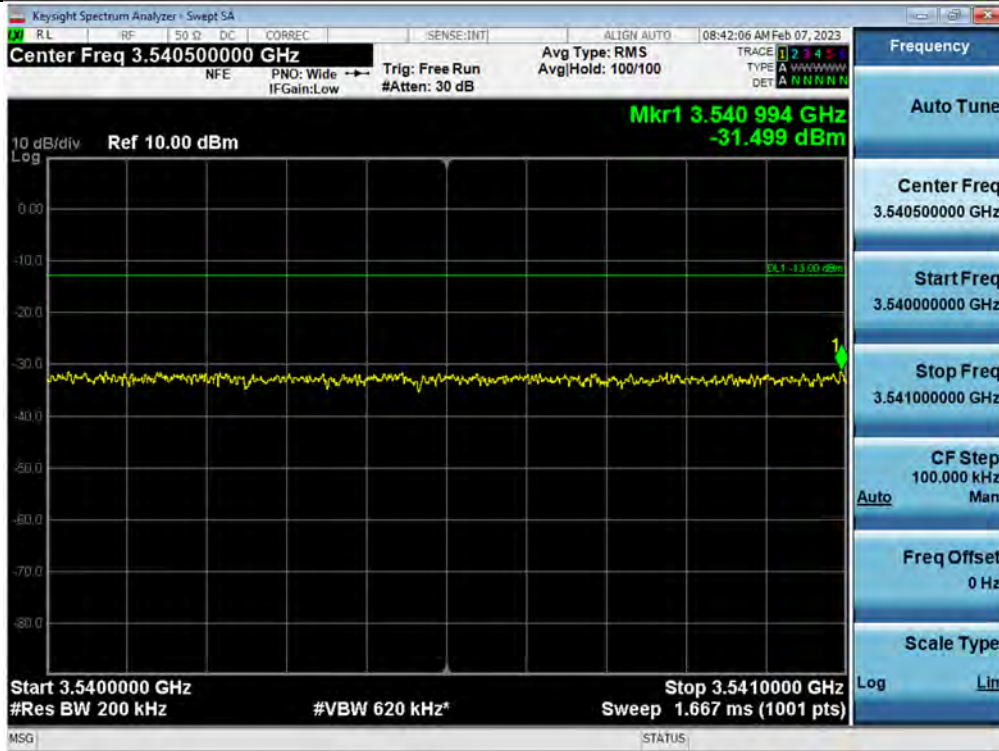

Out-of-band (single test signal) / 3.45 GHz Service / Downlink / 5G NR 80 MHz / High / Lower

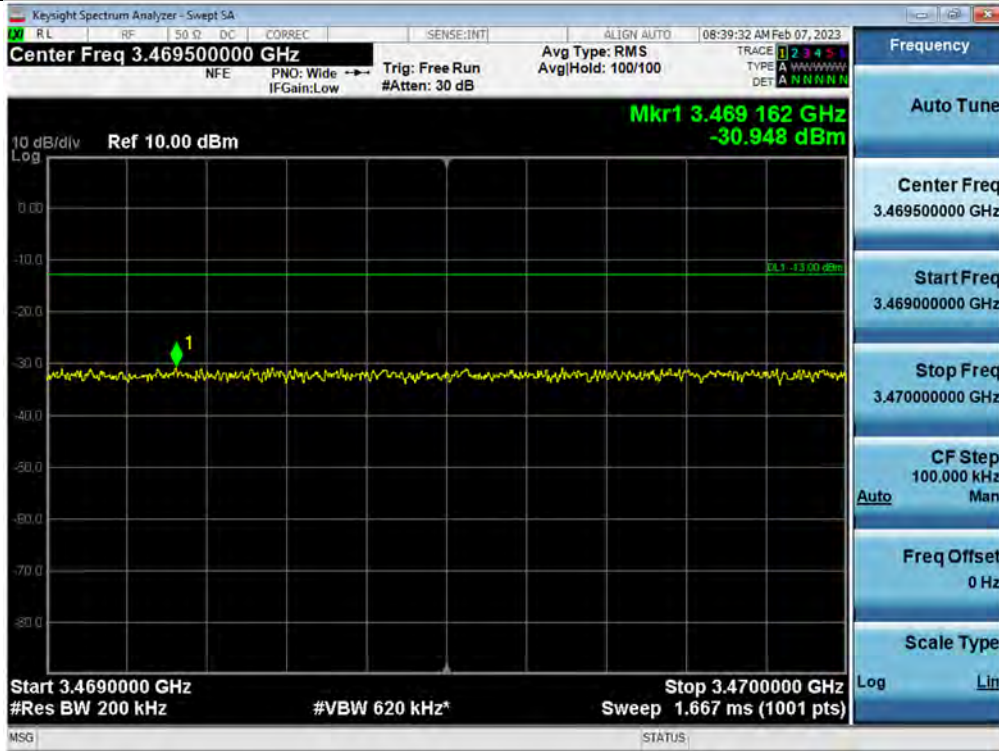

Out-of-band (single test signal) / 3.45 GHz Service / Downlink / 5G NR 80 MHz / High / Upper

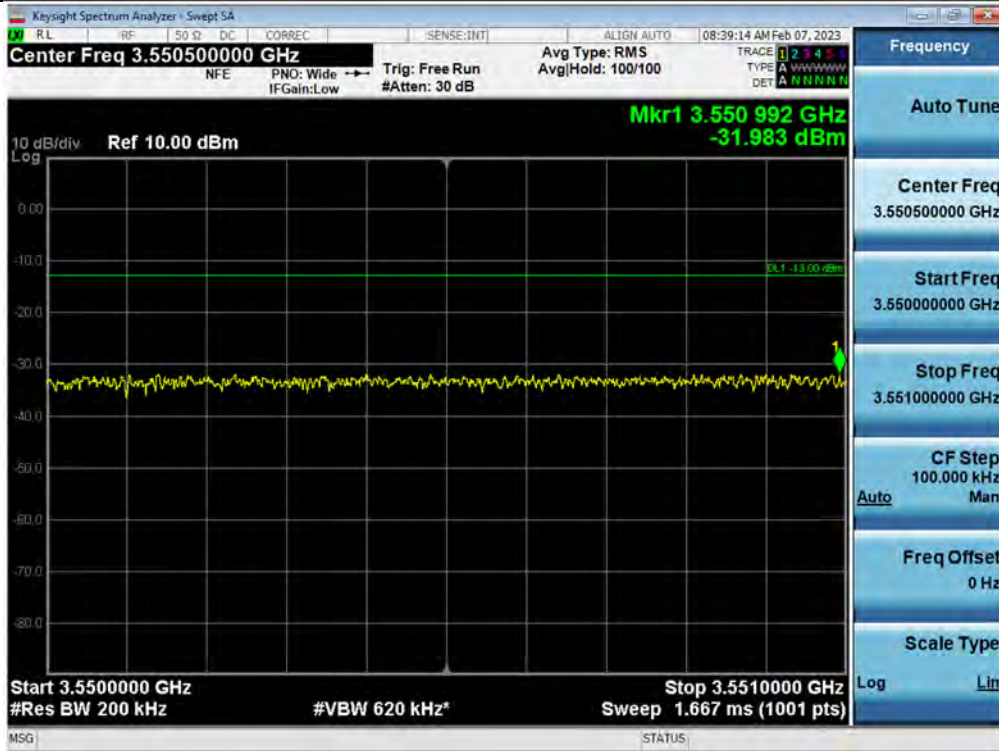

+3 dB above Out-of-band (single test signal) / 3.45 GHz Service / Downlink / 5G NR 80 MHz / Low / Lower

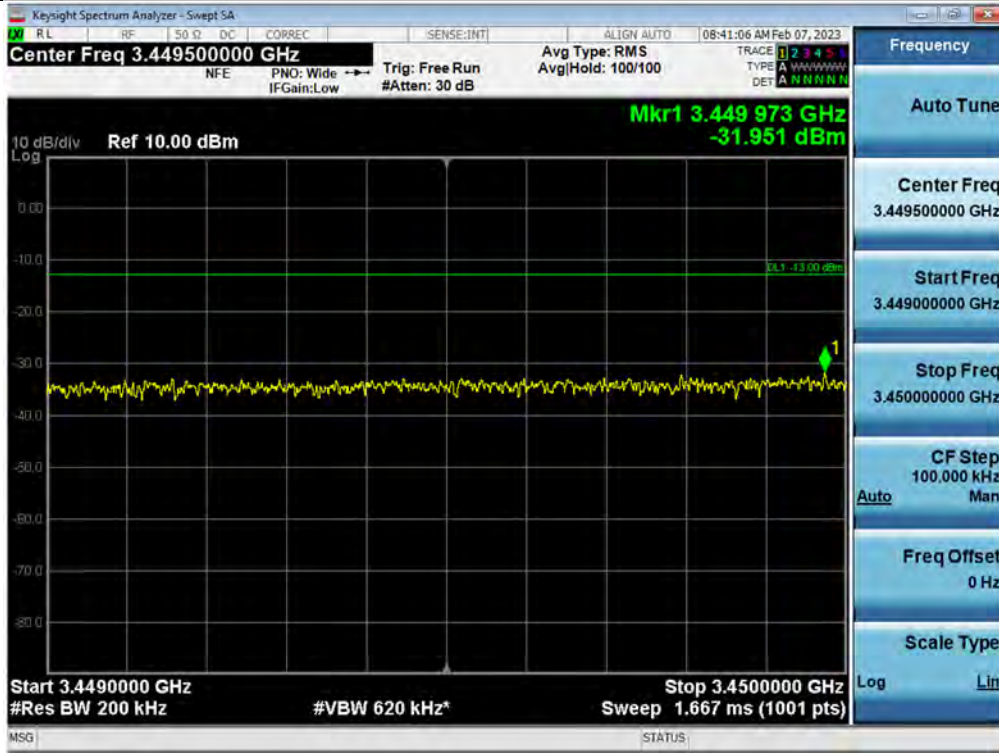

+3 dB above Out-of-band (single test signal) / 3.45 GHz Service / Downlink / 5G NR 80 MHz / Low / Upper

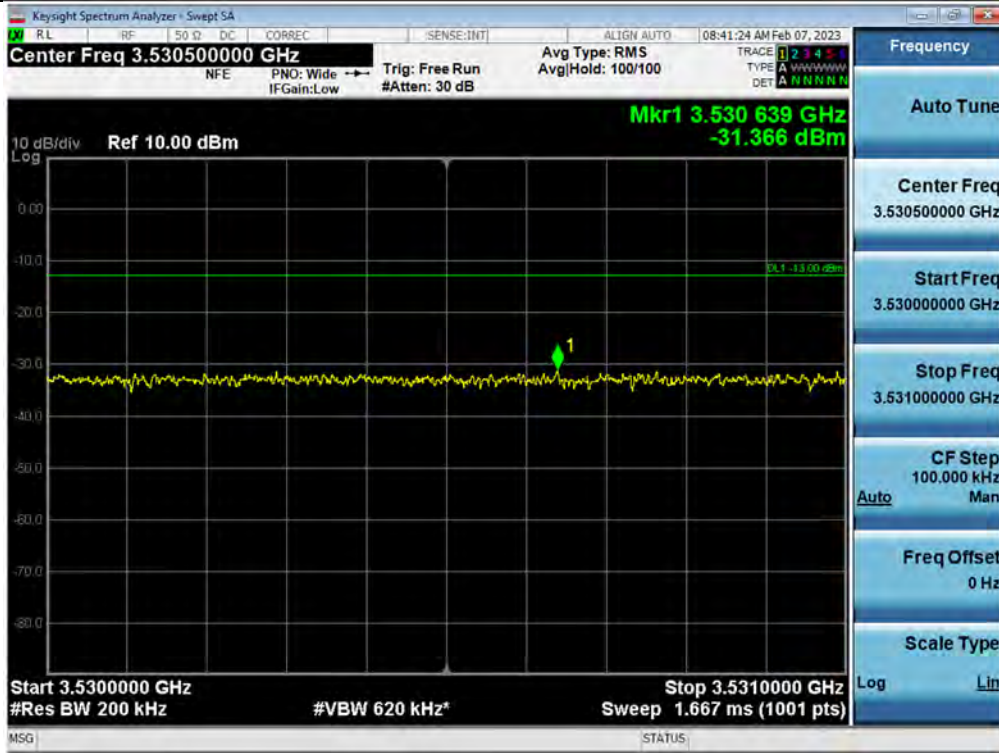

+3 dB above Out-of-band (single test signal) / 3.45 GHz Service / Downlink / 5G NR 80 MHz / Middle / Lower

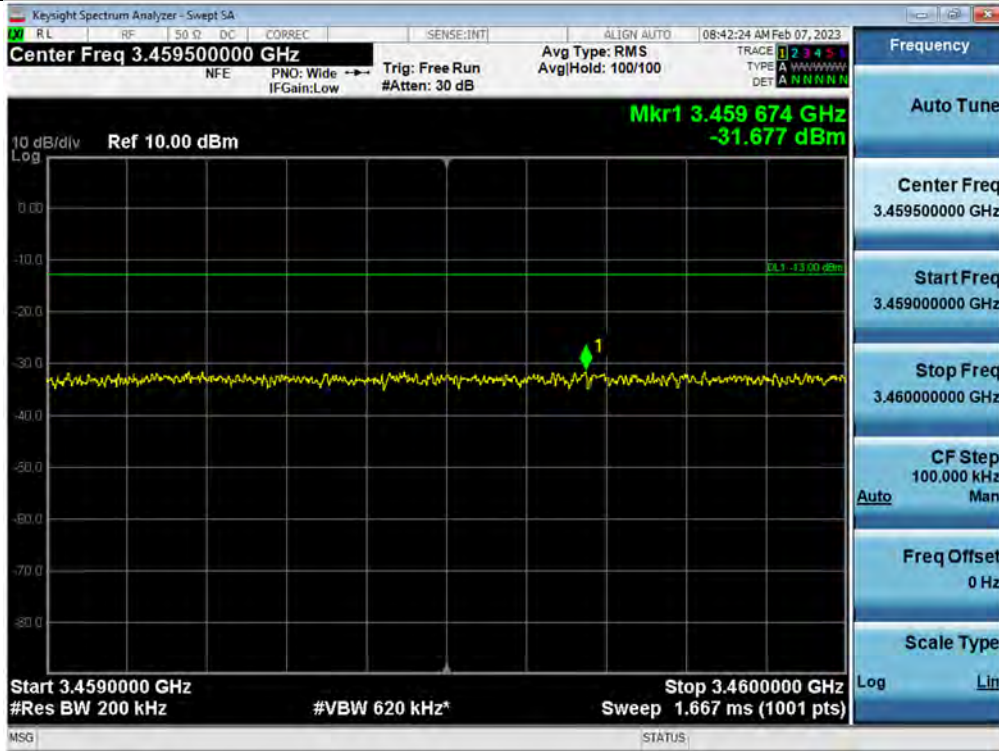

+3 dB above Out-of-band (single test signal) / 3.45 GHz Service / Downlink / 5G NR 80 MHz / Middle / Upper

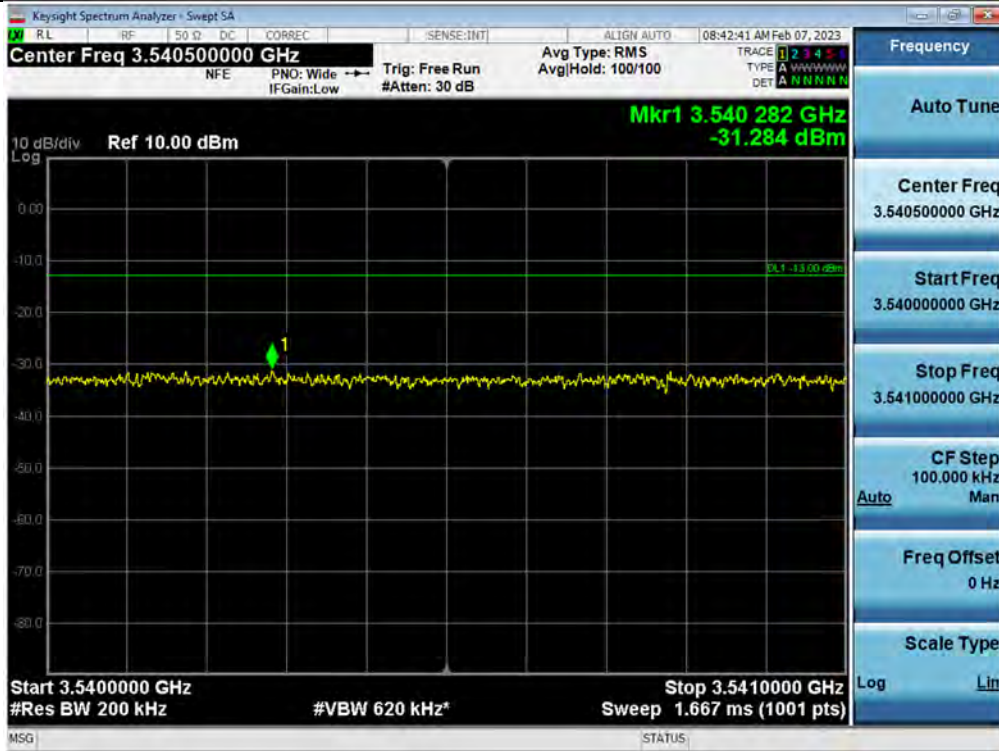

+3 dB above Out-of-band (single test signal) / 3.45 GHz Service / Downlink / 5G NR 80 MHz / High / Lower

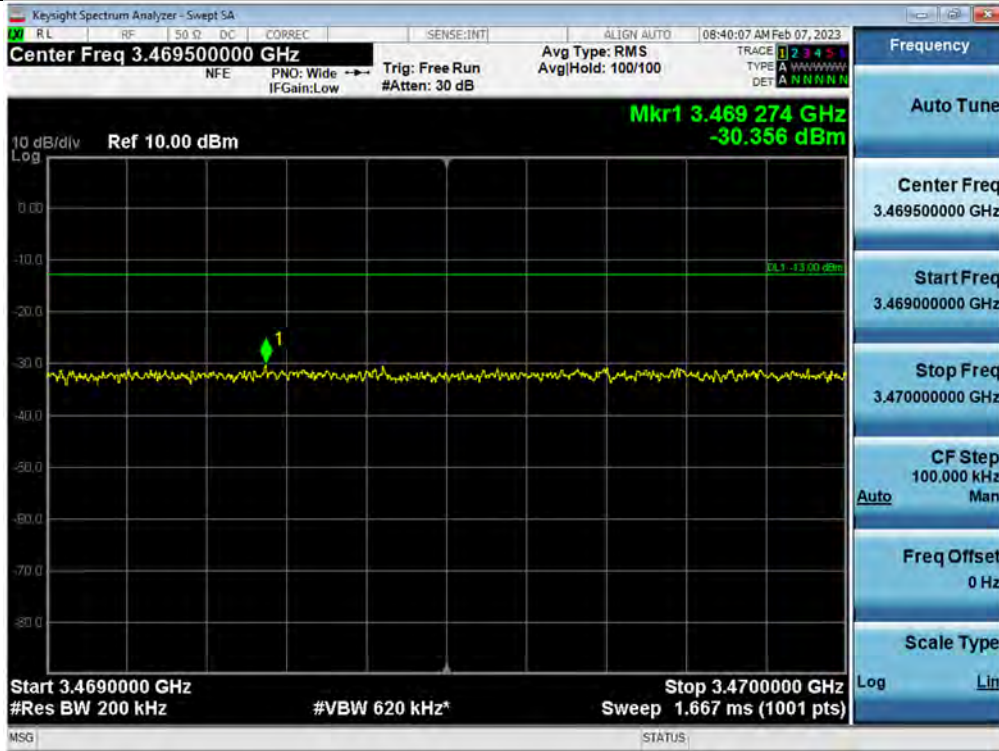

+3 dB above Out-of-band (single test signal) / 3.45 GHz Service / Downlink / 5G NR 80 MHz / High / Upper

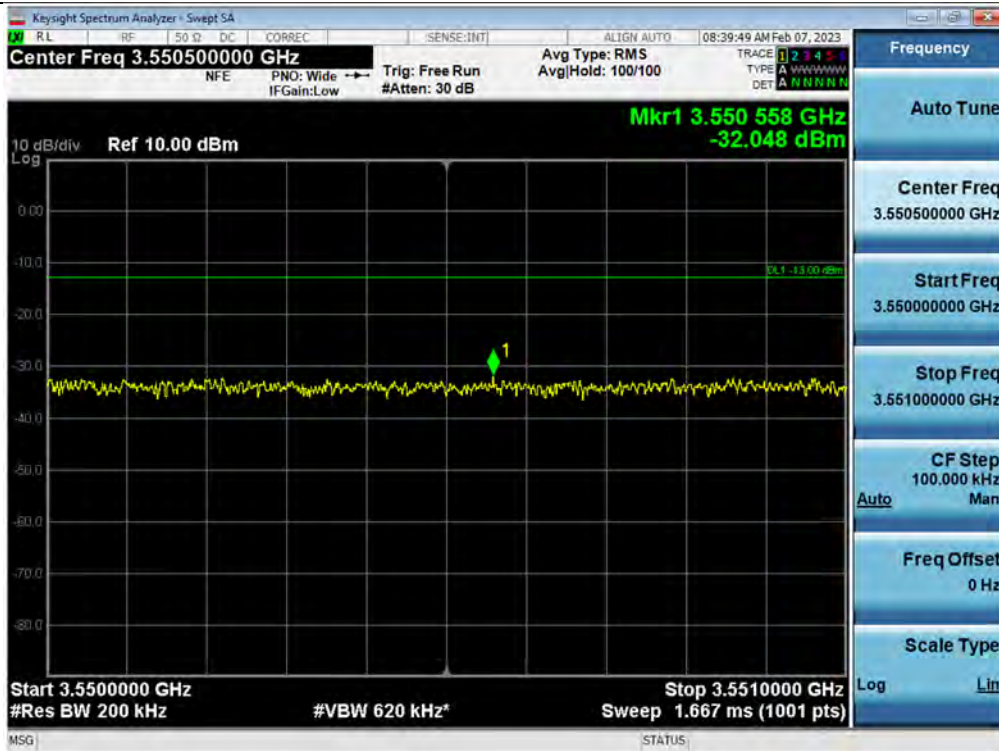

Out-of-band (single test signal) / 3.45 GHz Service / Downlink / 5G NR 100 MHz / Middle / Lower

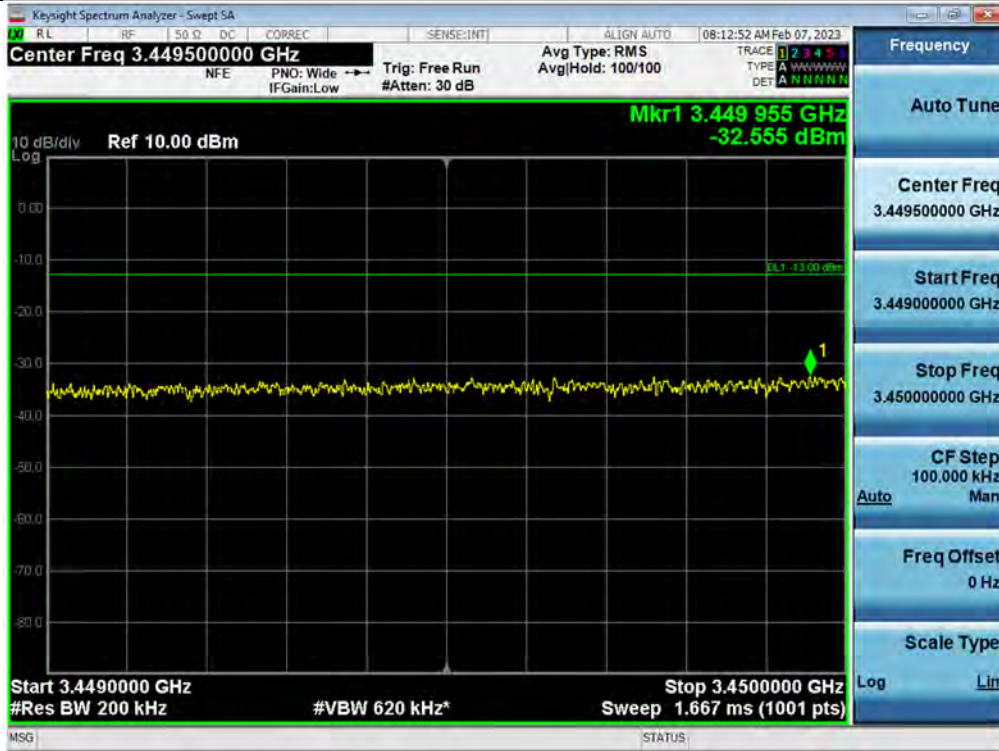

Out-of-band (single test signal) / 3.45 GHz Service / Downlink / 5G NR 100 MHz / Middle / Upper

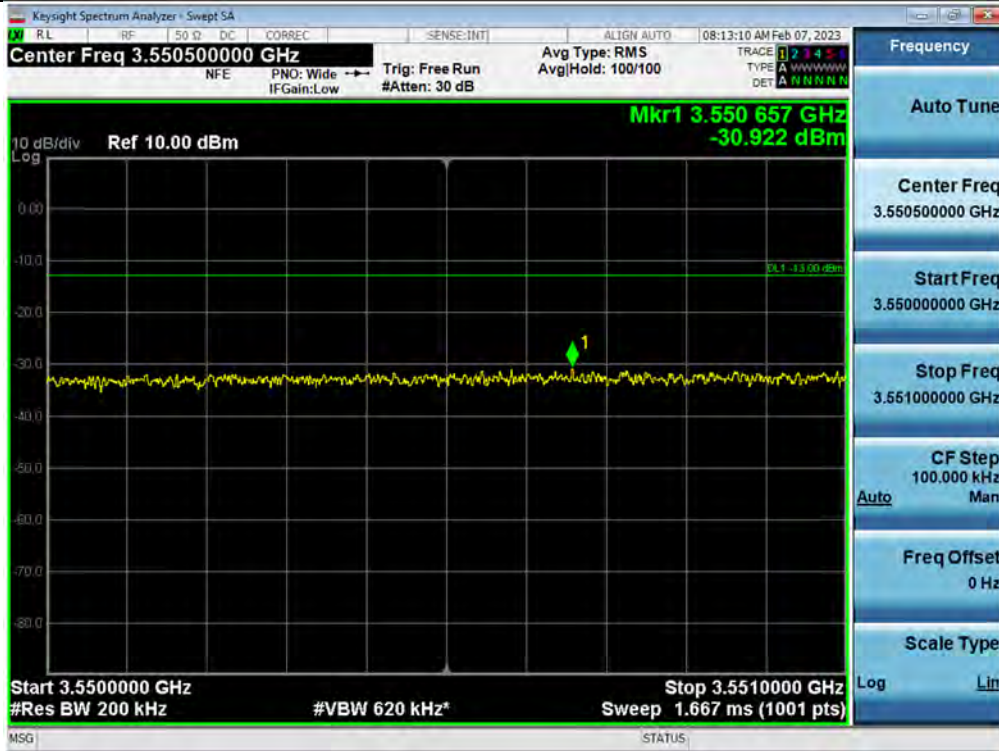

+3 dB above Out-of-band (single test signal) / 3.45 GHz Service / Downlink / 5G NR 100 MHz / Middle / Lower

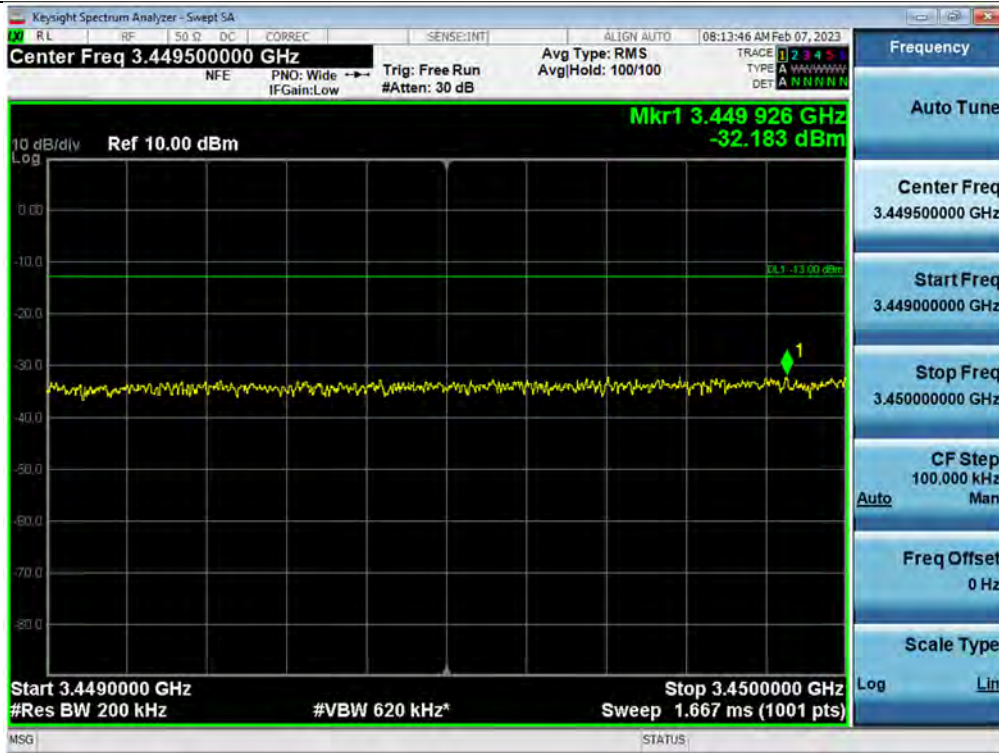

+3 dB above Out-of-band (single test signal) / 3.45 GHz Service / Downlink / 5G NR 100 MHz / Middle / Upper

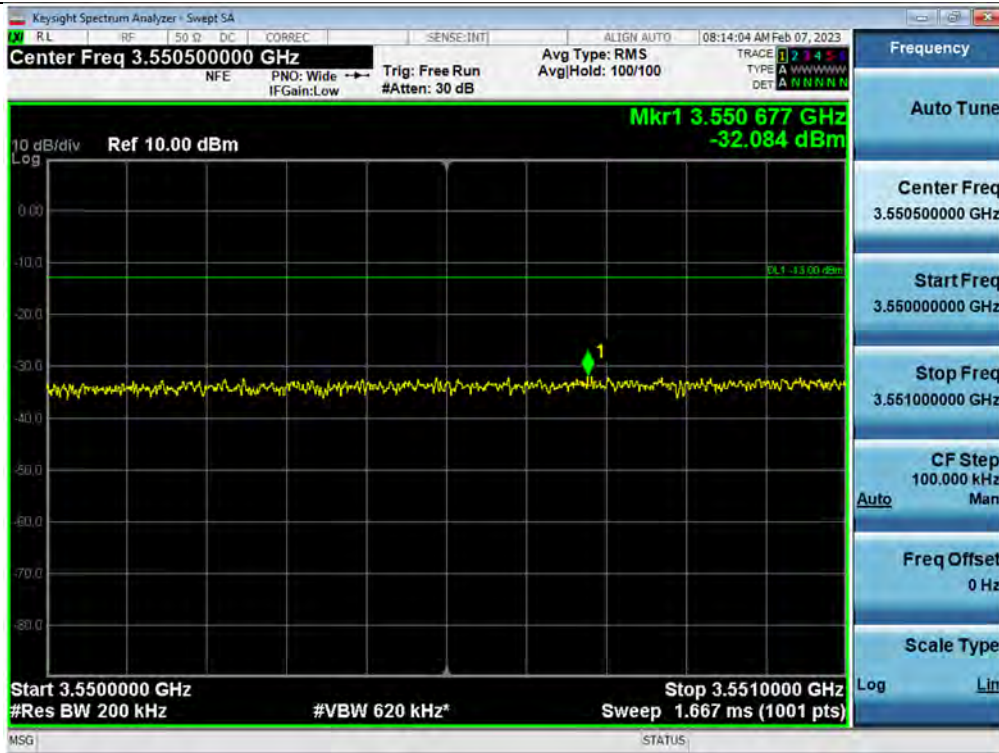

Plot data of Spurious emissions

Spurious / 3.45 GHz Service / Downlink / 5G NR 20 MHz / Low / 9 kHz ~ 150 kHz

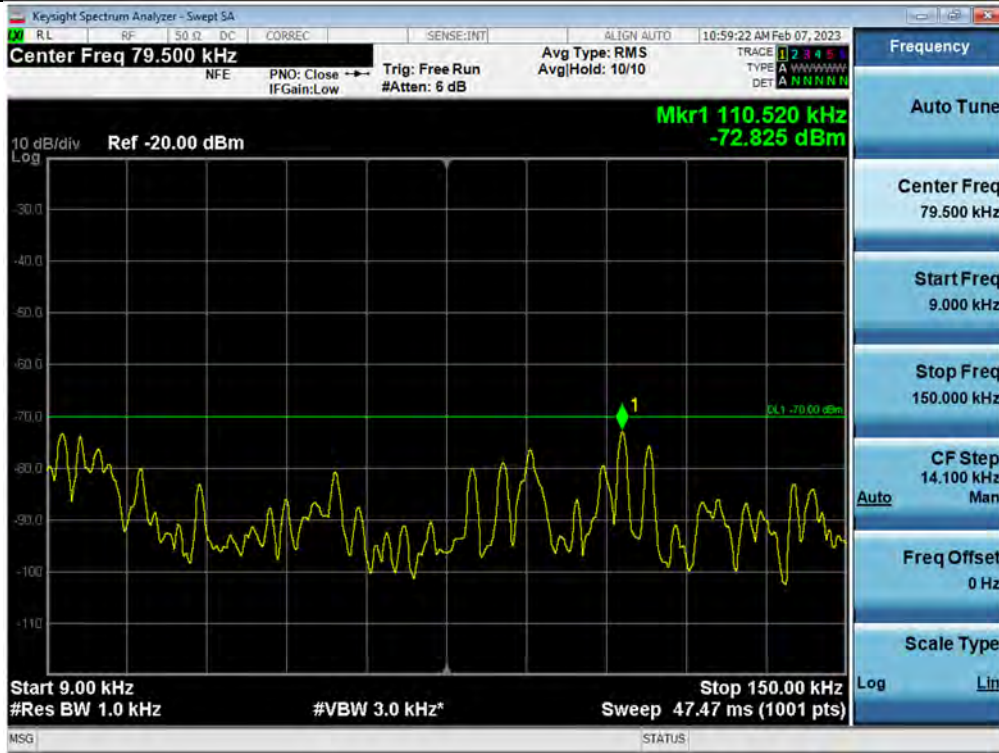

Spurious / 3.45 GHz Service / Downlink / 5G NR 20 MHz / Middle / 150 kHz ~ 30 MHz

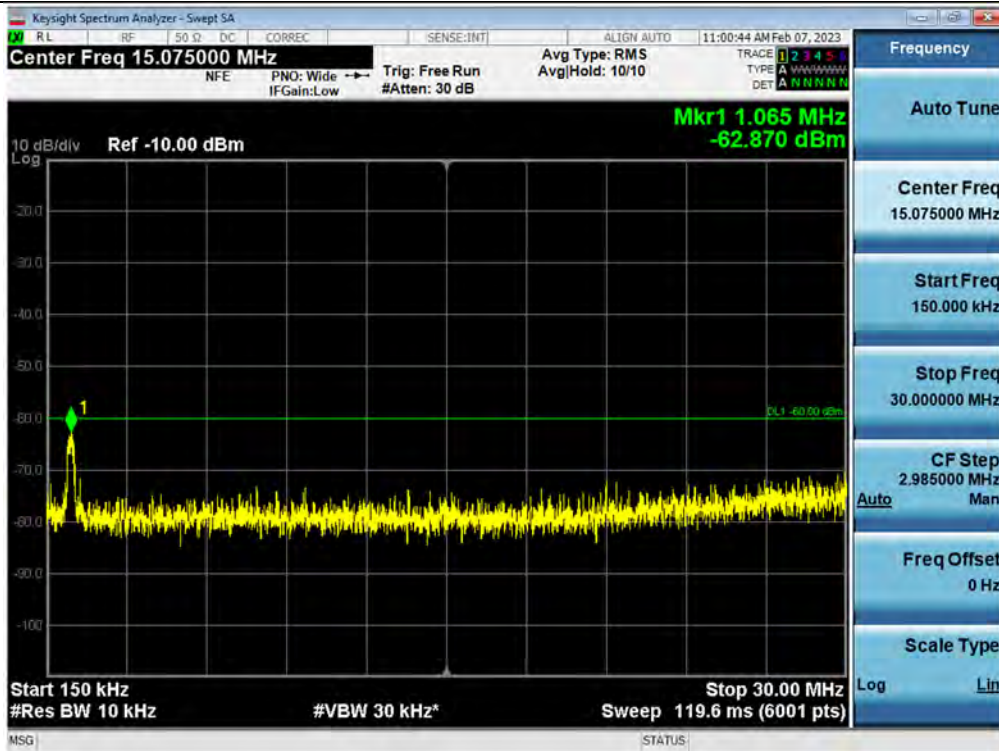

Spurious / 3.45 GHz Service / Downlink / 5G NR 20 MHz / High / 30 MHz ~ 3 430 MHz

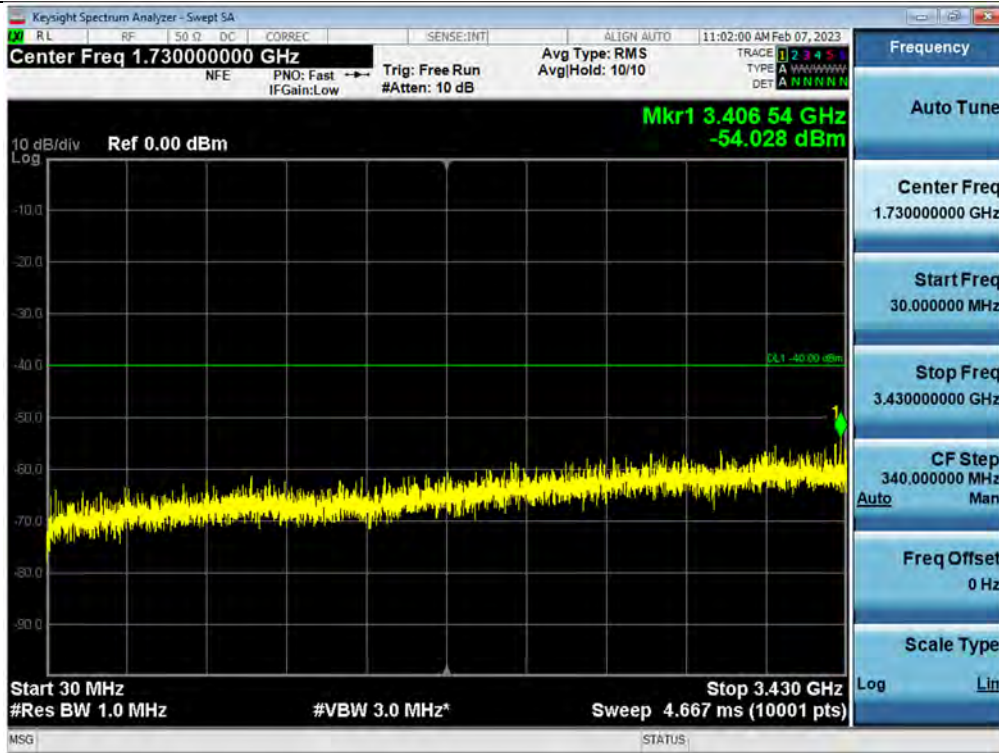

Spurious / 3.45 GHz Service / Downlink / 5G NR 20 MHz / Low / 3 430 MHz ~ 3 440 MHz

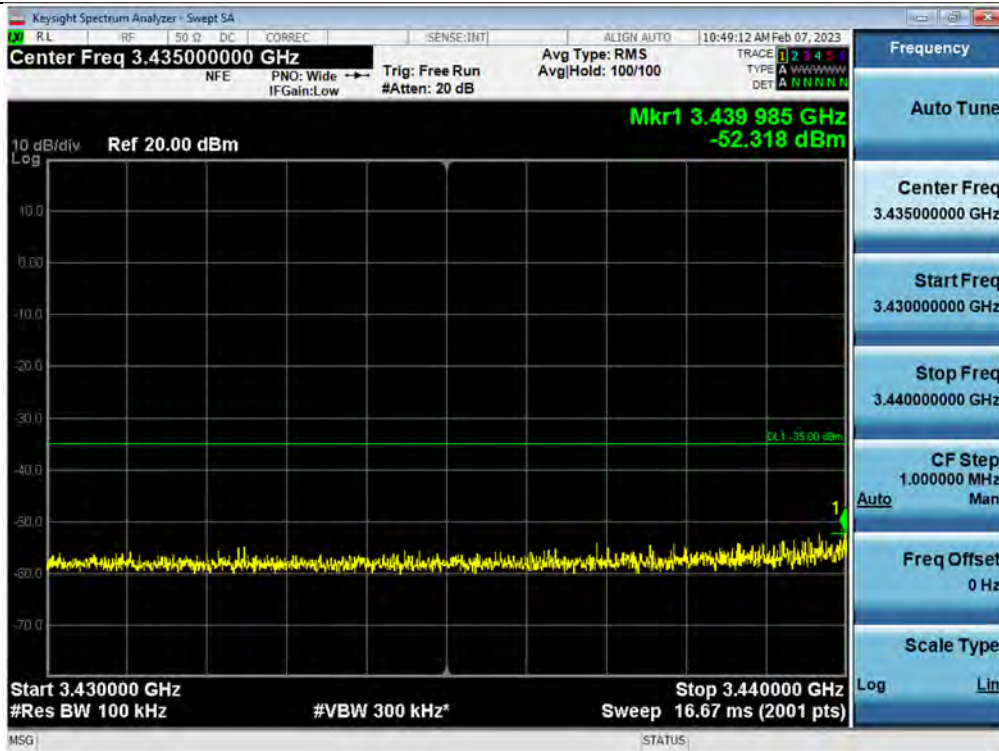

Spurious / 3.45 GHz Service / Downlink / 5G NR 20 MHz / Middle / 3 440 MHz ~ Low Edge

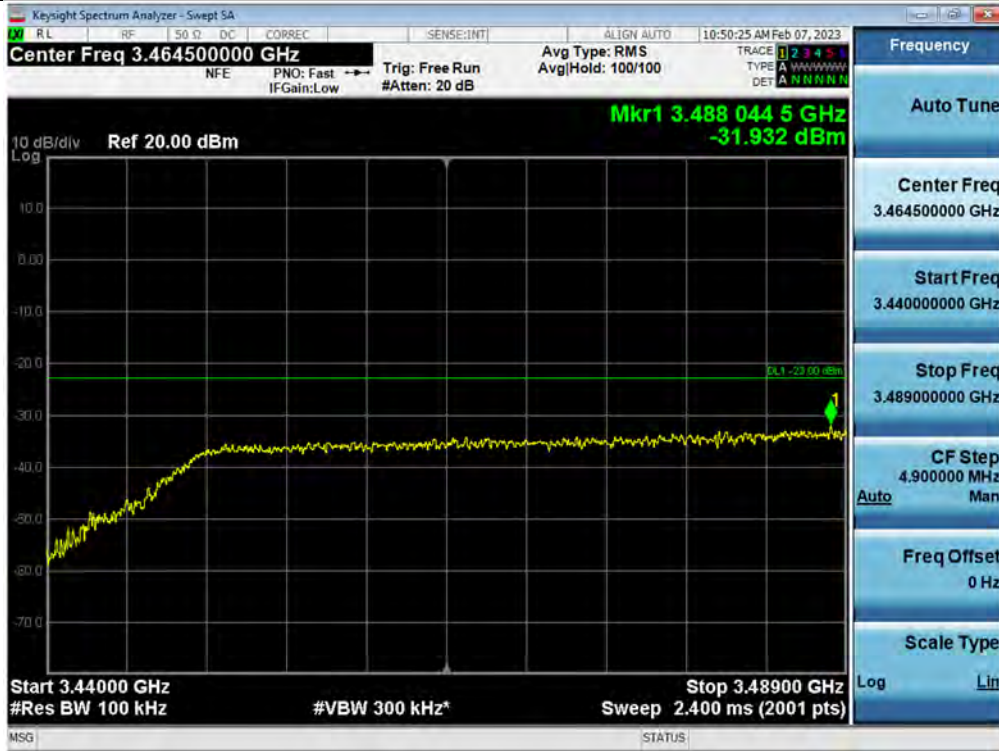

Spurious / 3.45 GHz Service / Downlink / 5G NR 20 MHz / Middle / High Edge ~ 3 560 MHz

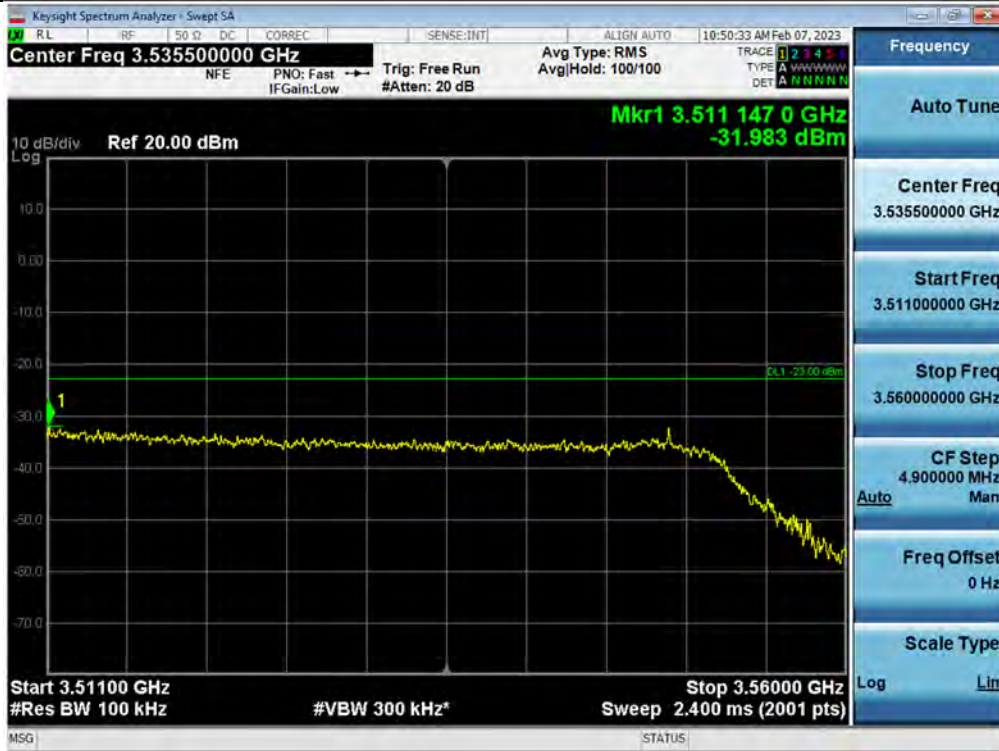

Spurious / 3.45 GHz Service / Downlink / 5G NR 20 MHz / High / 3 560 MHz ~ 3 570 MHz

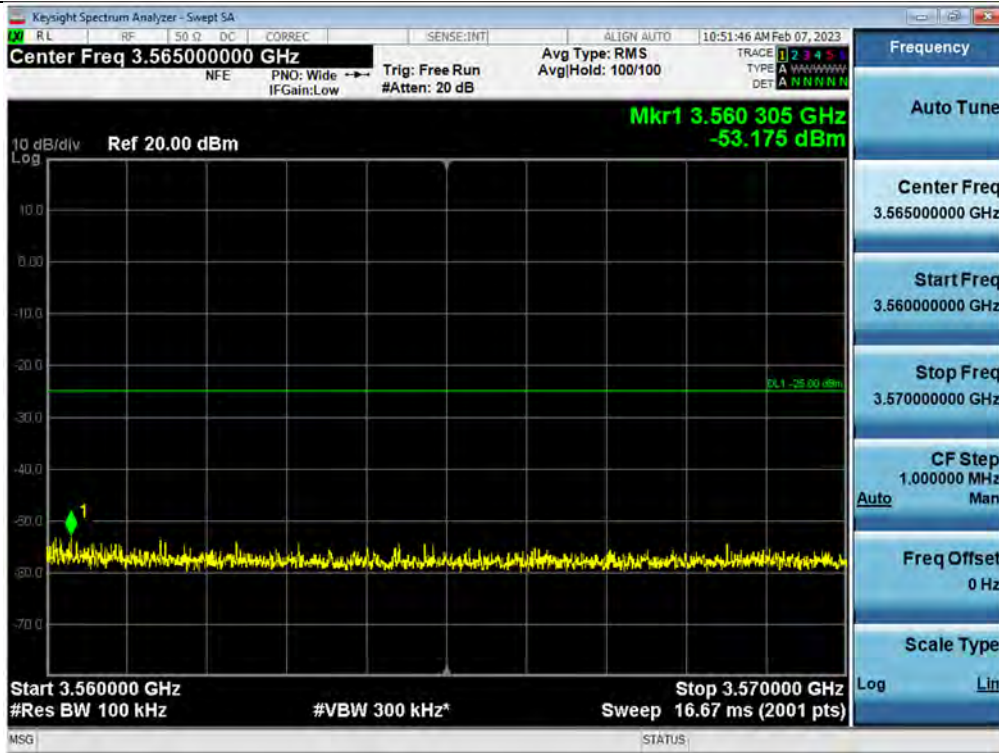

*Limit: -35 dBm/MHz

Spurious / 3.45 GHz Service / Downlink / 5G NR 20 MHz / Low / 3 570 MHz ~ 10 GHz

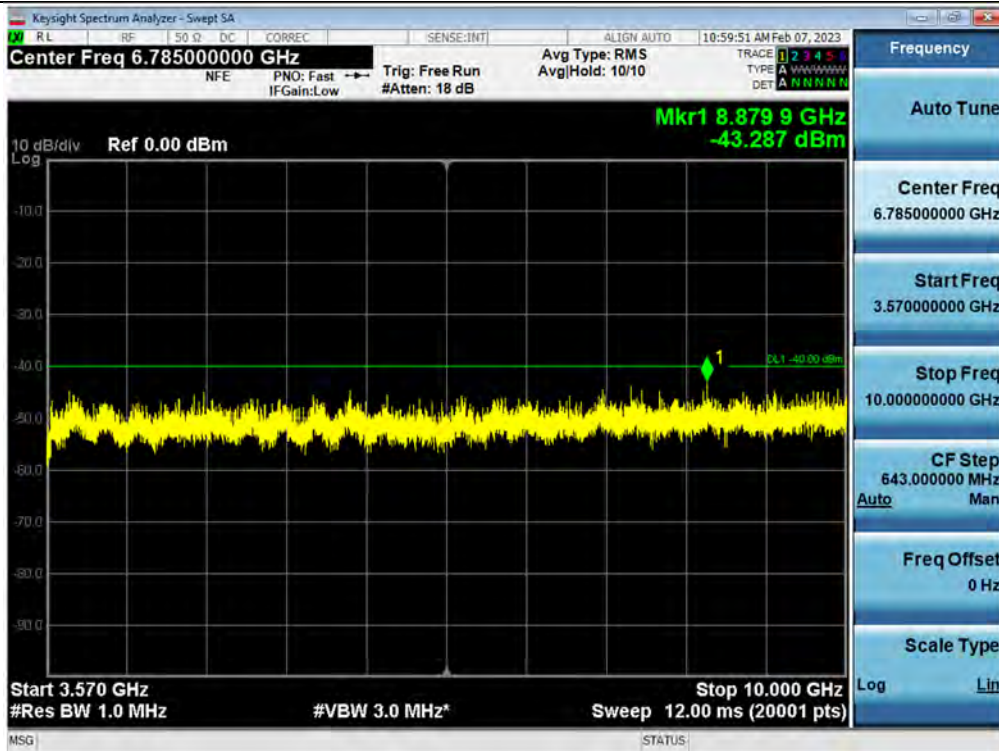

Spurious / 3.45 GHz Service / Downlink / 5G NR 20 MHz / High / 10 GHz ~ 40 GHz

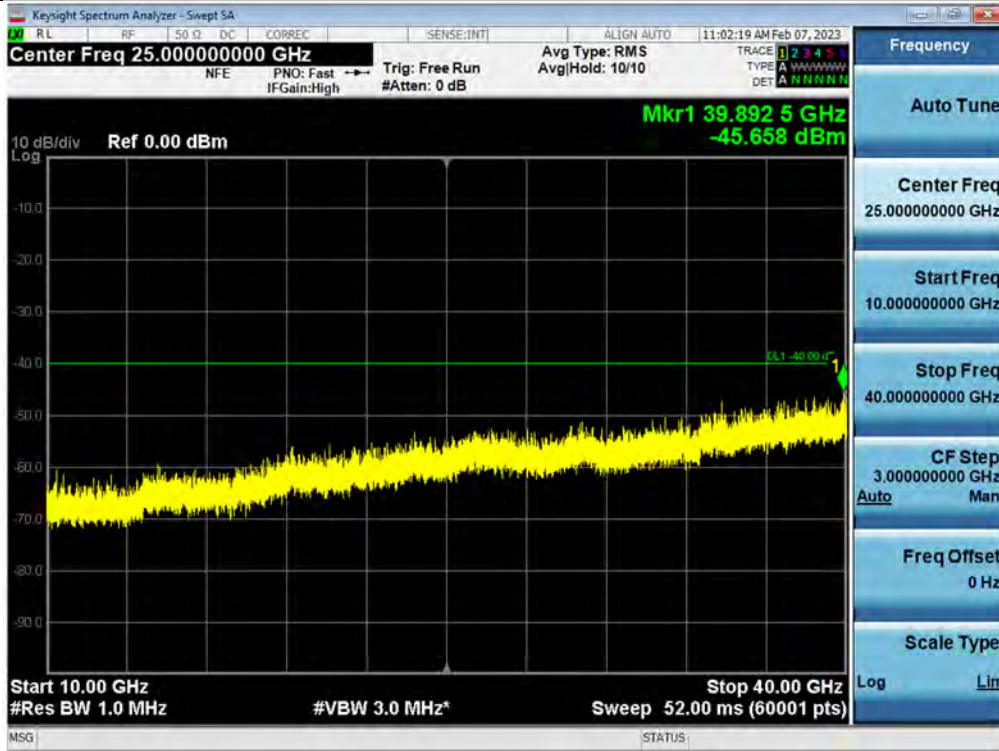

Spurious / 3.45 GHz Service / Downlink / 5G NR 40 MHz / High / 9 kHz ~ 150 kHz

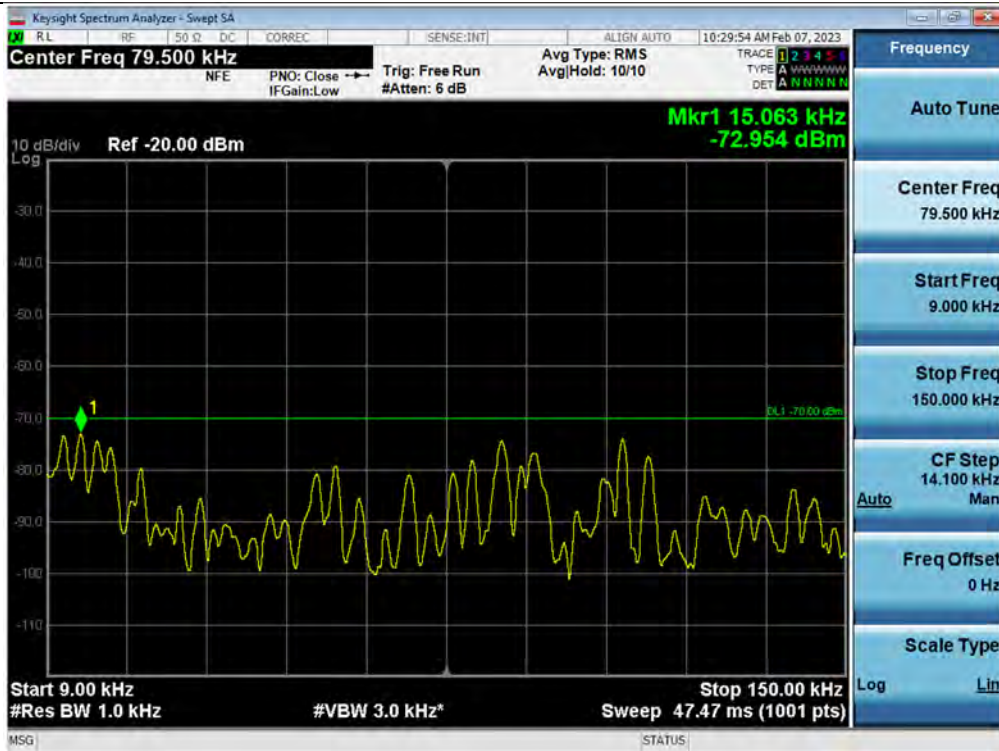

Spurious / 3.45 GHz Service / Downlink / 5G NR 40 MHz / Low / 150 kHz ~ 30 MHz



Spurious / 3.45 GHz Service / Downlink / 5G NR 40 MHz / Middle / 30 MHz ~ 3 430 MHz

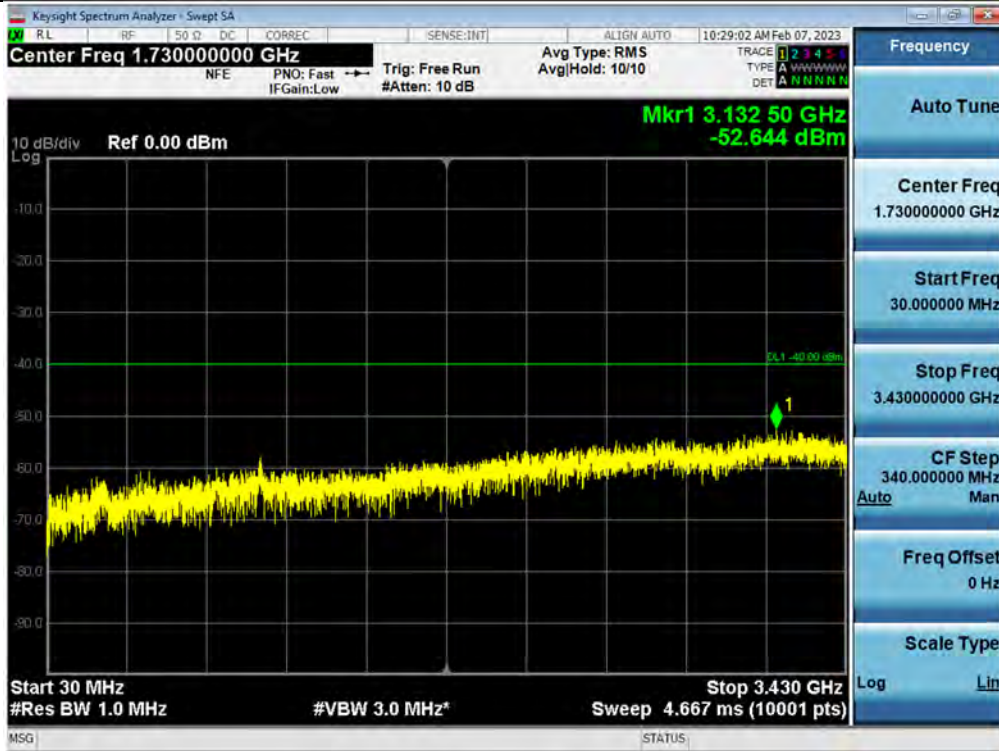

Spurious / 3.45 GHz Service / Downlink / 5G NR 40 MHz / Low / 3 430 MHz ~ 3 440 MHz

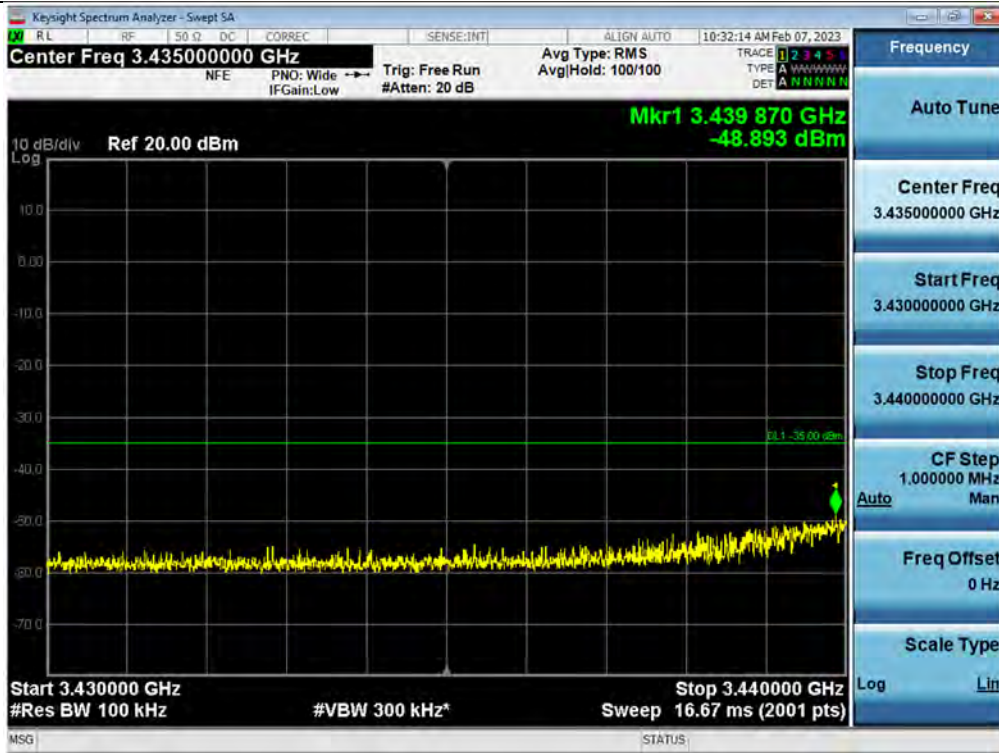

Spurious / 3.45 GHz Service / Downlink / 5G NR 40 MHz / High / 3 440 MHz ~ Low Edge

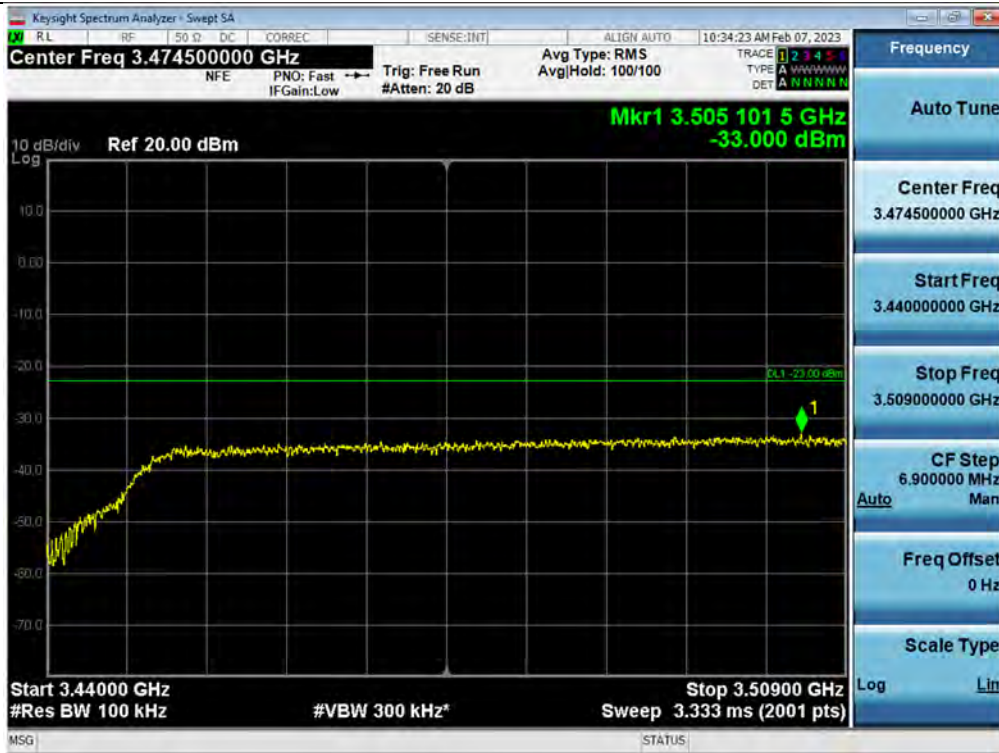

Spurious / 3.45 GHz Service / Downlink / 5G NR 40 MHz / Middle / High Edge ~ 3 560 MHz



Spurious / 3.45 GHz Service / Downlink / 5G NR 40 MHz / High / 3 560 MHz ~ 3 570 MHz

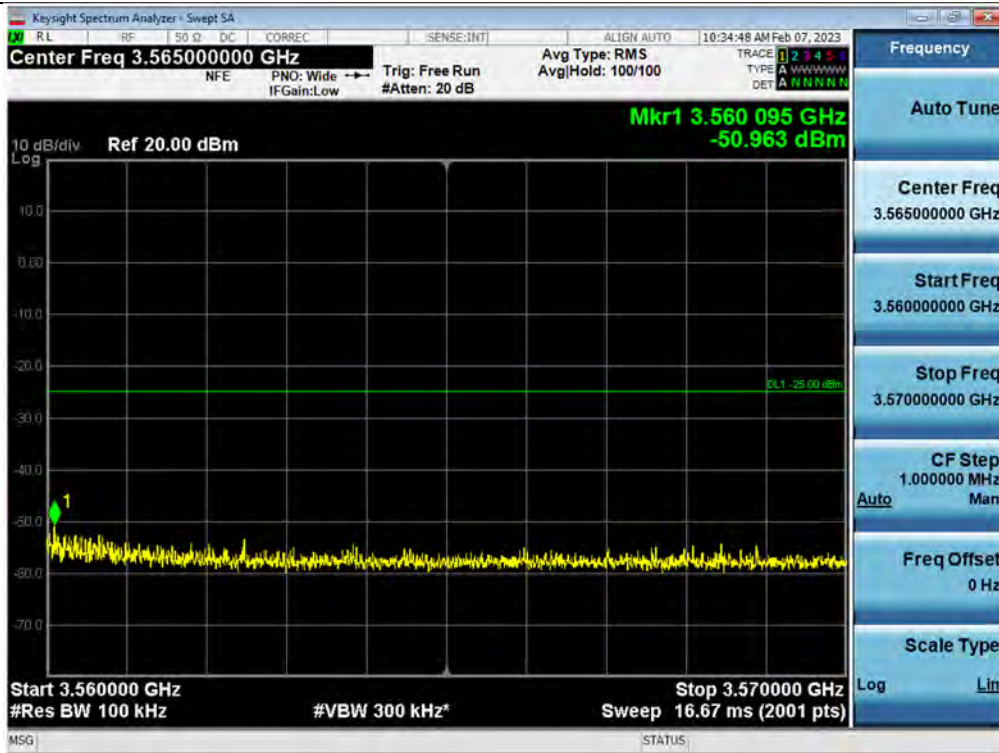

*Limit: -35 dBm/MHz

Spurious / 3.45 GHz Service / Downlink / 5G NR 40 MHz / Low / 3 570 MHz ~ 10 GHz

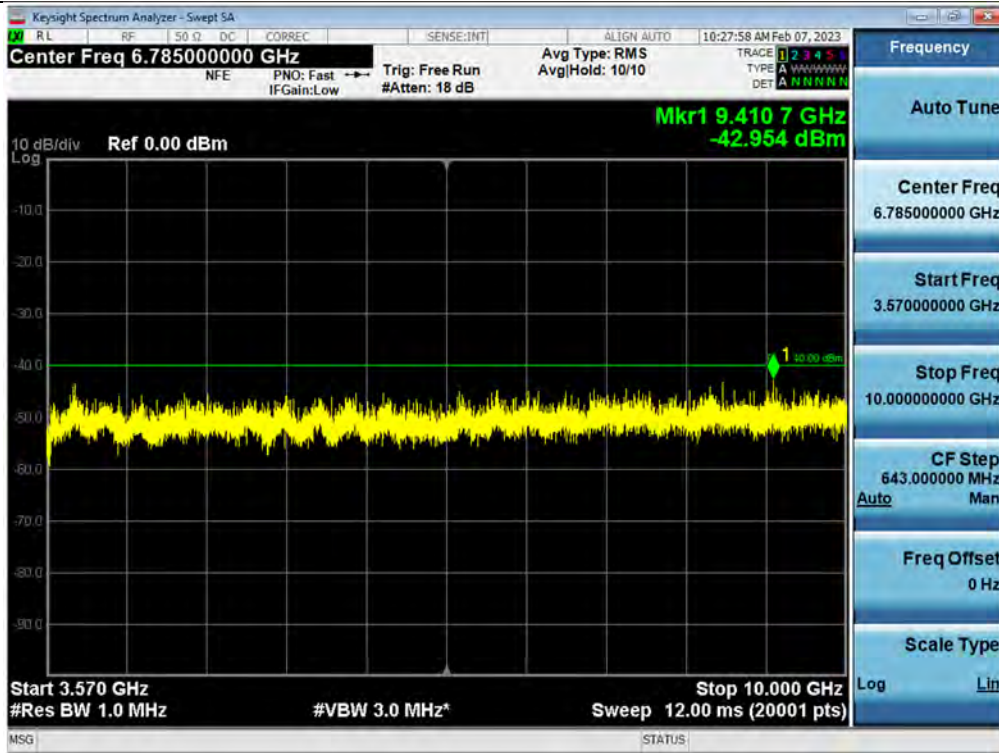

Spurious / 3.45 GHz Service / Downlink / 5G NR 40 MHz / Low / 10 GHz ~ 40 GHz

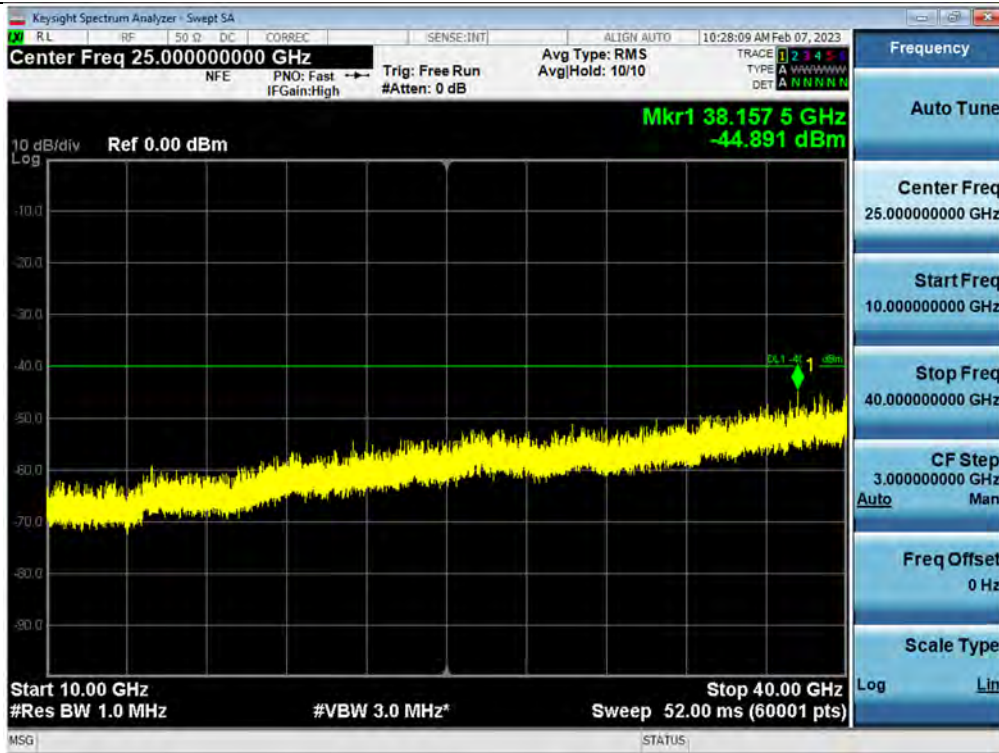

Spurious / 3.45 GHz Service / Downlink / 5G NR 60 MHz / Low / 9 kHz ~ 150 kHz



Spurious / 3.45 GHz Service / Downlink / 5G NR 60 MHz / Low / 150 kHz ~ 30 MHz

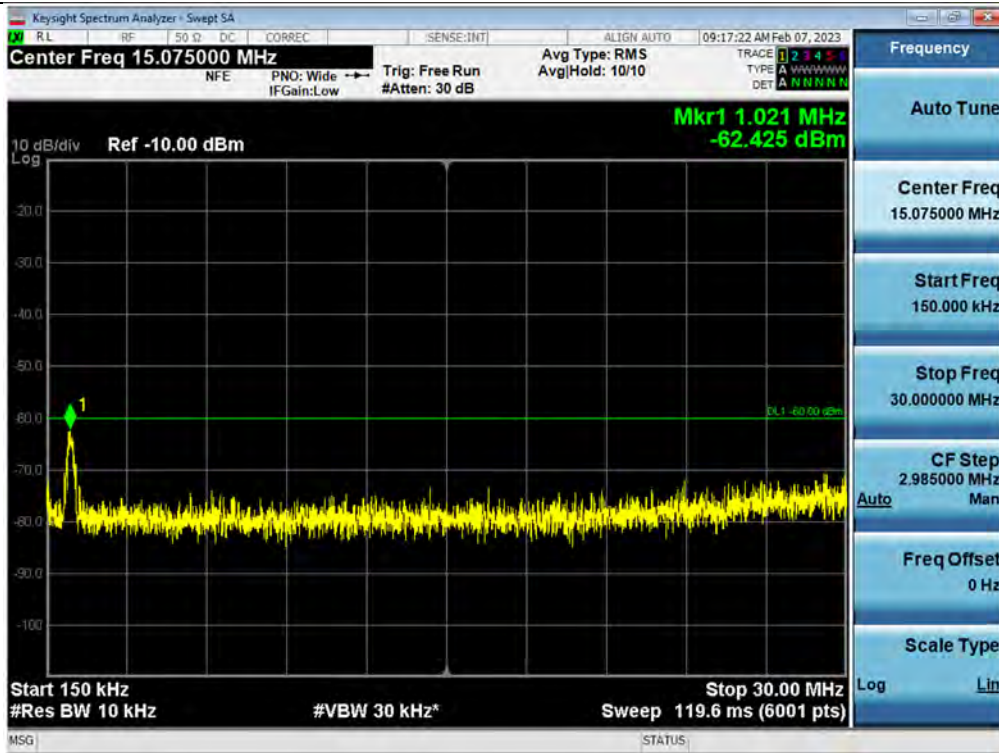

Spurious / 3.45 GHz Service / Downlink / 5G NR 60 MHz / High / 30 MHz ~ 3 430 MHz

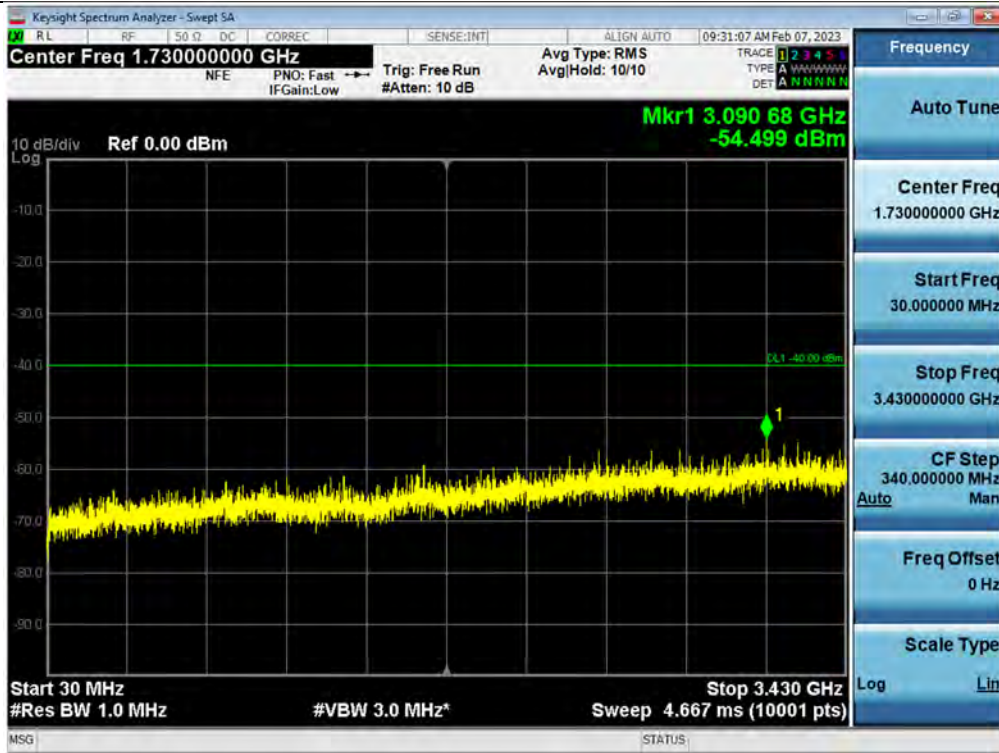

Spurious / 3.45 GHz Service / Downlink / 5G NR 60 MHz / Low / 3 430 MHz ~ 3 440 MHz

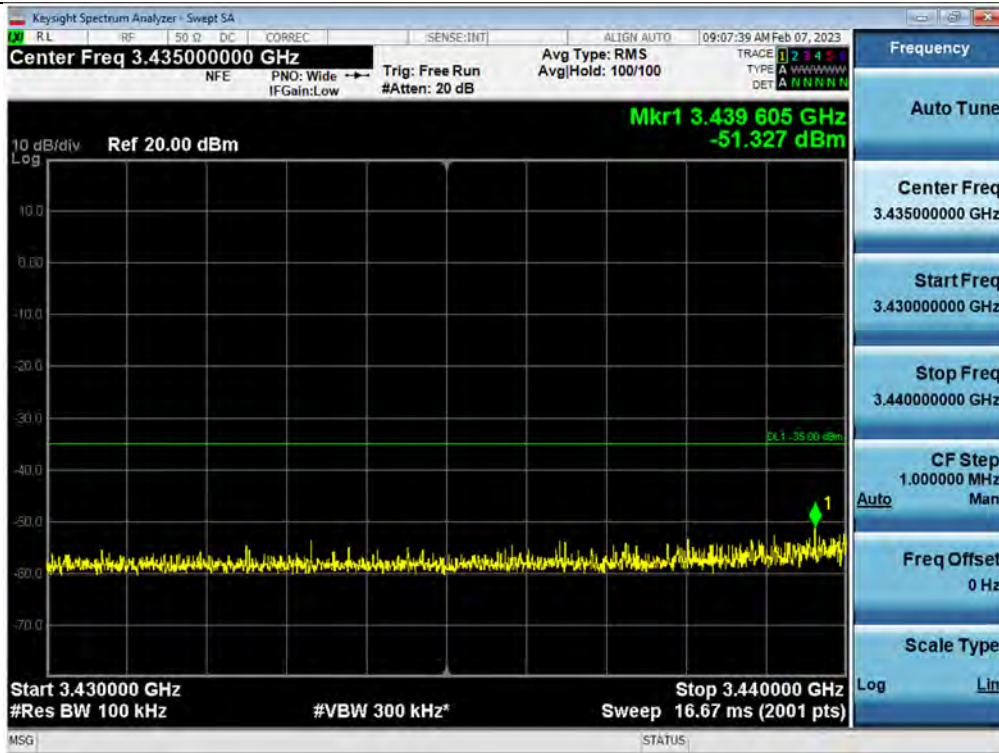

Spurious / 3.45 GHz Service / Downlink / 5G NR 60 MHz / High / 3 440 MHz ~ Low Edge

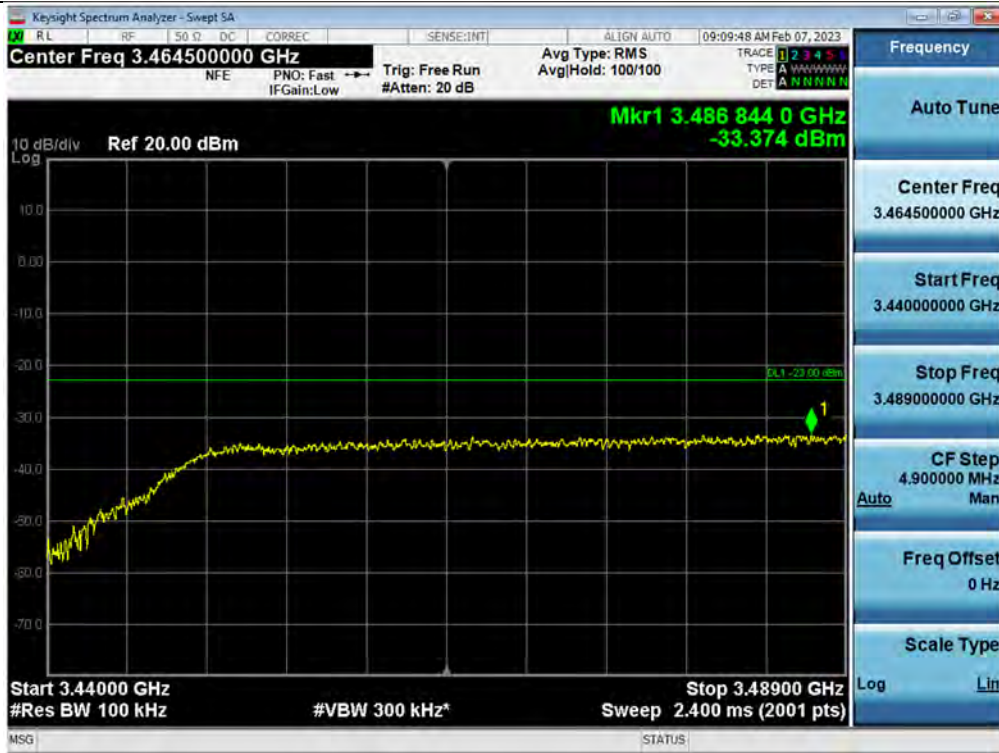

Spurious / 3.45 GHz Service / Downlink / 5G NR 60 MHz / Low / High Edge ~ 3 560 MHz



Spurious / 3.45 GHz Service / Downlink / 5G NR 60 MHz / High / 3 560 MHz ~ 3 570 MHz

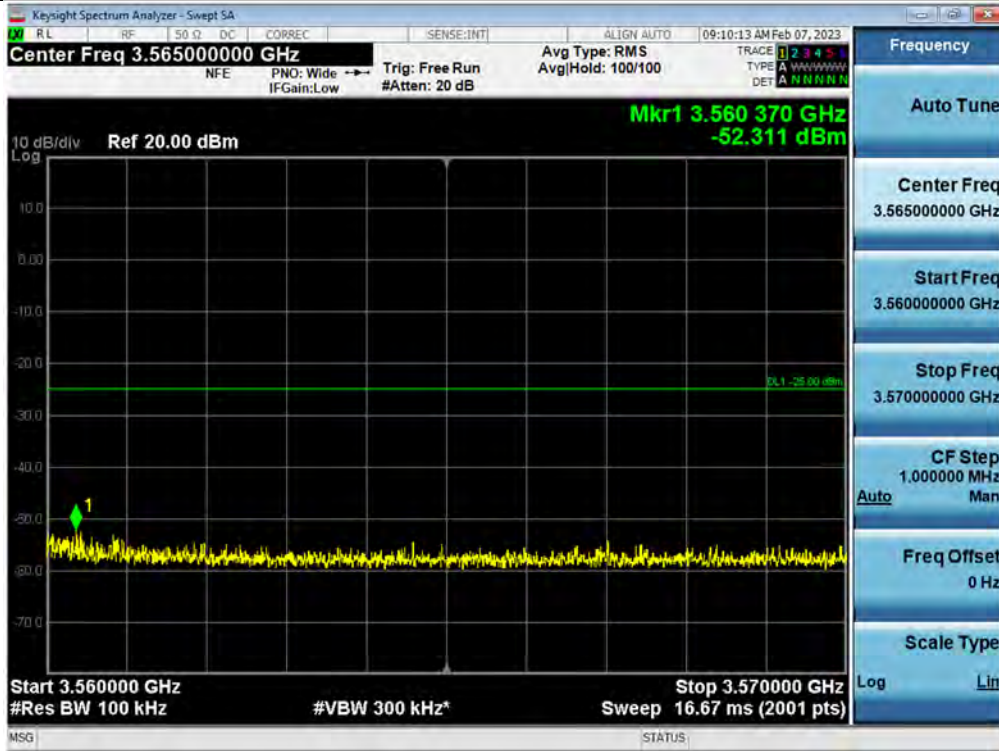

*Limit: -35 dBm/MHz

Spurious / 3.45 GHz Service / Downlink / 5G NR 60 MHz / High / 3 570 MHz ~ 10 GHz

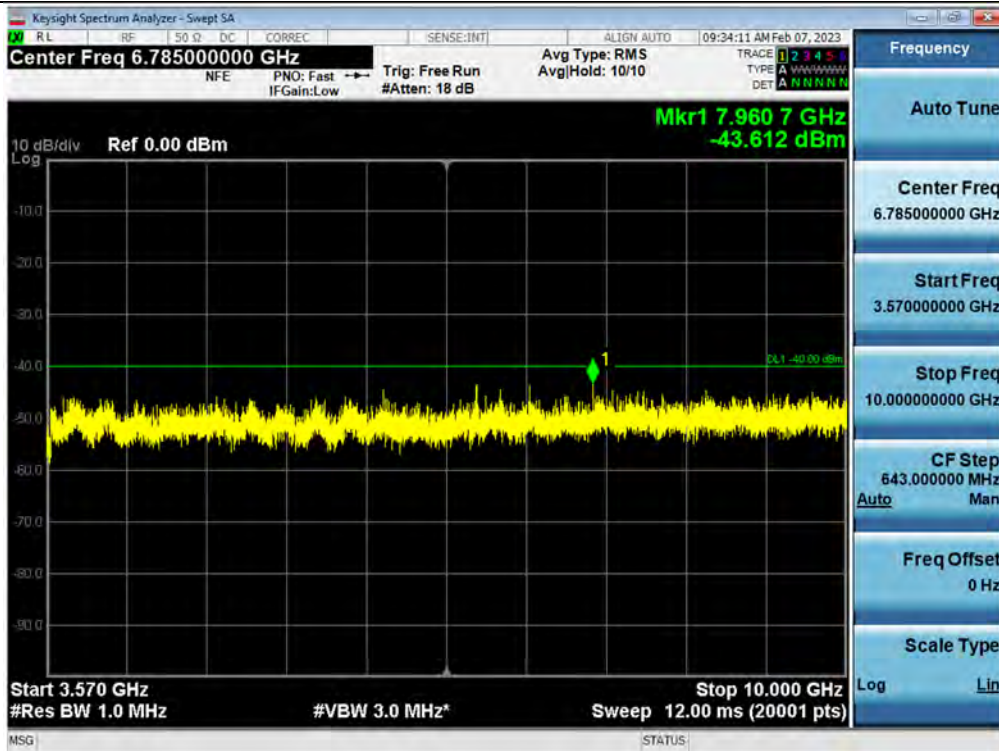

Spurious / 3.45 GHz Service / Downlink / 5G NR 60 MHz / Middle / 10 GHz ~ 40 GHz

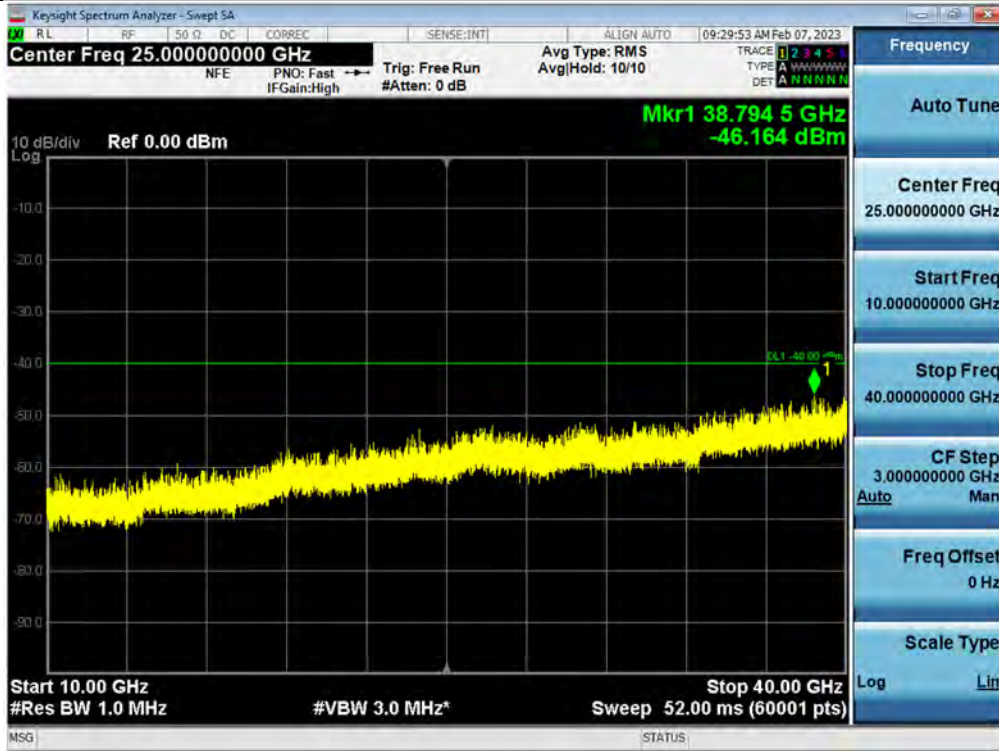

Spurious / 3.45 GHz Service / Downlink / 5G NR 80 MHz / Middle / 9 kHz ~ 150 kHz

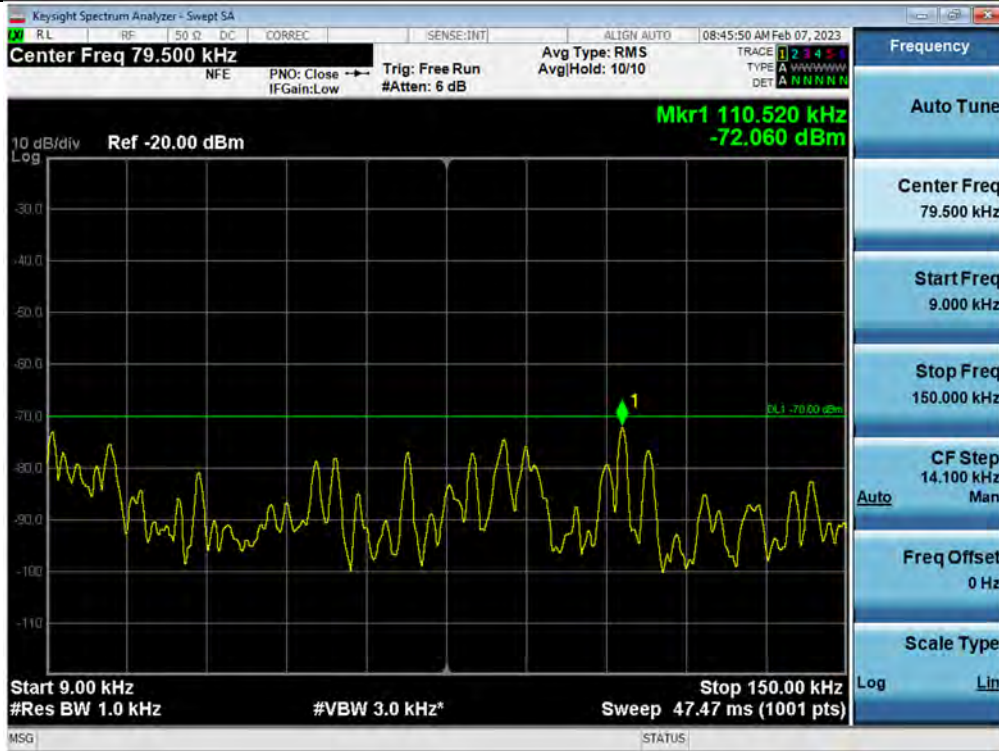

Spurious / 3.45 GHz Service / Downlink / 5G NR 80 MHz / Middle / 150 kHz ~ 30 MHz

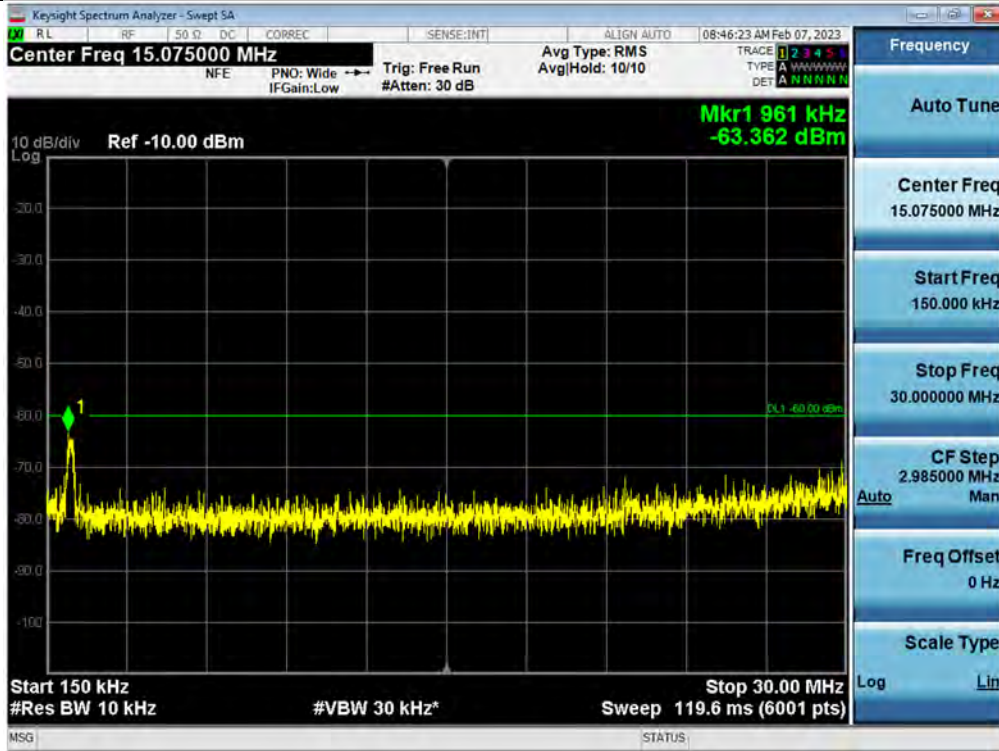

Spurious / 3.45 GHz Service / Downlink / 5G NR 80 MHz / High / 30 MHz ~ 3 430 MHz

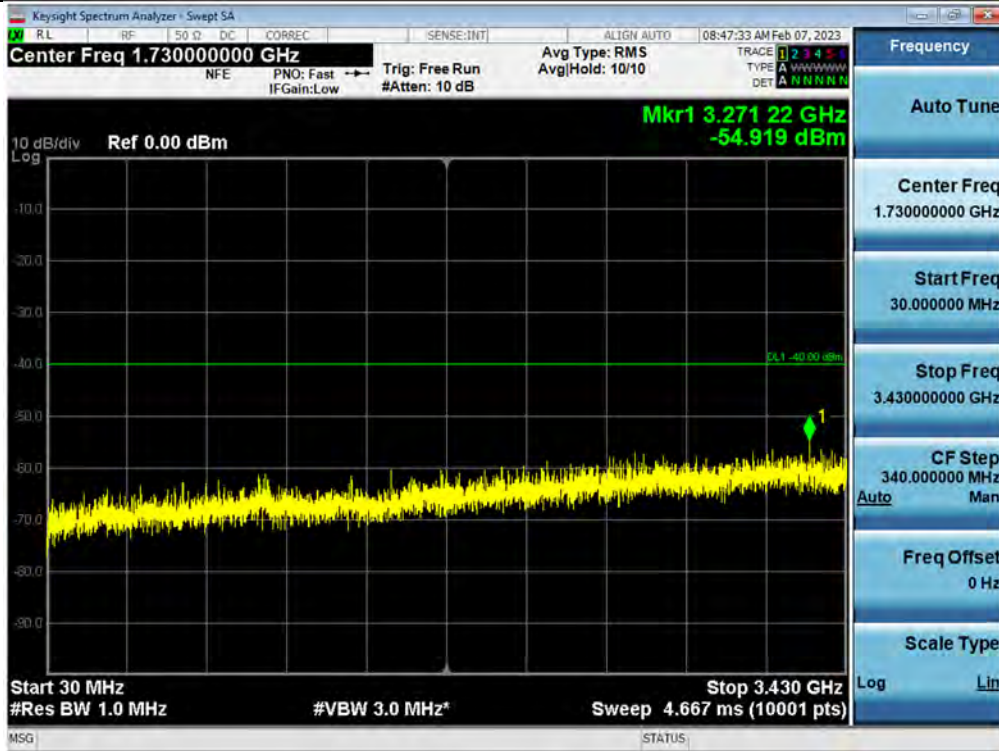

Spurious / 3.45 GHz Service / Downlink / 5G NR 80 MHz / High / 3 430 MHz ~ 3 440 MHz

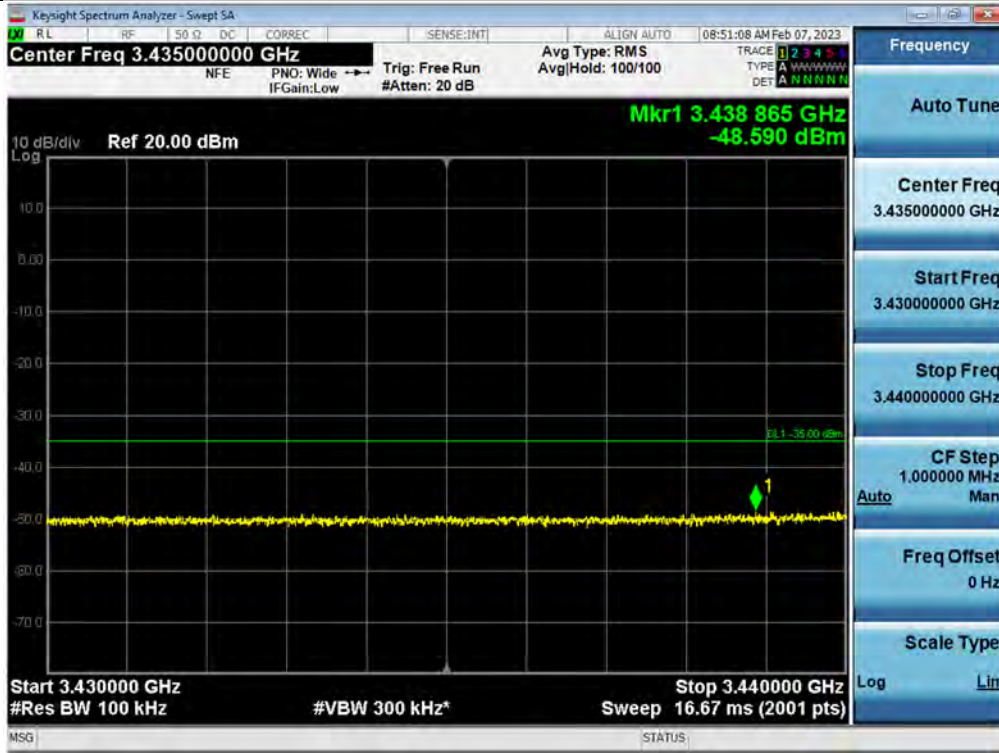

Spurious / 3.45 GHz Service / Downlink / 5G NR 80 MHz / Middle / 3 440 MHz ~ Low Edge

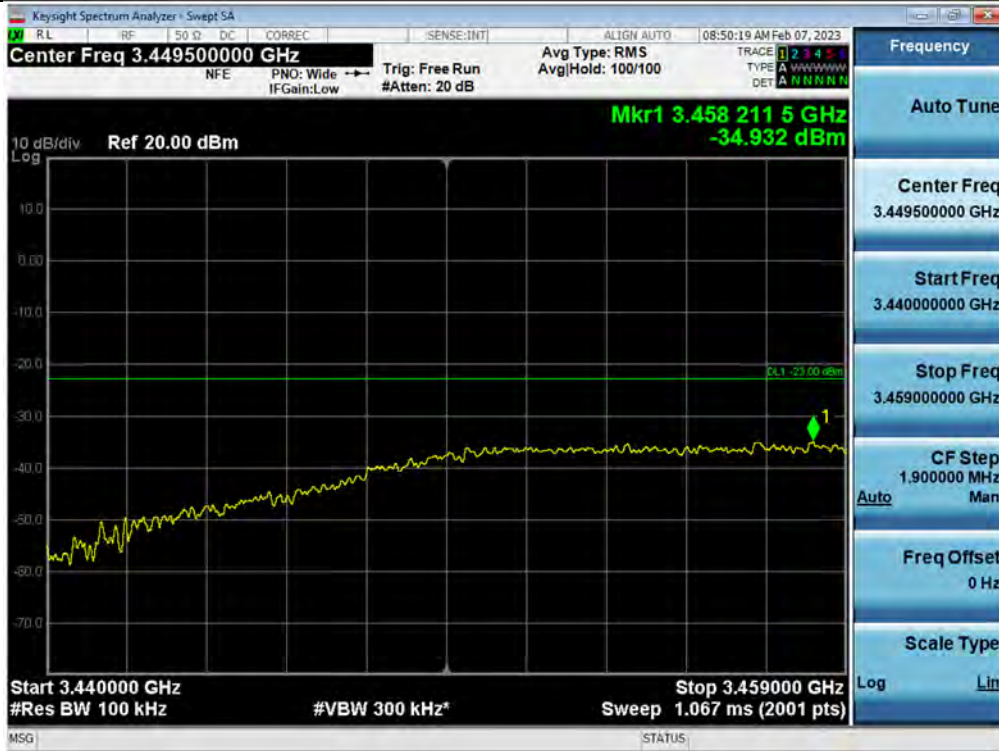

Spurious / 3.45 GHz Service / Downlink / 5G NR 80 MHz / Middle / High Edge ~ 3 560 MHz



Spurious / 3.45 GHz Service / Downlink / 5G NR 80 MHz / Low / 3 560 MHz ~ 3 570 MHz



*Limit: -35 dBm/MHz

Spurious / 3.45 GHz Service / Downlink / 5G NR 80 MHz / Low / 3 570 MHz ~ 10 GHz

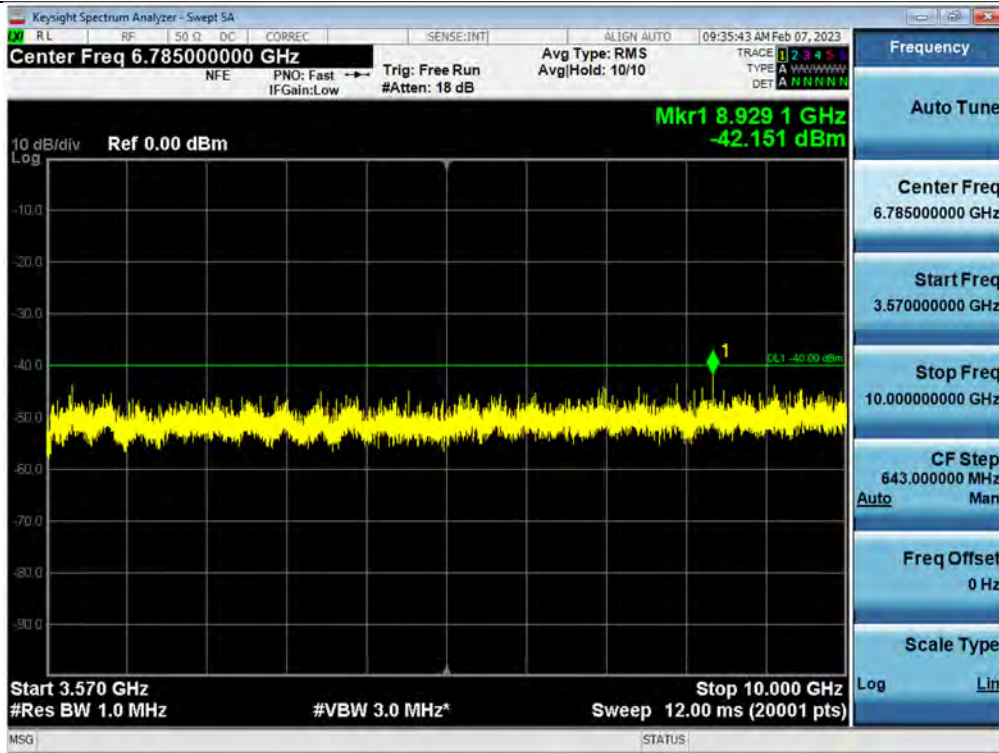

Spurious / 3.45 GHz Service / Downlink / 5G NR 80 MHz / Low / 10 GHz ~ 40 GHz

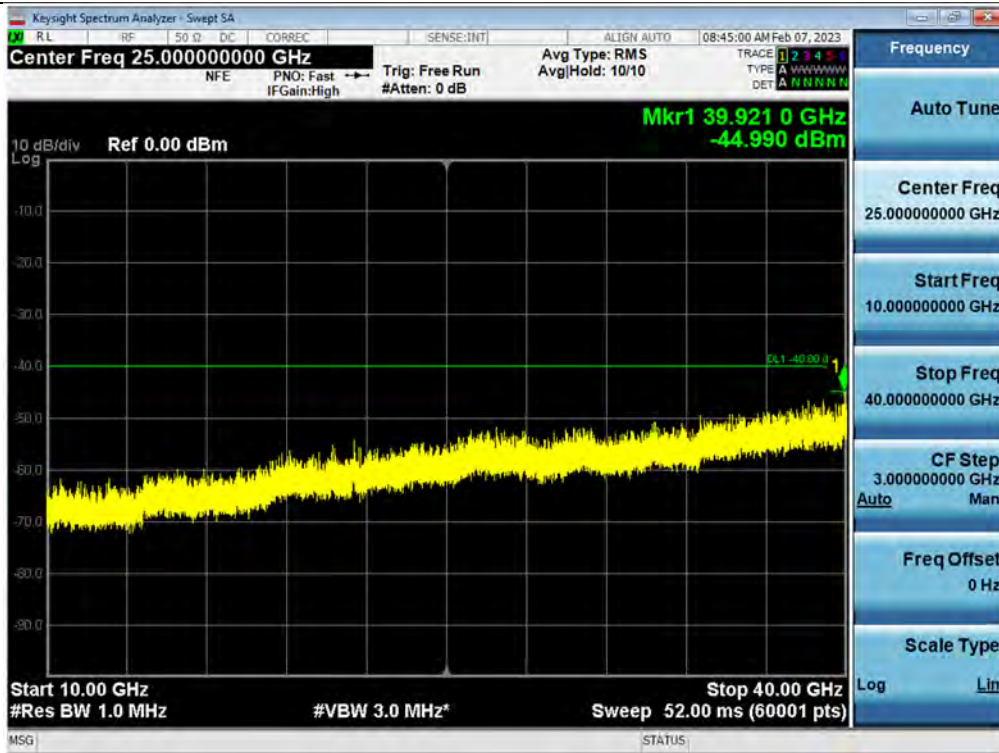

Spurious / 3.45 GHz Service / Downlink / 5G NR 100 MHz / Middle / 9 kHz ~ 150 kHz

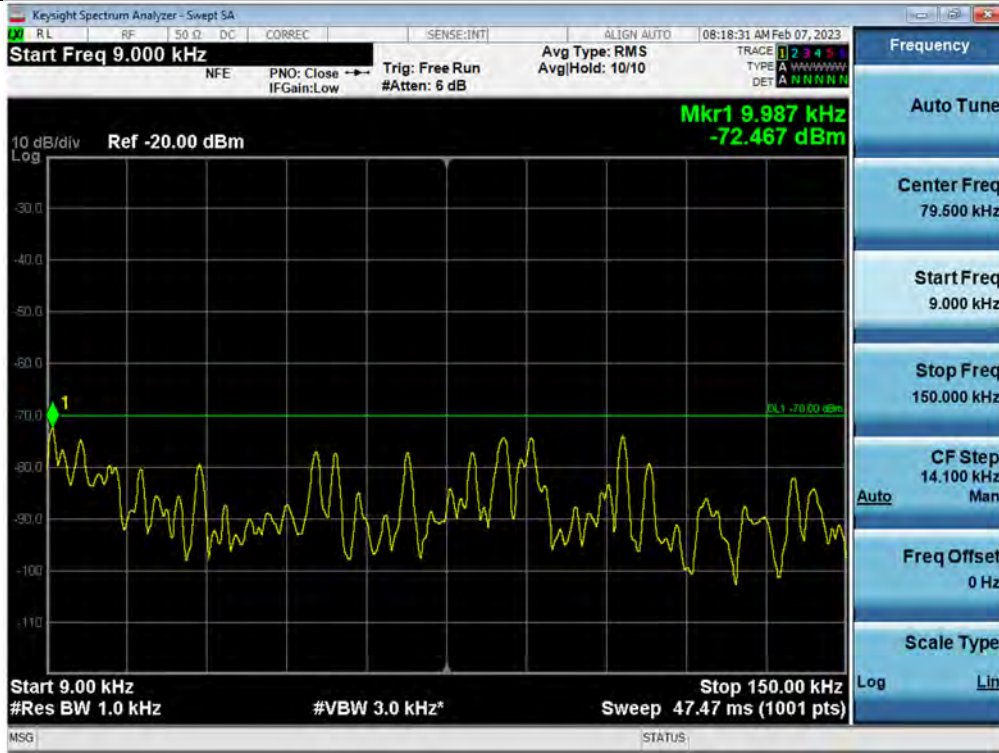

Spurious / 3.45 GHz Service / Downlink / 5G NR 100 MHz / Middle / 150 kHz ~ 30 MHz



Spurious / 3.45 GHz Service / Downlink / 5G NR 100 MHz / Middle / 30 MHz ~ 3 430 MHz



Spurious / 3.45 GHz Service / Downlink / 5G NR 100 MHz / Middle / 3 430 MHz ~ 3 440 MHz

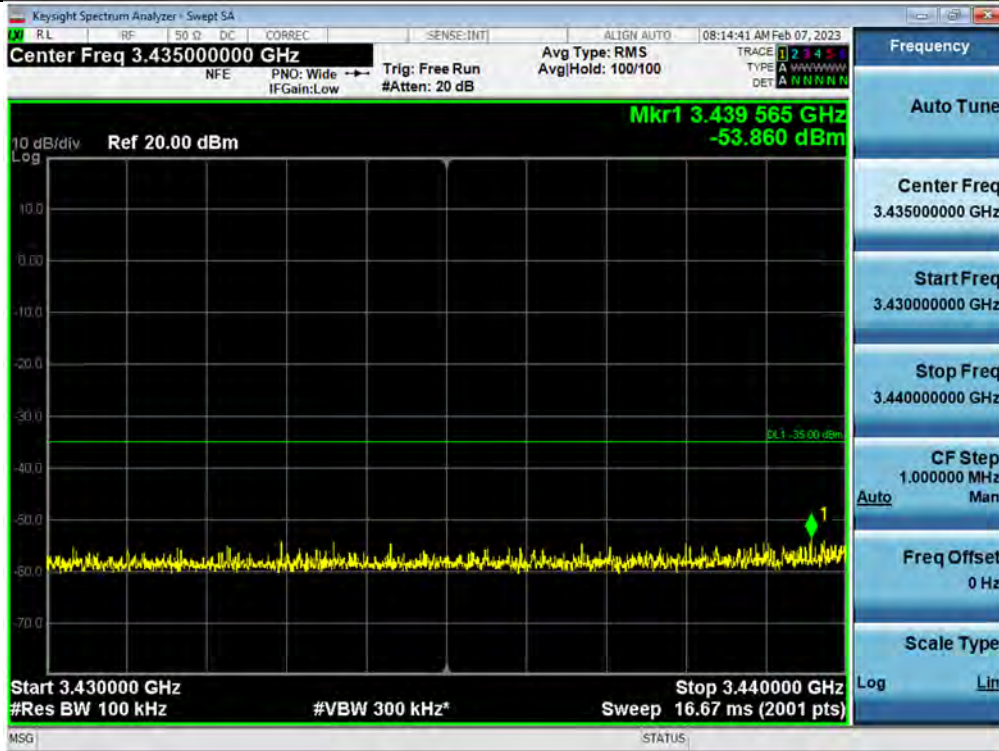

Spurious / 3.45 GHz Service / Downlink / 5G NR 100 MHz / Middle / 3 440 MHz ~ Low Edge

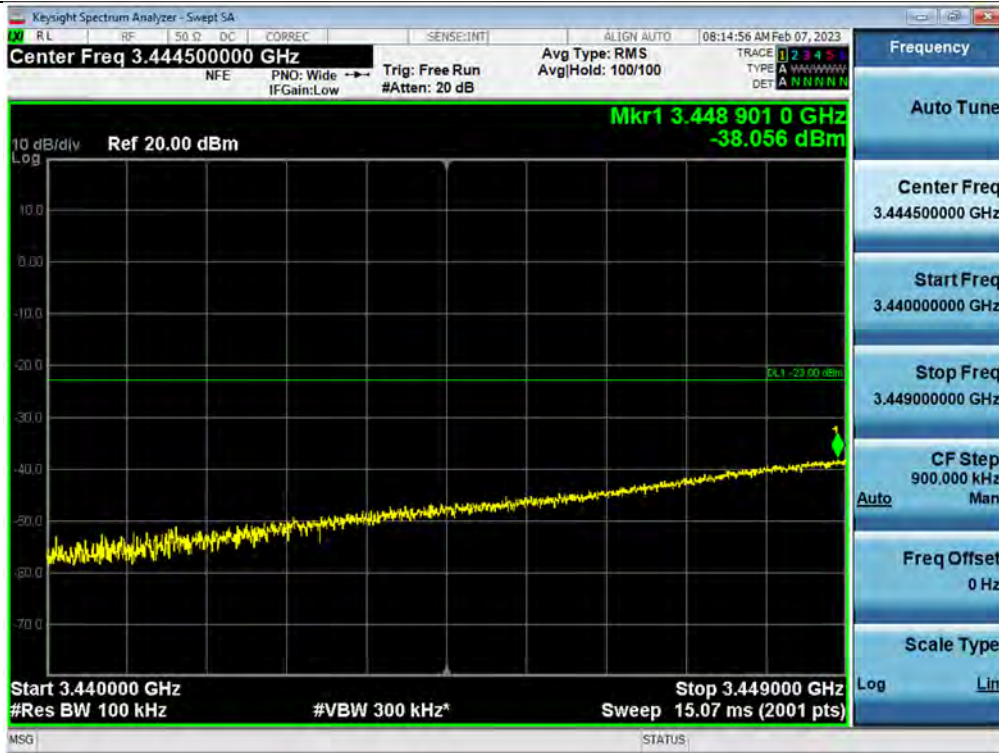

Spurious / 3.45 GHz Service / Downlink / 5G NR 100 MHz / Middle / High Edge ~ 3 560 MHz

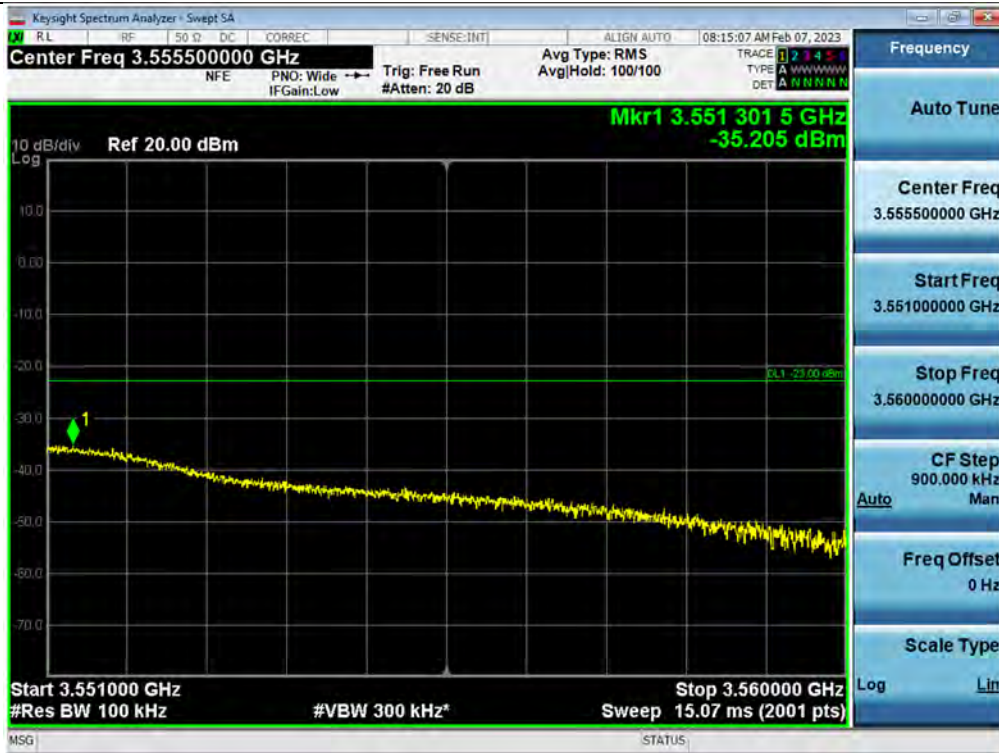

Spurious / 3.45 GHz Service / Downlink / 5G NR 100 MHz / Middle / 3 560 MHz ~ 3 570 MHz

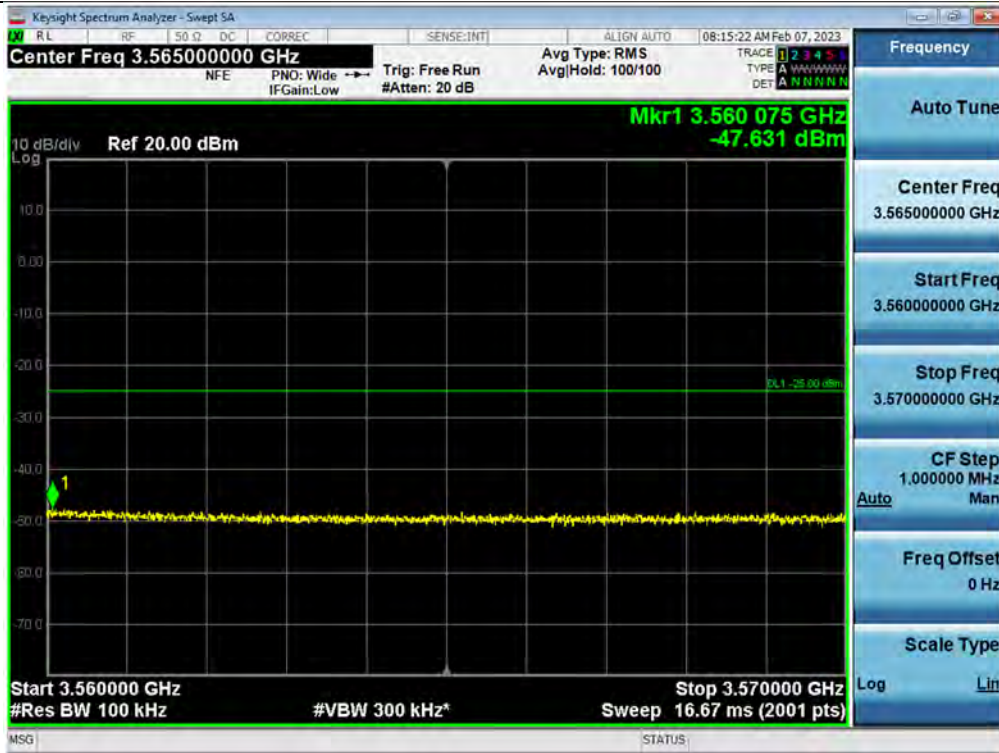

*Limit: -35 dBm/MHz

Spurious / 3.45 GHz Service / Downlink / 5G NR 100 MHz / Middle / 3 570 MHz ~ 10 GHz

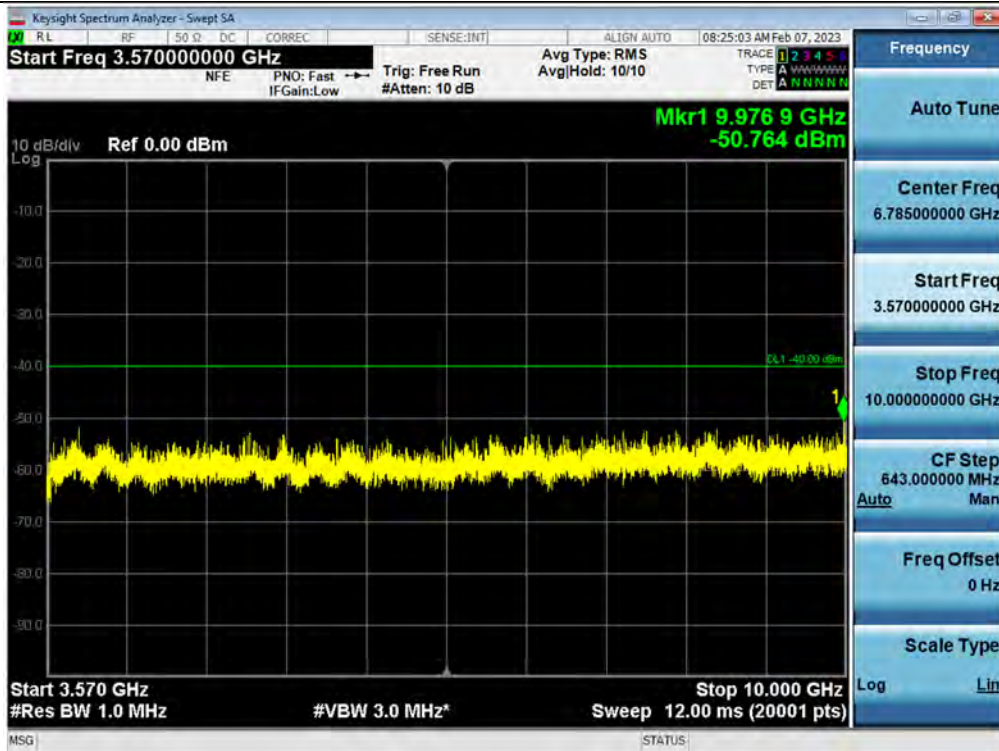

Spurious / 3.45 GHz Service / Downlink / 5G NR 100 MHz / Middle / 10 GHz ~ 40 GHz

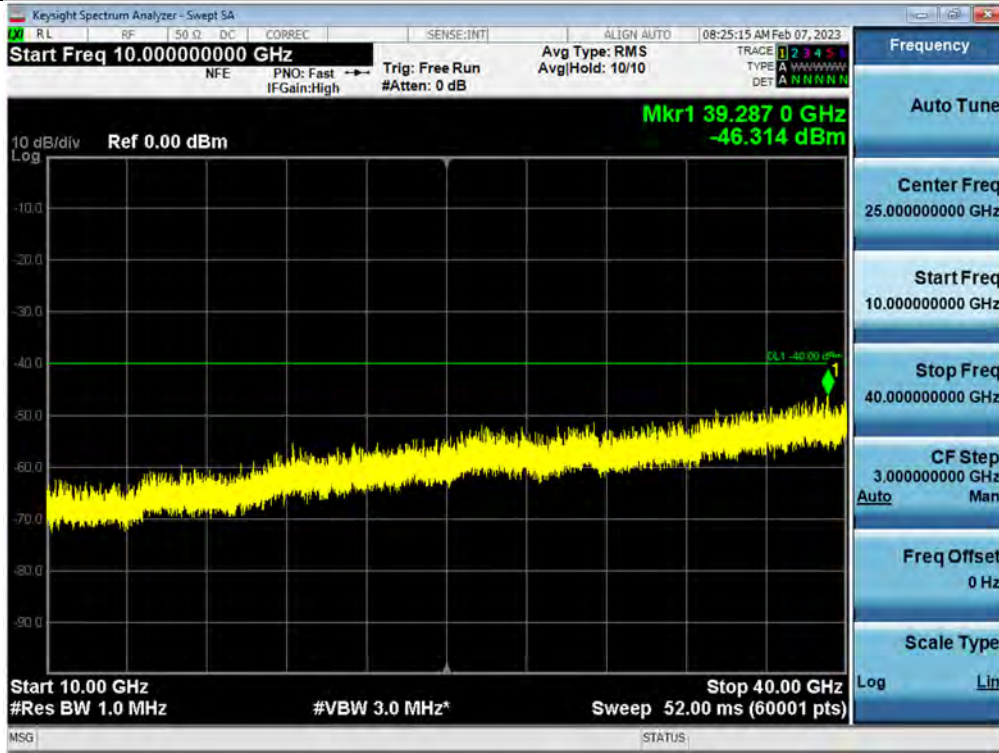

Note : Only the worst case Spurious Emissions plots are attached for each frequency range.

5.6. RADIATED SPURIOUS EMISSIONS

Test Requirements:

§ 2.1053 Measurements required: Field strength of spurious radiation.

- (a) Measurements shall be made to detect spurious emissions that may be radiated directly from the cabinet, control circuits, power leads, or intermediate circuit elements under normal conditions of installation and operation. Curves or equivalent data shall be supplied showing the magnitude of each harmonic and other spurious emission. For this test, single sideband, independent sideband, and controlled carrier transmitters shall be modulated under the conditions specified in paragraph (c) of § 2.1049, as appropriate. For equipment operating on frequencies below 890 MHz, an open field test is normally required, with the measuring instrument antenna located in the far-field at all test frequencies. In the event it is either impractical or impossible to make open field measurements (e.g. a broadcast transmitter installed in a building) measurements will be accepted of the equipment as installed. Such measurements must be accompanied by a description of the site where the measurements were made showing the location of any possible source of reflections which might distort the field strength measurements. Information submitted shall include the relative radiated power of each spurious emission with reference to the rated power output of the transmitter, assuming all emissions are radiated from halfwave dipole antennas.
- (b) The measurements specified in paragraph (a) of this section shall be made for the following equipment:
- (1) Those in which the spurious emissions are required to be 60 dB or more below the mean power of the transmitter.
 - (2) All equipment operating on frequencies higher than 25 MHz.
 - (3) All equipment where the antenna is an integral part of, and attached directly to the transmitter.
 - (4) Other types of equipment as required, when deemed necessary by the Commission.

27.53 Emission limits.

- (n) 3.45 GHz Service. The following emission limits apply to stations transmitting in the 3450-3550 MHz band:
- (1) For base station operations in the 3450-3550 MHz band, the conducted power of any emission outside the licensee's authorized bandwidth shall not exceed -13 dBm/MHz. Compliance with the provisions of this paragraph (n)(1) is based on the use of measurement instrumentation employing a resolution bandwidth of 1 megahertz or greater. However, in the 1 megahertz bands immediately outside and adjacent to the licensee's frequency block, a resolution bandwidth of at least one percent of the emission bandwidth of the fundamental emission of the transmitter may be employed, but limited to a maximum of 200 kHz. The emission bandwidth is defined as the width of the signal between two points, one below the carrier center frequency and one above the carrier center frequency, outside of which all emissions are attenuated at least 26 dB below the transmitter power. Notwithstanding the channel edge requirement of -13 dBm per megahertz, for base station operations in the 3450-3550 MHz band, the conducted power of any emission below 3440 MHz or above 3560 MHz shall not exceed -25 dBm/MHz, and the conducted power of emissions below 3430 MHz or above 3570 MHz shall not exceed -40 dBm/MHz.

Test Procedures:

Because KDB 935210 D05 procedure does not provide this requirement, measurements were in accordance with the test methods section 5.5 of ANSI C63.26-2015

- a) Place the EUT in the center of the turntable. The EUT shall be configured to transmit into the standard non-radiating load (for measuring radiated spurious emissions), connected with cables of minimal length unless specified otherwise. If the EUT uses an adjustable antenna, the antenna shall be positioned to the length that produces the worst case emission at the fundamental operating frequency.
- b) Each emission under consideration shall be evaluated:
 - 1) Raise and lower the measurement antenna in accordance 5.5.2, as necessary to enable detection of the maximum emission amplitude relative to measurement antenna height.
 - 2) Rotate the EUT through 360° to determine the maximum emission level relative to the axial position.
 - 3) Return the turntable to the azimuth where the highest emission amplitude level was observed.
 - 4) Vary the measurement antenna height again through 1 m to 4 m again to find the height associated with the maximum emission amplitude.
 - 5) Record the measured emission amplitude level and frequency using the appropriate RBW.
- c) Repeat step b) for each emission frequency with the measurement antenna oriented in both the horizontal and vertical polarizations to determine the orientation that gives the maximum emissions amplitude.

Note:

All power supplies of operation were investigated and the worst case configuration results are reported.

- Mode: 100~240 VAC, 50/60 Hz / 36~76 VDC

- Worst case: 100~240 VAC, 50/60 Hz

Test Result:

Band Name	Mode	Frequency (MHz)	Measured Level (dBUV)	Ant. Factor (dB/m)	A.G.+C.L.+H.P.F. (dB)	Pol.	Measured Power (dBm)	Result (dBm/m)
-----------	------	-----------------	-----------------------	--------------------	-----------------------	------	----------------------	----------------

No Critical Peaks Found.

* C.L.: Cable Loss / A.G.: Amp. Gain / H.P.F.: High Pass Filter

Note:

1. We have done horizontal and vertical polarization in detecting antenna.
2. Measure distance = 3 m
3. The amplitude of the spurious domain emission attenuated by more than 20 dB over the permissible value was not recorded according to ANSI C63.26, clause 5.1.1., c).
4. We have also tested all the additional models (-) and attached only the worst case plot of each model.

Plot data of radiated spurious emissions

Downlink / 5G NR 20 MHz / AC

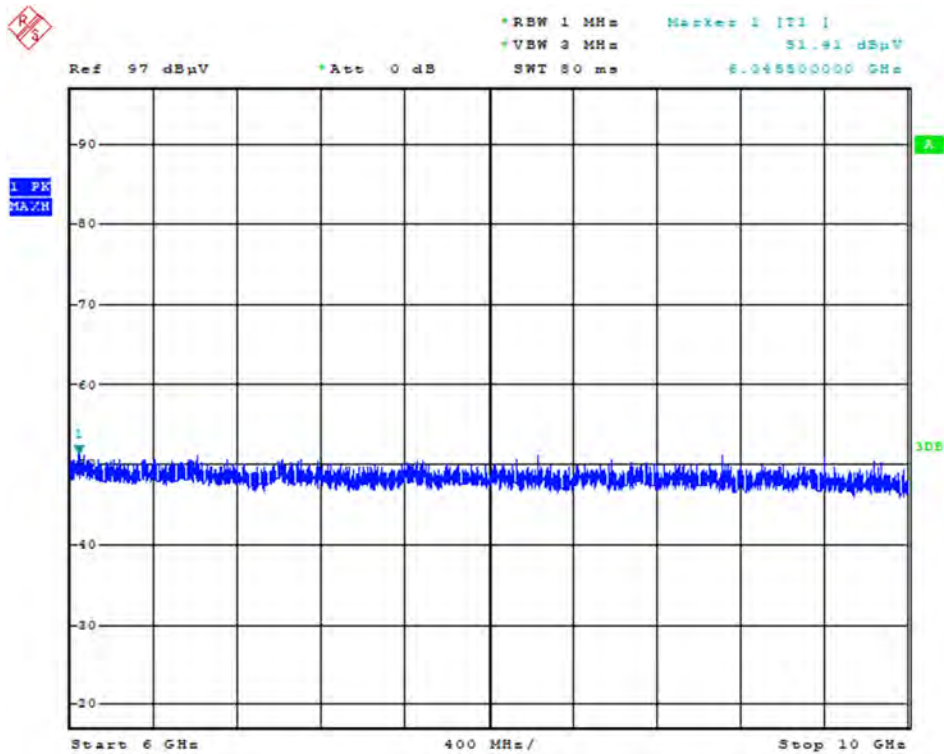

Note : Only the worst case plots for Radiated Spurious Emissions.

Downlink / 5G NR 100 MHz / DC

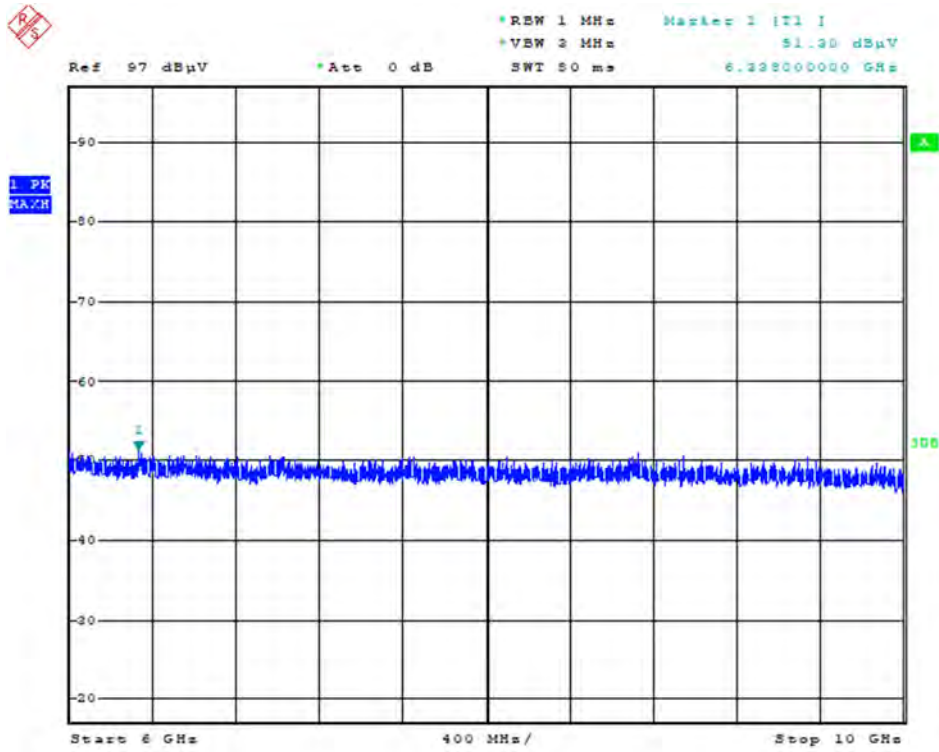

Note : Only the worst case plots for Radiated Spurious Emissions.

Downlink / 5G NR 100 MHz / AC + Battery

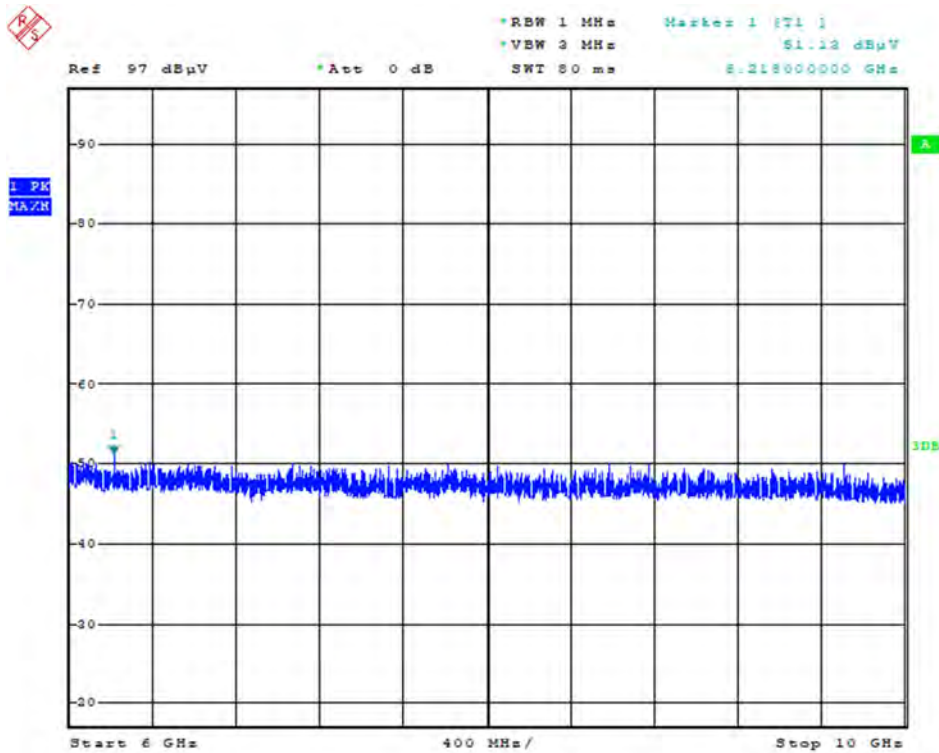

Note : Only the worst case plots for Radiated Spurious Emissions.

5.7. FREQUENCY STABILITY

Test Requirements:

§ 2.1055 Measurements required: Frequency stability.

- (a) The frequency stability shall be measured with variation of ambient temperature as follows:
- (1) From -30° to $+50^{\circ}$ centigrade for all equipment except that specified in paragraphs (a) (2) and (3) of this section.
 - (2) From -20° to $+50^{\circ}$ centigrade for equipment to be licensed for use in the Maritime Services under part 80 of this chapter, except for Class A, B, and S Emergency Position Indicating Radiobeacons (EPIRBS), and equipment to be licensed for use above 952 MHz at operational fixed stations in all services, stations in the Local Television Transmission Service and Point-to-Point Microwave Radio Service under part 21 of this chapter, equipment licensed for use aboard aircraft in the Aviation Services under part 87 of this chapter, and equipment authorized for use in the Family Radio Service under part 95 of this chapter.
 - (3) From 0° to $+50^{\circ}$ centigrade for equipment to be licensed for use in the Radio Broadcast Services under part 73 of this chapter.
- (d) The frequency stability shall be measured with variation of primary supply voltage as follows:
- (1) Vary primary supply voltage from 85 to 115 percent of the nominal value for other than hand carried battery equipment.
 - (2) For hand carried, battery powered equipment, reduce primary supply voltage to the battery operating end point which shall be specified by the manufacturer.
 - (3) The supply voltage shall be measured at the input to the cable normally provided with the equipment, or at the power supply terminals if cables are not normally provided. Effects on frequency of transmitter keying (except for broadcast transmitters) and any heating element cycling at the nominal supply voltage and at each extreme also shall be shown.

§ 27.54 Frequency stability.

The frequency stability shall be sufficient to ensure that the fundamental emissions stay within the authorized bands of operation.

Test Procedures:

The measurement is performed in accordance with Section 5.6.3, 5.6.4 and 5.6.5 of ANSI C63.26.

5.6.3 Procedure for frequency stability testing

Frequency stability is a measure of the frequency drift due to temperature and supply voltage variations, with reference to the frequency measured at +20 °C and rated supply voltage.

The operating carrier frequency shall be set up in accordance with the manufacturer's published operation and instruction manual prior to the commencement of these tests. No adjustment of any frequency determining circuit element shall be made subsequent to this initial set-up. Frequency stability is tested:

- a) At 10 °C intervals of temperatures between –30 °C and +50 °C at the manufacturer's rated supply voltage, and
- b) At +20 °C temperature and $\pm 15\%$ supply voltage variations. If a product is specified to operate over a range of input voltage then the –15% variation is applied to the lowermost voltage and the +15% is applied to the uppermost voltage.

During the test all necessary settings, adjustments and control of the EUT have to be performed without disturbing the test environment, i.e., without opening the environmental chamber. The frequency stabilities can be maintained to a lesser temperature range provided that the transmitter is automatically inhibited from operating outside the lesser temperature range. For handheld equipment that is only capable of operating from internal batteries and the supply voltage cannot be varied, the frequency stability tests shall be performed at the nominal battery voltage and the battery end point voltage specified by the manufacturer. An external supply voltage can be used and set at the internal battery nominal voltage, and again at the battery operating end point voltage which shall be specified by the equipment manufacturer.

If an unmodulated carrier is not available, the mean frequency of a modulated carrier can be obtained by using a frequency counter with gating time set to an appropriately large multiple of bit periods (gating time depending on the required accuracy). Full details on the choice of values shall be included in the test report.

5.6.4 Frequency stability over variations in temperature

- a) Supply the EUT with a nominal 60 Hz ac voltage, dc voltage, or install a new or fully charged battery in the EUT.
- b) If possible a dummy load should be connected to the EUT because an antenna near the metallic walls of an environmental test chamber could affect the output frequency of the EUT. If the EUT is equipped with a permanently attached, adjustable-length antenna, the EUT should be placed in the center of the chamber with the antenna adjusted to the shortest length possible.
- c) Turn on the EUT, and tune it to the center frequency of the operating band.
- d) Couple the transmitter output to the measuring instrument through a suitable attenuator and coaxial cable. If connection to the EUT output is not possible, make the measurement by connecting an antenna to the measuring instrument with a suitable length of coaxial cable and placing the measuring antenna near the EUT (e.g., 15 cm away).

NOTE—An instrument that has an adequate level of accuracy as specified by the procuring or regulatory authority is the recommended measuring instrument.

- e) Adjust the location of the measurement antenna and the controls on the measurement instrument to obtain a suitable signal level (i.e., a level that will not overload the measurement instrument, but is strong enough to allow measurement of the operating or fundamental frequency of the EUT). Adjust the detector bandwidth and span settings to achieve a resolution capable of accurate frequency measurements over the applicable frequency stability limits.
- f) Turn the EUT off, and place it inside the environmental temperature chamber. For devices that have oscillator heaters, energize only the heater circuit.
- g) Set the temperature control on the chamber to the Highest temperature specified in the regulatory requirements for the type of device, and allow the oscillator heater and the chamber temperature to stabilize. Unless otherwise instructed by the regulatory authority, this temperature should be 50 °C.
- h) While maintaining a constant temperature inside the environmental chamber, turn on the EUT and allow sufficient time for the EUT temperature to stabilize.
- i) Measure the frequency.
- j) Switch off the EUT, but do not switch off the oscillator heater.
- k) Lower the chamber temperature to the next level that is required by the standard and allow the temperature inside the chamber to stabilize. Unless otherwise instructed by the regulators, this temperature step should be 10 °C.
- l) Repeat step h) through step k) down to the lowest specified temperature. Unless otherwise instructed by the regulators, this temperature should be –30 °C. When the frequency stability limit is stated as being sufficient such that the fundamental emissions stay within the authorized bands of operation, a reference point shall be established at the applicable unwanted emissions limit using a RBW equal to the RBW required by the unwanted emissions specification of the applicable regulatory standard. These reference points measured using the lowest and Highest channel of operation shall be identified as f_L and f_H respectively. The worst-case frequency offset determined in the above methods shall be added or subtracted from the values of f_L and f_H and the resulting frequencies must remain within the band.
- m) Omitted

5.6.5 Frequency stability when varying supply voltage

- a) Couple the transmitter output to the measuring instrument through a suitable attenuator and coaxial cable. If connection to the EUT output is not possible make the measurement by connecting an antenna to the measuring instrument with a suitable length of coaxial cable and placing the measuring antenna near the EUT (e.g., 15 cm away)
- b) Supply the EUT with nominal ac or dc voltage. The supply voltage shall be measured at the input to the cable normally provided with the equipment, or at the power supply terminals if cables are not normally provided. Effects on frequency of transmitter keying (except for broadcast transmitters) and any heating element cycling at the nominal supply voltage and at each extreme also shall be shown.
- c) Turn on the EUT, and couple its output to a frequency counter or other frequency-measuring instrument.
- d) Tune the EUT to the center frequency of the operating band. Adjust the location of the measurement antenna

and the controls on the measurement instrument to obtain a suitable signal level (i.e., a level that will not overload the measurement instrument, but is strong enough to allow measurement of the operating or fundamental frequency of the EUT). Adjust the detector bandwidth and span settings to achieve a resolution capable of accurate frequency measurements over the applicable frequency stability limits.

NOTE—An instrument that has an adequate level of accuracy as specified by the procuring or regulatory authority is the recommended measuring instrument.

- e) Measure the frequency.
- f) Unless otherwise specified, vary primary supply voltage from 85% to 115% of the nominal value for other than hand carried battery equipment.
- g) For hand carried, battery powered equipment, reduce the primary ac or dc supply voltage to the battery operating end point, which shall be specified by the manufacturer.
- h) Repeat the frequency measurement.

NOTE—For band-edge compliance, it can be required to make these measurements at the low and High channel of the operating band.

Note:

- (1) The results of the frequency stability test shown above the frequency deviation measured values are very small and similar trend for each port, so we are attached only the worst case data.
- (2) All power supplies of operation were investigated and the worst case configuration results are reported.
 - Mode: 100~240 VAC, 50/60 Hz / 36~76 VDC
 - Worst case: 100~240 VAC, 50/60 Hz

Test Results:

Reference: 110 Vac at 20°C Freq. = 3 500,000,000 Hz

Voltage (%)	Temp. (°C)	Frequency (Hz)	Frequency Error (Hz)	Deviation (Hz)	ppm
100 %	+20(Ref)	3 500 000 009	9.040	0.000	0.00000
	-30	3 500 000 013	3.621	-5.419	-0.00155
	-20	3 500 000 016	6.531	-2.509	-0.00072
	-10	3 500 000 018	9.119	0.079	0.00002
	0	3 500 000 012	3.084	-5.956	-0.00170
	+10	3 500 000 016	6.989	-2.051	-0.00059
	+30	3 500 000 009	0.041	-8.999	-0.00257
	+40	3 500 000 013	3.797	-5.242	-0.00150
	+50	3 500 000 015	5.994	-3.046	-0.00087
115 %	+20	3 500 000 012	3.424	-5.616	-0.00160
85 %	+20	3 500 000 019	9.883	0.843	0.00024

6. Annex A_EUT AND TEST SETUP PHOTO

Please refer to test setup photo file no. as follows;

No.	Description
1	HCT-RF-2303-FC003-P