

ADXV DAS User Manual

Version 1.5

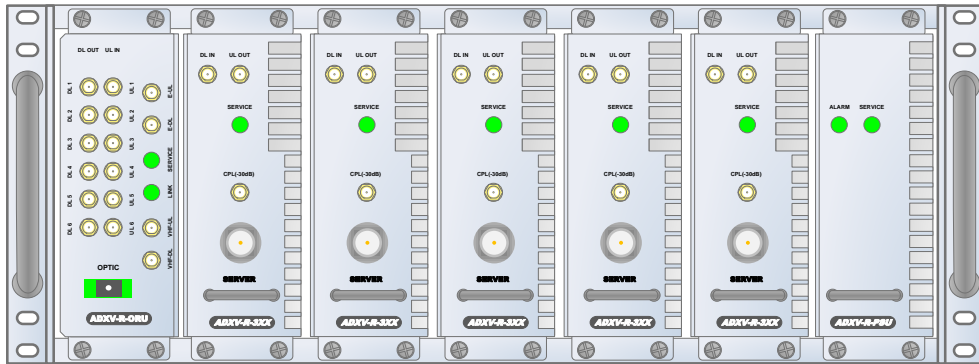

3116 West Vanowen St.
 Burbank, CA 91505
 Tel: 818-840-8131
 Fax: 818-840-8138
www.adrftech.com

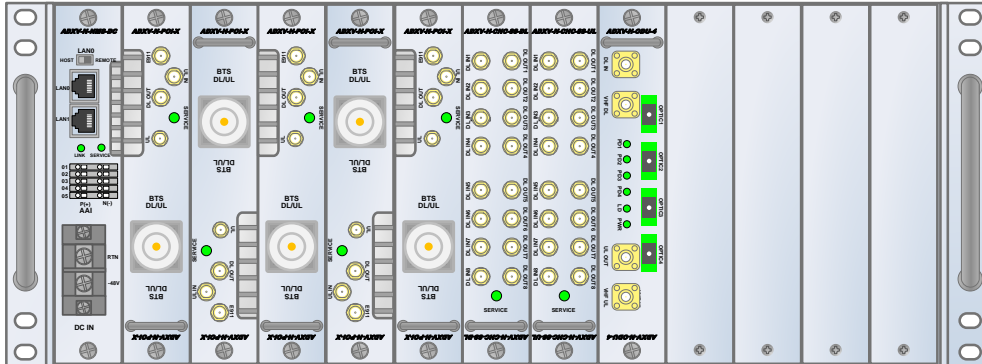

Information in this document is subject to change without notice.

***Advanced RF Technologies, Inc. 1996-2015.
All rights reserved.***

- Please send comments to:

E-Mail: info@adrfttech.com

Phone: (818) 840-8131

(800) 313-9345

Fax: (818) 840-8138

- Address:

Advanced RF Technologies, Inc.
Attention: Technical Publications Department
3116 Vanowen St.
Burbank, CA 91505
USA
www.adrfttech.com

Revision History

Version	Author	Descriptions	Date
0.1	YH Ko	Initial Release	03/07/2016
0.9	YH Ko	VU, WCS, BRS, PS78 added	
1.0	CK CHO	VU External Filter, Frequency Range Change Update	07/05/2017
1.1	CK CHO	Add Warning Statement	07/25/2017
1.3	CK CHO	Add 600MHz Band	01/18/2018
1.31	CK CHO	Revision Update	01/26/2018
1.4	CK Cho	BTF	11/28/2019
1.5	CK Cho	Add 900MHz Band	07/03/2020

Change List

Version	Change list	Contents

Table of Contents

1.	Introduction	11
1.1	Highlights	11
1.2	ADXV DAS Quick View	12
1.2.1	HE Quick View	12
1.2.2	RU Quick View	13
1.3	Warnings and Hazards	13
2.	Block Diagram	18
2.1	ADXV DAS Block Diagram	18
2.2	ADXV-DAS Scalability	19
3.	ADxv Overview	20
3.1	Head End	20
3.1.1	NMS (Network Management System)	21
3.1.1.1	LEDs	22
3.1.1.2	AAI (only for DC type)	22
3.1.1.3	Ethernet Port	23
3.1.1.4	Host/Remote Switch	23
3.1.1.5	Power Connection	24
3.1.1.6	POI (ADXV-H-POI-x)	25
3.1.2	POIL (ADXV-H-POIL-x)	26
3.1.3	POIL-VU (ADXV-H-POIL-VU)	27
3.1.3.1	LED	27
3.1.3.2	RF Ports	28
3.1.4	Channel Combiner (CHC, ADXV-H-CHC)	28
3.1.4.1	RF ports	29
3.1.5	Optical Donor Unit (ODU, ADXV-H-ODU-4)	29
3.1.5.1	LED	29
3.1.5.2	RF Ports	30
3.1.5.3	Optic Ports	30
3.2	Remote Unit (RU)	30
3.2.1	Remote Module (RM, ADXV-R-3xx)	32
3.2.1.1	RM ID numbering and RF line connection scheme	32
3.2.1.2	RF port	33
3.2.1.3	Power port	33
3.2.1.4	LED	33
3.2.2	Optical Remote Unit (ORU, ADXV-R-ORU)	33
3.2.2.1	Front port	33
3.2.2.2	Rear port	34

3.2.2.3	LED	34
3.2.3	PSU (ADXV-R-PSU)	34
3.2.3.1	Port	34
3.2.3.2	LED	35
3.2.3.3	AC Switch	35
3.3	Remote Unit (RU) for N4X.....	오류! 책갈피가 정의되어 있지 않습니다.
3.3.1	Port	35
4.	Cable Connection	36
4.1	Head End Connection Diagrams	36
4.2	Remote Unit Connection Diagrams	37
5.	Mounting method	38
5.1	Head End.....	38
5.1.1	Rack Mount	38
5.2	RU	39
5.2.1	Rack Mount	39
6.	Installation	39
6.1	Pre-Installation Inspection	39
6.2	ADXV DAS Installation Procedure	40
6.2.1	HE Installation Procedure	40
6.2.1.1	Installing a ADXV DAS HE in a rack.....	40
6.2.2	RU Installation Procedure.....	42
6.2.3	RF coaxial cable and antenna connection	44
6.3	Grounding	44
6.4	Optic Port Cleaning	45
7.	Web-GUI	46
7.1	Web-GUI Setup	46
7.1.1	DAS system/PC Connection Using Web-GUI	46
7.2	Administrator/User Mode	47
7.2.1	Common	47
7.2.1.1	Navigation Tree.....	47
7.2.1.2	Power Status	47
7.2.1.3	Commissioning Status.....	47
7.2.1.4	Information	47
7.2.2	Status Tab	49
7.2.2.1	Status – NMS	49
7.2.3	System	52
7.2.3.1	System: Account	52
7.2.3.2	System: Logs	53
7.2.3.3	System: Update.....	54

7.2.4	Help	54
7.2.5	Logout.....	55
7.3	Guest Mode	55
8.	System-Wide Specification	56
9.	Mechanical Drawing	60
9.1	HE.....	60
9.2	RU	61
9.3	N4X RU for PS78	62
9.4	N4X RU for VU.....	63

Figures

Figure 2-1	ADXV DAS HE Quick View (Front and Rear)	12
Figure 2-2	ADXV DAS RU Quick View (Front and Rear).....	13
Figure 2-1	ADXV DAS Block Diagram	18
Figure 3-1	Head End Front View	20
Figure 3-2	ADXV-H-NMS-DC Front View	21
Figure 3-3	ADXV-H-NMS-AC Front View	22
Figure 3-4	NMS LED	22
Figure 3-5	NMS AAI.....	23
Figure 3-6	Ethernet Port	23
Figure 3-7	Host/Remote Switch.....	24
Figure 3-8	POI front View	25
Figure 3-9	POIL front View.....	26
Figure 3-10	POIL-VU front View.....	27
Figure 3-11	POI LED	27
Figure 3-12	ADXV-H-CHC Front View	28
Figure 3-13	ADXV-H-ODU-4 Front view	29
Figure 3-14	ADXV-H-ODU-4 LED	30
Figure 3-15	ODU RF Ports	30
Figure 3-16	ODU Optic Ports.....	30
Figure 3-17	ADXV-R Front and Rear (without FAN and with FAN) View.....	31
Figure 3-18	ADXV-R-3XX (RM) Front and Rear View.....	32
Figure 3-19	RM ID numbering and RF connection between ORU and RM	32
Figure 3-20	ADXV-R-ORU Front and Rear View	33
Figure 3-21	ADXV-R-PSU Front and Rear View	34
Figure 3-22	ADXV-R-PSU Front and Rear View	35
Figure 3-23	ADXV-R-3378P-N4X Front and Bottom View	오류! 책갈피가 정의되어 있지 않습니다.
Figure 3-24	ADXV-R-25VU-N4X Front and Bottom View	오류! 책갈피가 정의되어 있지 않습니다.
Figure 4-1	HE Cable connection (4 ADXV-H-POIs, 2 ADXV-H-ODUs)	36
Figure 4-2	ADXV-RU 5sands connection.....	37
Figure 5-1	HE Rack Mount (Front & Rear view)	38
Figure 5-2	RU Rack Mount Front and Rear View	39
Figure 6-1	HE Installation Procedure	41
Figure 6-2	RU Installation Procedure	43
Figure 6-3	HE Ground Cable Connection, Protective Earthing Conductor (HE chassis rear side).....	44
Figure 6-4	RU Ground Cable Connection, Protective Earthing Conductor (RU chassis rear side)	44
Figure 6-5	Optic Connector Cleaning (left) and Optic Port Cleaning (right)	45
Figure 6-6	SC/APC Optic Connector Dust Cap	45
Figure 7-1	Login screen.....	46
Figure 7-2	ADXV DAS General Information.....	48
Figure 7-3	SNMP (Install – NMS).....	49
Figure 7-4	Location Setting (Install – NMS)	50
Figure 7-5	External Modem Box Setting (Install – NMS)	50
Figure 7-6	Description (Install – NMS).....	50
Figure 7-7	SNMP Agent False Alarm Test (Install – NMS).....	51
Figure 7-8	Location Info / Installer Info (Install – NMS).....	51
Figure 7-9	Date & Time Setting (Install – NMS)	52
Figure 7-10	Description (Install-Remote Module)	52
Figure 7-11	Account Management	52
Figure 7-12	New Account	53

Figure 7-13	Change Password.....	53
Figure 7-14	User Log	54
Figure 7-15	System update	54
Figure 7-16	Message after System update is complete.....	54
Figure 7-17	Help.....	55
Figure 9-1	HE Drawing	60
Figure 9-2	RU Drawing	61
Figure 9-3	PS78 N4X RU Drawing.....	62
Figure 9-4	VU N4X RU Drawing.....	63

Tables

Table 2-1	ADXV-DAS Scalability	19
Table 3-1	NMS LED Specifications	22
Table 3-2	NMS AAI Specifications.....	23
Table 3-3	POI LED Specifications	27
Table 3-4	POI RF port.....	28
Table 3-5	ODU LED Specifications	30
Table 7-1	Account Information for Login	46
Table 7-2	Navigation tree	47
Table 7-3	Power Supply Status	47
Table 7-4	Commissioning ICON	47
Table 7-5	System Summary Description.....	49

Terms and Abbreviations

The following is a list of abbreviations and terms used throughout this document.

Abbreviation/Term	Definition
AGC	Automatic Gain Control
ALC	Automatic Level Control
AROMS	ADRF' Repeater Operation and Management System
BCU	Band Combiner Unit
BTS	Base Transceiver Station
CDMA	Code Division Multiple Access
CHC	Channel combiner
CW	Continuous Wave (un-modulated signal)
DAS	Distributed Antenna System
DL	Downlink
Downlink	The path covered from the Base Transceiver Station (BTS) to the subscribers' service area via the repeater
HE	Head End
HPA	High Power Amplifier
HW	Hardware
IF	Intermediate Frequency
LNA	Low Noise Amplifier
LTE	Long Term Evolution
MS	Mobile Station
NMS	Network Management System
ODU	Optical Donor Unit which is located in ADXV-HE.
OEU	Optic Expansion Unit
PLL	Phased Locked Loop
POI	Point Of Interface
PSU	Power Supply Unit
RF	Radio Frequency
RU	Remote Unit which is composed of master RU and multiple slaves RU
RM	Remote Module
SW	Software

UL

Uplink

Uplink

The path covered from the subscribers' service area to the Base Transceiver Station (BTS) via the repeater

VSWR

Voltage Standing Wave Ratio

1. INTRODUCTION

Currently the ADXV supports 700 MHz (Lower A, Lower B, Lower C, and Upper C), SMR800/Cellular, PCS, AWS, WCS, BRS, PS700, PS800, **900P**, VHF and UHF band.

1.1 Highlights

- Modular Structure (HE)
 - Supports multi bands service in one body
 - Supports up to 12 slot available for POI, ODU, CHC card, etc.
- Supports up to a of maximum of 96 Remote Units(using Optical Expansion Unit)
- **33**/37dBm of downlink composite output power
- Requires only single strand of fiber per remote unit
- Operates with up to 5dBo optical loss
- Supports SNMP v1, v2, v3 (get, set & traps)
- Web-based GUI Interface; No 3rd party GUI software required
- Web-GUI connectivity via DHCP in host mode
- Versatility and Usability: ADXV gives total control to the user. Control parameters such as gain, output power, and alarm threshold can be changed using Web-GUI interface allowing the user to fine tune the system to the given RF environment.

1.2 ADXV DAS Quick View

1.2.1 HE Quick View

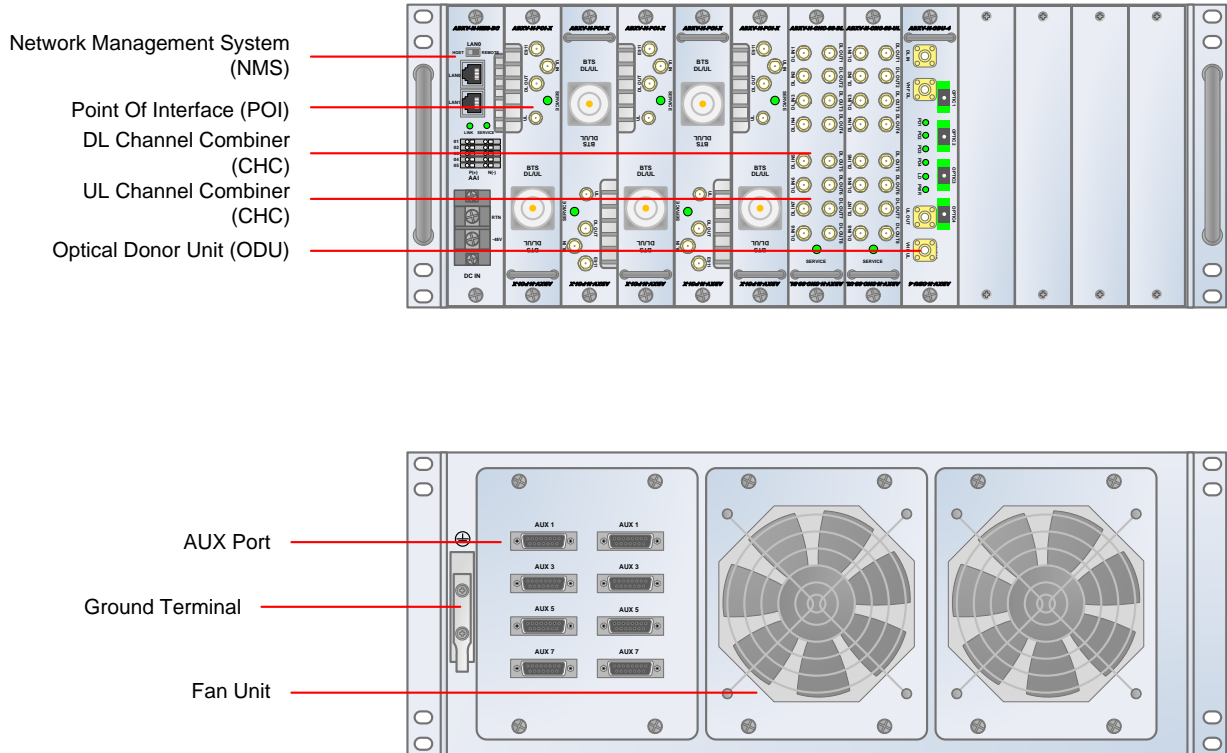

Figure 2-1 ADXV DAS HE Quick View (Front and Rear)

1.2.2 RU Quick View

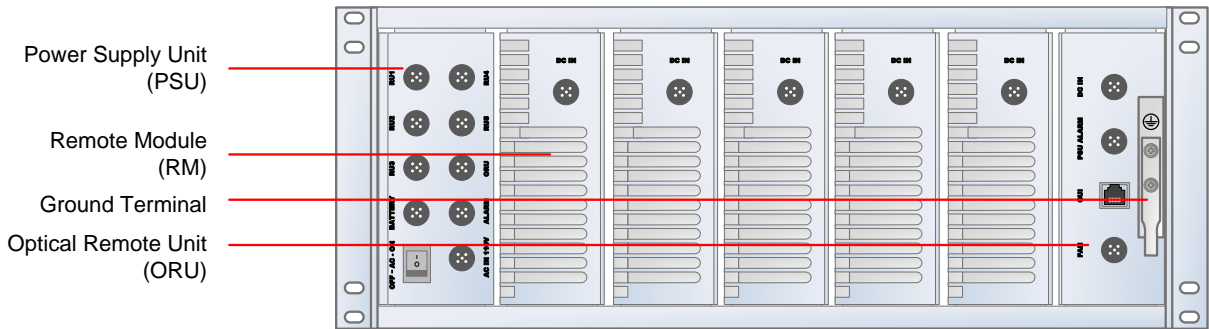
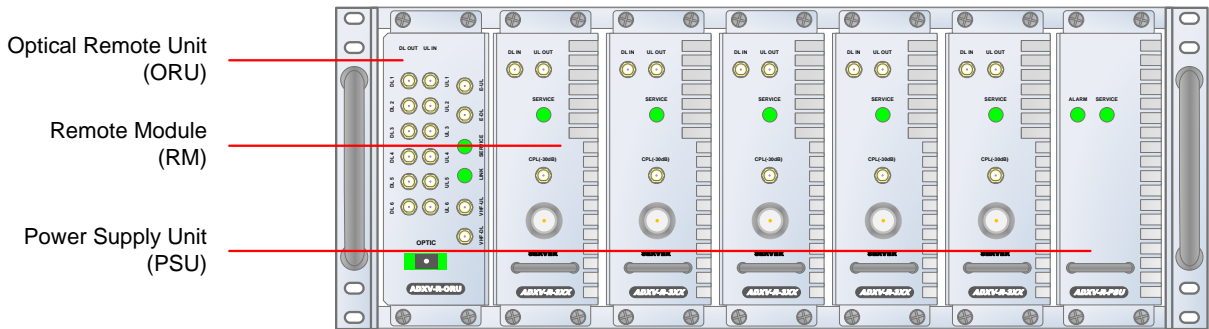

Figure 2-2 ADXV DAS RU Quick View (Front and Rear)

1.3 Warnings and Hazards



WARNING! ELECTRIC SHOCK

Opening the ADXV DAS could result in electric shock and may cause severe injury.



WARNING! EXPOSURE TO RF

Working with the ADXV DAS while in operation, may expose the technician to RF electromagnetic fields that exceed FCC rules for human exposure. Visit the FCC website at www.fcc.gov/oet/rfsafety to learn more about the effects of exposure to RF electromagnetic fields.

RF EXPOSURE & ANTENNA PLACEMENT Guidelines

Actual separation distance is determined upon gain of antenna used.

Please maintain a minimum safe distance of at least **30 cm** while operating near the donor and the server antennas.

WARRANTY

Opening or tampering the ADXV DAS will void all warranties.

Lithium Battery: CAUTION. RISK OF EXPLOSION IF BATTERY IS REPLACED BY INCORRECT TYPE. DISPOSE OF USED BATTERIES ACCORDING TO INSTRUCTIONS.

Ethernet Instructions: This equipment is for indoor use only. All cabling should be limited to inside the building.

FCC Part 15 Class A

NOTE: This equipment has been tested and found to comply with the limits for a Class A digital device, pursuant to part 15 of the FCC Rules. These limits are designed to provide reasonable protection against harmful interference when the equipment is operated in a commercial environment. This equipment generates, uses, and can radiate radio frequency energy and, if not installed and used in accordance with the instruction manual, may cause harmful interference to radio communications. Operation of this equipment in a residential area is likely to cause harmful interference in which case the user will be required to correct the interference at their own expense.

FCC Part 20

WARNING. THIS is NOT a CONSUMER device. It is designed for installation by FCC LICENSEES and QUALIFIED INSTALLERS. You MUST have an FCC LICENSE or express consent of an FCC Licensee to operate this device. Unauthorized use may result in significant forfeiture penalties, including penalties in excess of \$100,000 for each continuing violation.

Laser Safety

Fiber optic ports of the ADXV DAS emit invisible laser radiation at the 1310, 1550nm wavelength window.

To avoid eye injury never look directly into the optical ports, patch cords or optical cables. Do not stare into beam or view directly with optical instruments. Always assume optical output is on.

Only technicians familiar with fiber optic safety practices and procedures should perform optical fiber connections and disconnections of the ADXV DAS and the associated cables.

The ADXV DAS complies with 21 CFR 1040.10 and 1040.11 except for deviations pursuant to laser notice No.50 (July26. 2001)@IEC 60825-1, Amendment2 (Jan. 2001).

Care of Fiber Optic Connectors

Do not remove the protective covers on the fiber optic connectors until a connection is ready to be made. Do not leave connectors uncovered when not connected.

The tip of the fiber optic connectors should not come into contact with any object or dust.

Refer to the cleaning procedure for information on the cleaning of the fiber tip.

Use of unauthorized antennas, cables, and/or coupling devices not conforming with ERP/EIRP and/or indoor-only restrictions is prohibited.

Any changes or modifications not expressly approved by the party responsible for compliance could avoid the user's authority to operate this equipment.

Home/ personal use are prohibited

Only 50 ohm rated antennas, cables and passive equipment shall be used with this remote. Any equipment attached to this device not meeting this standard may cause degradation and unwanted signals in the bi-directional system. All components connected to this device must operate in the frequency range of this device.

RSS-GEN, Sec. 7.1.2 – (transmitters)

Under Industry Canada regulations, this radio transmitter may only operate using an antenna of a type and maximum (or lesser) gain approved for the transmitter by Industry Canada. To reduce potential radio interference to other users, the antenna type and its gain should be so chosen that the equivalent isotropically radiated power (e.i.r.p.) is not more than that necessary for successful communication.

Conformément à la réglementation d'Industrie Canada, le présent émetteur radio peut fonctionner avec une antenne d'un type et d'un gain maximal (ou inférieur) approuvé pour l'émetteur par Industrie Canada. Dans le but de réduire les risques de brouillage radioélectrique à l'intention des autres utilisateurs, il faut choisir le type d'antenne et son gain de sorte que la puissance isotrope rayonnée équivalente (p.i.r.e.) ne dépasse pas l'intensité nécessaire à l'établissement d'une communication satisfaisante.

RSS-GEN, Sec. 7.1.2 – (detachable antennas)

This radio transmitter (identify the device by certification number, or model number if Category II) has been approved by Industry Canada to operate with the antenna types listed below with the maximum permissible gain and required antenna impedance for each antenna type indicated. Antenna types not included in this list, having a gain greater than the maximum gain indicated for that type, are strictly prohibited for use with this device. **(Max. antenna gain : 3 dBi, Antenna type : OMNI ANTENNA)**

Le présent émetteur radio (identifier le dispositif par son numéro de certification ou son numéro de modèle s'il fait partie du matériel de catégorie I) a été approuvé par Industrie Canada pour fonctionner avec les types d'antenne énumérés ci-dessous et ayant un gain admissible maximal et l'impédance requise pour chaque type d'antenne. Les types d'antenne non inclus dans cette liste, ou dont le gain est supérieur au gain maximal indiqué, sont strictement interdits pour l'exploitation de l'émetteur.

RF Radiation Exposure

This equipment complies with RF radiation exposure limits set forth for an uncontrolled environment. This equipment should be installed and operated with a minimum distance of **30 cm** between the radiator and your body. This transmitter must not be co-located or operating in conjunction with any other antenna or transmitter. RF exposure will be addressed at time of installation and the use of higher gain antennas require larger separation distances.

RSS-102 RF Exposure

L'antenne (ou les antennes) doit être installée de façon à maintenir à tout instant une distance minimum de au moins **30 cm** entre la source de radiation (l'antenne) et toute personne physique. Cet appareil ne doit pas être installé ou utilisé en conjonction avec une autre antenne ou émetteur.

2. BLOCK DIAGRAM

2.1 ADV DAS Block Diagram

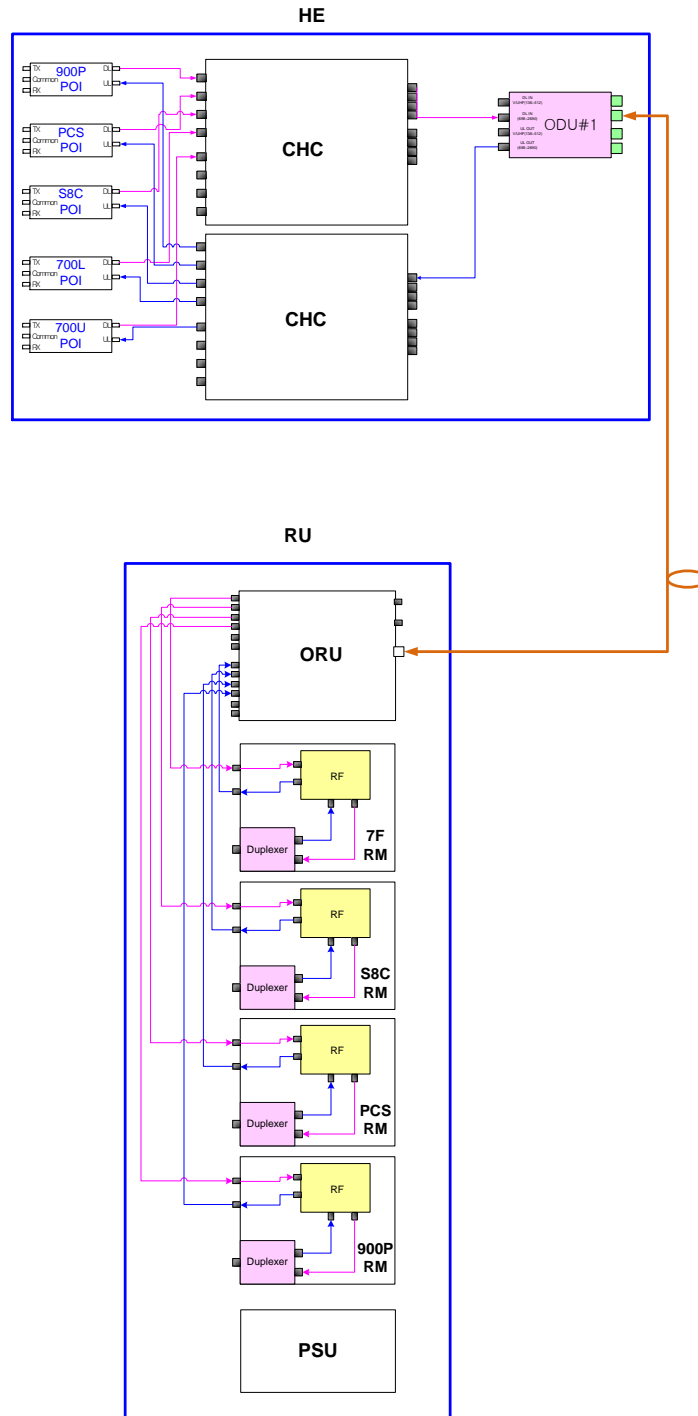

Figure 2-1 ADV DAS Block Diagram

2.2 ADXV-DAS Scalability

Table 2-1 ADXV-DAS Scalability

Unit		Scalability	Remarks
Supported band		700F, Cellular, AWS, PCS, SMR800, PS78, VU(VHF, UHF), BRS FDD, BRS TDD, WCS, 900P	
HE	POI	No limitation in 12 slots except NMS	
	NMS	1	
	CHC	No limitation in 12 slots except NMS	
	Optic Unit	No limitation in 12 slots except NMS In case of Aux, No limit in 8 Aux ports	
RU	RU	64	
	PSU (RU)	Adaptor type	1 per Remote Module(RM)
		19" rack mount (AC or DC)	1

3. ADXV OVERVIEW

3.1 Head End

The head end unit always has to be connected to the Base Station using a direct cabled connection. This system has not been approved for use with a wireless connection via server antenna to the base station.

- Specifications
 - Size: 19.0 x 19.7 x 7inches (482 x 500 x 178 mm)
 - Weight: 64.8lbs @5 POI, 2 CHC, ODU and NMS
 - Power Input: 110VAC(optional) or -48VDC

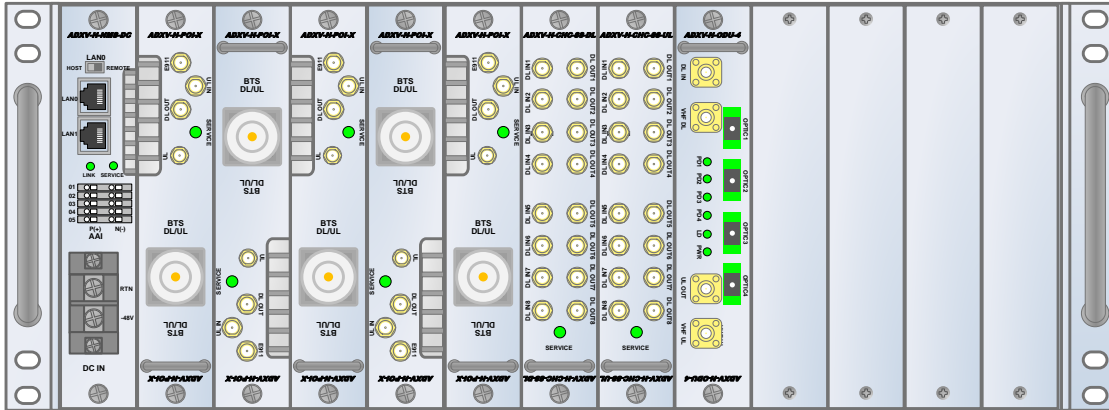

Figure 3-1 Head End Front View

3.1.1 NMS (Network Management System)

- Functions and features
 - Supports SNMP v1, v2, and v3 (get, set & trap) and web-based GUI Interface.
 - Monitors alarms and status
 - Provides control interfaces with all subordinate modules
 - Provides overall DAS structure via the auto tree update function
 - ADXV-H-NMS-DC is for DC type
 - ADXV-H-NMS-AC is for AC type
 - HE's battery backup option is available only in ADXV-H-NMS-AC
- Spec
 - Size: 19.0 x 12.1 x 1.7inches
 - Weight: 3.5lbs

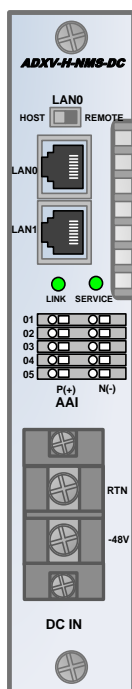

Figure 3-2 ADXV-H-NMS-DC Front View

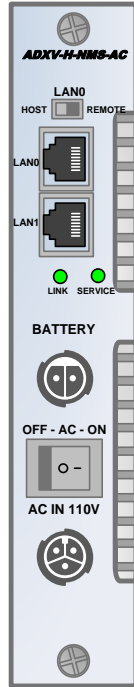

Figure 3-3 ADXV-H-NMS-AC Front View

3.1.1.1 LEDs

NMS has LEDs on the front panel as shown in Figure 3-4.

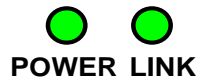

Figure 3-4 NMS LED

Table 3-1 NMS LED Specifications

ADXV DAS-NMS		Specifications
POWER	Solid Green	NMS power is ON
	OFF	NMS power is OFF
LINK	Solid Red	HE Link Fail alarm exists in the system
	Solid Green	No HE Link Fail alarms are present in the system

3.1.1.2 AAI (only for DC type)

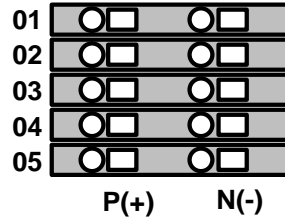

Figure 3-5 NMS AAI

NMS has 5 external alarms out interface pins on the front panel.

Table 3-2 NMS AAI Specifications

AAI Alarm Status	Output
Normal	High Impedance (Open)
Alarm	Low Impedance (Short)

3.1.1.3 Ethernet Port

The Ethernet port can be used to communicate directly with the ADXV DAS using a RJ-45 crossover cable or can also be used to connect the ADXV DAS to an external modem box.

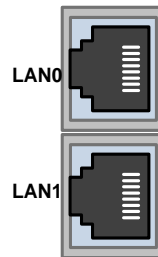

Figure 3-6 Ethernet Port

3.1.1.4 Host/Remote Switch

The Host/Remote Switch allows the user to switch the default Repeater IP, Subnet Mask, and Gateway of the repeater to an alternate setup. These settings can be adjusted by logging into the ADXV DAS in HOST mode and configuring the settings under the Modem Box Setting section under the Install Page of NMS.

Once the settings are set, flipping the switch to the REMOTE position will reboot NMS module with the new alternate settings. *Please note that when the NMS is set to the REMOTE position, DHCP is disabled and the NMS will not automatically assign an IP address to any device that connects directly to the NMS.*

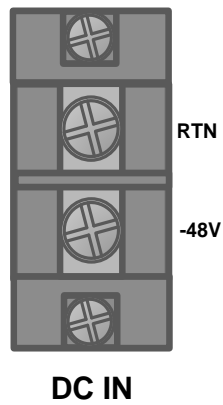

Figure 3-7 Host/Remote Switch

- Host IP: 192.168.63.1 (Fixed IP, unable to modify this IP address)
- Remote IP: 192.168.63.5 (Default IP, but can be modified in Host mode)

3.1.1.5 Power Connection

- For DC type(-48VDC)
ADXV-H-NMS-DC has terminal block for DC power connection on the front panel.
You should verify voltage and power polarity of each power line and should turn on the power after power connection necessarily.



- For AC type(AC 110V)
 ADV-H-NMS-AC has two push-lock connectors for battery backup and AC power connection on the front panel.
 You should verify voltage and should turn on the power after power connection necessarily

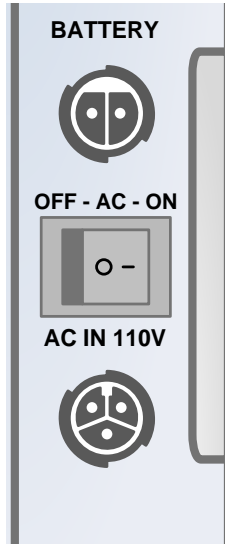

3.1.1.6 POI (ADV-H-POI-x)



Figure 3-8 POI front View

- Functions and features
 - Provide RF interface with BTS
 - Each POI has independent gain control and filtering
 - Modular type and hot swappable
 - Supports duplex port and simplex RX port

- Easily support additional frequency bands by adding a POI
- Reduces complexity and overall equipment size
- Specifications
 - Size: 1.3 x 17.0 x 6.85 (in)
 - Weight: 6.17lbs

3.1.2 POIL (ADXV-H-POIL-x)



Figure 3-9 POIL front View

- Functions and features
 - Provide RF interface with BTS
 - Each POIL has independent gain control and filtering
 - Modular type and hot swappable
 - Supports duplex port and simplex RX port
 - Easily support additional frequency bands by adding a POIL
 - Reduces complexity and overall equipment size
- Specifications
 - Size: 1.3 x 17.0 x 6.85 (in)
 - Weight: 5.0 lbs

3.1.3 POIL-VU (ADXV-H-POIL-VU)

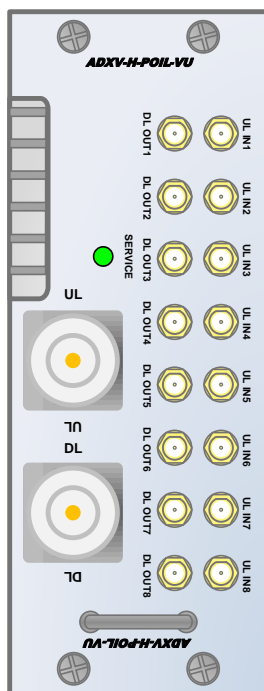

Figure 3-10 POIL-VU front View

- Functions and features
 - Supports VHF/UHF frequency band
 - Provide RF interface with BTS
 - Modular type and hot swappable
 - Supports simplex TX and RX port
- Specifications
 - Size: 2.6 x 17.1 x 6.85 (in)
 - Weight: 8.85 lbs

3.1.3.1 LED

POI has LEDs on the front panel as shown in Figure 3-11.

POWER



Figure 3-11 POI LED

Table 3-3 POI LED Specifications

POI		Specifications
Power	Solid Green	POI power is ON and POI/POIL is normal status
	Solid Red	POI power is ON and POI/POIL is hard fail alarm status
	Solid Yellow	POI power is ON and POI/POIL is soft fail alarm status

3.1.3.2 RF Ports

BTS DL/UL, DL OUT, UL IN, E911 Ports (refer to Figure 3-8) are located at the front of the POI

Table 3-4 POI RF port

RF Port	Function
BTS DL/UL	BTS Interface, DL duplexer Input, UL duplexer output
DL OUT	DL output
UL IN	UL input
UL OUT	UL output not passing through duplexer
E911	E911 RF interface

3.1.4 Channel Combiner (CHC, ADXV-H-CHC)

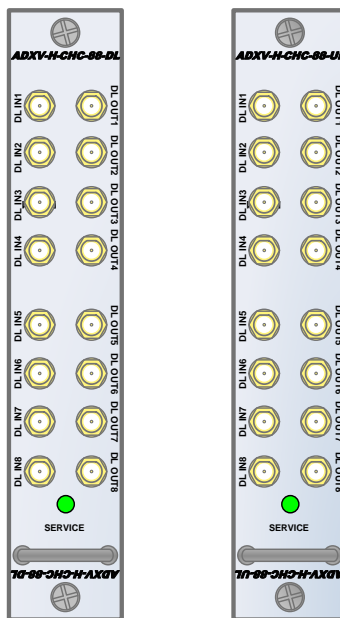

Figure 3-12 ADXV-H-CHC Front View

- Functions & Features
 - Combines DL signals received from each POI and feeds the combined signals to the ADXV-H-ODU
 - Combines UL signals received from each RU and feeds the combined signal to the ADXV-H-POI
 - No limit of installation number and location to install POI/POIL, ODU, CHC card in 12 slots except NMS card
- Specifications

- Size: 1.3 x 17.0 x 6.85 (in)
- Weight: 4.4lbs per CHC

3.1.4.1 RF ports

3.1.4.1.1 RF ports at the front panel (DL 1 to DL 8, UL 1 to UL 8)

DL 1(to DL 8) & UL 1(to UL 8) RF ports are connected to DL OUT/UL IN Ports at the front panel of POI.

- Receive the downlink signal from each POI
- Split the uplink signal received from ODU to each POI

3.1.4.1.2 RF ports at the back panel (DL 1 to DL 8, UL 1 to UL 8)

DL 1(to DL 8) & UL 1(to UL 8) RF ports are connected to DL IN/UL OUT Ports at the back panel of ODU.

- Transfer the combined downlink signals to ODU
- Receive the uplink signal from ODU

3.1.5 Optical Donor Unit (ODU, ADXV-H-ODU-4)

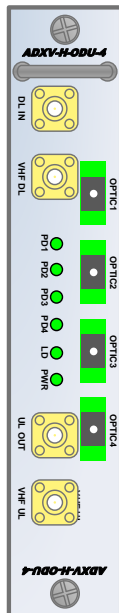

Figure 3-13 ADXV-H-ODU-4 Front view

- Functions & Features
 - Converts signal from RF to optic and transports signals up to a maximum of 10Km (optical 5dB loss including optical connection loss).
 - One ADXV-H-ODU-4 supports up to 4 RUs
 - Minimizes the number of optic fiber cable need by transporting multi band signals over a single strand of fiber using WDM technology.
- Spec
 - Size: 1.3 x 17.0 x 6.85 (in)
 - Weight: 5.3lbs

3.1.5.1 LED

The ADV-H-ODU-4 has the following LEDs on the front panel as shown in Figure 3-14.



Figure 3-14 ADV-H-ODU-4 LED

Table 3-5 ODU LED Specifications

ADV DAS-Module		Specifications
PWR	Solid Green	Module power is ON
	OFF	Module power is OFF
LD	OFF	ODU is not installed
	Solid Yellow	LD Fail alarm exists in the ODU
	Solid Green	No LD Fail alarm is present in the ODU
PD1 to PD4	Solid Yellow	PD Fail alarm exists
	Solid Green	No PD Fail alarm is present

3.1.5.2 RF Ports



Figure 3-15 ODU RF Ports

3.1.5.2.1 DL IN/UL OUT

The combined downlink signal received from ADV-H-CHC is transferred to the DL IN at the back of ODU. The UL OUT port connects any of the ports on back of the ADV-H-CHC labeled UL 1 ~8.

3.1.5.2.2 VHF DL/VHF UL

VHF DL/UHF UL ports are used to support Public Safety in the VHF & UHF frequency bands. VHF/UHF signals for Public Safety bypass the ADV-H-CHC and connect directly to the VHF DL/UHF UL ports of the ADV-H-ODU.

3.1.5.3 Optic Ports

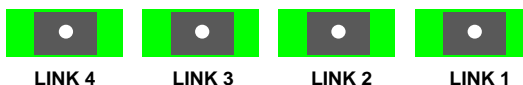

Figure 3-16 ODU Optic Ports

The ADV-H-ODU4 has (4) optic ports and can support up to (4) Main RU's. Likewise, the ADV-H-ODU1 has (1) optic ports and can support up to (1) Main RU.

3.2 Remote Unit (RU)

- A remote unit (single RU chassis base) is composed of an ORU (Optical Remote Unit), a PSU (Power Supply Unit) and plural band's RM (Remote Module).
- Specifications
 - Size: 19.0 x 15.0 x 7 inches (482 x 380 x 178 mm)
 - Weight: 62.17lbs (28.2 Kg)@4 RM(337F/33S8C/37P/37A), ORU and PSU
 - Power Input: 110VAC(optional) or -48VDC

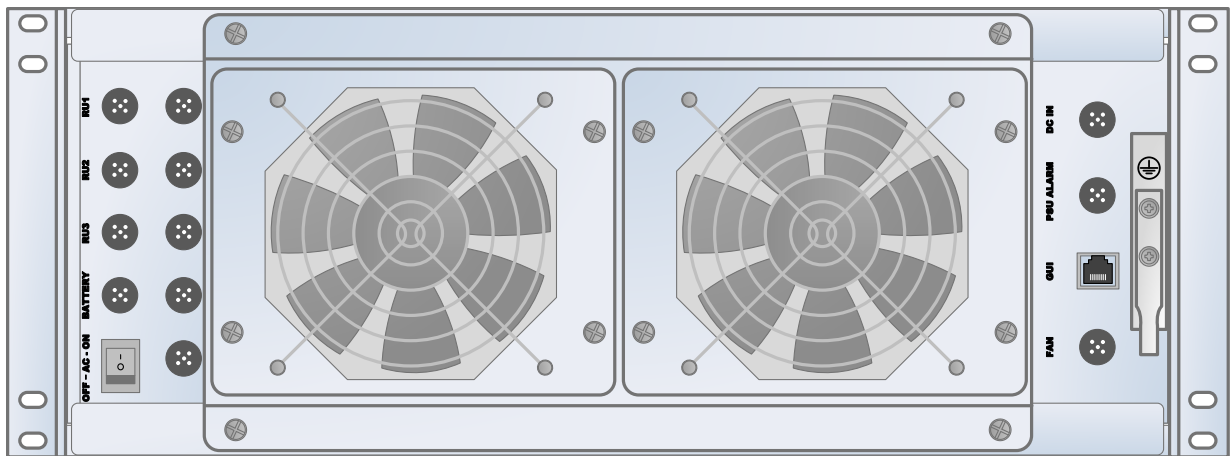
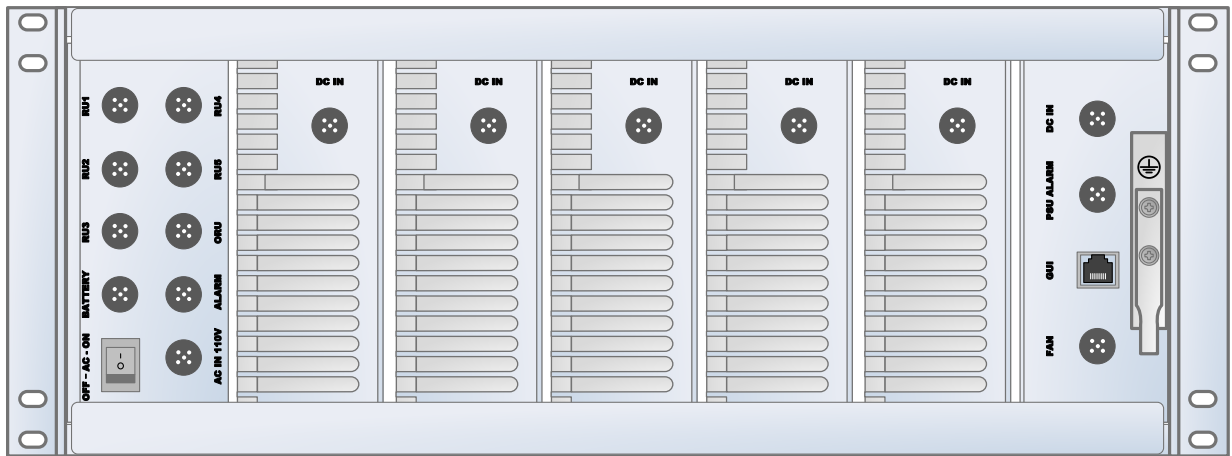
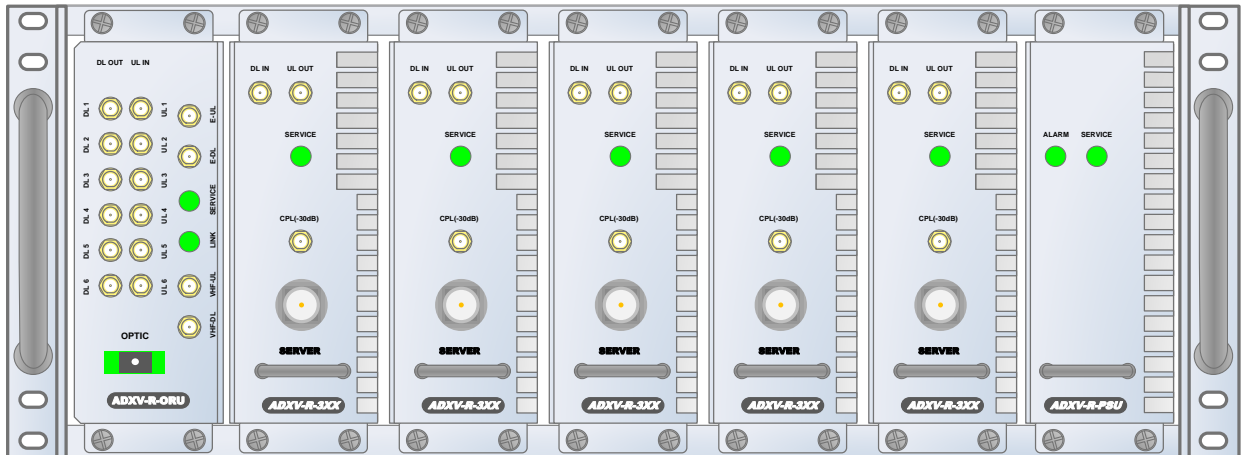

Figure 3-17 ADVX-R Front and Rear (without FAN and with FAN) View

3.2.1 Remote Module (RM, ADXV-R-3xx)

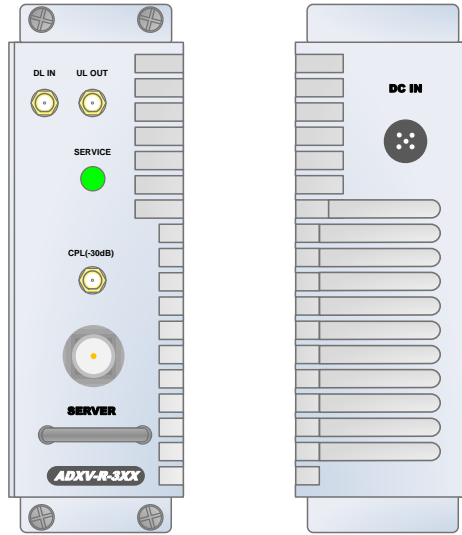

Figure 3-18 ADXV-R-3XX (RM) Front and Rear View

- Spec
 - Size: 2.3 x 13.8 x 6.85 (in)
 - Weight: 9.92 lbs

3.2.1.1 RM ID numbering and RF line connection scheme

RM ID right next to ORU is RM #1, RM 2nd next is RM #2 and the rest of RMs' ID numbering is in the same order.

With RF connection between ORU and RM, it is necessary RM ID number should be equal to DL/UL port number of ORU because of RM ID management and normal serial communication.

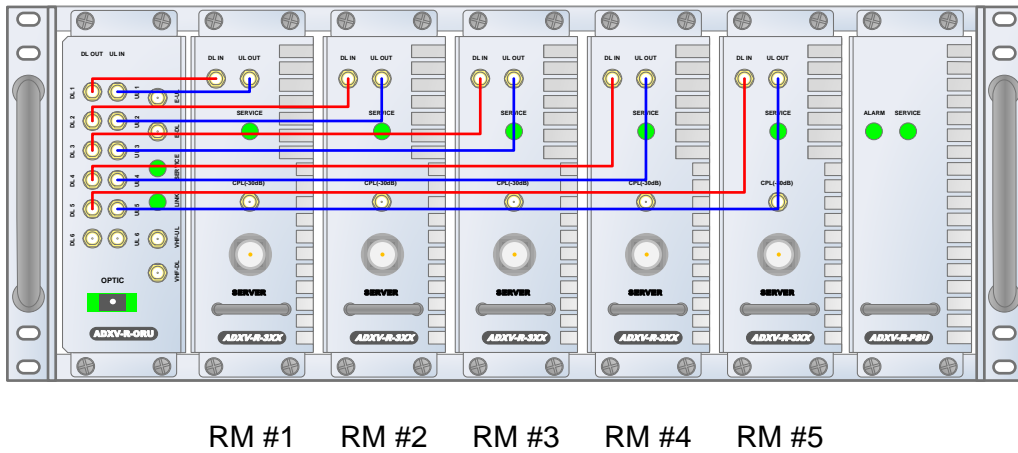

Figure 3-19 RM ID numbering and RF connection between ORU and RM

3.2.1.2 RF port

DL IN/UL OUT connect to ORU's DL port and UL port, it is necessary to connect UL's port number equal to DL's because of serial communication with ORU.

CPL (-30dB): DL output 30dB coupling

SERVER: DL output, UL input, Server Duplexer port

3.2.1.3 Power port

DC IN: Port for power supply (+27VDC) and communication with Controller inside PSU.

3.2.1.4 LED

LED color	Status
Green	Normal
Yellow	Soft fail
Red	Hard fail

3.2.2 Optical Remote Unit (ORU, ADXV-R-ORU)

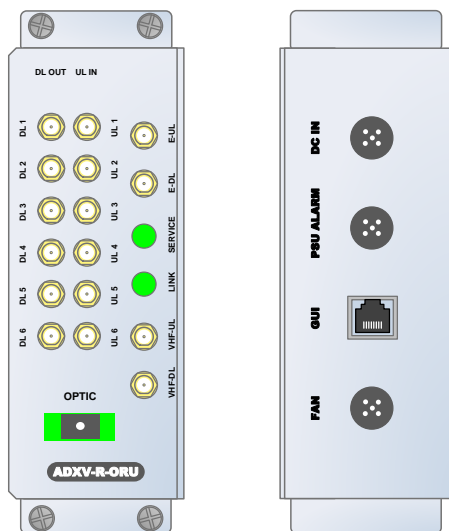

Figure 3-20 ADXV-R-ORU Front and Rear View

- Spec
 - Size: 2.3 x 13.8 x 6.85 (in)
 - Weight: 9.26lbs

3.2.2.1 Front port

- DL1-DL6: DL port connect to 'DL IN' of RM (Remote Module) (see 3.2.1.1)
- UL1-UL6: UL port connect to 'UL OUT' of RM (Remote Module) (see 3.2.1.1)
- E-DL/E-UL ports connect to external splitter for extension of band RM

- VHF-DL/VHF-UL ports connect to the ADXV VHF/UHF RM
- OPTIC port connects with optic line with waterproof optical connector (provided by ADRF)

3.2.2.2 Rear port

- DC IN port connects to PSU's ORU port.
- PSU ALARM port connects to PSU's ALARM port.
- GUI port for connection to Lap- top.
- FAN port for connection to FAN unit.

3.2.2.3 LED

LED	LED color	Status
Link	Green	Link normal
	Yellow	Link fail
Service	Green	Normal
	Yellow	Soft fail
	Red	Hard fail

3.2.3 PSU (ADXV-R-PSU)

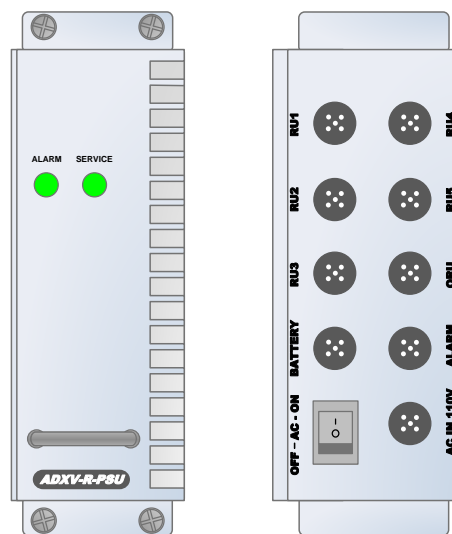

Figure 3-21 ADXV-R-PSU Front and Rear View

- Spec
 - Size: 2.3 x 13.8 x 6.8 (in)
 - Weight: 7.5lbs for DC PSU

3.2.3.1 Port

- RU1-RU5 ports connect respectively to RU's rear port.
- ORU port connects to ORU.
- BATTERY port connects to optional battery box.

- ALARM port connects to 'PSU ALARM' port of ORU
- AC IN 110V port connects to AC 110V

3.2.3.2 LED

LED	LED color	Status
ALARM	Green	Normal
	Yellow	Link fail
SERVICE	Green	Normal
	Yellow	Soft fail
	Red	Hard fail

3.2.3.3 AC Switch

The ADXV-RU is operated at 110 AC.

(WARNING: The AC switch must be set to OFF before cable connection to avoid equipment damage and personal injury.)

(WARNING: To avoid damage, be sure 110V AC for operation of ADXV-RU.)

(CAUTION: DOUBLE POLE/NEUTRAL FUSING.)

The procedure for connecting RU

- AC S/W OFF
- AC cable connection
- Optic connection
- RF cable connection
- AC S/W ON

Figure 3-22 ADXV-R-PSU Front and Rear View

3.2.4 Port

- 78PS: SERVER, OPTIC, GUI, AC IN, BATTERY, EXTERNAL ALARM, EF-UL IN, EF-UL OUT, EF-DL OUT, EF-DL IN
- VU: DL OUT, UL IN, OPTIC, GUI, BATTERY, AC IN, EXTERNAL ALARM

4. CABLE CONNECTION

4.1 Head End Connection Diagrams

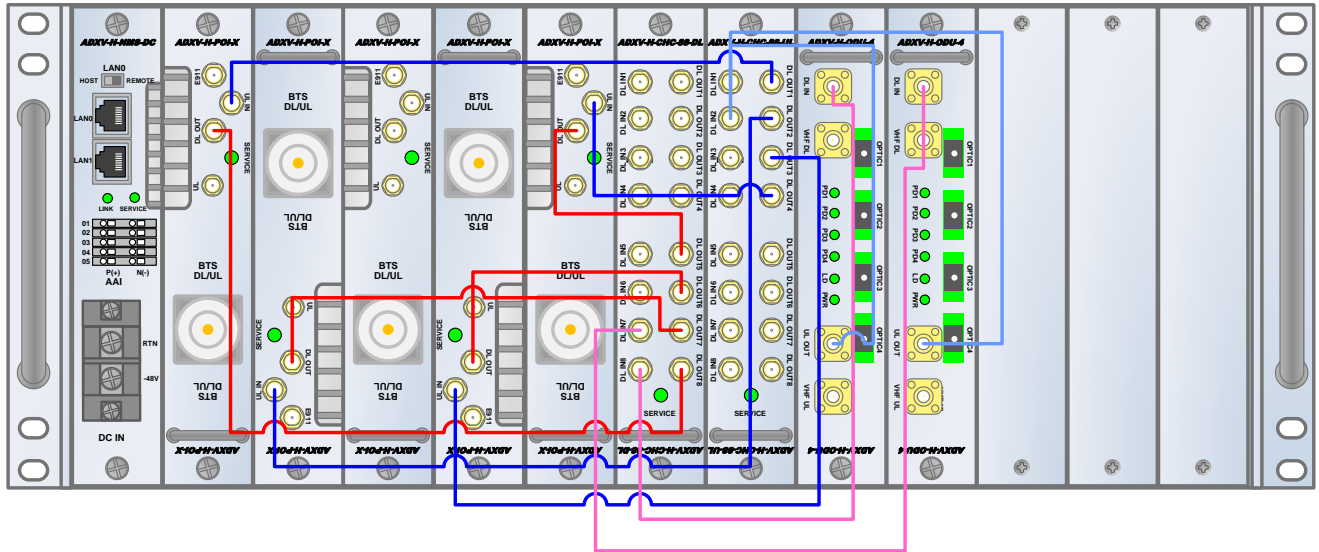

Figure 4-1 HE Cable connection (4 ADXV-H-POIs, 2 ADXV-H-ODUs)

4.2 Remote Unit Connection Diagrams

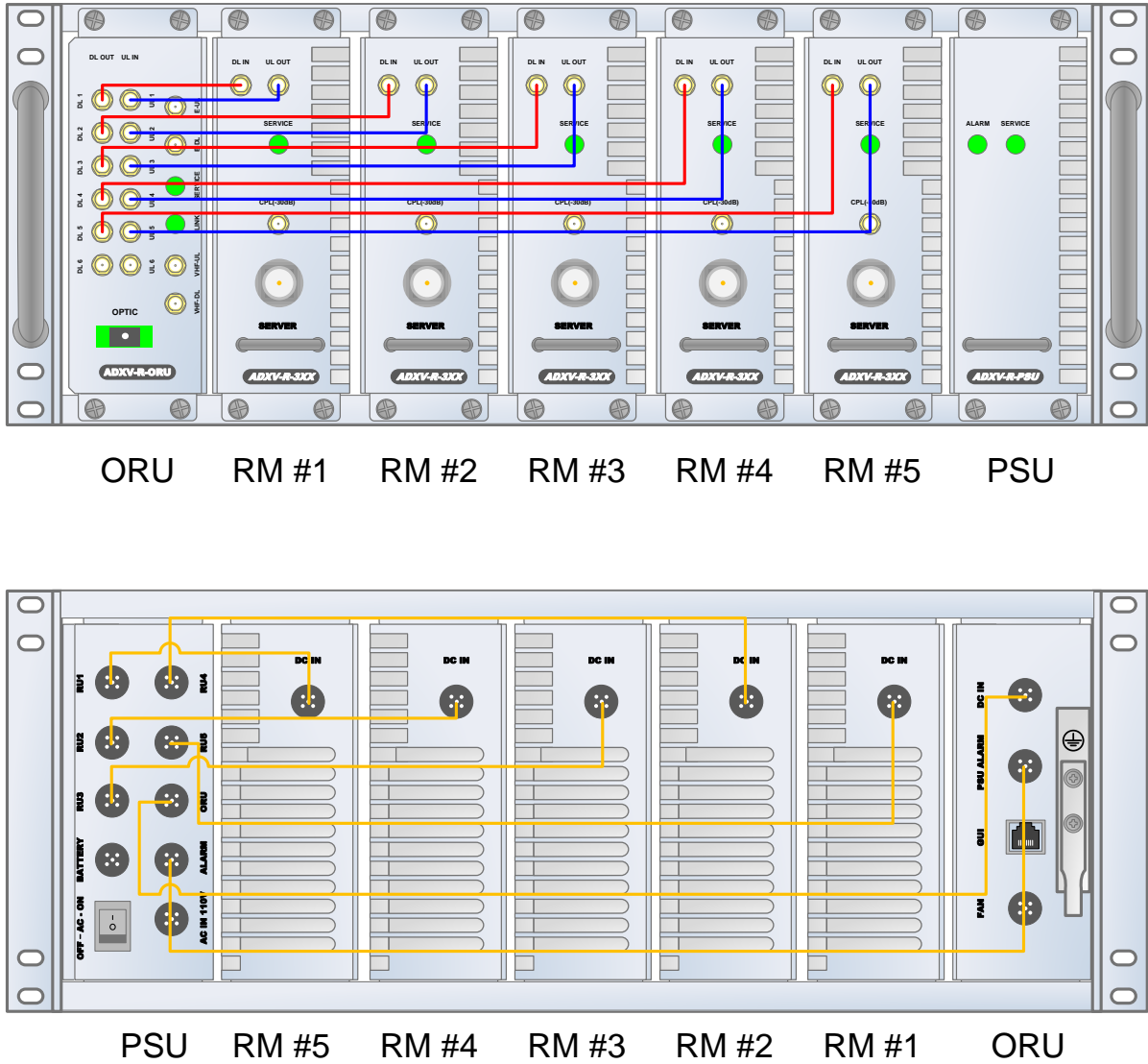

Figure 4-2 ADXV-RU 5 Sands connection

5. MOUNTING METHOD

5.1 Head End

5.1.1 Rack Mount

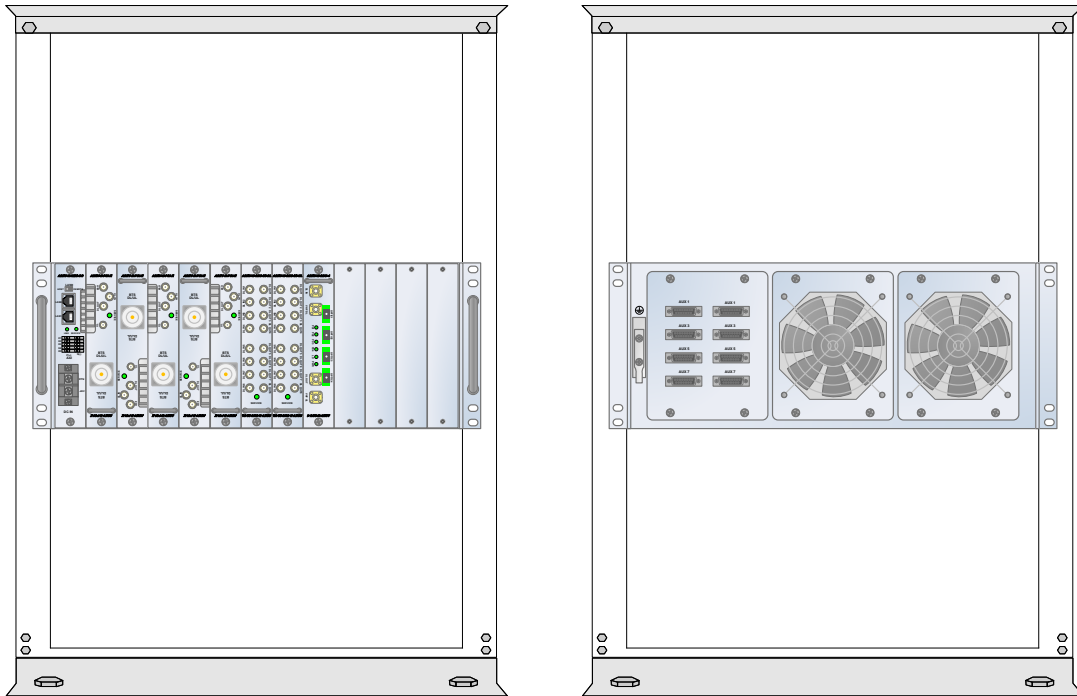

Figure 5-1 HE Rack Mount (Front & Rear view)

5.2 RU

5.2.1 Rack Mount

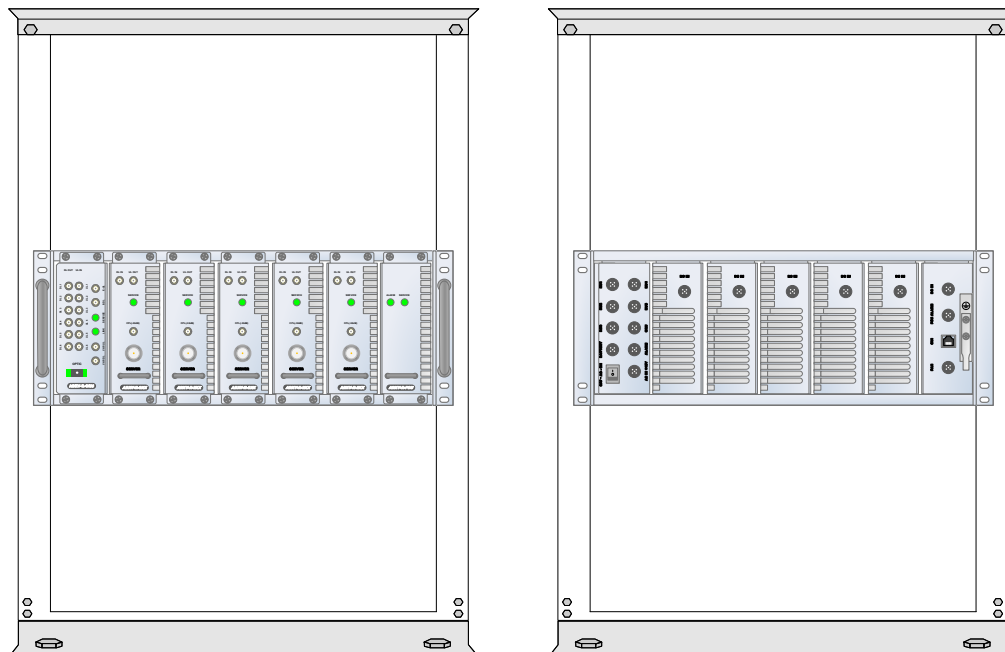

Figure 5-2 RU Rack Mount Front and Rear View

6. INSTALLATION

6.1 Pre-Installation Inspection

Please follow these procedures before installing ADXV RU equipment:

- Verify the number of packages received against the packing list.
- Check all packages for external damage; report any external damage to the shipping carrier. If there is damage, a shipping agent should be present before you unpack and inspect the contents because damage caused during transit is the responsibility of the shipping agent.
- Open and check each package against the packing list. If any items are missing, contact ADRF customer service.
- If damage is discovered at the time of installation, contact the shipping agent.
- Verify the AC voltage with DVM (Volt meter) is 110V AC. Incorrect AC voltage can damage the ADXV equipment.
- This power of this system shall be supplied through wiring installed in a normal building. If powered directly from the mains distribution system, it shall be used additional protection, such as overvoltage protection device.
- Over voltage category(OVC) & Pollution degree(PD)

Over voltage category (OVC)	OVC II
Pollution degree (PD)	PD2

6.2 ADXV DAS Installation Procedure

6.2.1 HE Installation Procedure



CAUTION: ADXV DAS HE should be installed inside building only.

6.2.1.1 Installing a ADXV DAS HE in a rack

The ADXV HE chassis mounts in a standard 19" (483mm) equipment rack. Allow clearance of 3" (76mm) at the front and rear, and 2" (51mm) on both sides for air circulation. No top or bottom clearance is required.

- Consideration:
 - Eight mounting holes are located on 4 corners of ADXV HE to attach it to the 19" rack. The ADXV HE must be securely attached to a rack that can support the weight of the ADX.
- Mount procedure
 - The following steps should be followed while mounting the ADXV HE
 - > Verify that the HE and Mounting holes are in good condition
 - > Set the ADXV DAS HE against the 19" rack and secure the unit with screws
 - > Verify that ADXV HE is securely attached
 - > Connect the GND cable
 - > Connect the RF cable
 - > Connect the Power
 - > Connect the Optic cable

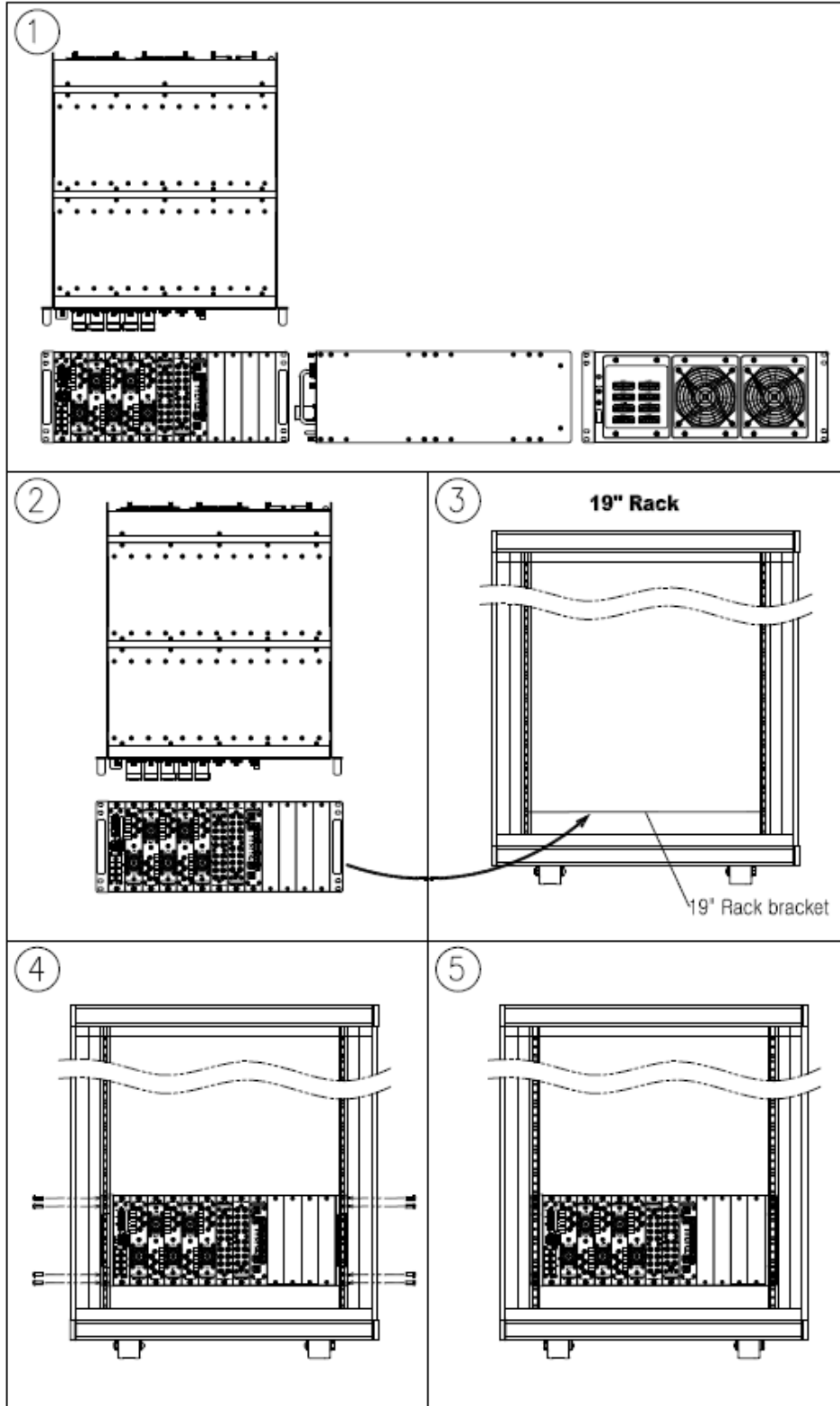

Figure 6-1 HE Installation Procedure

6.2.2 RU Installation Procedure

The ADXV RU chassis mounts in a standard 19" (483mm) equipment rack. Allow clearance of 3" (76mm) at the front and rear, and 2" (51mm) on both sides for air circulation. No top or bottom clearance is required.

- Consideration:
 - Eight mounting holes are located on 4 corners of ADXV RU to attach it to the 19" rack. The ADXV RU must be securely attached to a rack that can support the weight of the ADX.
- Procedure
 - The following steps should be followed while mounting the ADXV RU
 - > Verify that the RU and Mounting holes are in good condition
 - > Set the ADXV DAS RU against the 19" rack and secure the unit with screws
 - > Verify that ADXV RU is securely attached
 - > Connect the GND cable
 - > Connect the RF coaxial cable
 - > Connect the Power
 - > Connect the Optic cable

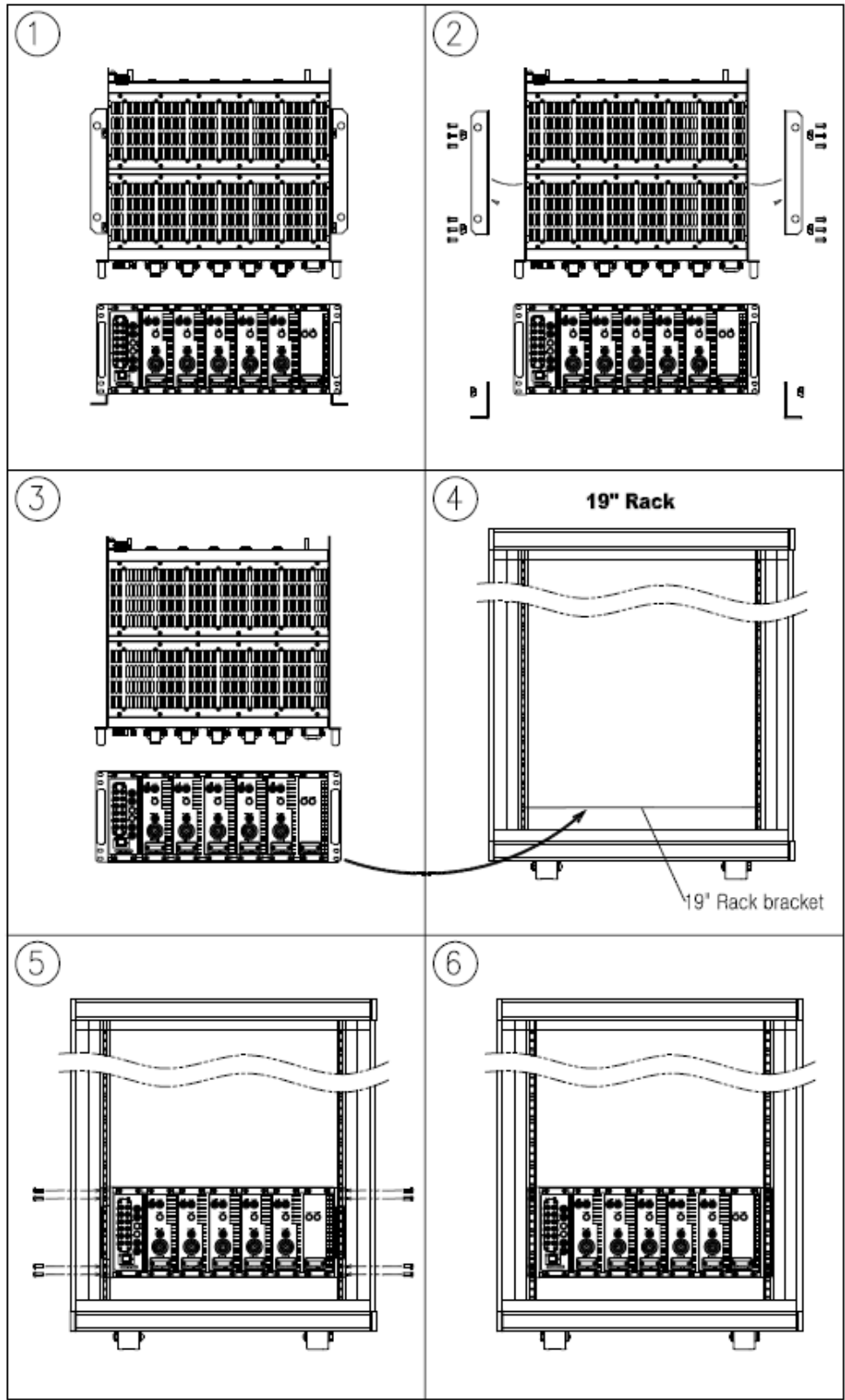

Figure 6-2 RU Installation Procedure

6.2.3 RF coaxial cable and antenna connection

- > The coaxial cables which are connected to antenna port of RU. Before connection, check the VSWR value of coaxial cable whether it is within specification using Sitemaster..
- > At this time, check if the Return loss have above 15dB or VSWR have below 1.5
- > The part of antenna connection fasten to port not to be loosed and not to be injected the dusty and insects
- > The antenna connected to RU is only serviced in in-building

6.3 Grounding

A ground cable is included in the box. The grounding terminals are located at the rear of the ADXV HE and RU. The grounding cable should be properly connected before powering on the equipment.

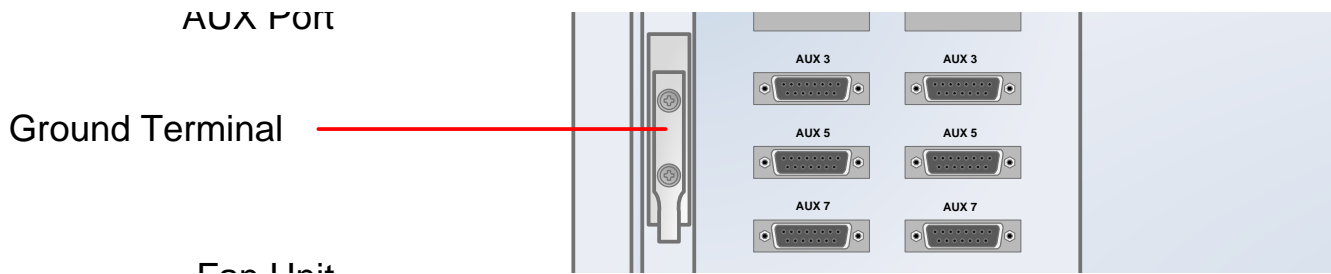

Figure 6-3 HE Ground Cable Connection, Protective Earthing Conductor (HE chassis rear side)

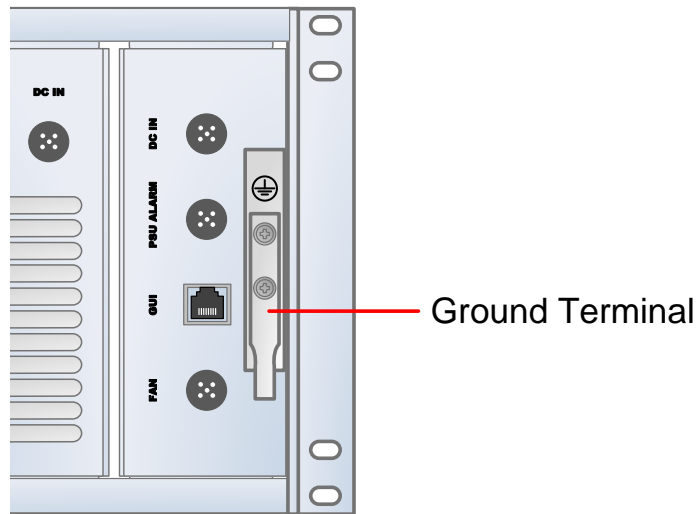

Figure 6-4 RU Ground Cable Connection, Protective Earthing Conductor (RU chassis rear side)

Round terminals located on the side of a 1.25mm²(16AWG) or more wires Using permanently connected to earth(Protective earthing conductor).

6.4 Optic Port Cleaning

- We recommend cleaning optic connector using a dry optical cleaning swab or tissue in a dry environment as needed. We recommend cleaning the optic connectors only if the expected optic loss is higher than the loss reported in the Web-GUI by 1.5dB_o. (Figure 6-5)
- When optic connector are not in use, the port should be covered with a protective dust cap. (Figure 6-6)



Figure 6-5 Optic Connector Cleaning (left) and Optic Port Cleaning (right)

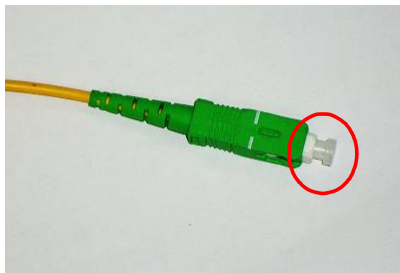

Figure 6-6 SC/APC Optic Connector Dust Cap

7. WEB-GUI

7.1 Web-GUI Setup

The Web-GUI allows the user to communicate with the DAS system either locally or remotely. To connect to the DAS system locally, you will need a laptop with an Ethernet port and a RJ-45 crossover cable. To connect to the DAS system remotely, you will need to have an active internet connection and the ADXV system must have an external modem box connected to the ADX.

7.1.1 DAS system/PC Connection Using Web-GUI

- Verify that your Local Area Connection is set to Obtain an IP address automatically under the Internet Protocol (TCP/IP) properties
 - If you are connecting to the unit remotely (use of a modem), then skip this and next step.
- Connect the RJ-45 crossover cable between the laptop's Ethernet port and the repeater's Ethernet port
- Launch an Internet Browser
- Type the following IP address into the address bar of Microsoft Internet Explorer: <http://192.168.63.1>
 - If you are connecting to the unit remotely, then type the IP address of the modem to connect to the unit
- The following login screen will appear:

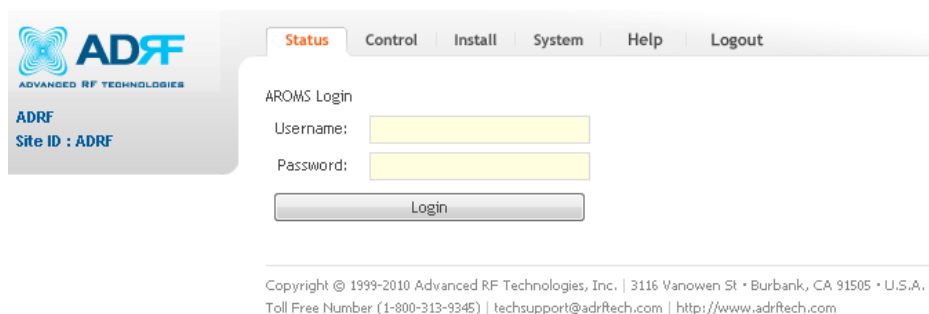

Figure 7-1 Login screen

If you are not the Administrator, please type in your assigned username & password which you should have received from the Administrator.

Table 7-1 Account Information for Login

Account type	Show items	Control Items	Default ID	Default Password
Administrator	all Items	all items	admin	admin
User	restricted items	restricted items	adrftch	adrftch
Guest	restricted items	read-only	guest	guest







7.2 Administrator/User Mode

7.2.1 Common

7.2.1.1 Navigation Tree

The navigation tree located on the left hand side of the Web-GUI allows the user to switch between the various modules that are connected to the system.

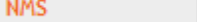

Table 7-2 Navigation tree

Parameters	Description
	Expands the entire navigation tree
	Collapses the entire navigation tree
	The module has the expandable subordinate modules
	The branch is currently expanded
	The module has soft fail alarm
	The module has hard fail alarm
	The module has no alarms (normal)
	The selected module will have orange colored text

7.2.1.2 Power Status

Display the power source that is currently being used.



Table 7-3 Power Supply Status

Input Power Status	Display Image
AC	
Battery	

7.2.1.3 Commissioning Status

Display whether or not the module has successfully been commissioned.

Table 7-4 Commissioning ICON

Status	Display Image
Commissioned	
Not-Commissioned	

7.2.1.4 Information

ADRF Remote Operation & Management System

Information

Serial Number	SN_NMS
Latitude	N777.777777
Longitude	E777.777777
Firmware	13000F01002X
Web GUI	X0.0.35

Location

ADRF
3116 Vanowen St.
burbank CA 91505

Description

nms_desc.

Technical Support

Phone: 1-800-313-9345
E-mail: techsupport@adrftech.com

Installer Contact Info

Company: ADRF
Installer: Installer
Phone: 800-313-9345
E-mail: techsupport@adrftech.com

Figure 7-2 ADXV DAS General Information

- Information: Displays the serial number, latitude/longitude, firmware version of selected module, and Web GUI version of the NMS.
- Location: Displays the address where the ADXV DAS is installed.
- Description: Displays the description of selected module. The description of each module can be edited from the Install tab. It is recommended to use the location of the module as the description. This description information can be seen when hovering over the device tree in order to easily identify each component.
- Technical Support: Displays ADRF’s Technical Support contact information.
- Installer Contact Info: Displays the contact information of the installer.

7.2.2 Status Tab

7.2.2.1 Status – NMS

The NMS Status page provides an overall view of how the system is performing. From the NMS Status page, the user can see what modules are connected to ADXV DAS. In addition, the user can see if any alarms are present in the system and also the commissioning status of each module.

7.2.2.1.1 System Summary

The Summary section provides the user with the number of components physically connected, the number of soft/hard/link fails present in the system, and also the number of commissioned and non-commissioned components.

Table 7-5 System Summary Description

Parameters	Description
Connected	Display the number of modules physically connected to ADXV DAS
Soft Fail	Display the number of soft fail present on each module
Hard Fail	Display the number of hard fail present on each module
Link Fail	Display the number of link fail present on each module
Not Commissioned	Display the number of non-commissioned or commission failed module
Commissioned	Display the number of successfully commissioned module

7.2.2.1.2 HE Alarm Status

Display the alarm status of each HE component.

7.2.2.1.3 HE Commissioning Status

Display commissioning status of each HE component.

7.2.2.1.4 Alarm

Displays alarm status of the NMS. If an alarm is present in the system, the color of the system alarm tab will change according to the type of failure.

7.2.2.1.5 SNMP



The image shows a configuration window titled "SNMP". It contains two input fields: "Site ID" with the value "adrf" and "Manager IP" with the value "0.0.0.0". Below these fields is a "Set" button.

Figure 7-3 SNMP (Install – NMS)

The SNMP section allows you to specify the Site ID and Manager IP. The Site-ID is the code that is used to identify a particular module. The Manager IP field is where the user inputs the IP address of the NOC system that is being used to monitor the SNMP traps.

7.2.2.1.6 Location

This section allows the user to input the latitude and the longitude of the repeater.

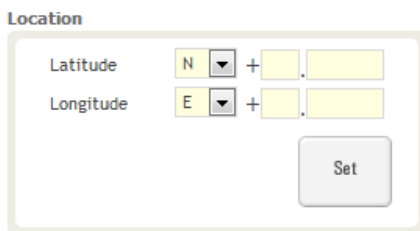

Figure 7-4 Location Setting (Install – NMS)

- Select N or S from the dropdown menu for Latitude
- Select E or W from the dropdown menu for Longitude
- Input the first 3 numbers of the latitude/longitude in the text area after the “+” and before the “.”
- Input the last 6 numbers of the latitude/longitude in the text area after the “.”

7.2.2.1.7 External Modem Box Settings

This section allows the user to specify an alternative IP, Subnet Mask, and Gateway settings. These settings are enabled when the Host/Remote switch is set to the Remote position.

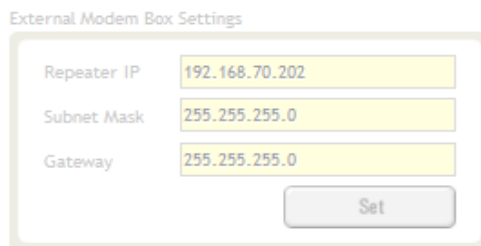

Figure 7-5 External Modem Box Setting (Install – NMS)

7.2.2.1.8 Description

This section allows the user to save the description of NMS.

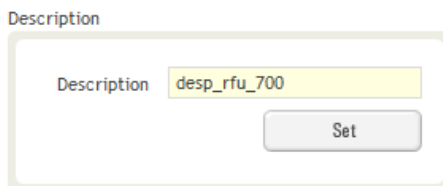

Figure 7-6 Description (Install – NMS)

7.2.2.1.9 SNMP Agent False Alarm Test

This section allows the user to generate both soft and hard fail alarms. After alarms are generated, the NOC can poll the ADXV to see if alarms are present. All alarms generated during this test are false alarms.

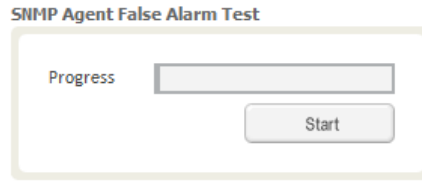

Figure 7-7 SNMP Agent False Alarm Test (Install – NMS)

7.2.2.1.10 Location Info / Installer Info

This section allows the user to specify the address of the repeater and also the information of the installer.

ADRF Remote Operation & Management System

Location Info

Company

Address1

Address2

City

State

ZIP Code

Installer Info

Company

Name

Phone

E-mail

Figure 7-8 Location Info / Installer Info (Install – NMS)

7.2.2.1.11 Date & Time

This section allows the user to specify the current date and time.

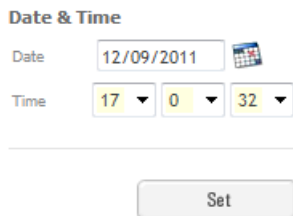

The interface shows a 'Date & Time' section with a 'Date' field containing '12/09/2011' and a calendar icon. Below it, the 'Time' is set to '17:03' using three dropdown menus. A 'Set' button is located at the bottom.

Figure 7-9 Date & Time Setting (Install – NMS)

7.2.2.1.12 Description

This section allows the user to save the description of remote module.

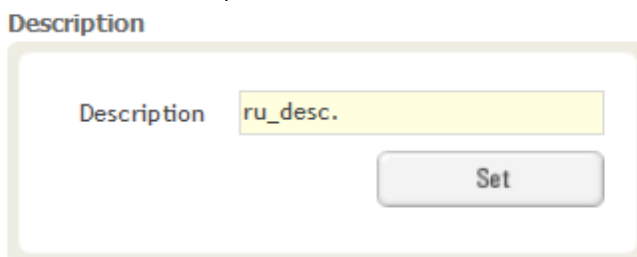

The interface shows a 'Description' section with a text input field containing 'ru_desc.' and a 'Set' button.

Figure 7-10 Description (Install-Remote Module)

7.2.3 System

The System tab allows the user to perform firmware updates, upload closeout packages, view any changes to the system, backup existing configuration, and add/remove user accounts, and change the login credentials of the Administrator.

7.2.3.1 System: Account

7.2.3.1.1 System: Account - Account Management (Admin Only)

The Account Management section allows the Administrator to delete any user/guest account. Please note that the Account Management section is only available if you are logged into the system as the Administrator. To delete a user/guest account click on the Account Management link and under the Delete column, click on the delete button.

Account Management / New account / Change Password

No	Login Name	Password	Status	Last Login	Edit
1	admin	admin	administrator	2012-02-28 18:37:53	-
2	adrf	adrf	user	2012-02-28 00:47:55	delete
3	guest	guest	guest	1970-01-01 00:00:00	delete

Figure 7-11 Account Management

7.2.3.1.2 System: Account - New Account (Admin Only)

The New account section allows the Administrator to create a new user/guest account. Please note that the new account section is only available if you are logged into the system as the Administrator. To create a new user/guest account click on the new account link and fill in the fields highlighted in yellow as shown below.

Account | Logs | Update | System Information | Backup/Restore | SNMP | Closeout Package

Account Management / New account / Change Password

Account Name

Account Group user ▼

Password

Confirm password

Figure 7-12 New Account

7.2.3.1.3 System: Account - Change Password

The Change Password section allows the current user who is logged into the system to change their login credentials.

Account Management / New account / Change Password

User Name admin

Password

Confirm password

Please enter new password.

Figure 7-13 Change Password

7.2.3.2 System: Logs

7.2.3.2.1 System: Logs - Event Log

This section displays system events that have taken place. The Event Log displays who has made the changes, the time and date of when the event took place, and what changes were made to the system. The System Log tracks the following events:

- System Initiation
- Alarm Set
- Alarm Clear

7.2.3.2.2 System: Logs - User Log

This section tracks user activity within the system. The User Log displays who has made the changes, the time and date of when the event took place, and what changes were made to the system. The User Log tracks the following items:

- Log in / Log out activity
- Changes to gain/attenuation/output values
- System event generated by user(firmware update, backup/restore, create/delete account)
- DAS Navigation Tree Lock/Unlock
- Description change
- Repeater/installer information change
- Setting date/time

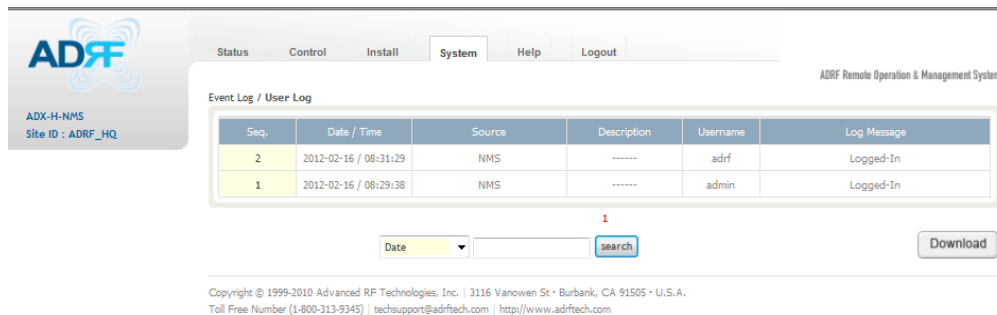

Figure 7-14 User Log

7.2.3.3 System: Update

- To perform a firmware update, click on the System:Update tab and the following screen will show up.

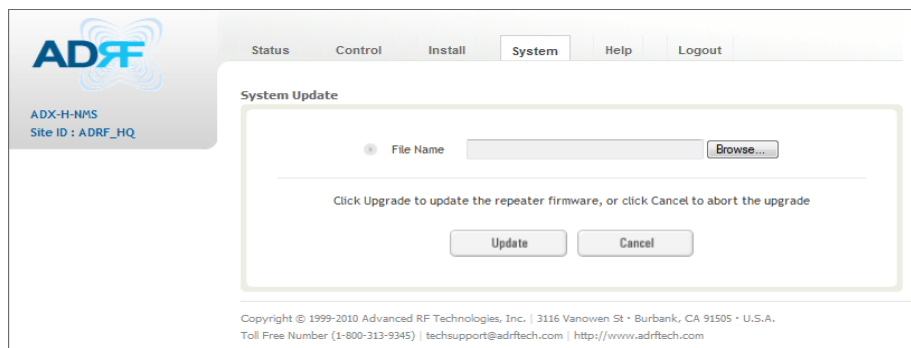

Figure 7-15 System update

- Click on the 'Browse' button and locate the firmware file.
- Click on the Update button to perform the firmware update.
- Once the firmware update is complete, the following message will appear.

```

File Size = 1149078///1149095
File upload OK.
Now copying files and reboot. Do not close this page.
Updated... Web
Updated... Universal Extra files

Updated ...

Rebooting now ...

Turn off this terminal.
And connect GUI after 30 seconds ...

*****
***** End Download *****
*****

```

Figure 7-16 Message after System update is complete

7.2.4 Help

If an internet connection is available, clicking on the Help Tab will redirect the user to our Technical Support page.

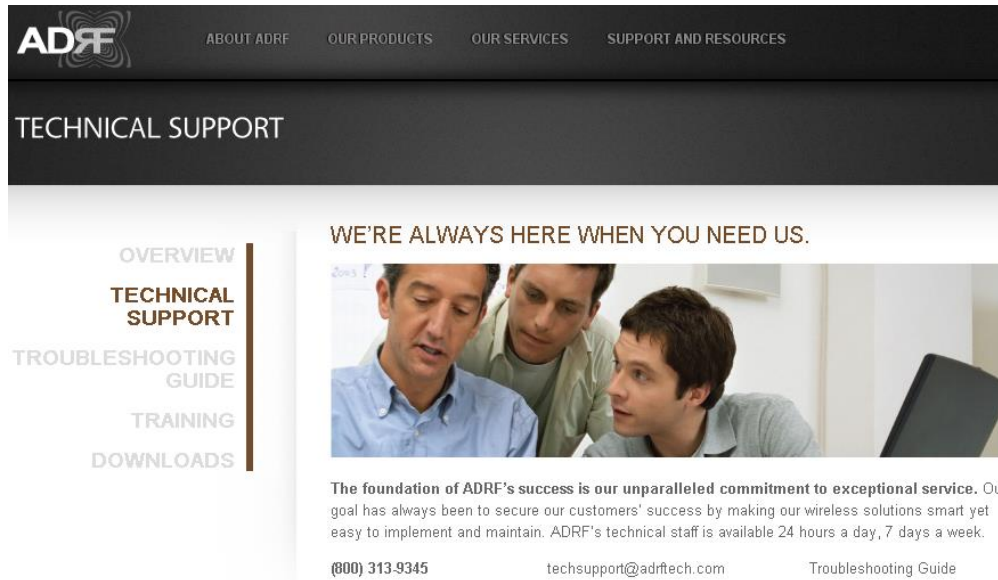

Figure 7-17 Help

7.2.5 Logout

Clicking the Logout button will log the current user off the system.

7.3 Guest Mode

When logging into the system as a guest, the guest will only have read-only privileges and will not be able to make any changes to the system.

8. SYSTEM-WIDE SPECIFICATION

1.1 700MHz/S8C/Ps78/PCS/.AWS/BRS/VU Specifications.

Parameters		700MHz		S8C (CELLUAR & SMR800)	PS78 (PS700 & PS800)	PCS	AWS	WCS	BRS (TDD/FDD)	VU (VHF & UHF)
Frequency (Bandwidth)	Downlink (MHz)	Lower A	728-734	862-894 (32MHz)	PS700(FirstNet + PS 700): 758-768, 769~775 PS800: 851-861	1930-1995 (65MHz)	2110-2180 (70MHz)	2350-2360 (10MHz)	TDD: 2496-2690 (194MHz) FDD: 2620-2690 (70MHz)	VHF: 138-174 (36MHz) UHF: 380-512 (132MHz)
		Lower B	734-740							
		Lower C	740-746							
		Upper C	746-757							
	Uplink (MHz)	Lower A	698-704	817-849 (32MHz)	PS700(FirstNet + PS 700): 788-798, 799~805 PS800: 806-816	1850-1915 (65MHz)	1710-1780 (70MHz)	2305-2315 (10MHz)	TDD: 2496-2690 (194MHz) FDD: 2500-2570 (70MHz)	VHF: 138-174 (36MHz) UHF: 380-512 (132MHz)
		Lower B	704-710							
		Lower C	710-716							
		Upper C	776-787							
Input Power Range (dBm)	POI	+48~0								-
	POIL	+25~-15							-	+25~-15
System Gain/ Nominal pass band gain	Downlink (dB)	POI to RM: -15~33/33(2W), POIL to RM: 8~48(2W)				POI to RM: -11~37/33(5W), POIL to RM: 12~52(5W)				POIL to RM: 0~40(0.25W)
	Uplink (dB)	0~30								
Rated mean output power (DL)	33dBm(2W)				37dBm(5W)				25dBm (0.25W)	
Maximum Composite Output Power(UL)	-15dBm(Typ.)									
Noise Figure	≤ 5dB @Maximum gain, Center Frequency									
VSWR	≤ 1.3:1 @ BTS interface port									

		≤ 1.5:1 @ Internal interface port	
Optical Loss		0~5dBo	
System Delay		< 2us	
Spurious		Meet FCC rules, 3GPP TS 36.104, 3GPP2 C.S0010-C	
Dimension (WXDXH, in)	Head End Chassis	19 x 19.7 x 7.0	
	POI/POIL	1.3 x 17.0 x 6.85	2.6 x 17.0 x 6.85
	RU(Remote Unit) Chassis	19 x 15.0 x 7.0	
	RU Chassis RU(Remote Unit) N4X	9.85 x 15.0 x 6.6 for PS78 and VU	
	RM(Remote Module)	2.3 x 13.8 x 6.85	
	Head End Chassis	20.9(including NMS-AC)	
	POI/POIL	6.17/5.0	8.85
	Weight(lbs)	RU(Remote Unit) Chassis	15.43
RU Chassis RU(Remote Unit) N4X		26.5	
RM(Remote Module)		9.92	
Optic Connectors		SC/APC (Green)	
Optic Wavelength		1310nm for downlink, 1550nm for uplink	
Operating Temperature		-40 - 140°F(-40~60°C)	
Operating Humidity		5~90%RH	
Power Supply	Head-End	ADXV-H-NMS-AC: 100 to 240V, 50-60Hz with battery backup function ADXV-H-NMS-DC: -36V to -72V DC	

	RU	ADXV-R-PSU-AC: 100 to 240V, 50-60Hz with battery backup function ADXV-R-PSU-DC: -36V to -72V DC
Network Management System		Ethernet(RJ45)
RF connector	POI	DIN (Female) SMA (Female) SMB (Female)
	POIL	4.3-10 (Female) SMB (Female)
	Remote Modules	4.3-10 (Female) SMA (Female)
Weather Resistance (Remote Modules)		IP66

"The Manufacturer's rated output power of this equipment is for single carrier operation. For situations when multiple carrier signals are present, the rating would have to be reduced by 3.5 dB, especially where the output signal is re-radiated and can cause interference to adjacent band users. This power reduction is to be by means of input power or gain reduction and not by an attenuator at the output of the device."

1.2 900P_Specifications.

Parameters		900P	Comments
Frequency	Downlink	928~941MHz	
	Uplink	896~902MHz	
Input Power Range @ POIL	Power Mode	POIL: +25~ -15dBm	
System Gain	Downlink	POIL to RM: 8~48dB	
	Uplink	-20~10dB	
Maximum Composite Output Power(DL)		+33dBm(2W)	
Maximum Composite Output Power(UL)		-35dBm(Typ)	
Noise Figure		≤ 5dB @maximum gain, Center Frequency	
VSWR		≤ 1.5:1	
Optical Loss		0~5dBo	
System Delay		< 2us	
Spurious		Meet FCC rules, 3GPP TS 36.104, 3GPP2 C.S0010-C	

Dimension (WXDXH)	POIL	1.31 x 6.86 x 17.02 inches	
	RM(Remote Module)	2.29 x 6.86 x 13.79 inches	
Weight	POIL	5.0 lbs	
	RM(Remote Module)	9.3 lbs	
Operating Temperature		-40 ~ 131°F(-40 ~ 55°C)	
Operating Humidity		5~95%	
Power Supply	Head-End	ADXV-H-NMS-AC: 100 to 240V, 50-60Hz with battery backup function ADXV-H-NMS-DC: -36V to -72V DC	
	Remote Unit	ADXV-R-PSU-AC: 100 to 240V, 50-60Hz with battery backup function ADXV-R-PSU-DC: -36V to -72V DC	
Network Management System		Ethernet(RJ45)	
Optic Connectors		SC/APC (Green)	
Optic Wavelength		1310nm for downlink, 1550nm for uplink	
RF connector	POIL	4.3-10 (Female) SMB (Female)	
	Remote Modules	4.3-10 (Female) SMA (Female)	
Weather Resistance (Remote Modules)		IP66	

9. MECHANICAL DRAWING

9.1 HE

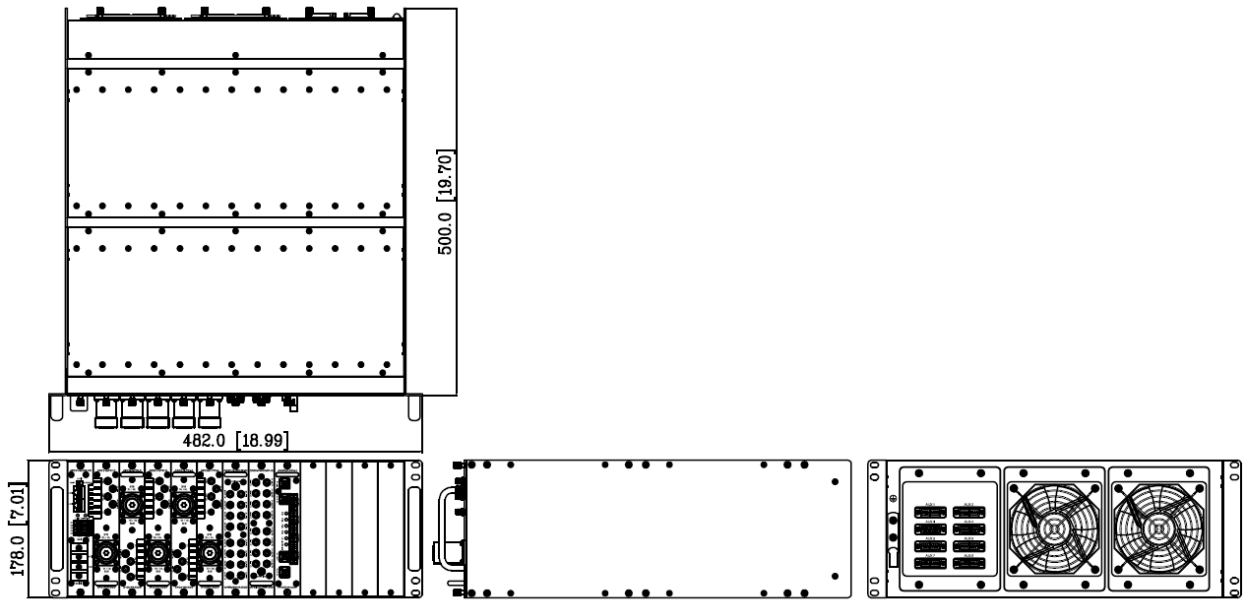

Figure 9-1 HE Drawing

9.2 RU

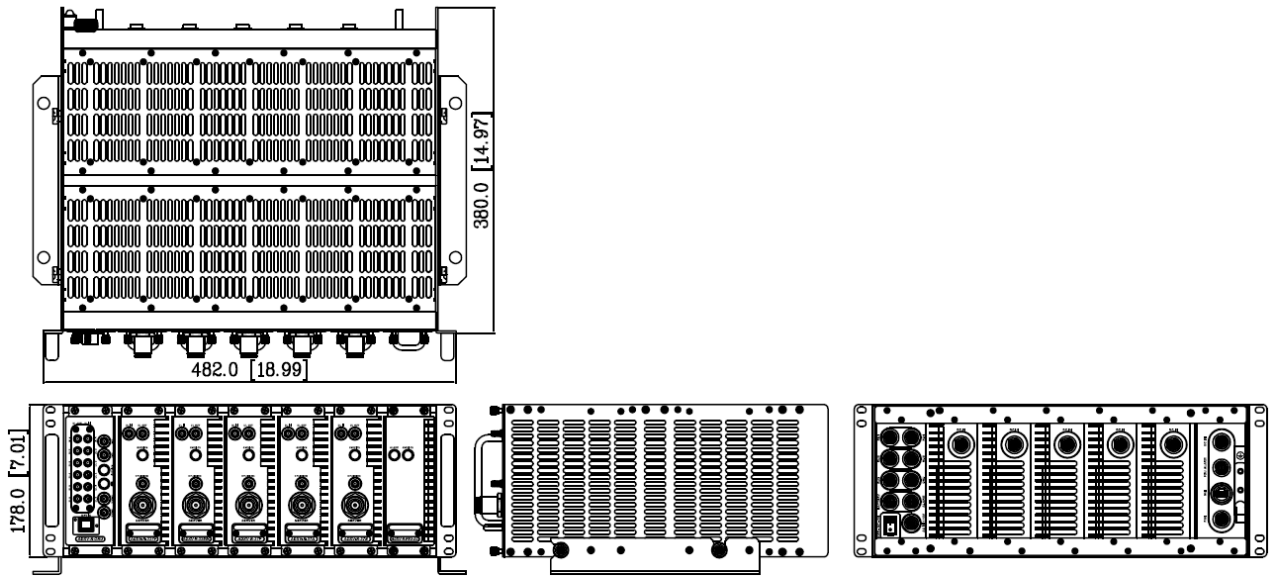

Figure 9-2 RU Drawing

9.3 N4X RU for PS78

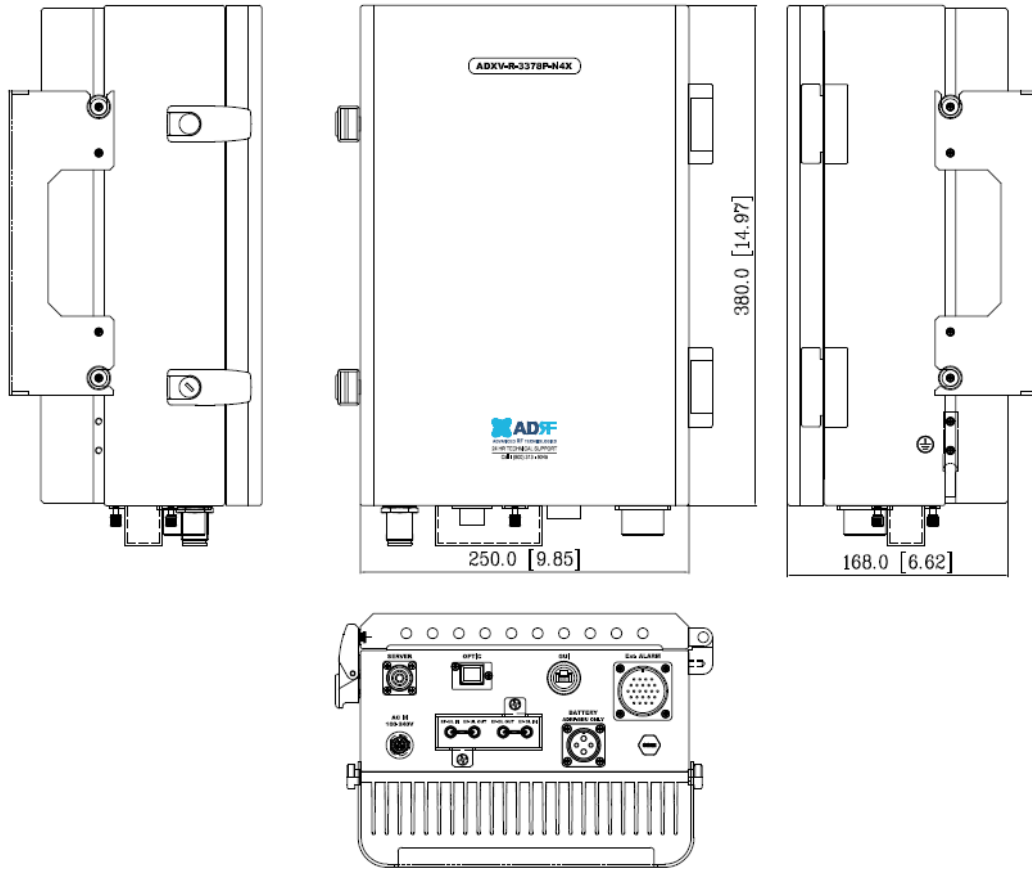

Figure 9-3 PS78 N4X RU Drawing

9.4 N4X RU for VU

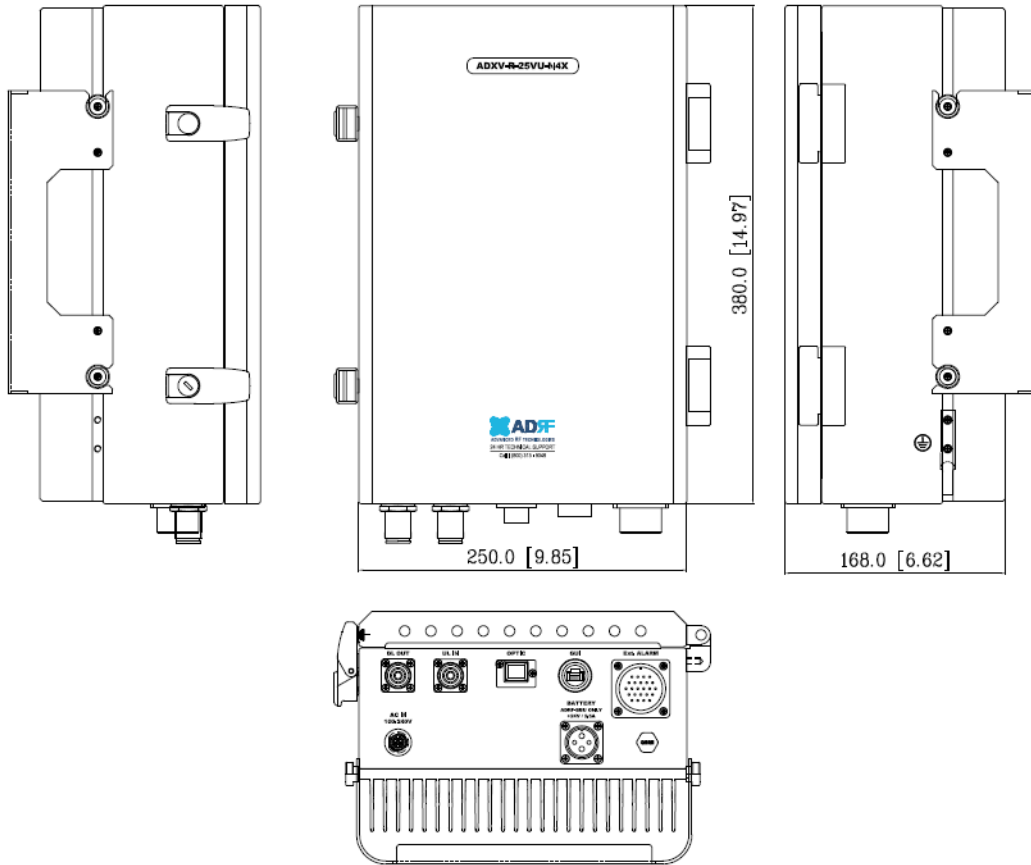

Figure 9-4 VU N4X RU Drawing