

ADXV-HPR User Manual

Version 0.6



3116 West Vanowen St.
Burbank, CA 91505
Tel: 818-840-8131
Fax: 818-840-8138

www.adrftech.com



Information in this document is subject to change without notice.

*Advanced RF Technologies, Inc. 1996-2015.
All rights reserved.*

- Please send comments to:

E-Mail: info@adrftech.com

Phone: (818) 840-8131

(800) 313-9345

Fax: (818) 840-8138

- Address:

Advanced RF Technologies, Inc.
Attention: Technical Publications Department
3116 Vanowen St.
Burbank, CA 91505
USA
www.adrftech.com

Revision History

Version	Author	Descriptions	Date
0.1	CK CHO	Initial Release	05/08/2017
0.2	CK CHO	Update	07/07/2017
0.3	CK CHO	Update	07/27/2017
0.4	CK CHO	600MHz Update	04/27/2020
0.5	CK CHO	7FN Update	05/21/2020
0.5	CK CHO	N77x Update	08/18/2022

Change List

Version	Change list	Contents

Table of Contents

1.	Introduction	11
1.1	Highlights	11
1.2	ADXV-DAS/ADXV-HPR Quick View	12
1.2.1	HE Quick View	12
1.2.2	ADXV-HPR Quick View	13
1.3	Warnings and Hazards	14
2.	Block Diagram	17
2.1	ADXV Block Diagram	17
2.2	ADXV Scalability	18
3.	ADxv Overview	19
3.1	Head End.....	19
3.1.1	NMS (Network Management System).....	19
3.1.1.1	LEDs	20
3.1.1.2	AAI	20
3.1.1.3	Ethernet Port	21
3.1.1.4	Host/Remote Switch.....	21
3.1.1.5	Power Connection (for DC -48V)	22
3.1.1.6	Power Connection (for AC 110V).....	22
3.1.2	POI (ADXV-H-POI-x)	23
3.1.2.1	LED	24
3.1.2.2	RF Ports.....	25
3.1.3	Channel Combiner (CHC, ADXV-H-CHC)	25
3.1.3.1	RF ports.....	26
3.1.4	Optical Donor Unit (ODU, ADXV-H-ODU-4)	27
3.1.4.1	LEDs	27
3.1.4.2	RF Ports.....	28
3.1.4.3	Optic Ports	28
3.2	Remote Unit (ADXV-HPR)	28
3.2.1	Remote Module (ADXV-HPR-4XX)	30
3.2.1.1	HPR ID numbering and RF line connection scheme.....	30
3.2.1.2	RF port	31
3.2.1.3	Power port.....	31
3.2.1.4	LED.....	31
3.2.2	Optical Remote Unit (ADXV-HPR-ORU)	31
3.2.2.1	Front port.....	32
3.2.2.2	Rear port.....	32
3.2.2.3	LED	32

3.2.3	PSU (ADXV-HPR-PSU)	33
3.2.3.1	Port	33
3.2.3.2	LED	34
3.2.3.3	AC Switch	34
4.	Cable Connection	34
4.1	Head End Connection Diagrams	34
4.2	Remote Unit Connection Diagrams	35
5.	Mounting method	37
5.1	Head End	37
5.1.1	Rack Mount	37
5.2	ADXV-HPR	38
5.2.1	Rack Mount	38
6.	Installation	38
6.1	Pre-Installation Inspection	38
6.2	ADXV Installation Procedure	39
6.2.1	HE Installation Procedure	39
6.2.1.1	Installing a ADXV- HE in a rack	39
6.2.2	ADXV-HPR Installation Procedure	41
6.2.3	RF coaxial cable and antenna connection	43
6.3	Grounding	43
6.4	Optic Port Cleaning	44
7.	Web-GUI	45
7.1	Web-GUI Setup	45
7.1.1	DAS system/PC Connection Using Web-GUI	45
7.2	Administrator/User Mode	46
7.2.1	Common	46
7.2.1.1	Navigation Tree	46
7.2.1.2	Power Status	46
7.2.1.3	Commissioning Status	46
7.2.1.4	Information	46
7.2.2	Status Tab	48
7.2.2.1	Status – NMS	48
7.2.3	System	51
7.2.3.1	System: Account	51
7.2.3.2	System: Logs	53
7.2.3.3	System: Update	54
7.2.4	Help	54
7.2.5	Logout	55
7.3	Guest Mode	55



8.	ADXV-System-Wide Specification	56
9.	Mechanical Drawing	63
9.1	HE.....	63
9.2	ADXV-HPR	64

Figures

Figure 1-1	ADXV-HPR HE Quick View (Front and Rear)	12
Figure 1-2	ADXV-HPR ADXV-HPR Quick View (Front and Rear)	13
Figure 2-1	ADXV-HPR Block Diagram	17
Figure 3-1	Head End Front View	19
Figure 3-2	ADXV-H-NMS Front View	20
Figure 3-3	NMS LED	20
Figure 3-4	NMS AAI	21
Figure 3-5	Ethernet Port	21
Figure 3-6	Host/Remote Switch	22
Figure 3-7	POI front View	23
Figure 3-8	POI LED	24
Figure 3-9	ADXV-H-CHC Front View	25
Figure 3-10	ADXV-H-ODU-4 Front view	오류! 책갈피가 정의되어 있지 않습니다.
Figure 3-11	ADXV-H-ODU-4 LED	27
Figure 3-12	ODU RF Ports	28
Figure 3-13	ODU Optic Ports	28
Figure 3-14	ADXV-R Front and Rear (without FAN and with FAN) View	29
Figure 3-15	ADXV-R-4XX (RM) Front and Rear View	30
Figure 3-16	RM ID numbering and RF connection between OADXV-HPR and RM	31
Figure 3-17	ADXV-R-OADXV-HPR Front View	32
Figure 3-18	ADXV-R-PSU Front View	33
Figure 4-1	HE Cable connection (4 ADXV-H-POIs, 2 ADXV-H-ODUs)	34
Figure 4-2	ADXV-HPR 4ands connection	35
Figure 5-1	HE Rack Mount (Front & Rear view)	37
Figure 5-2	ADXV-HPR Rack Mount Front and Rear View	38
Figure 6-1	HE Installation Procedure	40
Figure 6-2	ADXV-HPR Installation Procedure	42
Figure 6-3	HE Ground Cable Connection, Protective Earthing Conductor (HE chassis rear side)	43
Figure 6-4	ADXV-HPR Ground Cable Connection, Protective Earthing Conductor (ADXV-HPR chassis rear side)	43
Figure 6-5	Optic Connector Cleaning (left) and Optic Port Cleaning (right)	44
Figure 6-6	SC/APC Optic Connector Dust Cap	44
Figure 7-1	Login screen	45
Figure 7-2	ADXV-HPR General Information	47
Figure 7-3	SNMP (Install – NMS)	48
Figure 7-4	Location Setting (Install – NMS)	49
Figure 7-5	External Modem Box Setting (Install – NMS)	49
Figure 7-6	Description (Install – NMS)	49
Figure 7-7	SNMP Agent False Alarm Test (Install – NMS)	50
Figure 7-8	Location Info / Installer Info (Install – NMS)	50
Figure 7-9	Date & Time Setting (Install – NMS)	51
Figure 7-10	Description (Install-Remote Module)	51
Figure 7-11	Account Management	51
Figure 7-12	New Account	52
Figure 7-13	Change Password	53
Figure 7-14	User Log	53
Figure 7-15	System update	54
Figure 7-16	Message after System update is complete	54
Figure 7-17	Help	55
Figure 9-1	HE Drawing	63



Figure 9-2 ADVX-HPR Drawing.....64

Tables

Table 2-1	ADXV-HPR Scalability	18
Table 3-1	NMS LED Specifications	20
Table 3-2	NMS AAI Specifications.....	21
Table 3-3	POI LED Specifications	24
Table 3-4	POI RF port.....	25
Table 3-5	ODU LED Specifications	27
Table 7-1	Account Information for Login	45
Table 7-2	Navigation tree	46
Table 7-3	Power Supply Status	46
Table 7-4	Commissioning ICON	46
Table 7-5	System Summary Description.....	48

Terms and Abbreviations

The following is a list of abbreviations and terms used throughout this document.

Abbreviation/Term	Definition
AGC	Automatic Gain Control
ALC	Automatic Level Control
AROMS	ADRF' Repeater Operation and Management System
BCU	Band Combiner Unit
BTS	Base Transceiver Station
CDMA	Code Division Multiple Access
CHC	Channel combiner
CW	Continuous Wave (un-modulated signal)
DAS	Distributed Antenna System
DL	Downlink
Downlink	The path covered from the Base Transceiver Station (BTS) to the subscribers' service area via the repeater
HE	Head End
HPA	High Power Amplifier
HW	Hardware
IF	Intermediate Frequency
LNA	Low Noise Amplifier
LTE	Long Term Evolution
MS	Mobile Station
NMS	Network Management System
ODU	Optical Donor Unit which is located in ADXV-HE.
OEU	Optic Expansion Unit
PLL	Phased Locked Loop
POI	Point Of Interface
PSU	Power Supply Unit
RF	Radio Frequency
ADXV-HPR	Remote Unit
RM	Remote Module
SW	Software



UL

Uplink

VSWR

Uplink

The path covered from the subscribers' service area to the Base Transceiver Station (BTS) via the repeater

Voltage Standing Wave Ratio

1. INTRODUCTION

Currently the ADXV-HPR supports 600,700 MHz (Lower A, Lower B, Lower C, and Upper C), SMR800/Cellular, PCS, AWS, WCS, BRS TD-LTE, [N77H \(3.7 GHz\)](#)

1.1 Highlights

- Modular Structure (HE)
 - Supports multi bands service in one body
 - Supports up to 12 slot available for POI, ODU (ODU-X), CHC (CHC-X) card, etc.
- Supports up to a of maximum of 96 Remote Units(using Optical Expansion Unit)
- 43/45/46dBm of downlink composite output power
- Requires only single strand of fiber per remote unit
- Operates with up to 5dB_o optical loss
- Supports SNMP v1, v2, v3 (get, set & traps)
- Web-based GUI Interface; No 3rd party GUI software required
- Web-GUI connectivity via DHCP in host mode
- Versatility and Usability: ADXV-DAS gives total control to the user. Control parameters such as gain, output power, and alarm threshold can be changed using Web-GUI interface allowing the user to fine tune the system to the given RF environment.

1.2 ADXV-HPR Quick View

1.2.1 HE Quick View

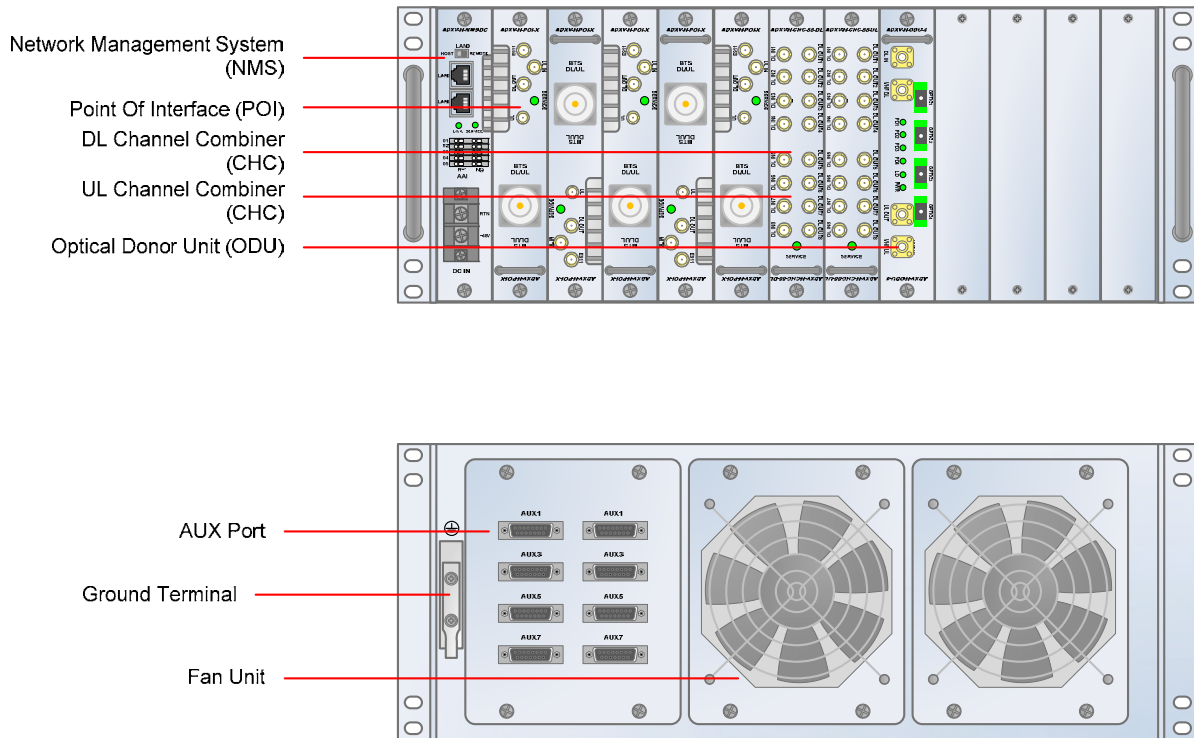

Figure 1-1 ADXV-DAS HE Quick View (Front and Rear)

1.2.2 ADXV-HPR Quick View

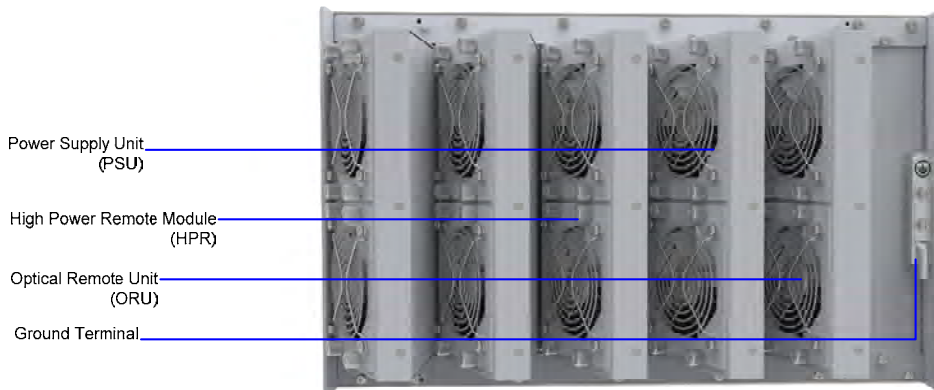
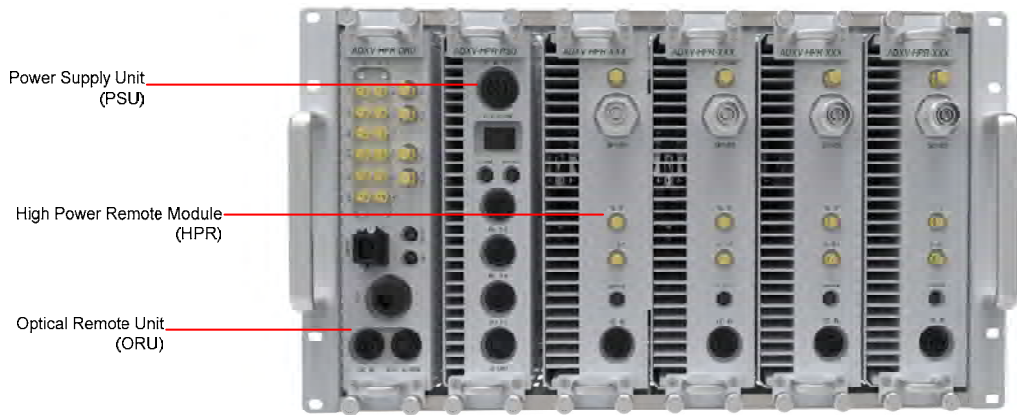

Figure 1-2 ADXV-HPR Quick View (Front and Rear)

1.3 Warnings and Hazards



WARNING! ELECTRIC SHOCK

Opening the ADXV-HPR could result in electric shock and may cause severe injury.



WARNING! EXPOSURE TO RF

Working with the ADXV DAS while in operation, may expose the technician to RF electromagnetic fields that exceed FCC rules for human exposure. Please maintain a minimum safe distance of at least **105 cm** while operating near the donor and the server antennas. Also, the donor antenna needs to be mounted outdoors on a permanent structure.

HPR is a coverage system for in-building services. The system covers general public institutions and private facilities.

- Shopping malls
- Hotels
- Campus areas
- Airports
- Clinics
- Subways

WARRANTY

Opening or tampering the ADXV-HPR will void all warranties.

Lithium Battery: CAUTION. RISK OF EXPLOSION IF BATTERY IS REPLACED BY INCORRECT TYPE. DISPOSE OF USED BATTERIES ACCORDING TO INSTADXV-HPRCTIONS.

Ethernet Instructions: This equipment is for indoor use only. All cabling should be limited to inside the building.

FCC Part 15 Class A

NOTE: This equipment has been tested and found to comply with the limits for a Class A digital device, pursuant to part 15 of the FCC rules. These limits are designed to provide reasonable protection against harmful interference when the equipment is operated in a commercial environment. This equipment generates, uses, and can radiate radio frequency energy and, if not installed and used in accordance with the instruction manual, may cause harmful interference to radio communications. Operation of this equipment in a residential area is likely to cause harmful interference in which case the user will be required to correct the interference at their own expense.

FCC Part 20

WARNING. THIS is NOT a CONSUMER device. It is designed for installation by FCC LICENSEES and QUALIFIED INSTALLERS. You MUST have an FCC LICENSE or express consent of an FCC Licensee to operate this device. Unauthorized use may result in significant forfeiture penalties, including penalties in excess of \$100,000 for each continuing violation.

Laser Safety

Fiber optic ports of the ADXV-HPR emit invisible laser radiation at the 1310, 1550nm wavelength window.

To avoid eye injury never look directly into the optical ports, patch cords or optical cables. Do not stare into beam or view directly with optical instruments. Always assume optical output is on.

Only technicians familiar with fiber optic safety practices and procedures should perform optical fiber connections and disconnections of the ADXV-HPR and the associated cables.

The ADXV-HPR complies with 21 CFR 1040.10 and 1040.11 except for deviations pursuant to laser notice No.50 (July26, 2001)@IEC 60825-1, Amendment2 (Jan. 2001).

Care of Fiber Optic Connectors

Do not remove the protective covers on the fiber optic connectors until a connection is ready to be made. Do not leave connectors uncovered when not connected.

The tip of the fiber optic connectors should not come into contact with any object or dust.

Refer to the cleaning procedure for information on the cleaning of the fiber tip.

Use of unauthorized antennas, cables, and/or coupling devices not conforming with ERP/EIRP and/or indoor-only restrictions is prohibited.

Home/ personal use are prohibited

Only 50 ohm rated antennas, cables and passive equipment shall be used with this remote. Any equipment attached to this device not meeting this standard may cause degradation and unwanted signals in the bi-directional system. All components connected to this device must operate in the frequency range of this device.

Only 50 ohm rated antennas, cables and passive components operating from 150 - 3 GHz shall be used with this device.

CAUTION

Double Pole/Neutral Fusing.

Permanent earthing

for PERMANENTLY CONNECTED EQUIPMENT, a readily accessible disconnect device shall be incorporated external to the equipment;

2. BLOCK DIAGRAM

2.1 ADXV Block Diagram

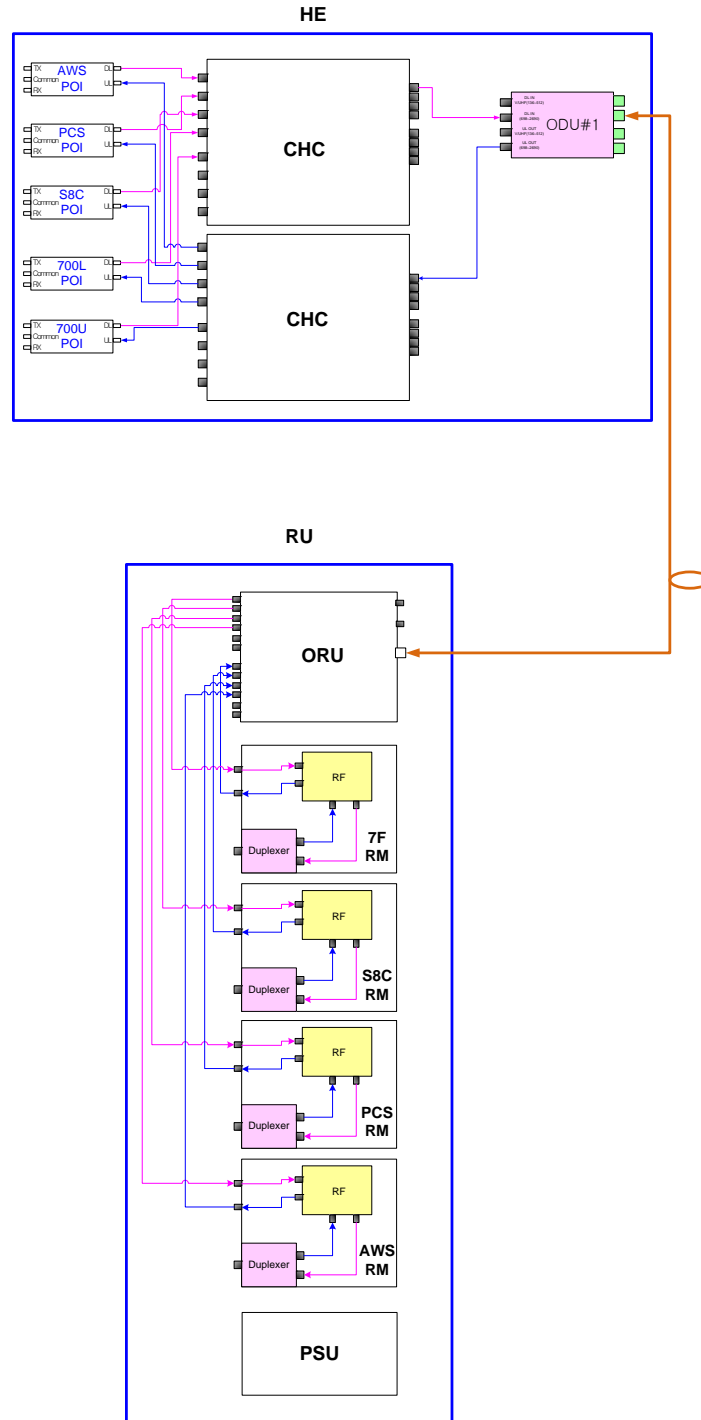

Figure 2-1 ADXV Block Diagram

2.2 ADXV Scalability

Table 2-1 ADXV Scalability

Unit		Scalability	Remarks
Supported band		600, 700F, S8C, AWS, PCS, WCS, BRS TD-LTE, 700FN, N77H (3.7 GHz)	
HE	POI	No limitation in 12 slots except NMS	
	NMS	1	
	CHC	No limitation in 12 slots except NMS	
	Optic Unit	No limitation in 12 slots except NMS In case of Aux, No limit in 8 Aux ports	
ADXV-HPR	ADXV-HPR		64
	PSU (ADXV-HPR)	Adaptor type	1 per HPR Remote Module(HRM)
		19" rack mount (AC or DC)	1

3. ADXV OVERVIEW

3.1 Head End

The head end unit must always be connected to the Base Station using a direct cabled connection. This system has not been approved for use with a wireless connection via server antenna to the base station.

- Specifications
 - Size: 19.0 x 19.7 x 7inches (482 x 500 x 178 mm)
 - Weight: 64.8lbs @5 POI, 2 CHC, ODU(ODU-X) and NMS
 - Power Input: 110VAC(optional) or -48VDC

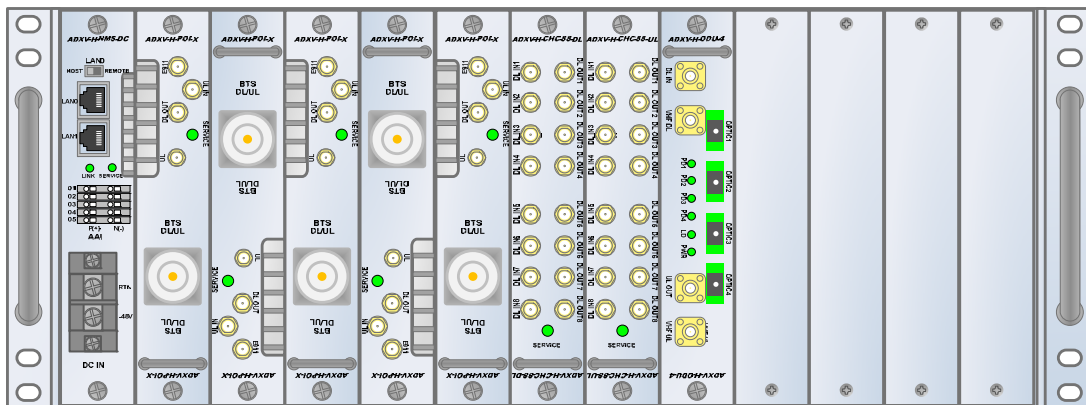

Figure 3-1 Head End Front View

3.1.1 NMS (Network Management System)

- Functions and features
 - Supports SNMP v1, v2, and v3 (get, set & trap) and web-based GUI Interface.
 - Monitors alarms and status
 - Provides control interfaces with all subordinate modules
 - Provides overall DAS structure via the auto tree update function
- Spec
 - Size: 19.0 x 12.1 x 1.7inches
 - Weight: 3.5lbs

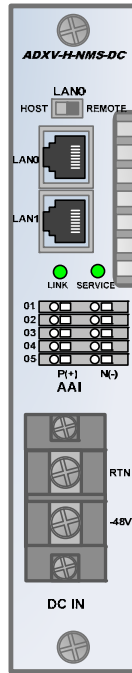

Figure 3-2 ADXV-H-NMS Front View

3.1.1.1 LEDs

NMS has LEDs on the front panel as shown in Figure 3-3.



Figure 3-3 NMS LED

Table 3-1 NMS LED Specifications

ADXV-HPR-NMS		Specifications
POWER	Solid Green	NMS power is ON
	OFF	NMS power is OFF
LINK	Solid Red	HE Link Fail alarm exists in the system
	Solid Green	No HE Link Fail alarms are present in the system

3.1.1.2 AAI

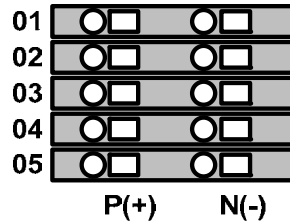

Figure 3-4 NMS AAI

NMS has 5 external alarms out interface pins on the front panel.

Table 3-2 NMS AAI Specifications

AAI Alarm Status	Output
Normal	High Impedance (Open)
Alarm	Low Impedance (Short)

3.1.1.3 Ethernet Port

The Ethernet port can be used to communicate directly with the ADXV-HPR using a RJ-45 crossover cable or can also be used to connect the ADXV-HPR to an external modem box.

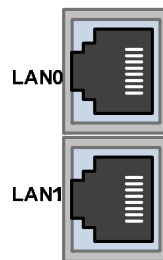

Figure 3-5 Ethernet Port

3.1.1.4 Host/Remote Switch

The Host/Remote Switch allows the user to switch the default Repeater IP, Subnet Mask, and Gateway of the repeater to an alternative setup. These settings can be adjusted by logging into the ADXV-HPR in HOST mode and configuring the settings under the Modem Box Setting section under the Install Page of NMS.

Once the settings are set, flipping the switch to the REMOTE position will reboot NMS module with the new alternate settings. *Please note that when the NMS is set to the REMOTE position, DHCP is disabled and the NMS will not automatically assign an IP address to any device that connects directly to the NMS.*

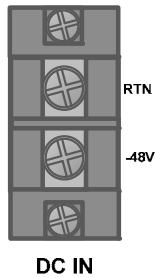

Figure 3-6 Host/Remote Switch

- Host IP: 192.168.63.1 (Fixed IP, unable to modify this IP address)
- Remote IP: 192.168.63.5 (Default IP, but can be modified in Host mode)

3.1.1.5 Power Connection (for DC -48V)

NMS has terminal block for DC power connection on the front panel. You should verify power polarity of each power line and should turn on the power after power connection necessarily.



3.1.1.6 Power Connection (for AC 110V)

NMS has Chogori connectors for AC power feeding and battery backup on the front panel. You should verify power polarity of each power line and should turn on the power after power connection necessarily.



3.1.2 POI (ADXV-H-POI-XX)

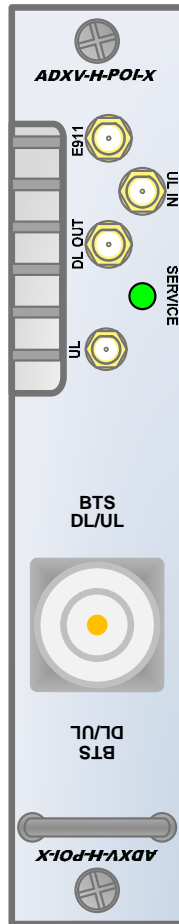

Figure 3-7 POI front View

3.1.2.1 POI (ADXV-H-POI-N77x)

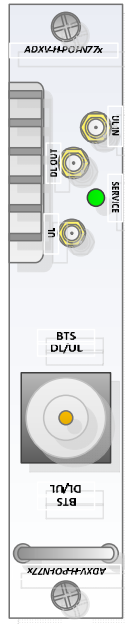

Figure 3-8 POI-N77x front View

- Functions and features
 - Provide RF interface with BTS
 - Each POI has independent gain control and filtering
 - Modular type and hot swappable
 - Supports duplex port and simplex RX port
 - Easily support additional frequency bands by adding a single POI
 - Reduces complexity and overall equipment size
- Specifications
 - Size: 1.3 x 17.1 x 6.85inches
 - Weight: 6.2lbs

3.1.2.2 LED

POI has LEDs on the front panel as shown in Figure 3-9.

POWER



Figure 3-9 POI LED

Table 3-3 POI LED Specifications

POI		Specifications
Power	Solid Green	POI power is ON and POI is normal status
	Solid Red	POI power is ON and POI is hard fail alarm status
	Solid Yellow	POI power is ON and POI is soft fail alarm status

3.1.2.3 RF Ports

BTS DL/UL, DL OUT, UL IN, E911 Ports (refer to Figure 3-7) are located at the front of the POI

Table 3-4 POI RF port

RF Port	Function
BTS DL/UL	BTS Interface, DL duplexer Input, UL duplexer output
DL OUT	DL output
UL IN	UL input
UL OUT	UL output not passing through duplexer
E911	E911 RF interface (POI & POIL Only)

3.1.3 Channel Combiner (CHC, ADXV-H-CHC)

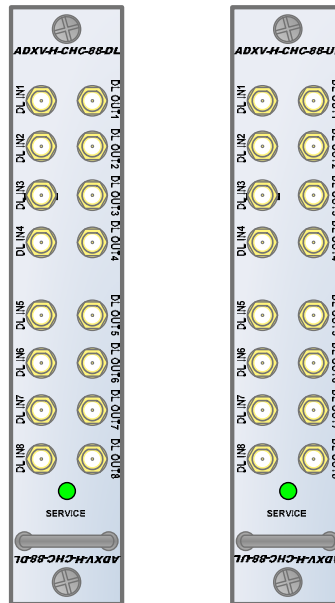

Figure 3-10 ADXV-H-CHC Front View

3.1.4 Channel Combiner (CHC, ADXV-H-CHC-X)

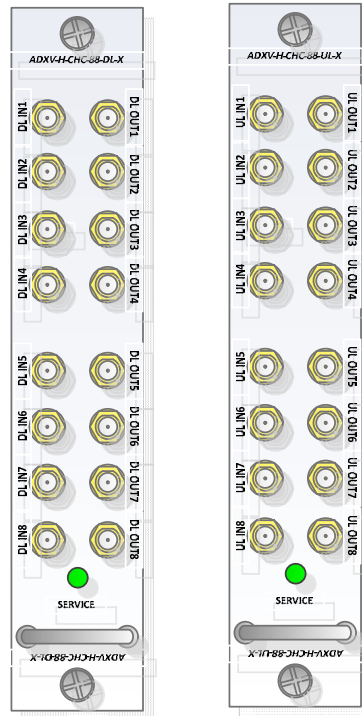

Figure 3-11 ADXV-H-CHC-X Front View

- Functions & Features
 - Combines DL signals received from each POI and feeds the combined signals to the ADXV-H-ODU(ADXV-H-ODU-X)
 - Combines UL signals received from each ADXV-HPR and feeds the combined signal to the ADXV-H-POI
 - No limit of installation number and location to install POI, ODU(ODU-X), CHC(CHC-X) card in 12 slots except NMS card
- Specifications
 - Size: 1.3 x 17.1 x 6.85inches
 - Weight: 4.4lbs per CHC(CHC-X)

3.1.4.1 RF ports

3.1.4.1.1 RF ports at the front panel (DL 1 to DL 8, UL 1 to UL 8)

DL 1(to DL 8) & UL 1(to UL 8) RF ports are connected to DL OUT/UL IN Ports at the front panel of POI.

- Receive the downlink signal from each POI
- Split the uplink signal received from ODU(ODU-X), to each POI

3.1.4.1.2 RF ports at the back panel (DL 1 to DL 8, UL 1 to UL 8)

DL 1(to DL 8) & UL 1(to UL 8) RF ports are connected to DL IN/UL OUT Ports at the back panel of ODU(ODU-X),.

- Transfer the combined downlink signals to ODU(ODU-X),
- Receive the uplink signal from ODU(ODU-X),

3.1.5 Optical Donor Unit (ODU(ODU-X), ADXV-H-ODU-4(ADXV-H-ODU-4X)

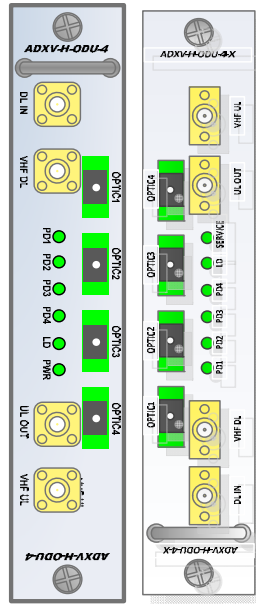

Figure 3-12 ADXV-H-ODU-4(ADXV-H-ODU-4X) Front view

- Functions & Features
 - Converts signal from RF to optic and transports signals up to a maximum of 10Km (optical 5dB loss including optical connection loss).
 - One ADXV-H-ODU-4 supports up to 4 ADXV-HPRs
 - Minimizes the number of optical fiber cable need by transporting multi band signals over a single strand of fiber using WDM technology.
- Spec
 - Size: 1.3 x 17.1 x 6.85inches
 - Weight: 5.3lbs

3.1.5.1 LEDs

The ADXV-H-ODU-4 has the following LEDs on the front panel as shown in Figure 3-13.

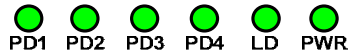

Figure 3-13 ADXV-H-ODU-4 LED

Table 3-5 ODU LED Specifications

ADXV-HPR-Module		Specifications
PWR	Solid Green	Module power is ON
	OFF	Module power is OFF
LD	OFF	ODU is not installed
	Solid Yellow	LD Fail alarm exists in the ODU
	Solid Green	No LD Fail alarm is present in the ODU
PD1 to PD4	Solid Yellow	PD Fail alarm exists
	Solid Green	No PD Fail alarm is present

3.1.5.2 RF Ports



Figure 3-14 ODU(ODU-X) RF Ports

3.1.5.2.1 DL IN/UL OUT

The combined downlink signal received from ADXV-H-CHC(ADXV-H-CHC-X) is transferred to the DL IN at the back of ODU.

The UL OUT port connects any of the ports on back of the ADXV-H-CHC(ADXV-H-CHC-X) labeled UL 1 ~8.

3.1.5.2.2 VHF DL/VHF UL

VHF DL/UHF UL ports are used to support Public Safety in the VHF & UHF frequency bands. VHF/UHF signals for Public Safety bypass the ADXV-H-CHC and connect directly to the VHF DL/UHF UL ports of the ADXV-H-ODU(ADXV-H-CODU-X).

3.1.5.3 Optic Ports

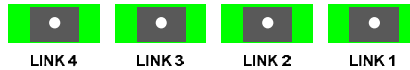

Figure 3-15 ODU(ODU-X) Optic Ports

The ADXV-H-ODU4 has (4) optic ports and can support up to (4) Main ADXV-HPR's. Likewise, the ADXV-H-ODU1(ADXV-H-CODU-X) has (1) optic ports and can support up to (1) Main ADXV-HPR.

3.2 ADXV-HPR

- A remote unit (single ADXV-HPR chassis base) is composed of an ADXV-HPR-ORU (ADXV-HPR-ORU-X) (Optical Remote Unit), a PSU (Power Supply Unit) and plural band's RM (Remote Module).
- Specifications
 - Size: 19.0 x 14.96 x 7 inches (482 x 380 x 178 mm)
 - Weight: 62.17lbs (28.2 Kg)@4 HPR(600/437F/43S8C/46P/46A, 46N77L, 46N77H), ADXV-HPR-ORU(ADXV-HPR-ORU-X) and PSU
 - Power Input: 110VAC or -48VDC

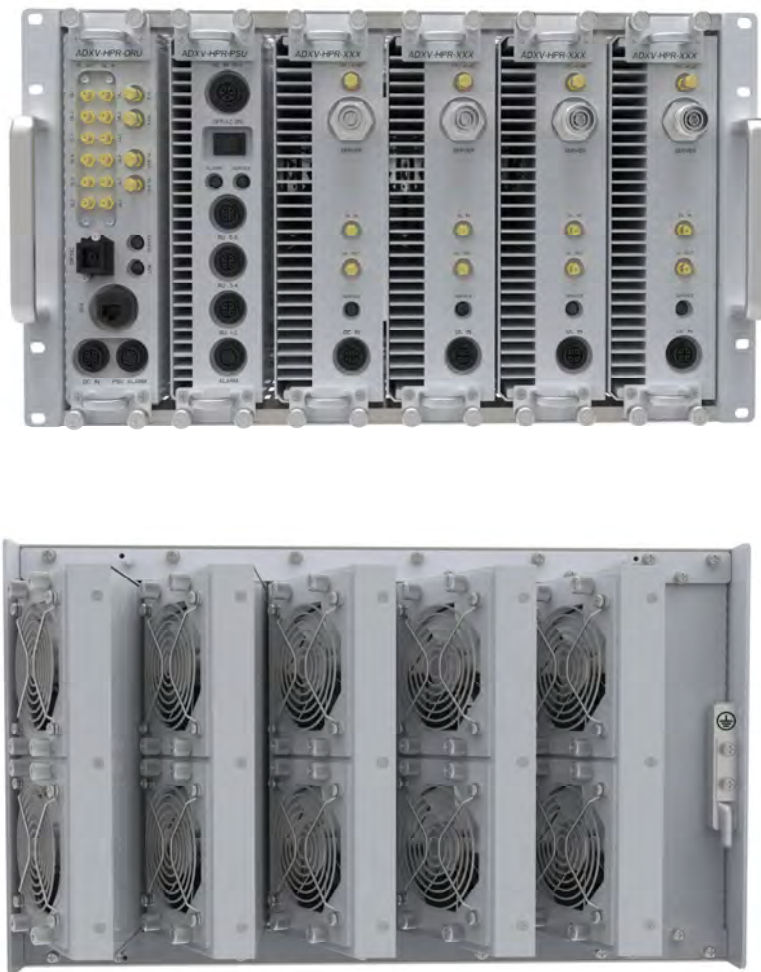

Figure 3-16 ADXV-R Front and Rear View

3.2.1 Remote Module (ADXV-HPR-4XX)



Figure 3-17 ADXV-HPR-4XX (RM) Front and Rear View

- Spec
 - Size: 2.75 x 17.8 x 10.3 inches
 - Weight: 13.22lbs for 436, 437F, 43S8C, 46P, 46A, 45W, 46BT, 46N77L, 46N77H

3.2.1.1 HPR ID numbering and RF line connection scheme

HPR ID right next to ADXV-HPR-ORU(ADXV-HPR-ORU-X) is HPR #1, HPR second next is HPR #2, the rest of HPR s' ID numbering is in the same order.

With RF connection between ADXV-HPR-ORU and HPR, it is necessary ADXV-HPR ID number should be equal to DL/UL port number of ADXV-HPR-ORU(ADXV-HPR-ORU-X) because of ADXV-HPR ID management and normal serial communication.

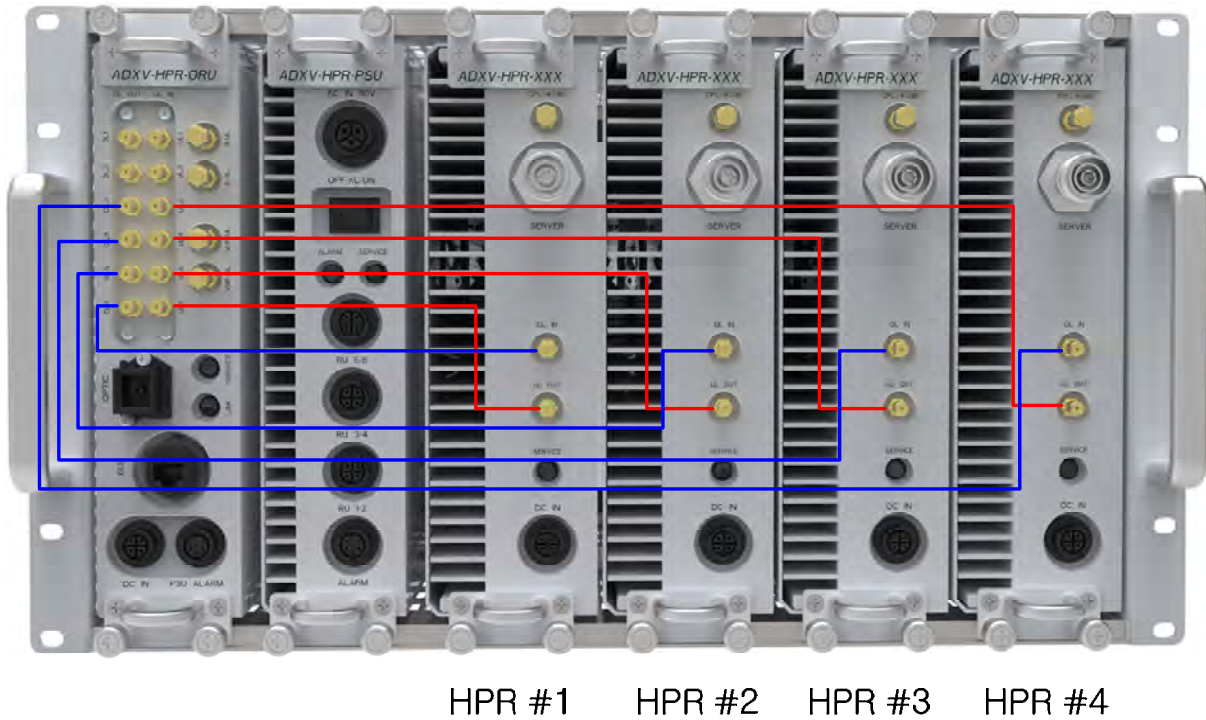

Figure 3-18 ADXV-HPR ID numbering and RF connection between ADXV-HPR-ORU and ADXV-HPR

3.2.1.2 RF port

DL IN/UL OUT connect to ADXV-HPR-ORU(ADXV-HPR-ORU-X)'s DL port and UL port, it is necessary to connect UL's port number equal to DL's because of serial communication with ADXV-HPR-ORU.

- CPL (-40dB): DL output 40dB coupling
- SERVER: DL output, UL input, Server Duplexer port

3.2.1.3 Power port

- ADXV-HPR-PSU DC IN: Port for power supply (+28VDC) and communication with Controller inside PSU.
- ADXV-HPR-PSU-AC-50DC IN: Port for power supply (+50VDC) and communication with Controller inside PSU

3.2.1.4 LED

LED color	Status
Green	Normal
Yellow	Soft fail
Red	Hard fail

3.2.2 Optical Remote Unit (ADXV-HPR-ORU,(ADXV-HPR-ORU-X))

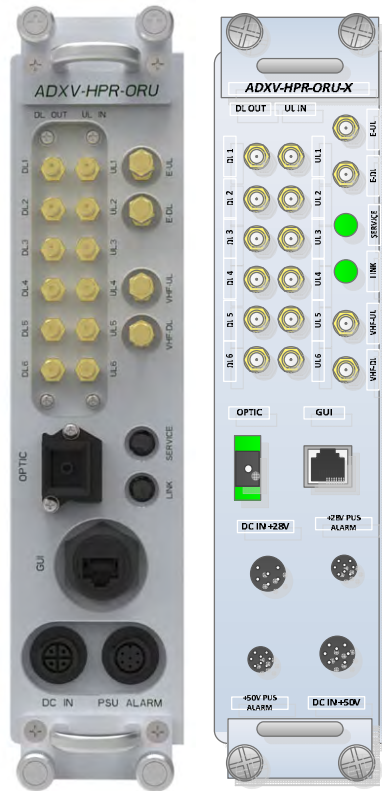

Figure 3-18 ADXV-HPR-ORU(ADXV-HPR-ORU-X) Front View

- Spec
 - Size: 2.36 x 13.8 x 10.3 inches
 - Weight: 11.02lbs

3.2.2.1 Front port

DL1-DL6: DL port connect to 'DL IN' of ADXV-HPR (Remote Module) (see 3.2.1.1)
 UL1-UL6: UL port connect to 'UL OUT' of ADXV-HPR (Remote Module)(see 3.2.1.1)
 E-DL/E-UL ports connect to external splitter for extension of band RM
 VHF-DL/VHF-UL ports connect to the ADXV VHF/UHF RM
 OPTIC port connects with optic line with waterproof optical connector (provided by ADRF)

3.2.2.2 Rear port

DC IN port connects to PSU's ADXV-HPR-ORU(ADXV-HPR-ORU-X)port.
 PSU ALARM port connects to PSU's ALARM port.
 GUI port for connection to Lap top.
 FAN port for connection to FAN unit.

3.2.2.3 LED

LED	LED color	Status
Link	Green	Link normal
	Yellow	Link fail
Service	Green	Normal
	Yellow	Soft fail
	Red	Hard fail

3.2.3 PSU (ADXV-HPR-PSU(28V), ADXV-HPR-PSU-AC-50, ADXV-HPR-PSU-DC-50)



Figure 3-19 ADXV-HPR-PSU, ADXV-HPR-PSU-AC-50, ADXV-HPR-PSU-DC-50 Front View

- Spec
 - Size: 2.36 x 17.8 x 10.3inches
 - Weight: 11.02lbs for AC/DC PSU
 - Weight: 11.02lbs for AC-50/DC-50 PSU

3.2.3.1 Port

ADXV-HPR1-ADXV-HPR4 ports connect respectively to ADXV-HPR's front port.

ADXV-HPR-ORU (ADXV-HPR-ORU-X) port connects to ADXV-HPR.

ALARM port connects to 'PSU ALARM' port of ADXV-HPR-ORU (ADXV-HPR-ORU-X) ALARM port

AC IN 110V port connects to AC 110V

3.2.3.2 LED

LED	LED color	Status
ALARM	Green	Normal
	Yellow	Link fail
SERVICE	Green	Normal
	Yellow	Soft fail
	Red	Hard fail

3.2.3.3 AC Switch

The ADXV-HPR is operated at 110 AC.

(WARNING: The AC switch must be set to OFF before cable connection to avoid equipment damage and personal injury.)

(WARNING: To avoid damage, be sure 110V AC for operation of ADXV-HPR.)

(CAUTION: DOUBLE POLE/NEUTRAL FUSING.)

The procedure for connecting ADXV-HPR

- AC S/W OFF
- AC cable connection
- Optic connection
- RF cable connection
- AC S/W ON

4. CABLE CONNECTION

4.1 Head End Connection Diagrams

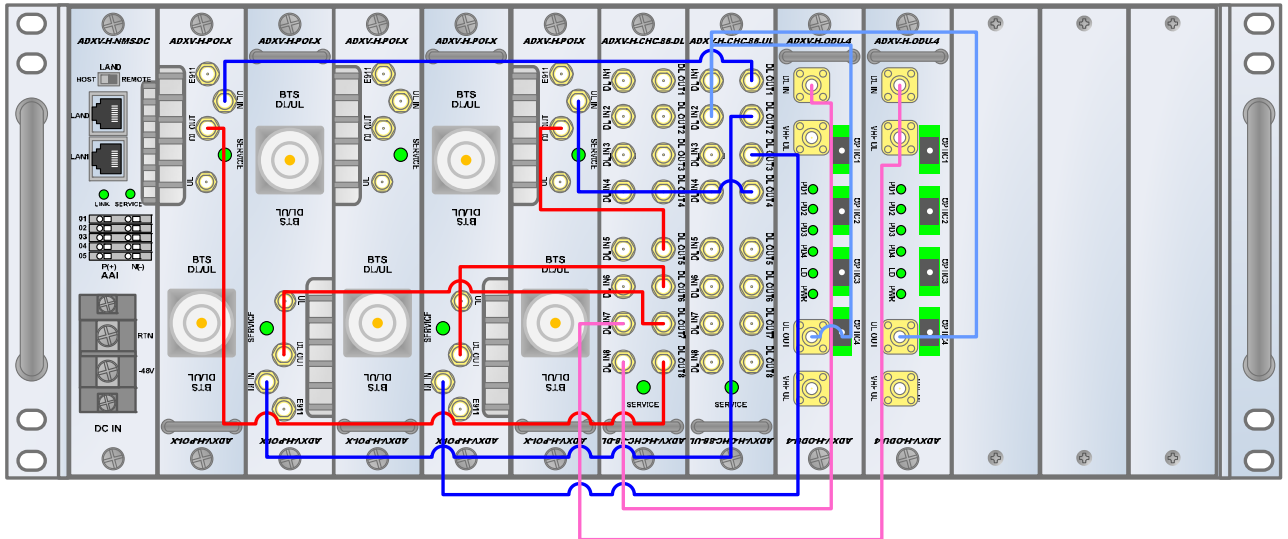

Figure 4-1 HE Cable connection (4 ADXV-H-POIs, 2 ADXV-H-ODUs(ADXV-H-ODU-X))

4.2 Remote Unit Connection Diagrams

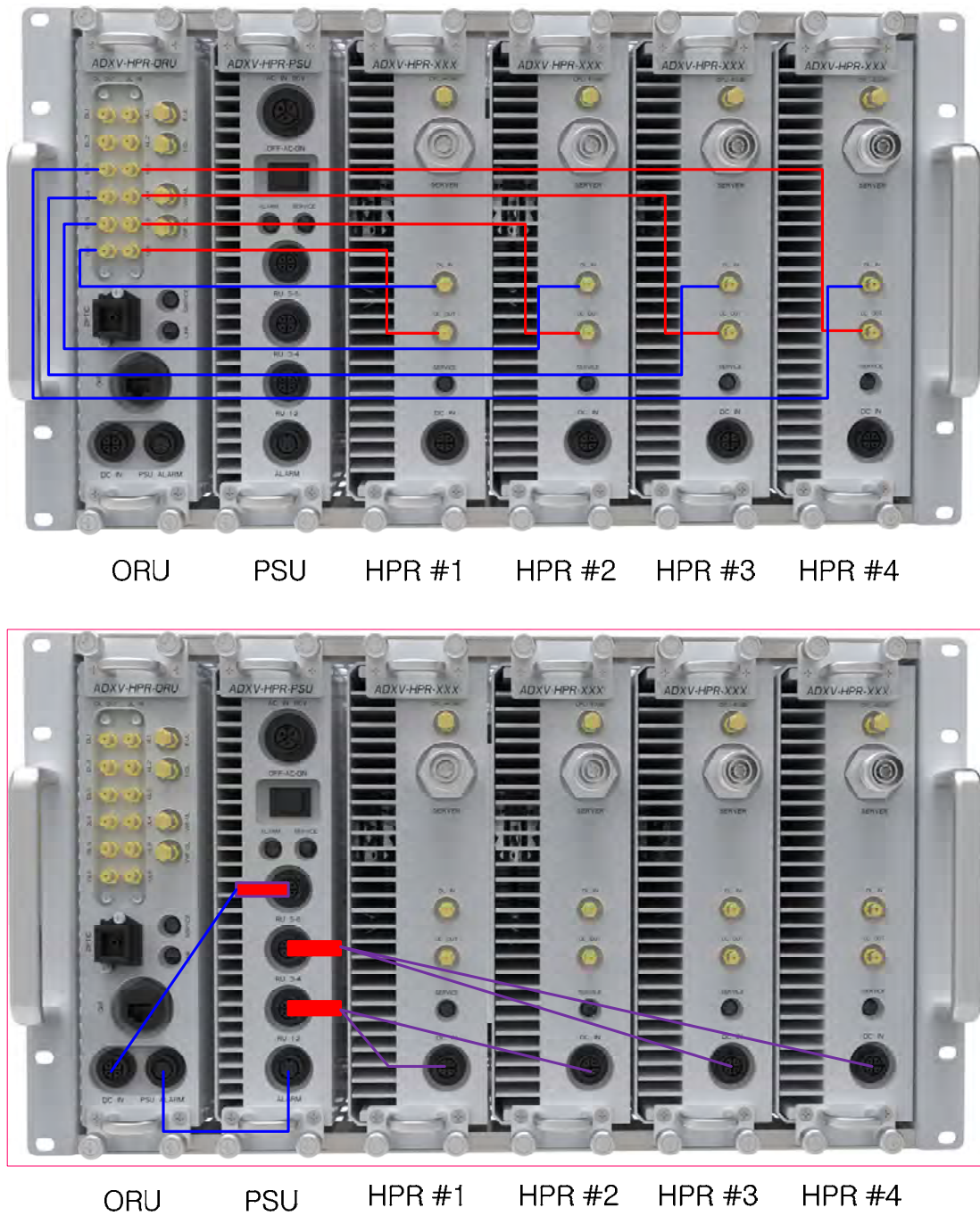
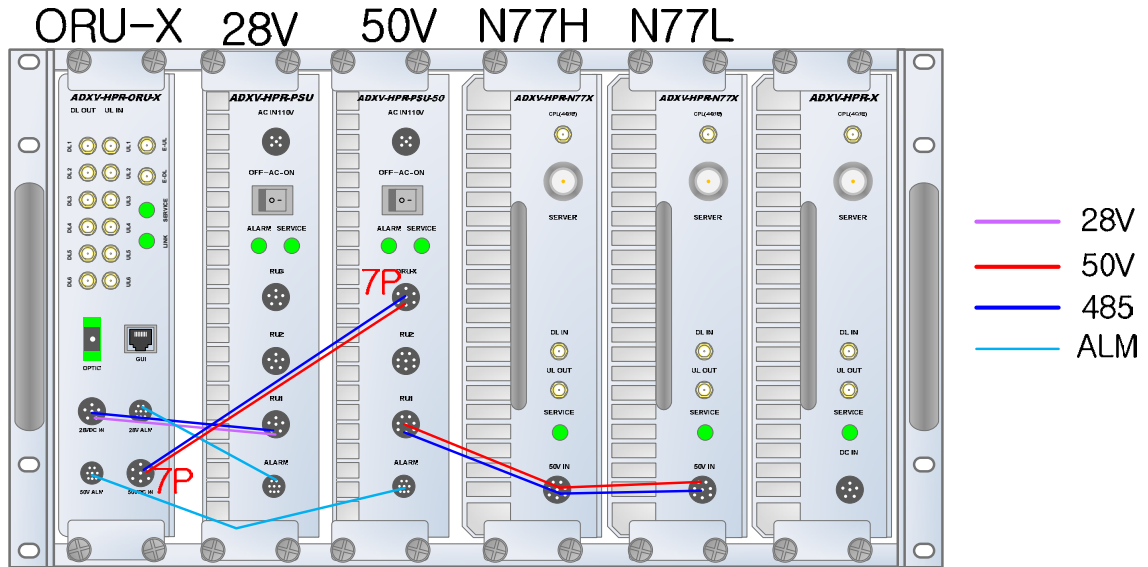
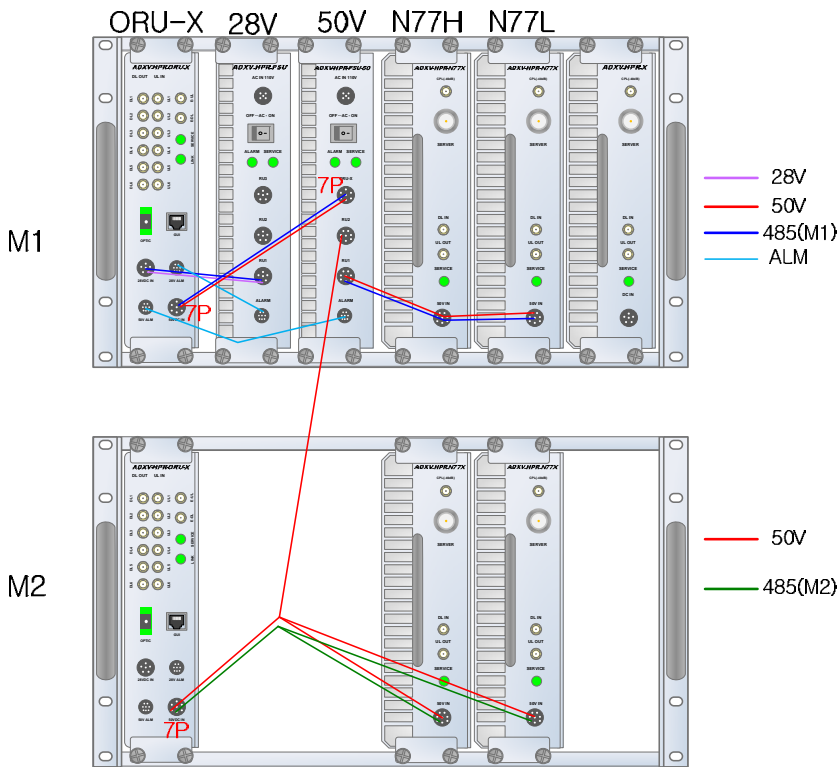

Figure 4-2 ADXV-HPR 4ands connection

4.3 Remote Unit Connection Diagrams (HPR C-band Configuration w/28V & 50V PSU)



4.4 Remote Unit Connection Diagrams (HPR C-band MIMO Configuration w/28V & 50V PSU)



5. MOUNTING METHOD

5.1 Head End

5.1.1 Rack Mount

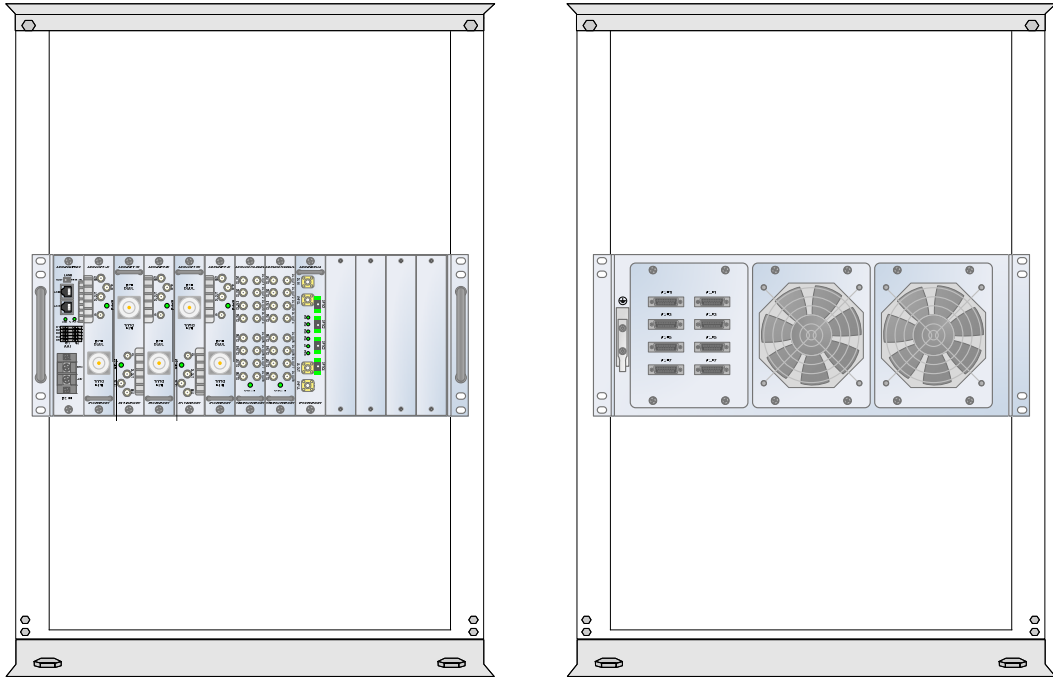

Figure 5-1 HE Rack Mount (Front & Rear view)

5.2 ADXV-HPR

5.2.1 Rack Mount



Figure 5-2 ADXV-HPR Rack Mount Front and Rear View

6. INSTALLATION

6.1 Pre-Installation Inspection

Please follow these procedures before installing ADXV equipment:

- Verify the number of packages received against the packing list.
- Check all packages for external damage; report any external damage to the shipping carrier. If there is damage, a shipping agent should be present before you unpack and inspect the contents because damage caused during transit is the responsibility of the shipping agent.
- Open and check each package against the packing list. If any items are missing, contact ADRF customer service.
- If damage is discovered at the time of installation, contact the shipping agent.
- Verify the AC voltage with DVM (Volt meter) is 110V AC. Incorrect AC voltage can damage the ADXV equipment.
- This power of this system shall be supplied through wiring installed in a normal building. If powered directly from the mains distribution system, it shall be used additional protection, such as overvoltage protection device.
- Over voltage category(OVC) & Pollution degree(PD)

Over voltage category (OVC)	OVC II
-----------------------------	--------

Pollution degree (PD)	PD2
-----------------------	-----

6.2 ADXV Installation Procedure

6.2.1 HE Installation Procedure



CAUTION: ADXV- HE should be installed inside building only.

6.2.1.1 Installing a ADXV- HE in a rack

The ADXV HE chassis mounts in a standard 19" (483mm) equipment rack. Allow clearance of 3" (76mm) at the front and rear, and 2" (51mm) on both sides for air circulation. No top or bottom clearance is required.

- Consideration:
 - Eight mounting holes (two holes at each corner of ADXV-HE rack) are to attach it to the 19" rack. The ADXV HE must be securely attached to a rack that can support the weight of the ADX.
- Mount procedure
 - The following steps should be followed while mounting the ADXV HE
 - Verify that the HE and Mounting holes are in good condition
 - Set the ADXV HE against the 19" rack and secure the unit with screws
 - Verify that ADXV HE is securely attached
 - Connect the GND cable
 - Connect the RF cable
 - Connect the Power
 - Connect the Optic cable

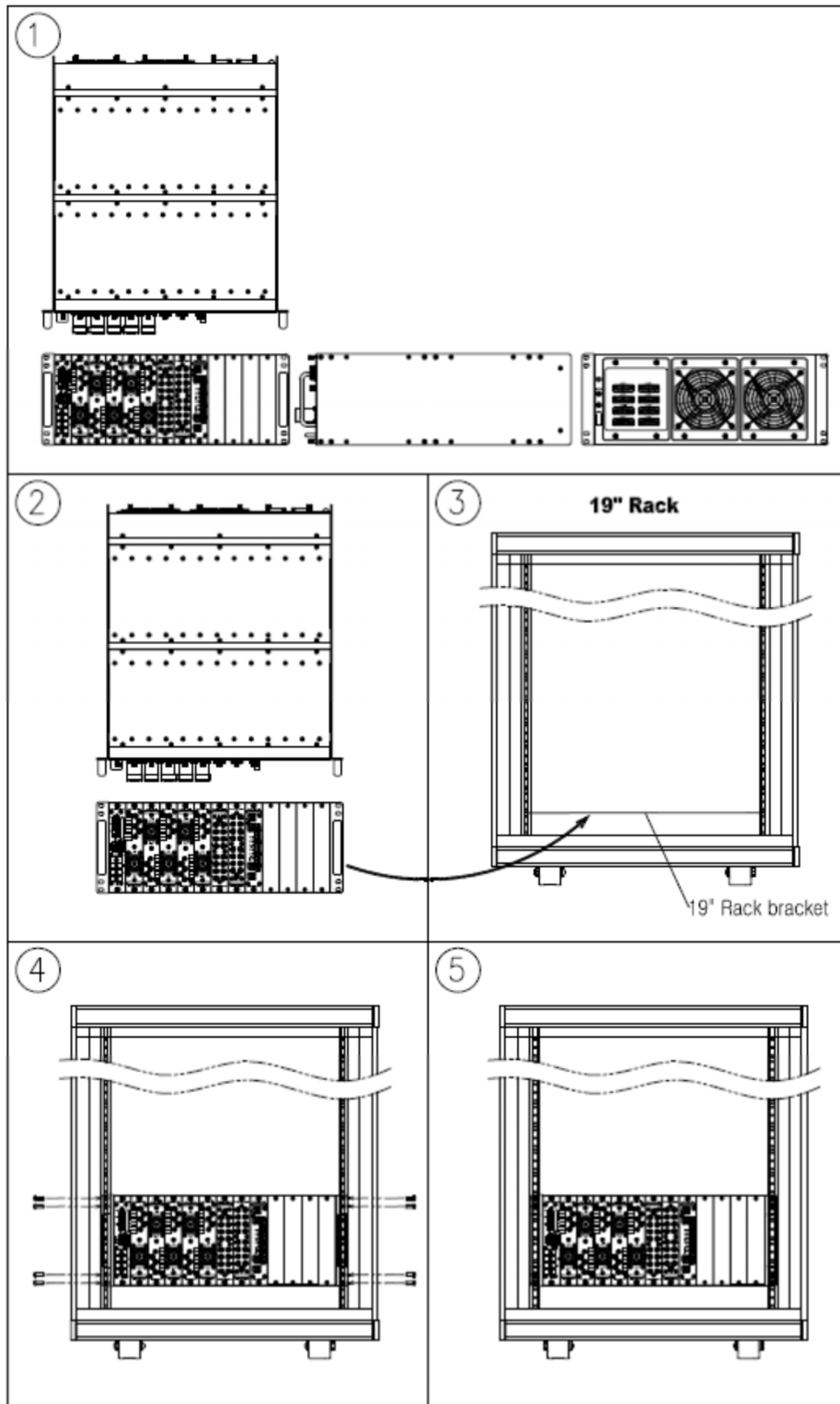

Figure 6-1 HE Installation Procedure

6.2.2 ADXV-HPR Installation Procedure

The ADXV-HPR chassis mounts in a standard 19" (483mm) equipment rack. Allow clearance of 3" (76mm) at the front and rear, and 2" (51mm) on both sides for air circulation. No top or bottom clearance is required.

- Consideration:
 - Eight mounting holes (two holes at each corner of ADXV-HPR rack) are to attach it to the 19" rack. The ADXV-HPR must be securely attached to a rack that can support the weight of the ADXV.
- Procedure
 - The following steps should be followed while mounting the ADXV-HPR
 - Verify that the ADXV-HPR and Mounting holes are in good condition
 - Set the ADXV-HPR against the 19" rack and secure the unit with screws
 - Verify that ADXV-HPR is securely attached
 - Connect the GND cable
 - Connect the RF coaxial cable
 - Connect the Power
 - Connect the Optic cable

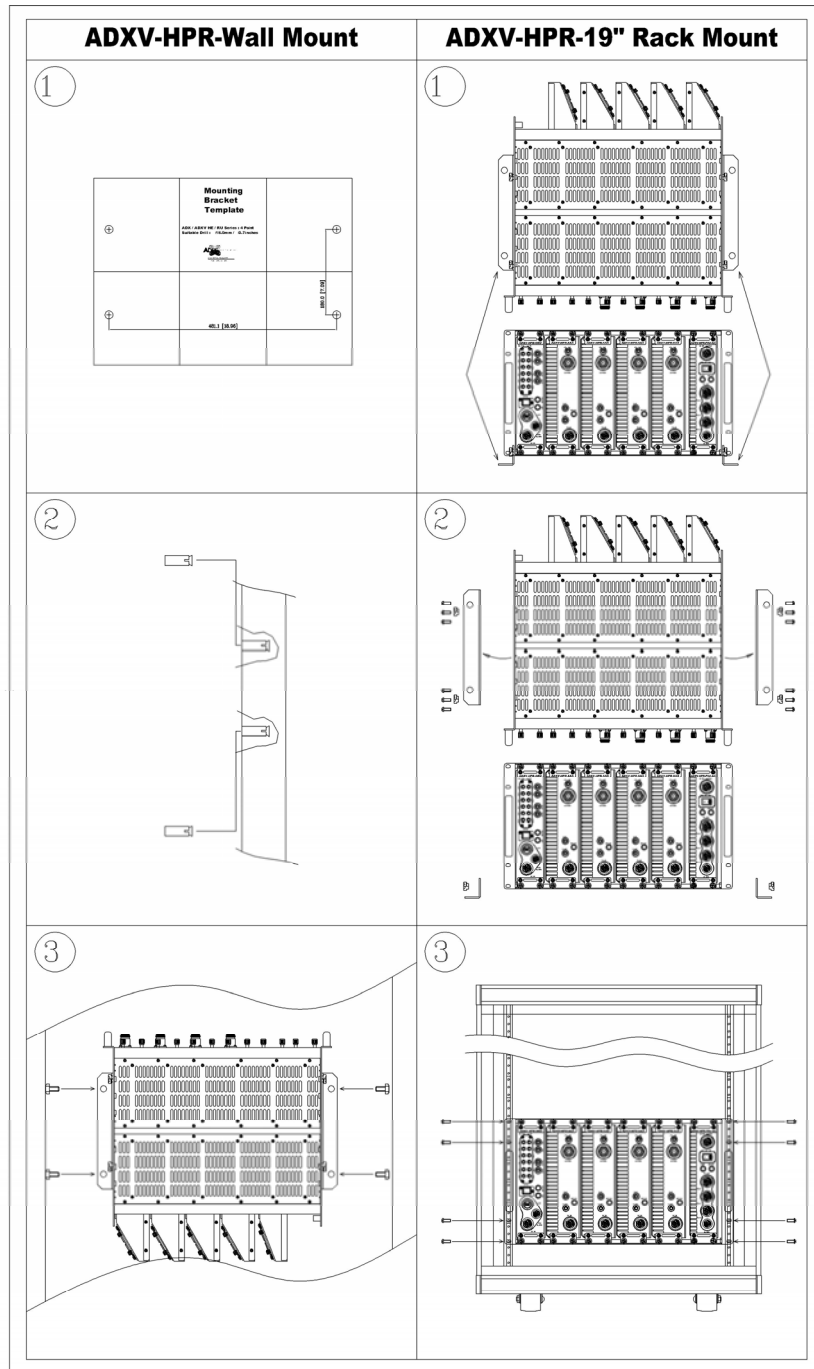

Figure 6-2 ADXV-HPR Installation Procedure

6.2.3 RF coaxial cable and antenna connection

- > The coaxial cables which are connected to antenna port of ADXV-HPR. Before connection, check the VSWR value of coaxial cable whether it is within specification using Site master.
- > At this time, check if the Return loss have above 15dB or VSWR have below 1.5
- > The part of antenna connection fasten to port not to be loosed and not to be injected the dusty and insects
- > The antenna connected to ADXV-HPR is only serviced in in-building

6.3 Grounding

A ground cable is included in the box. The grounding terminals are located at the rear of the ADXV HE and ADXV-HPR. The grounding cable should be properly connected before powering on the equipment.

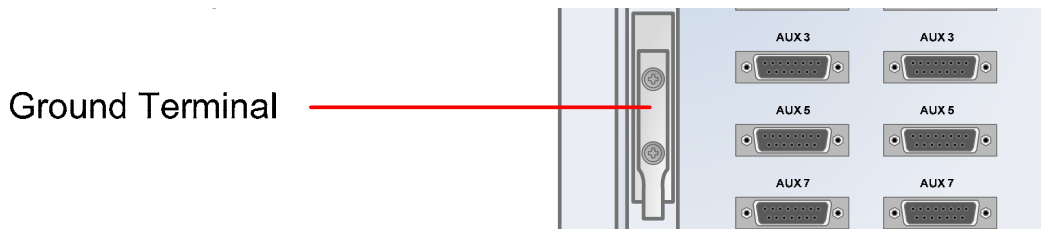

Figure 6-3 HE Ground Cable Connection, Protective Earthing Conductor (HE chassis rear side)

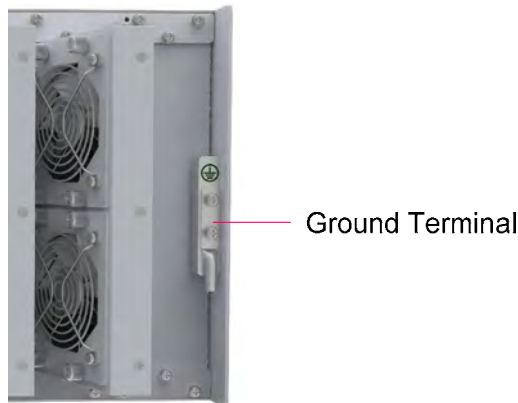

Figure 6-4 ADXV-HPR Ground Cable Connection, Protective Earthing Conductor (ADXV-HPR chassis rear side)

Round terminals located on the side of a 1.25mm²(16AWG) or more wires Using permanently connected to earth(Protective earthing conductor).

6.4 Optic Port Cleaning

- We recommend cleaning optic connector using a dry optical cleaning swab or tissue in a dry environment as needed. We recommend cleaning the optic connectors only if the expected optic loss is higher than the loss reported in the Web-GUI by 1.5dB_o. (Figure 6-5)
- When optic connector are not in use, the port should be covered with a protective dust cap. (Figure 6-6)

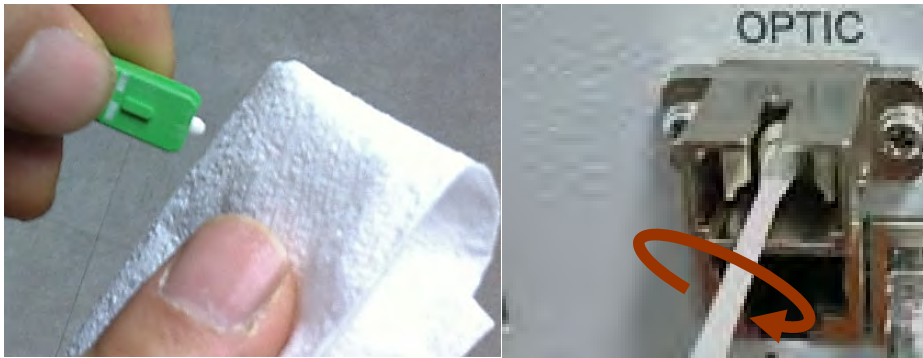

Figure 6-5 Optic Connector Cleaning (left) and Optic Port Cleaning (right)

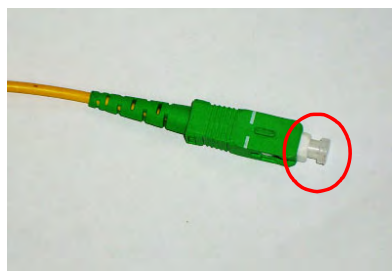

Figure 6-6 SC/APC Optic Connector Dust Cap

7. WEB-GUI

7.1 Web-GUI Setup

The Web-GUI allows the user to communicate with the DAS system either locally or remotely. To connect to the DAS system locally, you will need a laptop with an Ethernet port and a RJ-45 crossover cable. To connect to the DAS system remotely, you will need to have an active internet connection and the ADXV system must have an external modem box connected to the ADXV.

7.1.1 DAS system/PC Connection Using Web-GUI

- Verify that your Local Area Connection is set to **Obtain an IP address automatically** under the Internet Protocol (TCP/IP) properties
 - If you are connecting to the unit remotely (use of a modem), then skip this and next step.
- Connect the RJ-45 crossover cable between the laptop's Ethernet port and the repeater's Ethernet port
- Launch an Internet Browser
- Type the following IP address into the address bar of Microsoft Internet Explorer: <http://192.168.63.1>
 - If you are connecting to the unit remotely, then type the IP address of the modem to connect to the unit
- The following login screen will appear:



Figure 7-1 Login screen

If you are not the Administrator, please type in your assigned username & password which you should have received from the Administrator.

Table 7-1 Account Information for Login

Account type	Show items	Control Items	Default ID	Default Password
Administrator	all items	all items	admin	admin
User	restricted items	restricted items	adrf	adrf
Guest	restricted items	read-only	guest	guest







7.2 Administrator/User Mode

7.2.1 Common

7.2.1.1 Navigation Tree

The navigation tree located on the left hand side of the Web-GUI allows the user to switch between the various modules that are connected to the system.

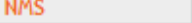

Table 7-2 Navigation tree

Parameters	Description
	Expands the entire navigation tree
	Collapses the entire navigation tree
	The module has the expandable subordinate modules
	The branch is currently expanded
	The module has soft fail alarm
	The module has hard fail alarm
	The module has no alarms (normal)
	The selected module will have orange colored text

7.2.1.2 Power Status

Display the power source that is currently being used.



Table 7-3 Power Supply Status

Input Power Status	Display Image
AC	
Battery	

7.2.1.3 Commissioning Status

Display whether or not the module has successfully been commissioned.

Table 7-4 Commissioning ICON

Status	Display Image
Commissioned	
Not-Commissioned	

7.2.1.4 Information

ADRF Remote Operation & Management System

Information

Serial Number	SN_NMS
Latitude	N777.777777
Longitude	E777.777777
Firmware	13000F01002X
Web GUI	X0.0.35

Location
ADRF
3116 Vanowen St.
Burbank, CA 91505

Description
nms_desc.

Technical Support
Phone: 1-800-313-9345
E-mail: techsupport@adrftech.com

Installer Contact Info
Company: ADRF
Installer: Installer
Phone: 800-313-9345
E-mail: techsupport@adrftech.com

Figure 7-2 ADXV General Information

- **Information:** Displays the serial number, latitude/longitude, firmware version of selected module, and Web GUI version of the NMS.
- **Location:** Displays the address where the ADXV is installed.
- **Description:** Displays the description of selected module. The description of each module can be edited from the Install tab. It is recommended to use the location of the module as the description. This description information can be seen when hovering over the device tree in order to easily identify each component.
- **Technical Support:** Displays ADRF's Technical Support contact information.
- **Installer Contact Info:** Displays the contact information of the installer.

7.2.2 Status Tab

7.2.2.1 Status – NMS

The NMS Status page provides an overall view of how the system is performing. From the NMS Status page, the user can see what modules are connected to ADXV-HPR. In addition, the user can see if any alarms are present in the system and also the commissioning status of each module.

7.2.2.1.1 System Summary

The Summary section provides the user with the number of components physically connected, the number of soft/hard/link fails present in the system, and also the number of commissioned and non-commissioned components.

Table 7-5 System Summary Description

Parameters	Description
Connected	Display the number of modules physically connected to ADXV-HPR
Soft Fail	Display the number of soft fail present on each module
Hard Fail	Display the number of hard fail present on each module
Link Fail	Display the number of link fail present on each module
Not Commissioned	Display the number of non-commissioned or commission failed module
Commissioned	Display the number of successfully commissioned module

7.2.2.1.2 HE Alarm Status

Display the alarm status of each HE component.

7.2.2.1.3 HE Commissioning Status

Display commissioning status of each HE component.

7.2.2.1.4 Alarm

Displays alarm status of the NMS. If an alarm is present in the system, the color of the system alarm tab will change according to the type of failure.

7.2.2.1.5 SNMP



The image shows a web form titled "SNMP" with two input fields: "Site ID" containing the text "adrf" and "Manager IP" containing the text "0.0.0.0". Below the fields is a "Set" button.

Figure 7-3 SNMP (Install – NMS)

The SNMP section allows you to specify the Site ID and Manager IP. The Site-ID is the code that is used to identify a particular module. The Manager IP field is where the user inputs the IP address of the NOC system that is being used to monitor the SNMP traps.

7.2.2.1.6 Location

This section allows the user to input the latitude and the longitude of the repeater.

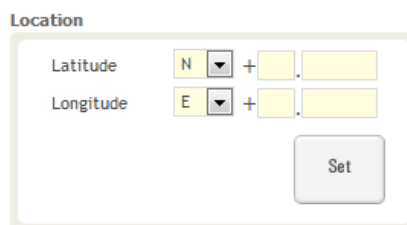

Figure 7-4 Location Setting (Install – NMS)

- Select N or S from the dropdown menu for Latitude
- Select E or W from the dropdown menu for Longitude
- Input the first 3 numbers of the latitude/longitude in the text area after the “+” and before the “.”
- Input the last 6 numbers of the latitude/longitude in the text area after the “.”

7.2.2.1.7 External Modem Box Settings

This section allows the user to specify an alternative IP, Subnet Mask, and Gateway settings. These settings are enabled when the Host/Remote switch is set to the Remote position.

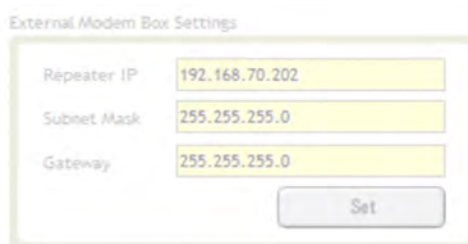

Figure 7-5 External Modem Box Setting (Install – NMS)

7.2.2.1.8 Description

This section allows the user to save the description of NMS.



Figure 7-6 Description (Install – NMS)

7.2.2.1.9 SNMP Agent False Alarm Test

This section allows the user to generate both soft and hard fail alarms. After alarms are generated, the NOC can poll the ADXV to see if alarms are present. All alarms generated during this test are false alarms.

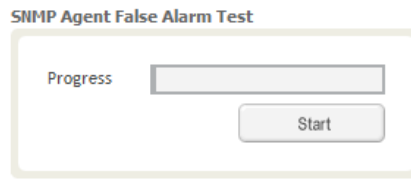

Figure 7-7 SNMP Agent False Alarm Test (Install – NMS)

7.2.2.1.10 Location Info / Installer Info

This section allows the user to specify the address of the repeater and also the information of the installer.

ADRF Remote Operation & Management System

Location Info

Company

Address1

Address2

City

State ▼

ZIP Code

Installer Info

Company

Name

Phone

E-mail

Figure 7-8 Location Info / Installer Info (Install – NMS)

7.2.2.1.11 Date & Time

This section allows the user to specify the current date and time.

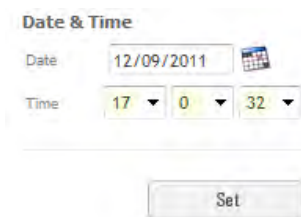

The form is titled "Date & Time". It contains a "Date" field with a text input showing "12/09/2011" and a calendar icon. Below it is a "Time" field with three dropdown menus showing "17", "0", and "32". A "Set" button is located at the bottom of the form.

Figure 7-9 Date & Time Setting (Install – NMS)

7.2.2.1.12 Description

This section allows the user to save the description of remote module.

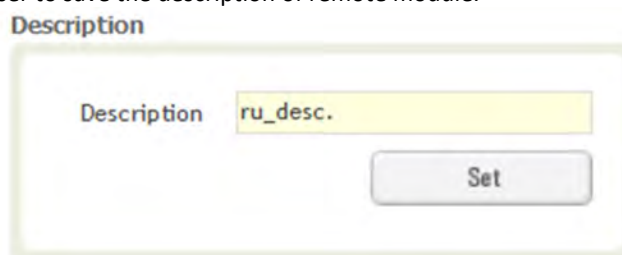

The form is titled "Description". It features a text input field containing "ru_desc." and a "Set" button.

Figure 7-10 Description (Install-Remote Module)

7.2.3 System

The System tab allows the user to perform firmware updates, upload closeout packages, view any changes to the system, backup existing configuration, and add/remove user accounts, and change the login credentials of the Administrator.

7.2.3.1 System: Account

7.2.3.1.1 System: Account - Account Management (Admin Only)

The Account Management section allows the Administrator to delete any user/guest account. Please note that the Account Management section is only available if you are logged into the system as the Administrator. To delete a user/guest account click on the Account Management link and under the Delete column, click on the delete button.

Account Management / New account / Change Password

No	Login Name	Password	Status	Last Login	Edit
1	admin	admin	administrator	2012-02-28 18:37:53	-
2	adrf	adrf	user	2012-02-28 00:47:55	<input type="button" value="delete"/>
3	guest	guest	guest	1970-01-01 00:00:00	<input type="button" value="delete"/>

Figure 7-11 Account Management

7.2.3.1.2 System: Account - New Account (Admin Only)

The New account section allows the Administrator to create a new user/guest account. Please note that the new account section is only available if you are logged into the system as the Administrator. To create a new user/guest account click on the new account link and fill in the fields highlighted in yellow as shown below.

Account | Logs | Update | System Information | Backup/Restore | SNMP | Closeout Package

Account Management / New account / Change Password

Account Name	<input type="text"/>
Account Group	<input type="text" value="user"/>
Password	<input type="text"/>
Confirm password	<input type="text"/>

Figure 7-12 New Account

7.2.3.1.3 System: Account - Change Password

The Change Password section allows the current user who is logged into the system to change their login credentials.

Figure 7-13 Change Password

7.2.3.2 System: Logs

7.2.3.2.1 System: Logs - Event Log

This section displays system events that have taken place. The Event Log displays who has made the changes, the time and date of when the event took place, and what changes were made to the system. The System Log tracks the following events:

- System Initiation
- Alarm Set
- Alarm Clear

7.2.3.2.2 System: Logs - User Log

This section tracks user activity within the system. The User Log displays who has made the changes, the time and date of when the event took place, and what changes were made to the system. The User Log tracks the following items:

- Log in / Log out activity
- Changes to gain/attenuation/output values
- System event generated by user(firmware update, backup/resote, create/delete account)
- DAS Navigation Tree Lock/Unlock
- Description change
- Repeater/installer information change
- Setting date/time

Seq.	Date / Time	Source	Description	Event
1	2017.05.09 11:21:47	[11]H-ODU/[1]R-ORU/[2]R-37W	k	DL Output Low Alarm Set - Trap S
2	2017.05.09 11:21:11	[11]H-ODU/[1]R-ORU/[1]R-37P	fdsafasdf	DL Output Low Alarm Set - Trap S
3	2017.05.09 11:20:34	[8]H-POIL-78P	78p	UL VSWR Alarm Set - Trap Sen
4	2017.05.09 11:19:58	[8]H-POIL-78P	78p	DL Signal Not Detect Alarm Set - Tra
5	2017.05.09 11:19:21	[8]H-POIL-78P	78p	DL Signal Low Alarm Set - Trap S
6	2017.05.09 11:18:32	H-NMS-DC	test	Boot up - Trap Send Out;

Figure 7-14 User Log

7.2.3.3 System: Update

- To perform a firmware update, click on the System:Update tab and the following screen will show up.

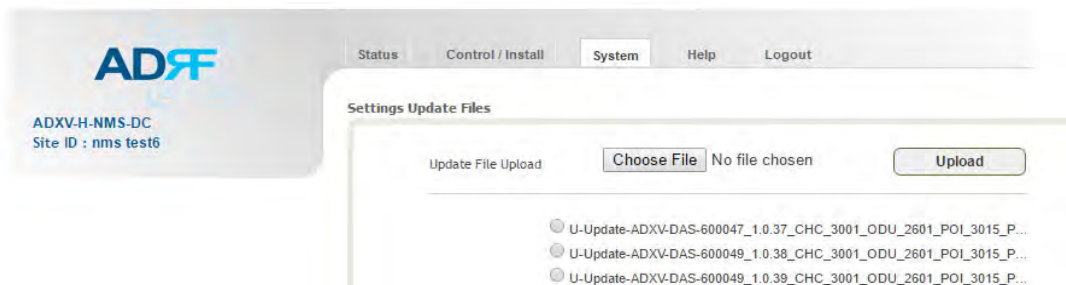

Figure 7-15 System update

- Click on the 'Browse' button and locate the firmware file.
- Click on the Update button to perform the firmware update.
- Once the firmware update is complete, the following message will appear.



Figure 7-16 Message after System update is complete

7.2.4 Help

If an internet connection is available, clicking on the Help Tab will redirect the user to our Technical Support page.

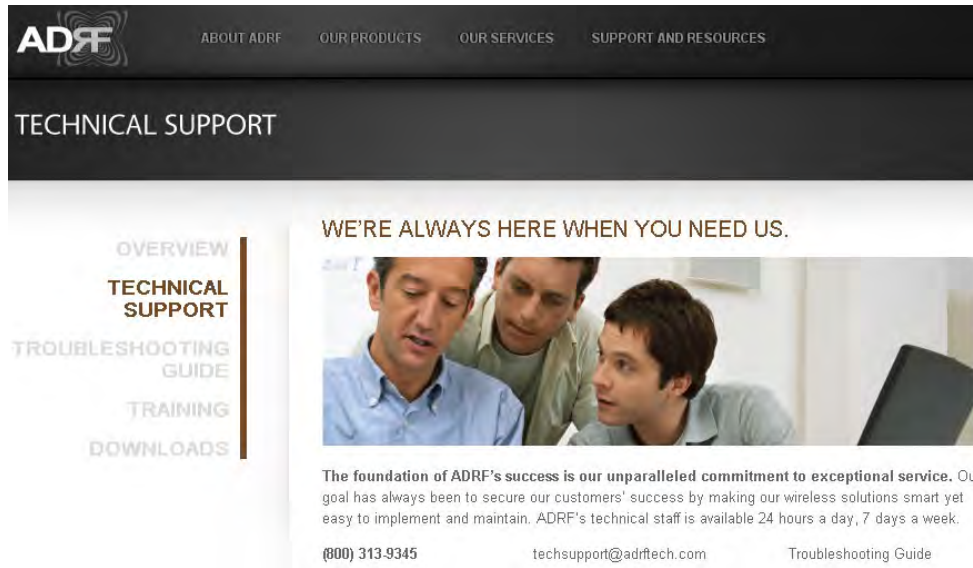

Figure 7-17 Help

7.2.5 Logout

Clicking the Logout button will log the current user off the system.

7.3 Guest Mode

When logging into the system as a guest, the guest will only have read-only privileges and will not be able to make any changes to the system.

8. ADXV SYSTEM-WIDE SPECIFICATION

700LTE/S8C/PCS/AWS

Parameters		700MHz	SMR800+CELL	PCS	AWS
Frequency (Bandwidth)	Downlink	Lower ABC+ Upper C 728-757MHz	862-894MHz (32MHz)	1930-1995MHz (65MHz)	2110-2180MHz (70MHz)
	Uplink	Lower ABC+ Upper C 698-716, 776~787MHz	817-849MHz (32MHz)	1850-1915MHz (65MHz)	1710-1780MHz (70MHz)
Input Power Range @ POI	Power Mode	+48~ 0dBm			
System Gain/ Nominal pass band gain	Downlink	-11~33dB/43dB (2Watt)			
		-11~37dB/37dB (5Watt)			
		-11~43dB/43dB (20Watt)			
		-11~46dB/45dB (30Watt)			
	Uplink	-11~46dB/46dB (40Watt)			
Rated mean output power (DL)		43dBm(20W)	43dBm(20W)	46dBm(40W)	46dBm(40Watt)
Maximum Composite Output Power(UL)		-15dBm			
Noise Figure		≤ 5dB @maximum gain, Center Frequency			
VSWR		≤ 1.3:1 @ BTS interface port ≤ 1.5:1 @ Internal interface port			
Optical Loss		0~5dBo			
System Delay		< 2us			
Spurious		Meet FCC, 3GPP TS 36.104, 3GPP2 C.S0010-C			
Dimension (WXDXH)	Head End Chassis	19in x 19.7 in x 7.0 inches			
	POI/POIL	1.3in x 17.0 in x 6.85 inches			
	ADXV-HPR Chassis	19in x 15.0 in x 10.5 inches			
	ADXV- HPR(Remote Unit)	2.75in x 17.8 in x 10.3 inches			
Weight	Head End Chassis	20.9 lbs			
	POI	6.17 lbs			
	POIL	5.00 lbs			
	ADXV- HPR(Remote Unit) Chassis	17.60 lbs			
	ADXV- HPR(Remote	13.22 lbs			

	Unit)	
Operating Temperature		-22 - 140 F(-30~60°C)
Operating Humidity		5~90%RH
Power Supply	Head-End	-48V DC 110/220V, 50-60Hz(optional) with battery backup function
	ADXV-HPR	110/220V, 50-60Hz -48V DC(optional)
Power consumption	ADXV-H-NMS-AC	8.85 Watt
	ADXV-H-ODU-4	7.47 Watt
	ADXV-H-POI	7.20 Watt
	ADXV-H-POIL	6.45 Watt
	ADXV-HPR-PSU-AC	5.4 Watt
	ADXV-HPR-ORU	109 Watt
	ADXV-HPR-437F	129 Watt
	ADXV-HPR-43S8C	145 Watt
	ADXV-HPR-46P	264 Watt
ADXV-HPR-46A	259 Watt	
Network Management System		Ethernet(RJ45)
RF connector	POI	DIN(Female)
	POIL	4.3-10(Female)
	ADXV-HPR(Remote Unit)	4.3-10(Female)

WCS/BT

Parameters		WCS	BRS TD-LTE
Frequency (Bandwidth)	Downlink	2350~2360MHz	2496~2690MHz(FCC) 2500~2690MHz(IC)
	Uplink	2305~2315MHz	
Input Power Range @ POI	Power Mode	+48~ 0dBm	
System Gain/ Nominal pass band gain	Downlink	-11~33dB/43dB (2Watt)	
		-11~37dB/37dB (5Watt)	
		-11~43dB/43dB (20Watt)	
		-11~46dB/45dB (30Watt)	
	Uplink	0~30dB	
Rated mean output power (DL)		45dBm(30Watt)	46dBm(40W)

Maximum Composite Output Power(UL)		-15dBm
Noise Figure		≤ 5dB @maximum gain, Center Frequency
VSWR		≤ 1.3:1 @ BTS interface port ≤ 1.5:1 @ Internal interface port
Optical Loss		0~5dBo
System Delay		< 2us
Spurious		Meet FCC, 3GPP TS 36.104, 3GPP2 C.S0010-C
Dimension (WXDXH)	Head End Chassis	19in x 19.7 in x 7.0 inches
	POI/POIL	1.3in x 17.0 in x 6.85 inches
	ADXV-HPR Chassis	19in x 15.0 in x 10.5 inches
	ADXV-HPR(Remote Unit)	2.75in x 17.8 in x 10.3 inches
Weight	Head End Chassis	20.9 lbs
	POI	6.17 lbs
	POIL	5.00 lbs
	ADXV-HPR(Remote Unit) Chassis	17.60 lbs
	ADXV-HPR(Remote Unit)	13.22 lbs
Operating Temperature		-22 - 140 F(-30~60°C)
Operating Humidity		5~90%RH
Power Supply	Head-End	-48V DC 110/220V, 50-60Hz(optional) with battery backup function
	ADXV-HPR	110/220V, 50-60Hz -48V DC(optional)
Power consumption	ADXV-H-NMS-AC	8.85 Watt
	ADXV-H-ODU-4	7.47 Watt
	ADXV-H-POI	7.20 Watt
	ADXV-H-POIL	6.45 Watt
	ADXV-HPR-PSU-AC	5.4 Watt
	ADXV-HPR-ORU	109 Watt
	ADXV-HPR-45W	255 Watt
	ADXV-HPR-46BT	264 Watt

Network Management System		Ethernet(RJ45)
RF connector	POI	DIN(Female)
	POIL	4.3-10(Female)
	ADXV-HPR(Remote Unit)	4.3-10(Female)

600,700FN

Parameters		600	700FN
Frequency (Bandwidth)	Downlink	617~652MHz	728~768MH
	Uplink	663~698MHz	698~716MHz 776~798MHz
Input Power Range @ POI	Power Mode	+48~ 0dBm	
System Gain/ Nominal pass band gain	Downlink	-11~43dB/43dB (20Watt)	
	Uplink	-20~10dB	
Rated mean output power (DL)		43dBm(20Watt)	43dBm(20Watt)
Maximum Composite Output Power(UL)		-35dBm	
Noise Figure		≤ 5dB @maximum gain, Center Frequency	
VSWR		≤ 1.5:1	
Optical Loss		0~5dBo	
System Delay		< 2us	
Spurious		Meet FCC, 3GPP TS 36.104, 3GPP2 C.S0010-C	
Dimension (WXDXH)	Head End Chassis	19in x 19.7 in x 7.0 inches	
	POI/POIL	1.3in x 17.0 in x 6.85 inches	
	ADXV-HPR Chassis	19in x 15.0 in x 10.5 inches	
	ADXV-HPR(Remote Unit)	2.75in x 17.8 in x 10.3 inches	
Weight	Head End Chassis	20.9 lbs	
	POI	6.17 lbs	
	POIL	5.00 lbs	
	ADXV-	17.60 lbs	

	HPR(Remote Unit) Chassis	
	ADXV-HPR(Remote Unit)	13.22 lbs
Operating Temperature		-22 - 140 F(-30~60°C)
Operating Humidity		5~90%RH
Power Supply	Head-End	-48V DC 110/220V, 50-60Hz(optional) with battery backup function
	ADXV-HPR	110/220V, 50-60Hz -48V DC(optional)
Power consumption	ADXV-H-NMS-AC	8.85 Watt
	ADXV-H-ODU-4	7.47 Watt
	ADXV-H-POI	7.20 Watt
	ADXV-H-POIL	6.45 Watt
	ADXV-HPR-PSU-AC	5.4 Watt
	ADXV-HPR-ORU	109 Watt
	ADXV-HPR-436	130Watt
Network Management System		Ethernet(RJ45)
RF connector	POI	DIN(Female)
	POIL	4.3-10(Female)
	ADXV-HPR(Remote Unit)	4.3-10(Female)

- N77H

Parameters		1. N77H (3.7 GHz)
Frequency (Bandwidth)	Downlink	2. 3700~3980MHz
	Uplink	
Input Power Range @ POI	Power Mode	3. +48~ 0dBm
System Gain/ Nominal pass band gain	Downlink	4. -11~33dB/43dB (2Watt)
		5. -11~37dB/37dB (5Watt)
		6. -11~43dB/43dB (20Watt)
		7. -11~46dB/45dB (30Watt)
	8. -11~46dB/46dB (40Watt)	
	Uplink	9. 0~30dB
Rated mean output power (DL)		10. 46dBm(40Watt)

Maximum Composite Output Power(UL)		-15dBm
Noise Figure		≤ 5dB @maximum gain, Center Frequency
VSWR		≤ 1.3:1 @ BTS interface port ≤ 1.5:1 @ Internal interface port
Optical Loss		0~5dBo
System Delay		< 2us
Spurious		Meet FCC, 3GPP TS 36.104, 3GPP2 C.S0010-C
Dimension (WXDXH)	Head End Chassis	19in x 19.7 in x 7.0 inches
	POI/POIL	1.3in x 17.0 in x 6.85 inches
	ADXV-HPR Chassis	19in x 15.0 in x 10.5 inches
	ADXV-HPR(Remote Unit)	2.75in x 17.8 in x 10.3 inches
Weight	Head End Chassis	20.9 lbs
	POI	6.17 lbs
	POIL	5.00 lbs
	ADXV-HPR(Remote Unit) Chassis	17.60 lbs
	ADXV-HPR(Remote Unit)	13.22 lbs
Operating Temperature		-22 - 140 F(-30~60°C)
Operating Humidity		5~90%RH
Power Supply	Head-End	--48V DC 110/220V, 50-60Hz(optional) with battery backup function
	ADXV-HPR	110/220V, 50-60Hz -48V DC(optional)
Power consumption	ADXV-H-NMS-AC	8.85 Watt
	ADXV-H-ODU-4	7.47 Watt
	ADXV-H-POI	7.20 Watt
	ADXV-H-POIL	6.45 Watt
	ADXV-HPR-PSU-AC	5.4 Watt
	ADXV-HPR-ORU	109 Watt
	ADXV-HPR-46N77L	255 Watt
	ADXV-HPR-46N77H	264 Watt

Network Management System		Ethernet(RJ45)
RF connector	POI	DIN(Female)
	POIL	4.3-10(Female)
	ADXV-HPR(Remote Unit)	4.3-10(Female)

"The Manufacturer's rated output power of this equipment is for single carrier operation. For situations when multiple carrier signals are present, the rating would have to be reduced by 3.5 dB, especially where the output signal is re-radiated and can cause interference to adjacent band users. This power reduction is to be by means of input power or gain reduction and not by an attenuator at the output of the device."

9. MECHANICAL DRAWING

9.1 HE

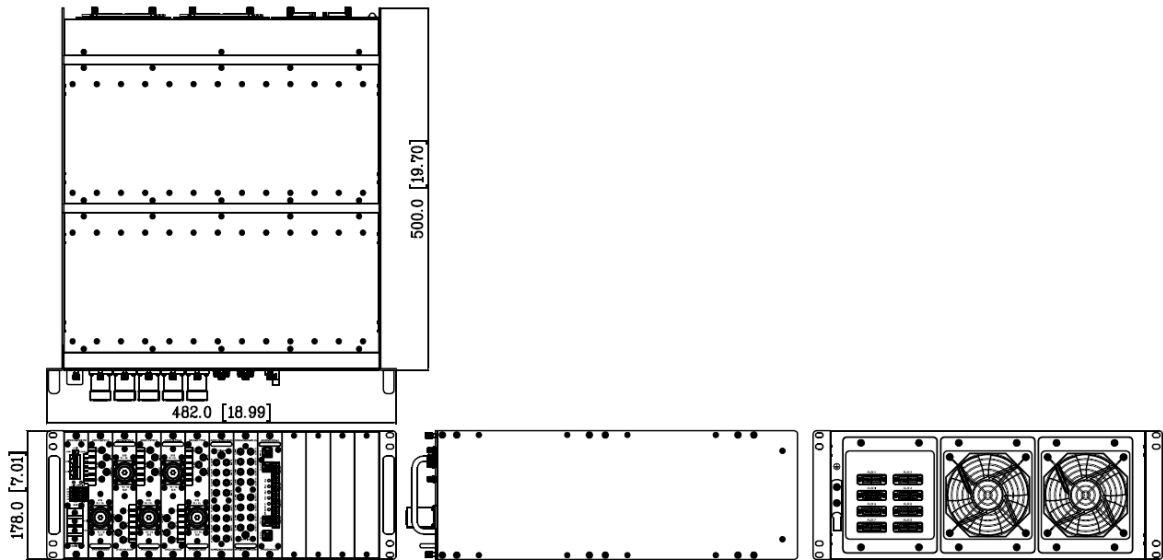

Figure 9-1 HE Drawing

9.2 ADXV-HPR

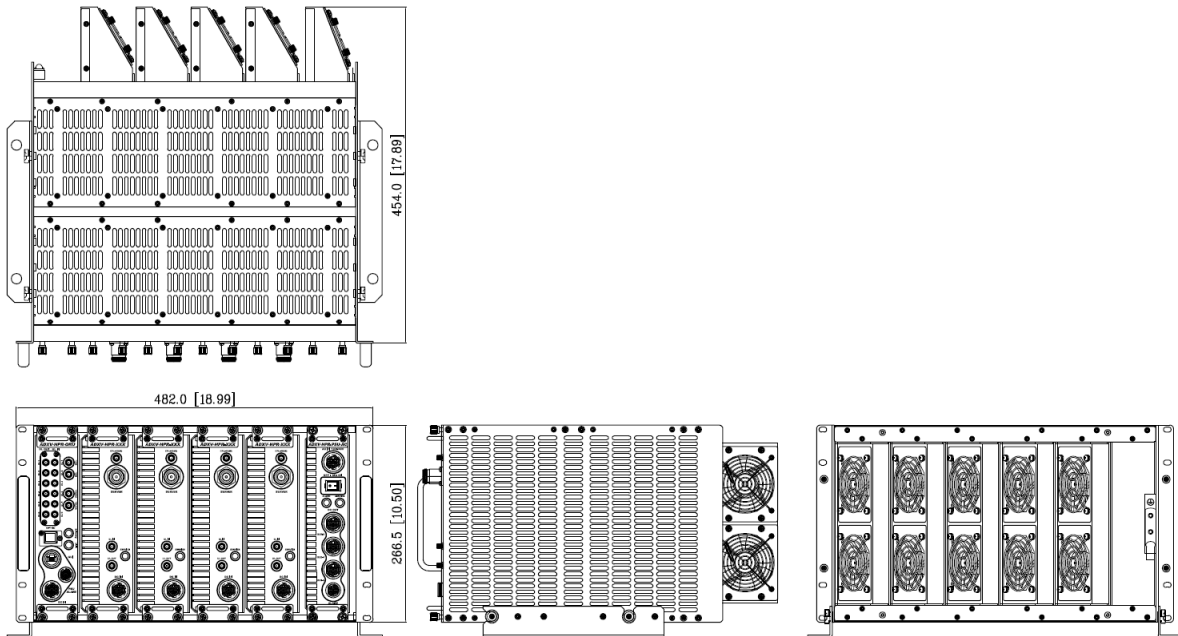

Figure 9-2 ADXV-HPR Drawing