

# TEST REPORT

FCC Test for ADXV-HPR-46N77H  
Certification

**APPLICANT**  
ADRF KOREA, Inc.

**REPORT NO.**  
HCT-RF-2209-FC002

**DATE OF ISSUE**  
September 7, 2022

**Tested by**  
Sang Su Lee

**Technical Manager**  
Jong Seok Lee

**HCT CO., LTD.**  
*Bongjai Huh*  
BongJai Huh / CEO

HCT Co., Ltd.

74, Seoicheon-ro 578beon-gil, Majang-myeon, Icheon-si, Gyeonggi-do, 17383 KOREA  
Tel. +82 31 634 6300 Fax. +82 31 645 6401

# TEST REPORT

FCC Test for  
ADXV-HPR-46N77H

REPORT NO.  
HCT-RF-2209-FC002

DATE OF ISSUE  
September 07, 2022

Additional Model  
-

**Applicant**      **ADRF KOREA, Inc.**  
5-5, Mojeon-Ri, Backsa-Myun, Icheon-Citi, Kyunggi-Do, Korea

**Eut Type**      DAS  
**Model Name**    ADXV-HPR-46N77H

**FCC ID**      N52-ADXV-HPR-N77H

**Output Power**      Downlink: 46 dBm

**Date of Test**      August 17, 2022 ~ September 06, 2022

**FCC Rule Parts:**      CFR 47 Part 2, Part 27

The result shown in this test report refer only to the sample(s) tested unless otherwise stated.  
This test results were applied only to the test methods required by the standard.

## REVISION HISTORY

The revision history for this test report is shown in table.

Revision No.	Date of Issue	Description
0	September 07, 2022	Initial Release

The measurements shown in this report were made in accordance with the procedures indicated, and the emissions from this equipment were found to be within the limits applicable. I assume full responsibility for the accuracy and completeness of these measurements, and for the qualifications of all persons taking them. It is further stated that upon the basis of the measurements made, the equipment tested is capable of operation in accordance with the requirements of the FCC Rules under normal use and maintenance.

If this report is required to confirmation of authenticity, please contact to [www.hct.co.kr](http://www.hct.co.kr)

## CONTENTS

1. GENERAL INFORMATION	5
1.1. APPLICANT INFORMATION	5
1.2. PRODUCT INFORMATION	5
1.3. TEST INFORMATION	5
2. FACILITIES AND ACCREDITATIONS	6
2.1. FACILITIES	6
2.2. EQUIPMENT	6
3. TEST SPECIFICATIONS	7
3.1. STANDARDS	7
3.2. ADDITIONAL DESCRIPTIONS ABOUT TEST	8
3.3. MEASUREMENT UNCERTAINTY	10
3.4. STANDARDS ENVIRONMENTAL TEST CONDITIONS	10
3.5. TEST DIAGRAMS	11
4. TEST EQUIPMENTS	13
5. TEST RESULT	14
5.1. AGC THRESHOLD	14
5.2. OUT-OF-BAND REJECTION	16
5.3. INPUT-VERSUS-OUTPUT SIGNAL COMPARISON	18
5.4. INPUT/OUTPUT POWER AND AMPLIFIER/BOOSTER GAIN	32
5.5. OUT-OF-BAND/OUT-OF-BLOCK EMISSIONS AND SPURIOUS EMISSIONS	44
5.6. RADIATED SPURIOUS EMISSIONS	71
5.7. FREQUENCY STABILITY	74
6. Annex A_EUT AND TEST SETUP PHOTO	79

## 1. GENERAL INFORMATION

### 1.1. APPLICANT INFORMATION

Company Name	ADRF KOREA, Inc.
Company Address	5-5, Mojeon-Ri, Backsa-Myun, Icheon-Citi, Kyunggi-Do, Korea

### 1.2. PRODUCT INFORMATION

EUT Type	DAS	
EUT Serial Number	ADXVHPR46N77H220000	
Power Supply	100~240 VAC, 50/60 Hz / $\pm 36$ V ~ $\pm 76$ VDC	
Frequency Range	Band Name	Downlink (MHz)
	C-Band	3 700 ~ 3 980
Tx Output Power	46 dBm	
Antenna Peak Gain	4.6 dBi	

### 1.3. TEST INFORMATION

FCC Rule Parts	CFR 47 Part 2, Part 27
Measurement Standards	KDB 935210 D05 v01r04, KDB 971168 D01 v03r01, ANSI C63.26-2015
Test Location	HCT CO., LTD. 74, Seoicheon-ro 578beon-gil, Majang-myeon, Icheon-si, Gyeonggi-do, 17383, Rep. of KOREA

## 2. FACILITIES AND ACCREDITATIONS

### 2.1. FACILITIES

The SAC(Semi-Anechoic Chamber) and conducted measurement facility used to collect the radiated data are located at the 74, Seoicheon-ro 578beon-gil, Majang-myeon, Icheon-si, Gyeonggi-do, 17383, Rep. of KOREA.

The site is constructed in conformance with the requirements of ANSI C63.4 (Version: 2014) and CISPR Publication 22.

Detailed description of test facility was submitted to the Commission and accepted dated April 02, 2018 (Registration Number: KR0032).

### 2.2. EQUIPMENT

Radiated emissions are measured with one or more of the following types of linearly polarized antennas: tuned dipole, bi-conical, log periodic, bi-log, and/or ridged waveguide, horn. Spectrum analyzers with pre-selectors and quasi-peak detectors are used to perform radiated measurements.

Calibrated wideband preamplifiers, coaxial cables, and coaxial attenuators are also used for making measurements.

All receiving equipment conforms to CISPR Publication 16-1, "Radio Interference Measuring Apparatus and Measurement Methods."

### 3. TEST SPECIFICATIONS

#### 3.1. STANDARDS

The following tests were conducted on a sample of the equipment for the purpose of demonstrating compliance with FCC Part 2, Part 27

Description	Reference	Results
AGC threshold	KDB 935210 D05 v01r04 3.2	Compliant
Out-of-band rejection	KDB 935210 D05 v01r04 3.3	Compliant
Input-versus-output signal comparison	§ 2.1049	Compliant
Input/output power and amplifier/booster gain	§ 2.1046, § 27.50(j)(2), § 27.50(j)(4)	Compliant
Out-of-band/out-of-block emissions and spurious emissions	§ 2.1051, § 27.53(l)(1)	Compliant
Spurious emissions radiated	§ 2.1053, § 27.53(l)(1)	Compliant
Frequency Stability	§ 2.1055 § 27.54	Compliant

### 3.2. ADDITIONAL DESCRIPTIONS ABOUT TEST

Except for the following cases, EUT was tested under normal operating conditions.

: Out-of-band rejection test requires maximum gain condition without AGC.

The test was generally based on the method of KDB 935210 D05 v01r04 and only followed ANSI C63.26-2015 if there was no test method in KDB standard.

EUT was tested with following modulated signals provide by applicant.

Band Name	Tested signals
C-Band	5G NR 20 MHz
	5G NR 40 MHz
	5G NR 60 MHz
	5G NR 80 MHz
	5G NR 100 MHz

The tests results included actual loss value for attenuator and cable combination as shown in the table below.

: Input Path

Correction factor table			
Frequency (MHz)	Factor (dB)	Frequency (MHz)	Factor (dB)
2 000	1.059	2 800	1.333
2 200	1.339	3 000	1.671
2 400	1.360	4 000	1.926
2 600	1.552		



: Output Path

Correction factor table

Frequency (MHz)	Factor (dB)	Frequency (MHz)	Factor (dB)
0.009	29.665	14 000	36.288
20	29.759	15 000	36.301
40	29.485	16 000	36.945
60	29.466	17 000	36.622
80	29.521	18 000	37.380
100	29.566	19 000	37.666
200	29.767	20 000	38.801
300	30.152	21 000	39.792
400	30.283	22 000	42.044
500	30.427	23 000	41.421
600	30.523	24 000	48.071
700	30.652	25 000	45.282
800	30.688	26 000	41.251
900	30.696	27 000	28.678
1 000	30.744	28 000	28.803
2 000	31.446	29 000	29.253
3 000	32.272	30 000	29.048
4 000	32.692	31 000	30.961
5 000	32.764	32 000	30.646
6 000	33.240	33 000	30.148
7 000	33.541	34 000	29.163
8 000	33.493	35 000	29.415
9 000	34.552	36 000	29.890
10 000	36.024	37 000	29.638
11 000	35.113	38 000	29.927
12 000	35.174	39 000	30.240
13 000	35.274	40 000	29.175

### 3.3. MEASUREMENT UNCERTAINTY

Description	Condition	Uncertainty
Radiated Disturbance	9 kHz ~ 30 MHz	± 4.40 dB
	30 MHz ~ 1 GHz	± 5.74 dB
	1 GHz ~ 18 GHz	± 5.51 dB
	18 GHz ~ 40 GHz	± 5.92 dB

\* Coverage factor  $k=2$ , Confidence levels of 95 %

### 3.4. STANDARDS ENVIRONMENTAL TEST CONDITIONS

Temperature	+15 °C to +35 °C
Relative humidity	30 % to 60 %
Air pressure	860 mbar to 1 060 mbar

### 3.5. TEST DIAGRAMS

#### Conducted Test

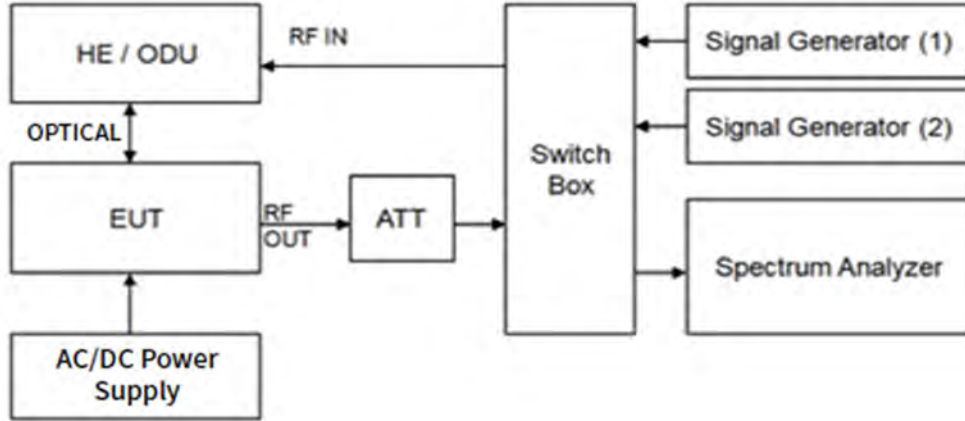

#### Radiated Test

30 MHz ~ 1 GHz

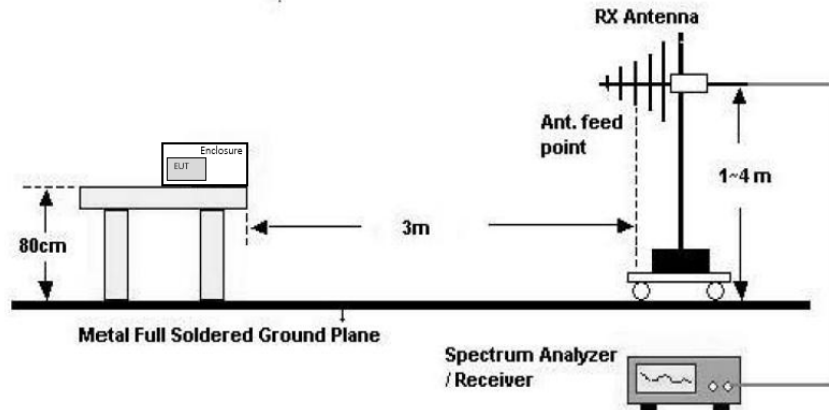

Above 1 GHz

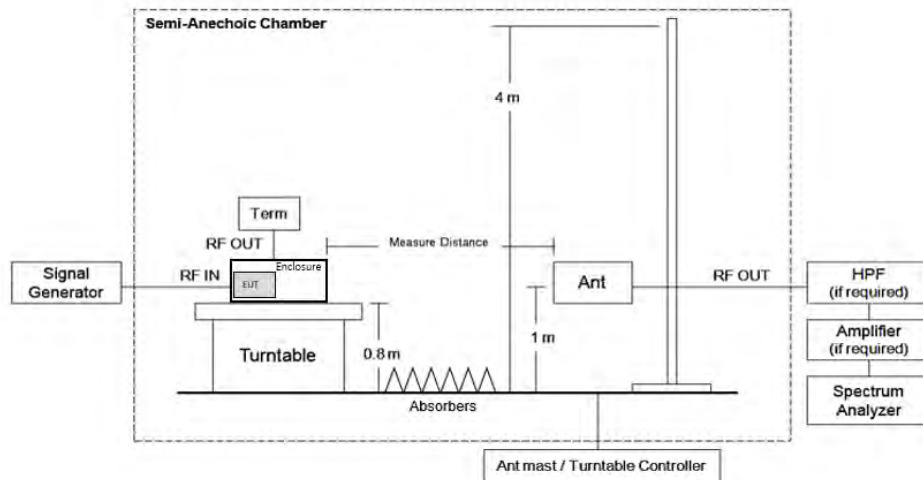

※ EUT position is adopted by placement of floor-standing refer to section 5.5.2.3.2 of ANSI C63.26-2015

---

Frequency Stability

---

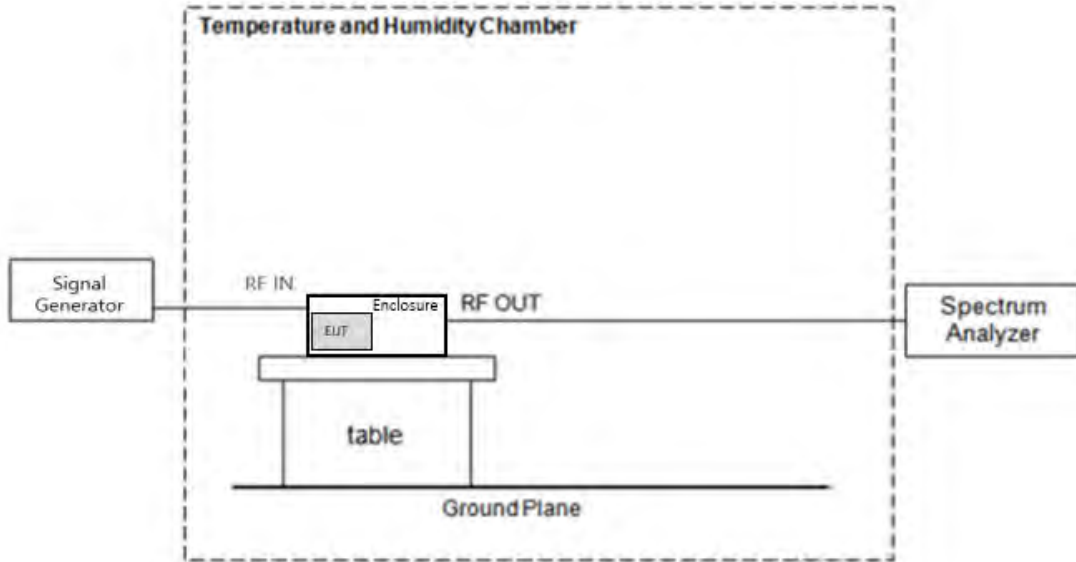

#### 4. TEST EQUIPMENTS

Equipment	Model	Manufacturer	Serial No.	Due to Calibration	Calibration Interval
MXA Signal Analyzer	N9020A	Keysight	MY46471250	07/22/2023	Annual
PXA Signal Analyzer	N9030A	Keysight	MY49431434	01/05/2023	Annual
PXA Signal Analyzer	N9030B	Keysight	MY60070602	10/22/2022	Annual
MXG Vector Signal Generator	N5182A	Agilent	MY47070406	02/22/2023	Annual
MXG Vector Signal Generator	N5182A	Agilent	MY46240807	11/23/2022	Annual
DC Power Supply	PWR800L	KIKUSUI	LJ003448	05/30/2023	Annual
30 dB Attenuator	WA93-30-33	Weinschel Associates	0190	03/28/2023	Annual
20 dB Attenuator	FAS-23-20	MCLI	103756	01/03/2023	Annual
30 dB Attenuator	TWAN-300-18G	Teleworld	N/A	08/22/2023	Annual
50Ω Termination	908A	H.P.	N/A	N/A	N/A
Switch	S46	KEITHLEY	1088024	N/A	N/A
Controller (Antenna mast)	CO3000	Innco systems	CO3000-4p	N/A	N/A
Antenna Position Tower	MA4640/800-XP-EP	Innco systems	N/A	N/A	N/A
Controller (Antenna mast & Turn Table)	EM1000	Audix	060520	N/A	N/A
Turn Table	N/A	Audix	N/A	N/A	N/A
Loop Antenna	FMZB 1513	Schwarzbeck	1513-333	03/17/2024	Biennial
Trilog Super Broadband Antenna	VULB 9168	Schwarzbeck	9168-0895	08/16/2024	Biennial
Horn Antenna	BBHA 9120D	Schwarzbeck	02296	05/18/2024	Biennial
Horn Antenna (15 GHz ~ 40 GHz)	BBHA9170	Schwarzbeck	BBHA9170124	04/12/2023	Biennial
Spectrum Analyzer	FSV40	Rohde & Schwarz	101055	05/16/2023	Annual
Amp & Filter Bank Switch Controller	FBSM-01B	TNM system	TM19050002	N/A	N/A
LNA1(1~18GHz)	FMSR-05B	TNM system	25540	01/19/2023	Annual
High Pass Filter	WHNX6.0/26.5G-6SS	Wainwright Instruments	1	02/17/2023	Annual
Power Amplifier	CBL18265035	CERNEX	22966	12/02/2022	Annual
Power Amplifier	CBL26405040	CERNEX	25956	03/11/2023	Annual

**Note:**

1. Equipment listed above that calibrated during the testing period was set for test after the calibration.
2. Equipment listed above that has a calibration due date during the testing period, the testing is completed before equipment expiration date.

## 5. TEST RESULT

### 5.1. AGC THRESHOLD

#### Test Requirement:

##### KDB 935210 D05 v01r04

Testing at and above the AGC threshold is required.

#### Test Procedures:

Measurements were in accordance with the test methods section 3.2 of KDB 935210 D05 v01r04.

In the case of fiber-optic distribution systems, the RF input port of the equipment under test (EUT) refers to the RF input of the supporting equipment RF to optical convertor; see also descriptions and diagrams for typical DAS booster systems in KDB Publication 935210 D02

Devices intended to be directly connected to an RF source (donor port) only need to be evaluated for any over-the-air transmit paths.

- a) Connect a signal generator to the input of the EUT.
- b) Connect a spectrum analyzer or power meter to the output of the EUT using appropriate attenuation as necessary.
- c) The signal generator should initially be configured to produce either of the required test signals.
- d) Set the signal generator frequency to the center frequency of the EUT operating band.
- e) While monitoring the output power of the EUT, measured using the methods of ANSI C63.26-2015 subclause 5.2.4.4.1, increase the input level until a 1 dB increase in the input signal power no longer causes a 1 dB increase in the output signal power.
- f) Record this level as the AGC threshold level.
- g) Repeat the procedure with the remaining test signal.

Output power measurement in subclause 5.2.4.4.1 of ANSI C63.26

- a) Set span to  $2 \times$  to  $3 \times$  the OBW.
- b) Set RBW = 1% to 5% of the OBW.
- c) Set VBW  $\geq 3 \times$  RBW.
- d) Set number of measurement points in sweep  $\geq 2 \times$  span / RBW.
- e) Sweep time: auto-couple
- f) Detector = power averaging (rms).
- g) If the EUT can be configured to transmit continuously, then set the trigger to free run.
- h) Omit
- i) Trace average at least 100 traces in power averaging (rms) mode if sweep is set to auto-couple. To accurately determine the average power over multiple symbols, it can be necessary to increase the number of traces to be averaged above 100 or, if using a manually configured sweep time, increase the sweep time.

- j) Compute the power by integrating the spectrum across the OBW of the signal using the instrument’s band or channel power measurement function, with the band/channel limits set equal to the OBW band edges. If the instrument does not have a band or channel power function, then sum the spectrum levels (in linear power units) at intervals equal to the RBW extending across the entire OBW of the spectrum.

**Note:**

- (1) All power supplies of operation were investigated and the worst case configuration results are reported.
- Mode: 100~240 VAC, 50/60 Hz /  $\pm 36\text{ V} \sim \pm 76\text{ VDC}$
  - Worst case: 100~240 VAC, 50/60 Hz

**Test Results:**

Test Band	Link	Signal	Center Frequency (MHz)	AGC Threshold Level (dBm)	Output Level (dBm)
C-Band	Downlink	5G NR 20 MHz	3 840.00	0	45.86
		5G NR 40 MHz	3 840.00	0	45.71
		5G NR 60 MHz	3 840.00	0	45.85
		5G NR 80 MHz	3 840.00	0	46.16
		5G NR 100 MHz	3 840.00	0	45.89

## 5.2. OUT-OF-BAND REJECTION

### Test Requirement:

**KDB 935210 D05 v01r04**

Out-of-band rejection required.

### Test Procedures:

Measurements were in accordance with the test methods section 3.3 of KDB 935210 D05 v01r04.

A signal booster shall reject amplification of other signals outside of its passband. Adjust the internal gain control of the EUT (if so equipped) to the maximum gain for which equipment certification is sought.

- a) Connect a signal generator to the input of the EUT.
- b) Configure a swept CW signal with the following parameters:
  - 1) Frequency range =  $\pm 250\%$  of the passband, for each applicable CMRS band.
  - 2) Level = a sufficient level to affirm that the out-of-band rejection is  $> 20$  dB above the noise floor and will not engage the AGC during the entire sweep.
  - 3) Dwell time = approximately 10 ms.
  - 4) Number of points =  $\text{SPAN}/(\text{RBW}/2)$ .
- c) Connect a spectrum analyzer to the output of the EUT using appropriate attenuation.
- d) Set the span of the spectrum analyzer to the same as the frequency range of the signal generator.
- e) Set the resolution bandwidth (RBW) of the spectrum analyzer to be 1 % to 5 % of the EUT passband, and the video bandwidth (VBW) shall be set to  $\geq 3 \times \text{RBW}$ .
- f) Set the detector to Peak Max-Hold and wait for the spectrum analyzer's spectral display to fill.
- g) Place a marker to the peak of the frequency response and record this frequency as  $f_0$ .
- h) Place two markers, one at the lowest and the other at the highest frequency of the envelope of the spectral display, such that each marker is at or slightly below the  $-20$  dB down amplitude, to determine the 20 dB bandwidth.
- i) Capture the frequency response of the EUT.
- j) Repeat for all frequency bands applicable for use by the EUT.

### Note:

- (1) All power supplies of operation were investigated and the worst case configuration results are reported.
  - Mode: 100~240 VAC, 50/60 Hz /  $\pm 36$  V ~  $\pm 76$  VDC
  - Worst case: 100~240 VAC, 50/60 Hz



Test Results:

C-Band / Downlink

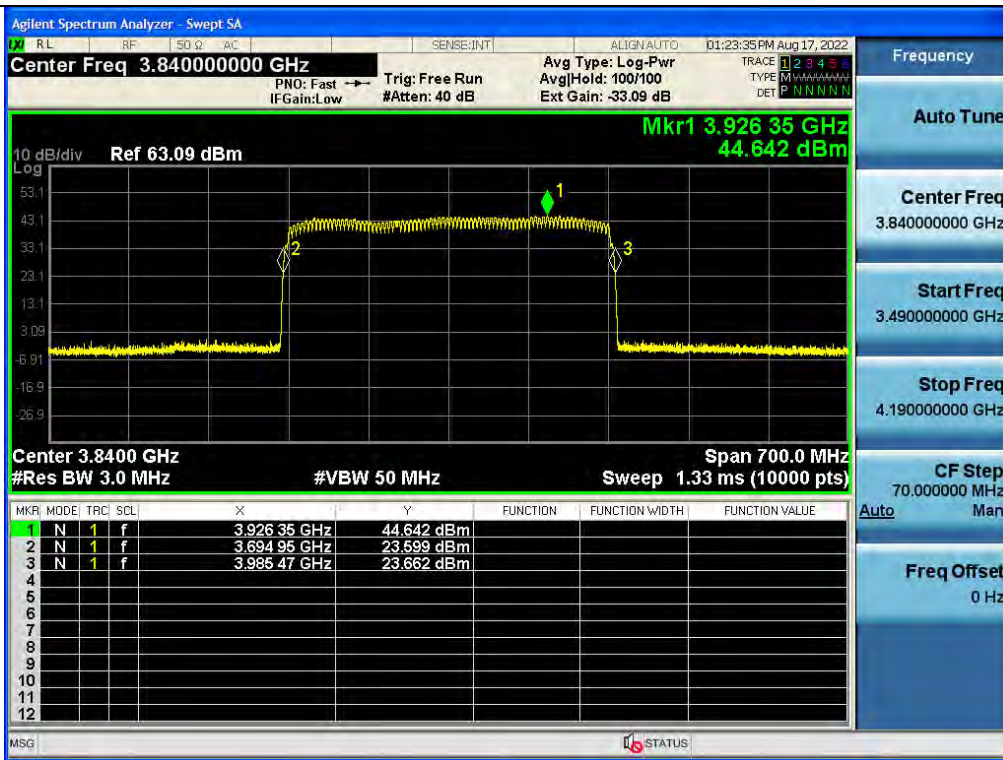

### 5.3. INPUT-VERSUS-OUTPUT SIGNAL COMPARISON

#### Test Requirement:

##### § 2.1049 Measurements required: Occupied bandwidth.

The occupied bandwidth, that is the frequency bandwidth such that, below its lower and above its upper frequency limits, the mean powers radiated are each equal to 0.5 percent of the total mean power radiated by a given emission shall be measured under the specified conditions of § 2.1049 (a) through (i) as applicable.

#### Test Procedures:

Measurements were in accordance with the test methods section 3.4 of KDB 935210 D05 v01r04.

A 26 dB bandwidth measurement shall be performed on the input signal and the output signal; alternatively, the 99% OBW can be measured and used. See KDB Publication 971168 [R8] for more information on measuring OBW.

- a) Connect a signal generator to the input of the EUT.
- b) Configure the signal generator to transmit the AWGN signal.
- c) Configure the signal amplitude to be just below the AGC threshold level (see 3.2), but not more than 0.5 dB below.
- d) Connect a spectrum analyzer to the output of the EUT using appropriate attenuation.
- e) Set the spectrum analyzer center frequency to the center frequency of the operational band under test. The span range of the spectrum analyzer shall be between 2 times to 5 times the emission bandwidth (EBW) or alternatively, the OBW.
- f) The nominal RBW shall be in the range of 1 % to 5 % of the anticipated OBW, and the VBW shall be  $\geq 3 \times$  RBW.
- g) Set the reference level of the instrument as required to preclude the signal from exceeding the maximum spectrum analyzer input mixer level for linear operation. In general, the peak of the spectral envelope must be more than  $[10 \log (\text{OBW} / \text{RBW})]$  below the reference level. Steps f) and g) may require iteration to enable adjustments within the specified tolerances.
- h) The noise floor of the spectrum analyzer at the selected RBW shall be at least 36 dB below the reference level.
- i) Set spectrum analyzer detection function to positive peak.
- j) Set the trace mode to max hold.
- k) Determine the reference value: Allow the trace to stabilize. Set the spectrum analyzer marker to the highest amplitude level of the displayed trace (this is the reference value) and record the associated frequency.
- l) Place two markers, one at the lowest and the other at the highest frequency of the envelope of the spectral display, such that each marker is at or slightly below the  $-26$  dB down amplitude. The 26 dB EBW (alternatively OBW) is the positive frequency difference between the two markers. If the spectral envelope crosses the  $-26$  dB down amplitude at multiple points, the lowest or highest frequency shall be selected as the frequencies that are the furthest removed from the center frequency at which the spectral envelope crosses the  $-26$  dB down amplitude point.
- m) Repeat steps e) to l) with the input signal connected directly to the spectrum analyzer (i.e., input signal

measurement).

- n) Compare the spectral plot of the input signal (determined from step m) to the output signal (determined from step l) to affirm that they are similar (in passband and rolloff characteristic features and relative spectral locations), and include plot(s) and descriptions in test report.
- o) Repeat the procedure [steps e) to n)] with the input signal amplitude set to 3 dB above the AGC threshold.
- p) Repeat steps e) to o) with the signal generator set to the narrowband signal.
- q) Repeat steps e) to p) for all frequency bands authorized for use by the EUT.

**Note:**

- (1) All power supplies of operation were investigated and the worst case configuration results are reported.
  - Mode: 100~240 VAC, 50/60 Hz /  $\pm 36\text{ V} \sim \pm 76\text{ VDC}$
  - Worst case: 100~240 VAC, 50/60 Hz

**Test Results:**

Tabular data of Output Occupied Bandwidth

Test Band	Link	Signal	Center Frequency (MHz)	99 % OBW (MHz)	26 dB OBW (MHz)
C-Band	Downlink	5G NR 20 MHz	3 840.00	18.264	19.425
		5G NR 40 MHz	3 840.00	37.934	39.915
		5G NR 60 MHz	3 840.00	57.865	60.933
		5G NR 80 MHz	3 840.00	77.473	81.526
		5G NR 100 MHz	3 840.00	97.093	102.250

Tabular data of Input Occupied Bandwidth

Test Band	Link	Signal	Center Frequency (MHz)	99 % OBW (MHz)	26 dB OBW (MHz)
C-Band	Downlink	5G NR 20 MHz	3 840.00	18.276	19.475
		5G NR 40 MHz	3 840.00	37.927	39.900
		5G NR 60 MHz	3 840.00	57.923	60.933
		5G NR 80 MHz	3 840.00	77.640	81.562
		5G NR 100 MHz	3 840.00	97.153	102.449

Tabular data of 3 dB above the AGC threshold Output Occupied Bandwidth

Test Band	Link	Signal	Center Frequency (MHz)	99 % OBW (MHz)	26 dB OBW (MHz)
C-Band	Downlink	5G NR 20 MHz	3 840.00	18.241	19.405
		5G NR 40 MHz	3 840.00	37.866	39.909
		5G NR 60 MHz	3 840.00	57.887	60.848
		5G NR 80 MHz	3 840.00	77.470	81.493
		5G NR 100 MHz	3 840.00	97.106	102.289

Tabular data of 3 dB above the AGC threshold Input Occupied Bandwidth

Test Band	Link	Signal	Center Frequency (MHz)	99 % OBW (MHz)	26 dB OBW (MHz)
C-Band	Downlink	5G NR 20 MHz	3 840.00	18.268	19.420
		5G NR 40 MHz	3 840.00	37.939	39.935
		5G NR 60 MHz	3 840.00	57.991	60.914
		5G NR 80 MHz	3 840.00	77.538	81.529
		5G NR 100 MHz	3 840.00	97.372	102.189

Measured Occupied Bandwidth Comparison

Test Band	Link	Signal	Variant of Input and output 26 dB Occupied Bandwidth (%)	Variant of Input and 3 dB above the AGC threshold output 26 dB Occupied Bandwidth (%)
C-Band	Downlink	5G NR 20 MHz	-0.257	-0.077
		5G NR 40 MHz	0.038	-0.065
		5G NR 60 MHz	0.000	-0.108
		5G NR 80 MHz	-0.044	-0.044
		5G NR 100 MHz	-0.194	0.098

\* Change in input-output OBW is less than  $\pm 5\%$ .

Plot data of Occupied Bandwidth

Output / C-Band / Downlink / 5G NR 20 MHz

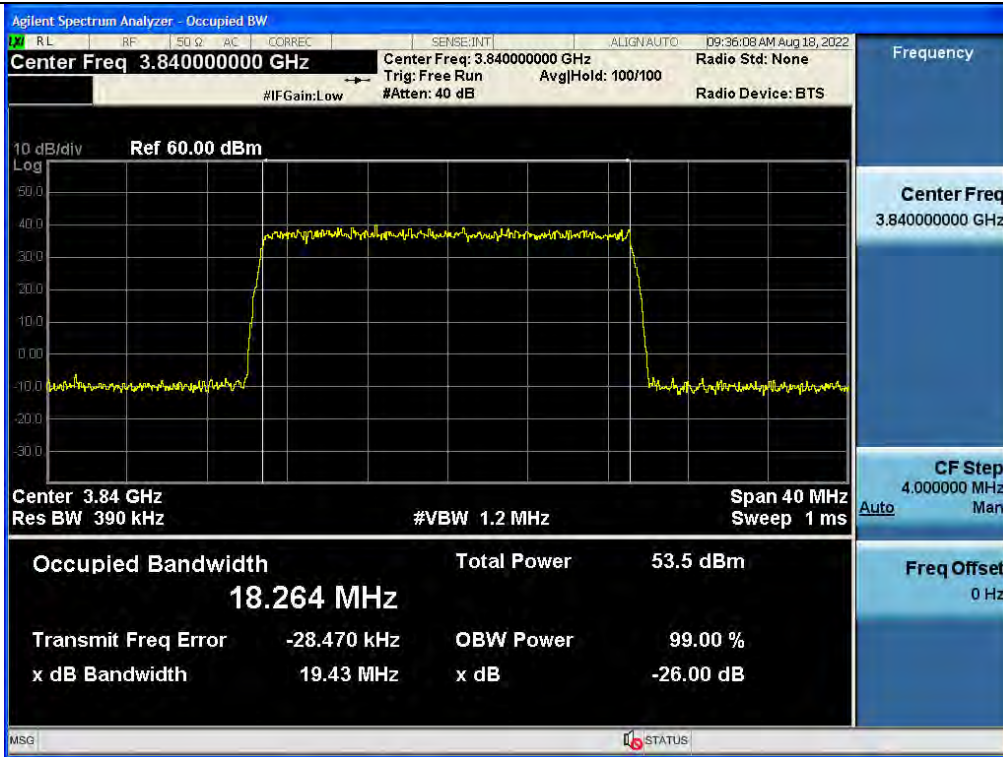

Input / C-Band / Downlink / 5G NR 20 MHz

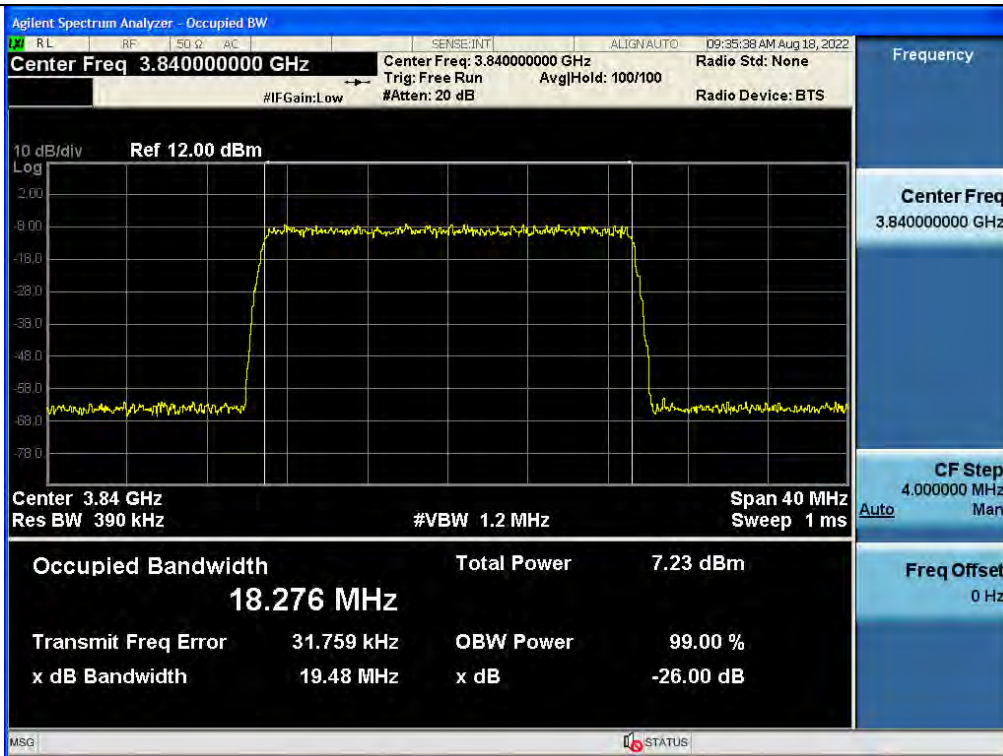

3 dB above the AGC threshold output / C-Band / Downlink / 5G NR 20 MHz

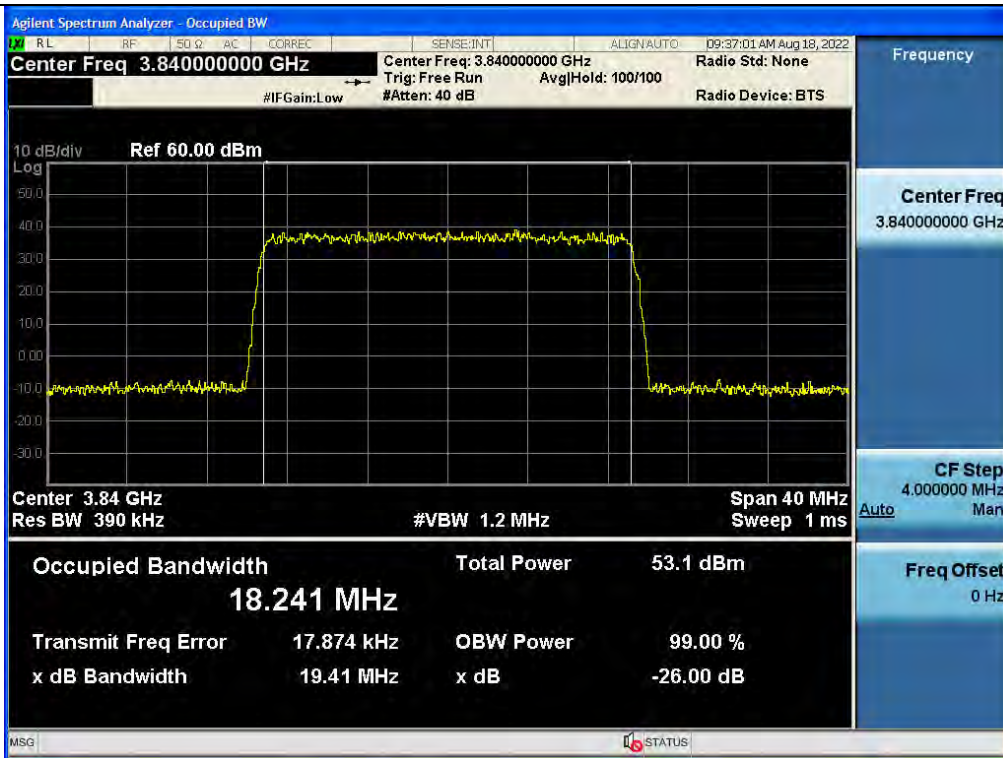

3 dB above the AGC threshold Input / C-Band / Downlink / 5G NR 20 MHz

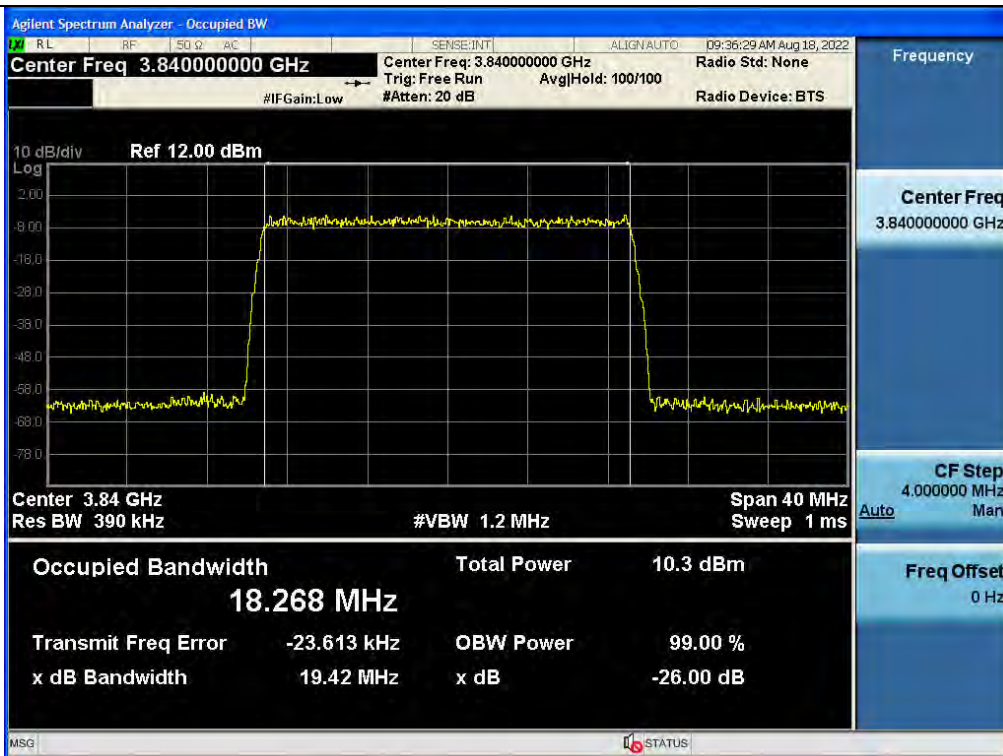

Output / C-Band / Downlink / 5G NR 40 MHz

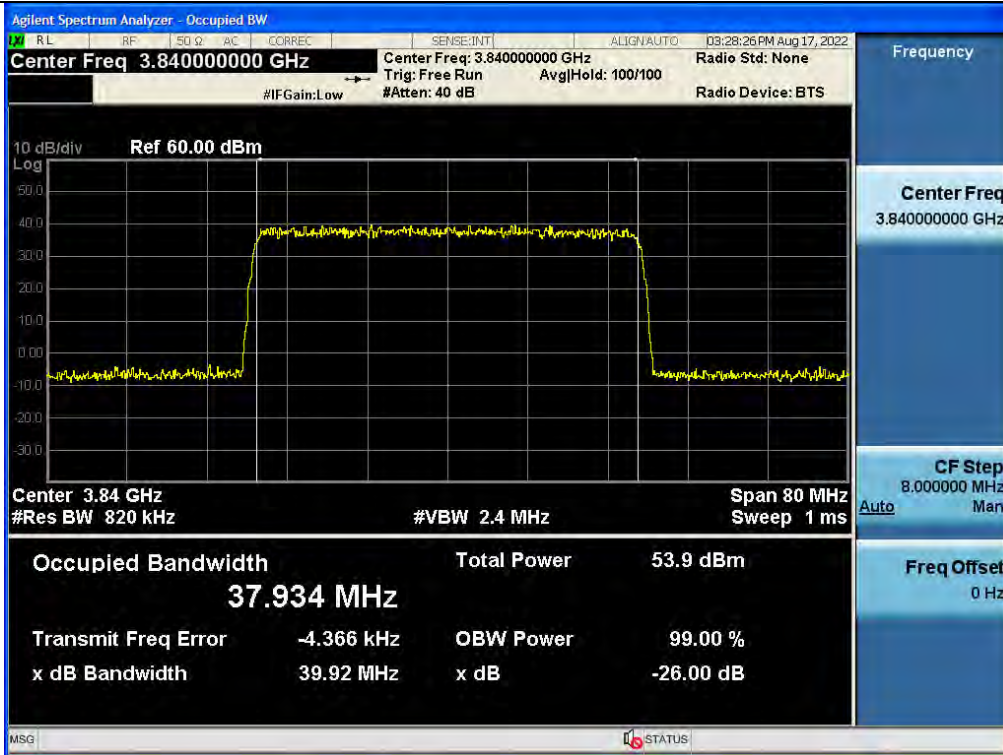

Input / C-Band / Downlink / 5G NR 40 MHz

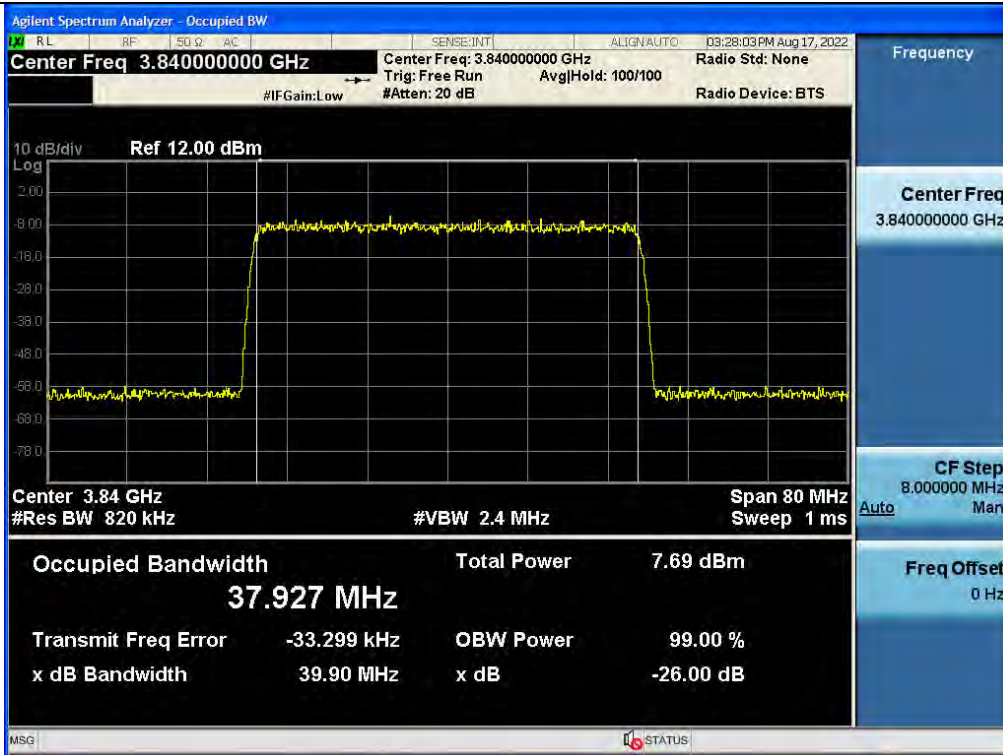



3 dB above the AGC threshold output / C-Band / Downlink / 5G NR 40 MHz

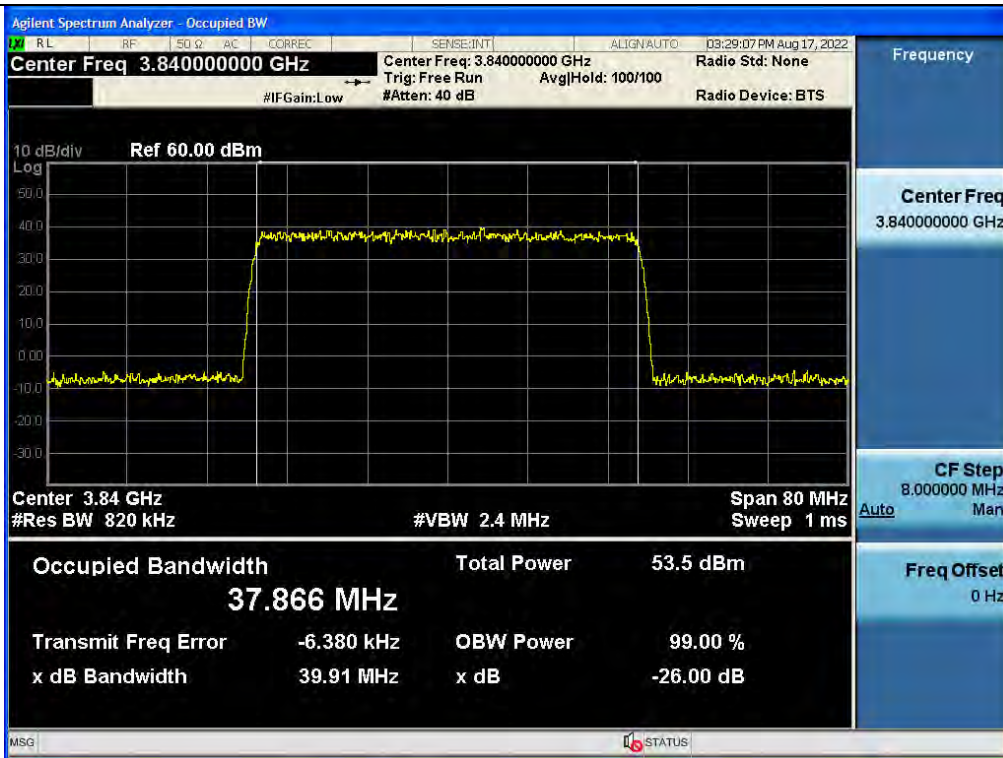

3 dB above the AGC threshold Input / C-Band / Downlink / 5G NR 40 MHz

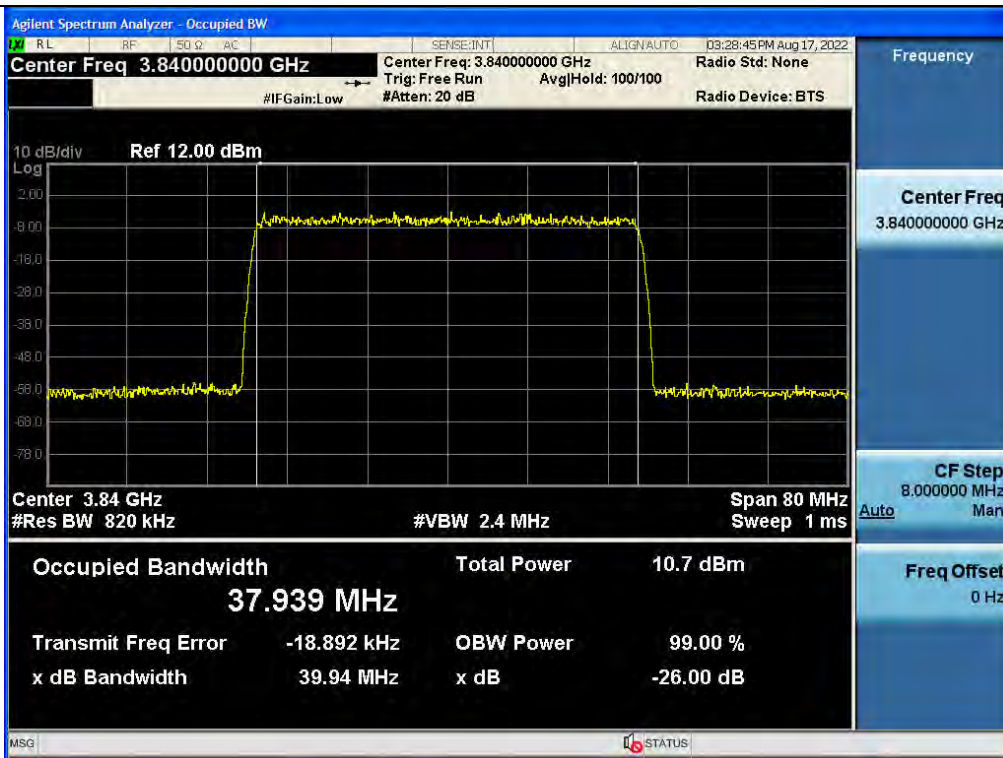

Output / C-Band / Downlink / 5G NR 60 MHz

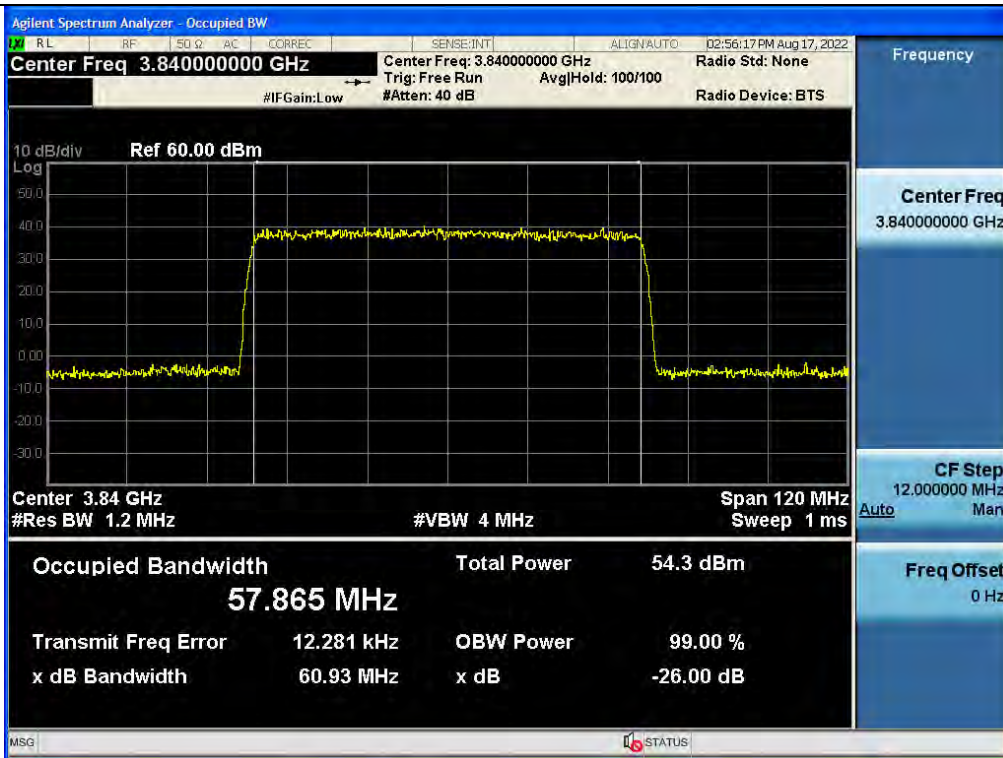

Input / C-Band / Downlink / 5G NR 60 MHz

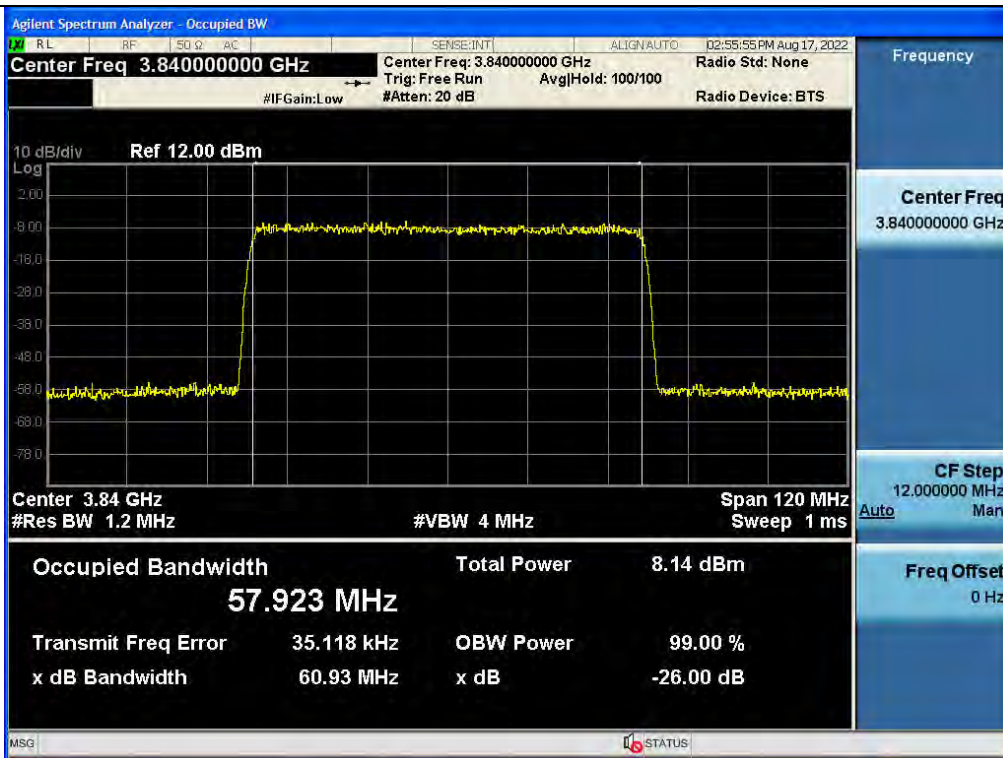

3 dB above the AGC threshold output / C-Band / Downlink / 5G NR 60 MHz

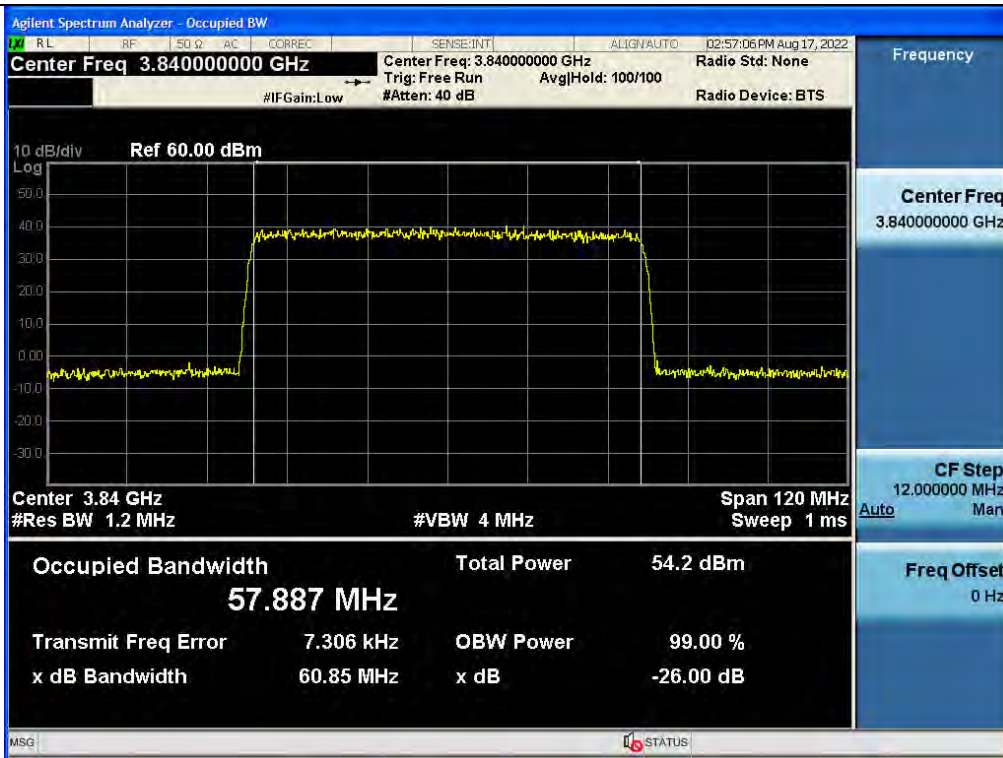

3 dB above the AGC threshold Input / C-Band / Downlink / 5G NR 60 MHz

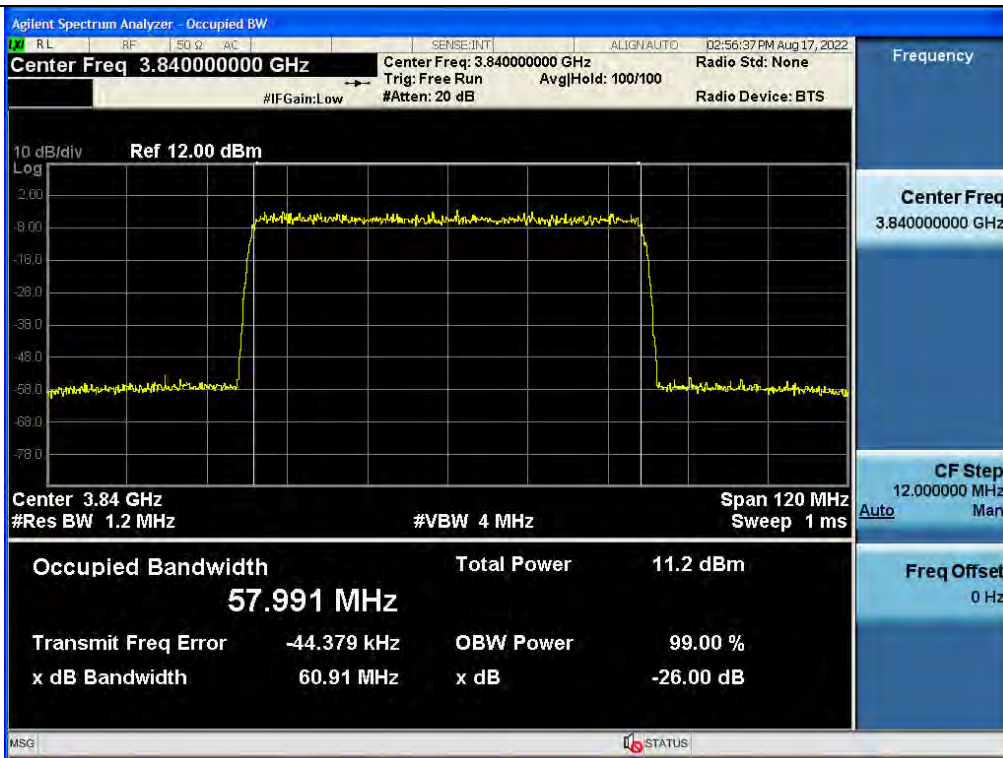

Output / C-Band / Downlink / 5G NR 80 MHz

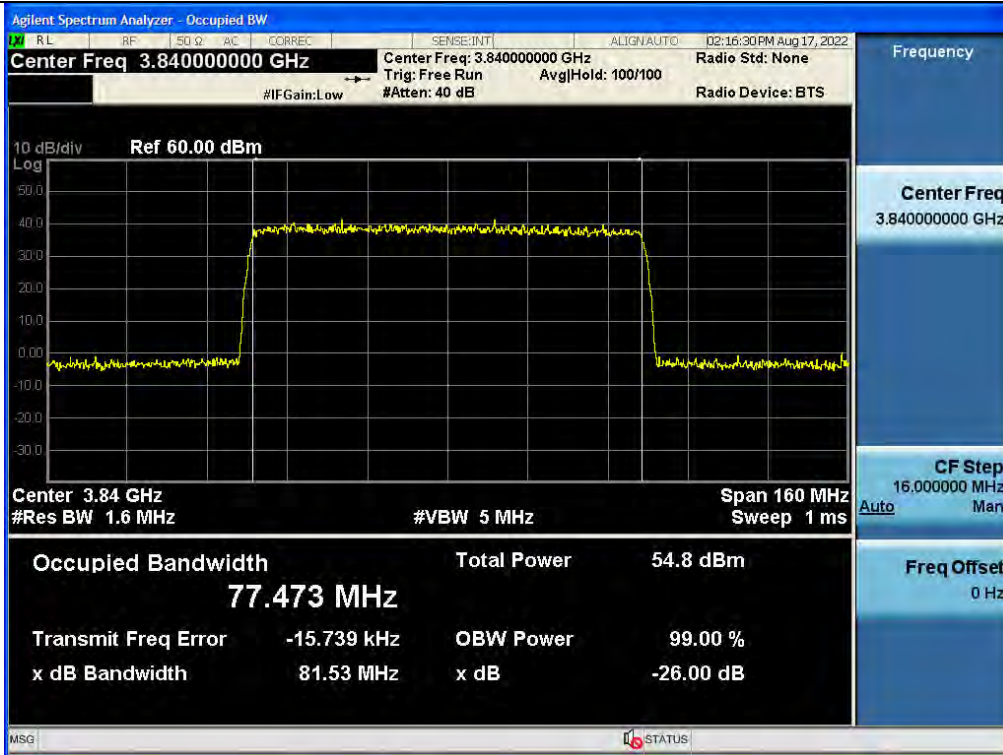

Input / C-Band / Downlink / 5G NR 80 MHz

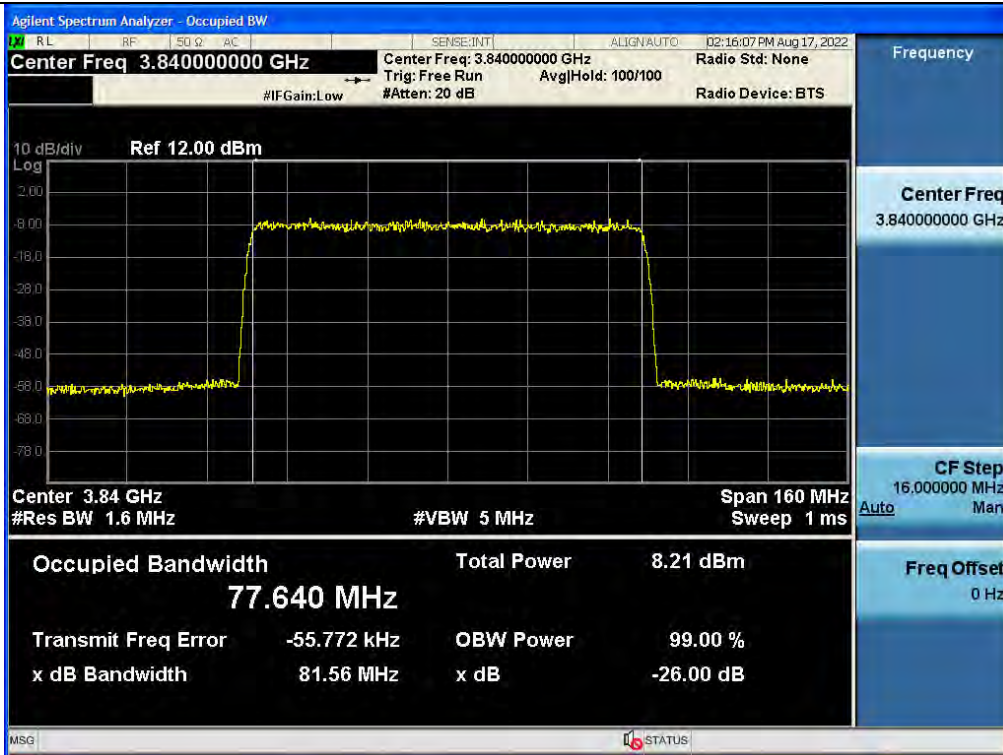

3 dB above the AGC threshold output / C-Band / Downlink / 5G NR 80 MHz

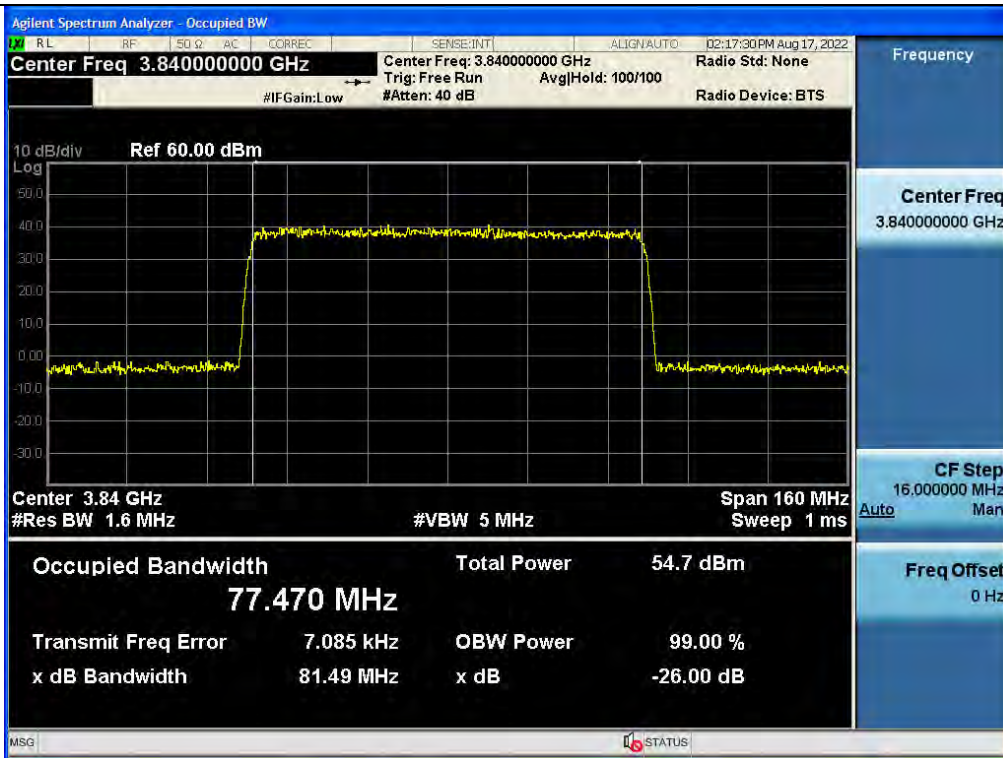

3 dB above the AGC threshold Input / C-Band / Downlink / 5G NR 80 MHz

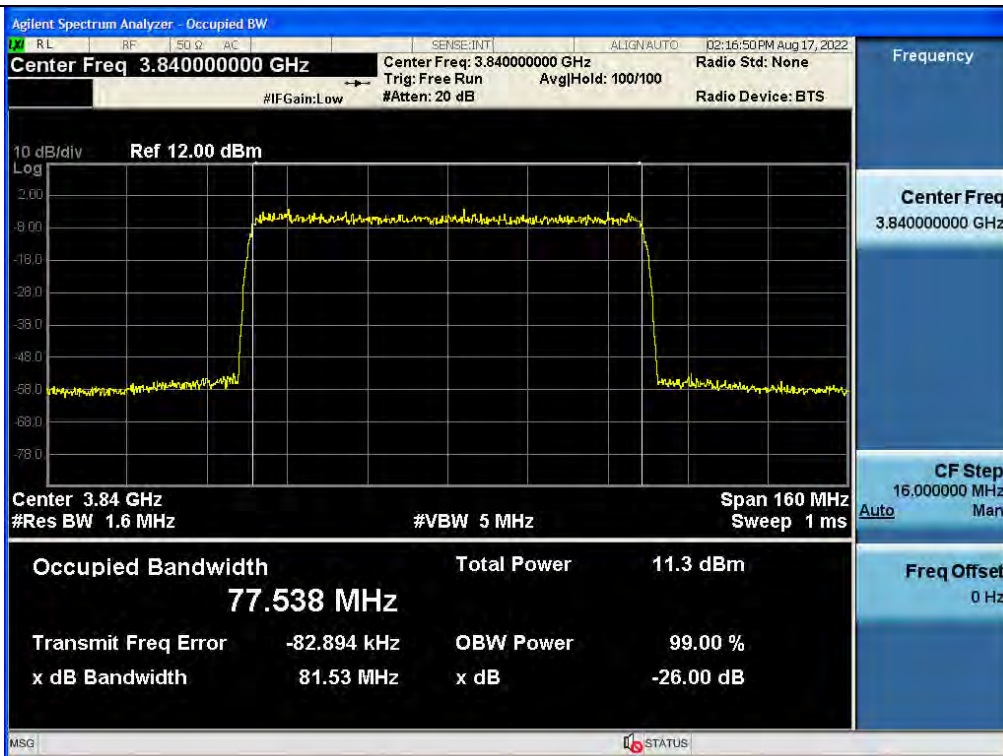

Output / C-Band / Downlink / 5G NR 100 MHz

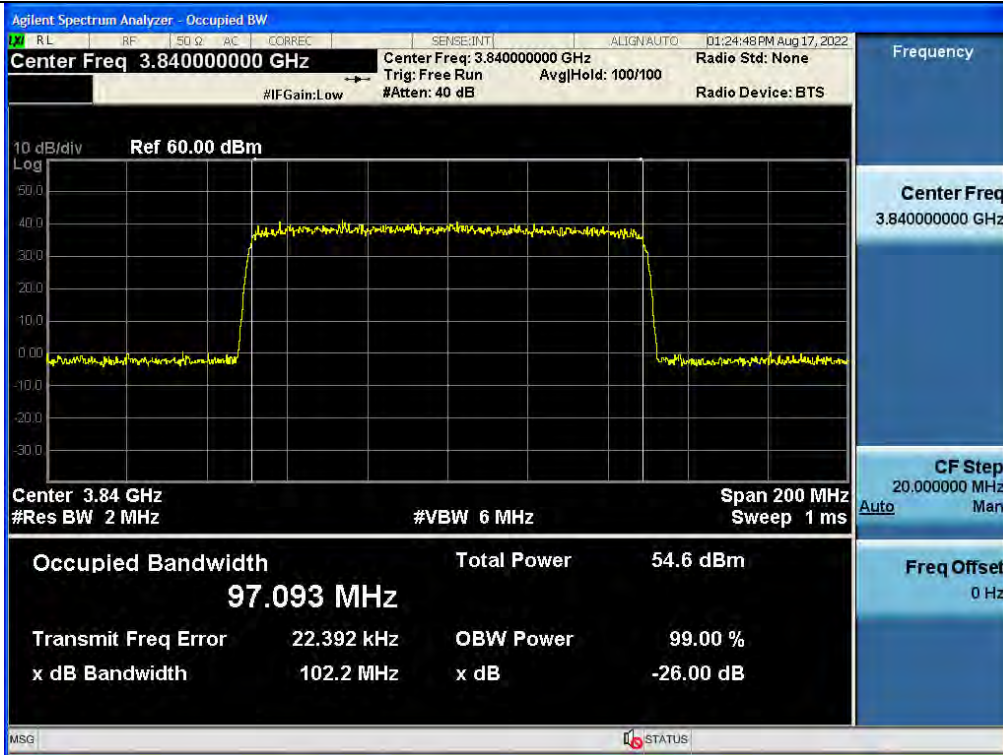

Input / C-Band / Downlink / 5G NR 100 MHz

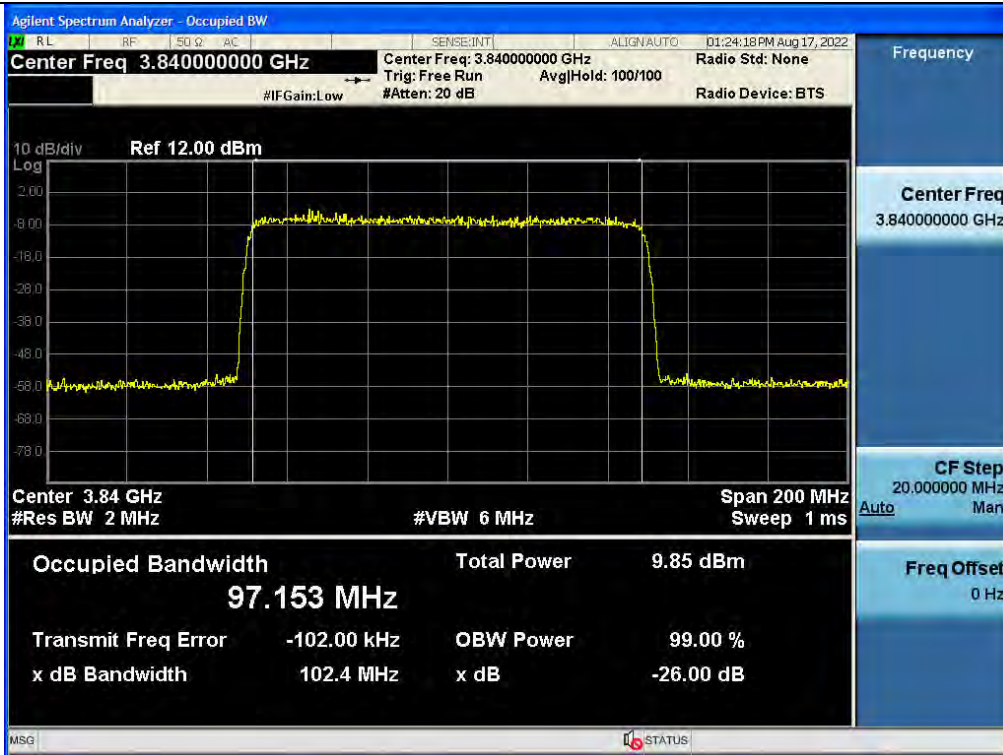

3 dB above the AGC threshold output / C-Band / Downlink / 5G NR 100 MHz

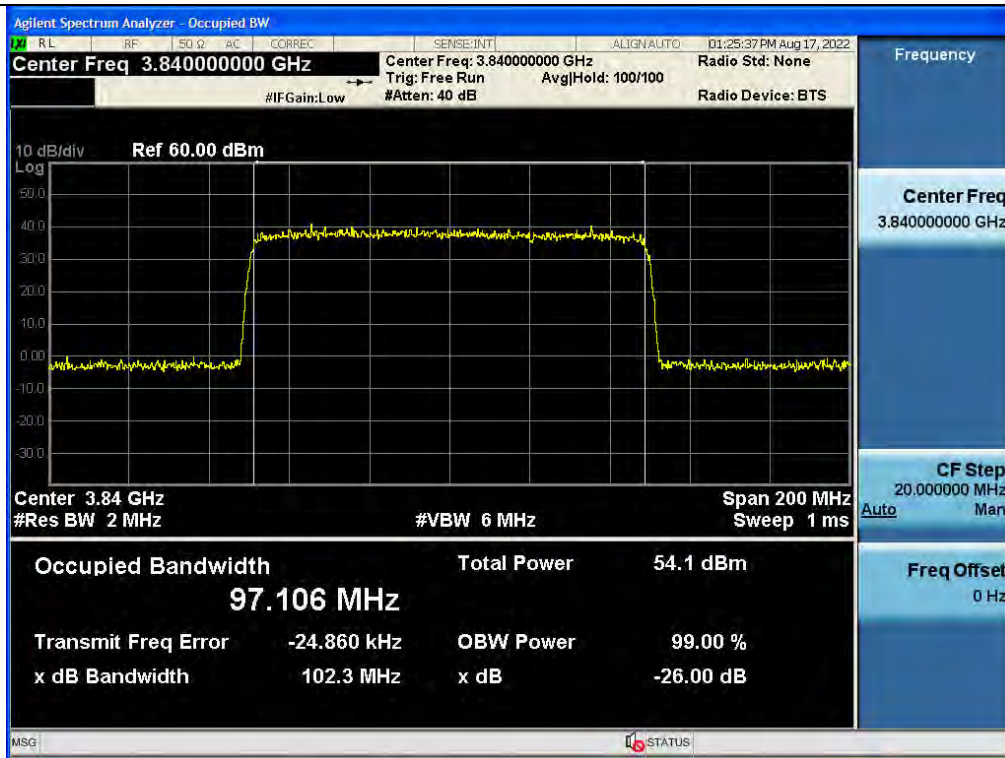

3 dB above the AGC threshold Input / C-Band / Downlink / 5G NR 100 MHz

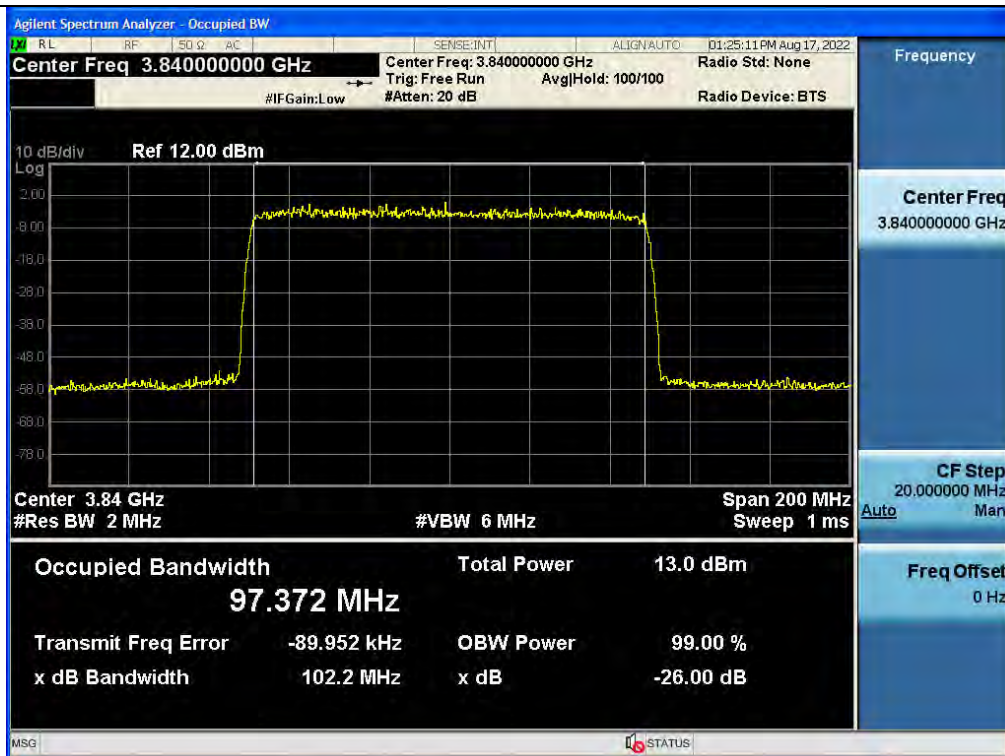

## 5.4. INPUT/OUTPUT POWER AND AMPLIFIER/BOOSTER GAIN

### Test Requirement:

#### § 2.1046 Measurements required: RF power output.

- (a) For transmitters other than single sideband, independent sideband and controlled carrier radiotelephone, power output shall be measured at the RF output terminals when the transmitter is adjusted in accordance with the tune-up procedure to give the values of current and voltage on the circuit elements specified in § 2.1033(c)(8). The electrical characteristics of the radio frequency load attached to the output terminals when this test is made shall be stated.
- (b) For single sideband, independent sideband, and single channel, controlled carrier radiotelephone transmitters the procedure specified in paragraph (a) of this section shall be employed and, in addition, the transmitter shall be modulated during the test as specified and applicable in § 2.1046 (b) (1-5). In all tests, the input level of the modulating signal shall be such as to develop rated peak envelope power or carrier power, as appropriate, for the transmitter.
- (c) For measurements conducted pursuant to paragraphs (a) and (b) of this section, all calculations and methods used by the applicant for determining carrier power or peak envelope power, as appropriate, on the basis of measured power in the radio frequency load attached to the transmitter output terminals shall be shown. Under the test conditions specified, no components of the emission spectrum shall exceed the limits specified in the applicable rule parts as necessary for meeting occupied bandwidth or emission limitations.

#### § 27.50 Power limits and duty cycle.

- (j) The following power requirements apply to stations transmitting in the 3700-3980 MHz band:
  - (2) The power of each fixed or base station transmitting in the 3700-3980 MHz band and situated in any geographic location other than that described in paragraph (j)(1) of this section is limited to an EIRP of 1640 Watts/MHz. This limit applies to the aggregate power of all antenna elements in any given sector of a base station.
  - (4) Equipment employed must be authorized in accordance with the provisions of § 27.51. Power measurements for transmissions by stations authorized under this section may be made either in accordance with a Commission-approved average power technique or in compliance with paragraph (j)(5) of this section. In measuring transmissions in this band using an average power technique, the peak-to-average ratio (PAR) of the transmission may not exceed 13 dB.

### Test Procedures:

Measurements were in accordance with the test methods section 3.5 of KDB 935210 D05 v01r04.

Adjust the internal gain control of the EUT to the maximum gain for which the equipment certification is being sought. Any EUT attenuation settings shall be set to their minimum value.



Input power levels (uplink and downlink) should be set to maximum input ratings while confirming that the device is not capable of operating in saturation (non-linear mode) at the rated input levels, including during the performance of the input/output power measurements.

### 3.5.2 Measuring the EUT mean input and output power

- a) Connect a signal generator to the input of the EUT.
- b) Configure to generate the test signal.
- c) The frequency of the signal generator shall be set to the frequency  $f_0$  as determined from out-of-band rejection test.
- d) Connect a spectrum analyzer or power meter to the output of the EUT using appropriate attenuation as necessary.
- e) Set the signal generator output power to a level that produces an EUT output level that is just below the AGC threshold, but not more than 0.5 dB below.
- f) Measure and record the output power of the EUT; use ANSI C63.26-2015 subclause 5.2.4.4.1, for power measurement.
- g) Remove the EUT from the measurement setup. Using the same signal generator settings, repeat the power measurement at the signal generator port, which was used as the input signal to the EUT, and record as the input power. EUT gain may be calculated as described in 3.5.5.
- h) Repeat steps f) and g) with input signal amplitude set to 3 dB above the AGC threshold level.
- i) Repeat steps e) to h) with the narrowband test signal.
- j) Repeat steps e) to i) for all frequency bands authorized for use by the EUT.

### 3.5.5 Calculating amplifier, repeater, or industrial booster gain

After the input and output power levels have been measured as described in the preceding subclauses, the gain of the EUT can be determined from:

$$\text{Gain (dB)} = \text{output power (dBm)} - \text{input power (dBm)}.$$

Report the gain for each authorized operating frequency band, and each test signal stimulus.

Note. If  $f_0$  that determined from out-of-band test is smaller or greater than difference of test signal's center frequency and operation band block, test is performed at the lowest or the highest frequency that test signals can be passed.

#### Note:

- (1) All power supplies of operation were investigated and the worst case configuration results are reported.
  - Mode: 100~240 VAC, 50/60 Hz /  $\pm 36$  V ~  $\pm 76$  VDC
  - Worst case: 100~240 VAC, 50/60 Hz

**Test Results:**

Tabular data of Input / Output Power and Gain

Test Band	Signal	f <sub>0</sub> Frequency	Input Power	Output Power	Gain	Ant. Gain	E.I.R.P.		
		(MHz)	(dBm)	(dB)	(dBi)	(dBm)	(W/MHz)	(W)	
C-Band	5G NR 20 MHz	3 926.35	0.12	46.08	45.96	4.60	50.68	5.85	116.95
	5G NR 40 MHz	3 926.35	0.01	45.85	45.84	4.60	50.45	2.77	110.92
	5G NR 60 MHz	3 926.35	0.12	46.05	45.93	4.60	50.65	1.94	116.14
	5G NR 80 MHz	3 926.35	0.09	46.24	46.15	4.60	50.84	1.52	121.34
	5G NR 100 MHz	3 926.35	0.13	45.98	45.85	4.60	50.58	1.14	114.29

\*E.I.R.P.(dBm) = Output Power(dBm) + Ant. Gain

Tabular data of Input / 3 dB above AGC threshold Output Power and Gain

Test Band	Signal	f <sub>0</sub> Frequency	Input Power	Output Power	Gain	Ant. Gain	E.I.R.P.		
		(MHz)	(dBm)	(dB)	(dBi)	(dBm)	(W/MHz)	(W)	
C-Band	5G NR 20 MHz	3 926.35	3.10	45.90	42.80	4.60	50.50	5.61	112.20
	5G NR 40 MHz	3 926.35	3.04	45.89	42.85	4.60	50.49	2.80	111.94
	5G NR 60 MHz	3 926.35	3.13	46.00	42.87	4.60	50.60	1.91	114.82
	5G NR 80 MHz	3 926.35	3.16	46.31	43.15	4.60	50.91	1.54	123.31
	5G NR 100 MHz	3 926.35	3.19	45.71	42.52	4.60	50.31	1.07	107.40

\*E.I.R.P.(dBm) = Output Power(dBm) + Ant. Gain

Tabular data of PSD

Test Band	Signal	f <sub>0</sub> Frequency (MHz)	Output PSD (dBm/MHz)	Ant. Gain (dB)	E.I.R.P. (dBm/MHz)	Calculated (W/MHz)	Limit (W/MHz)
C-Band	5G NR 20 MHz	3 926.35	34.27	4.60	38.87	7.71	1640
	5G NR 40 MHz	3 926.35	31.18	4.60	35.78	3.78	
	5G NR 60 MHz	3 926.35	29.58	4.60	34.18	2.62	
	5G NR 80 MHz	3 926.35	28.58	4.60	33.18	2.08	
	5G NR 100 MHz	3 926.35	27.52	4.60	32.12	1.63	

\*Note: Downlink E.I.R.P.(dBm/MHz) = Output PSD(dBm/MHz) + Ant. Gain

Tabular data of 3 dB above AGC threshold PSD

Test Band	Signal	f <sub>0</sub> Frequency (MHz)	Output PSD (dBm/MHz)	Ant. Gain (dB)	E.I.R.P. (dBm/MHz)	Calculated (W/MHz)	Limit (W/MHz)
C-Band	5G NR 20 MHz	3 926.35	34.26	4.60	38.86	7.69	1640
	5G NR 40 MHz	3 926.35	31.34	4.60	35.94	3.93	
	5G NR 60 MHz	3 926.35	29.66	4.60	34.26	2.67	
	5G NR 80 MHz	3 926.35	28.71	4.60	33.31	2.14	
	5G NR 100 MHz	3 926.35	27.17	4.60	31.77	1.50	

\*Note: Downlink E.I.R.P.(dBm/MHz) = Output PSD(dBm/MHz) + Ant. Gain

Tabular data of PAPR

Test Band	Signal	f <sub>0</sub> Frequency (MHz)	0.1 % PAPR (dB)
C-Band	5G NR 20 MHz	3 926.35	8.30
	5G NR 40 MHz	3 926.35	8.35
	5G NR 60 MHz	3 926.35	8.93
	5G NR 80 MHz	3 926.35	8.29
	5G NR 100 MHz	3 926.35	8.32

Plot data of PSD

PSD / C-Band / Downlink / 5G NR 20 MHz



3 dB above the AGC threshold PSD / C-Band / Downlink / 5G NR 20 MHz

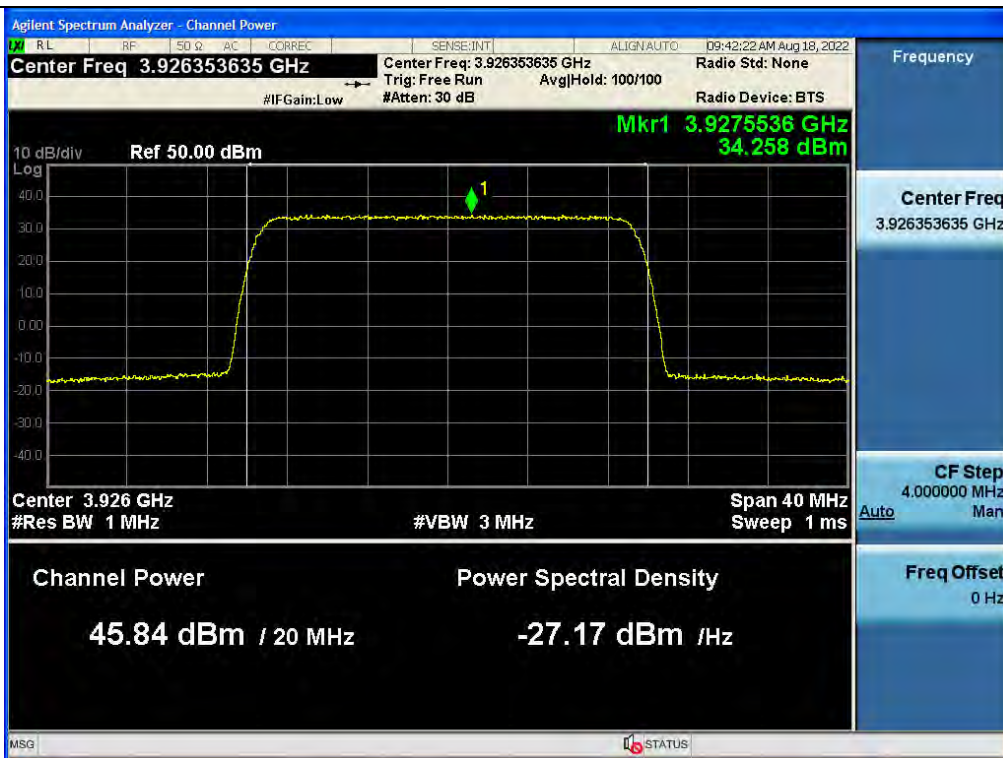

PSD / C-Band / Downlink / 5G NR 40 MHz

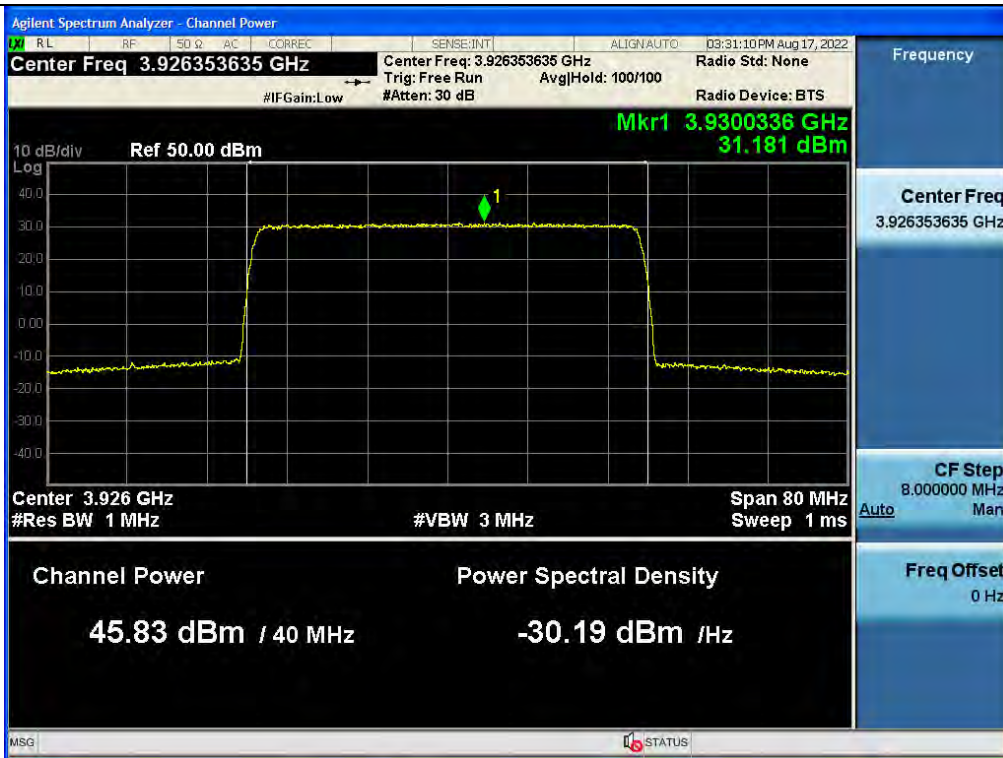

3 dB above the AGC threshold PSD / C-Band / Downlink / 5G NR 40 MHz



PSD / C-Band / Downlink / 5G NR 60 MHz

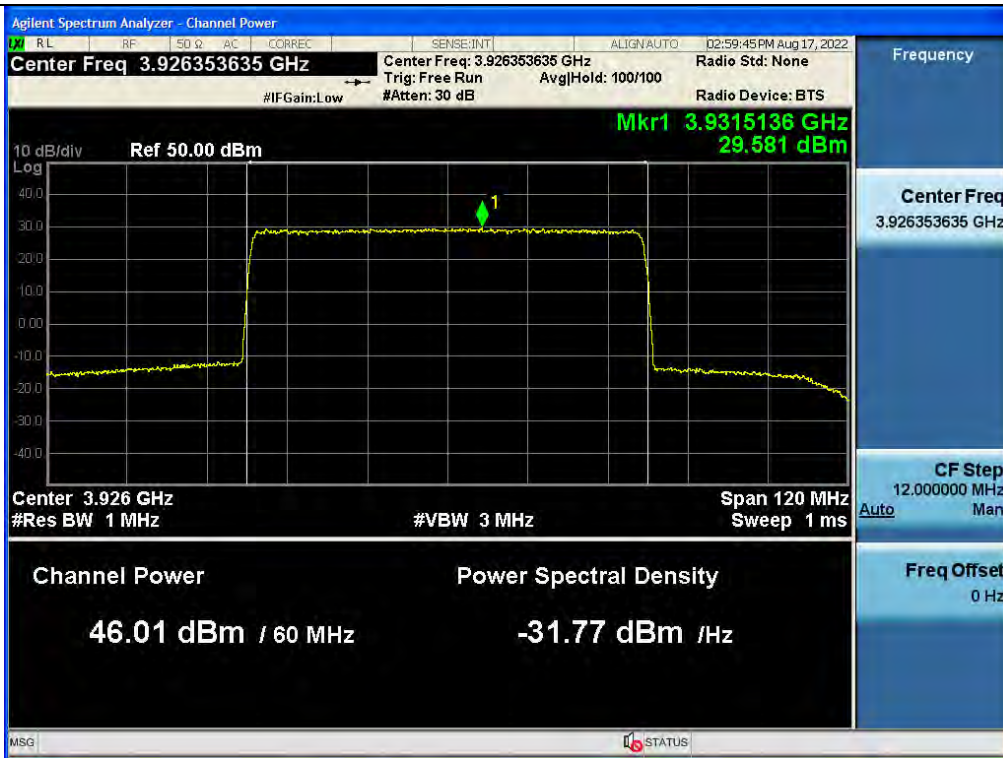

3 dB above the AGC threshold PSD / C-Band / Downlink / 5G NR 60 MHz



PSD / C-Band / Downlink / 5G NR 80 MHz



3 dB above the AGC threshold PSD / C-Band / Downlink / 5G NR 80 MHz



PSD / C-Band / Downlink / 5G NR 100 MHz



3 dB above the AGC threshold PSD / C-Band / Downlink / 5G NR 100 MHz





Plot data of PAPR

PAPR / C-Band / Downlink / 5G NR 20 MHz

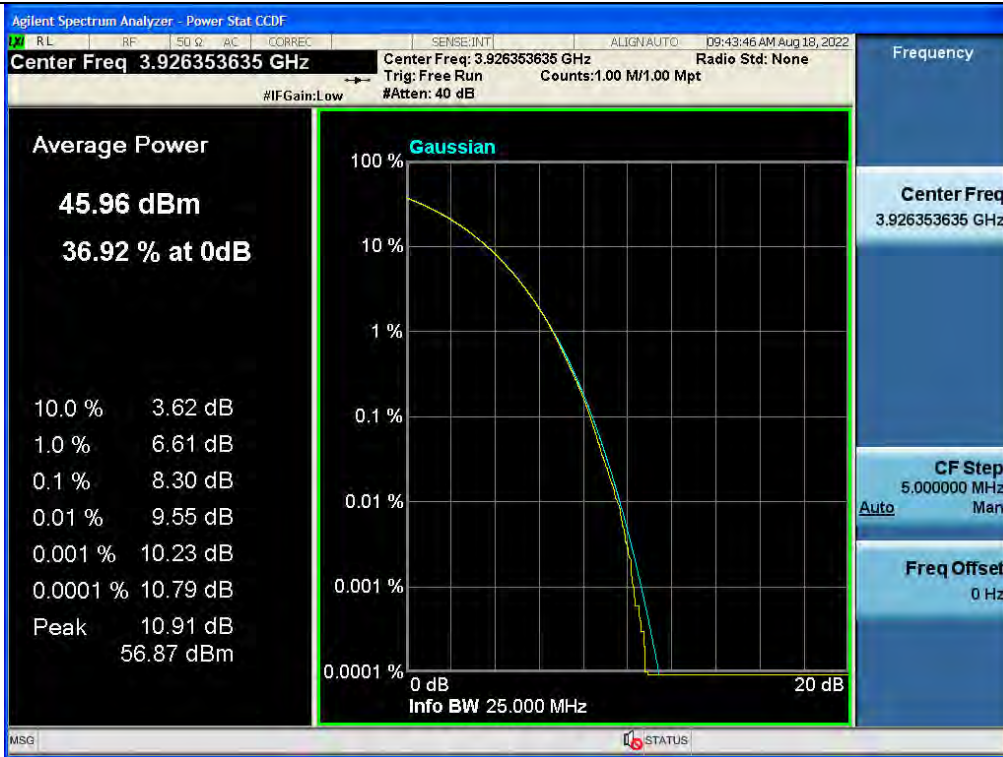

PAPR / C-Band / Downlink / 5G NR 40 MHz



PAPR / C-Band / Downlink / 5G NR 60 MHz



PAPR / C-Band / Downlink / 5G NR 80 MHz



PAPR / C-Band / Downlink / 5G NR 100 MHz



## 5.5. OUT-OF-BAND/OUT-OF-BLOCK EMISSIONS AND SPURIOUS EMISSIONS

### Test Requirements:

#### § 2.1051 Measurements required: Spurious emissions at antenna terminals:

The radio frequency voltage or powers generated within the equipment and appearing on a spurious frequency shall be checked at the equipment output terminals when properly loaded with a suitable artificial antenna. Curves or equivalent data shall show the magnitude of each harmonic and other spurious emission that can be detected when the equipment is operated under the conditions specified in § 2.1049 as appropriate. The magnitude of spurious emissions which are attenuated more than 20 dB below the permissible value need not be specified.

#### § 27.53 Emission limits.

(l) 3.7 GHz Service. The following emission limits apply to station transmitting in the 3700-3980 MHz band:

- (1) For base station operations in the 3700-3980 MHz band, the conducted power of any emission outside the licensee's authorized bandwidth shall not exceed -13 dBm/MHz. Compliance with this paragraph (l)(1) is based on the use of measurement instrumentation employing a resolution bandwidth of 1 megahertz or greater. However, in the 1 megahertz bands immediately outside and adjacent to the licensee's frequency block, a resolution bandwidth of at least one percent of the emission bandwidth of the fundamental emission of the transmitter may be employed. The emission bandwidth is defined as the width of the signal between two points, one below the carrier center frequency and one above the carrier center frequency, outside of which all emissions are attenuated at least 26 dB below the transmitter power.

### Test Procedures:

Measurements were in accordance with the test methods section 3.6 of KDB 935210 D05 v01r04.

Spurious emissions shall be measured using a single test signal sequentially tuned to the low, middle, and high channels or frequencies within each authorized frequency band of operation.

Out-of-band/out-of-block emissions (including intermodulation products) shall be measured under each of the following two stimulus conditions:

- a) two adjacent test signals sequentially tuned to the lower and upper frequency band/block edges;
- b) a single test signal, sequentially tuned to the lowest and highest frequencies or channels within the frequency band/block under examination.

NOTE—Single-channel boosters that cannot accommodate two simultaneous signals within the passband may be excluded from the test stipulated in step a).

#### 3.6.2 Out-of-band/out-of-block emissions conducted measurements

- a) Connect a signal generator to the input of the EUT.

If the signal generator is not capable of generating two modulated carriers simultaneously, then two discrete signal generators can be connected with an appropriate combining network to support this two-signal test.

- b) Set the signal generator to produce two AWGN signals as previously described.

- c) Set the center frequencies such that the AWGN signals occupy adjacent channels, as defined by industry standards such as 3GPP or 3GPP2, at the upper edge of the frequency band or block under test.
- d) Set the composite power levels such that the input signal is just below the AGC threshold, but not more than 0.5 dB below. The composite power can be measured using the procedures provided in KDB Publication 971168, but it will be necessary to expand the power integration bandwidth so as to include both of the transmit channels.
- e) Connect a spectrum analyzer to the output of the EUT using appropriate attenuation as necessary.
- f) Set the RBW = reference bandwidth in the applicable rule section for the supported frequency band.
- g) Set the VBW =  $3 \times$  RBW.
- h) Set the detector to power averaging (rms) detector.
- i) Set the Sweep time = auto-couple.
- j) Set the spectrum analyzer start frequency to the upper block edge frequency, and the stop frequency to the upper block edge frequency plus 300 kHz or 3 MHz, for frequencies below and above 1 GHz, respectively.
- k) Trace average at least 100 traces in power averaging (rms) mode.
- l) Use the marker function to find the maximum power level.
- m) Capture the spectrum analyzer trace of the power level for inclusion in the test report.
- n) Repeat steps k) to m) with the composite input power level set to 3 dB above the AGC threshold.
- o) Reset the frequencies of the input signals to the lower edge of the frequency block or band under test.
- p) Reset the spectrum analyzer start frequency to the lower block edge frequency minus 300 kHz or 3 MHz, for frequencies below and above 1 GHz, respectively, and the stop frequency to the lower band or block edge frequency.
- q) Repeat steps k) to n).
- r) Repeat steps a) to q) with the signal generator configured for a single test signal tuned as close as possible to the block edges.
- s) Repeat steps a) to r) with the narrowband test signal.
- t) Repeat steps a) to s) for all authorized frequency bands or blocks used by the EUT.

### 3.6.3 Spurious emissions conducted measurements

- a) Connect a signal generator to the input of the EUT.
- b) Set the signal generator to produce the broadband test signal as previously described.
- c) Set the center frequency of the test signal to the lowest available channel within the frequency band or block.
- d) Set the EUT input power to a level that is just below the AGC threshold, but not more than 0.5 dB below.
- e) Connect a spectrum analyzer to the output of the EUT using appropriate attenuation as necessary.
- f) Set the RBW = reference bandwidth in the applicable rule section for the supported frequency band of operation.
- g) Set the VBW  $\geq 3 \times$  RBW.
- h) Set the Sweep time = auto-couple.
- i) Set the spectrum analyzer start frequency to the lowest RF signal generated in the equipment, without going below 9 kHz, and the stop frequency to the lower band/block edge frequency minus 1 MHz.

The number of measurement points in each sweep must be  $\geq (2 \times \text{span}/\text{RBW})$ , which may require that the measurement range defined by the start and stop frequencies be subdivided, depending on the available number of measurement points provided by the spectrum analyzer.

- j) Select the power averaging (rms) detector function.
- k) Trace average at least 10 traces in power averaging (rms) mode.
- l) Use the peak marker function to identify the highest amplitude level over each measured frequency range. Record the frequency and amplitude and capture a plot for inclusion in the test report.
- m) Reset the spectrum analyzer start frequency to the upper band/block edge frequency plus 1 MHz, and the spectrum analyzer stop frequency to 10 times the highest frequency of the fundamental emission. The number of measurement points in each sweep must be  $\geq (2 \times \text{span}/\text{RBW})$ , which may require that the measurement range defined by the start and stop frequencies be subdivided, depending on the available number of measurement points provided by the spectrum analyzer.
- n) Trace average at least 10 traces in power averaging (rms) mode.
- o) Use the peak marker function to identify the highest amplitude level over each of the measured frequency ranges. Record the frequency and amplitude and capture a plot for inclusion in the test report; also provide tabular data, if required.
- p) Repeat steps i) to o) with the input test signals firstly tuned to a middle band/block frequency/channel, and then tuned to a high band/block frequency/channel.
- q) Repeat steps b) to p) with the narrowband test signal.
- r) Repeat steps b) to q) for all authorized frequency bands/blocks used by the EUT.

**Note:**

(1) In some bands, RBW was reduced to 0.1 %, 1 %, and 10 % of the reference bandwidth for measuring out-of-band and unwanted spurious emissions level, so the limit lines were compensated according to section 5.7.2 of ANSI C63.26-2015.

Reduced RBW	0.1 %	1 %	10 %
Limit line compensation	-30 dB	-20 dB	-10 dB

(2) All power supplies of operation were investigated and the worst case configuration results are reported.

- Mode: 100~240 VAC, 50/60 Hz /  $\pm 36 \text{ V} \sim \pm 76 \text{ VDC}$
- Worst case: 100~240 VAC, 50/60 Hz

**Test Results: Plot data of Out-of-band/out-of-block emissions**

Out-of-band (two adjacent test signals) / C-Band / Downlink / 5G NR 20 MHz / Lower

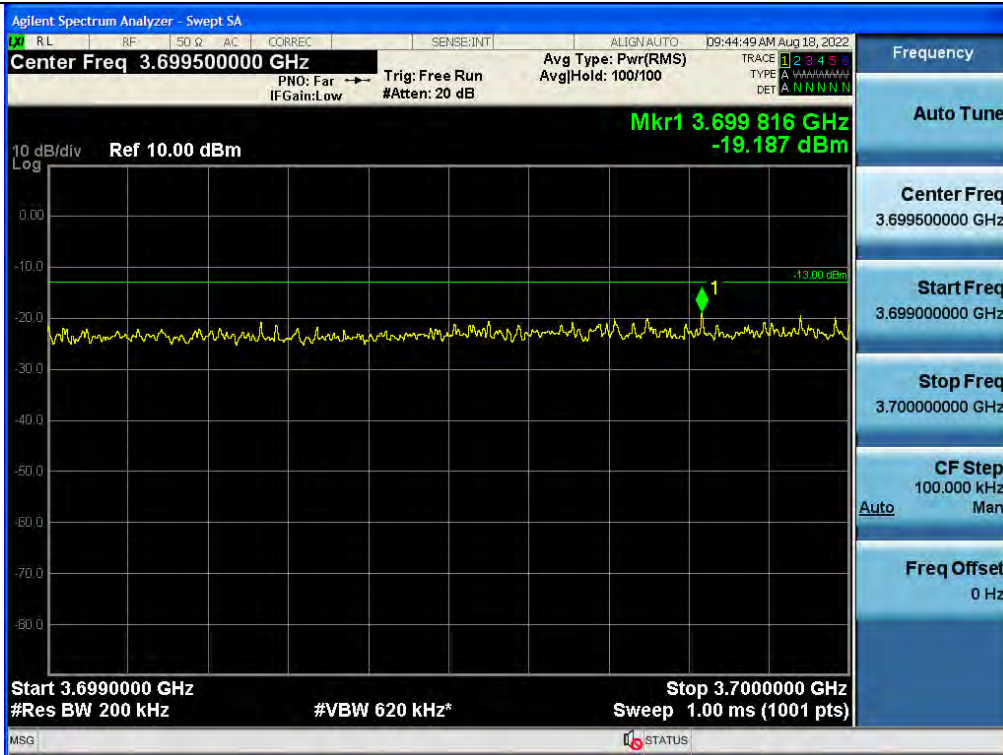

Out-of-band (two adjacent test signals) / C-Band / Downlink / 5G NR 20 MHz / Upper

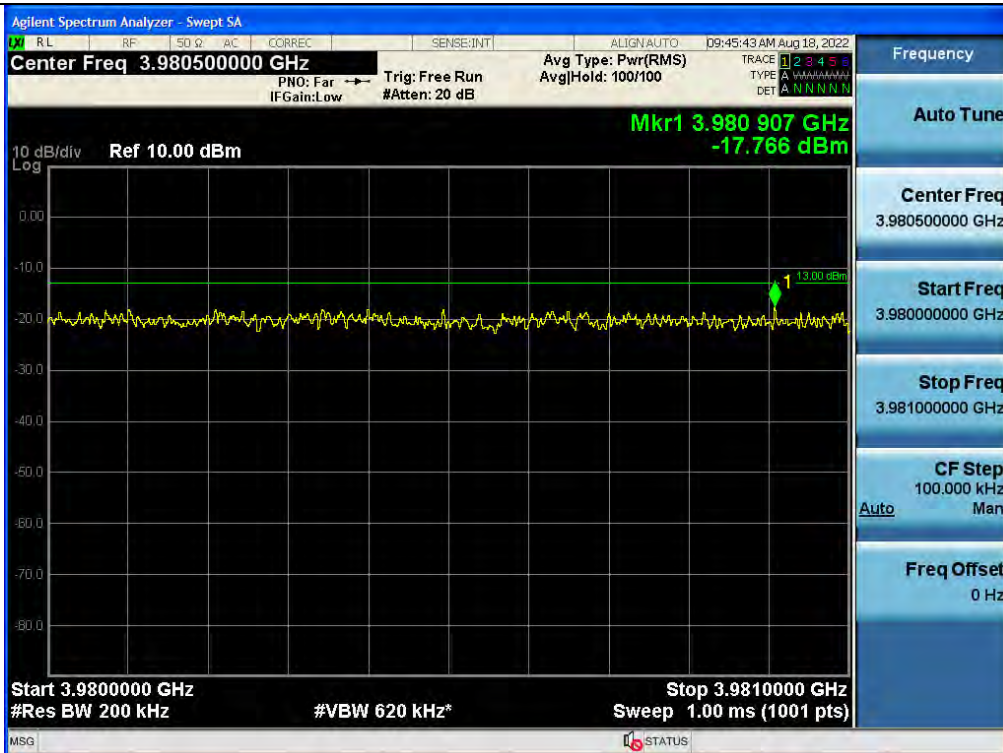

+3 dB above Out-of-band (two adjacent test signals) / C-Band / Downlink / 5G NR 20 MHz / Lower

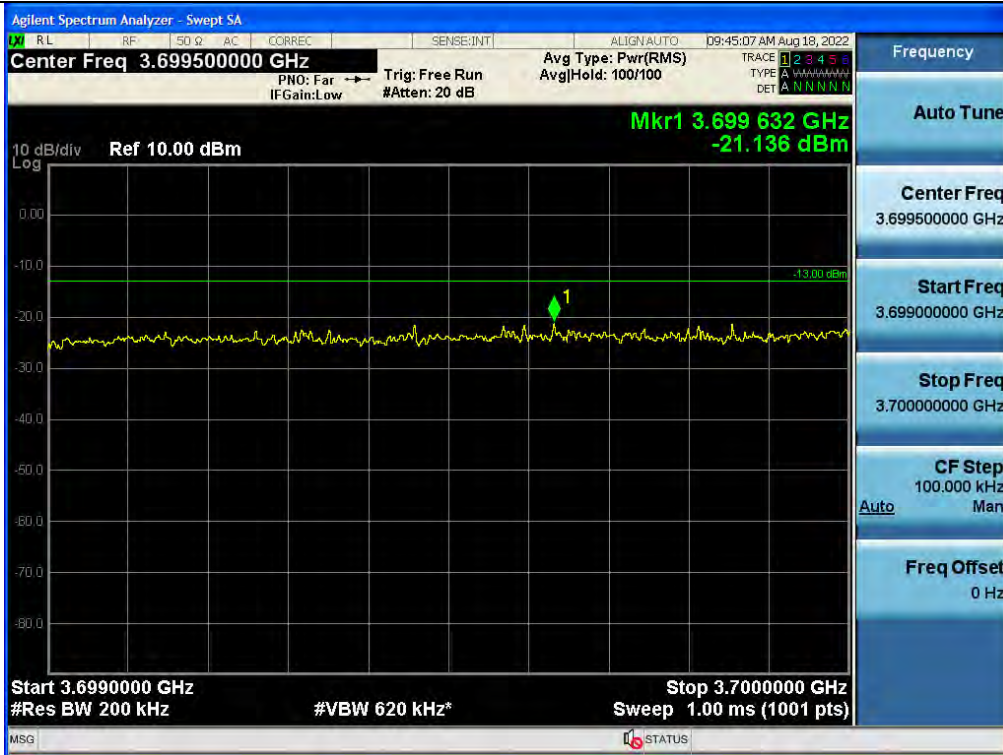

+3 dB above Out-of-band (two adjacent test signals) / C-Band / Downlink / 5G NR 20 MHz / Upper

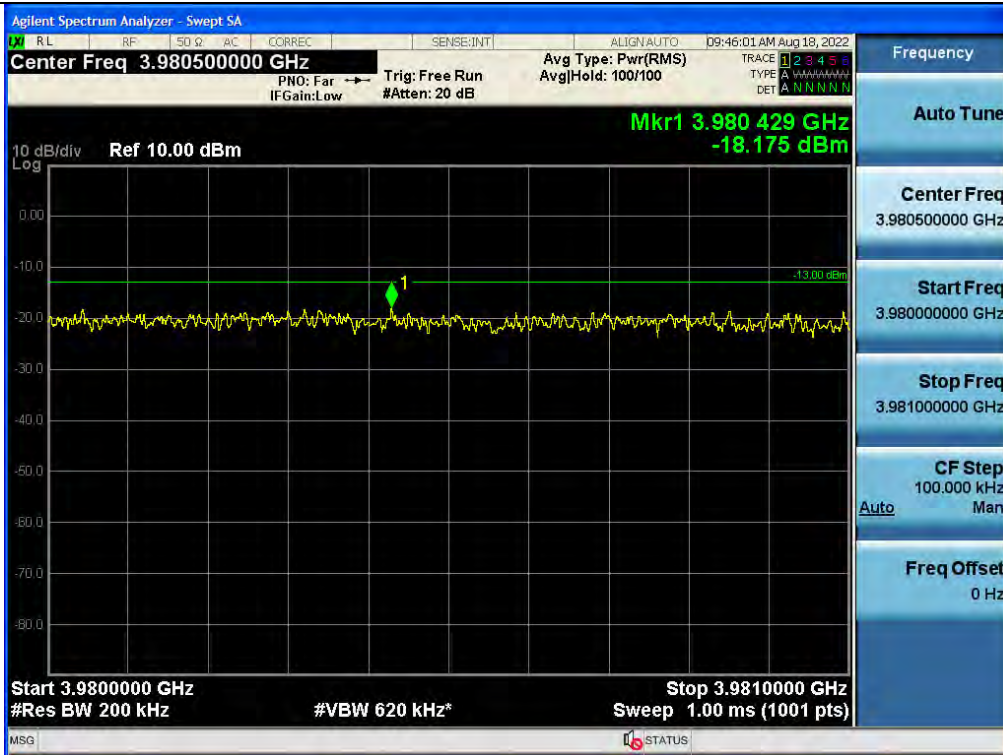



Out-of-band (two adjacent test signals) / C-Band / Downlink / 5G NR 40 MHz / Lower

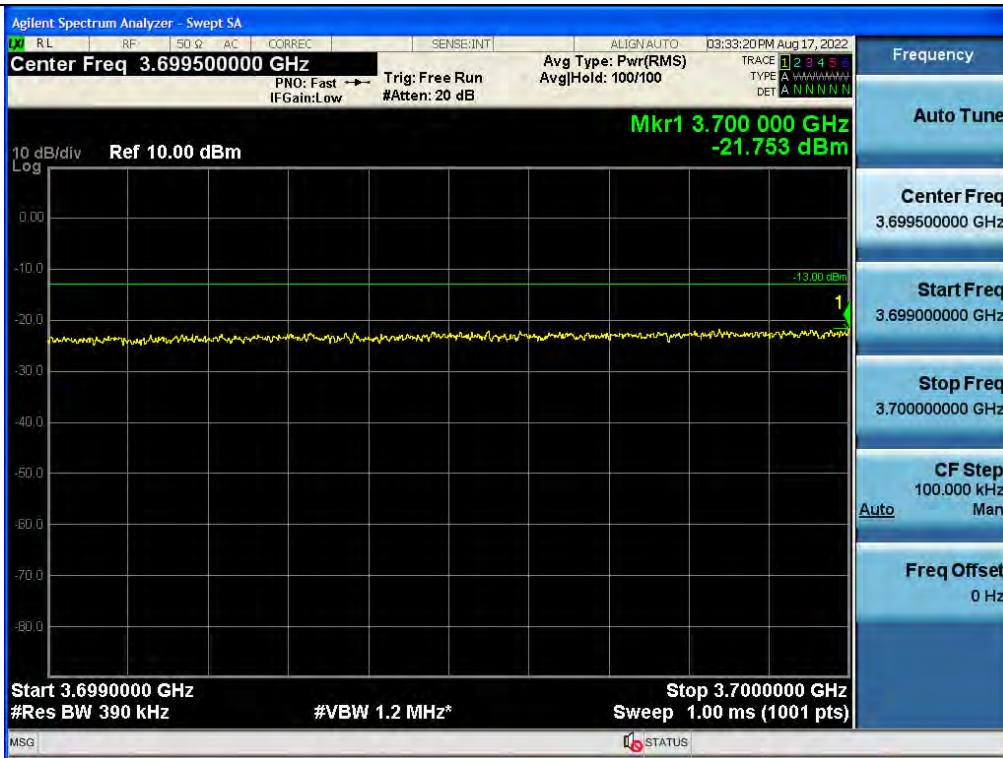

Out-of-band (two adjacent test signals) / C-Band / Downlink / 5G NR 40 MHz / Upper



+3 dB above Out-of-band (two adjacent test signals) / C-Band / Downlink / 5G NR 40 MHz / Lower

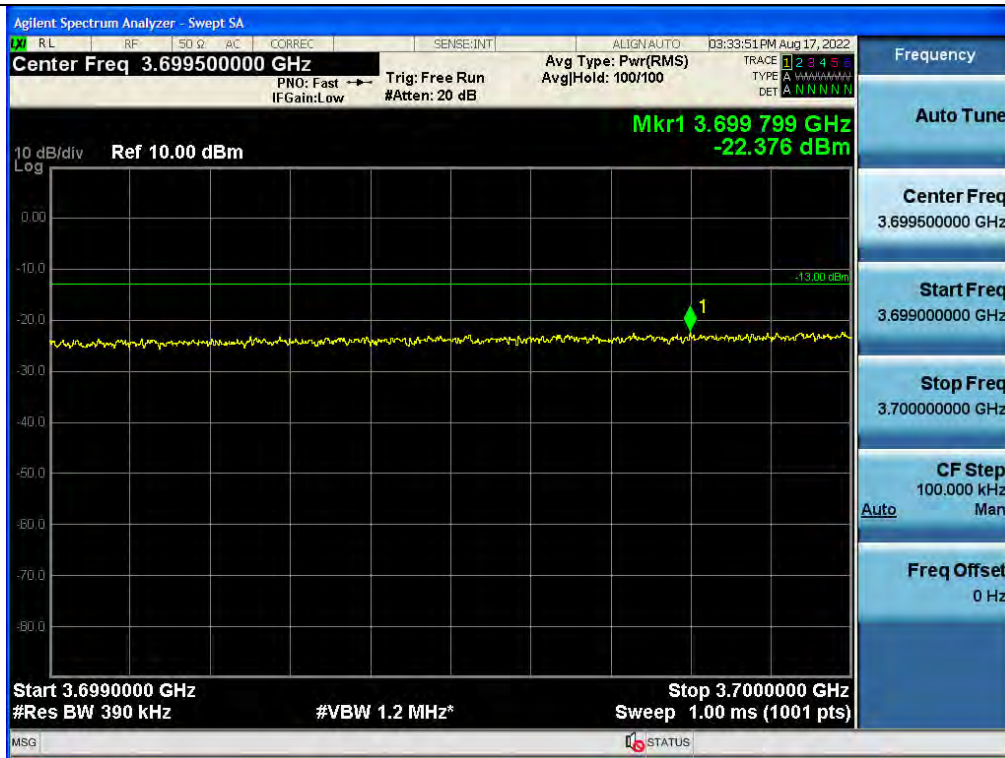

+3 dB above Out-of-band (two adjacent test signals) / C-Band / Downlink / 5G NR 40 MHz / Upper



Out-of-band (two adjacent test signals) / C-Band / Downlink / 5G NR 60 MHz / Lower

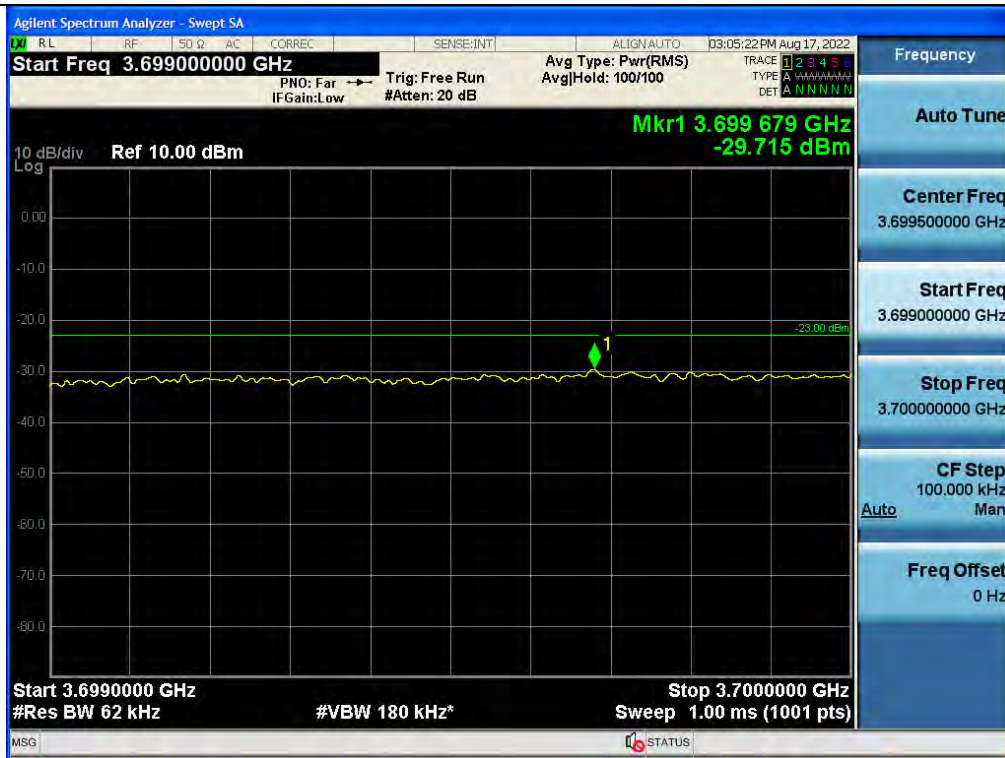

Out-of-band (two adjacent test signals) / C-Band / Downlink / 5G NR 60 MHz / Upper



+3 dB above Out-of-band (two adjacent test signals) / C-Band / Downlink / 5G NR 60 MHz / Lower

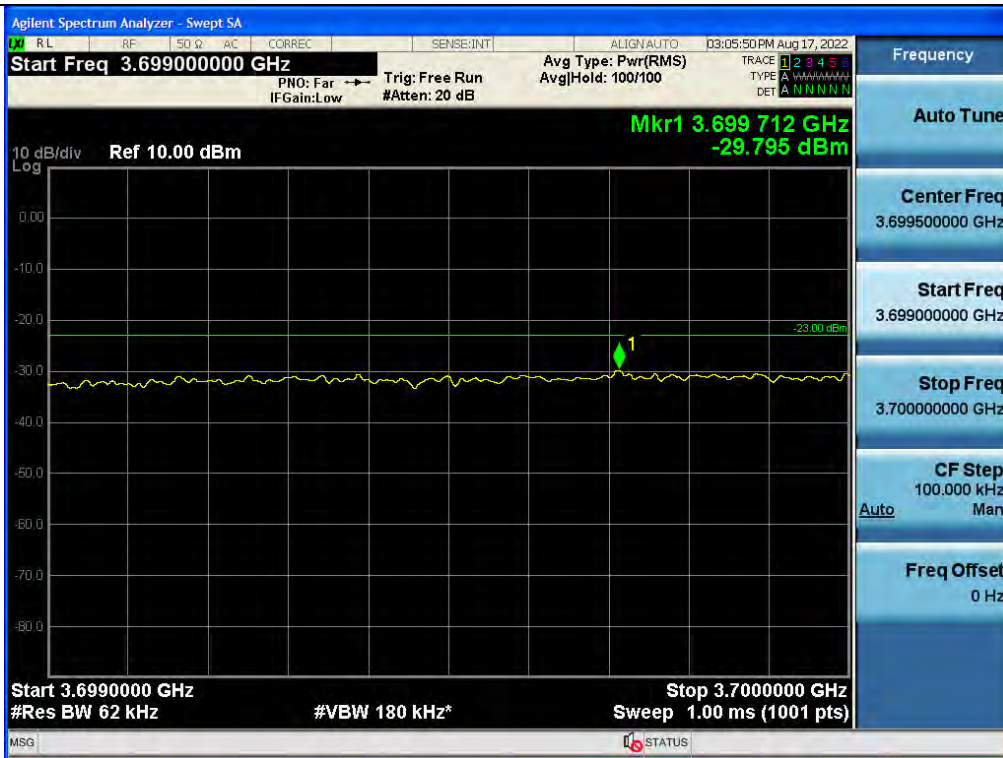

+3 dB above Out-of-band (two adjacent test signals) / C-Band / Downlink / 5G NR 60 MHz / Upper

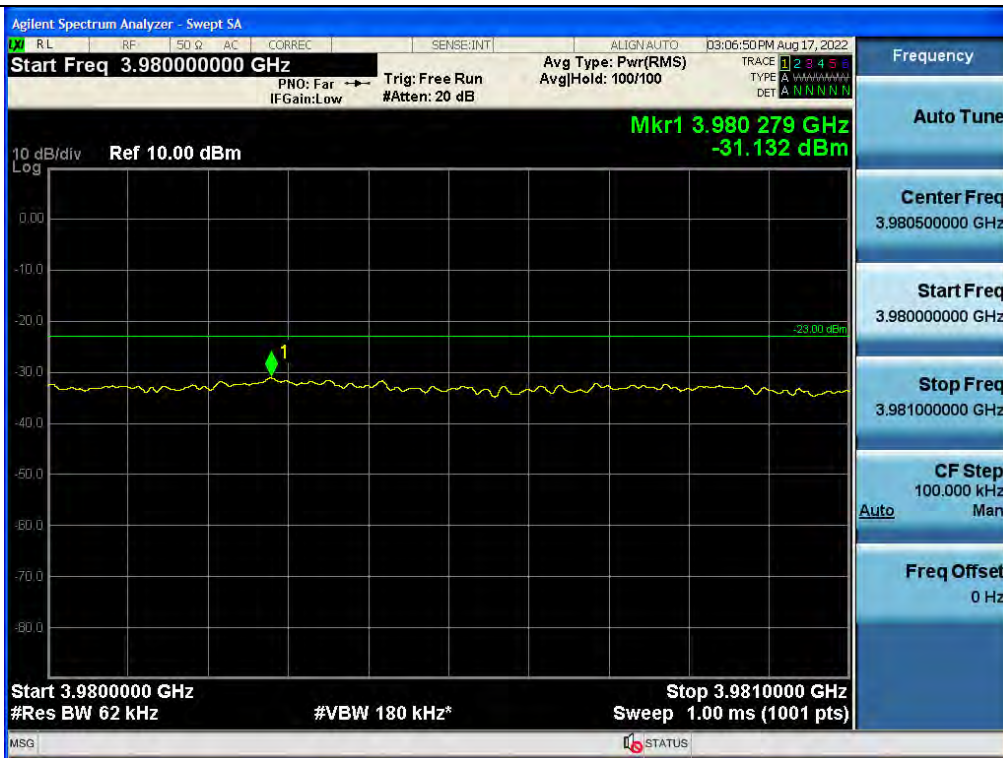

Out-of-band (two adjacent test signals) / C-Band / Downlink / 5G NR 80 MHz / Lower

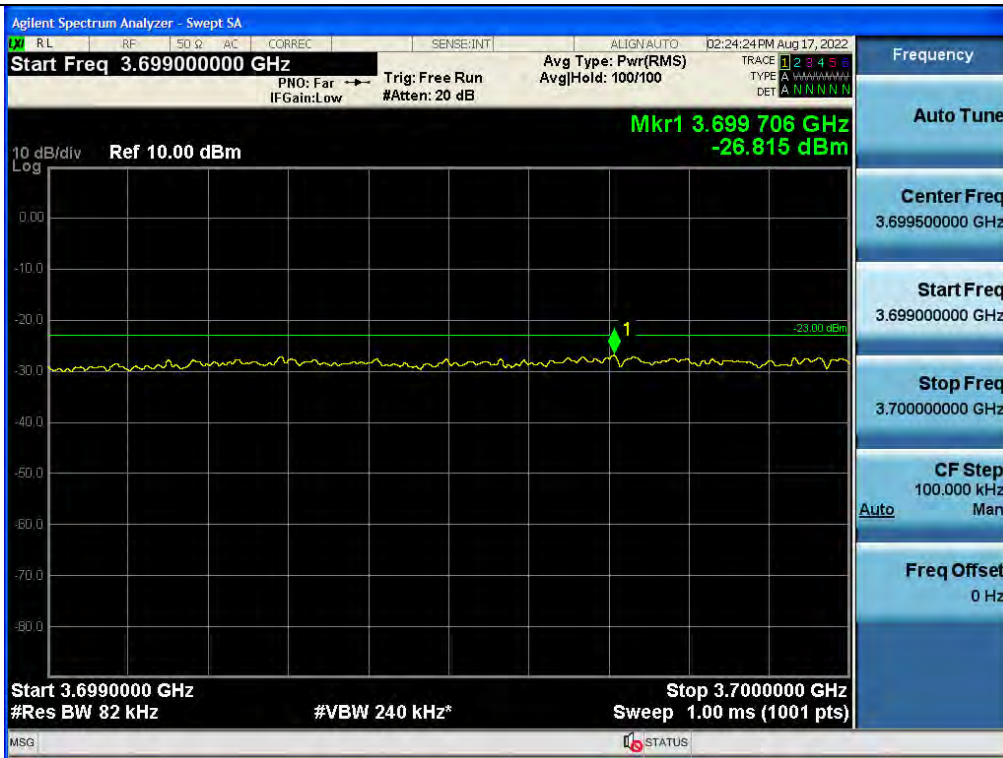

Out-of-band (two adjacent test signals) / C-Band / Downlink / 5G NR 80 MHz / Upper

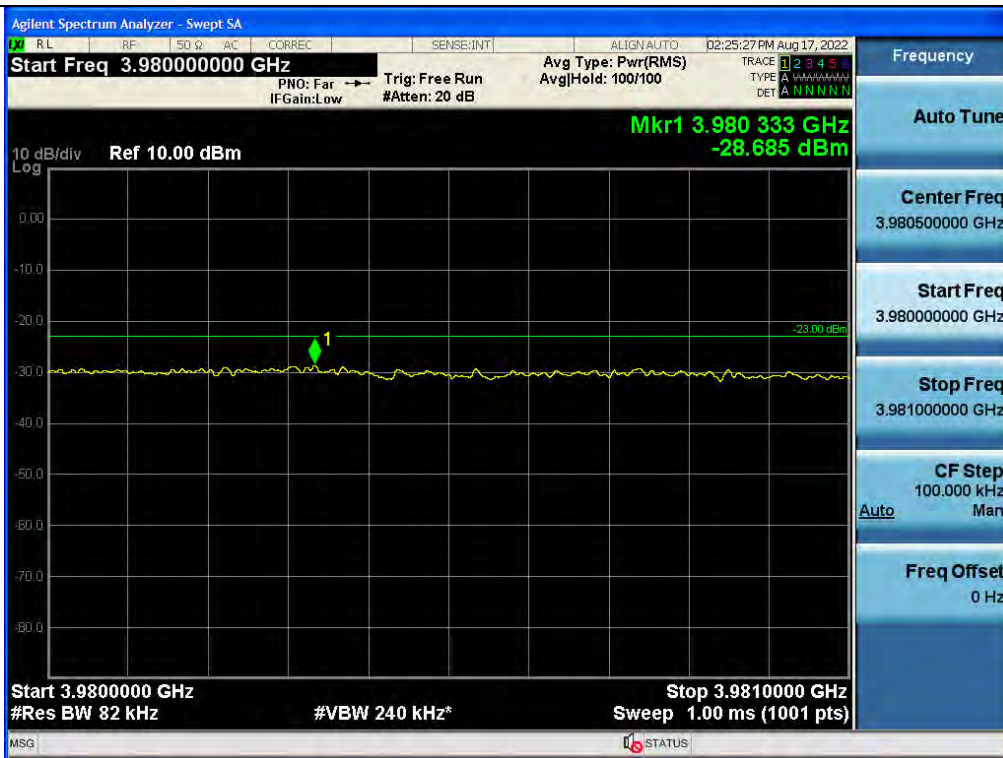

+3 dB above Out-of-band (two adjacent test signals) / C-Band / Downlink / 5G NR 80 MHz / Lower

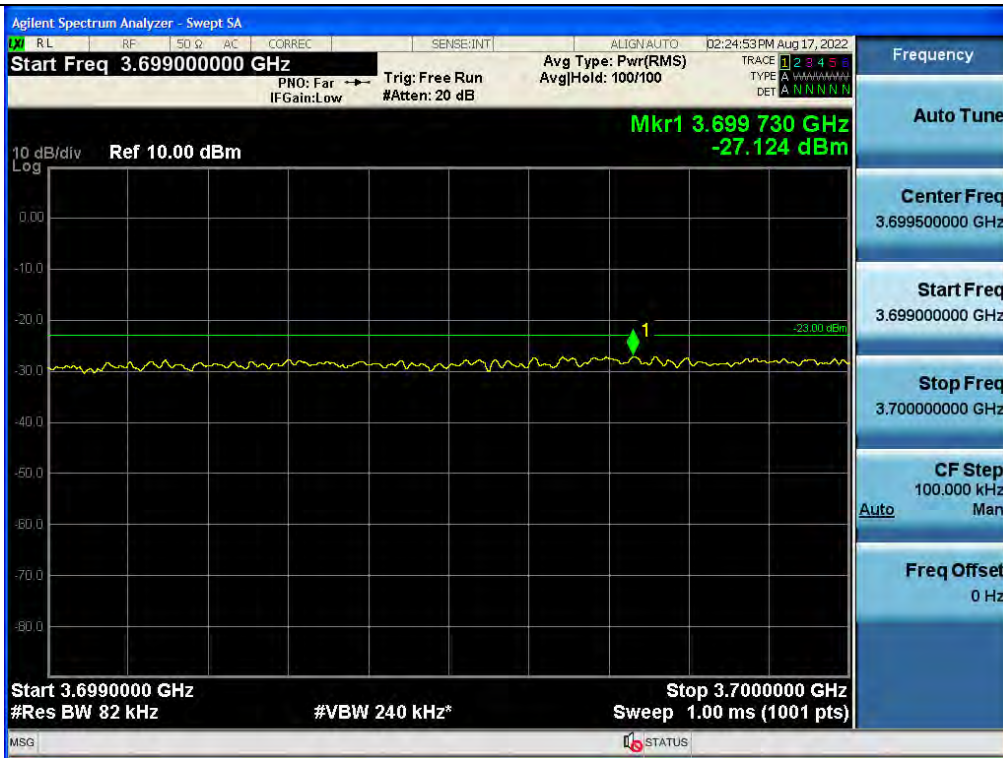

+3 dB above Out-of-band (two adjacent test signals) / C-Band / Downlink / 5G NR 80 MHz / Upper

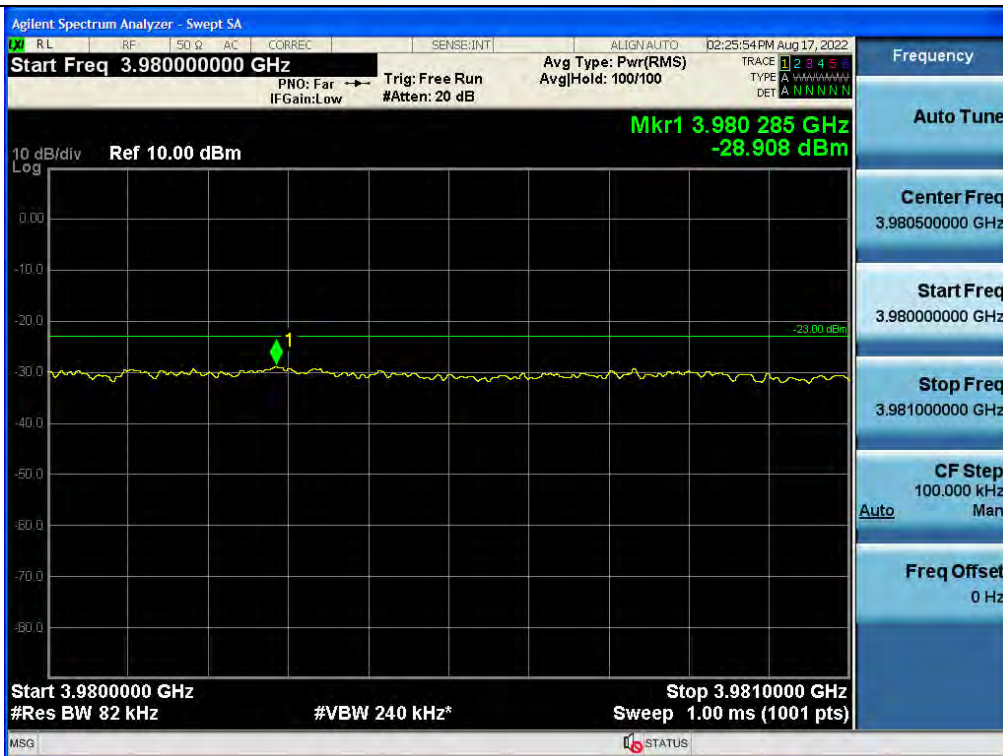

Out-of-band (two adjacent test signals) / C-Band / Downlink / 5G NR 100 MHz / Lower

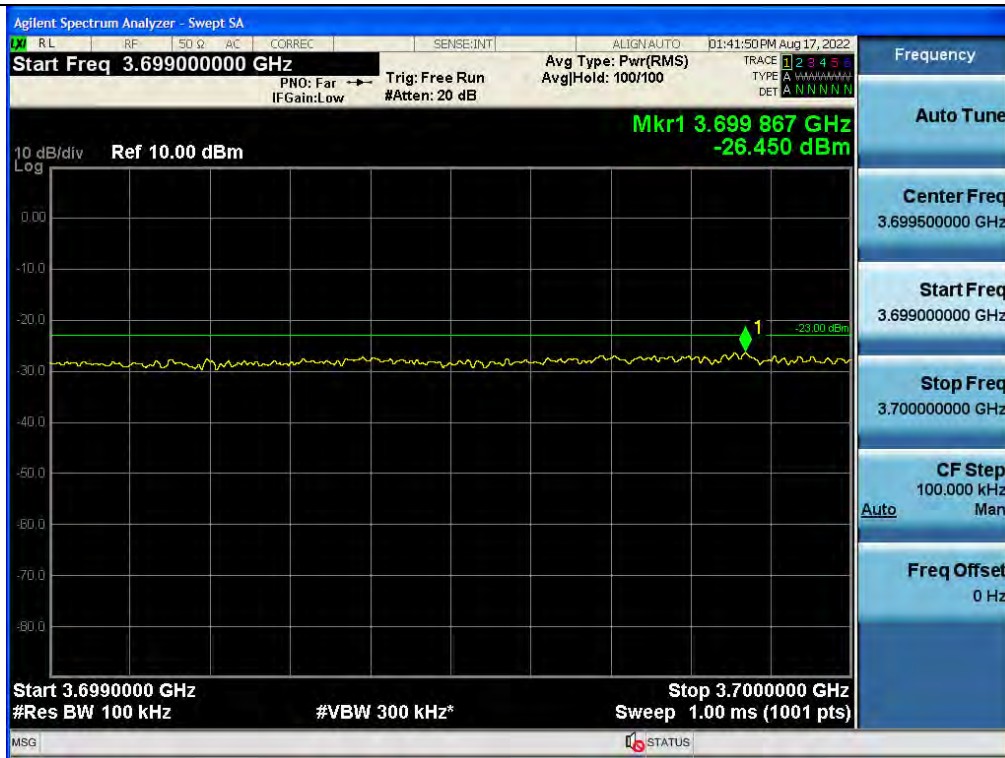

Out-of-band (two adjacent test signals) / C-Band / Downlink / 5G NR 100 MHz / Upper

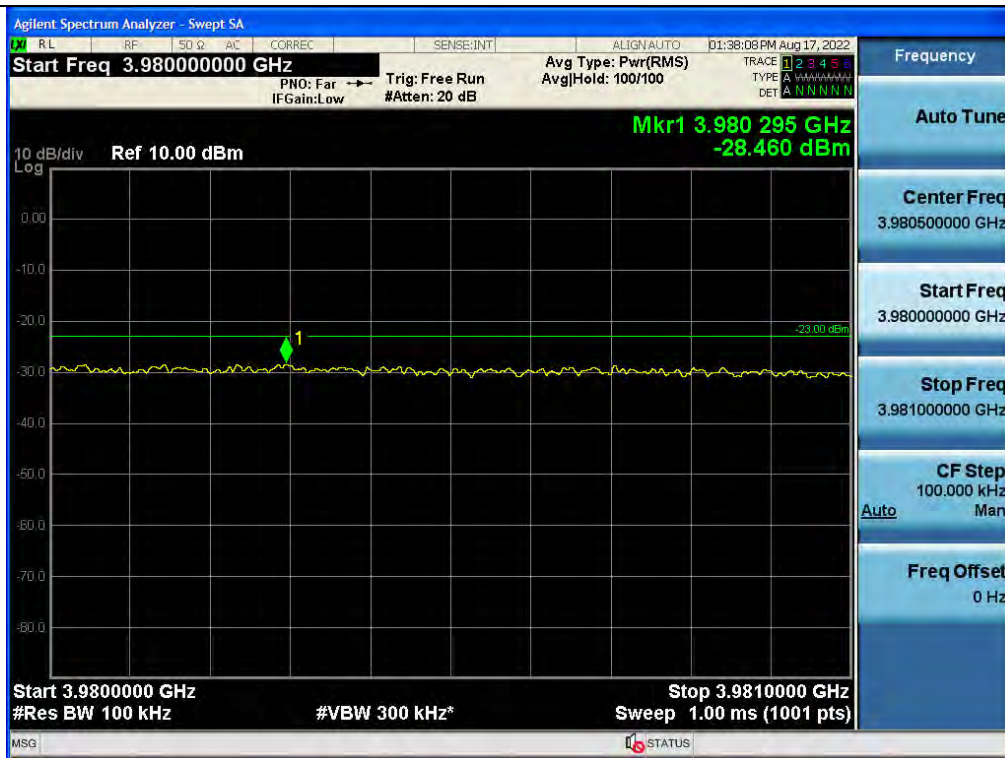

+3 dB above Out-of-band (two adjacent test signals) / C-Band / Downlink / 5G NR 100 MHz / Lower

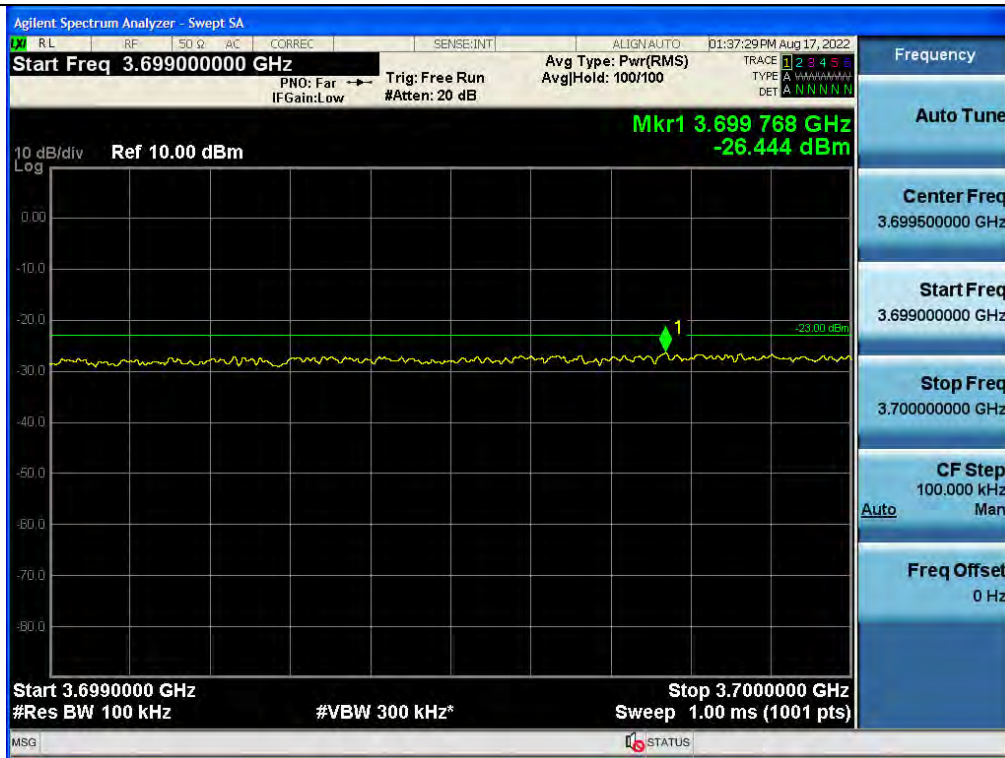

+3 dB above Out-of-band (two adjacent test signals) / C-Band / Downlink / 5G NR 100 MHz / Upper





Out-of-band (single test signal) / C-Band / Downlink / 5G NR 20 MHz / Lower

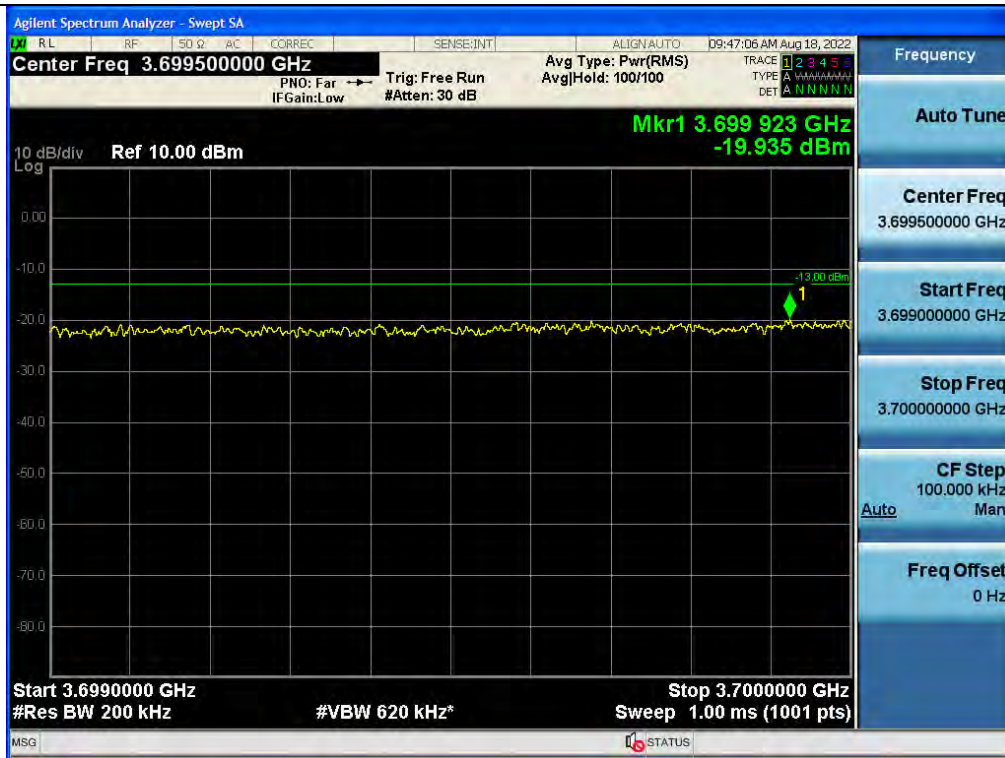

Out-of-band (single test signal) / C-Band / Downlink / 5G NR 20 MHz / Upper



+3 dB above Out-of-band (single test signal) / C-Band / Downlink / 5G NR 20 MHz / Lower

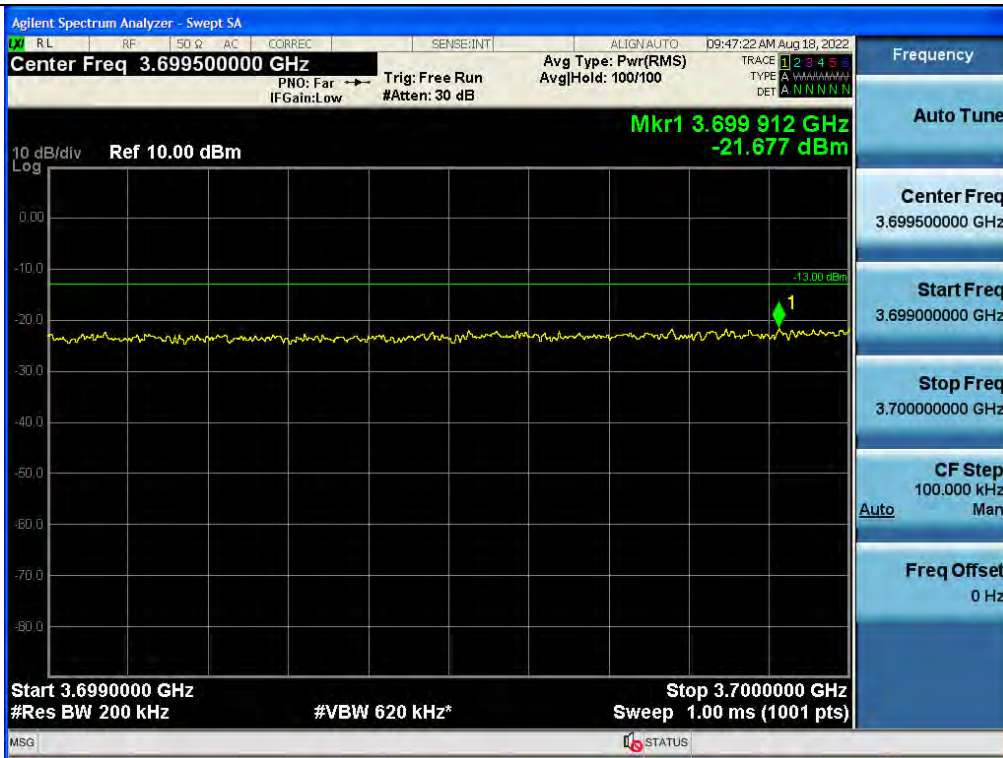

+3 dB above Out-of-band (single test signal) / C-Band / Downlink / 5G NR 20 MHz / Upper



Out-of-band (single test signal) / C-Band / Downlink / 5G NR 40 MHz / Lower

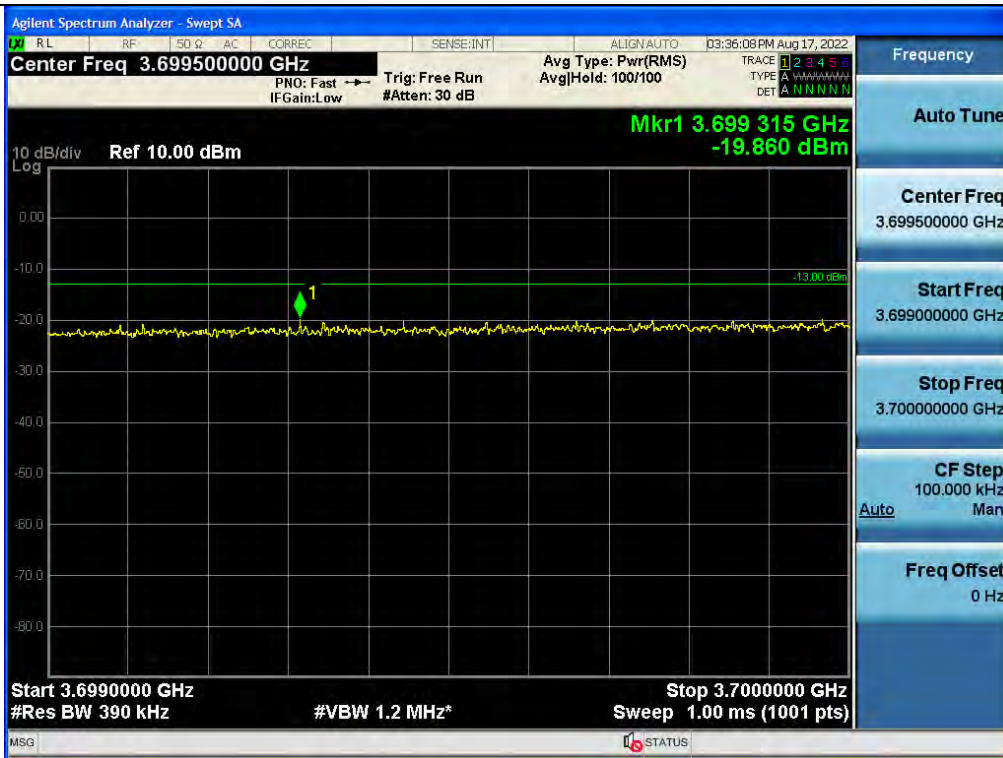

Out-of-band (single test signal) / C-Band / Downlink / 5G NR 40 MHz / Upper

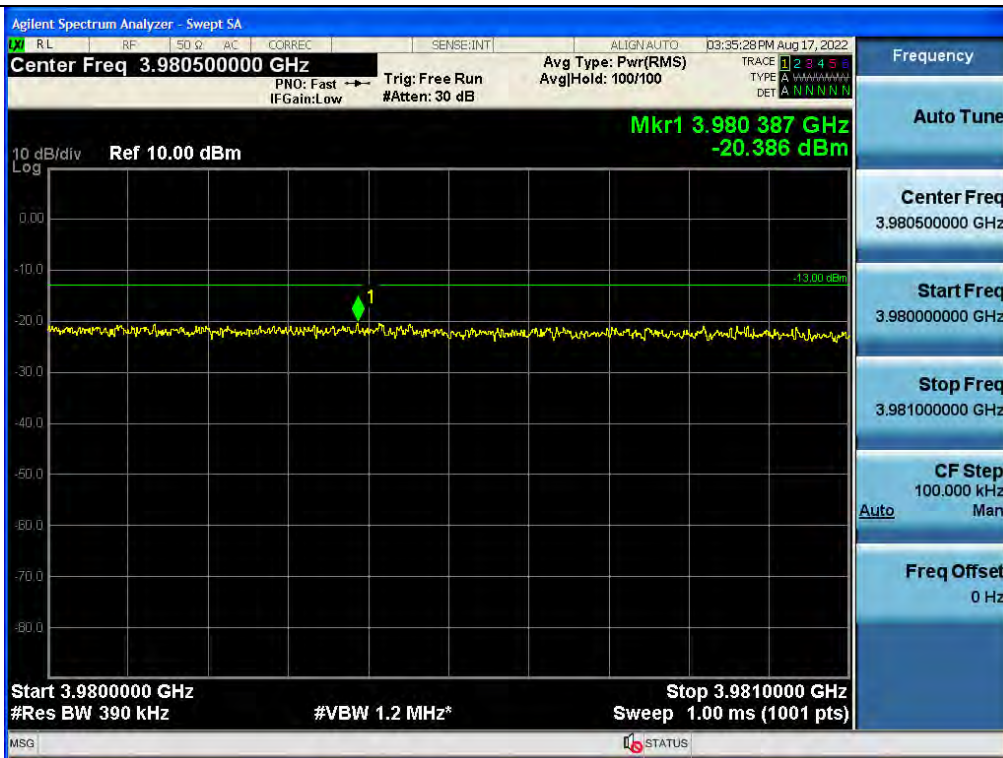

+3 dB above Out-of-band (single test signal) / C-Band / Downlink / 5G NR 40 MHz / Lower

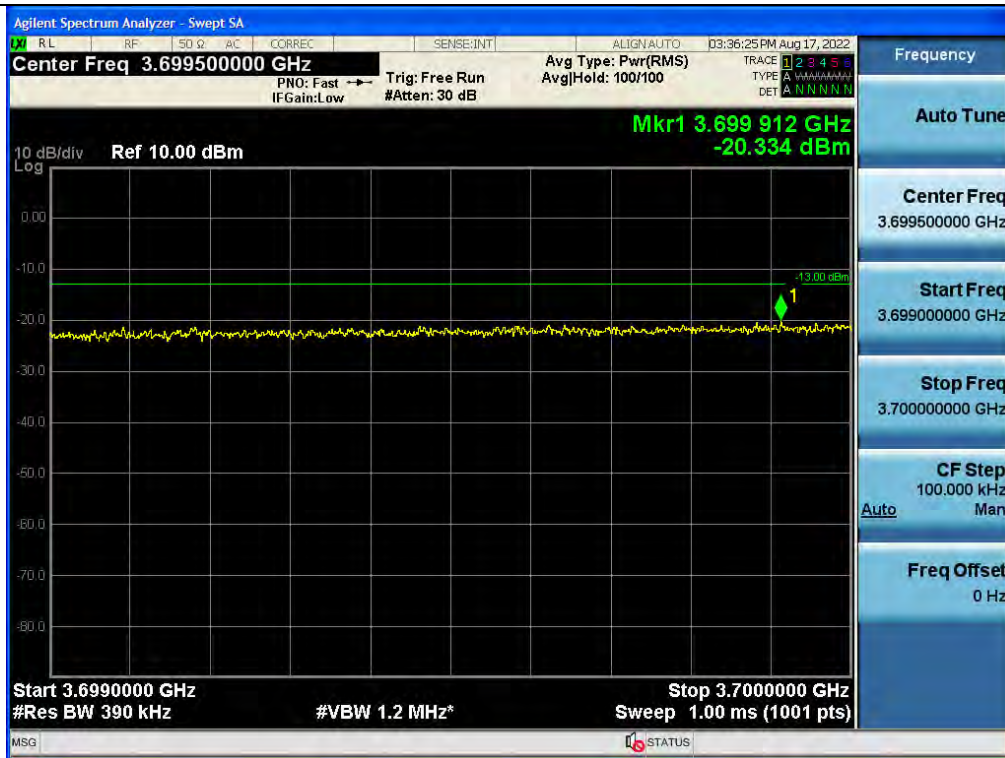

+3 dB above Out-of-band (single test signal) / C-Band / Downlink / 5G NR 40 MHz / Upper



Out-of-band (single test signal) / C-Band / Downlink / 5G NR 60 MHz / Lower



Out-of-band (single test signal) / C-Band / Downlink / 5G NR 60 MHz / Upper



+3 dB above Out-of-band (single test signal) / C-Band / Downlink / 5G NR 60 MHz / Lower

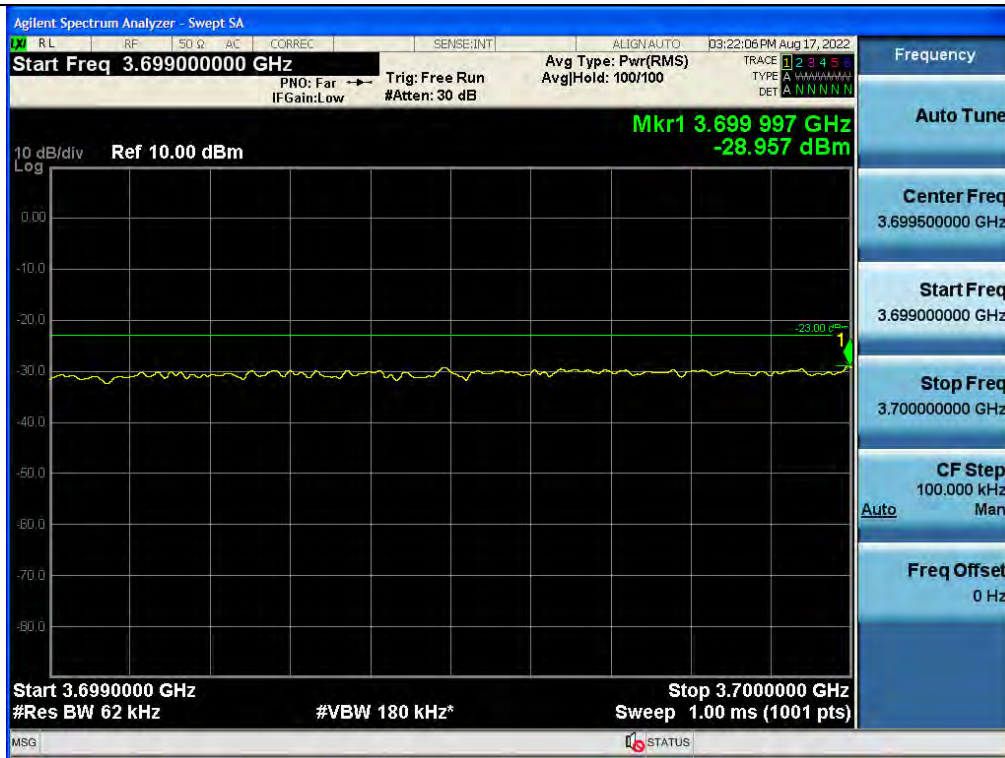

+3 dB above Out-of-band (single test signal) / C-Band / Downlink / 5G NR 60 MHz / Upper



Out-of-band (single test signal) / C-Band / Downlink / 5G NR 80 MHz / Lower

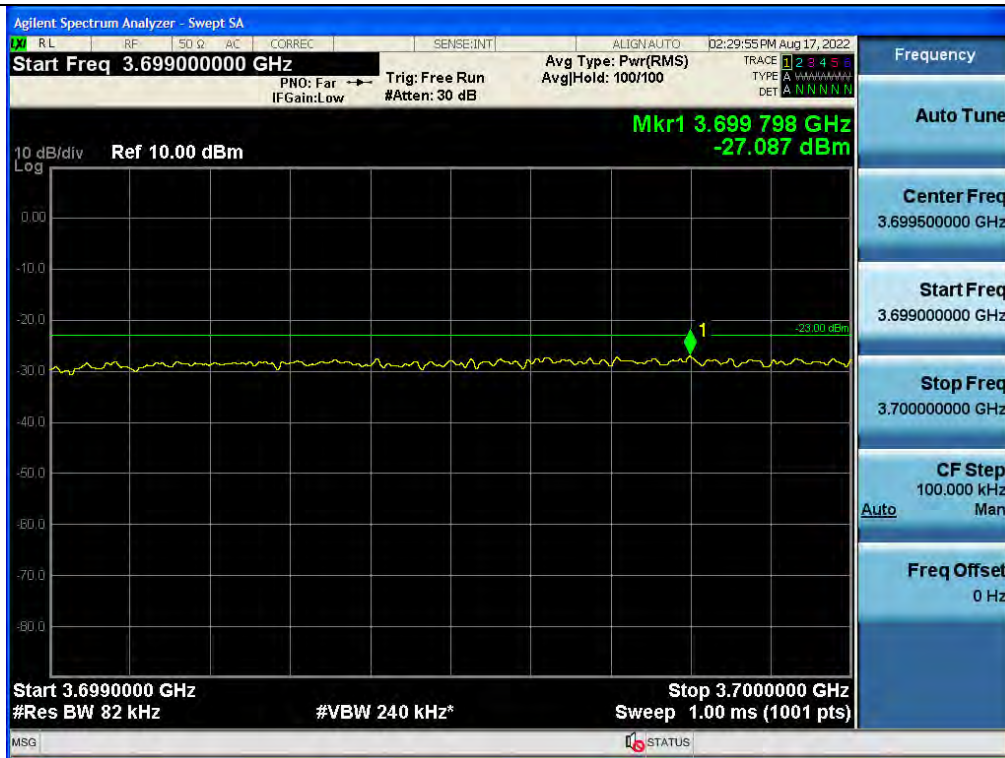

Out-of-band (single test signal) / C-Band / Downlink / 5G NR 80 MHz / Upper

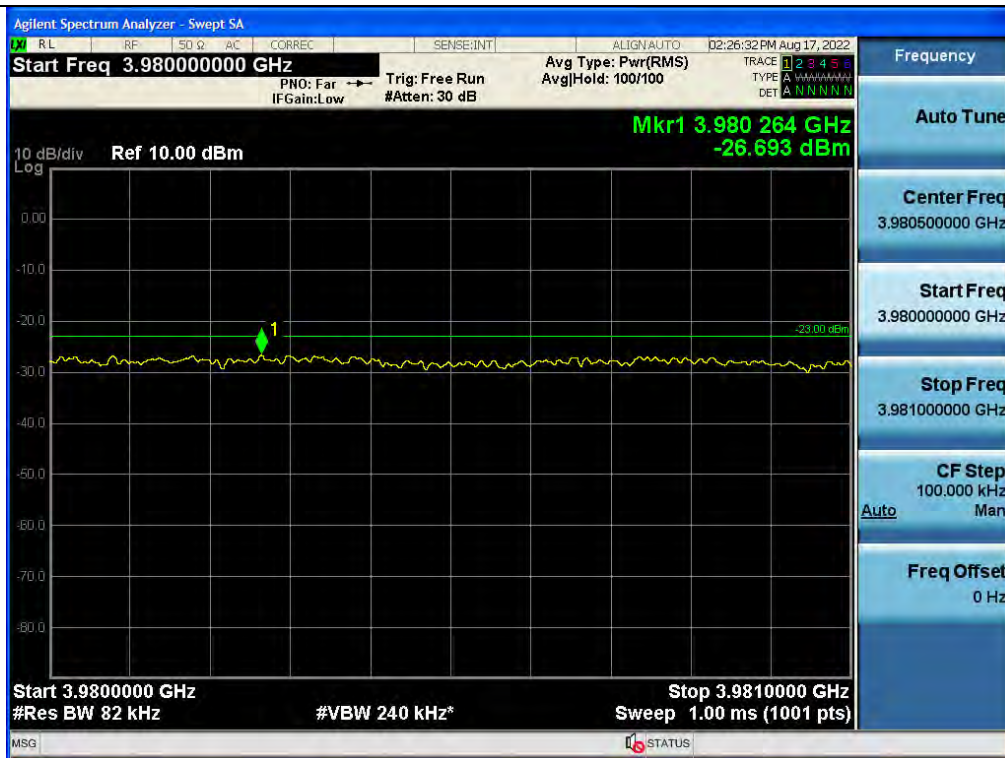

+3 dB above Out-of-band (single test signal) / C-Band / Downlink / 5G NR 80 MHz / Lower

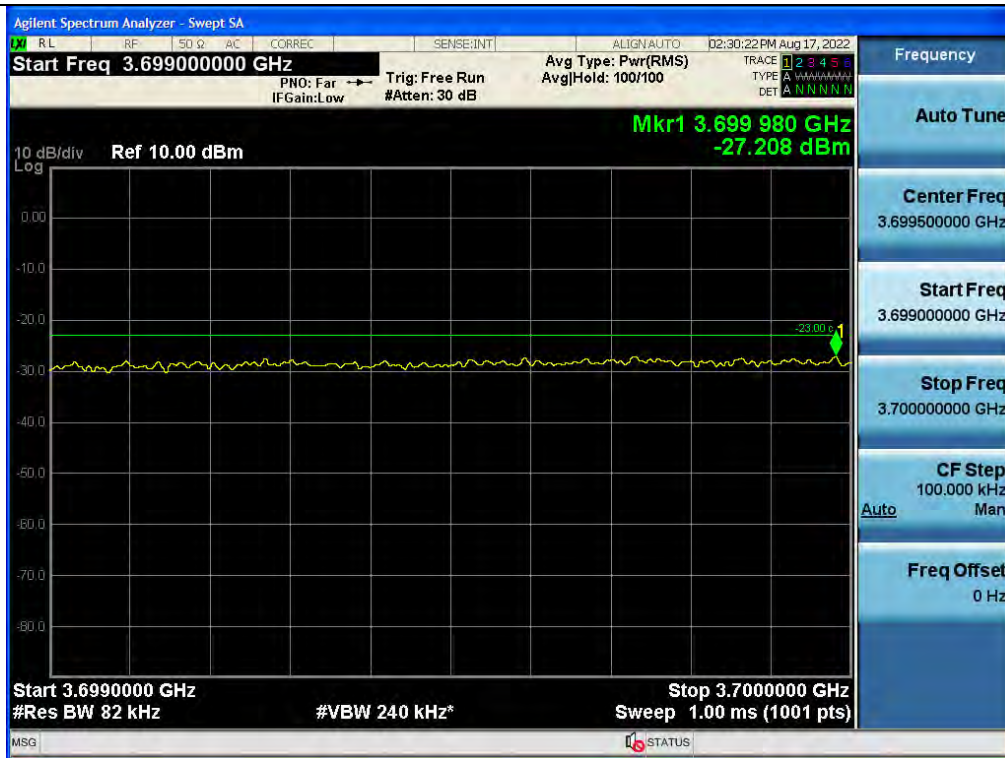

+3 dB above Out-of-band (single test signal) / C-Band / Downlink / 5G NR 80 MHz / Upper





Out-of-band (single test signal) / C-Band / Downlink / 5G NR 100 MHz / Lower

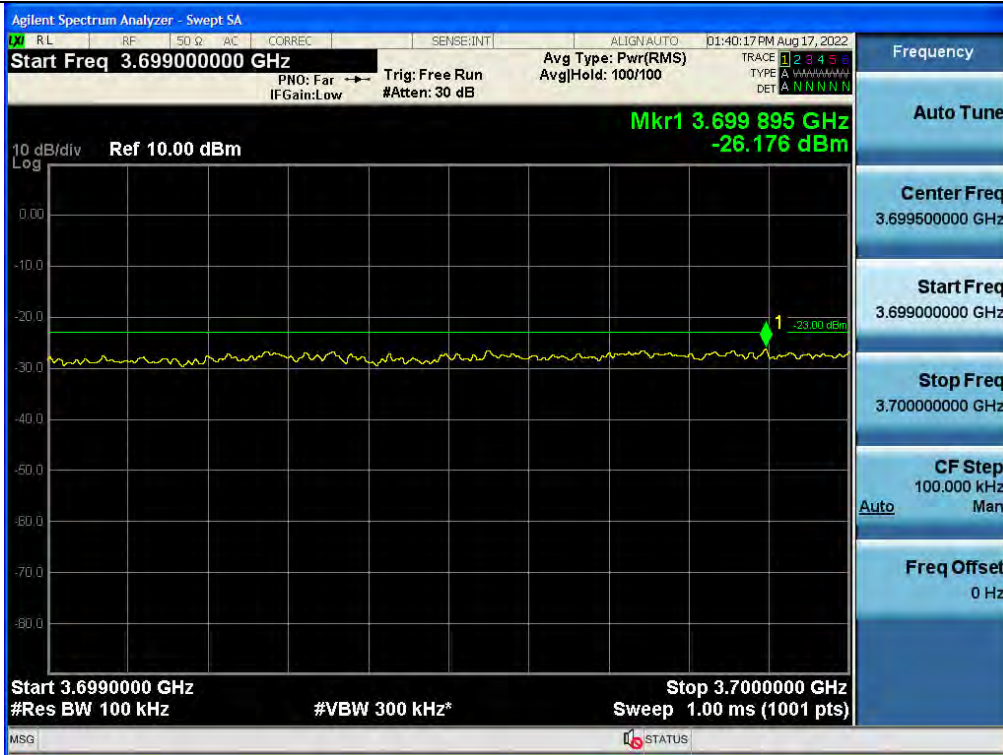

Out-of-band (single test signal) / C-Band / Downlink / 5G NR 100 MHz / Upper

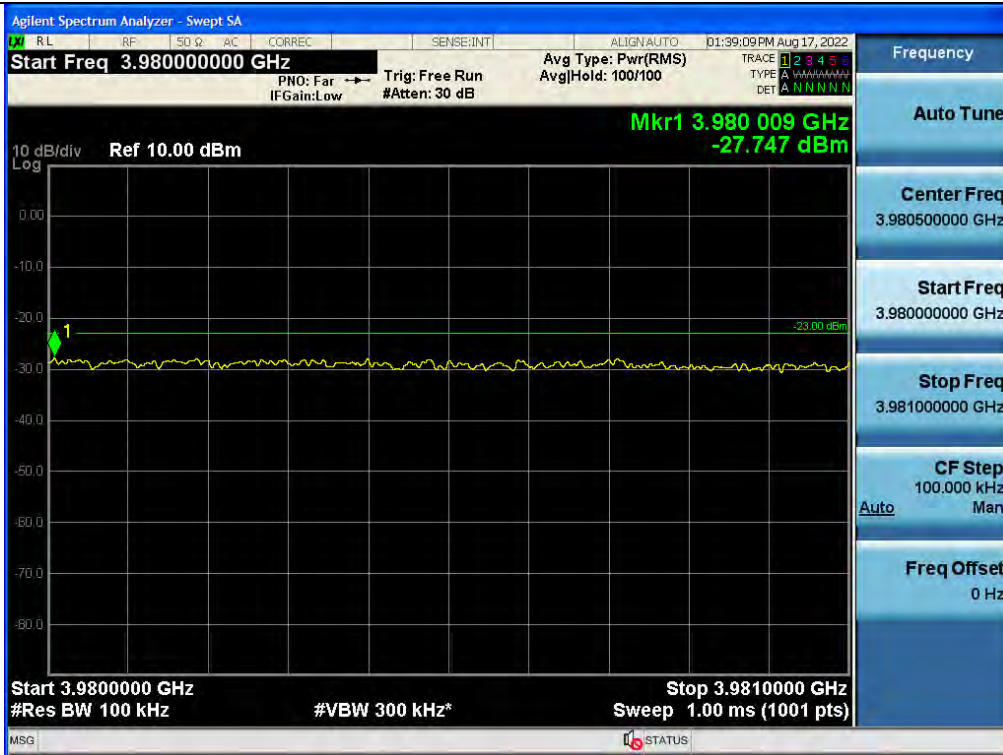

+3 dB above Out-of-band (single test signal) / C-Band / Downlink / 5G NR 100 MHz / Lower

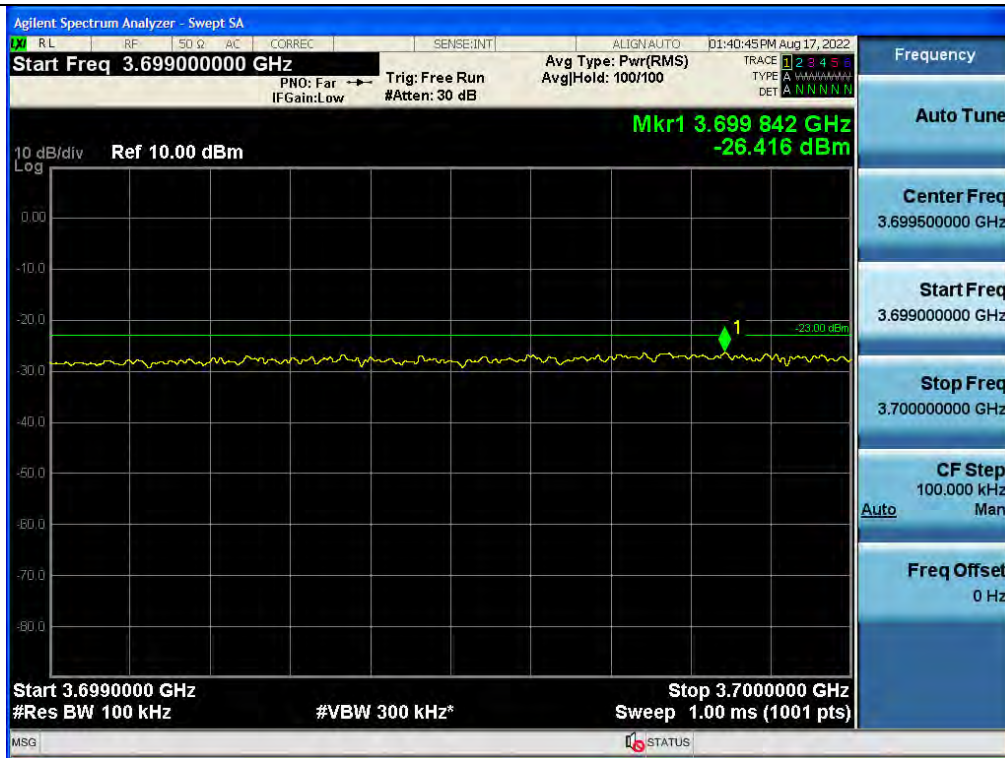

+3 dB above Out-of-band (single test signal) / C-Band / Downlink / 5G NR 100 MHz / Upper

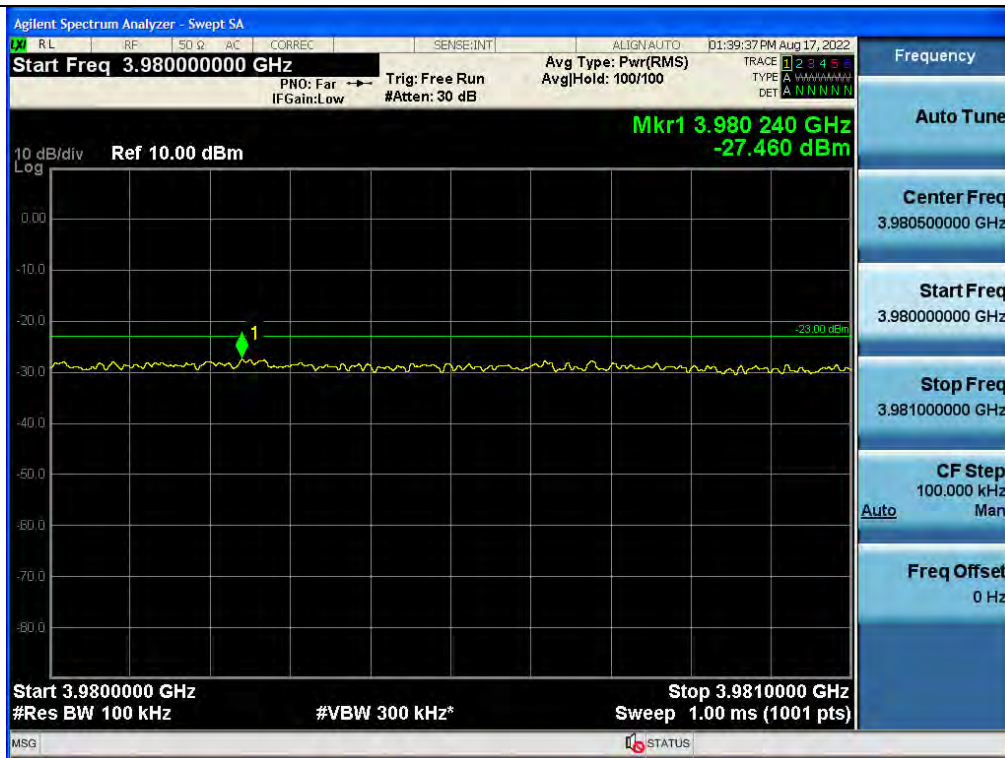

Plot data of Spurious Emissions

Spurious / C-Band / Downlink / 5G NR 20 MHz / Middle / 9 kHz ~ 150 kHz

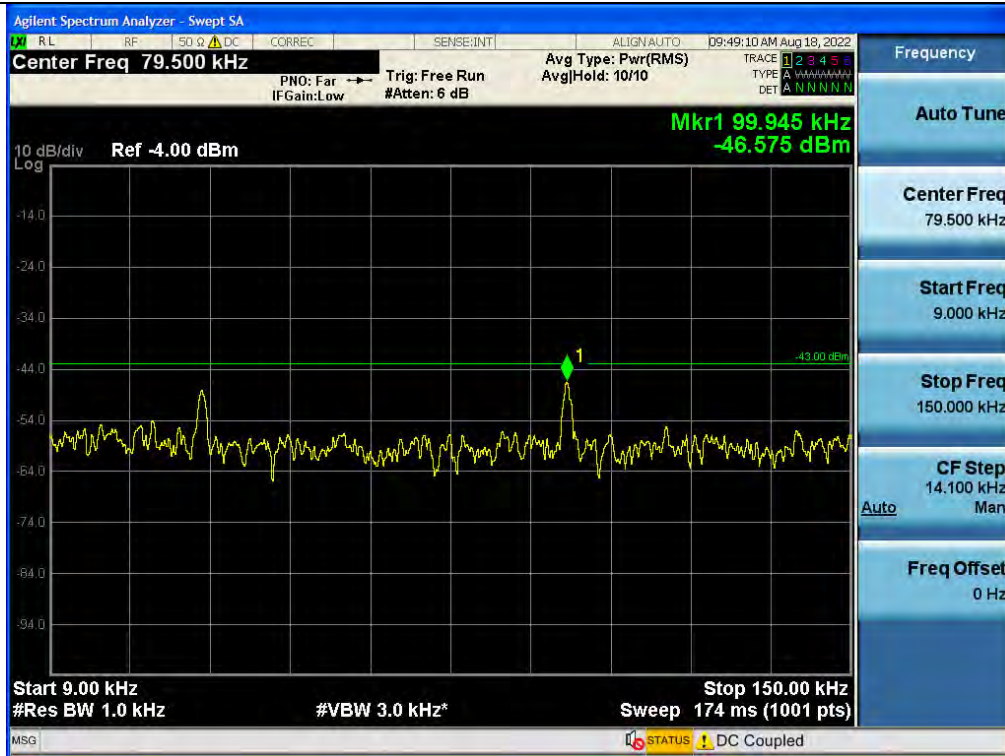

Spurious / C-Band / Downlink / 5G NR 20 MHz / Middle / 150 kHz ~ 30 MHz

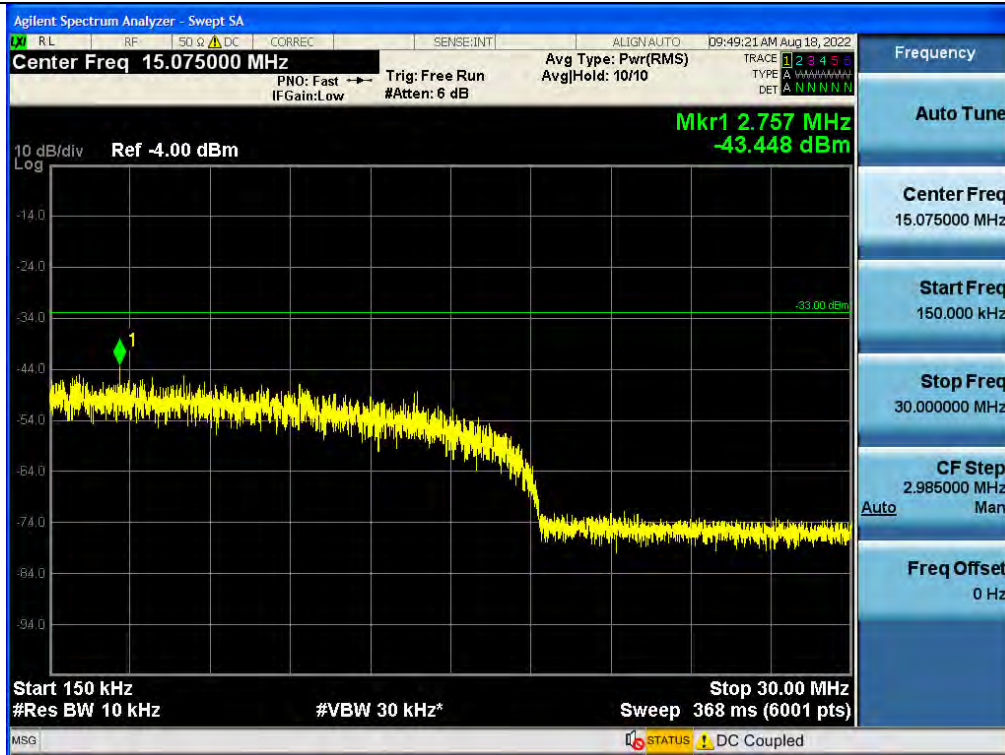

Spurious / C-Band / Downlink / 5G NR 80 MHz / Low / 30 MHz ~ Low Edge - 10 MHz

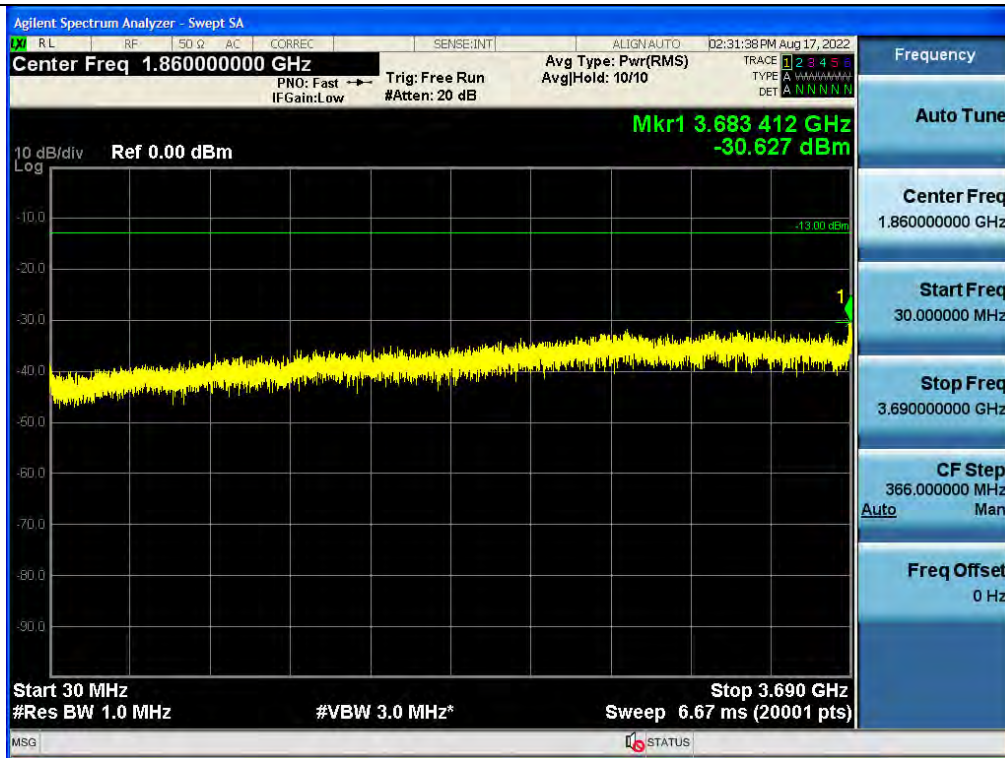

Spurious / C-Band / Downlink / 5G NR 20 MHz / Low / Low Edge - 10 MHz ~ Low Edge

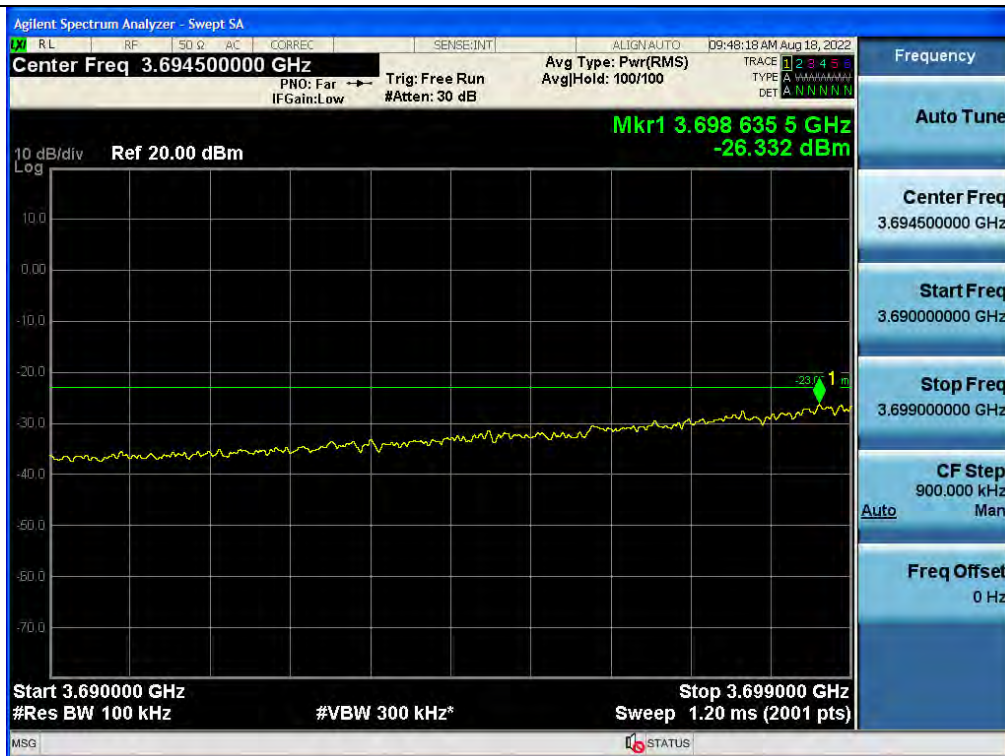

Spurious / C-Band / Downlink / 5G NR 20 MHz / High / High Edge ~ High Edge + 10 MHz

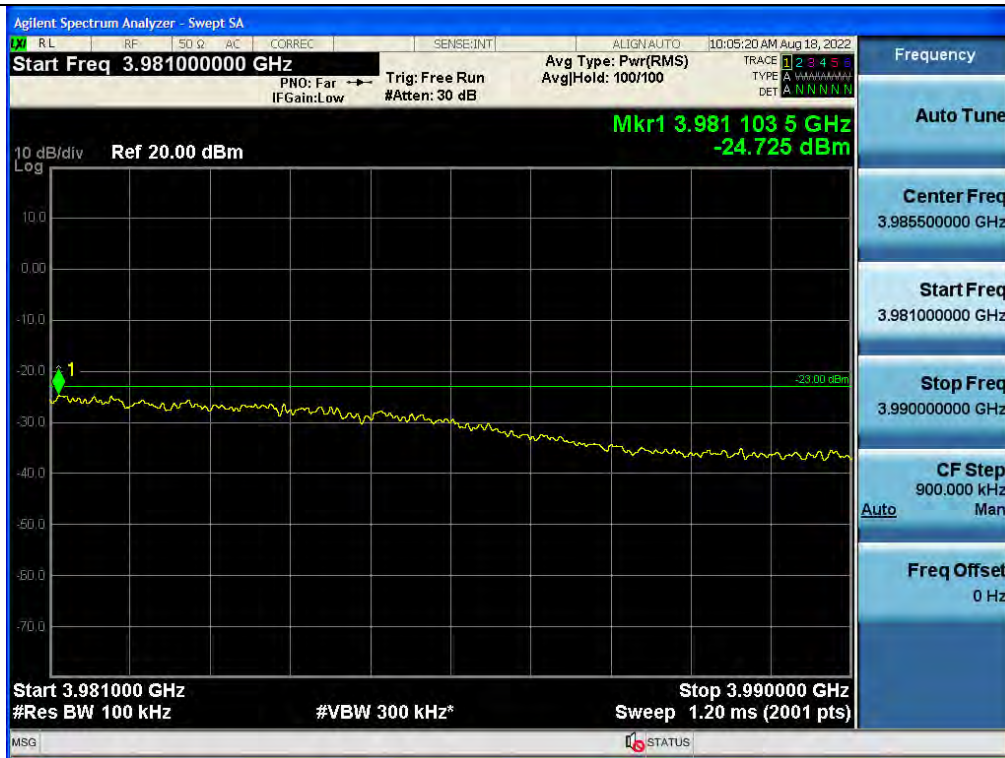

Spurious / C-Band / Downlink / 5G NR 60 MHz / Middle / High Edge + 10 MHz ~ 10 GHz

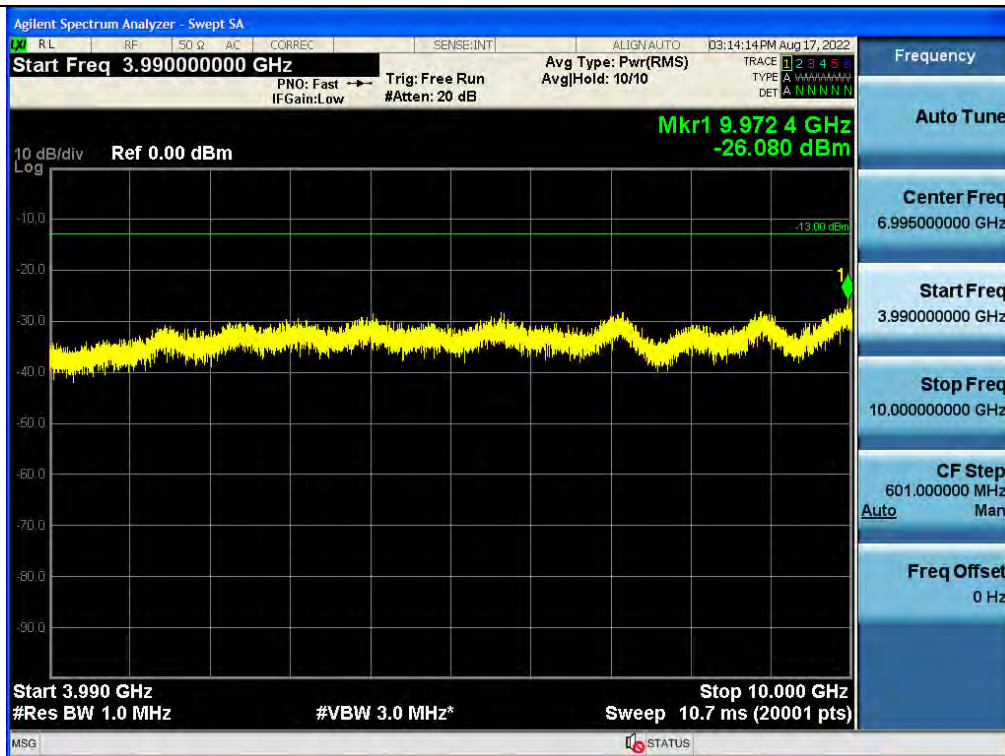

Spurious / C-Band / Downlink / 5G NR 40 MHz / Middle / 10 GHz ~ 26.5 GHz



Spurious / C-Band / Downlink / 5G NR 100 MHz / Middle / 26.5 GHz ~ 40 GHz

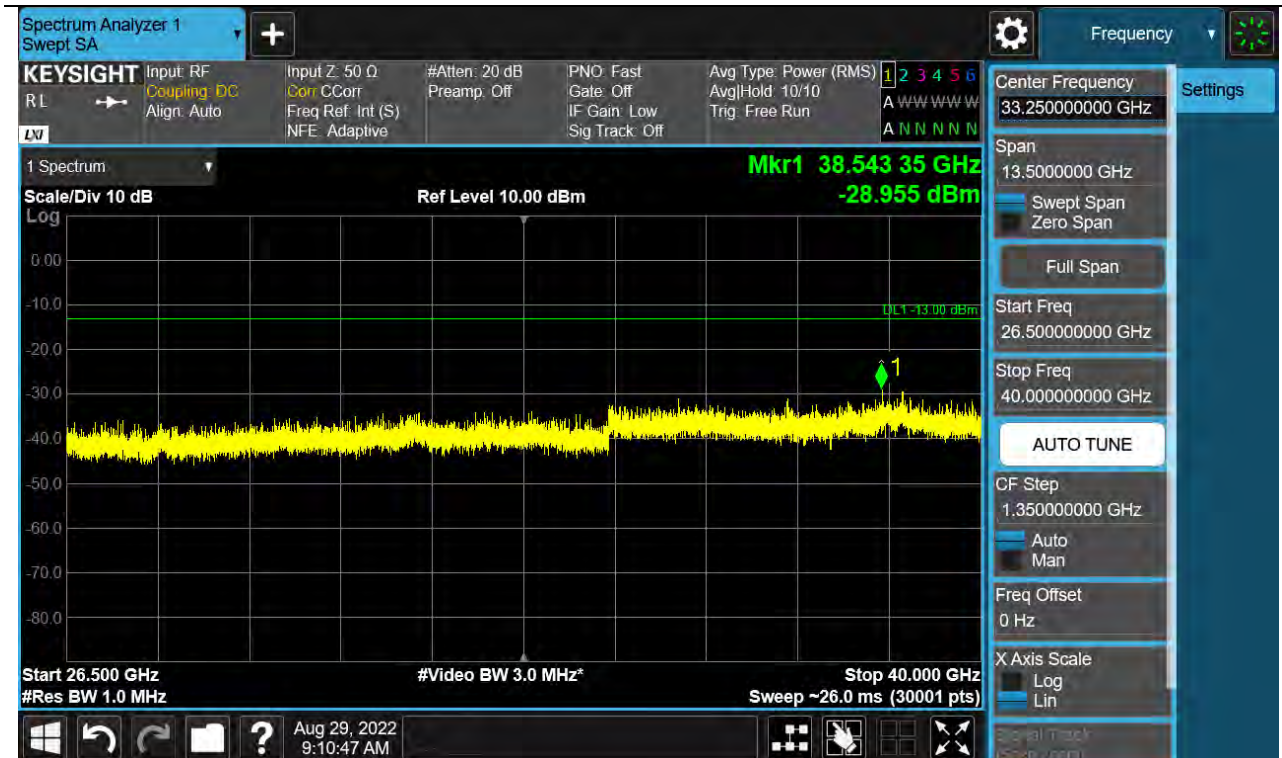

Note : Only the worst case Spurious Emissions plots are attached for each frequency range.

## 5.6. RADIATED SPURIOUS EMISSIONS

### Test Requirements:

#### § 2.1053 Measurements required: Field strength of spurious radiation.

- (a) Measurements shall be made to detect spurious emissions that may be radiated directly from the cabinet, control circuits, power leads, or intermediate circuit elements under normal conditions of installation and operation. Curves or equivalent data shall be supplied showing the magnitude of each harmonic and other spurious emission. For this test, single sideband, independent sideband, and controlled carrier transmitters shall be modulated under the conditions specified in paragraph (c) of § 2.1049, as appropriate. For equipment operating on frequencies below 890 MHz, an open field test is normally required, with the measuring instrument antenna located in the far-field at all test frequencies. In the event it is either impractical or impossible to make open field measurements (e.g. a broadcast transmitter installed in a building) measurements will be accepted of the equipment as installed. Such measurements must be accompanied by a description of the site where the measurements were made showing the location of any possible source of reflections which might distort the field strength measurements. Information submitted shall include the relative radiated power of each spurious emission with reference to the rated power output of the transmitter, assuming all emissions are radiated from halfwave dipole antennas.
- (b) The measurements specified in paragraph (a) of this section shall be made for the following equipment:
- (1) Those in which the spurious emissions are required to be 60 dB or more below the mean power of the transmitter.
  - (2) All equipment operating on frequencies higher than 25 MHz.
  - (3) All equipment where the antenna is an integral part of, and attached directly to the transmitter.
  - (4) Other types of equipment as required, when deemed necessary by the Commission.

#### § 27.53 Emission limits.

- (l) 3.7 GHz Service. The following emission limits apply to station transmitting in the 3700-3980 MHz band:
- (1) For base station operations in the 3700-3980 MHz band, the conducted power of any emission outside the licensee's authorized bandwidth shall not exceed -13 dBm/MHz. Compliance with this paragraph (l)(1) is based on the use of measurement instrumentation employing a resolution bandwidth of 1 megahertz or greater. However, in the 1 megahertz bands immediately outside and adjacent to the licensee's frequency block, a resolution bandwidth of at least one percent of the emission bandwidth of the fundamental emission of the transmitter may be employed. The emission bandwidth is defined as the width of the signal between two points, one below the carrier center frequency and one above the carrier center frequency, outside of which all emissions are attenuated at least 26 dB below the transmitter power.

### Test Procedures:

Because KDB 935210 D05 procedure does not provide this requirement, measurements were in accordance with the test methods section 5.5 of ANSI C63.26-2015

- a) Place the EUT in the center of the turntable. The EUT shall be configured to transmit into the standard non-radiating load (for measuring radiated spurious emissions), connected with cables of minimal length unless specified otherwise. If the EUT uses an adjustable antenna, the antenna shall be positioned to the length that produces the worst case emission at the fundamental operating frequency.
- b) Each emission under consideration shall be evaluated:
  - 1) Raise and lower the measurement antenna in accordance 5.5.2, as necessary to enable detection of the maximum emission amplitude relative to measurement antenna height.
  - 2) Rotate the EUT through 360° to determine the maximum emission level relative to the axial position.
  - 3) Return the turntable to the azimuth where the highest emission amplitude level was observed.
  - 4) Vary the measurement antenna height again through 1 m to 4 m again to find the height associated with the maximum emission amplitude.
  - 5) Record the measured emission amplitude level and frequency using the appropriate RBW.
- c) Repeat step b) for each emission frequency with the measurement antenna oriented in both the horizontal and vertical polarizations to determine the orientation that gives the maximum emissions amplitude.

### Note:

- (1) All power supplies of operation were investigated and the worst case configuration results are reported.
  - Mode: 100~240 VAC, 50/60 Hz /  $\pm 36\text{ V} \sim \pm 76\text{ VDC}$
  - Worst case: 100~240 VAC, 50/60 Hz



**Test Result:**

Band Name	Mode	Frequency (MHz)	Measured Level (dBuV)	Ant. Factor (dB/m)	A.G.+C.L.+H.P.F. (dB)	Pol.	Measured Power (dBm)	Result (dBm/m)
C-Band	NR 20M	7 678.54	39.84	35.90	27.11	H	-55.36	-46.57
		11 517.22	40.01	39.53	21.45	H	-55.19	-37.11
		7 682.94	41.45	35.90	27.11	V	-53.75	-44.96
		11 519.62	39.27	39.53	21.45	V	-55.93	-37.85

\* C.L.: Cable Loss / A.G.: Amp. Gain / H.P.F.: High Pass Filter

**Note:**

1. We have done horizontal and vertical polarization in detecting antenna.
2. Measure distance = 3 m
3. The amplitude of the spurious domain emission attenuated by more than 20 dB over the permissible value was not recorded according to ANSI C63.26, clause 5.1.1., c).
4. We have also tested all the additional models (-) and attached only the worst case plot of each model.

**Plot data of radiated spurious emissions**

Downlink / 5G NR 20 MHz

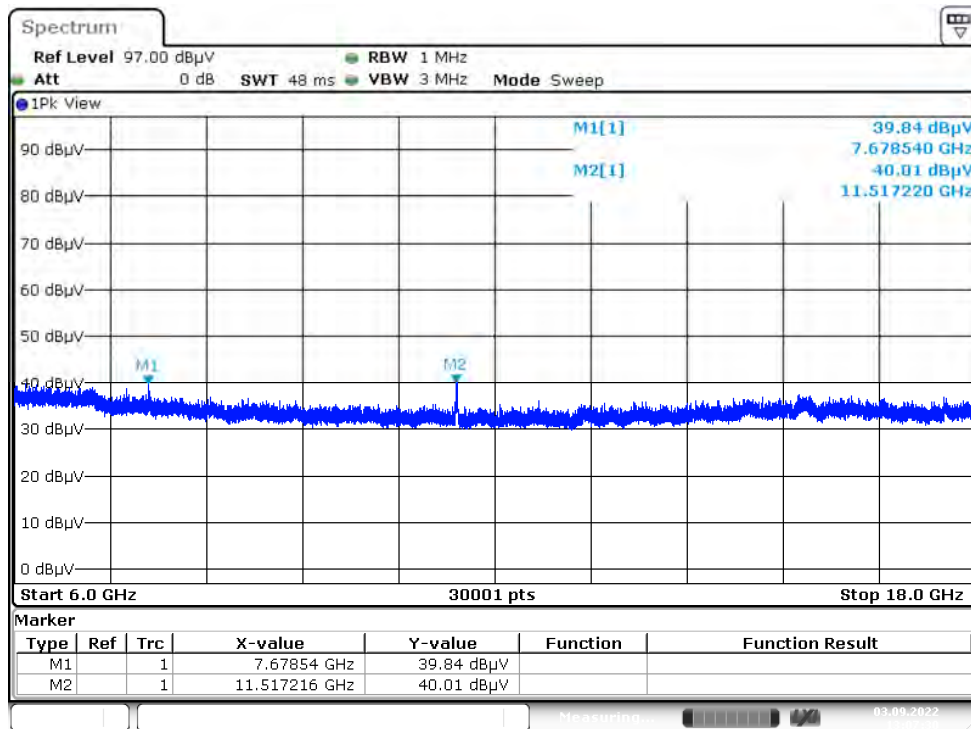

Note : Only the worst case plots for Radiated Spurious Emissions.

## 5.7. FREQUENCY STABILITY

### Test Requirements:

#### § 2.1055 Measurements required: Frequency stability.

- (a) The frequency stability shall be measured with variation of ambient temperature as follows:
- (1) From  $-30^{\circ}$  to  $+50^{\circ}$  centigrade for all equipment except that specified in paragraphs (a) (2) and (3) of this section.
  - (2) From  $-20^{\circ}$  to  $+50^{\circ}$  centigrade for equipment to be licensed for use in the Maritime Services under part 80 of this chapter, except for Class A, B, and S Emergency Position Indicating Radiobeacons (EPIRBS), and equipment to be licensed for use above 952 MHz at operational fixed stations in all services, stations in the Local Television Transmission Service and Point-to-Point Microwave Radio Service under part 21 of this chapter, equipment licensed for use aboard aircraft in the Aviation Services under part 87 of this chapter, and equipment authorized for use in the Family Radio Service under part 95 of this chapter.
  - (3) From  $0^{\circ}$  to  $+50^{\circ}$  centigrade for equipment to be licensed for use in the Radio Broadcast Services under part 73 of this chapter.
- (d) The frequency stability shall be measured with variation of primary supply voltage as follows:
- (1) Vary primary supply voltage from 85 to 115 percent of the nominal value for other than hand carried battery equipment.
  - (2) For hand carried, battery powered equipment, reduce primary supply voltage to the battery operating end point which shall be specified by the manufacturer.
  - (3) The supply voltage shall be measured at the input to the cable normally provided with the equipment, or at the power supply terminals if cables are not normally provided. Effects on frequency of transmitter keying (except for broadcast transmitters) and any heating element cycling at the nominal supply voltage and at each extreme also shall be shown.

#### § 27.54 Frequency stability.

The frequency stability shall be sufficient to ensure that the fundamental emissions stay within the authorized bands of operation.

### Test Procedures:

The measurement is performed in accordance with Section 5.6.3, 5.6.4 and 5.6.5 of ANSI C63.26.

#### 5.6.3 Procedure for frequency stability testing

Frequency stability is a measure of the frequency drift due to temperature and supply voltage variations, with reference to the frequency measured at +20 °C and rated supply voltage.

The operating carrier frequency shall be set up in accordance with the manufacturer's published operation and instruction manual prior to the commencement of these tests. No adjustment of any frequency determining circuit element shall be made subsequent to this initial set-up. Frequency stability is tested:

- a) At 10 °C intervals of temperatures between –30 °C and +50 °C at the manufacturer's rated supply voltage, and
- b) At +20 °C temperature and  $\pm 15\%$  supply voltage variations. If a product is specified to operate over a range of input voltage then the –15% variation is applied to the lowermost voltage and the +15% is applied to the uppermost voltage.

During the test all necessary settings, adjustments and control of the EUT have to be performed without disturbing the test environment, i.e., without opening the environmental chamber. The frequency stabilities can be maintained to a lesser temperature range provided that the transmitter is automatically inhibited from operating outside the lesser temperature range. For handheld equipment that is only capable of operating from internal batteries and the supply voltage cannot be varied, the frequency stability tests shall be performed at the nominal battery voltage and the battery end point voltage specified by the manufacturer. An external supply voltage can be used and set at the internal battery nominal voltage, and again at the battery operating end point voltage which shall be specified by the equipment manufacturer.

If an unmodulated carrier is not available, the mean frequency of a modulated carrier can be obtained by using a frequency counter with gating time set to an appropriately large multiple of bit periods (gating time depending on the required accuracy). Full details on the choice of values shall be included in the test report.

#### 5.6.4 Frequency stability over variations in temperature

- a) Supply the EUT with a nominal 60 Hz ac voltage, dc voltage, or install a new or fully charged battery in the EUT.
- b) If possible a dummy load should be connected to the EUT because an antenna near the metallic walls of an environmental test chamber could affect the output frequency of the EUT. If the EUT is equipped with a permanently attached, adjustable-length antenna, the EUT should be placed in the center of the chamber with the antenna adjusted to the shortest length possible.
- c) Turn on the EUT, and tune it to the center frequency of the operating band.
- d) Couple the transmitter output to the measuring instrument through a suitable attenuator and coaxial cable. If connection to the EUT output is not possible, make the measurement by connecting an antenna to the measuring instrument with a suitable length of coaxial cable and placing the measuring antenna near the EUT (e.g., 15 cm away).

NOTE—An instrument that has an adequate level of accuracy as specified by the procuring or regulatory authority is the recommended measuring instrument.

- e) Adjust the location of the measurement antenna and the controls on the measurement instrument to obtain a suitable signal level (i.e., a level that will not overload the measurement instrument, but is strong enough to allow measurement of the operating or fundamental frequency of the EUT). Adjust the detector bandwidth and span settings to achieve a resolution capable of accurate frequency measurements over the applicable frequency stability limits.
- f) Turn the EUT off, and place it inside the environmental temperature chamber. For devices that have oscillator heaters, energize only the heater circuit.
- g) Set the temperature control on the chamber to the Highest temperature specified in the regulatory requirements for the type of device, and allow the oscillator heater and the chamber temperature to stabilize. Unless otherwise instructed by the regulatory authority, this temperature should be 50 °C.
- h) While maintaining a constant temperature inside the environmental chamber, turn on the EUT and allow sufficient time for the EUT temperature to stabilize.
- i) Measure the frequency.
- j) Switch off the EUT, but do not switch off the oscillator heater.
- k) Lower the chamber temperature to the next level that is required by the standard and allow the temperature inside the chamber to stabilize. Unless otherwise instructed by the regulators, this temperature step should be 10 °C.
- l) Repeat step h) through step k) down to the lowest specified temperature. Unless otherwise instructed by the regulators, this temperature should be –30 °C. When the frequency stability limit is stated as being sufficient such that the fundamental emissions stay within the authorized bands of operation, a reference point shall be established at the applicable unwanted emissions limit using a RBW equal to the RBW required by the unwanted emissions specification of the applicable regulatory standard. These reference points measured using the lowest and Highest channel of operation shall be identified as  $f_L$  and  $f_H$  respectively. The worst-case frequency offset determined in the above methods shall be added or subtracted from the values of  $f_L$  and  $f_H$  and the resulting frequencies must remain within the band.
- m) Omitted

#### 5.6.5 Frequency stability when varying supply voltage

- a) Couple the transmitter output to the measuring instrument through a suitable attenuator and coaxial cable. If connection to the EUT output is not possible make the measurement by connecting an antenna to the measuring instrument with a suitable length of coaxial cable and placing the measuring antenna near the EUT (e.g., 15 cm away)
- b) Supply the EUT with nominal ac or dc voltage. The supply voltage shall be measured at the input to the cable normally provided with the equipment, or at the power supply terminals if cables are not normally provided. Effects on frequency of transmitter keying (except for broadcast transmitters) and any heating element cycling at the nominal supply voltage and at each extreme also shall be shown.
- c) Turn on the EUT, and couple its output to a frequency counter or other frequency-measuring instrument.
- d) Tune the EUT to the center frequency of the operating band. Adjust the location of the measurement antenna

and the controls on the measurement instrument to obtain a suitable signal level (i.e., a level that will not overload the measurement instrument, but is strong enough to allow measurement of the operating or fundamental frequency of the EUT). Adjust the detector bandwidth and span settings to achieve a resolution capable of accurate frequency measurements over the applicable frequency stability limits.

NOTE—An instrument that has an adequate level of accuracy as specified by the procuring or regulatory authority is the recommended measuring instrument.

- e) Measure the frequency.
- f) Unless otherwise specified, vary primary supply voltage from 85% to 115% of the nominal value for other than hand carried battery equipment.
- g) For hand carried, battery powered equipment, reduce the primary ac or dc supply voltage to the battery operating end point, which shall be specified by the manufacturer.
- h) Repeat the frequency measurement.

NOTE—For band-edge compliance, it can be required to make these measurements at the low and High channel of the operating band.

**Note:**

- (1) The results of the frequency stability test shown above the frequency deviation measured values are very small and similar trend for each port, so we are attached only the worst case data.
- (2) All power supplies of operation were investigated and the worst case configuration results are reported.
  - Mode: 100~240 VAC, 50/60 Hz /  $\pm 36\text{ V} \sim \pm 76\text{ VDC}$
  - Worst case: 100~240 VAC, 50/60 Hz

**Test Results:**

Reference: 110 Vac at 20°C Freq. = 3 840,000,000 Hz

Voltage (%)	Temp. (°C)	Frequency (Hz)	Frequency Error (Hz)	Deviation (Hz)	ppm
100 %	+20(Ref)	3 840 000 009	9.427	0.000	0.00000
	-30	3 840 000 019	9.137	-0.290	-0.00008
	-20	3 840 000 019	9.743	0.315	0.00008
	-10	3 840 000 017	7.586	-1.841	-0.00048
	0	3 840 000 016	6.337	-3.090	-0.00080
	+10	3 840 000 012	2.478	-6.950	-0.00181
	+30	3 840 000 015	5.392	-4.035	-0.00105
	+40	3 840 000 010	0.291	-9.136	-0.00238
	+50	3 840 000 016	6.119	-3.308	-0.00086
115 %	+20	3 840 000 014	4.342	-5.085	-0.00132
85 %	+20	3 840 000 014	4.474	-4.954	-0.00129

## 6. Annex A\_EUT AND TEST SETUP PHOTO

Please refer to test setup photo file no. as follows;

No.	Description
1	HCT-RF-2209-FC002-P