

TEST REPORT

FCC Test for ADXV-HPR-43BTF
Certification

APPLICANT
ADRF KOREA, Inc.

REPORT NO.
HCT-RF-2108-FC001

DATE OF ISSUE
August 5, 2021

Tested by
Kyung Soo Kang

Technical Manager
Jong Seok Lee

HCT CO., LTD.
Bongjai Huh
BongJai Huh / CEO

HCT Co., Ltd.

74, Seoicheon-ro 578beon-gil, Majang-myeon, Icheon-si, Gyeonggi-do, 17383 KOREA
Tel. +82 31 634 6300 Fax. +82 31 645 6401

TEST REPORT

FCC Test for
ADXV-HPR-43BTF

REPORT NO.
HCT-RF-2108-FC001

DATE OF ISSUE
August 05, 2021

Additional Model
-

Applicant **ADRF KOREA, Inc.**
5-5, Mojeon-Ri, Backsa-Myun, Icheon-Citi, Kyunggi-Do, Korea

Eut Type DAS
Model Name ADXV-HPR-43BTF

FCC ID N52-ADXV-HPR-BTF

Output Power 43 dBm

Date of Test July 16, 2021~ August 06, 2021

FCC Rule Parts: CFR 47 Part 2, Part 27

The result shown in this test report refer only to the sample(s) tested unless otherwise stated.
This test results were applied only to the test methods required by the standard.

REVISION HISTORY

The revision history for this test report is shown in table.

Revision No.	Date of Issue	Description
0	August 05, 2021	Initial Release

The measurements shown in this report were made in accordance with the procedures indicated, and the emissions from this equipment were found to be within the limits applicable. I assume full responsibility for the accuracy and completeness of these measurements, and for the qualifications of all persons taking them. It is further stated that upon the basis of the measurements made, the equipment tested is capable of operation in accordance with the requirements of the FCC Rules under normal use and maintenance.

If this report is required to confirmation of authenticity, please contact to www.hct.co.kr

CONTENTS

1. GENERAL INFORMATION	5
1.1. APPLICANT INFORMATION	5
1.2. PRODUCT INFORMATION	5
1.3. TEST INFORMATION	5
2. FACILITIES AND ACCREDITATIONS	6
2.1. FACILITIES	6
2.2. EQUIPMENT	6
3. TEST SPECIFICATIONS	7
3.1. STANDARDS	7
3.2. ADDITIONAL DESCRIPTIONS ABOUT TEST	8
3.3. MEASUREMENT UNCERTAINTY	10
3.4. STANDARDS ENVIRONMENTAL TEST CONDITIONS	10
3.5. TEST DIAGRAMS	11
4. TEST EQUIPMENTS	12
5. TEST RESULT	13
5.1. AGC THRESHOLD	13
5.2. OUT-OF-BAND REJECTION	15
5.3. INPUT-VERSUS-OUTPUT SIGNAL COMPARISON	17
5.4. INPUT/OUTPUT POWER AND AMPLIFIER/BOOSTER GAIN	24
5.5. OUT-OF-BAND/OUT-OF-BLOCK EMISSIONS AND SPURIOUS EMISSIONS	28
5.6. RADIATED SPURIOUS EMISSIONS	42
6. Annex A_EUT AND TEST SETUP PHOTO	45

1. GENERAL INFORMATION

1.1. APPLICANT INFORMATION

Company Name	ADRF KOREA, Inc.
Company Address	5-5, Mojeon-Ri, Backsa-Myun, Icheon-Citi, Kyunggi-Do, Korea

1.2. PRODUCT INFORMATION

EUT Type	DAS	
EUT Serial Number	ADXVHPR43BTF213001	
Power Supply	100-240VAC, 50/60Hz	
Frequency Range	Band Name	Downlink (MHz)
	BRS/EBS	2 496 ~ 2 690
Tx Output Power	43 dBm	
Antenna Peak Gain	3 dBi	

1.3. TEST INFORMATION

FCC Rule Parts	CFR 47 Part 2, Part 27
Measurement Standards	KDB 935210 D05 v01r04, KDB 971168 D01 v03r01, ANSI C63.26-2015
Test Location	HCT CO., LTD. 74, Seoicheon-ro 578beon-gil, Majang-myeon, Icheon-si, Gyeonggi-do, 17383, Rep. of KOREA

2. FACILITIES AND ACCREDITATIONS

2.1. FACILITIES

The SAC(Semi-Anechoic Chamber) and conducted measurement facility used to collect the radiated data are located at the 74, Seoicheon-ro 578beon-gil, Majang-myeon, Icheon-si, Gyeonggi-do, 17383, Rep. of KOREA.

The site is constructed in conformance with the requirements of ANSI C63.4 (Version: 2014) and CISPR Publication 22.

Detailed description of test facility was submitted to the Commission and accepted dated April 02, 2018 (Registration Number: KR0032).

2.2. EQUIPMENT

Radiated emissions are measured with one or more of the following types of linearly polarized antennas: tuned dipole, bi-conical, log periodic, bi-log, and/or ridged waveguide, horn. Spectrum analyzers with pre-selectors and quasi-peak detectors are used to perform radiated measurements.

Calibrated wideband preamplifiers, coaxial cables, and coaxial attenuators are also used for making measurements.

All receiving equipment conforms to CISPR Publication 16-1, "Radio Interference Measuring Apparatus and Measurement Methods."

3. TEST SPECIFICATIONS

3.1. STANDARDS

The following tests were conducted on a sample of the equipment for the purpose of demonstrating compliance with FCC Part 2 and Par 27.

Description	Reference	Results
AGC threshold	KDB 935210 D05 v01r04 3.2	Compliant
Out-of-band rejection	KDB 935210 D05 v01r04 3.3	Compliant
Input-versus-output signal comparison	§ 2.1049	Compliant
Input/output power and amplifier/booster gain	§ 2.1046, § 27.50(h)	Compliant
Out-of-band/out-of-block emissions and spurious emissions	§ 2.1051, § 27.53(m)	Compliant
Spurious emissions radiated	§ 2.1053	Compliant

3.2. ADDITIONAL DESCRIPTIONS ABOUT TEST

Except for the following cases, EUT was tested under normal operating conditions.

: Out-of-band rejection test requires maximum gain condition without AGC.

The test was generally based on the method of KDB 935210 D05 v01r04 and only followed ANSI C63.26-2015 if there was no test method in KDB standard.

EUT was tested with following modulated signals provide by applicant.

Band Name	Tested signals
BRS/EBS	LTE 20 MHz
	5G NR 100 MHz

*Simultaneous filter supporting LTE + 5G NR.

The frequency stability measurement has been omitted in accordance with section 3.7 of KDB 935210 D05 v01r04.

: It can be confirmed through input-versus-output signal comparison test that EUT does not alter the input signal.

The tests results included actual loss value for attenuator and cable combination as shown in the table below.

: Input Path

Correction factor table			
Frequency (MHz)	Factor (dB)	Frequency (MHz)	Factor (dB)
1 900	1.125	2 350	1.453
1 950	1.502	2 400	1.500
2 000	1.359	2 450	1.343
2 050	1.265	2 500	1.296
2 100	1.204	2 550	1.394
2 150	1.318	2 600	1.537
2 200	1.208	2 650	1.320
2 250	1.561	2 700	1.588
2 300	1.293	-	-

: Output Path

Correction factor table

Frequency (MHz)	Factor (dB)	Frequency (MHz)	Factor (dB)
2	29.285	3 000	33.138
10	29.383	4 000	34.055
30	29.358	5 000	35.488
50	29.423	6 000	35.825
100	29.644	7 000	36.974
200	29.970	8 000	37.731
300	30.193	9 000	38.292
400	30.391	10 000	39.318
500	30.546	11 000	38.223
600	30.693	12 000	38.604
700	30.850	13 000	38.088
800	30.961	14 000	39.527
900	31.104	15 000	39.790
1 000	31.234	16 000	40.284
1 100	31.376	17 000	39.296
1 200	31.533	18 000	39.680
1 300	31.615	19 000	40.452
1 400	31.731	20 000	41.104
1 500	31.793	21 000	43.448
1 600	31.918	22 000	42.703
1 700	31.977	23 000	43.767
1 800	32.059	24 000	43.265
1 900	32.158	25 000	44.990
2 000	32.252	26 000	45.921
2 100	32.357	26 500	41.956
2 200	32.417	-	-
2 300	32.519	-	-
2 400	32.643	-	-
2 500	32.743	-	-
2 600	32.853	-	-
2 700	32.984	-	-

3.3. MEASUREMENT UNCERTAINTY

Description	Condition	Uncertainty
Radiated Disturbance	9 kHz ~ 30 MHz	± 3.40 dB
	30 MHz ~ 1 GHz	± 4.80 dB
	1 GHz ~ 18 GHz	± 5.70 dB
	18 GHz ~ 40 GHz	± 5.05 dB

* Coverage factor k = 2, Confidence levels of 95 %

3.4. STANDARDS ENVIRONMENTAL TEST CONDITIONS

Temperature	+15 °C to +35 °C
Relative humidity	30 % to 60 %
Air pressure	860 mbar to 1 060 mbar

3.5. TEST DIAGRAMS

Conducted Test

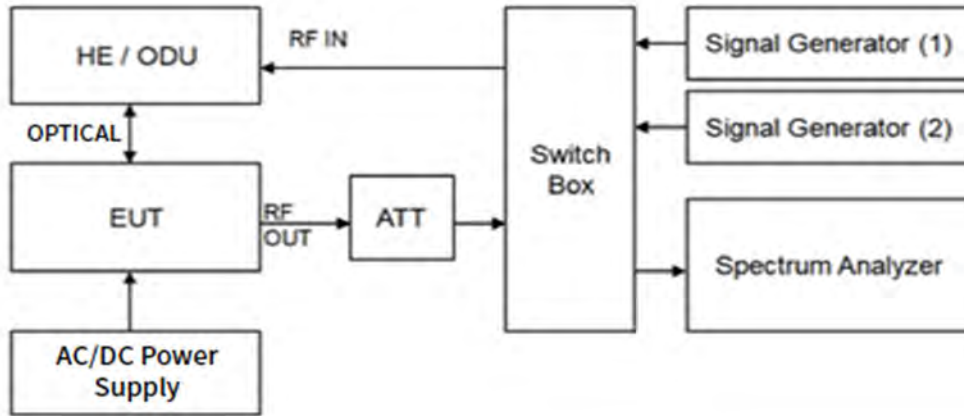

Radiated Test

30 MHz ~ 1 GHz

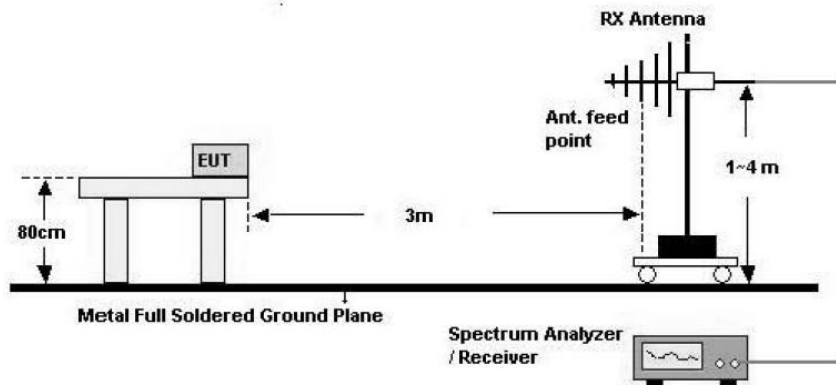

Above 1 GHz

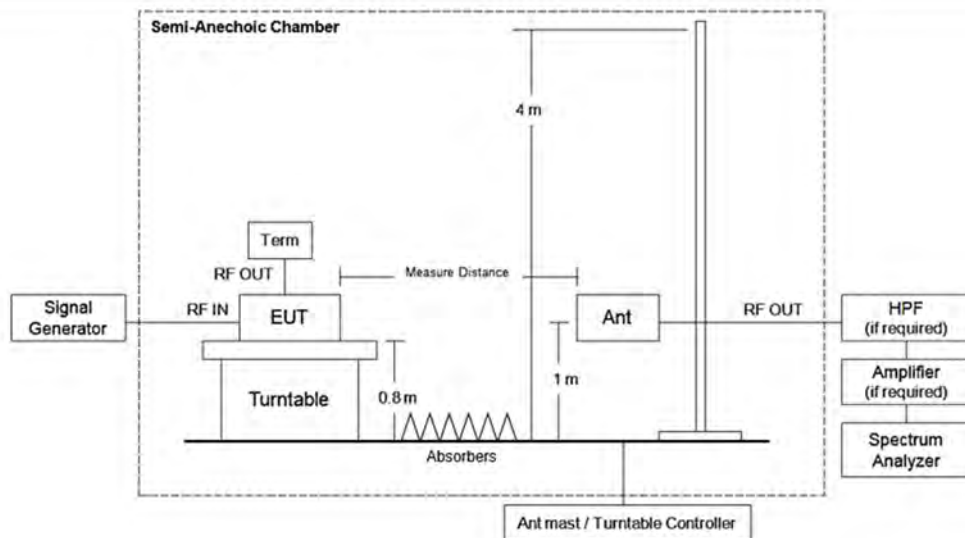

4. TEST EQUIPMENTS

Manufacturer	Model / Equipment	Calibration Date	Calibration Interval	Serial No.
Keysight	N9020A / MXA Signal Analyzer	08/06/2020	Annual	MY52440870
Keysight	N9030A / PXA Signal Analyzer	03/30/2021	Annual	US51350313
Agilent	N5182A / MXG Vector Signal Generator	01/08/2021	Annual	MY47070406
Agilent	N5182A / MXG Vector Signal Generator	12/02/2020	Annual	MY46240807
Weinschel Associates	WA93-30-33 / 30 dB Attenuator	03/30/2021	Annual	0202
KEITHLEY	S46 / Switch	N/A	N/A	1088024
Innco system	CO3000 / Controller(Antenna mast)	N/A	N/A	CO3000-4p
Innco system	MA4640/800-XP-EP / Antenna Position Tower	N/A	N/A	N/A
Audix	EM1000 / Controller	N/A	N/A	060520
Audix	Turn Table	N/A	N/A	N/A
TNM system	FBSM-01B / Amp & Filter Bank Switch Controller	N/A	N/A	TM19050002
Schwarzbeck	FMZB 1513 / Loop Antenna	03/19/2020	Biennial	1513-333
Schwarzbeck	VULB 9168 / Trilog Super Broadband Antenna	09/04/2019	Biennial	9168-0895
Schwarzbeck	BBHA 9120D / Horn Antenna	05/19/2020	Biennial	02296
Schwarzbeck	BBHA9170 / Horn Antenna(15 GHz ~ 40 GHz)	10/13/2020	Biennial	BBHA91703 42
Rohde & Schwarz	FSV40 / Spectrum Analyzer	05/14/2021	Annual	101055
TNM system	FMSR-05B / HPF(3~18GHz) + LNA1(1~18GHz)	01/20/2021	Annual	N/A
CERNEX	CBLU1183540B-01 / AMPLIFIER	01/20/2021	Annual	25540
Wainwright Instruments	F6_HP3.0 / High Pass Filter	01/20/2021	Annual	F6
CERNEX	CBL18265035 / Power Amplifier	12/04/2020	Annual	22966
CERNEX	CBL26405040 / Power Amplifier	03/23/2021	Annual	25956

Note:

1. Equipment listed above that calibrated during the testing period was set for test after the calibration.
2. Equipment listed above that has a calibration due date during the testing period, the testing is completed before equipment expiration date.

5. TEST RESULT

5.1. AGC THRESHOLD

Test Requirement:

KDB 935210 D05 v01r04

Testing at and above the AGC threshold is required.

Test Procedures:

Measurements were in accordance with the test methods section 3.2 of KDB 935210 D05 v01r04.

In the case of fiber-optic distribution systems, the RF input port of the equipment under test (EUT) refers to the RF input of the supporting equipment RF to optical convertor; see also descriptions and diagrams for typical DAS booster systems in KDB Publication 935210 D02

Devices intended to be directly connected to an RF source (donor port) only need to be evaluated for any over-the-air transmit paths.

- a) Connect a signal generator to the input of the EUT.
- b) Connect a spectrum analyzer or power meter to the output of the EUT using appropriate attenuation as necessary.
- c) The signal generator should initially be configured to produce either of the required test signals.
- d) Set the signal generator frequency to the center frequency of the EUT operating band.
- e) While monitoring the output power of the EUT, measured using the methods of ANSI C63.26-2015 subclause 5.2.4.4.1, increase the input level until a 1 dB increase in the input signal power no longer causes a 1 dB increase in the output signal power.
- f) Record this level as the AGC threshold level.
- g) Repeat the procedure with the remaining test signal.

Output power measurement in subclause 5.2.4.4.1 of ANSI C63.26

- a) Set span to $2 \times$ to $3 \times$ the OBW.
- b) Set RBW = 1% to 5% of the OBW.
- c) Set VBW $\geq 3 \times$ RBW.
- d) Set number of measurement points in sweep $\geq 2 \times$ span / RBW.
- e) Sweep time: auto-couple
- f) Detector = power averaging (rms).
- g) If the EUT can be configured to transmit continuously, then set the trigger to free run.
- h) Omit
- i) Trace average at least 100 traces in power averaging (rms) mode if sweep is set to auto-couple. To accurately determine the average power over multiple symbols, it can be necessary to increase the number of traces to be averaged above 100 or, if using a manually configured sweep time, increase the sweep time.

- j) Compute the power by integrating the spectrum across the OBW of the signal using the instrument's band or channel power measurement function, with the band/channel limits set equal to the OBW band edges. If the instrument does not have a band or channel power function, then sum the spectrum levels (in linear power units) at intervals equal to the RBW extending across the entire OBW of the spectrum.

Test Results:

Test Band	Link	Signal	Center Frequency (MHz)	AGC Threshold Level (dBm)	Output Level (dBm)
BRS/EBS	Downlink	LTE 20MHz	2593.00	0	43.09
		5G NR 100 MHz	2593.00	0	42.88

5.2. OUT-OF-BAND REJECTION

Test Requirement:

KDB 935210 D05 v01r04

Out-of-band rejection required.

Test Procedures:

Measurements were in accordance with the test methods section 3.3 of KDB 935210 D05 v01r04.

A signal booster shall reject amplification of other signals outside of its passband. Adjust the internal gain control of the EUT (if so equipped) to the maximum gain for which equipment certification is sought.

- a) Connect a signal generator to the input of the EUT.
- b) Configure a swept CW signal with the following parameters:
 - 1) Frequency range = $\pm 250\%$ of the passband, for each applicable CMRS band.
 - 2) Level = a sufficient level to affirm that the out-of-band rejection is > 20 dB above the noise floor and will not engage the AGC during the entire sweep.
 - 3) Dwell time = approximately 10 ms.
 - 4) Number of points = $\text{SPAN}/(\text{RBW}/2)$.
- c) Connect a spectrum analyzer to the output of the EUT using appropriate attenuation.
- d) Set the span of the spectrum analyzer to the same as the frequency range of the signal generator.
- e) Set the resolution bandwidth (RBW) of the spectrum analyzer to be 1 % to 5 % of the EUT passband, and the video bandwidth (VBW) shall be set to $\geq 3 \times \text{RBW}$.
- f) Set the detector to Peak Max-Hold and wait for the spectrum analyzer's spectral display to fill.
- g) Place a marker to the peak of the frequency response and record this frequency as f_0 .
- h) Place two markers, one at the lowest and the other at the highest frequency of the envelope of the spectral display, such that each marker is at or slightly below the -20 dB down amplitude, to determine the 20 dB bandwidth.
- i) Capture the frequency response of the EUT.
- j) Repeat for all frequency bands applicable for use by the EUT.

Test Results:

BRS/EBS (2 496 MHz ~ 2 690 MHz) / Downlink



5.3. INPUT-VERSUS-OUTPUT SIGNAL COMPARISON

Test Requirement:

§ 2.1049 Measurements required: Occupied bandwidth.

The occupied bandwidth, that is the frequency bandwidth such that, below its lower and above its upper frequency limits, the mean powers radiated are each equal to 0.5 percent of the total mean power radiated by a given emission shall be measured under the specified conditions of § 2.1049 (a) through (i) as applicable.

Test Procedures:

Measurements were in accordance with the test methods section 3.4 of KDB 935210 D05 v01r04.

A 26 dB bandwidth measurement shall be performed on the input signal and the output signal; alternatively, the 99% OBW can be measured and used. See KDB Publication 971168 [R8] for more information on measuring OBW.

- a) Connect a signal generator to the input of the EUT.
- b) Configure the signal generator to transmit the AWGN signal.
- c) Configure the signal amplitude to be just below the AGC threshold level (see 3.2), but not more than 0.5 dB below.
- d) Connect a spectrum analyzer to the output of the EUT using appropriate attenuation.
- e) Set the spectrum analyzer center frequency to the center frequency of the operational band under test. The span range of the spectrum analyzer shall be between 2 times to 5 times the emission bandwidth (EBW) or alternatively, the OBW.
- f) The nominal RBW shall be in the range of 1 % to 5 % of the anticipated OBW, and the VBW shall be $\geq 3 \times$ RBW.
- g) Set the reference level of the instrument as required to preclude the signal from exceeding the maximum spectrum analyzer input mixer level for linear operation. In general, the peak of the spectral envelope must be more than $[10 \log (\text{OBW} / \text{RBW})]$ below the reference level. Steps f) and g) may require iteration to enable adjustments within the specified tolerances.
- h) The noise floor of the spectrum analyzer at the selected RBW shall be at least 36 dB below the reference level.
- i) Set spectrum analyzer detection function to positive peak.
- j) Set the trace mode to max hold.
- k) Determine the reference value: Allow the trace to stabilize. Set the spectrum analyzer marker to the highest amplitude level of the displayed trace (this is the reference value) and record the associated frequency.
- l) Place two markers, one at the lowest and the other at the highest frequency of the envelope of the spectral display, such that each marker is at or slightly below the -26 dB down amplitude. The 26 dB EBW (alternatively OBW) is the positive frequency difference between the two markers. If the spectral envelope crosses the -26 dB down amplitude at multiple points, the lowest or highest frequency shall be selected as the frequencies that are the furthest removed from the center frequency at which the spectral envelope crosses the -26 dB down amplitude point.
- m) Repeat steps e) to l) with the input signal connected directly to the spectrum analyzer (i.e., input signal

measurement).

- n) Compare the spectral plot of the input signal (determined from step m) to the output signal (determined from step l) to affirm that they are similar (in passband and rolloff characteristic features and relative spectral locations), and include plot(s) and descriptions in test report.
- o) Repeat the procedure [steps e) to n)] with the input signal amplitude set to 3 dB above the AGC threshold.
- p) Repeat steps e) to o) with the signal generator set to the narrowband signal.
- q) Repeat steps e) to p) for all frequency bands authorized for use by the EUT.

Test Results:

Tabular data of Output Occupied Bandwidth

Test Band	Link	Signal	Center Frequency (MHz)	99 % OBW (MHz)	26 dB OBW (MHz)
BRS/EBS	Downlink	LTE 20MHz	2593.00	17.960	19.757
		5G NR 100 MHz	2593.00	97.214	102.31

Tabular data of Input Occupied Bandwidth

Test Band	Link	Signal	Center Frequency (MHz)	99 % OBW (MHz)	26 dB OBW (MHz)
BRS/EBS	Downlink	LTE 20MHz	2593.00	17.996	19.817
		5G NR 100 MHz	2593.00	97.115	102.41

Tabular data of 3 dB above the AGC threshold Output Occupied Bandwidth

Test Band	Link	Signal	Center Frequency (MHz)	99 % OBW (MHz)	26 dB OBW (MHz)
BRS/EBS	Downlink	LTE 20MHz	2593.00	17.922	19.694
		5G NR 100 MHz	2593.00	97.111	102.51

Tabular data of 3 dB above the AGC threshold Input Occupied Bandwidth

Test Band	Link	Signal	Center Frequency (MHz)	99 % OBW (MHz)	26 dB OBW (MHz)
BRS/EBS	Downlink	LTE 20MHz	2593.00	17.946	19.697
		5G NR 100 MHz	2593.00	97.199	102.48

Measured Occupied Bandwidth Comparison

Test Band	Link	Signal	Variant of Input and output Occupied Bandwidth (%)	Variant of Input and 3 dB above the AGC threshold output Occupied Bandwidth (%)
BRS/EBS	Downlink	LTE 20MHz	-0.303	-0.015
		5G NR 100 MHz	-0.101	0.026

* Change in input-output OBW is less than $\pm 5\%$.

Plot data of Occupied Bandwidth

Output / BRS/EBS / Downlink / LTE 20MHz

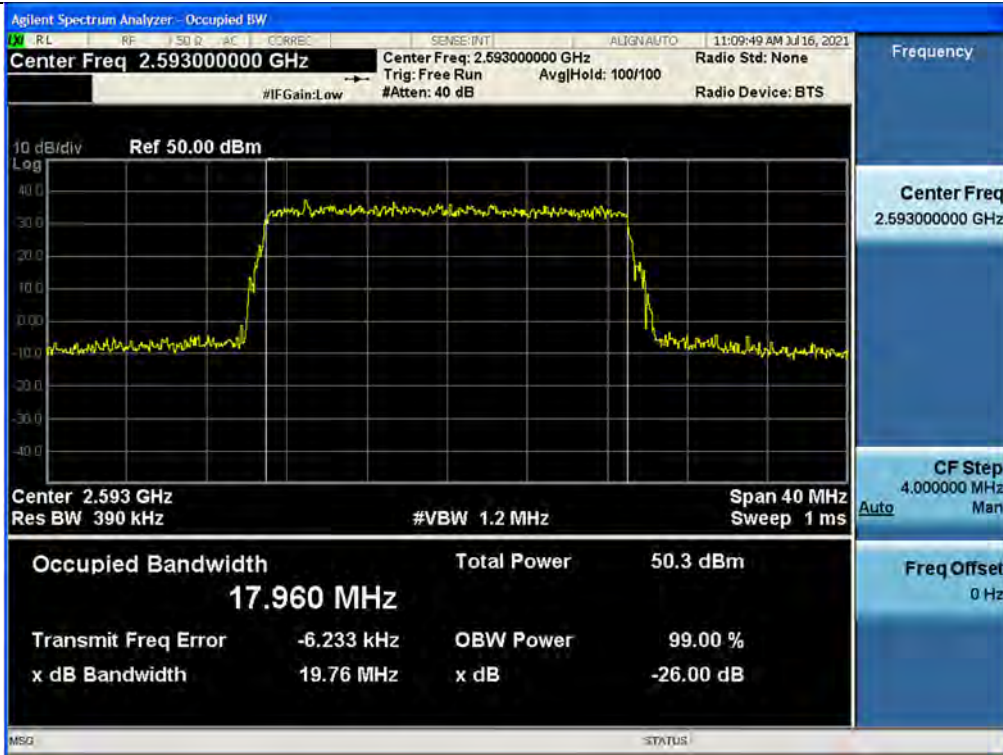

Input / BRS/EBS / Downlink / LTE 20 MHz

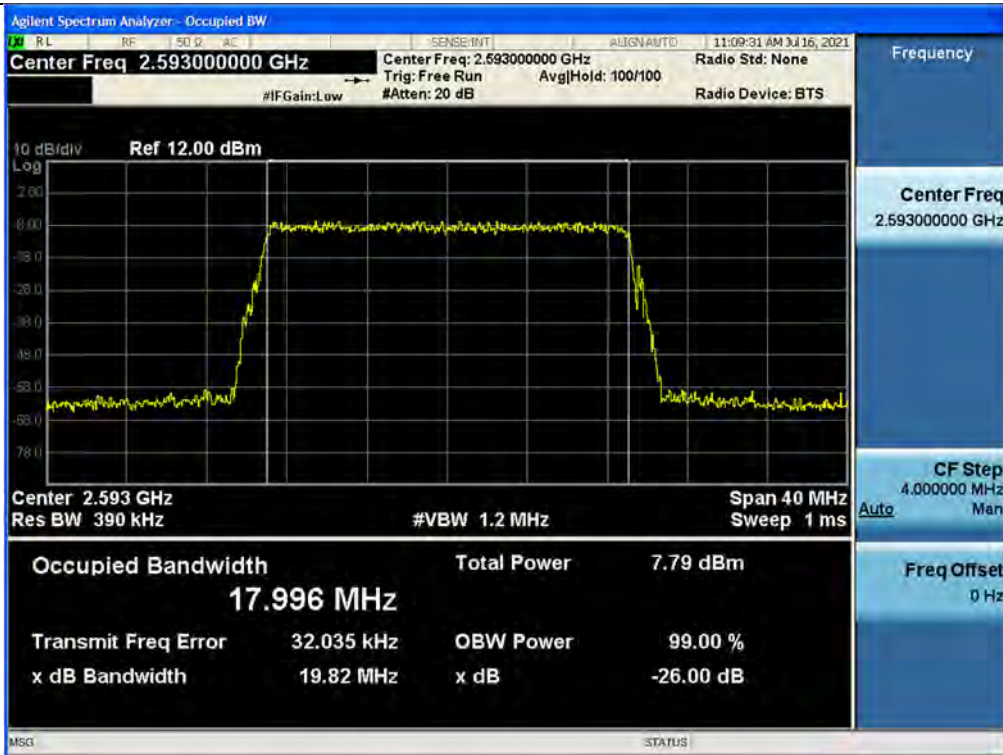

3 dB above the AGC threshold output / BRS/EBS / Downlink / LTE 20 MHz

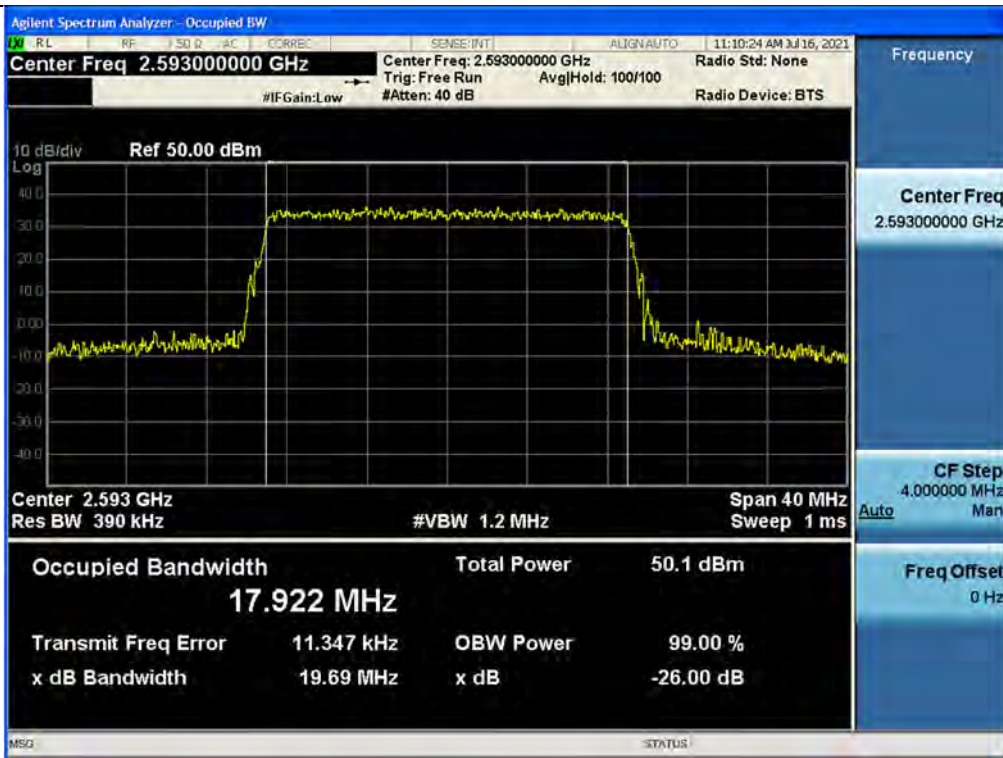

3 dB above the AGC threshold Input / BRS/EBS / Downlink / LTE 20 MHz

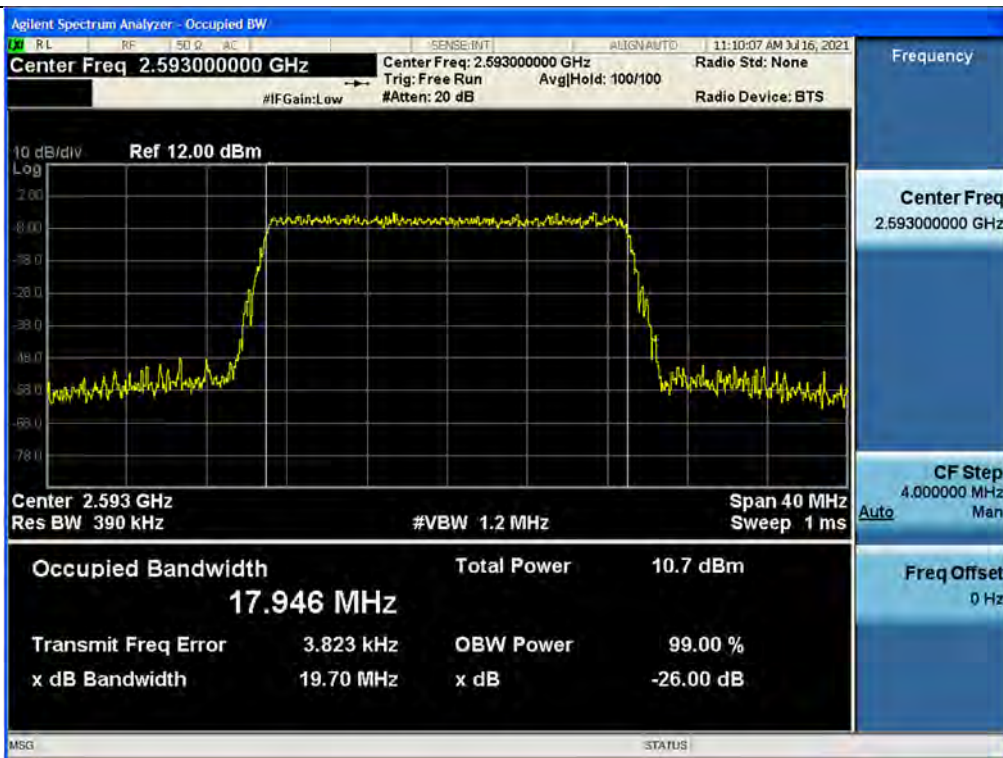

Output / BRS/EBS / Downlink / 5G NR 100 MHz

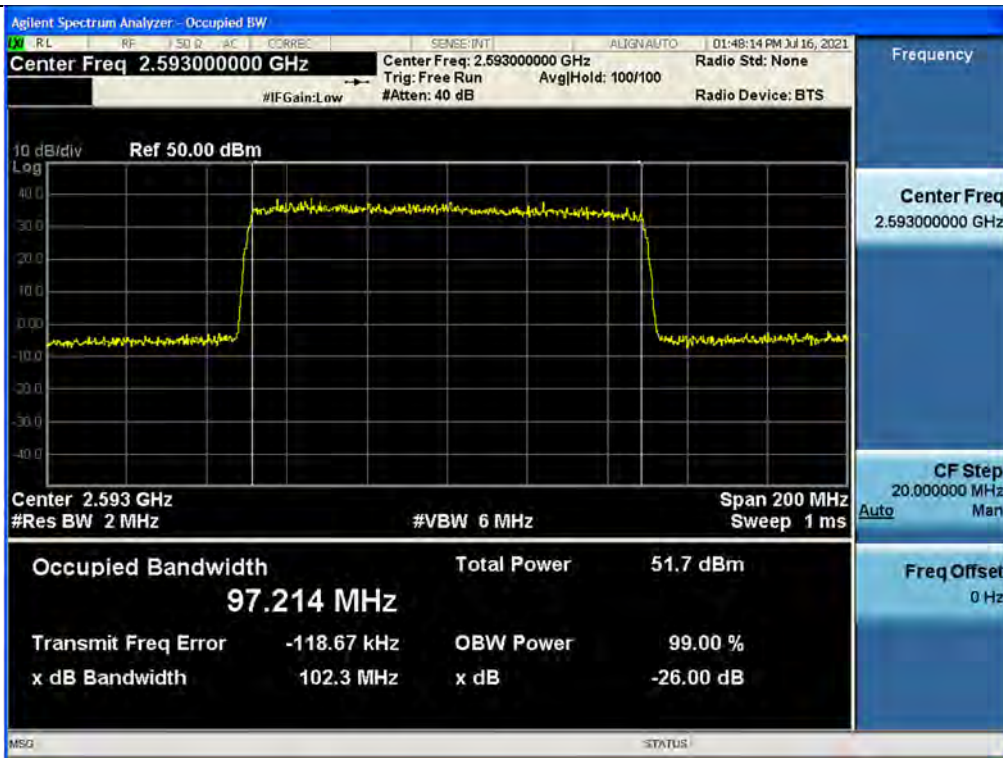

Input / BRS/EBS / Downlink / 5G NR 100 MHz

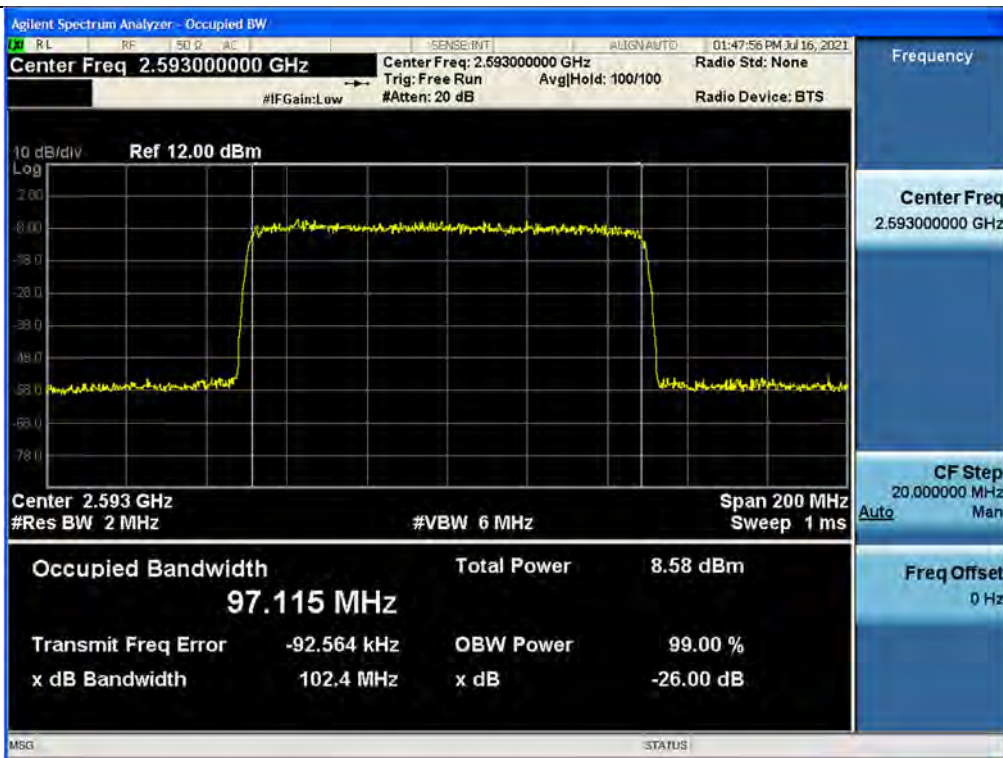

3 dB above the AGC threshold output / BRS/EBS / Downlink / 5G NR 100 MHz



3 dB above the AGC threshold Input / BRS/EBS / Downlink / 5G NR 100 MHz

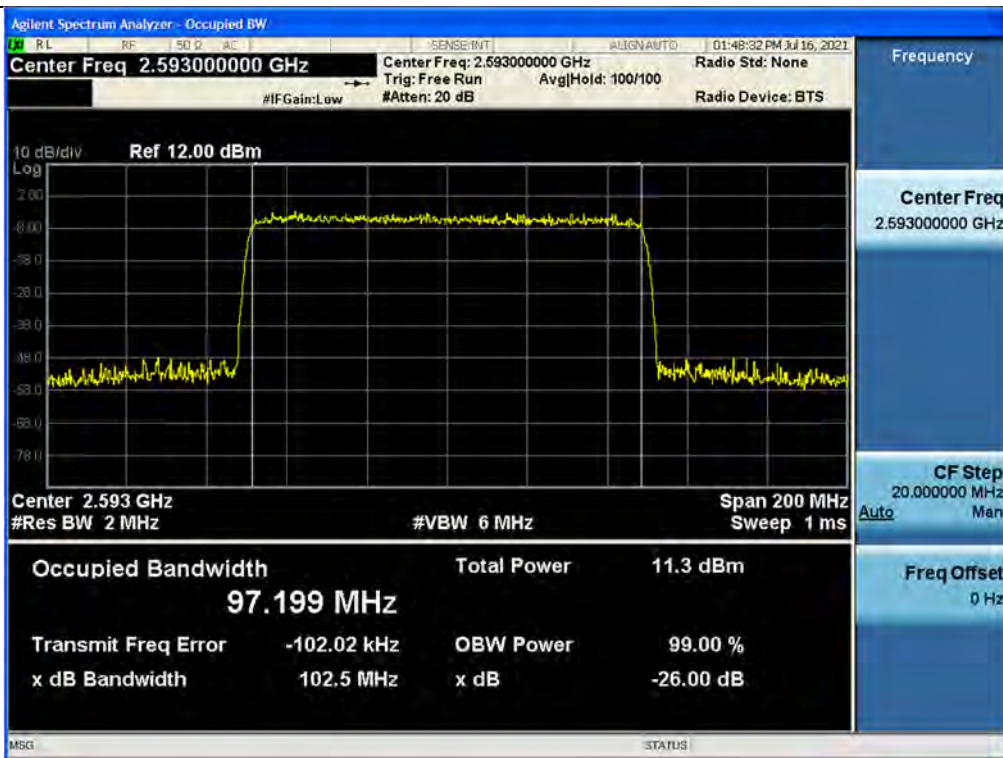

5.4. INPUT/OUTPUT POWER AND AMPLIFIER/BOOSTER GAIN

Test Requirement:

§ 2.1046 Measurements required: RF power output.

- (a) For transmitters other than single sideband, independent sideband and controlled carrier radiotelephone, power output shall be measured at the RF output terminals when the transmitter is adjusted in accordance with the tune-up procedure to give the values of current and voltage on the circuit elements specified in § 2.1033(c)(8). The electrical characteristics of the radio frequency load attached to the output terminals when this test is made shall be stated.
- (b) For single sideband, independent sideband, and single channel, controlled carrier radiotelephone transmitters the procedure specified in paragraph (a) of this section shall be employed and, in addition, the transmitter shall be modulated during the test as specified and applicable in § 2.1046 (b) (1-5). In all tests, the input level of the modulating signal shall be such as to develop rated peak envelope power or carrier power, as appropriate, for the transmitter.
- (c) For measurements conducted pursuant to paragraphs (a) and (b) of this section, all calculations and methods used by the applicant for determining carrier power or peak envelope power, as appropriate, on the basis of measured power in the radio frequency load attached to the transmitter output terminals shall be shown. Under the test conditions specified, no components of the emission spectrum shall exceed the limits specified in the applicable rule parts as necessary for meeting occupied bandwidth or emission limitations.

§ 27.50 Power limits and duty cycle.

- (h) The following power limits shall apply in the BRS and EBS:
 - (1) Main, booster and base stations.
 - (i) The maximum EIRP of a main, booster or base station shall not exceed $33 \text{ dBW} + 10\log(X/Y) \text{ dBW}$, where X is the actual channel width in MHz and Y is either 6 MHz if prior to transition or the station is in the MBS following transition or 5.5 MHz if the station is in the LBS and UBS following transition, except as provided in paragraph (h)(1)(ii) of this section.
 - (ii) If a main or booster station sectorizes or otherwise uses one or more transmitting antennas with a non-omnidirectional horizontal plane radiation pattern, the maximum EIRP in dBW in a given direction shall be determined by the following formula: $\text{EIRP} = 33 \text{ dBW} + 10 \log(X/Y) \text{ dBW} + 10 \log(360/\text{beamwidth}) \text{ dBW}$, where X is the actual channel width in MHz, Y is either (i) 6 MHz if prior to transition or the station is in the MBS following transition or (ii) 5.5 MHz if the station is in the LBS and UBS following transition, and beamwidth is the total horizontal plane beamwidth of the individual transmitting antenna for the station or any sector measured at the half-power points.

Test Procedures:

Measurements were in accordance with the test methods section 3.5 of KDB 935210 D05 v01r04.

Adjust the internal gain control of the EUT to the maximum gain for which the equipment certification is being sought. Any EUT attenuation settings shall be set to their minimum value.

Input power levels (uplink and downlink) should be set to maximum input ratings while confirming that the device is not capable of operating in saturation (non-linear mode) at the rated input levels, including during the performance of the input/output power measurements.

3.5.2 Measuring the EUT mean input and output power

- a) Connect a signal generator to the input of the EUT.
- b) Configure to generate the test signal.
- c) The frequency of the signal generator shall be set to the frequency f_0 as determined from out-of-band rejection test.
- d) Connect a spectrum analyzer or power meter to the output of the EUT using appropriate attenuation as necessary.
- e) Set the signal generator output power to a level that produces an EUT output level that is just below the AGC threshold, but not more than 0.5 dB below.
- f) Measure and record the output power of the EUT; use ANSI C63.26-2015 subclause 5.2.4.4.1, for power measurement.
- g) Remove the EUT from the measurement setup. Using the same signal generator settings, repeat the power measurement at the signal generator port, which was used as the input signal to the EUT, and record as the input power. EUT gain may be calculated as described in 3.5.5.
- h) Repeat steps f) and g) with input signal amplitude set to 3 dB above the AGC threshold level.
- i) Repeat steps e) to h) with the narrowband test signal.
- j) Repeat steps e) to i) for all frequency bands authorized for use by the EUT.

3.5.5 Calculating amplifier, repeater, or industrial booster gain

After the input and output power levels have been measured as described in the preceding subclauses, the gain of the EUT can be determined from:

$$\text{Gain (dB)} = \text{output power (dBm)} - \text{input power (dBm)}.$$

Report the gain for each authorized operating frequency band, and each test signal stimulus.

Note: If f_0 that determined from out-of-band test is smaller or greater than difference of test signal's center frequency and operation band block, test is performed at the lowest or the highest frequency that test signals can be passed.

EIRP Sample Calculation

Item	Formula	Value
27.50(h)(1)(i) Limit	$33 \text{ dBW} + 10 \log(X/Y) \text{ dBW}$ $= 33 \text{ dBW} + 10 \log(20/6) \text{ dBW} = 38.23 \text{ dBW}$	68.23 dBm
Final Calculated EIRP	Output Power + Antenna gain $= 43.16 \text{ dBm} + 3 \text{ dBi}$	46.16 dBm

Test Results:

Tabular data of Input / Output Power and Gain

Test Band	Signal	f ₀ Frequency	Input Power	Output Power	Gain	E.I.R.P		
		(MHz)	(dBm)		(dB)	(dBm)	(W/MHz)	(W)
BRS/EBS	LTE 20 MHz	2591.91	0.21	43.15	42.94	46.15	2.06	41.21
	5G NR 100 MHz	2591.91	-0.04	43.16	43.20	46.16	0.41	41.30

*E.I.R.P(dBm) = Output Power(dBm) + Ant. Gain(3 dBi)

Tabular data of Input / 3 dB above AGC threshold Output Power and Gain

Test Band	Signal	f ₀ Frequency	Input Power	Output Power	E.I.R.P		
		(MHz)	(dBm)		(dBm)	(W/MHz)	(W)
BRS/EBS	LTE 20 MHz	2591.91	3.18	42.92	45.92	1.95	39.08
	5G NR 100 MHz	2591.91	2.82	42.72	45.72	0.37	37.33

*E.I.R.P(dBm) = Output Power(dBm) + Ant. Gain(3 dBi)

Tabular data of PAPR

Test Band	Link	Signal	f ₀ Frequency (MHz)	0.1 % PAPR (dB)
BRS/EBS	Downlink	LTE 20MHz	2591.91	8.35
		5G NR 100 MHz	2591.91	8.30

Plot data of PAPR

PAPR / BRS/EBS / Downlink / LTE 20 MHz



PAPR / BRS/EBS / Downlink / 5G NR 100 MHz



5.5. OUT-OF-BAND/OUT-OF-BLOCK EMISSIONS AND SPURIOUS EMISSIONS

Test Requirements:

§ 2.1051 Measurements required: Spurious emissions at antenna terminals:

The radio frequency voltage or powers generated within the equipment and appearing on a spurious frequency shall be checked at the equipment output terminals when properly loaded with a suitable artificial antenna. Curves or equivalent data shall show the magnitude of each harmonic and other spurious emission that can be detected when the equipment is operated under the conditions specified in § 2.1049 as appropriate. The magnitude of spurious emissions which are attenuated more than 20 dB below the permissible value need not be specified.

§ 27.53 Emission limits.

- (m) For BRS and EBS stations, the power of any emissions outside the licensee's frequency bands of operation shall be attenuated below the transmitter power (P) measured in watts in accordance with the standards below. If a licensee has multiple contiguous channels, out-of-band emissions shall be measured from the upper and lower edges of the contiguous channels.
- (2) For digital base stations, the attenuation shall be not less than $43 + 10 \log (P)$ dB, unless a documented interference complaint is received from an adjacent channel licensee with an overlapping Geographic Service Area. Mobile Satellite Service licensees operating on frequencies below 2495 MHz may also submit a documented interference complaint against BRS licensees operating on channel BRS No. 1 on the same terms and conditions as adjacent channel BRS or EBS licensees. Provided that a documented interference complaint cannot be mutually resolved between the parties prior to the applicable deadline, then the following additional attenuation requirements shall apply:
- (i) If a pre-existing base station suffers harmful interference from emissions caused by a new or modified base station located 1.5 km or more away, within 24 hours of the receipt of a documented interference complaint the licensee of the new or modified base station must attenuate its emissions by at least $67 + 10 \log (P)$ dB measured at 3 megahertz, above or below, from the channel edge of its frequency block and shall immediately notify the complaining licensee upon implementation of the additional attenuation. No later than 60 days after the implementation of such additional attenuation, the licensee of the complaining base station must attenuate its base station emissions by at least $67 + 10 \log (P)$ dB measured at 3 megahertz, above or below, from the channel edge of its frequency block of the new or modified base station.
- (ii) If a pre-existing base station suffers harmful interference from emissions caused by a new or modified base station located less than 1.5 km away, within 24 hours of receipt of a documented interference complaint the licensee of the new or modified base station must attenuate its emissions by at least $67 + 10 \log (P) - 20 \log (D_{km}/1.5)$ dB measured at 3 megahertz, above or below, from the channel edge of its frequency block of the complaining licensee, or if both base stations are co-located, limit its undesired signal level at the pre-existing base station receiver(s) to no more than -107 dBm measured in a 5.5 megahertz bandwidth and shall immediately notify the complaining licensee upon such reduction in the undesired signal level. No later than 60 days after such reduction in the undesired signal level, the complaining licensee must attenuate its base station emissions by at least $67 + 10 \log (P)$ dB measured at 3 megahertz, above or below, from the channel edge of its frequency

- block of the new or modified base station.
- (iii) If a new or modified base station suffers harmful interference from emissions caused by a pre-existing base station located 1.5 km or more away, within 60 days of receipt of a documented interference complaint the licensee of each base station must attenuate its base station emissions by at least $67 + 10 \log (P)$ dB measured at 3 megahertz, above or below, from the channel edge of its frequency block of the other licensee.
 - (iv) If a new or modified base station suffers harmful interference from emissions caused by a pre-existing base station located less than 1.5 km away, within 60 days of receipt of a documented interference complaint: (a) The licensee of the new or modified base station must attenuate its OOB by at least $67 + 10 \log (P) - 20 \log (D_{km}/1.5)$ measured 3 megahertz above or below, from the channel edge of its frequency block of the other licensee, or if the base stations are co-located, limit its undesired signal level at the other base station receiver(s) to no more than -107 dBm measured in a 5.5-megahertz bandwidth; and (b) the licensee causing the interference must attenuate its emissions by at least $67 + 10 \log (P)$ dB measured at 3 megahertz, above or below, from the channel edge of its frequency block of the new or modified base station.
 - (v) For all fixed digital user stations, the attenuation factor shall be not less than $43 + 10 \log (P)$ dB at the channel edge.
- (6) Measurement procedure. Compliance with these rules is based on the use of measurement instrumentation employing a resolution bandwidth of 1 megahertz or greater. However, in the 1 MHz bands immediately outside and adjacent to the frequency block a resolution bandwidth of at least one percent of the emission bandwidth of the fundamental emission of the transmitter may be employed; for mobile digital stations, in the 1 megahertz bands immediately outside and adjacent to the frequency block a resolution bandwidth of at least two percent may be employed, except when the 1 megahertz band is 2495-2496 MHz, in which case a resolution bandwidth of at least one percent may be employed. A narrower resolution bandwidth is permitted in all cases to improve measurement accuracy provided the measured power is integrated over the full required measurement bandwidth (i.e. 1 megahertz or 1 percent of emission bandwidth, as specified; or 1 megahertz or 2 percent for mobile digital stations, except in the band 2495-2496 MHz). The emission bandwidth is defined as the width of the signal between two points, one below the carrier center frequency and one above the carrier center frequency, outside of which all emissions are attenuated at least 26 dB below the transmitter power. With respect to television operations, measurements must be made of the separate visual and aural operating powers at sufficiently frequent intervals to ensure compliance with the rules.

Test Procedures:

Measurements were in accordance with the test methods section 3.6 of KDB 935210 D05 v01r04.

Spurious emissions shall be measured using a single test signal sequentially tuned to the low, middle, and high channels or frequencies within each authorized frequency band of operation.

Out-of-band/out-of-block emissions (including intermodulation products) shall be measured under each of the following two stimulus conditions:

- a) two adjacent test signals sequentially tuned to the lower and upper frequency band/block edges;

- b) a single test signal, sequentially tuned to the lowest and highest frequencies or channels within the frequency band/block under examination.

NOTE—Single-channel boosters that cannot accommodate two simultaneous signals within the passband may be excluded from the test stipulated in step a).

3.6.2 Out-of-band/out-of-block emissions conducted measurements

- a) Connect a signal generator to the input of the EUT.
If the signal generator is not capable of generating two modulated carriers simultaneously, then two discrete signal generators can be connected with an appropriate combining network to support this two-signal test.
- b) Set the signal generator to produce two AWGN signals as previously described.
- c) Set the center frequencies such that the AWGN signals occupy adjacent channels, as defined by industry standards such as 3GPP or 3GPP2, at the upper edge of the frequency band or block under test.
- d) Set the composite power levels such that the input signal is just below the AGC threshold, but not more than 0.5 dB below. The composite power can be measured using the procedures provided in KDB Publication 971168, but it will be necessary to expand the power integration bandwidth so as to include both of the transmit channels.
- e) Connect a spectrum analyzer to the output of the EUT using appropriate attenuation as necessary.
- f) Set the RBW = reference bandwidth in the applicable rule section for the supported frequency band.
- g) Set the VBW = $3 \times$ RBW.
- h) Set the detector to power averaging (rms) detector.
- i) Set the Sweep time = auto-couple.
- j) Set the spectrum analyzer start frequency to the upper block edge frequency, and the stop frequency to the upper block edge frequency plus 300 kHz or 3 MHz, for frequencies below and above 1 GHz, respectively.
- k) Trace average at least 100 traces in power averaging (rms) mode.
- l) Use the marker function to find the maximum power level.
- m) Capture the spectrum analyzer trace of the power level for inclusion in the test report.
- n) Repeat steps k) to m) with the composite input power level set to 3 dB above the AGC threshold.
- o) Reset the frequencies of the input signals to the lower edge of the frequency block or band under test.
- p) Reset the spectrum analyzer start frequency to the lower block edge frequency minus 300 kHz or 3 MHz, for frequencies below and above 1 GHz, respectively, and the stop frequency to the lower band or block edge frequency.
- q) Repeat steps k) to n).
- r) Repeat steps a) to q) with the signal generator configured for a single test signal tuned as close as possible to the block edges.
- s) Repeat steps a) to r) with the narrowband test signal.
- t) Repeat steps a) to s) for all authorized frequency bands or blocks used by the EUT.

3.6.3 Spurious emissions conducted measurements

- a) Connect a signal generator to the input of the EUT.
- b) Set the signal generator to produce the broadband test signal as previously described.
- c) Set the center frequency of the test signal to the lowest available channel within the frequency band or block.

- d) Set the EUT input power to a level that is just below the AGC threshold, but not more than 0.5 dB below.
- e) Connect a spectrum analyzer to the output of the EUT using appropriate attenuation as necessary.
- f) Set the RBW = reference bandwidth in the applicable rule section for the supported frequency band of operation.
- g) Set the VBW $\geq 3 \times$ RBW.
- h) Set the Sweep time = auto-couple.
- i) Set the spectrum analyzer start frequency to the lowest RF signal generated in the equipment, without going below 9 kHz, and the stop frequency to the lower band/block edge frequency minus 1 MHz.
The number of measurement points in each sweep must be $\geq (2 \times \text{span}/\text{RBW})$, which may require that the measurement range defined by the start and stop frequencies be subdivided, depending on the available number of measurement points provided by the spectrum analyzer.
- j) Select the power averaging (rms) detector function.
- k) Trace average at least 10 traces in power averaging (rms) mode.
- l) Use the peak marker function to identify the highest amplitude level over each measured frequency range. Record the frequency and amplitude and capture a plot for inclusion in the test report.
- m) Reset the spectrum analyzer start frequency to the upper band/block edge frequency plus 1 MHz, and the spectrum analyzer stop frequency to 10 times the highest frequency of the fundamental emission. The number of measurement points in each sweep must be $\geq (2 \times \text{span}/\text{RBW})$, which may require that the measurement range defined by the start and stop frequencies be subdivided, depending on the available number of measurement points provided by the spectrum analyzer.
- n) Trace average at least 10 traces in power averaging (rms) mode.
- o) Use the peak marker function to identify the highest amplitude level over each of the measured frequency ranges. Record the frequency and amplitude and capture a plot for inclusion in the test report; also provide tabular data, if required.
- p) Repeat steps i) to o) with the input test signals firstly tuned to a middle band/block frequency/channel, and then tuned to a high band/block frequency/channel.
- q) Repeat steps b) to p) with the narrowband test signal.
- r) Repeat steps b) to q) for all authorized frequency bands/blocks used by the EUT.

Note:

1. In some bands, RBW was reduced to 0.1 %, 1 % and 10% of the reference bandwidth for measuring unwanted emission level (typically, 1 MHz if the authorized frequency band is above 1 GHz) and power was integrated. (0.1% = +30 dB, 1% = +20 dB, 10% = +10 dB)
2. Intermodulation test is not performed for 5G NR 100 MHz signal, because the band cannot accommodate two signals. (Refer to Section 3.6.1 of KDB 935210 D05)
3. Among the data of simultaneous and single band emission conditions, the single emission condition is the worst.

Test Results: Plot data of Out-of-band/out-of-block emissions

Out-of-band (two adjacent test signals) / BRS/EBS / Downlink / LTE 20 MHz / Lower

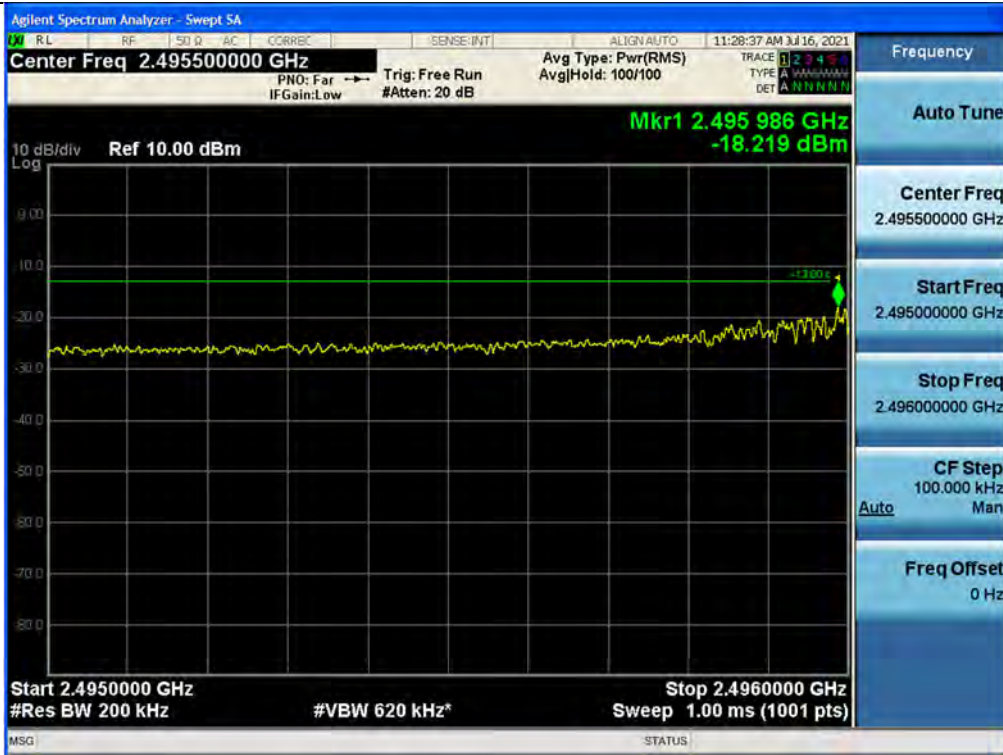

Out-of-band (two adjacent test signals) / BRS/EBS / Downlink / LTE 20 MHz / Upper

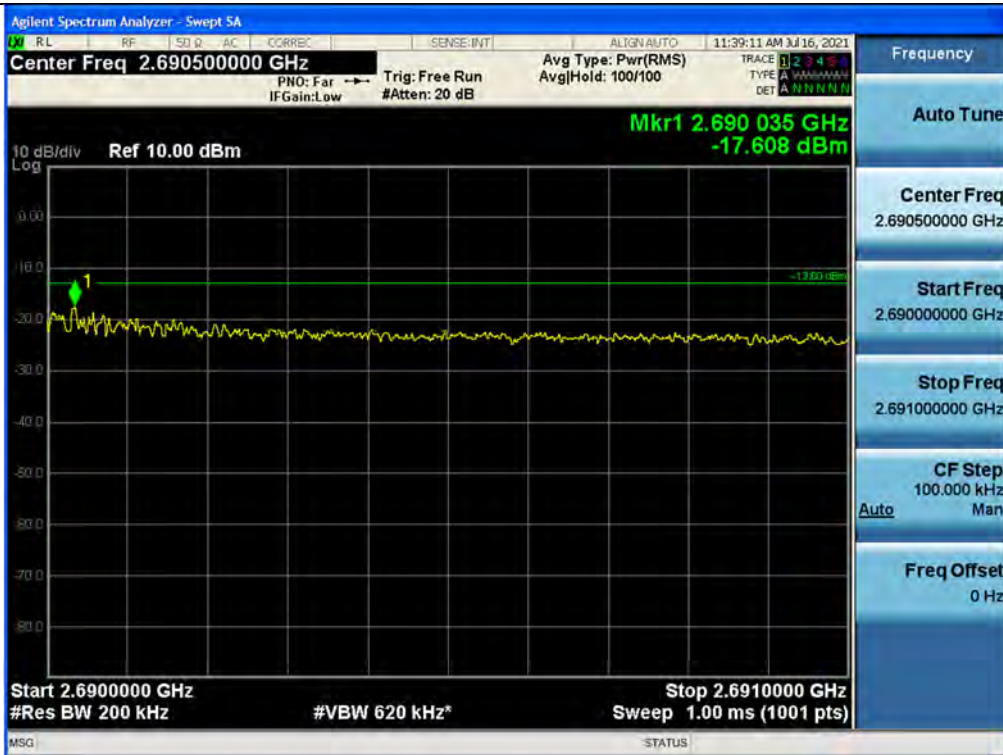

+3 dB above Out-of-band (two adjacent test signals) / BRS/EBS / Downlink / LTE 20 MHz / Lower

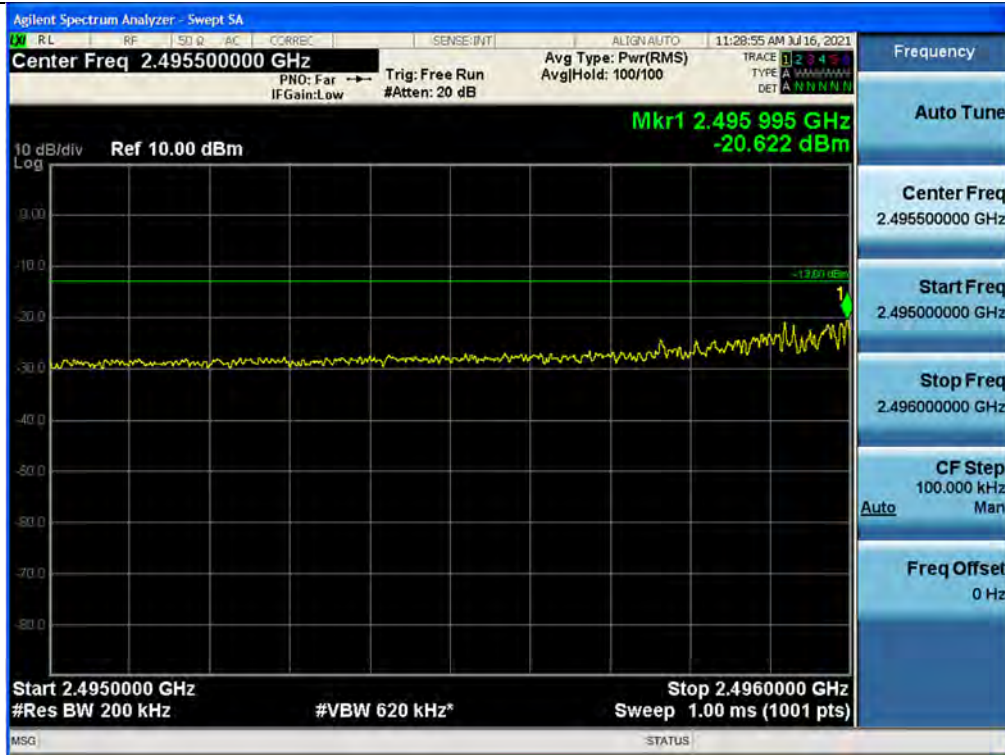

+3 dB above Out-of-band (two adjacent test signals) / BRS/EBS / Downlink / LTE 20 MHz / Upper

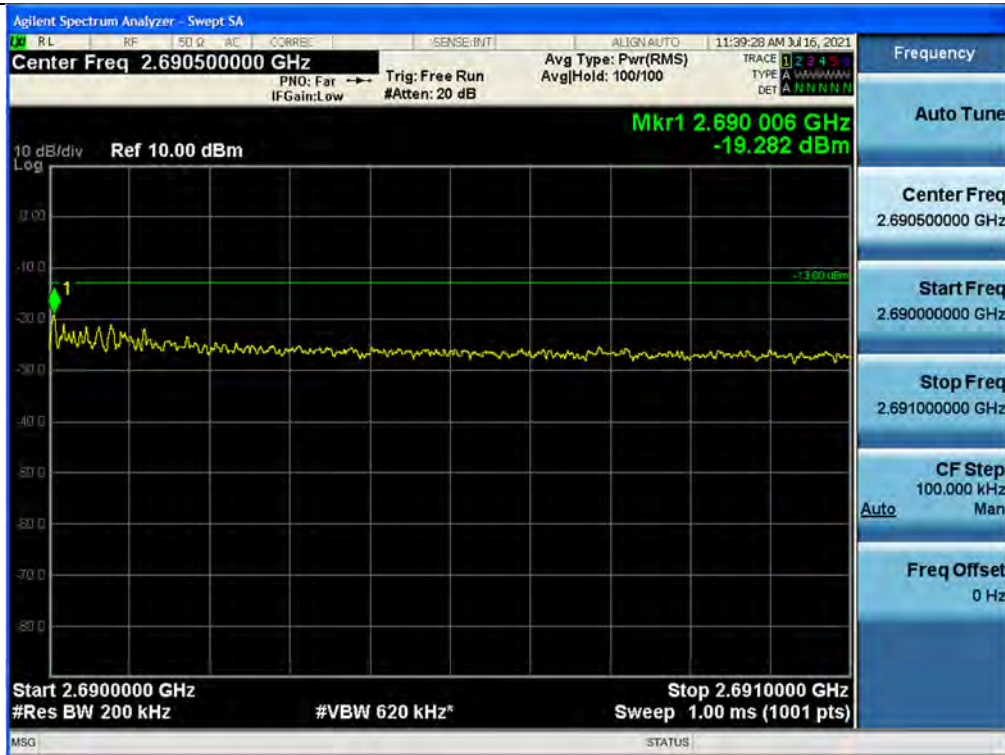

Out-of-band (single test signals) / BRS/EBS / Downlink / LTE 20 MHz / Lower



Out-of-band (single test signals) / BRS/EBS / Downlink / LTE 20 MHz / Upper

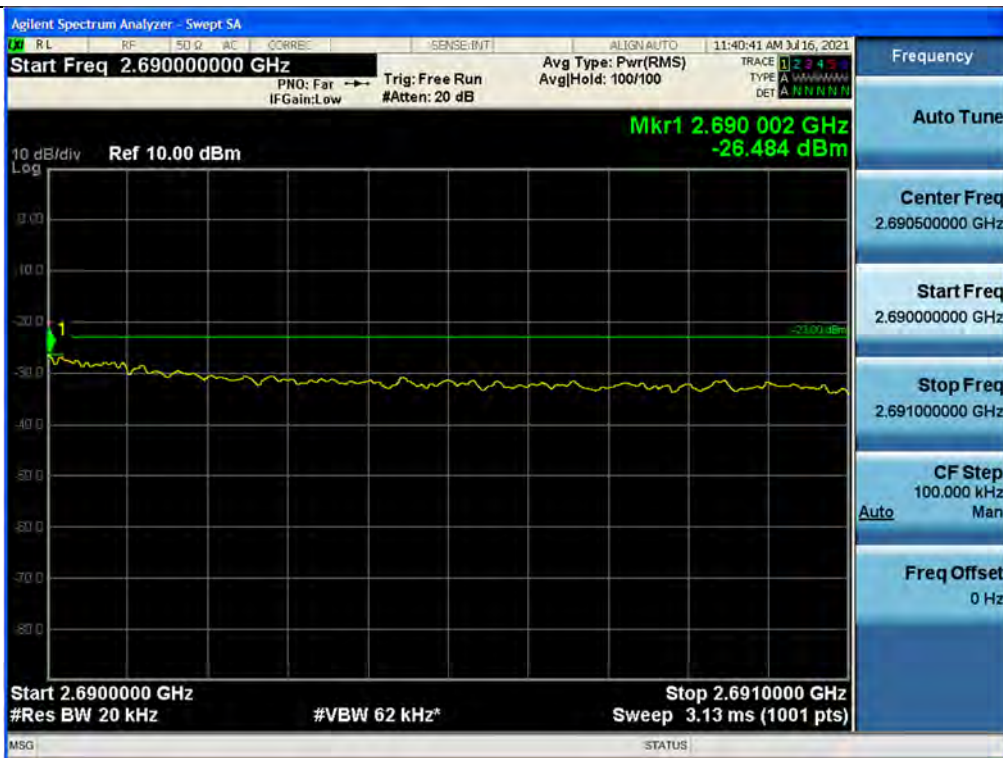

+3 dB above Out-of-band (single test signals) / BRS/EBS / Downlink / LTE 20 MHz / Lower

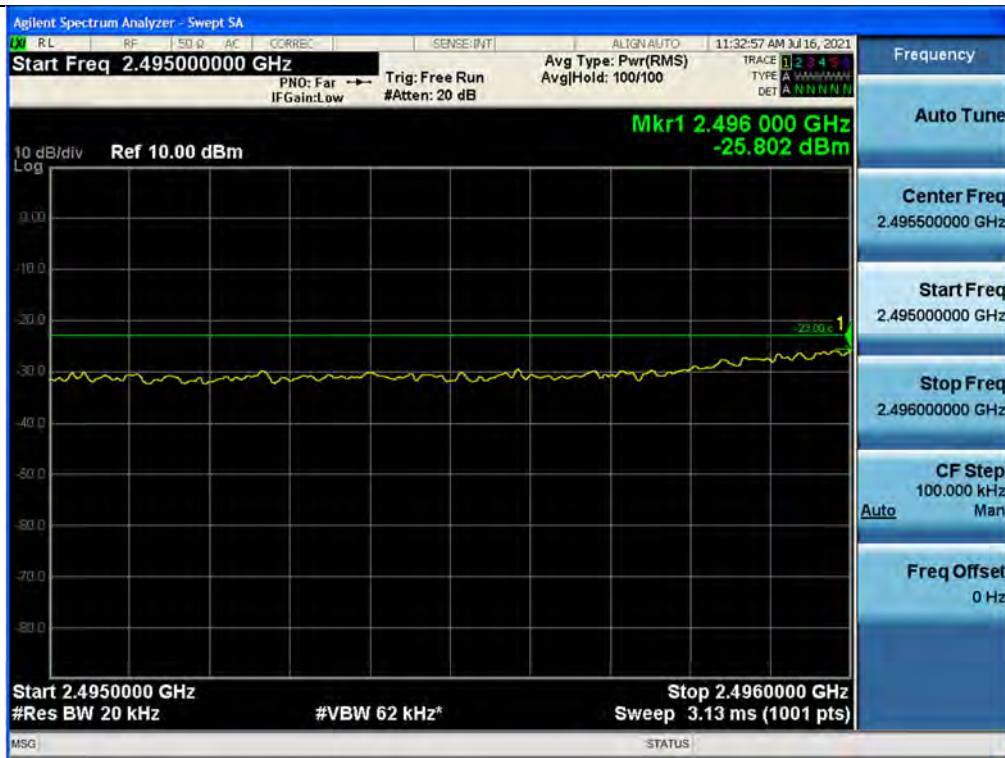

+3 dB above Out-of-band (single test signals) / BRS/EBS / Downlink / LTE 20 MHz / Upper

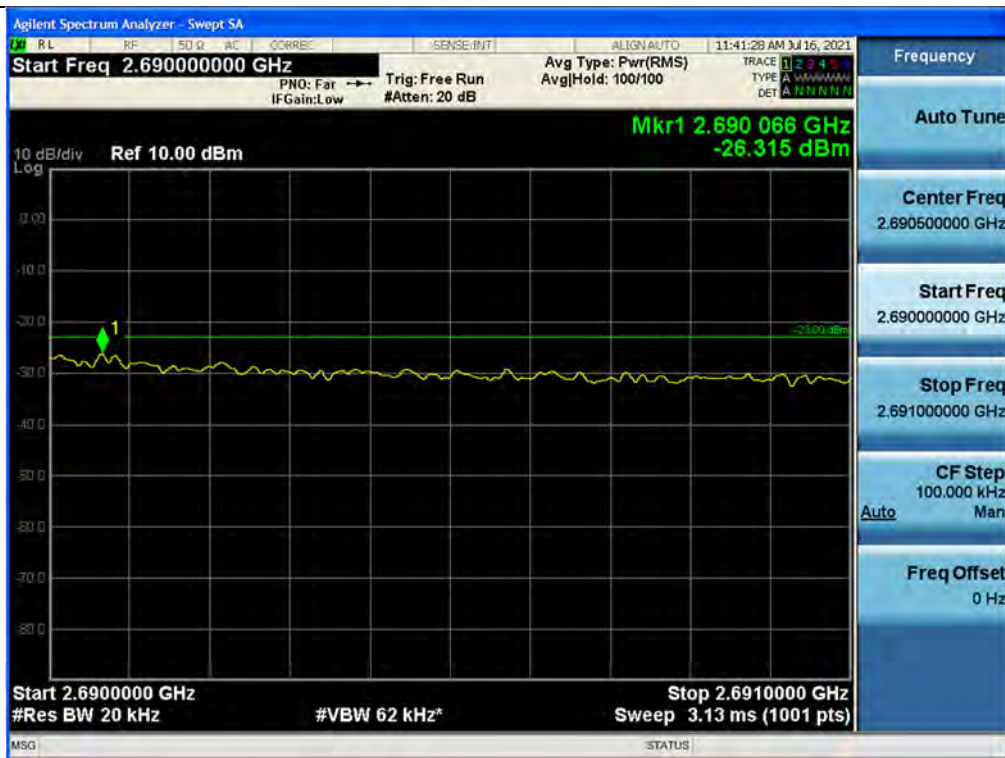

Out-of-band (single test signals) / BRS/EBS / Downlink / 5G NR 100 MHz / Lower

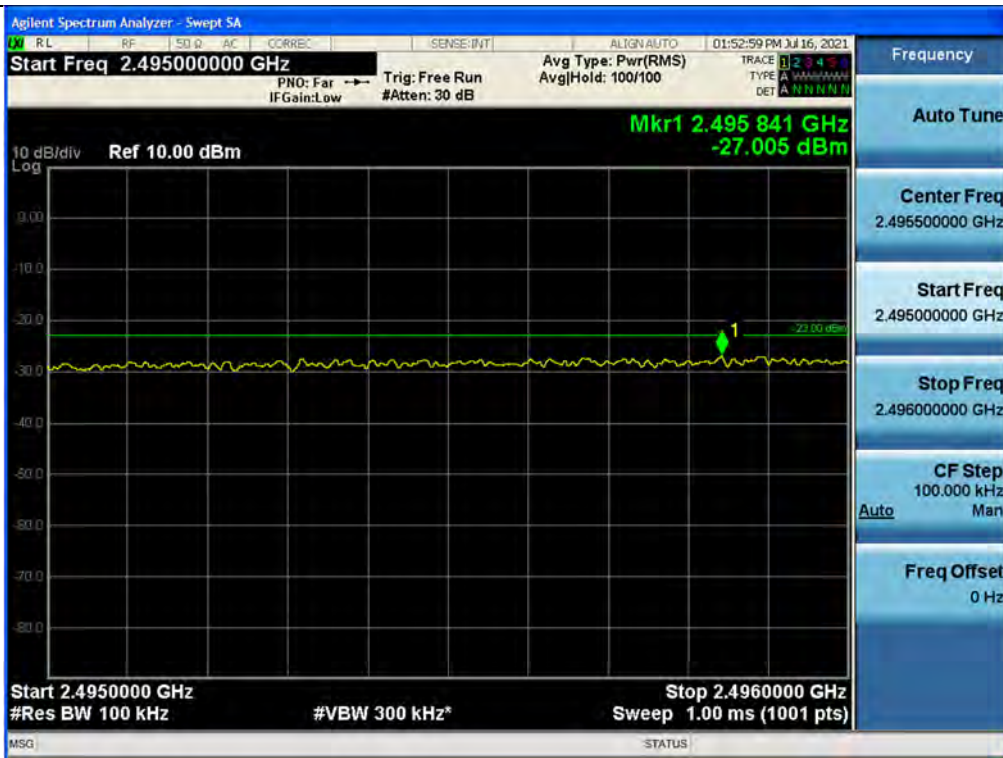

Out-of-band (single test signals) / BRS/EBS / Downlink / 5G NR 100 MHz / Upper

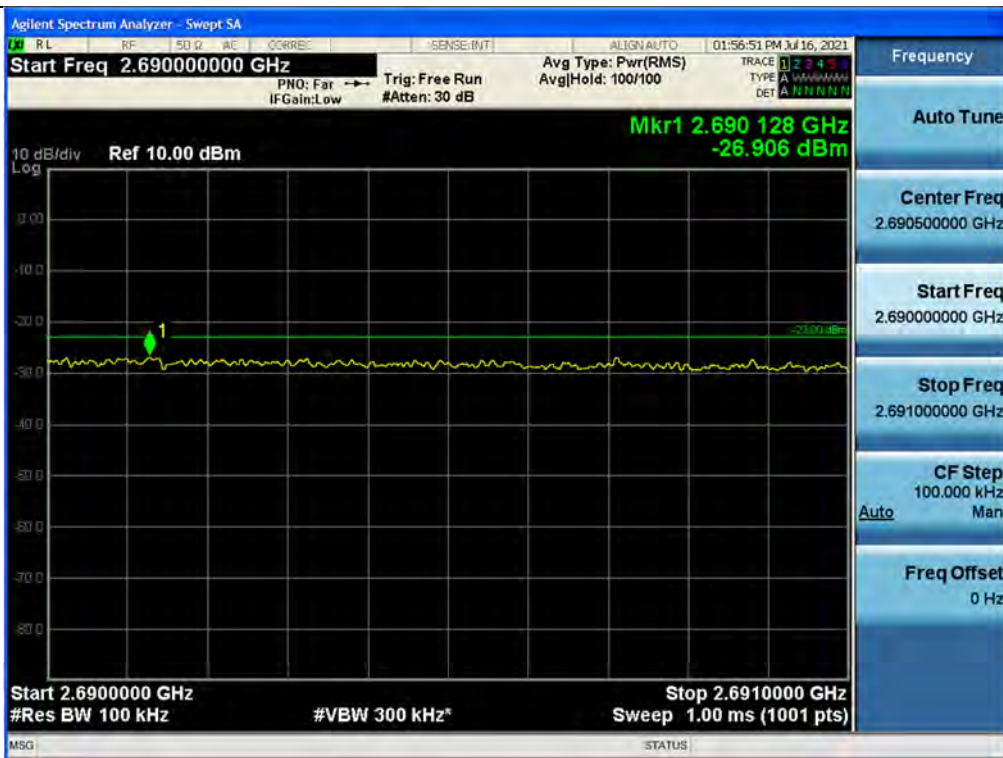

+3 dB above Out-of-band (single test signals) / BRS/EBS / Downlink / 5G NR 100 MHz / Lower

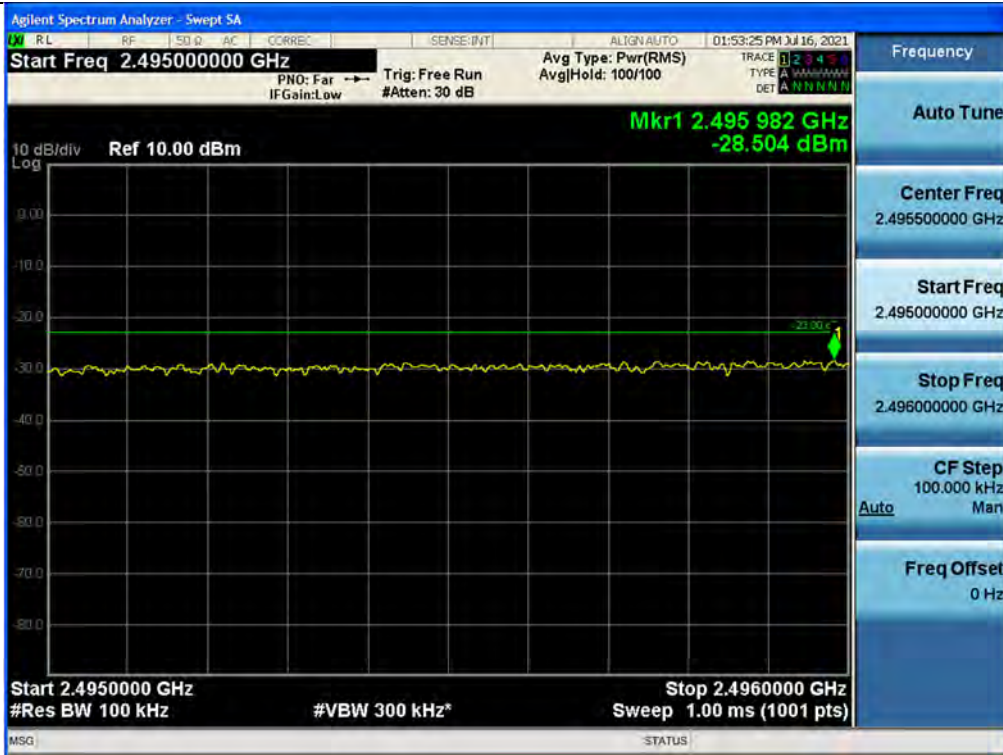

+3 dB above Out-of-band (single test signals) / BRS/EBS / Downlink / 5G NR 100 MHz / Upper

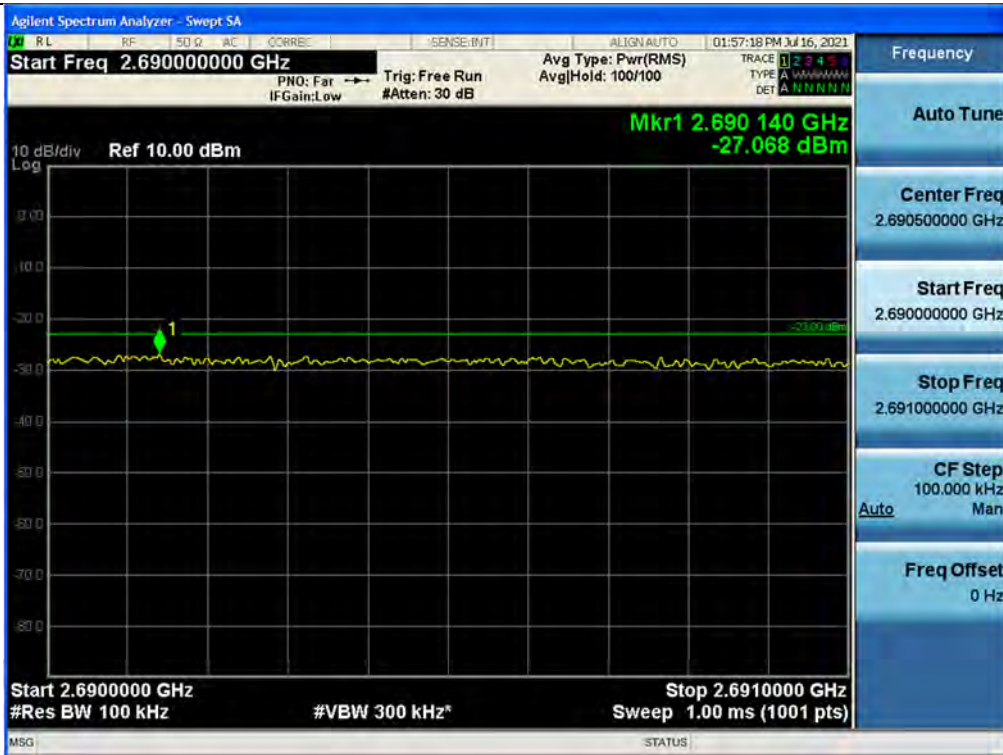

Plot data of Spurious Emissions

Spurious / BRS/EBS / Downlink / LTE 20 MHz / Middle / 9 kHz ~ 150 kHz



Spurious / BRS/EBS / Downlink / LTE 20 MHz / Middle / 150 kHz ~ 30 MHz

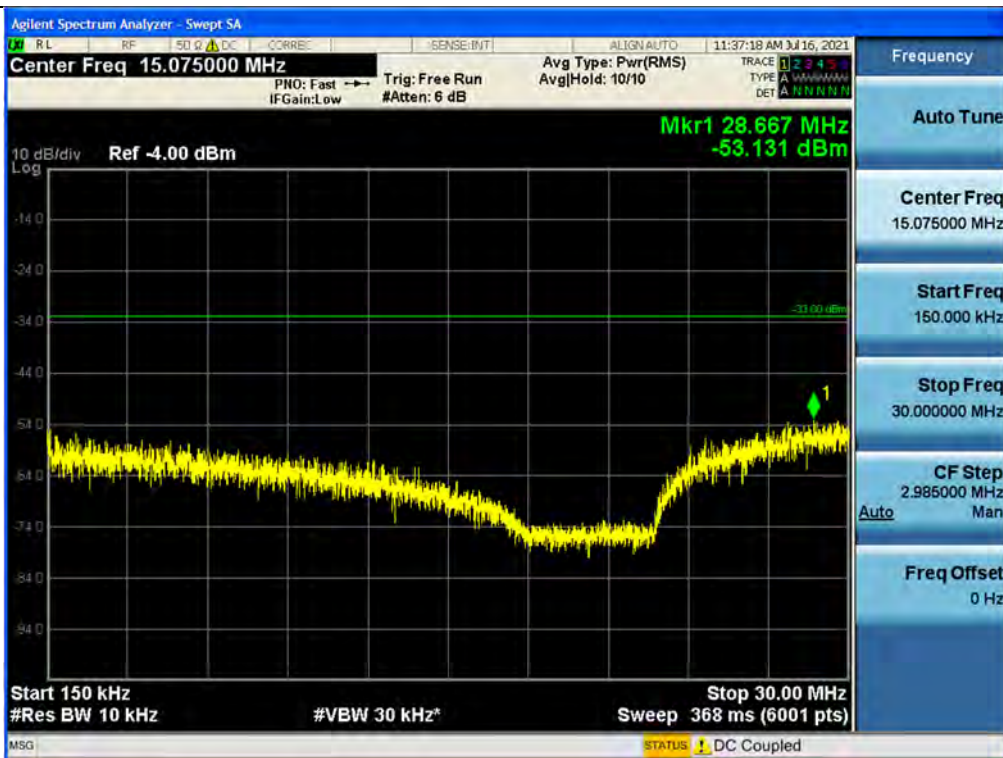

Spurious / BRS/EBS / Downlink / LTE 20 MHz / Low / 30 MHz ~ Low Edge - 10 MHz

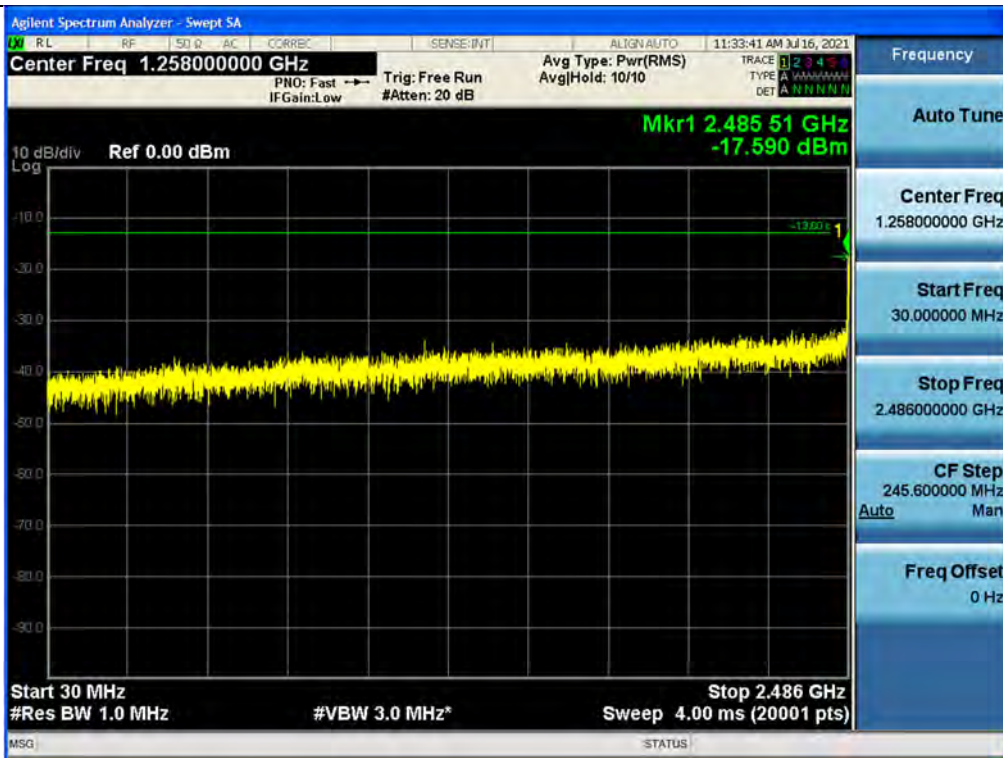

Spurious / BRS/EBS / Downlink / LTE 20 MHz / Low / Low Edge - 10 MHz ~ Low Edge

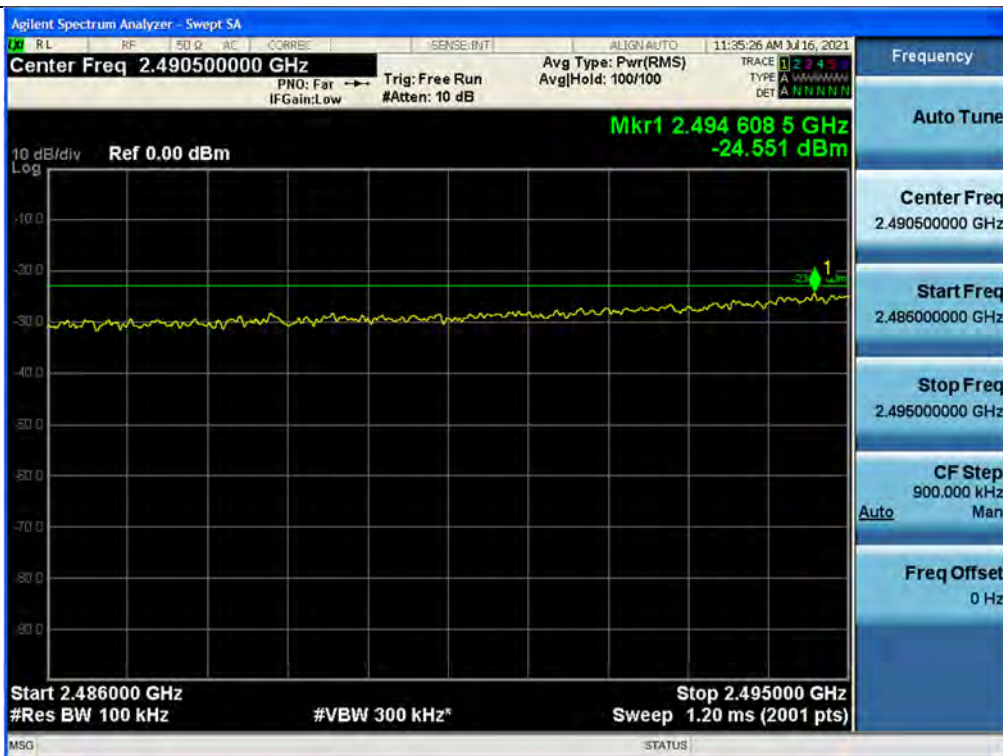

Spurious / BRS/EBS / Downlink / LTE 20 MHz / High / High Edge ~ High Edge + 10 MHz



Spurious / BRS/EBS / Downlink / LTE 20 MHz / High / High Edge + 10 MHz ~ 10 GHz

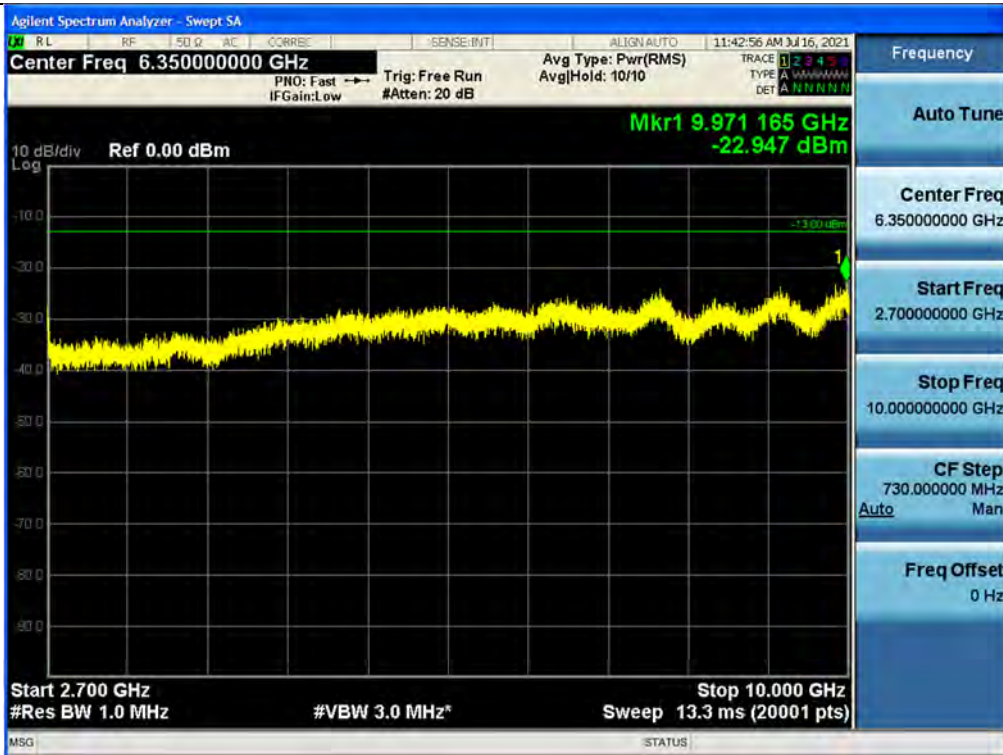

Spurious / BRS/EBS / Downlink / 5G NR 100 MHz / Middle / 10 GHz ~ 26.5 GHz



Note : Only the worst case Spurious Emissions plots are attached for each frequency range.

5.6. RADIATED SPURIOUS EMISSIONS

Test Requirements:

§ 2.1053 Measurements required: Field strength of spurious radiation.

- (a) Measurements shall be made to detect spurious emissions that may be radiated directly from the cabinet, control circuits, power leads, or intermediate circuit elements under normal conditions of installation and operation. Curves or equivalent data shall be supplied showing the magnitude of each harmonic and other spurious emission. For this test, single sideband, independent sideband, and controlled carrier transmitters shall be modulated under the conditions specified in paragraph (c) of § 2.1049, as appropriate. For equipment operating on frequencies below 890 MHz, an open field test is normally required, with the measuring instrument antenna located in the far-field at all test frequencies. In the event it is either impractical or impossible to make open field measurements (e.g. a broadcast transmitter installed in a building) measurements will be accepted of the equipment as installed. Such measurements must be accompanied by a description of the site where the measurements were made showing the location of any possible source of reflections which might distort the field strength measurements. Information submitted shall include the relative radiated power of each spurious emission with reference to the rated power output of the transmitter, assuming all emissions are radiated from halfwave dipole antennas.
- (b) The measurements specified in paragraph (a) of this section shall be made for the following equipment:
- (1) Those in which the spurious emissions are required to be 60 dB or more below the mean power of the transmitter.
 - (2) All equipment operating on frequencies higher than 25 MHz.
 - (3) All equipment where the antenna is an integral part of, and attached directly to the transmitter.
 - (4) Other types of equipment as required, when deemed necessary by the Commission.

Test Procedures:

Because KDB 935210 D05 procedure does not provide this requirement, measurements were in accordance with the test methods section 5.5 of ANSI C63.26-2015

- a) Place the EUT in the center of the turntable. The EUT shall be configured to transmit into the standard non-radiating load (for measuring radiated spurious emissions), connected with cables of minimal length unless specified otherwise. If the EUT uses an adjustable antenna, the antenna shall be positioned to the length that produces the worst case emission at the fundamental operating frequency.
- b) Each emission under consideration shall be evaluated:
- 1) Raise and lower the measurement antenna in accordance 5.5.2, as necessary to enable detection of the maximum emission amplitude relative to measurement antenna height.
 - 2) Rotate the EUT through 360° to determine the maximum emission level relative to the axial position.
 - 3) Return the turntable to the azimuth where the highest emission amplitude level was observed.
 - 4) Vary the measurement antenna height again through 1 m to 4 m again to find the height associated with the maximum emission amplitude.

- 5) Record the measured emission amplitude level and frequency using the appropriate RBW.
- c) Repeat step b) for each emission frequency with the measurement antenna oriented in both the horizontal and vertical polarizations to determine the orientation that gives the maximum emissions amplitude.

Test Result:

BRS/EBS_Downlink

Mode	Frequency (MHz)	Measured Level (dBuV)	Ant. Factor (dB/m)	A.G. + C.L. +H.P.F. (dB)	Pol.	Measured Power (dBm)	Result (dBm/m)
LTE 20 MHz	5 183.18	45.49	31.50	26.09	V	-49.71	-44.300
5G NR_100 MHz	5 189.68	46.08	31.50	26.09	V	-49.12	-43.710

* C.L.: Cable Loss / A.G.: Amp. Gain / H.P.F.: High Pass Filter

Note:

1. We have done horizontal and vertical polarization in detecting antenna.
2. Measure distance = 3 m
3. The amplitude of the spurious domain emission attenuated by more than 20 dB over the permissible value was not recorded according to ANSI C63.26, clause 5.1.1., c).
4. Test data were only the worst case.
5. Among the data of simultaneous and single band emission conditions, the single emission condition is the worst.

Plot data of radiated spurious emissions

Downlink / BRS/EBS

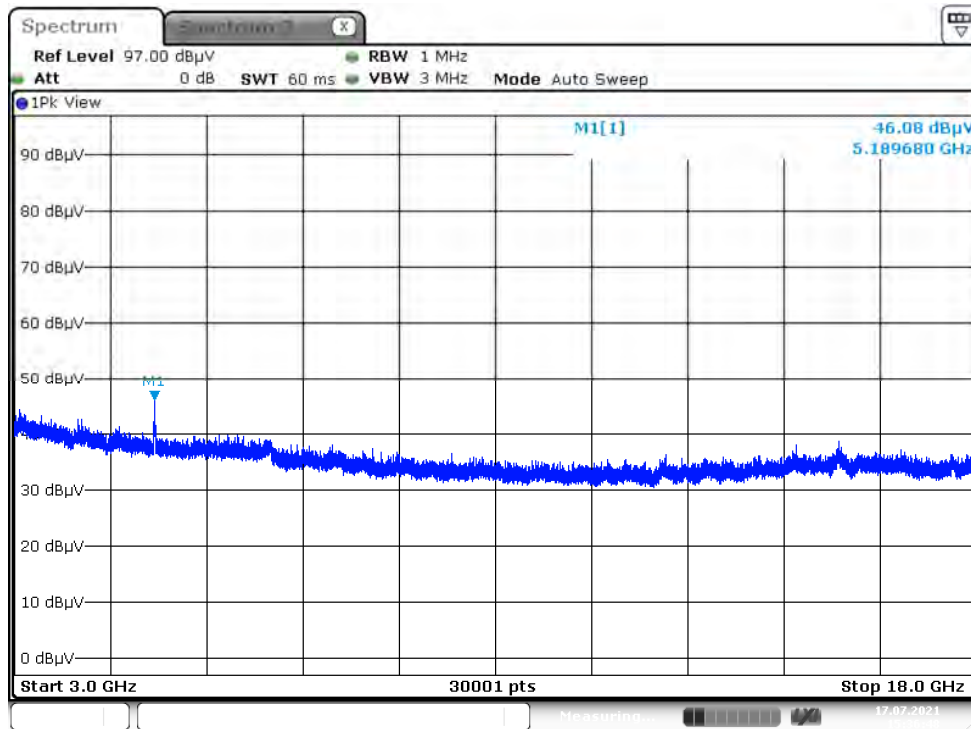

Note : Only the worst case plots for Radiated Spurious Emissions.

6. Annex A_EUT AND TEST SETUP PHOTO

Please refer to test setup photo file no. as follows;

No.	Description
1	HCT-RF-2108-FC001-P