

TEST REPORT

Applicant: FLYSKY RC MODEL TECHNOLOGY CO., LTD

Address of Applicant: West building3, Huangjianyuan Ind, Park QIAOLI North Gate
Changping Town, Dongguan, China

Manufacturer: ShenZhen FLYSKY Technology Co.,Ltd

Address of Manufacturer: ADD 16F, Huafeng Building, No. 6006 Shennan Road, Futian
District, Shenzhen, Guangdong, China

Factory: Dongguan Flysky RC Model technology Co.,Ltd

Address of Factory: West building 3, HuangjinyuanInd Park, QIAOLI North Gate,
Changping Town, Dongguan, China

Equipment Under Test (EUT)

Product Name: 2.4GHz 4CH RECEIVER

Model No.: FS-R4A

Trade Mark: FLYSKY

FCC ID: N4ZR4A00

Applicable standards: FCC CFR Title 47 Part 15 Subpart C Section 15.247

Date of sample receipt: April 27, 2021

Date of Test: April 28, 2021-May 14, 2021

Date of report issued: May 14, 2021

Test Result : PASS *

* In the configuration tested, the EUT complied with the standards specified above.

Authorized Signature:



Robinson Luo
Laboratory Manager

This results shown in this test report refer only to the sample(s) tested, this test report cannot be reproduced, except in full, without prior written permission of the company. The report would be invalid without specific stamp of test institute and the signatures of compiler and approver.

2 Version

Version No.	Date	Description
00	May 14, 2021	Original

Prepared By:

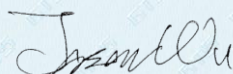

Date:

May 14, 2021

Project Engineer

Check By:

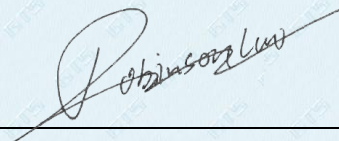

Date:

May 14, 2021

Reviewer

3 Contents

Page

1	COVER PAGE	1
2	VERSION	2
3	CONTENTS	3
4	TEST SUMMARY	4
4.1	MEASUREMENT UNCERTAINTY	4
5	GENERAL INFORMATION	5
5.1	GENERAL DESCRIPTION OF EUT	5
5.2	TEST MODE	7
5.3	TEST FACILITY	7
5.4	TEST LOCATION	7
5.5	DESCRIPTION OF SUPPORT UNITS	7
5.6	DEVIATION FROM STANDARDS.....	7
5.7	ABNORMALITIES FROM STANDARD CONDITIONS.....	7
5.8	ADDITIONAL INSTRUCTIONS.....	7
6	TEST INSTRUMENTS LIST	8
7	TEST RESULTS AND MEASUREMENT DATA	10
7.1	ANTENNA REQUIREMENT.....	10
7.2	CONDUCTED PEAK OUTPUT POWER.....	11
7.3	20dB EMISSION BANDWIDTH	13
7.4	CARRIER FREQUENCIES SEPARATION.....	15
7.5	HOPPING CHANNEL NUMBER	17
7.6	DWELL TIME	18
7.7	SPURIOUS EMISSION IN NON-RESTRICTED & RESTRICTED BANDS.....	22
7.7.1	Conducted Emission Method	22
7.7.2	Radiated Emission Method	26
8	TEST SETUP PHOTO	45
9	EUT CONSTRUCTIONAL DETAILS.....	45

4 Test Summary

Test Item	Section	Result
Antenna Requirement	15.203/15.247 (c)	Pass
AC Power Line Conducted Emission	15.207	N/A
Conducted Peak Output Power	15.247 (b)(1)	Pass
20dB Occupied Bandwidth	15.247 (a)(1)	Pass
Carrier Frequencies Separation	15.247 (a)(1)	Pass
Hopping Channel Number	15.247 (a)(1)	Pass
Dwell Time	15.247 (a)(1)	Pass
Pseudorandom Frequency Hopping Sequence	15.247(b)(4)	Pass
Radiated Emission	15.205/15.209	Pass
Band Edge	15.247(d)	Pass

Pass: The EUT complies with the essential requirements in the standard.

Remark : Test according to ANSI C63.10:2013.

4.1 Measurement Uncertainty

Test Item	Frequency Range	Measurement Uncertainty	Notes
Radiated Emission	30MHz-200MHz	3.8039dB	(1)
Radiated Emission	200MHz-1GHz	3.9679dB	(1)
Radiated Emission	1GHz-18GHz	4.29dB	(1)
Radiated Emission	18GHz-40GHz	3.30dB	(1)
AC Power Line Conducted Emission	0.15MHz ~ 30MHz	3.44dB	(1)

Note (1): The measurement uncertainty is for coverage factor of k=2 and a level of confidence of 95%.

5 General Information

5.1 General Description of EUT

Product Name:	2.4GHz 4CH RECEIVER
Model No.:	FS-R4A
Serial No.:	N/A
Test sample(s) ID:	GTS202104000274-1
Sample(s) Status	Engineer sample
Operation Frequency:	2406MHz~2472MHz
Channel numbers:	133
Modulation technology:	GMSK
Antenna Type:	Integral Antenna
Antenna gain:	-1dBi
Power supply:	DC 3.5-9V

Remark: The system works in the frequency range of 2406MHz to 2472MHz. This band has been divided to 133 independent channels. Each radio system uses 20 different channels; the minimum channel separation is ≥ 2.5 MHz. By using various switch-on times, hopping scheme and channel frequencies, the system can guarantee a jamming free radio transmission. The channel list is below.

The test frequencies are below:

Channel	Frequency
The lowest channel	2406MHz
The middle channel	2440MHz
The Highest channel	2472MHz

Operation Frequency each of channel							
Channel	Frequency (MHz)	Channel	Frequency (MHz)	Channel	Frequency (MHz)	Channel	Frequency (MHz)
1	2406.0	36	2423.5	71	2441.0	106	2458.5
2	2406.5	37	2424.0	72	2441.5	107	2459.0
3	2407.0	38	2424.5	73	2442.0	108	2459.5
4	2407.5	39	2425.0	74	2442.5	109	2460.0
5	2408.0	40	2425.5	75	2443.0	110	2460.5
6	2408.5	41	2426.0	76	2443.5	111	2461.0
7	2409.0	42	2426.5	77	2444.0	112	2461.5
8	2409.5	43	2427.0	78	2444.5	113	2462.0
9	2410.0	44	2427.5	79	2445.0	114	2462.5
10	2410.5	45	2428.0	80	2445.5	115	2463.0
11	2411.0	46	2428.5	81	2446.0	116	2463.5
12	2411.5	47	2429.0	82	2446.5	117	2464.0
13	2412.0	48	2429.5	83	2447.0	118	2464.5
14	2412.5	49	2430.0	84	2447.5	119	2465.0
15	2413.0	50	2430.5	85	2448.0	120	2465.5
16	2413.5	51	2431.0	86	2448.5	121	2466.0
17	2414.0	52	2431.5	87	2449.0	122	2466.5
18	2414.5	53	2432.0	88	2449.5	123	2467.0
19	2415.0	54	2432.5	89	2450.0	124	2467.5
20	2415.5	55	2433.0	90	2450.5	125	2468.0
21	2416.0	56	2433.5	91	2451.0	126	2468.5
22	2416.5	57	2434.0	92	2451.5	127	2469.0
23	2417.0	58	2434.5	93	2452.0	128	2469.5
24	2417.5	59	2435.0	94	2452.5	129	2470.0
25	2418.0	60	2435.5	95	2453.0	130	2470.5
26	2418.5	61	2436.0	96	2453.5	131	2471.0
27	2419.0	62	2436.5	97	2454.0	132	2471.5
28	2419.5	63	2437.0	98	2454.5	133	2472.0
29	2420.0	64	2437.5	99	2455.0		
30	2420.5	65	2438.0	100	2455.5		
31	2421.0	66	2438.5	101	2456.0		
32	2421.5	67	2439.0	102	2456.5		
33	2422.0	68	2439.5	103	2457.0		
34	2422.5	69	2440.0	104	2457.5		
35	2423.0	70	2440.5	105	2458.0		

5.2 Test mode

Transmitting mode	Keep the EUT in transmitting mode.
Remark: DC 3.5 to 9V all have been pretested, only worse case DC 9V is reported	

5.3 Test Facility

<p>The test facility is recognized, certified, or accredited by the following organizations:</p> <ul style="list-style-type: none"> ● FCC —Registration No.: 381383 Global United Technology Services Co., Ltd., Shenzhen EMC Laboratory has been registered and fully described in a report filed with the (FCC) Federal Communications Commission. The acceptance letter from the FCC is maintained in files. Registration 381383. ● IC —Registration No.: 9079A The 3m Semi-anechoic chamber of Global United Technology Services Co., Ltd. has been registered by Certification and Engineering Bureau of Industry Canada for radio equipment testing with Registration No.: 9079A ● NVLAP (LAB CODE:600179-0) Global United Technology Services Co., Ltd., is accredited by the National Voluntary Laboratory Accreditation Program (NVLAP). LAB CODE:600179-0

5.4 Test Location

All other tests were performed at:
<p>Global United Technology Services Co., Ltd. Address: No. 123-128, Tower A, Jinyuan Business Building, No.2, Laodong Industrial Zone, Xixiang Road, Baoan District, Shenzhen, Guangdong, China 518102 Tel: 0755-27798480 Fax: 0755-27798960</p>

5.5 Description of Support Units

Manufacturer	Description	Model	Serial Number
ShenZhen FLYSKY Technology Co.,Ltd	Remote control	F6S	N/A
MEILI	DC POWER SUPPLY	MCH-305A	011121168

5.6 Deviation from Standards

None.

5.7 Abnormalities from Standard Conditions

None.

5.8 Additional Instructions

Software (Used for test) from client
Built-in by manufacturer, power set default.

6 Test Instruments list

Radiated Emission:						
Item	Test Equipment	Manufacturer	Model No.	Inventory No.	Cal.Date (mm-dd-yy)	Cal.Due date (mm-dd-yy)
1	3m Semi- Anechoic Chamber	ZhongYu Electron	9.2(L)*6.2(W)* 6.4(H)	GTS250	July. 02 2020	July. 01 2025
2	Control Room	ZhongYu Electron	6.2(L)*2.5(W)* 2.4(H)	GTS251	N/A	N/A
3	EMI Test Receiver	Rohde & Schwarz	ESU26	GTS203	June. 25 2020	June. 24 2021
4	BiConiLog Antenna	SCHWARZBECK MESS-ELEKTRONIK	VULB9163	GTS214	June. 25 2020	June. 24 2021
5	Double -ridged waveguide horn	SCHWARZBECK MESS-ELEKTRONIK	BBHA 9120 D	GTS208	June. 25 2020	June. 24 2021
6	Horn Antenna	ETS-LINDGREN	3160	GTS217	June. 25 2020	June. 24 2021
7	EMI Test Software	AUDIX	E3	N/A	N/A	N/A
8	Coaxial Cable	GTS	N/A	GTS213	June. 25 2020	June. 24 2021
9	Coaxial Cable	GTS	N/A	GTS211	June. 25 2020	June. 24 2021
10	Coaxial cable	GTS	N/A	GTS210	June. 25 2020	June. 24 2021
11	Coaxial Cable	GTS	N/A	GTS212	June. 25 2020	June. 24 2021
12	Amplifier(100kHz-3GHz)	HP	8347A	GTS204	June. 25 2020	June. 24 2021
13	Amplifier(2GHz-20GHz)	HP	84722A	GTS206	June. 25 2020	June. 24 2021
14	Amplifier (18-26GHz)	Rohde & Schwarz	AFS33-18002 650-30-8P-44	GTS218	June. 25 2020	June. 24 2021
15	Band filter	Amindeon	82346	GTS219	June. 25 2020	June. 24 2021
16	Power Meter	Anritsu	ML2495A	GTS540	June. 25 2020	June. 24 2021
17	Power Sensor	Anritsu	MA2411B	GTS541	June. 25 2020	June. 24 2021
18	Wideband Radio Communication Tester	Rohde & Schwarz	CMW500	GTS575	June. 25 2020	June. 24 2021
19	Splitter	Agilent	11636B	GTS237	June. 25 2020	June. 24 2021
20	Loop Antenna	ZHINAN	ZN30900A	GTS534	June. 25 2020	June. 24 2021
21	Breitband hornantenne	SCHWARZBECK	BBHA 9170	GTS579	Oct. 18 2020	Oct. 17 2021
22	Amplifier	TDK	PA-02-02	GTS574	Oct. 18 2020	Oct. 17 2021
23	Amplifier	TDK	PA-02-03	GTS576	Oct. 18 2020	Oct. 17 2021
24	PSA Series Spectrum Analyzer	Rohde & Schwarz	FSP	GTS578	June. 25 2020	June. 24 2021

RF Conducted Test:						
Item	Test Equipment	Manufacturer	Model No.	Serial No.	Cal.Date (mm-dd-yy)	Cal.Due date (mm-dd-yy)
1	MXA Signal Analyzer	Agilent	N9020A	GTS566	June. 25 2020	June. 24 2021
2	EMI Test Receiver	R&S	ESCI 7	GTS552	June. 25 2020	June. 24 2021
3	Spectrum Analyzer	Agilent	E4440A	GTS533	June. 25 2020	June. 24 2021
4	MXG vector Signal Generator	Agilent	N5182A	GTS567	June. 25 2020	June. 24 2021
5	ESG Analog Signal Generator	Agilent	E4428C	GTS568	June. 25 2020	June. 24 2021
6	USB RF Power Sensor	DARE	RPR3006W	GTS569	June. 25 2020	June. 24 2021
7	RF Switch Box	Shongyi	RFSW3003328	GTS571	June. 25 2020	June. 24 2021
8	Programmable Constant Temp & Humi Test Chamber	WEWON	WHTH-150L-40-880	GTS572	June. 25 2020	June. 24 2021

General used equipment:						
Item	Test Equipment	Manufacturer	Model No.	Inventory No.	Cal.Date (mm-dd-yy)	Cal.Due date (mm-dd-yy)
1	Humidity/ Temperature Indicator	KTJ	TA328	GTS243	June. 25 2020	June. 24 2021
2	Barometer	ChangChun	DYM3	GTS255	June. 25 2020	June. 24 2021

7 Test results and Measurement Data

7.1 Antenna requirement

Standard requirement:	FCC Part15 C Section 15.203 /247(c)
<p>15.203 requirement:</p> <p>An intentional radiator shall be designed to ensure that no antenna other than that furnished by the responsible party shall be used with the device. The use of a permanently attached antenna or of an antenna that uses a unique coupling to the intentional radiator, the manufacturer may design the unit so that a broken antenna can be replaced by the user, but the use of a standard antenna jack or electrical connector is prohibited.</p> <p>15.247(c) (1)(i) requirement:</p> <p>(i) Systems operating in the 2400-2483.5 MHz band that is used exclusively for fixed. Point-to-point operations may employ transmitting antennas with directional gain greater than 6dBi provided the maximum conducted output power of the intentional radiator is reduced by 1 dB for every 3 dB that the directional gain of the antenna exceeds 6dBi.</p>	
EUT Antenna:	
<p><i>The antenna is integral antenna, the best case gain of the antenna is -1dBi, reference to the appendix II for details.</i></p>	

7.2 Conducted Peak Output Power

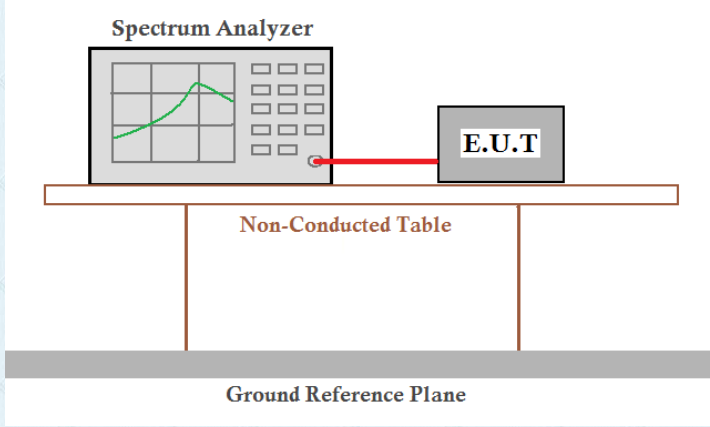
Test Requirement:	FCC Part15 C Section 15.247 (b)(1)
Test Method:	ANSI C63.10:2013
Limit:	20.97dBm
Test setup:	 <p>The diagram illustrates the test setup. A Spectrum Analyzer is connected to an E.U.T. (Equipment Under Test) via a red cable. Both the Spectrum Analyzer and the E.U.T. are placed on a Non-Conducted Table. The table is supported by a Ground Reference Plane.</p>
Test Instruments:	Refer to section 6.0 for details
Test mode:	Refer to section 5.2 for details
Test results:	Pass

Measurement Data

Test channel	Peak Output Power (dBm)	Limit (dBm)	Result
Lowest	13.62	20.97	Pass
Middle	13.30		Pass
Highest	12.72		Pass

Test plot as follows:

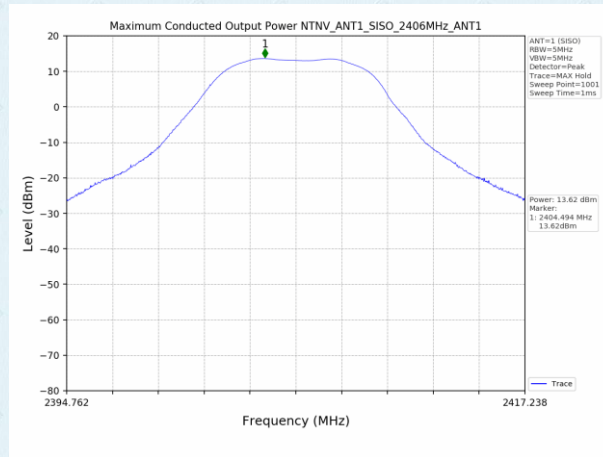

Lowest channel

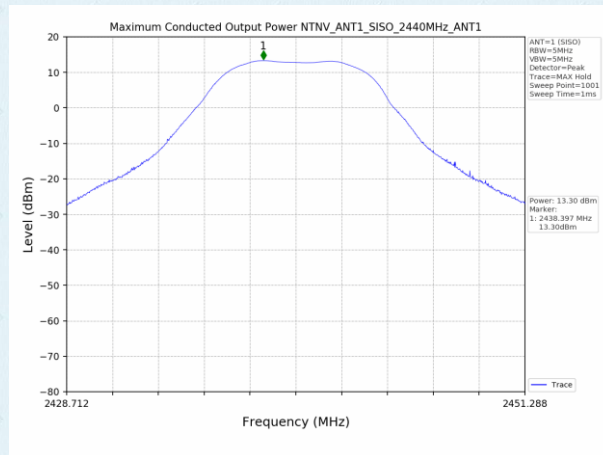

Middle channel

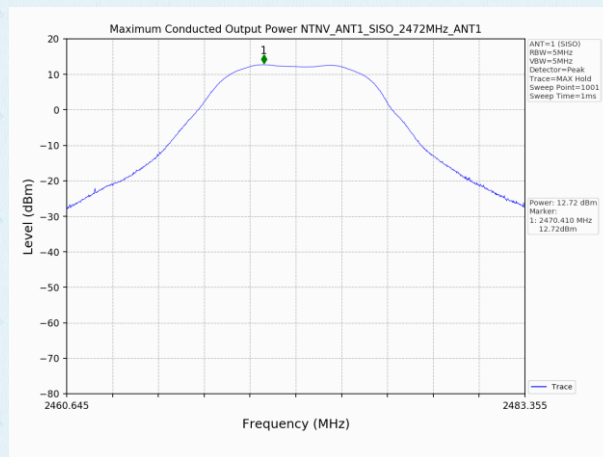

Highest channel

7.3 20dB Emission Bandwidth

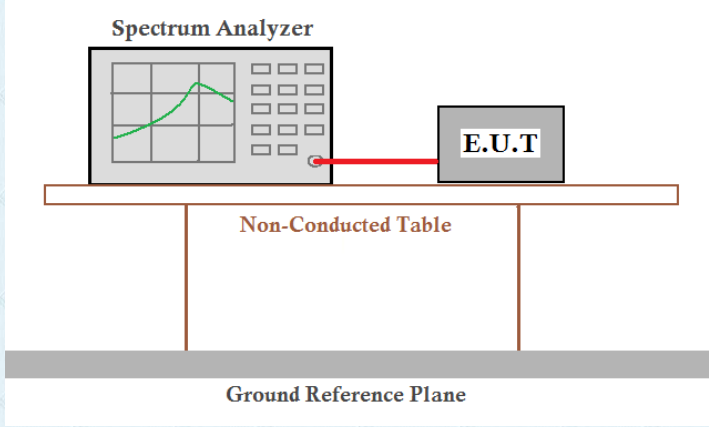
Test Requirement:	FCC Part15 C Section 15.247 (a)(1)
Test Method:	ANSI C63.10:2013
Limit:	N/A
Test setup:	 <p>The diagram illustrates the test setup. A Spectrum Analyzer is connected to an E.U.T. (Equipment Under Test) via a red cable. Both are placed on a Non-Conducted Table, which sits on a Ground Reference Plane.</p>
Test Instruments:	Refer to section 6.0 for details
Test mode:	Refer to section 5.2 for details
Test results:	Pass

Measurement Data

Test channel	20dB Emission Bandwidth (MHz)	Result
Lowest	4.495	Pass
Middle	4.515	
Highest	4.542	

Test plot as follows:

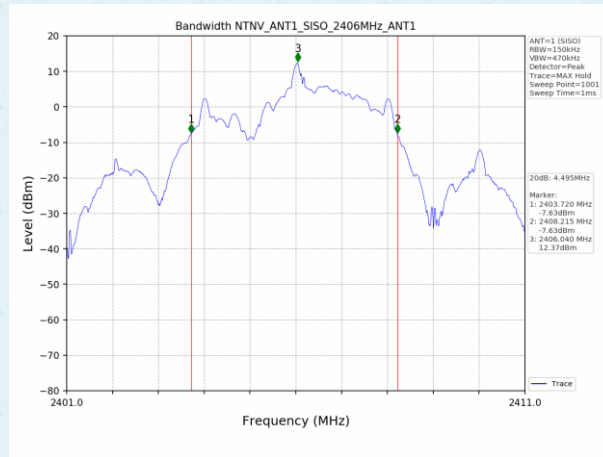

Lowest channel

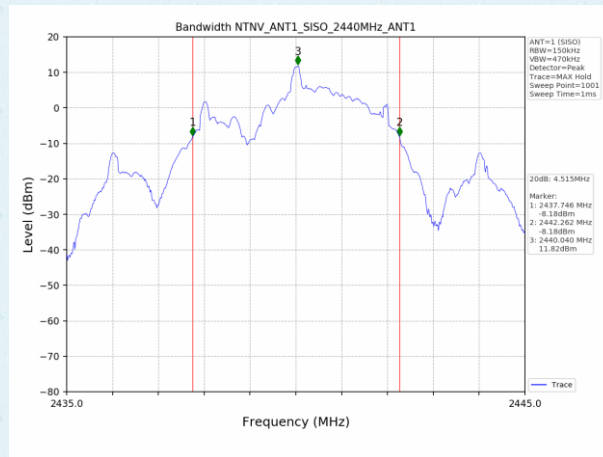

Middle channel

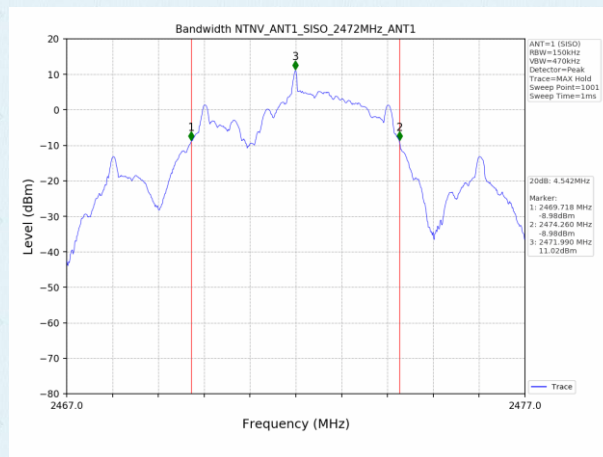

Highest channel

7.4 Carrier Frequencies Separation

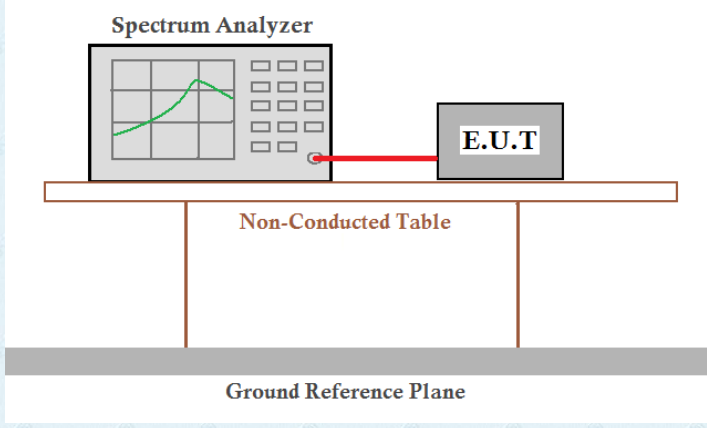
Test Requirement:	FCC Part15 C Section 15.247 (a)(1)
Test Method:	ANSI C63.10:2013
Receiver setup:	RBW=100KHz, VBW=300KHz, detector=Peak
Limit:	0.025MHz or 2/3 of the 20dB bandwidth (whichever is greater)
Test setup:	 <p>The diagram illustrates the test setup. A Spectrum Analyzer is connected to an E.U.T. (Equipment Under Test) via a red cable. Both are placed on a Non-Conducted Table, which is supported by a Ground Reference Plane.</p>
Test Instruments:	Refer to section 6.0 for details
Test mode:	Refer to section 5.2 for details
Test results:	Pass

Measurement Data

Test channel	Carrier Frequencies Separation (kHz)	Limit (kHz)	Result
Lowest	3055	3028	Pass
Middle	3040	3028	Pass
Highest	3100	3028	Pass

Test plot as follows:

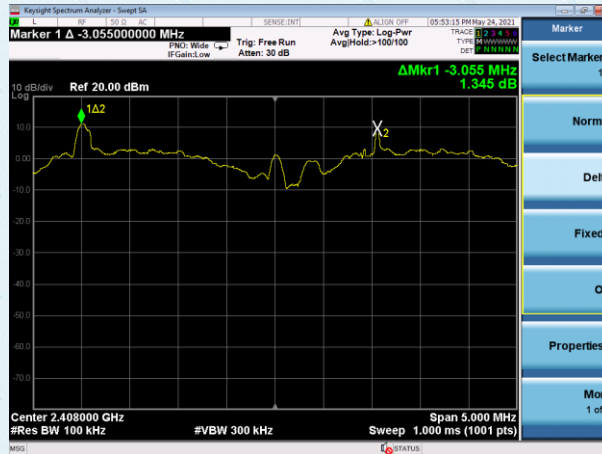

Lowest channel

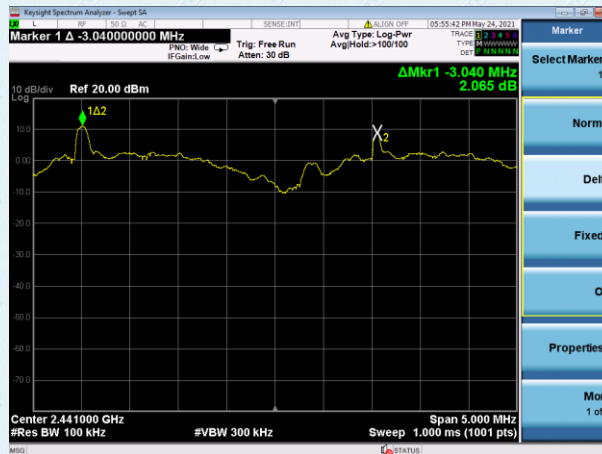

Middle channel

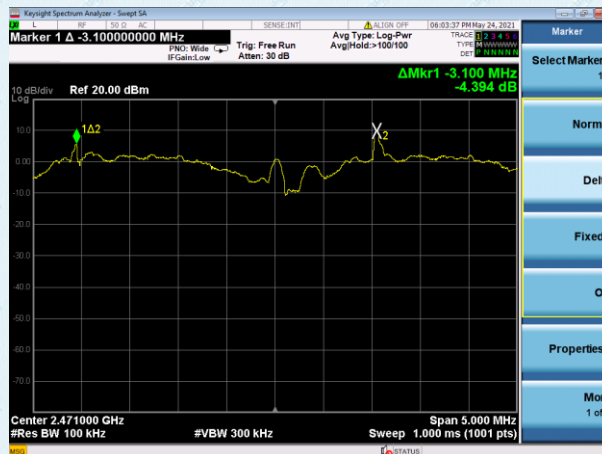

Highest channel

7.5 Hopping Channel Number

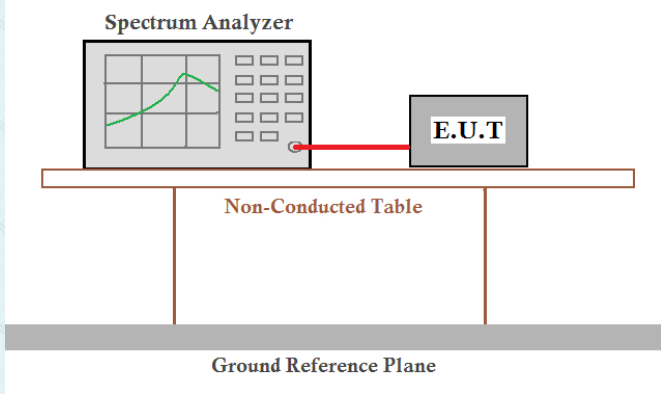
Test Requirement:	FCC Part15 C Section 15.247 (a)(1)
Test Method:	ANSI C63.10:2013
Receiver setup:	RBW=100kHz, VBW=300kHz, Frequency range=2400MHz-2483.5MHz, Detector=Peak
Limit:	15 channels
Test setup:	 <p>The diagram illustrates the test setup. A Spectrum Analyzer is connected via a red cable to an E.U.T. (Equipment Under Test). Both are placed on a Non-Conducted Table. Below the table is a Ground Reference Plane.</p>
Test Instruments:	Refer to section 6.0 for details
Test mode:	Refer to section 5.2 for details
Test results:	Pass

Measurement Data:

Hopping channel numbers	Limit	Result
20	15	Pass

Test plot as follows:

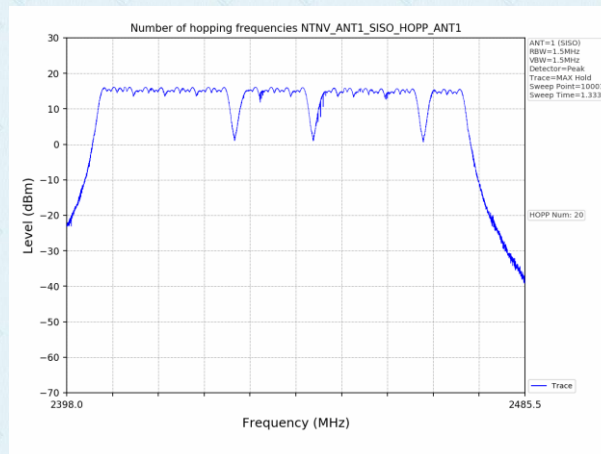

7.6 Dwell Time

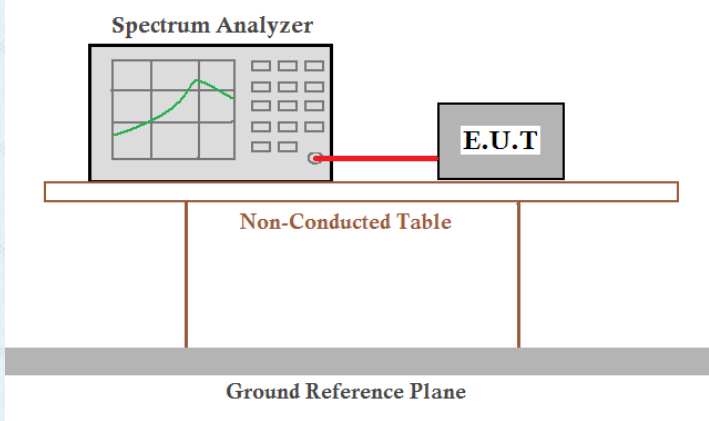
Test Requirement:	FCC Part15 C Section 15.247 (a)(1)
Test Method:	ANSI C63.10:2013
Receiver setup:	RBW=1MHz, VBW=1MHz, Span=0Hz, Detector=Peak
Limit:	0.4 Second
Test setup:	
Test Instruments:	Refer to section 6.0 for details
Test mode:	Refer to section 5.2 for details
Test results:	Pass

Measurement Data

Frequency(MHz)	Ton (ms)	Dwell time(ms)	Limit(ms)	Result
2406	3.080	73.92	400	Pass
2440	3.010	72.24	400	Pass
2472	3.080	73.92	400	Pass

The formula as below:

2406MHz: Dwell time = Ton * Ton times in 1s * 0.4s * channel numbers=3.080ms*3*0.4*20=73.92ms

2440MHz: Dwell time = Ton * Ton times in 1s * 0.4s * channel numbers=3.010ms*3*0.4*20=72.24ms

2472MHz: Dwell time = Ton * Ton times in 1s * 0.4s * channel numbers=3.080ms*3*0.4*20=73.92ms

Test plot as follows:

Frequency:	2406MHz
------------	---------

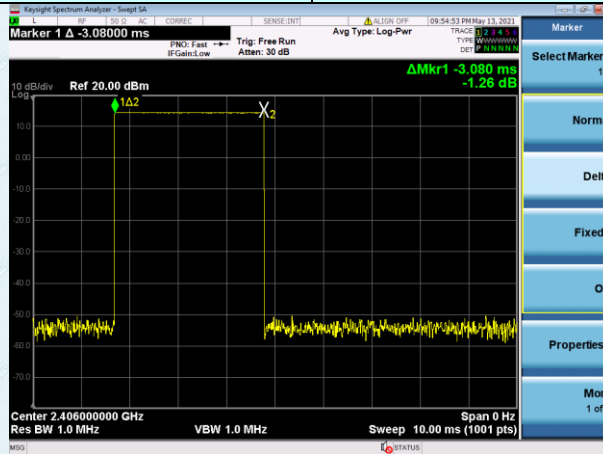

Ton

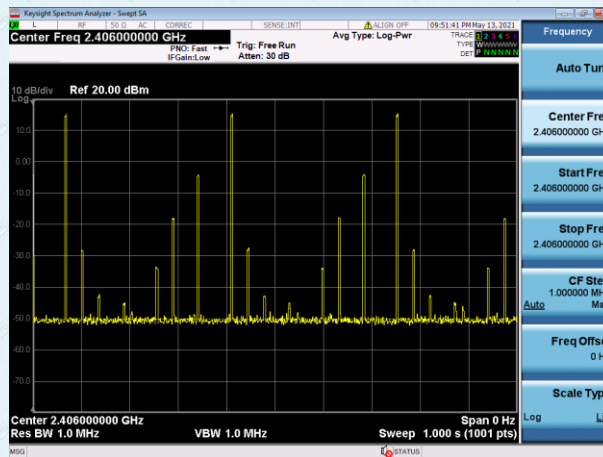

Ton times in 1s

Frequency: 2440MHz

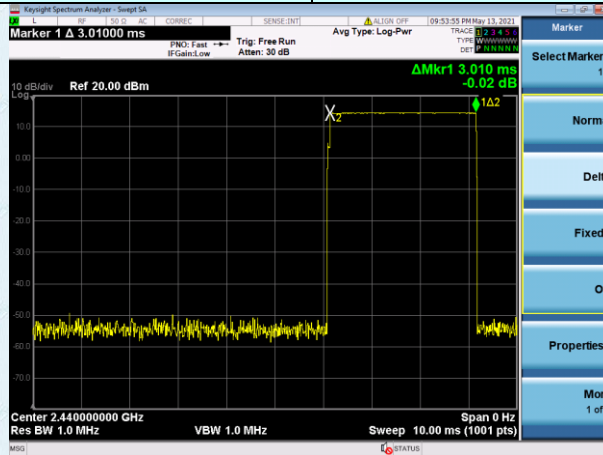

Ton

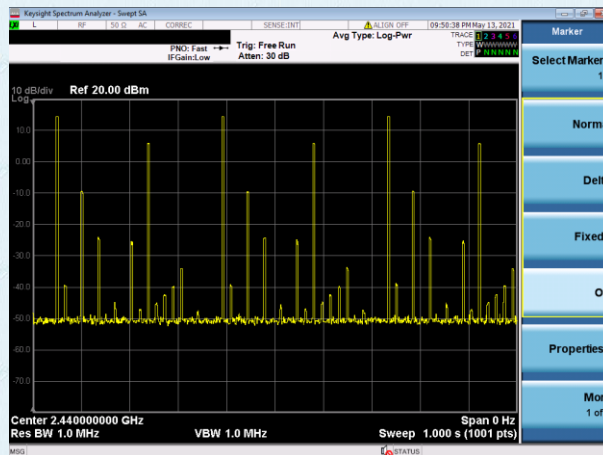

Ton times in 1s

Frequency: 2472MHz

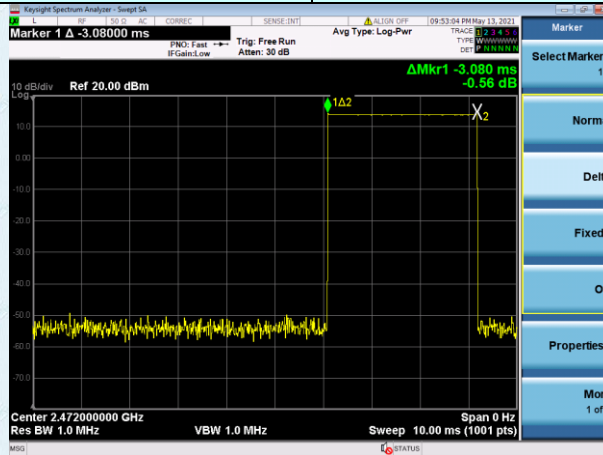

Ton

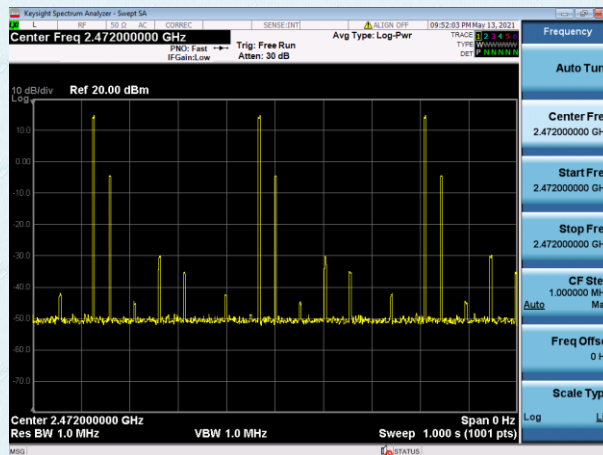

Ton times in 1s

7.7 Spurious Emission in Non-restricted & restricted Bands

7.7.1 Conducted Emission Method

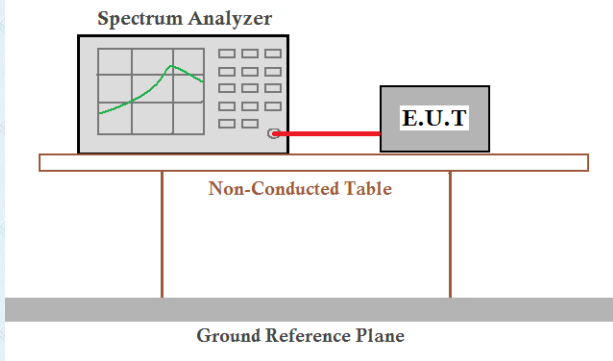
Test Requirement:	FCC Part15 C Section 15.247 (d)
Test Method:	ANSI C63.10:2013
Receiver setup:	RBW=100kHz, VBW=300kHz, Detector=Peak
Limit:	In any 100 kHz bandwidth outside the frequency band in which the spread spectrum intentional radiator is operating, the radio frequency power that is produced by the intentional radiator shall be at least 20 dB below that in the 100 kHz bandwidth within the band that contains the highest level of the desired power, based on either an RF conducted or a radiated measurement.
Test setup:	
Test Instruments:	Refer to section 6.0 for details
Test mode:	Refer to section 5.2 for details
Test results:	Pass

Measurement data:

Test Mode	Frequency (MHz)	TX Type	ANT No.	Spurious Conducted Emission (dBm)	Limits (dBm)	Verdict
ANT1	2406	SISO	1	Refer to test graph	-8.20	PASS
	2440	SISO	1	Refer to test graph	-8.20	PASS
	2472	SISO	1	Refer to test graph	-8.20	PASS
	Hopping	SISO	1	Refer to test graph	-8.20	PASS

Test plot as follows:

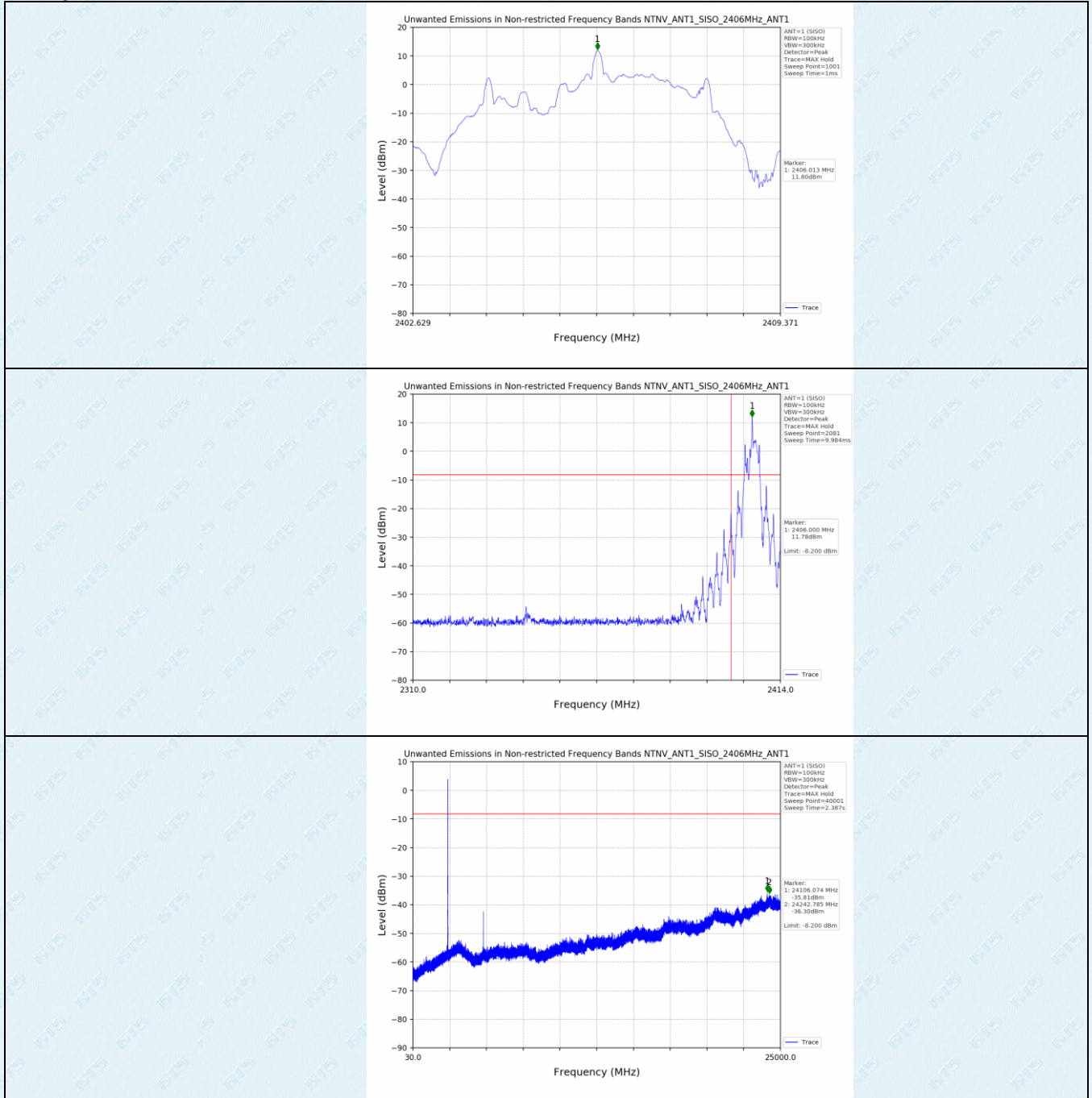

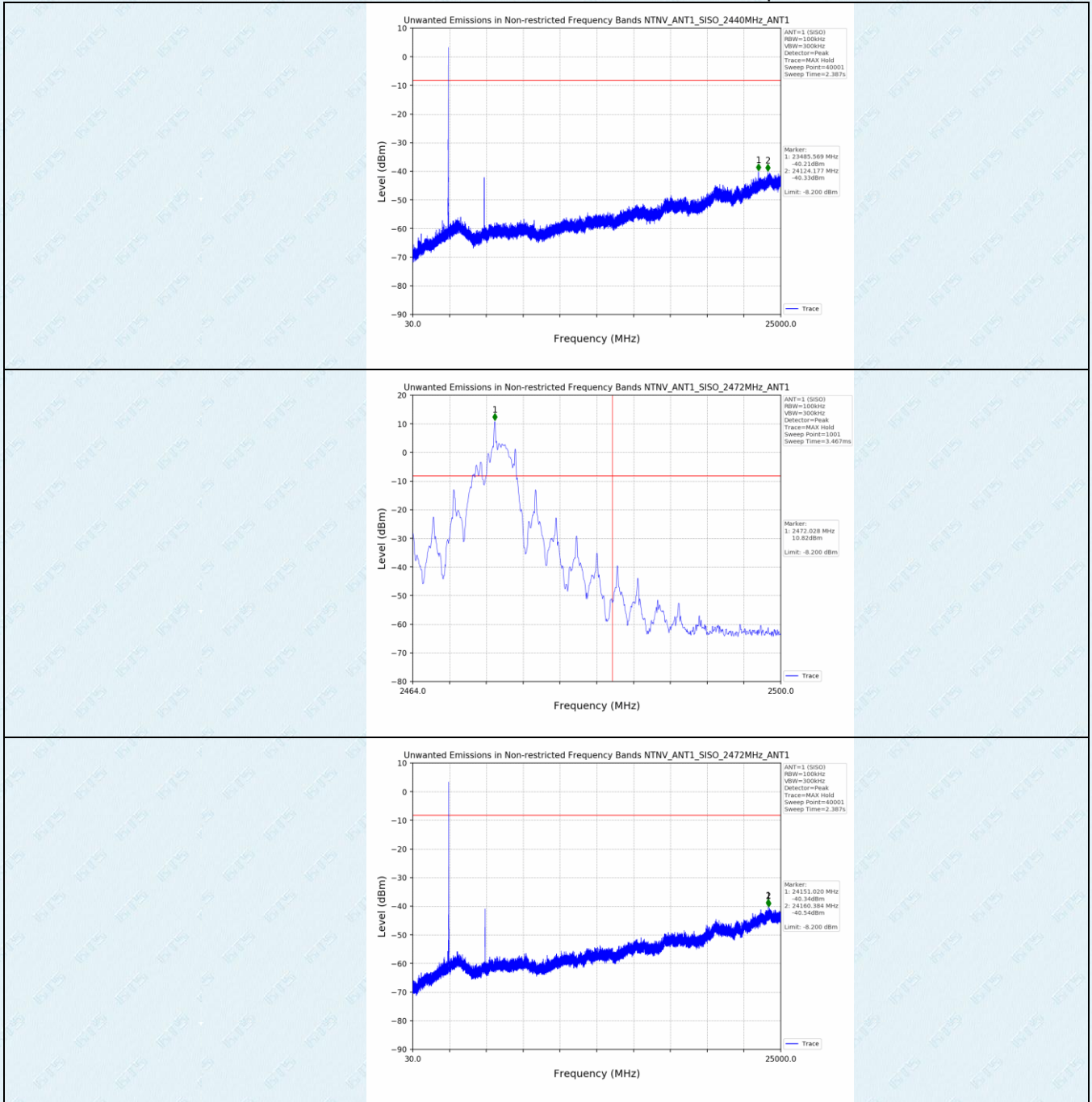

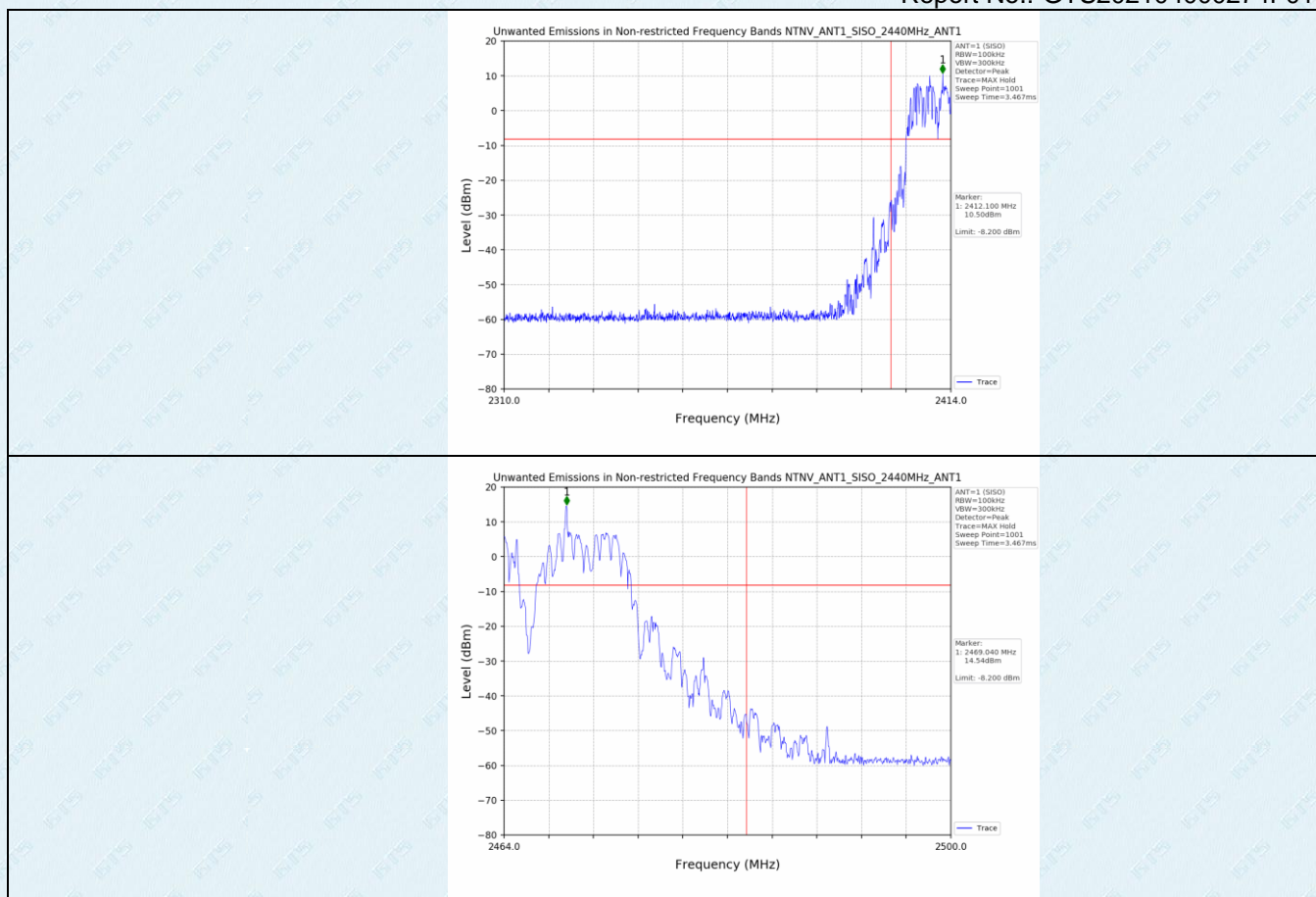

7.7.2 Radiated Emission Method

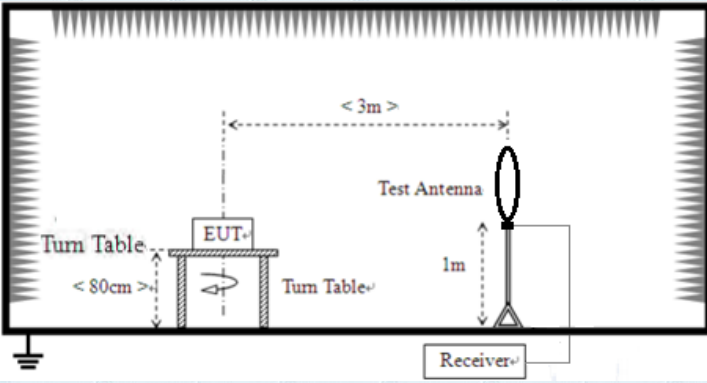
Test Requirement:	FCC Part15 C Section 15.209				
Test Method:	ANSI C63.10:2013				
Test Frequency Range:	9kHz to 25GHz				
Test site:	Measurement Distance: 3m				
Receiver setup:	Frequency	Detector	RBW	VBW	Value
	9KHz-150KHz	Quasi-peak	200Hz	600Hz	Quasi-peak
	150KHz-30MHz	Quasi-peak	9KHz	30KHz	Quasi-peak
	30MHz-1GHz	Quasi-peak	100KHz	300KHz	Quasi-peak
	Above 1GHz	Peak	1MHz	3MHz	Peak
Peak		1MHz	10Hz	Average	
Limit: (Spurious Emissions)	Frequency	Limit (uV/m)	Value	Measurement Distance	
	0.009MHz-0.490MHz	2400/F(KHz)	QP	300m	
	0.490MHz-1.705MHz	24000/F(KHz)	QP	300m	
	1.705MHz-30MHz	30	QP	30m	
	30MHz-88MHz	100	QP	3m	
	88MHz-216MHz	150	QP		
	216MHz-960MHz	200	QP		
	960MHz-1GHz	500	QP		
	Above 1GHz	500	Average		
5000		Peak			
Test setup:	Below 30MHz				
					
Below 1GHz					

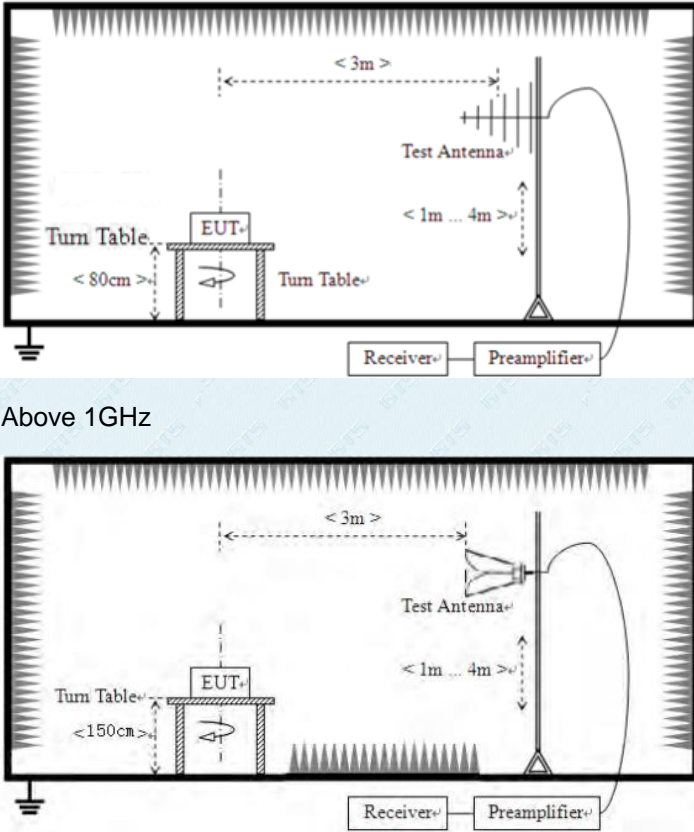
	 <p>Above 1GHz</p>						
<p>Test Procedure:</p>	<ol style="list-style-type: none"> 1. The EUT was placed on the top of a rotating table (0.8 meters for below 1GHz and 1.5meters for above 1GHz) above the ground at a 3 meter camber. The table was rotated 360 degrees to determine the position of the highest radiation. 2. The EUT was set 3 meters away from the interference-receiving antenna, which was mounted on the top of a variable-height antenna tower. 3. The antenna height is varied from one meter to four meters above the ground to determine the maximum value of the field strength. Both horizontal and vertical polarizations of the antenna are set to make the measurement. 4. For each suspected emission, the EUT was arranged to its worst case and then the antenna was tuned to heights from 1 meter to 4 meters and the rota table was turned from 0 degrees to 360 degrees to find the maximum reading. 5. The test-receiver system was set to Peak Detect Function and Specified Bandwidth with Maximum Hold Mode. 6. If the emission level of the EUT in peak mode was 10dB lower than the limit specified, then testing could be stopped and the peak values of the EUT would be reported. Otherwise the emissions that did not have 10dB margin would be re-tested one by one using peak, quasi-peak or average method as specified and then reported in a data sheet. 						
<p>Test Instruments:</p>	<p>Refer to section 5.8 for details</p>						
<p>Test mode:</p>	<p>Refer to section 5.2 for details</p>						
<p>Temp. / Hum.</p>	<table border="1"> <tr> <td>Temp.:</td> <td>25 °C</td> <td>Humid.:</td> <td>52%</td> <td>Press.:</td> <td>1 012mbar</td> </tr> </table>	Temp.:	25 °C	Humid.:	52%	Press.:	1 012mbar
Temp.:	25 °C	Humid.:	52%	Press.:	1 012mbar		

Test results:	Pass
---------------	------

Remark:

1. *Pre-scan all kind of the place mode (X-axis, Y-axis, Z-axis), and found the Y-axis which it is worse case.*

Measurement data:

■ **Below 30MHz**

The low frequency, which started from 9 kHz to 30 MHz, was pre-scanned and the result which was 20 dB lower than the limit line per 15.31(o) was not reported.

■ 30MHz ~ 1GHz

Test channel:	Lowest	Polarization:	Horizontal
---------------	--------	---------------	------------

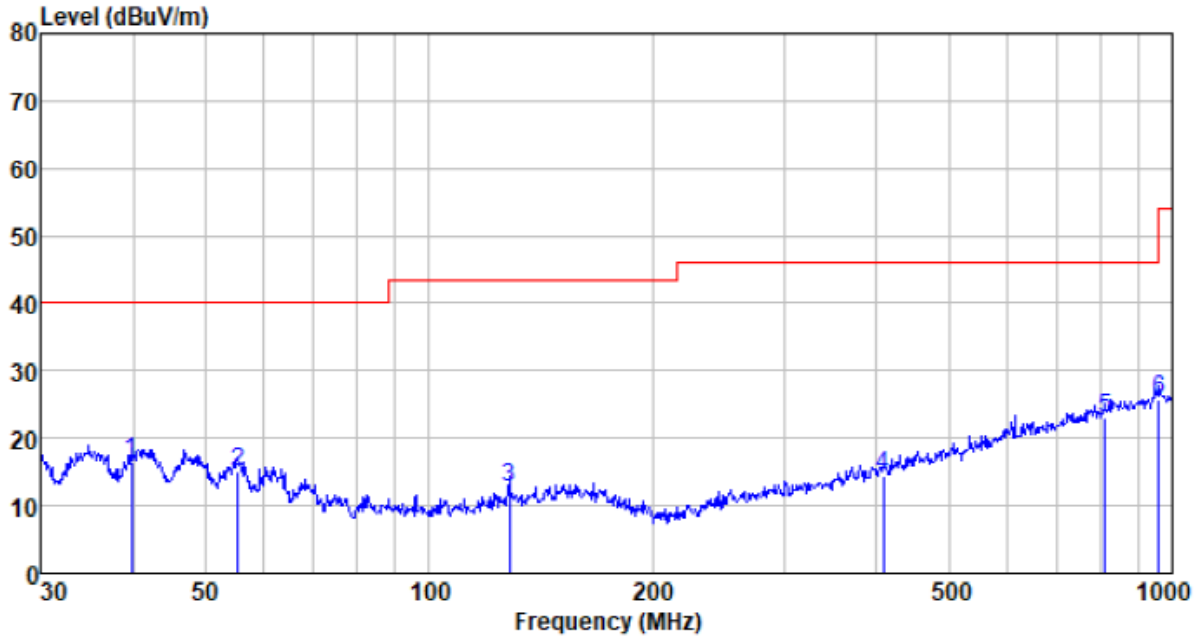

Freq MHz	Reading level dBuV	Antenna factor dB/m	Cable loss dB	Preamp factor dB	level dBuV/m	Limit level dBuV/m	Over limit dB	Remark
39.715	38.35	13.22	0.66	35.65	16.58	40.00	-23.42	QP
55.221	37.90	12.54	0.82	36.26	15.00	40.00	-25.00	QP
128.113	36.57	11.51	1.42	36.94	12.56	43.50	-30.94	QP
408.946	34.07	14.93	2.90	37.52	14.38	46.00	-31.62	QP
813.112	33.89	22.33	4.51	37.62	23.11	46.00	-22.89	QP
958.794	34.13	23.98	5.08	37.55	25.64	46.00	-20.36	QP

Test channel:	Lowest	Polarization:	Vertical
---------------	--------	---------------	----------

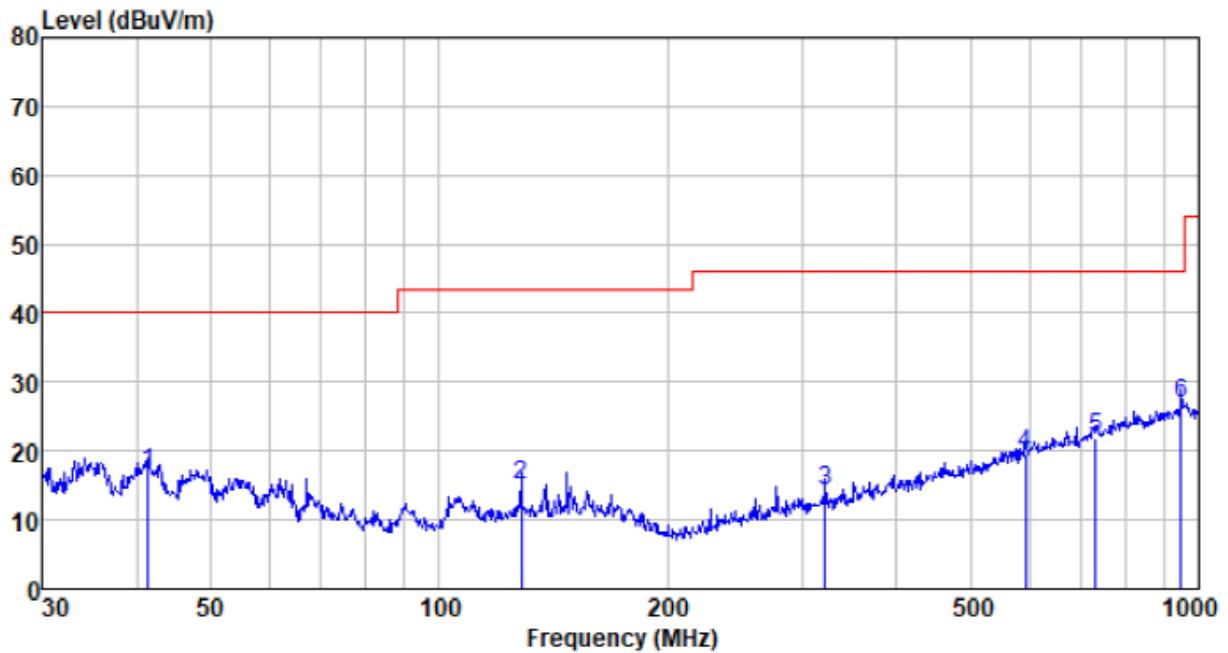

Freq MHz	Reading level dBuV	Antenna factor dB/m	Cable loss dB	Preamp factor dB	level dBuV/m	Limit level dBuV/m	Over limit dB	Remark
41.422	38.82	13.17	0.68	35.75	16.92	40.00	-23.08	QP
128.113	38.96	11.51	1.42	36.94	14.95	43.50	-28.55	QP
322.189	35.97	13.03	2.48	37.44	14.04	46.00	-31.96	QP
590.974	34.41	19.01	3.69	37.54	19.57	46.00	-26.43	QP
731.920	34.04	21.13	4.20	37.63	21.74	46.00	-24.26	QP
948.761	35.42	23.95	5.04	37.55	26.86	46.00	-19.14	QP

Test channel:	Middle	Polarization:	Horizontal
---------------	--------	---------------	------------

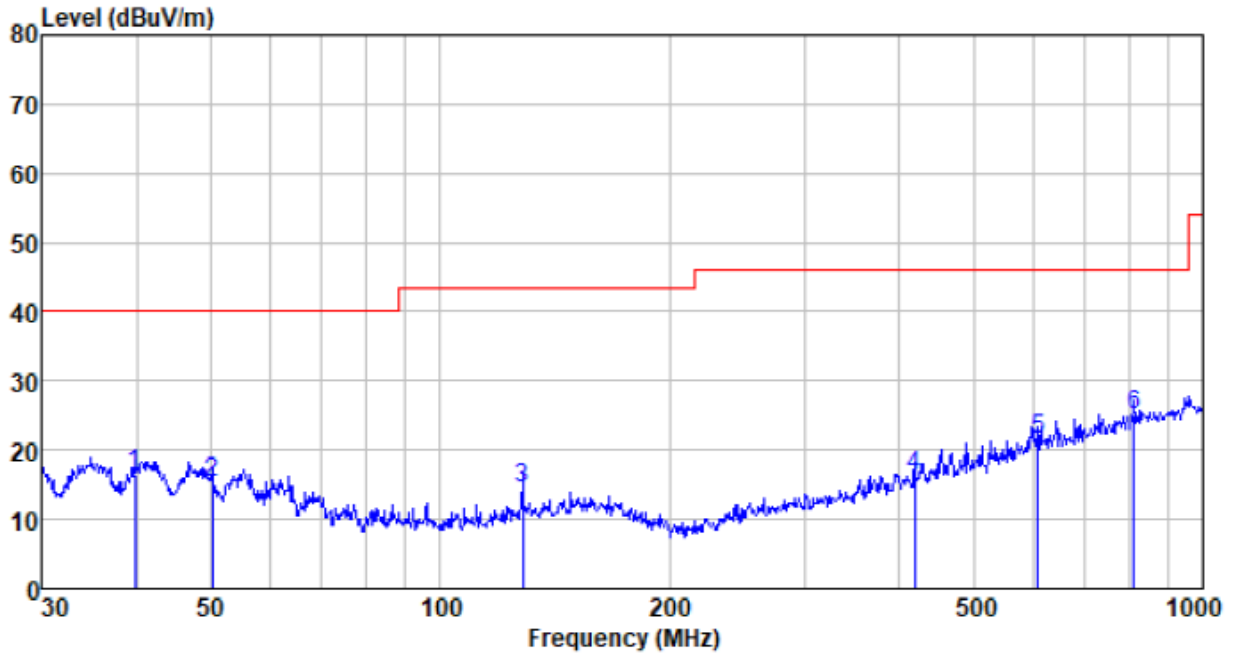

Freq MHz	Reading level dBuV	Antenna factor dB/m	Cable loss dB	Preamp factor dB	level dBuV/m	Limit level dBuV/m	Over limit dB	Remark
39.715	38.35	13.22	0.66	35.65	16.58	40.00	-23.42	QP
50.232	37.67	13.02	0.77	36.18	15.28	40.00	-24.72	QP
128.113	38.57	11.51	1.42	36.94	14.56	43.50	-28.94	QP
419.108	35.74	15.19	2.94	37.52	16.35	46.00	-29.65	QP
607.787	35.89	19.38	3.75	37.55	21.47	46.00	-24.53	QP
813.112	35.89	22.33	4.51	37.62	25.11	46.00	-20.89	QP

Test channel:	Middle	Polarization:	Vertical
---------------	--------	---------------	----------

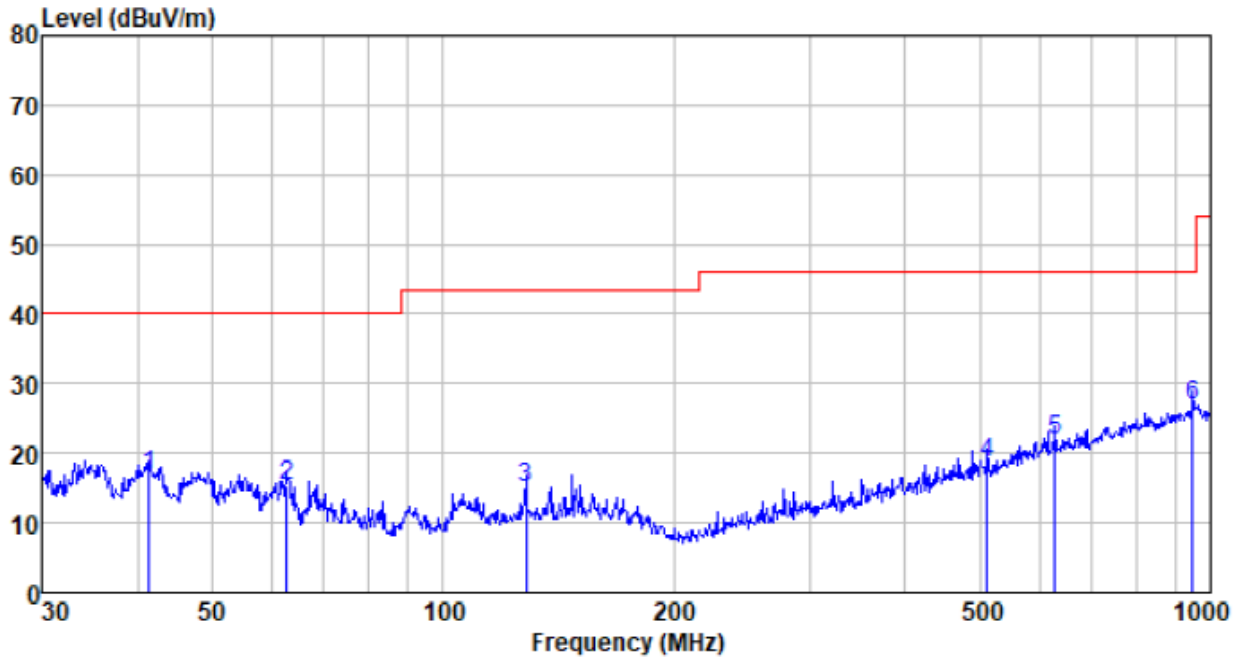

Freq MHz	Reading level dBuV	Antenna factor dB/m	Cable loss dB	Preamp factor dB	level dBuV/m	Limit level dBuV/m	Over limit dB	Remark
41.422	38.82	13.17	0.68	35.75	16.92	40.00	-23.08	QP
62.651	38.85	11.86	0.88	36.36	15.23	40.00	-24.77	QP
128.113	38.96	11.51	1.42	36.94	14.95	43.50	-28.55	QP
511.835	35.95	16.90	3.36	37.51	18.70	46.00	-27.30	QP
627.274	35.81	19.73	3.83	37.57	21.80	46.00	-24.20	QP
948.761	35.42	23.95	5.04	37.55	26.86	46.00	-19.14	QP

Test channel:	Highest	Polarization:	Horizontal
---------------	---------	---------------	------------

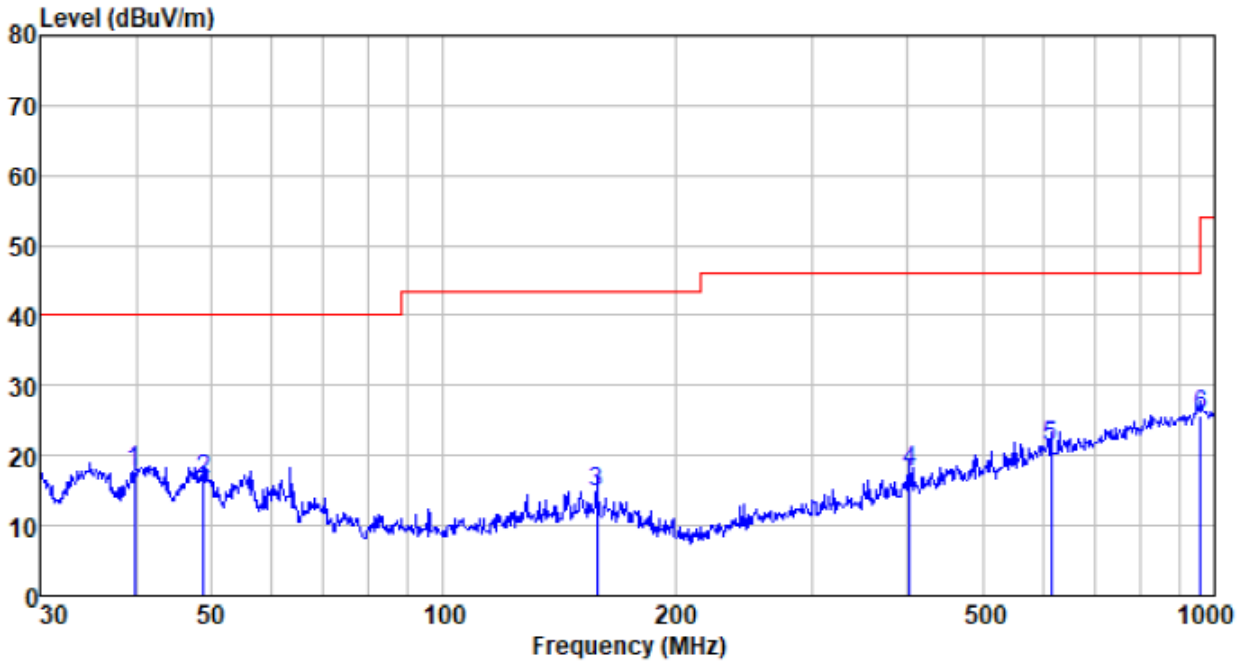

Freq MHz	Reading level dBuV	Antenna factor dB/m	Cable loss dB	Preamp factor dB	level dBuV/m	Limit level dBuV/m	Over limit dB	Remark
39.715	39.35	13.22	0.66	35.65	17.58	40.00	-22.42	QP
48.843	38.90	13.02	0.76	36.13	16.55	40.00	-23.45	QP
158.112	37.55	12.77	1.62	37.12	14.82	43.50	-28.68	QP
401.839	37.51	14.75	2.86	37.52	17.60	46.00	-28.40	QP
614.214	35.67	19.50	3.77	37.55	21.39	46.00	-24.61	QP
958.794	34.13	23.98	5.08	37.55	25.64	46.00	-20.36	QP

Test channel:	Highest	Polarization:	Vertical
---------------	---------	---------------	----------

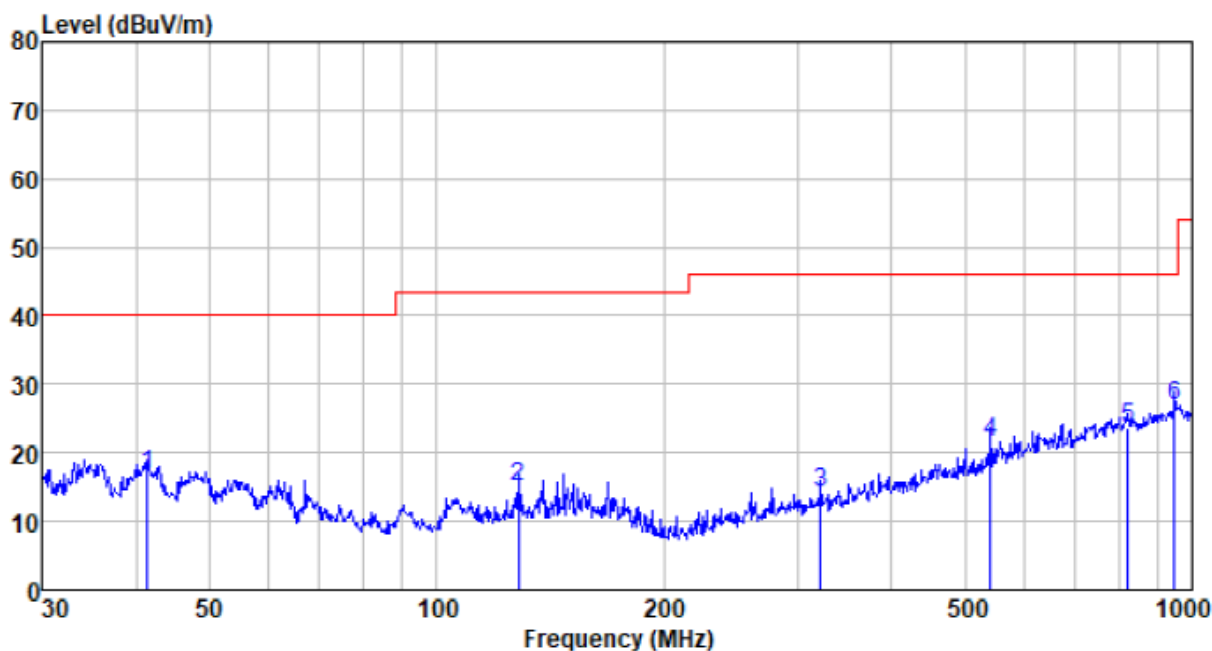

Freq MHz	Reading level dBuV	Antenna factor dB/m	Cable loss dB	Preamp factor dB	level dBuV/m	Limit level dBuV/m	Over limit dB	Remark
41.422	38.82	13.17	0.68	35.75	16.92	40.00	-23.08	QP
128.113	38.96	11.51	1.42	36.94	14.95	43.50	-28.55	QP
322.189	35.97	13.03	2.48	37.44	14.04	46.00	-31.96	QP
541.373	38.02	17.67	3.49	37.52	21.66	46.00	-24.34	QP
821.710	34.31	22.39	4.54	37.62	23.62	46.00	-22.38	QP
948.761	35.42	23.95	5.04	37.55	26.86	46.00	-19.14	QP

- Unwanted Emissions in Restricted Frequency Bands
- Above 1GHz

Test channel:	Lowest	Polarization:	Horizontal
---------------	--------	---------------	------------

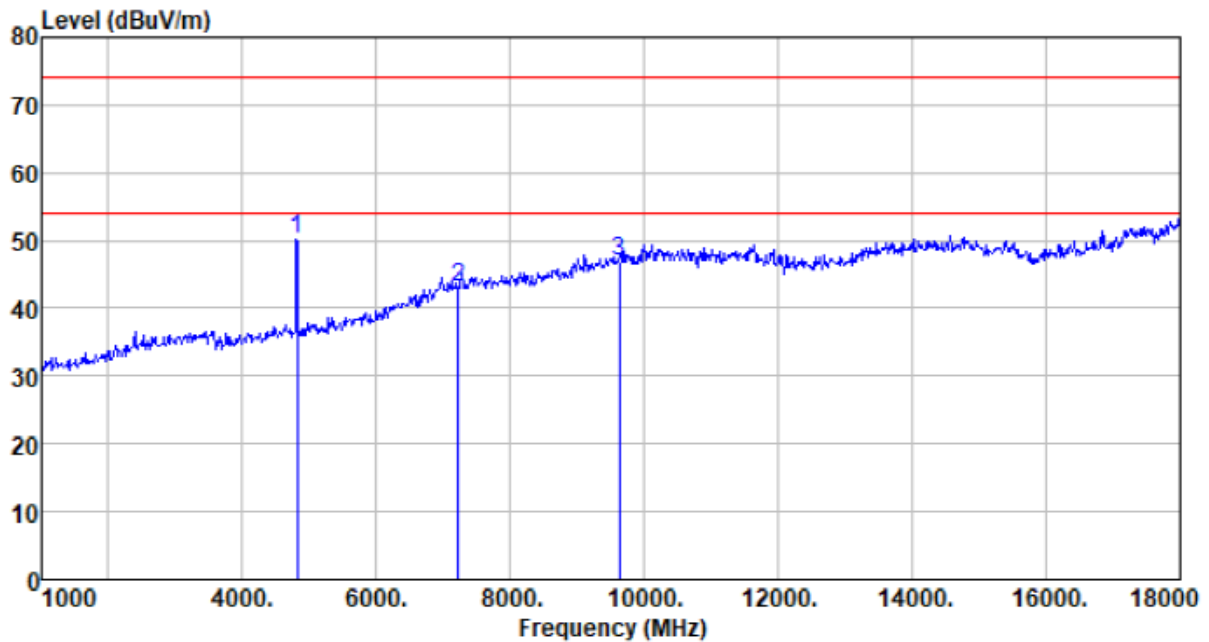

Freq MHz	Reading level dBuV	Antenna factor dB/m	Cable loss dB	Preamp factor dB	level dBuV/m	Limit level dBuV/m	Over limit dB	Remark
4812.000	51.97	31.22	4.61	37.73	50.07	74.00	-23.93	Peak
7218.000	35.90	36.20	6.50	35.63	42.97	74.00	-31.03	Peak
9624.000	36.06	37.93	7.98	34.94	47.03	74.00	-26.97	Peak

Test channel:	Lowest	Polarization:	Vertical
---------------	--------	---------------	----------

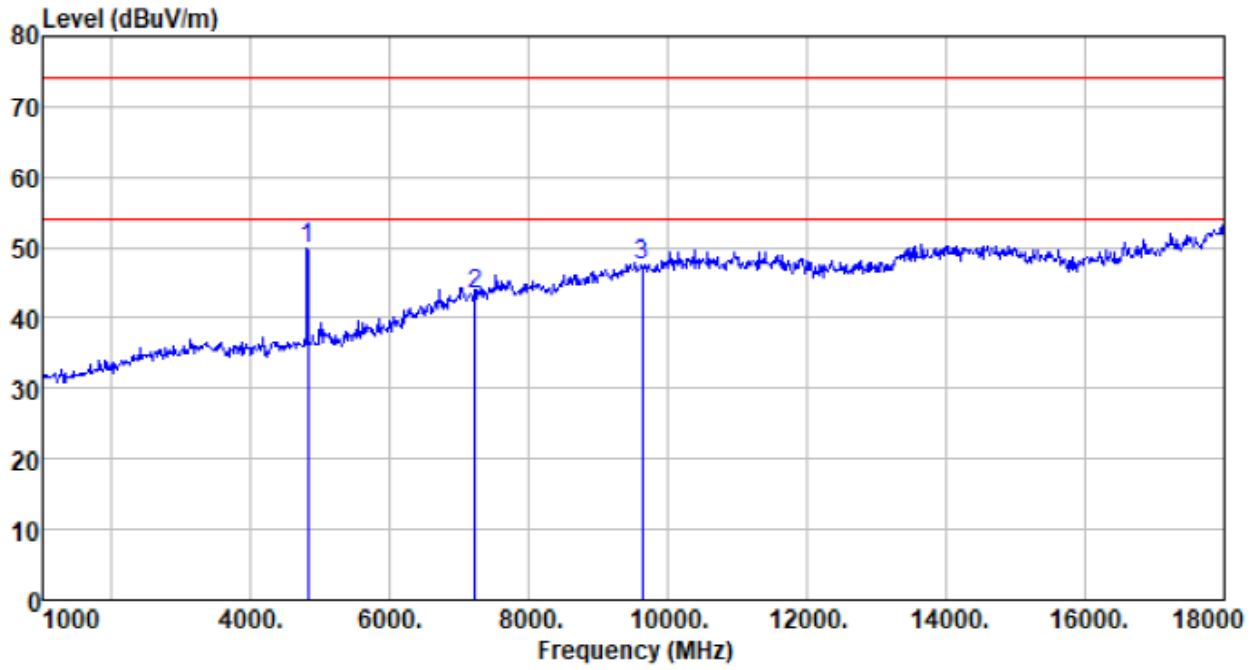

Freq MHz	Reading level dBuV	Antenna factor dB/m	Cable loss dB	Preamp factor dB	level dBuV/m	Limit level dBuV/m	Over limit dB	Remark
4812.000	51.90	31.22	4.61	37.73	50.00	74.00	-24.00	Peak
7218.000	36.29	36.20	6.50	35.63	43.36	74.00	-30.64	Peak
9624.000	36.53	37.93	7.98	34.94	47.50	74.00	-26.50	Peak

Test channel:	Middle	Polarization:	Horizontal
---------------	--------	---------------	------------

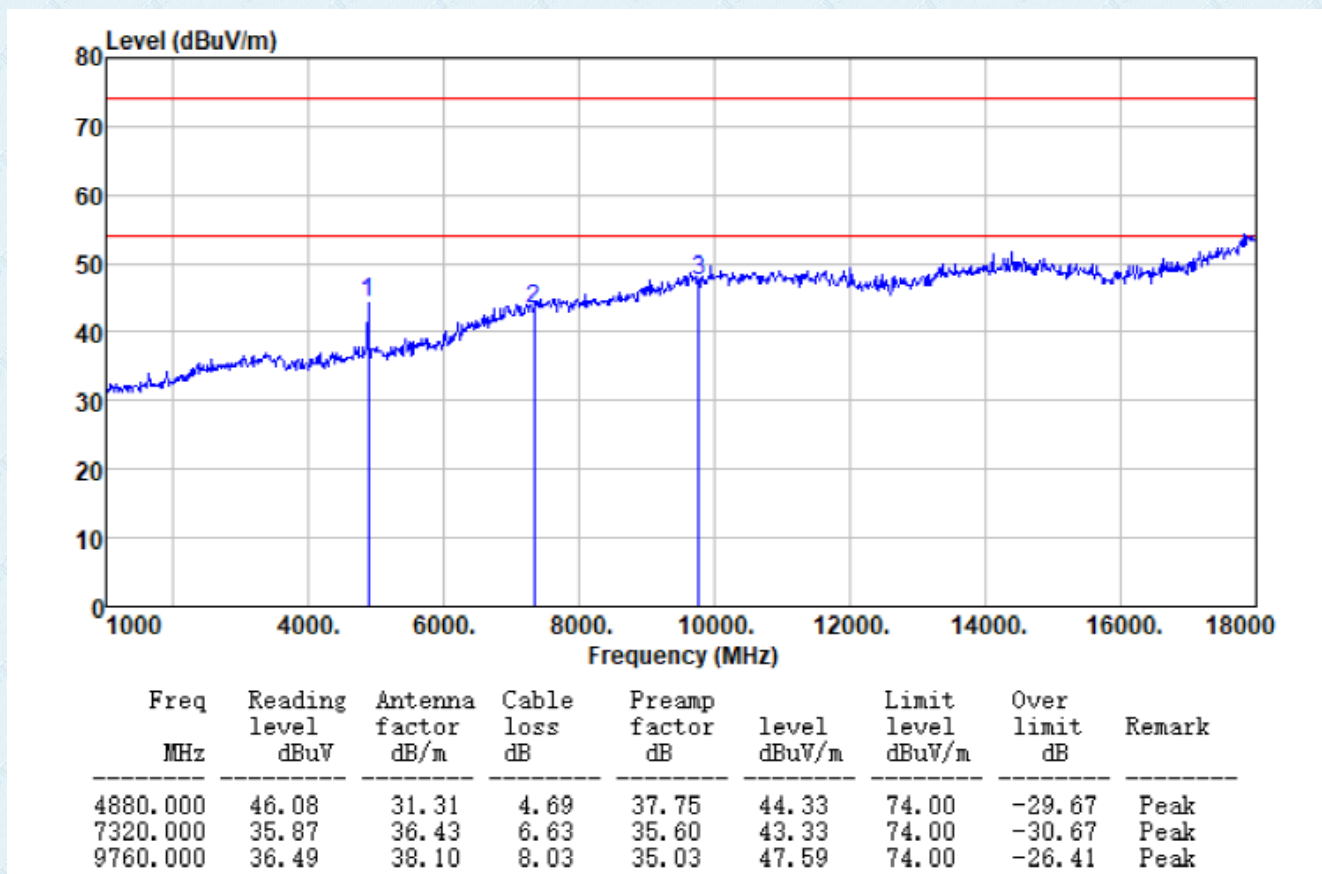

Test channel:	Middle	Polarization:	Vertical
---------------	--------	---------------	----------

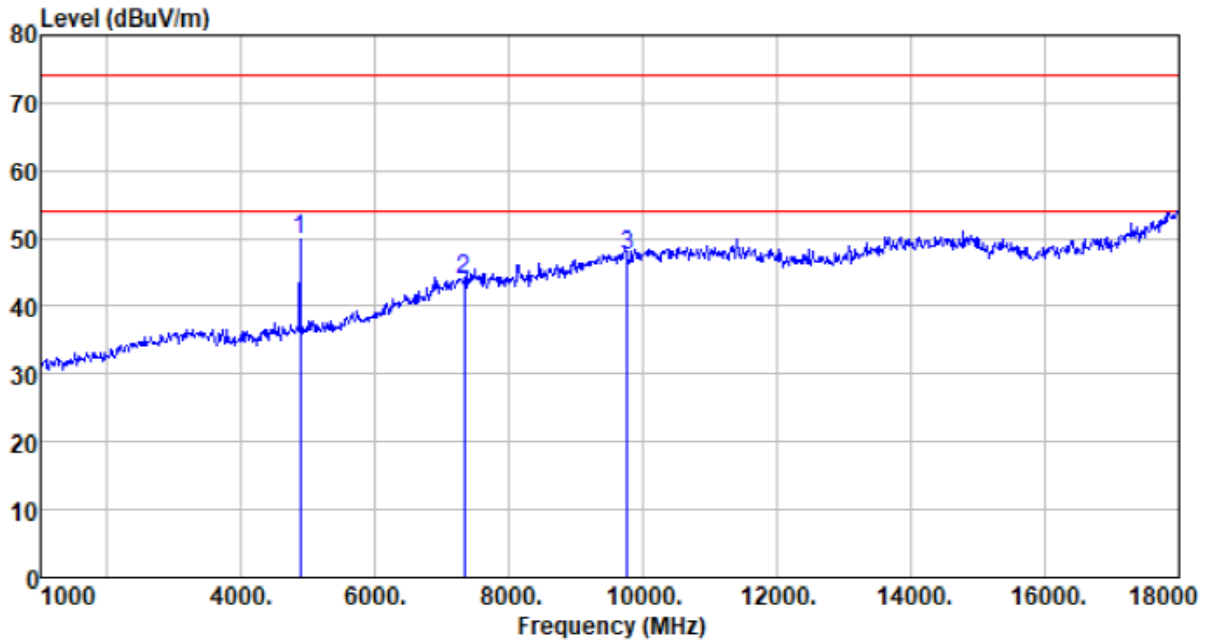

Freq MHz	Reading level dBuV	Antenna factor dB/m	Cable loss dB	Preamp factor dB	level dBuV/m	Limit level dBuV/m	Over limit dB	Remark
4880.000	51.71	31.31	4.69	37.75	49.96	74.00	-24.04	Peak
7320.000	36.59	36.43	6.63	35.60	44.05	74.00	-29.95	Peak
9760.000	36.52	38.10	8.03	35.03	47.62	74.00	-26.38	Peak

Test channel:	Highest	Polarization:	Horizontal
---------------	---------	---------------	------------

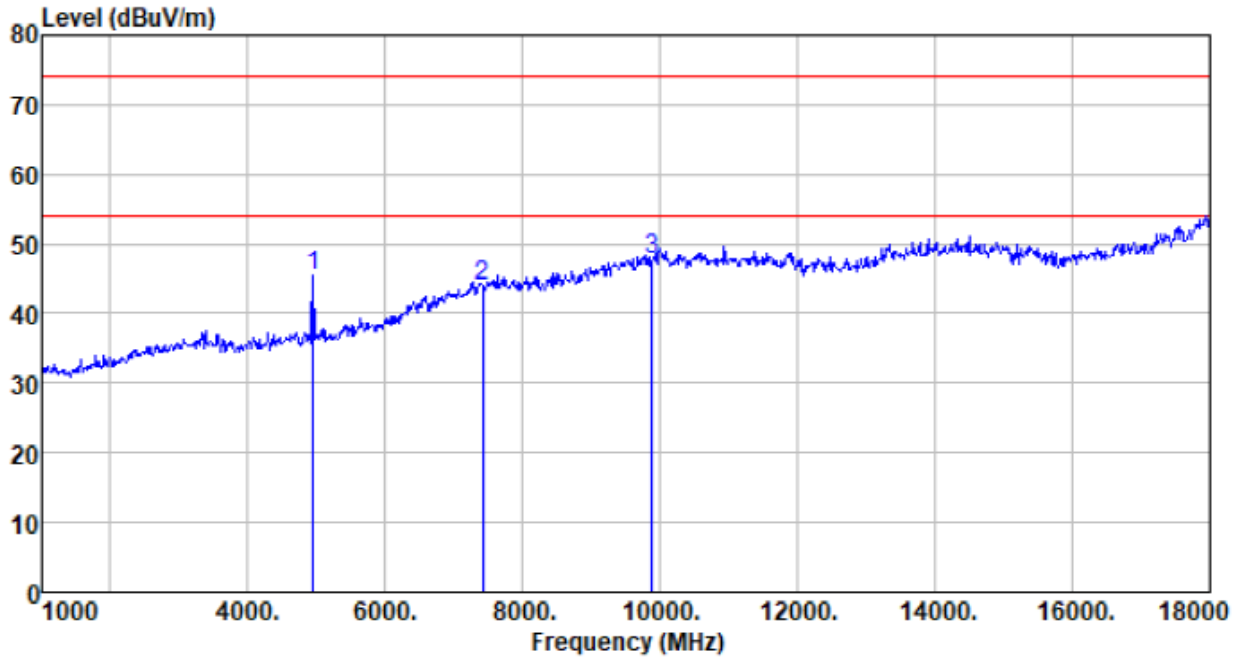

Freq MHz	Reading level dBuV	Antenna factor dB/m	Cable loss dB	Preamp factor dB	level dBuV/m	Limit level dBuV/m	Over limit dB	Remark
4944.000	46.98	31.41	4.77	37.78	45.38	74.00	-28.62	Peak
7416.000	36.31	36.62	6.73	35.57	44.09	74.00	-29.91	Peak
9888.000	36.74	38.27	8.08	35.12	47.97	74.00	-26.03	Peak

Test channel:	Highest	Polarization:	Vertical
---------------	---------	---------------	----------

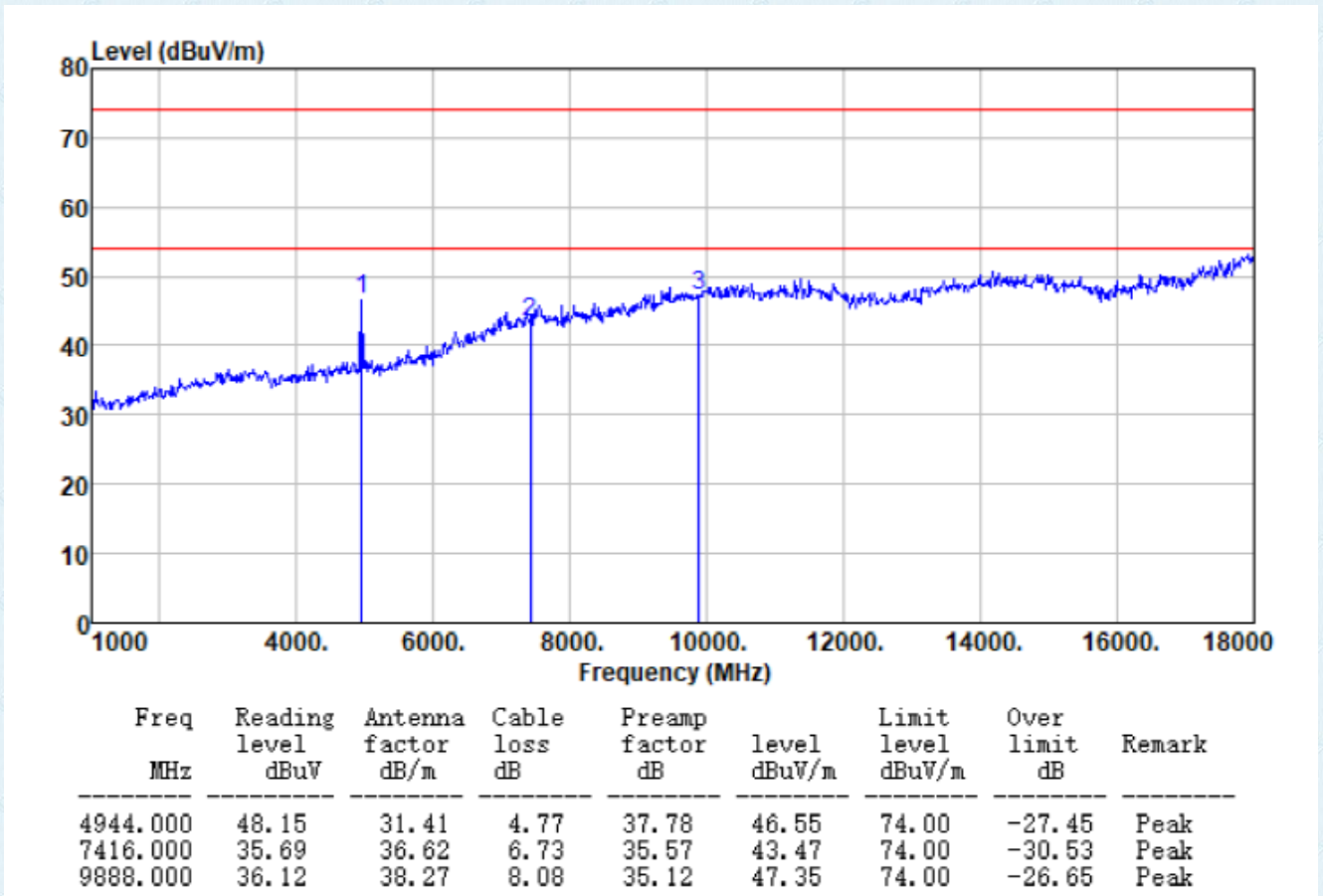

Remark:

1. Final Level = Receiver Read level + Antenna Factor + Cable Loss – Pre-amplifier Factor
2. “*”, means this data is too weak instrument of signal is unable to test.
3. The emission levels of other frequencies are very lower than the limit and not show in test report.

Unwanted Emissions in Non-restricted Frequency Bands

Test channel:	Lowest	Polarization:	Horizontal
---------------	--------	---------------	------------

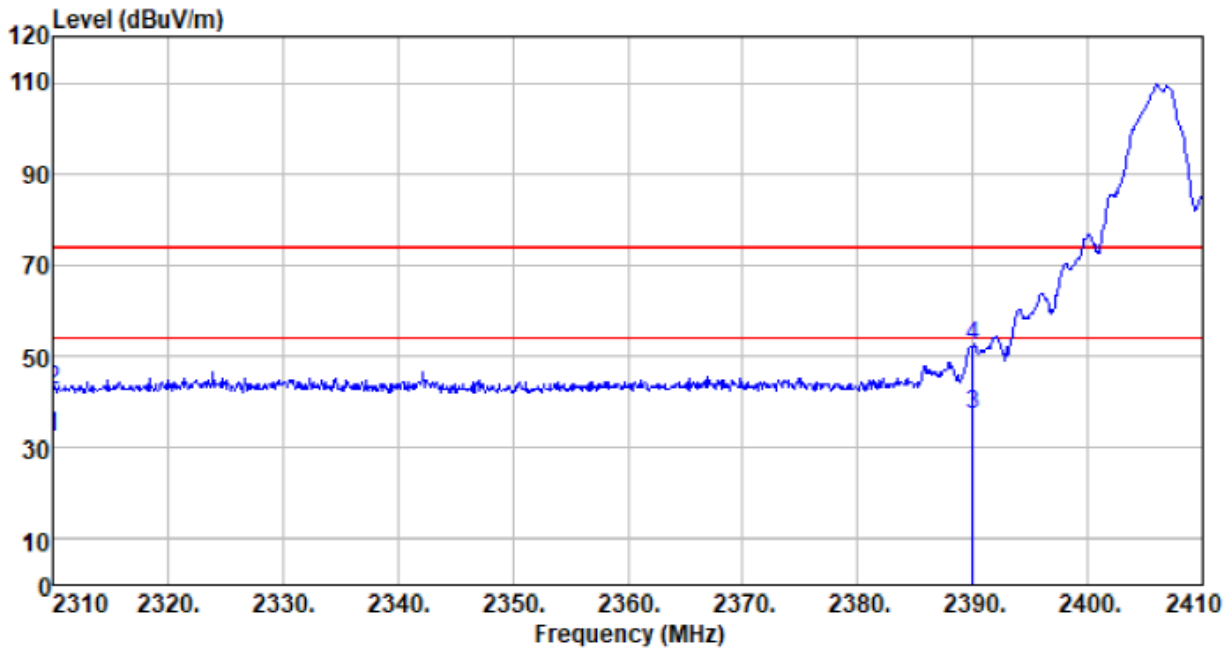

Freq MHz	Reading level dBuV	Antenna factor dB/m	Cable loss dB	Preamp factor dB	level dBuV/m	Limit level dBuV/m	Over limit dB	Remark
2310.000	32.68	27.14	2.81	30.43	32.20	54.00	-21.80	Average
2310.000	43.17	27.14	2.81	30.43	42.69	74.00	-31.31	Peak
2390.000	37.33	27.37	2.91	30.24	37.37	54.00	-16.63	Average
2390.000	52.21	27.37	2.91	30.24	52.25	74.00	-21.75	Peak

Test channel:	Lowest	Polarization:	Vertical
---------------	--------	---------------	----------

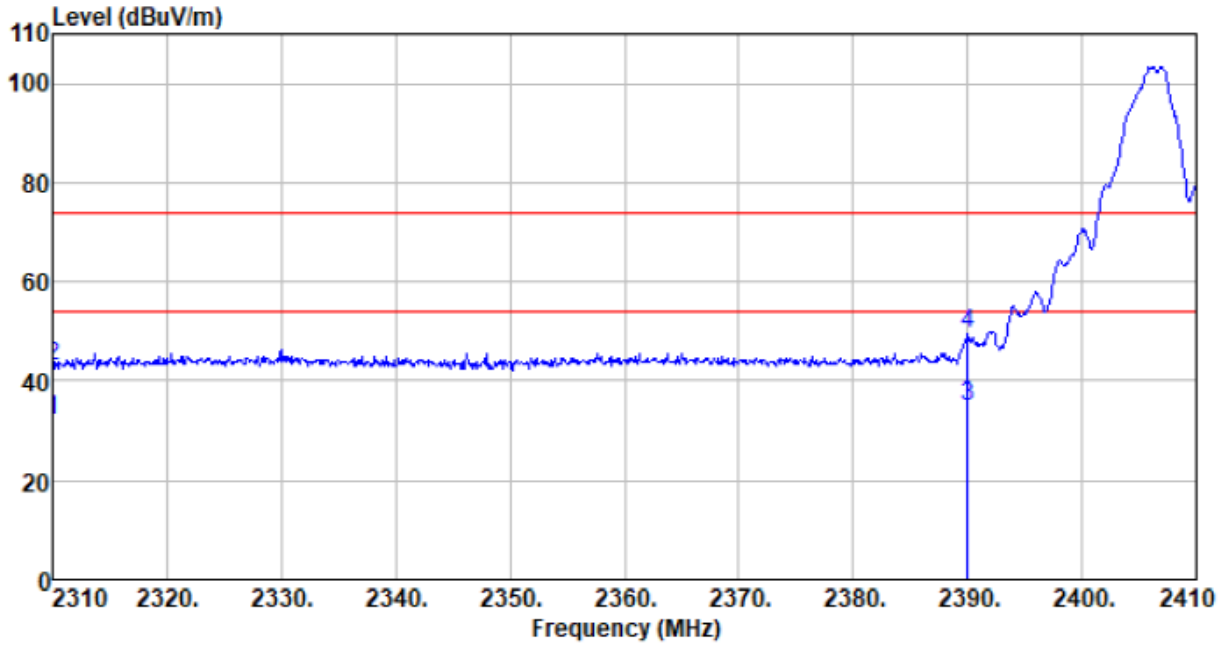

Freq MHz	Reading level dBUV	Antenna factor dB/m	Cable loss dB	Preamp factor dB	level dBUV/m	Limit level dBUV/m	Over limit dB	Remark
2310.000	32.68	27.14	2.81	30.43	32.20	54.00	-21.80	Average
2310.000	43.32	27.14	2.81	30.43	42.84	74.00	-31.16	Peak
2390.000	34.90	27.37	2.91	30.24	34.94	54.00	-19.06	Average
2390.000	49.63	27.37	2.91	30.24	49.67	74.00	-24.33	Peak

Test channel:	Highest	Polarization:	Horizontal
---------------	---------	---------------	------------

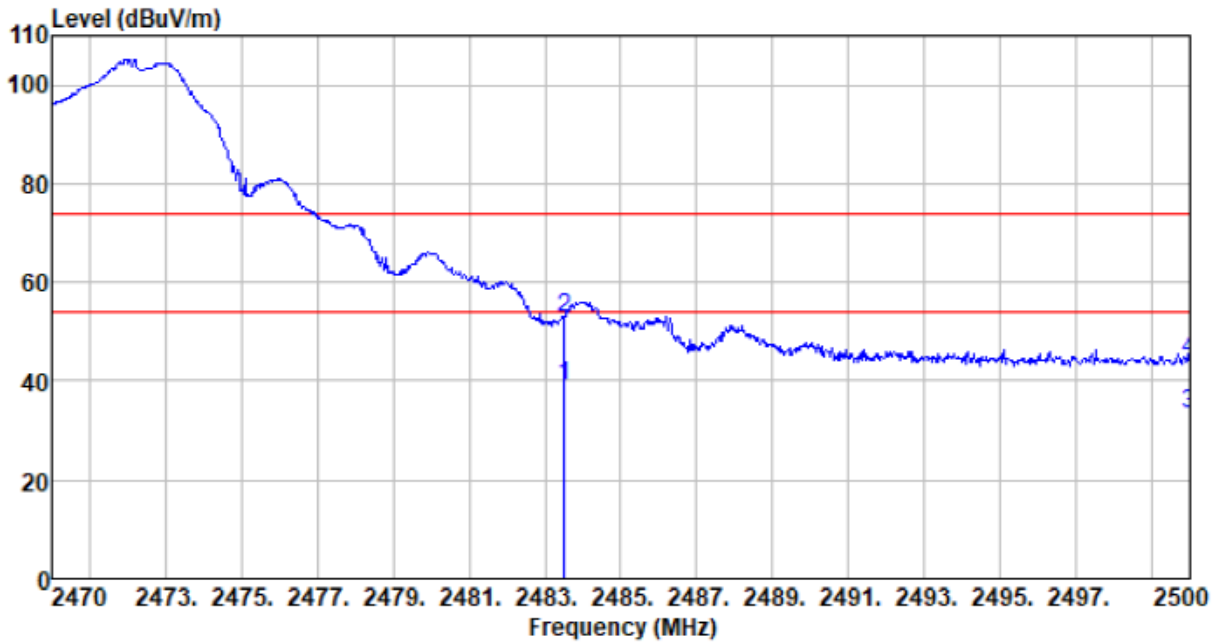

Freq MHz	Reading level dBuV	Antenna factor dB/m	Cable loss dB	Preamp factor dB	level dBuV/m	Limit level dBuV/m	Over limit dB	Remark
2483.500	38.56	27.66	2.99	30.12	39.09	54.00	-14.91	Average
2483.500	52.17	27.66	2.99	30.12	52.70	74.00	-21.30	Peak
2500.000	32.77	27.70	3.01	30.13	33.35	54.00	-20.65	Average
2500.000	43.83	27.70	3.01	30.13	44.41	74.00	-29.59	Peak

Test channel:	Highest	Polarization:	Vertical
---------------	---------	---------------	----------

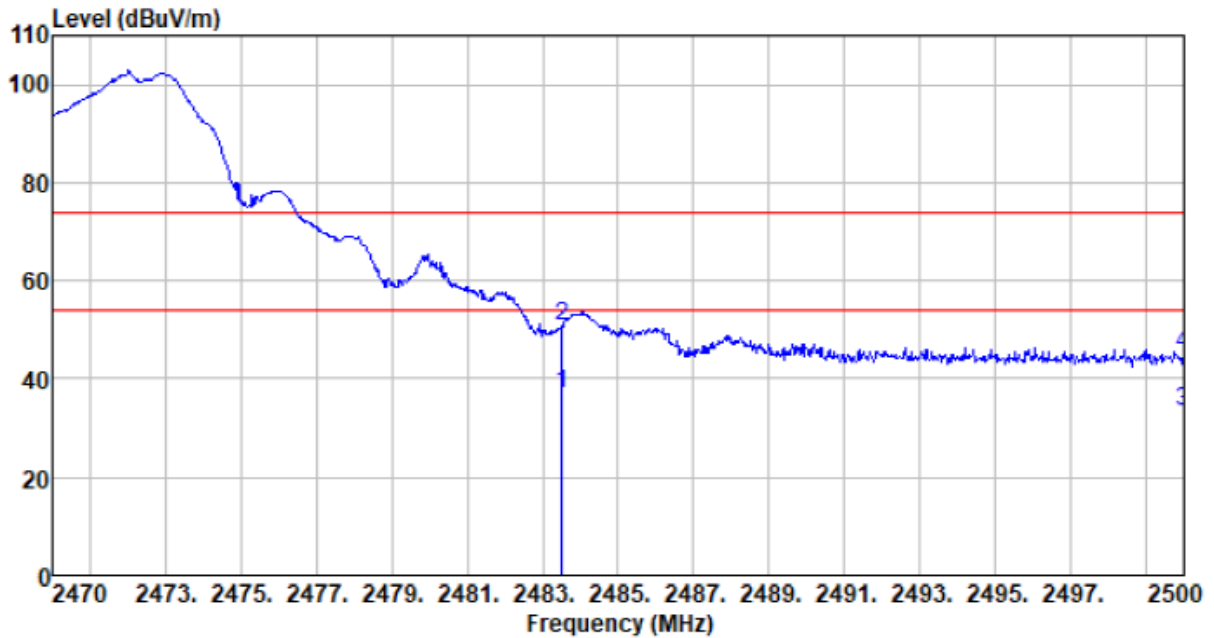

Freq MHz	Reading level dBuV	Antenna factor dB/m	Cable loss dB	Preamp factor dB	level dBuV/m	Limit level dBuV/m	Over limit dB	Remark
2483.500	36.48	27.66	2.99	30.12	37.01	54.00	-16.99	Average
2483.500	50.11	27.66	2.99	30.12	50.64	74.00	-23.36	Peak
2500.000	32.82	27.70	3.01	30.13	33.40	54.00	-20.60	Average
2500.000	44.34	27.70	3.01	30.13	44.92	74.00	-29.08	Peak

Remarks:

1. Final Level = Receiver Read level + Antenna Factor + Cable Loss – Preamplifier Factor
2. The emission levels of other frequencies are very lower than the limit and not show in test report.
3. “*”, means this data is the too weak instrument of signal is unable to test.

8 Test Setup Photo

Reference to the **appendix I** for details.

9 EUT Constructional Details

Reference to the **appendix II** for details.

---End---