

# TEST REPORT

**Applicant:** FLYSKY RC MODEL TECHNOLOGY CO., LTD

**Address of Applicant:** West building3, Huangjianyuan Ind, Park QIAOLI North Gate  
Changping Town, Dongguan, China

**Manufacturer:** ShenZhen FLYSKY Technology Co.,Ltd

**Address of Manufacturer:** ADD 16F, Huafeng Building, No. 6006 Shennan Road, Futian  
District, Shenzhen, Guangdong, China

**Factory:** Dongguan Flysky RC Model technology Co.,Ltd

**Address of Factory:** West building 3, HuangjinyuanInd Park, QIAOLI North Gate,  
Changping Town, Dongguan, China

**Equipment Under Test (EUT)**

Product Name: Digital propotional radio control system

Model No.: FS-MG41, FS-MG4

Trade Mark: FLYSKY

**FCC ID:** N4ZMG400

**Applicable standards:** FCC CFR Title 47 Part 15 Subpart C Section 15.247

**Date of sample receipt:** April 23, 2021

**Date of Test:** April 23, 2021-June 04, 2021

**Date of report issued:** June 04, 2021

**Test Result :** PASS \*

\* In the configuration tested, the EUT complied with the standards specified above.

Authorized Signature:

Robinson Luo  
Laboratory Manager

This results shown in this test report refer only to the sample(s) tested, this test report cannot be reproduced, except in full, without prior written permission of the company. The report would be invalid without specific stamp of test institute and the signatures of compiler and approver.

## 2 Version

Version No.	Date	Description
00	June 04, 2021	Original

Prepared By:

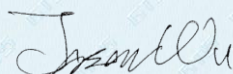

Date:

June 04, 2021

Project Engineer

Check By:

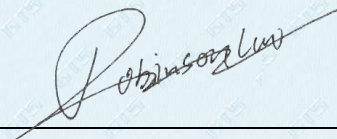

Date:

June 04, 2021

Reviewer

## 3 Contents

Page

1	COVER PAGE .....	1
2	VERSION .....	2
3	CONTENTS .....	3
4	TEST SUMMARY .....	4
4.1	MEASUREMENT UNCERTAINTY .....	4
5	GENERAL INFORMATION .....	5
5.1	GENERAL DESCRIPTION OF EUT .....	5
5.2	TEST MODE .....	7
5.3	TEST FACILITY .....	7
5.4	TEST LOCATION .....	7
5.5	DESCRIPTION OF SUPPORT UNITS .....	7
5.6	DEVIATION FROM STANDARDS.....	7
5.7	ABNORMALITIES FROM STANDARD CONDITIONS.....	7
5.8	ADDITIONAL INSTRUCTIONS.....	7
6	TEST INSTRUMENTS LIST .....	8
7	TEST RESULTS AND MEASUREMENT DATA .....	10
7.1	ANTENNA REQUIREMENT.....	10
7.2	CONDUCTED PEAK OUTPUT POWER.....	11
7.3	20dB EMISSION BANDWIDTH .....	13
7.4	CARRIER FREQUENCIES SEPARATION.....	15
7.5	HOPPING CHANNEL NUMBER .....	17
7.6	DWELL TIME .....	18
7.7	BAND EDGE .....	22
7.7.1	Conducted Emission Method .....	22
7.7.2	Radiated Emission Method .....	24
7.8	SPURIOUS EMISSION .....	29
7.8.1	Conducted Emission Method .....	29
7.8.2	Radiated Emission Method .....	31
8	TEST SETUP PHOTO .....	46
9	EUT CONSTRUCTIONAL DETAILS.....	46

## 4 Test Summary

Test Item	Section	Result
Antenna Requirement	15.203/15.247 (c)	Pass
AC Power Line Conducted Emission	15.207	N/A
Conducted Peak Output Power	15.247 (b)(1)	Pass
20dB Occupied Bandwidth	15.247 (a)(1)	Pass
Carrier Frequencies Separation	15.247 (a)(1)	Pass
Hopping Channel Number	15.247 (a)(1)	Pass
Dwell Time	15.247 (a)(1)	Pass
Pseudorandom Frequency Hopping Sequence	15.247(b)(4)	Pass
Radiated Emission	15.205/15.209	Pass
Band Edge	15.247(d)	Pass

*Pass: The EUT complies with the essential requirements in the standard.*

*Remark : Test according to ANSI C63.10:2013.*

### 4.1 Measurement Uncertainty

Test Item	Frequency Range	Measurement Uncertainty	Notes
Radiated Emission	30MHz-200MHz	3.8039dB	(1)
Radiated Emission	200MHz-1GHz	3.9679dB	(1)
Radiated Emission	1GHz-18GHz	4.29dB	(1)
Radiated Emission	18GHz-40GHz	3.30dB	(1)
AC Power Line Conducted Emission	0.15MHz ~ 30MHz	3.44dB	(1)

Note (1): The measurement uncertainty is for coverage factor of k=2 and a level of confidence of 95%.

## 5 General Information

### 5.1 General Description of EUT

Product Name:	Digital proportional radio control system
Model No.:	FS-MG41, FS-MG4
Test Model No:	FS-MG41
Remark: The difference between the two models appears in the red dial switch and dual color light, the main function of the red dial switch is the conversion between the modes. Double - color light is a return indication.	
Serial No.:	N/A
Hardware version:	FS-MG4 -V1.2
Software version:	FS-MG41 1.0.6
Test sample(s) ID:	GTS202104000240-1
Sample(s) Status	Engineer sample
Operation Frequency:	2406MHz~2472MHz
Channel numbers:	133
Modulation technology:	DSSS
Antenna Type:	PCB Antenna
Antenna gain:	1dBi
Power supply:	DC 6V(4*1.5V Size"AA" Battery)

Remark: The system works in the frequency range of 2406MHz to 2472MHz. This band has been divided to 133 independent channels. Each radio system uses 20 different channels; the minimum channel separation is  $\geq 3$  MHz. By using various switch-on times, hopping scheme and channel frequencies, the system can guarantee a jamming free radio transmission. The channel list is below.

The test frequencies are below:

Channel	Frequency
The lowest channel	2406MHz
The middle channel	2440MHz
The Highest channel	2472MHz

Operation Frequency each of channel							
Channel	Frequency (MHz)	Channel	Frequency (MHz)	Channel	Frequency (MHz)	Channel	Frequency (MHz)
1	2406.0	39	2425.0	77	2444.0	120	2465.5
2	2406.5	40	2425.5	78	2444.5	121	2466.0
3	2407.0	41	2426.0	79	2445.0	122	2466.5
4	2407.5	42	2426.5	80	2445.5	123	2467.0
5	2408.0	43	2427.0	81	2446.0	124	2467.5
6	2408.5	44	2427.5	82	2446.5	125	2468.0
7	2409.0	45	2428.0	83	2447.0	126	2468.5
8	2409.5	46	2428.5	84	2447.5	127	2469.0
9	2410.0	47	2429.0	85	2448.0	128	2469.5
10	2410.5	48	2429.5	86	2448.5	129	2470.0
11	2411.0	49	2430.0	87	2449.0	130	2470.5
12	2411.5	50	2430.5	88	2449.5	131	2471.0
13	2412.0	51	2431.0	89	2450.0	132	2471.5
14	2412.5	52	2431.5	90	2450.5	133	2472.0
15	2413.0	53	2432.0	91	2451.0		
16	2413.5	54	2432.5	92	2451.5		
17	2414.0	55	2433.0	93	2452.0		
18	2414.5	56	2433.5	94	2452.5		
19	2415.0	57	2434.0	95	2453.0		
20	2415.5	58	2434.5	96	2453.5		
21	2416.0	59	2435.0	97	2454.0		
22	2416.5	60	2435.5	98	2454.5		
23	2417.0	61	2436.0	99	2455.0		
24	2417.5	62	2436.5	100	2455.5		
25	2418.0	63	2437.0	101	2456.0		
26	2418.5	64	2437.5	102	2456.5		
27	2419.0	65	2438.0	103	2457.0		
28	2419.5	66	2438.5	104	2457.5		
29	2420.0	67	2439.0	105	2458.0		
30	2420.5	68	2439.5	106	2458.5		
31	2421.0	69	2440.0	107	2459.0		
32	2421.5	70	2440.5	108	2459.5		
33	2422.0	71	2441.0	109	2460.0		
34	2422.5	72	2441.5	110	2460.5		
35	2423.0	73	2442.0	111	2461.0		
36	2423.5	74	2442.5	112	2461.5		
37	2424.0	75	2443.0	113	2462.0		
38	2424.5	76	2443.5	114	2462.5		

## 5.2 Test mode

Transmitting mode	Keep the EUT in transmitting mode.
Remark: New battery is used during all test.	

## 5.3 Test Facility

<p>The test facility is recognized, certified, or accredited by the following organizations:</p> <ul style="list-style-type: none"> <li>● <b>FCC —Registration No.: 381383</b> Global United Technology Services Co., Ltd., Shenzhen EMC Laboratory has been registered and fully described in a report filed with the (FCC) Federal Communications Commission. The acceptance letter from the FCC is maintained in files. Registration 381383.</li> <li>● <b>IC —Registration No.: 9079A</b> The 3m Semi-anechoic chamber of Global United Technology Services Co., Ltd. has been registered by Certification and Engineering Bureau of Industry Canada for radio equipment testing with Registration No.: 9079A</li> <li>● <b>NVLAP (LAB CODE:600179-0)</b> Global United Technology Services Co., Ltd., is accredited by the National Voluntary Laboratory Accreditation Program (NVLAP). LAB CODE:600179-0</li> </ul>
---

## 5.4 Test Location

All other tests were performed at:
<p>Global United Technology Services Co., Ltd. Address: No. 123-128, Tower A, Jinyuan Business Building, No.2, Laodong Industrial Zone, Xixiang Road, Baoan District, Shenzhen, Guangdong, China 518102 Tel: 0755-27798480 Fax: 0755-27798960</p>

## 5.5 Description of Support Units

Manufacturer	Description	Model	Serial Number
None.			

## 5.6 Deviation from Standards

None.
-------

## 5.7 Abnormalities from Standard Conditions

None.
-------

## 5.8 Additional Instructions

Software (Used for test) from client
Built-in by manufacturer, power set default.

## 6 Test Instruments list

Radiated Emission:						
Item	Test Equipment	Manufacturer	Model No.	Inventory No.	Cal.Date (mm-dd-yy)	Cal.Due date (mm-dd-yy)
1	3m Semi- Anechoic Chamber	ZhongYu Electron	9.2(L)*6.2(W)* 6.4(H)	GTS250	July. 02 2020	July. 01 2025
2	Control Room	ZhongYu Electron	6.2(L)*2.5(W)* 2.4(H)	GTS251	N/A	N/A
3	EMI Test Receiver	Rohde & Schwarz	ESU26	GTS203	June. 25 2020	June. 24 2021
4	BiConiLog Antenna	SCHWARZBECK MESS-ELEKTRONIK	VULB9163	GTS214	June. 25 2020	June. 24 2021
5	Double -ridged waveguide horn	SCHWARZBECK MESS-ELEKTRONIK	BBHA 9120 D	GTS208	June. 25 2020	June. 24 2021
6	Horn Antenna	ETS-LINDGREN	3160	GTS217	June. 25 2020	June. 24 2021
7	EMI Test Software	AUDIX	E3	N/A	N/A	N/A
8	Coaxial Cable	GTS	N/A	GTS213	June. 25 2020	June. 24 2021
9	Coaxial Cable	GTS	N/A	GTS211	June. 25 2020	June. 24 2021
10	Coaxial cable	GTS	N/A	GTS210	June. 25 2020	June. 24 2021
11	Coaxial Cable	GTS	N/A	GTS212	June. 25 2020	June. 24 2021
12	Amplifier(100kHz-3GHz)	HP	8347A	GTS204	June. 25 2020	June. 24 2021
13	Amplifier(2GHz-20GHz)	HP	84722A	GTS206	June. 25 2020	June. 24 2021
14	Amplifier (18-26GHz)	Rohde & Schwarz	AFS33-18002 650-30-8P-44	GTS218	June. 25 2020	June. 24 2021
15	Band filter	Amindeon	82346	GTS219	June. 25 2020	June. 24 2021
16	Power Meter	Anritsu	ML2495A	GTS540	June. 25 2020	June. 24 2021
17	Power Sensor	Anritsu	MA2411B	GTS541	June. 25 2020	June. 24 2021
18	Wideband Radio Communication Tester	Rohde & Schwarz	CMW500	GTS575	June. 25 2020	June. 24 2021
19	Splitter	Agilent	11636B	GTS237	June. 25 2020	June. 24 2021
20	Loop Antenna	ZHINAN	ZN30900A	GTS534	June. 25 2020	June. 24 2021
21	Breitband hornantenne	SCHWARZBECK	BBHA 9170	GTS579	Oct. 18 2020	Oct. 17 2021
22	Amplifier	TDK	PA-02-02	GTS574	Oct. 18 2020	Oct. 17 2021
23	Amplifier	TDK	PA-02-03	GTS576	Oct. 18 2020	Oct. 17 2021
24	PSA Series Spectrum Analyzer	Rohde & Schwarz	FSP	GTS578	June. 25 2020	June. 24 2021



RF Conducted Test:						
Item	Test Equipment	Manufacturer	Model No.	Serial No.	Cal.Date (mm-dd-yy)	Cal.Due date (mm-dd-yy)
1	MXA Signal Analyzer	Agilent	N9020A	GTS566	June. 25 2020	June. 24 2021
2	EMI Test Receiver	R&S	ESCI 7	GTS552	June. 25 2020	June. 24 2021
3	Spectrum Analyzer	Agilent	E4440A	GTS533	June. 25 2020	June. 24 2021
4	MXG vector Signal Generator	Agilent	N5182A	GTS567	June. 25 2020	June. 24 2021
5	ESG Analog Signal Generator	Agilent	E4428C	GTS568	June. 25 2020	June. 24 2021
6	USB RF Power Sensor	DARE	RPR3006W	GTS569	June. 25 2020	June. 24 2021
7	RF Switch Box	Shongyi	RFSW3003328	GTS571	June. 25 2020	June. 24 2021
8	Programmable Constant Temp & Humi Test Chamber	WEWON	WHTH-150L-40-880	GTS572	June. 25 2020	June. 24 2021

General used equipment:						
Item	Test Equipment	Manufacturer	Model No.	Inventory No.	Cal.Date (mm-dd-yy)	Cal.Due date (mm-dd-yy)
1	Humidity/ Temperature Indicator	KTJ	TA328	GTS243	June. 25 2020	June. 24 2021
2	Barometer	ChangChun	DYM3	GTS255	June. 25 2020	June. 24 2021

## 7 Test results and Measurement Data

### 7.1 Antenna requirement

<b>Standard requirement:</b>	FCC Part15 C Section 15.203 /247(c)
<p><b>15.203 requirement:</b></p> <p>An intentional radiator shall be designed to ensure that no antenna other than that furnished by the responsible party shall be used with the device. The use of a permanently attached antenna or of an antenna that uses a unique coupling to the intentional radiator, the manufacturer may design the unit so that a broken antenna can be replaced by the user, but the use of a standard antenna jack or electrical connector is prohibited.</p> <p><b>15.247(c) (1)(i) requirement:</b></p> <p>(i) Systems operating in the 2400-2483.5 MHz band that is used exclusively for fixed. Point-to-point operations may employ transmitting antennas with directional gain greater than 6dBi provided the maximum conducted output power of the intentional radiator is reduced by 1 dB for every 3 dB that the directional gain of the antenna exceeds 6dBi.</p>	
<b>EUT Antenna:</b>	
<p><i>The antenna is PCB antenna, the best case gain of the antenna is 1dBi, reference to the appendix II for details.</i></p>	

## 7.2 Conducted Peak Output Power

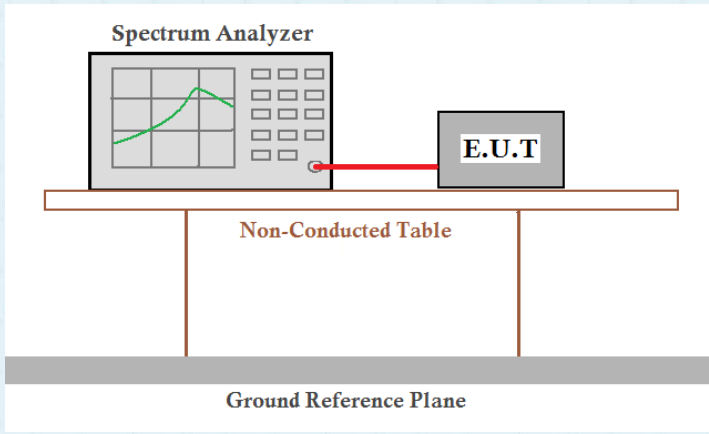
Test Requirement:	FCC Part15 C Section 15.247 (b)(1)
Test Method:	ANSI C63.10:2013
Limit:	20.97dBm
Test setup:	
Test Instruments:	Refer to section 6.0 for details
Test mode:	Refer to section 5.2 for details
Test results:	Pass

### Measurement Data

Test channel	Peak Output Power (dBm)	Limit (dBm)	Result
Lowest	16.49	20.97	Pass
Middle	15.78		Pass
Highest	14.78		Pass

Test plot as follows:

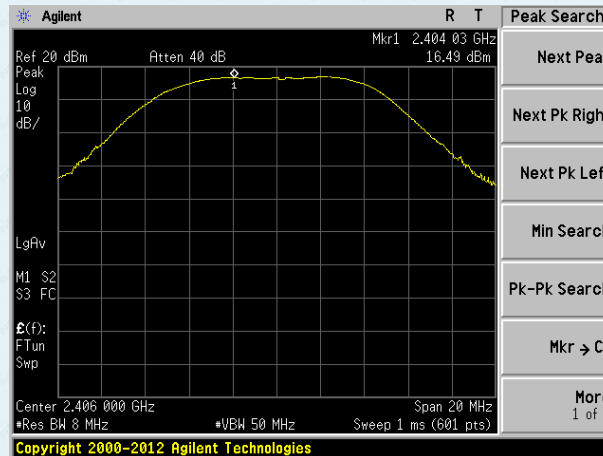

Lowest channel

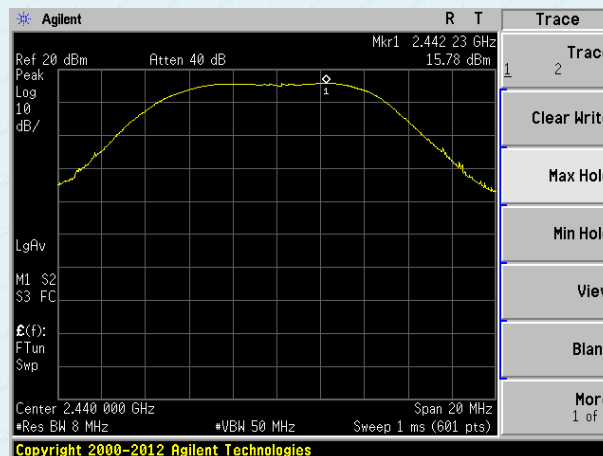

Middle channel

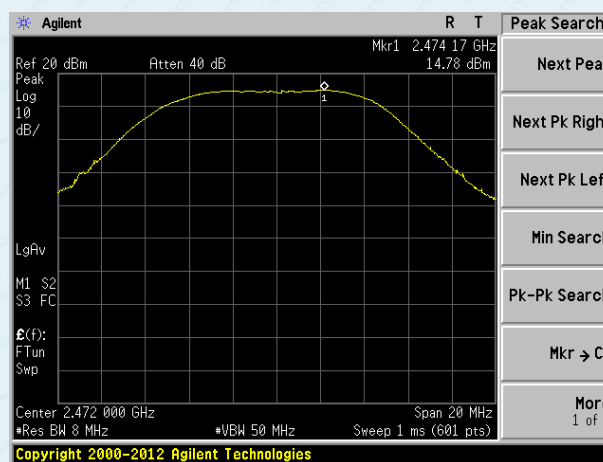

Highest channel

### 7.3 20dB Emission Bandwidth

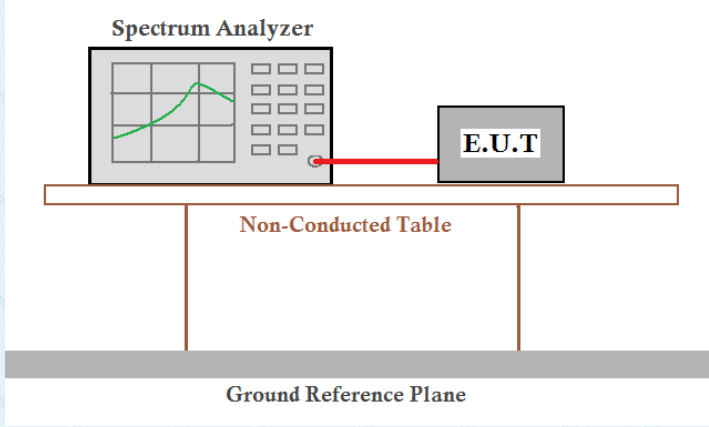
Test Requirement:	FCC Part15 C Section 15.247 (a)(1)
Test Method:	ANSI C63.10:2013
Limit:	N/A
Test setup:	 <p>The diagram illustrates the test setup. A Spectrum Analyzer is connected to an E.U.T. (Equipment Under Test) via a red cable. Both are placed on a Non-Conducted Table, which sits on a Ground Reference Plane.</p>
Test Instruments:	Refer to section 6.0 for details
Test mode:	Refer to section 5.2 for details
Test results:	Pass

#### Measurement Data

Test channel	20dB Emission Bandwidth (MHz)	Result
Lowest	4.409	Pass
Middle	4.402	
Highest	4.397	

Test plot as follows:

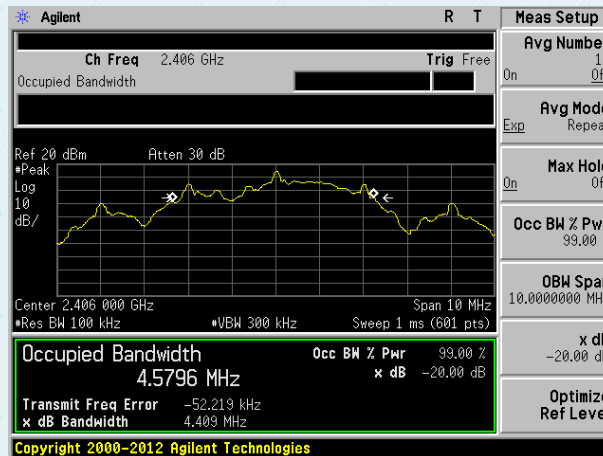

Lowest channel

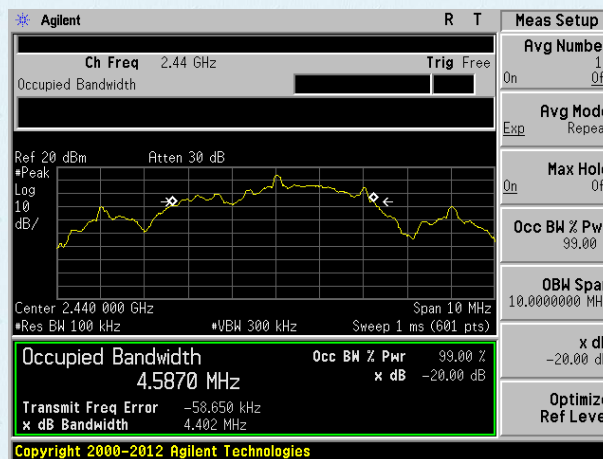

Middle channel

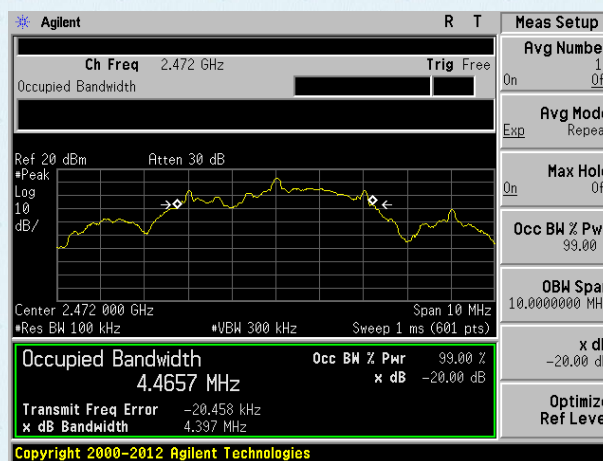

Highest channel

## 7.4 Carrier Frequencies Separation

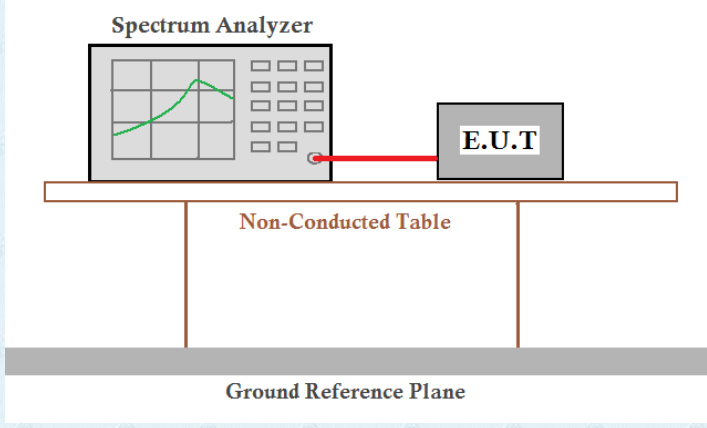
Test Requirement:	FCC Part15 C Section 15.247 (a)(1)
Test Method:	ANSI C63.10:2013
Receiver setup:	RBW=100KHz, VBW=300KHz, detector=Peak
Limit:	0.025MHz or 2/3 of the 20dB bandwidth (whichever is greater)
Test setup:	 <p>The diagram illustrates the test setup. A Spectrum Analyzer is connected to an E.U.T. (Equipment Under Test) via a red cable. Both are placed on a Non-Conducted Table, which is supported by a Ground Reference Plane.</p>
Test Instruments:	Refer to section 6.0 for details
Test mode:	Refer to section 5.2 for details
Test results:	Pass

### Measurement Data

Test channel	Carrier Frequencies Separation (kHz)	Limit (kHz)	Result
Lowest	3017	2939	Pass
Middle	3008	2935	Pass
Highest	3008	2931	Pass

Test plot as follows:

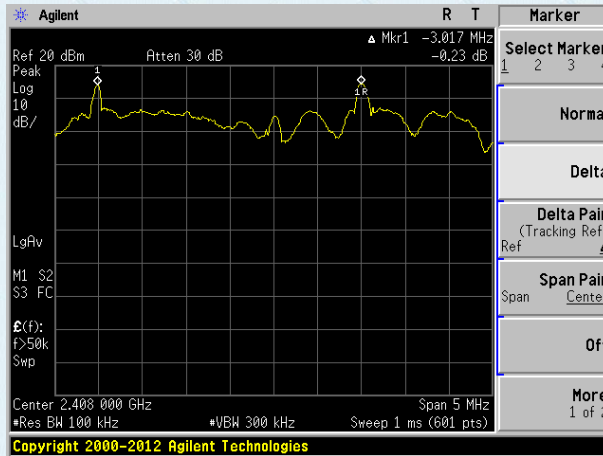

Lowest channel

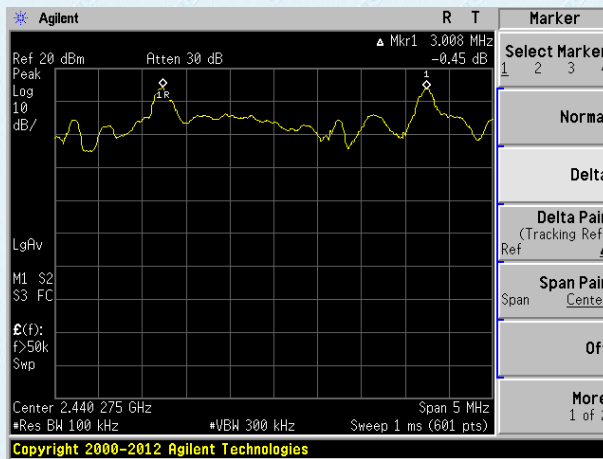

Middle channel

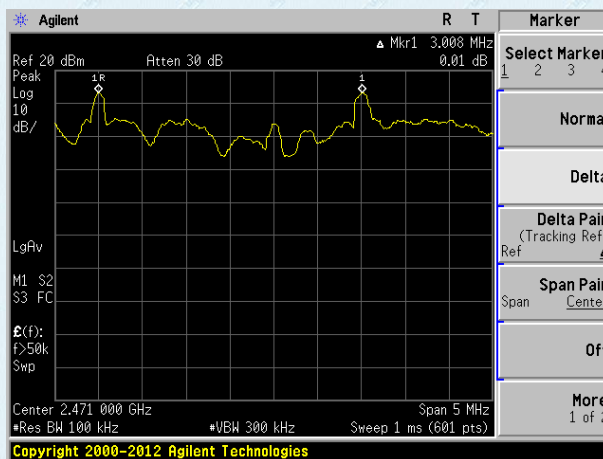

Highest channel

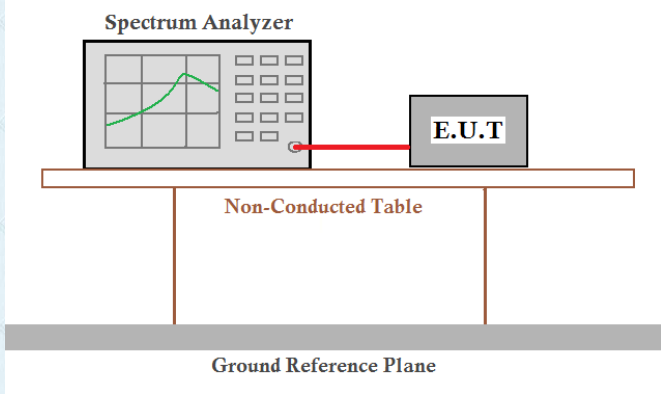

## 7.5 Hopping Channel Number

Test Requirement:	FCC Part15 C Section 15.247 (a)(1)
Test Method:	ANSI C63.10:2013
Receiver setup:	RBW=100kHz, VBW=300kHz, Frequency range=2400MHz-2483.5MHz, Detector=Peak
Limit:	15 channels
Test setup:	
Test Instruments:	Refer to section 6.0 for details
Test mode:	Refer to section 5.2 for details
Test results:	Pass

### Measurement Data:

Hopping channel numbers	Limit	Result
20	15	Pass

### Test plot as follows:

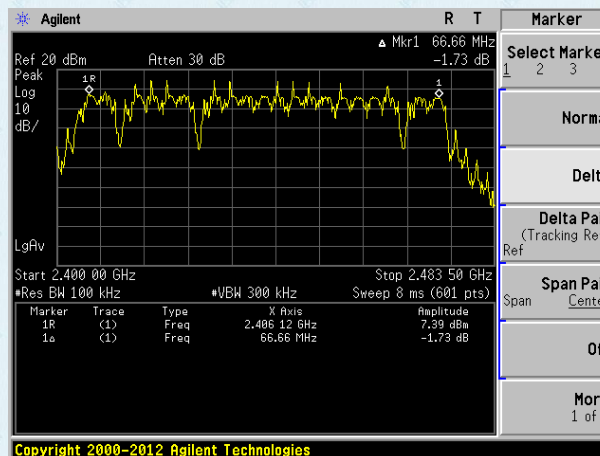

## 7.6 Dwell Time

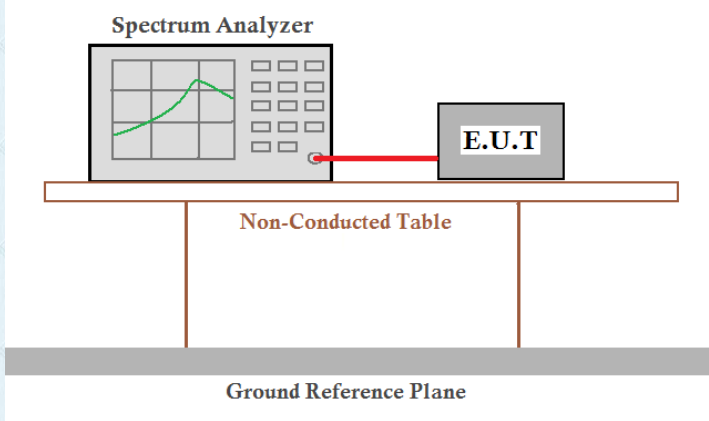
Test Requirement:	FCC Part15 C Section 15.247 (a)(1)
Test Method:	ANSI C63.10:2013
Receiver setup:	RBW=1MHz, VBW=1MHz, Span=0Hz, Detector=Peak
Limit:	0.4 Second
Test setup:	
Test Instruments:	Refer to section 6.0 for details
Test mode:	Refer to section 5.2 for details
Test results:	Pass

### Measurement Data

Frequency(MHz)	Ton (ms)	Dwell time(ms)	Limit(ms)	Result
2406	3.3	237.6	400	Pass
2440	3.217	231.62	400	Pass
2472	3.283	236.376	400	Pass

The formula as below:

2406MHz: Dwell time = Ton \* Ton times in 1s \* 0.4s \* channel numbers=3.3ms\*9\*0.4\*20=237.6ms

2440MHz: Dwell time = Ton \* Ton times in 1s \* 0.4s \* channel numbers=3.217ms\*9\*0.4\*20=231.624ms

2472MHz: Dwell time = Ton \* Ton times in 1s \* 0.4s \* channel numbers=3.283ms\*9\*0.4\*20=236.376ms

Test plot as follows:

Frequency:	2406MHz
------------	---------

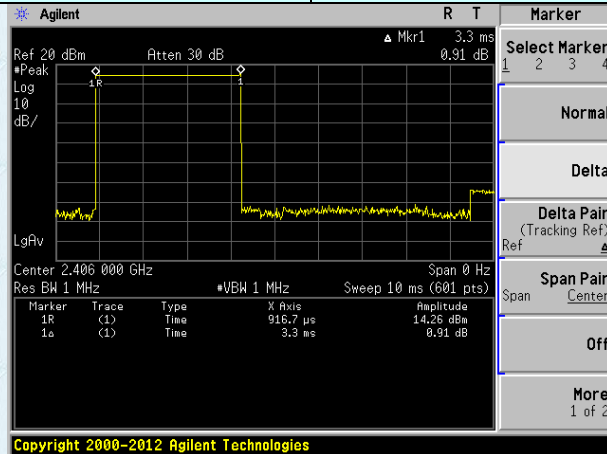

Ton

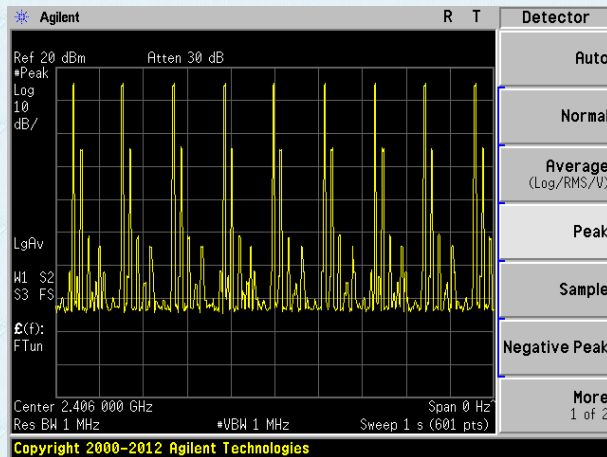

Ton times in 1s

Frequency: 2440MHz

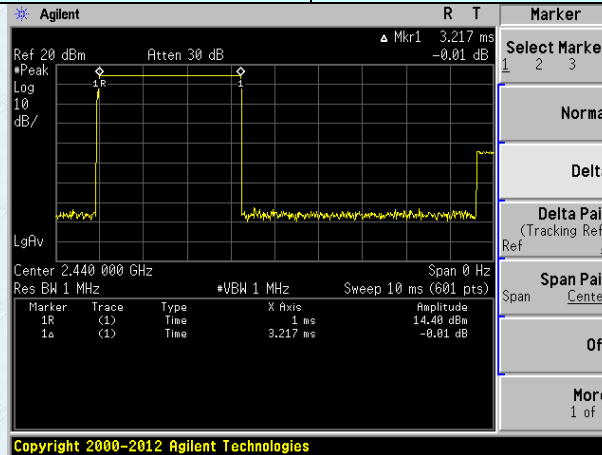

Ton

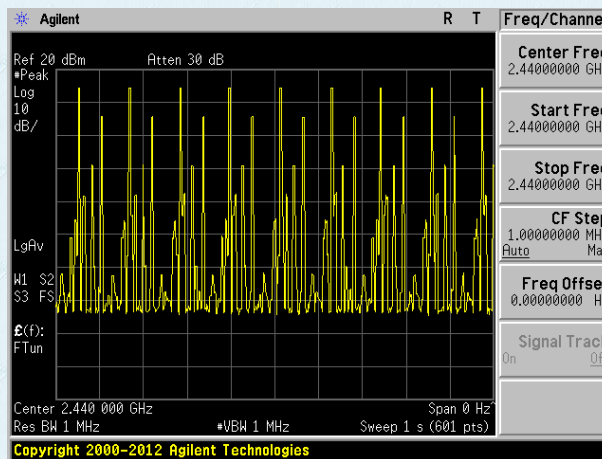

Ton times in 1s

Frequency: 2472MHz

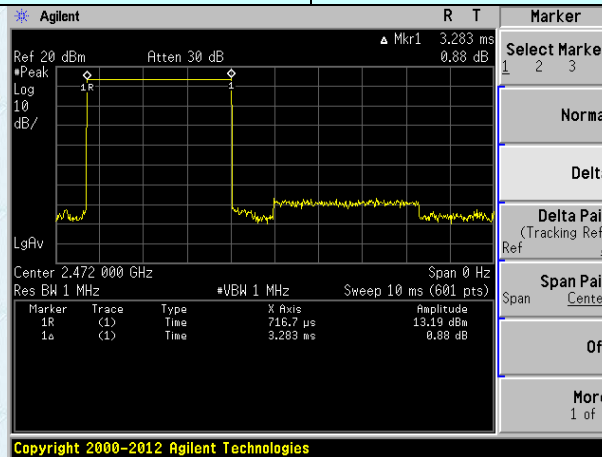

Ton

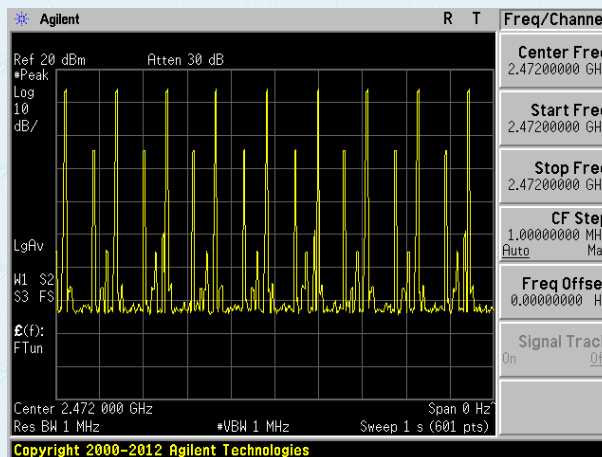

Ton times in 1s

## 7.7 Band Edge

### 7.7.1 Conducted Emission Method

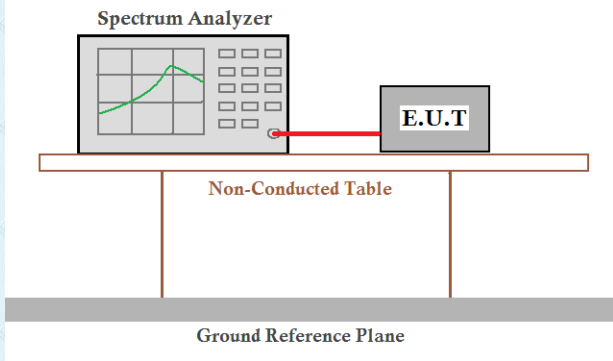
Test Requirement:	FCC Part15 C Section 15.247 (d)
Test Method:	ANSI C63.10:2013
Receiver setup:	RBW=100kHz, VBW=300kHz, Detector=Peak
Limit:	In any 100 kHz bandwidth outside the frequency band in which the spread spectrum intentional radiator is operating, the radio frequency power that is produced by the intentional radiator shall be at least 20 dB below that in the 100 kHz bandwidth within the band that contains the highest level of the desired power, based on either an RF conducted or a radiated measurement.
Test setup:	 <p>The diagram illustrates the test setup. A Spectrum Analyzer is connected to an E.U.T. (Equipment Under Test) via a red cable. Both are placed on a Non-Conducted Table, which sits on a Ground Reference Plane.</p>
Test Instruments:	Refer to section6.0 for details
Test mode:	Refer to section 5.2 for details
Test results:	Pass

Test plot as follows:

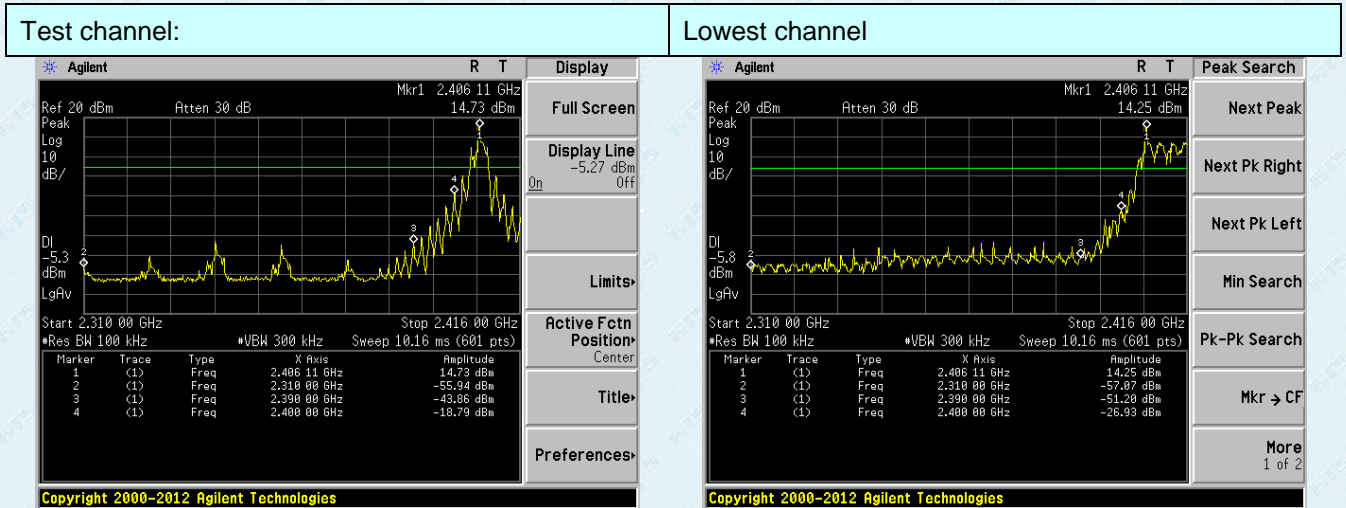

No-hopping mode

Hopping mode

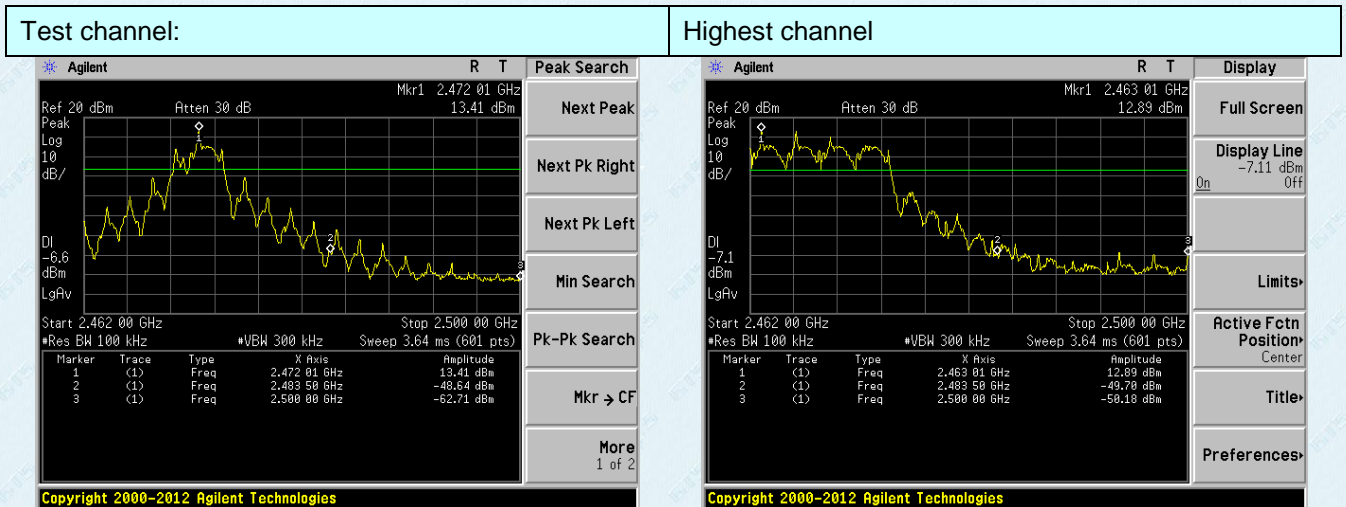

No-hopping mode

Hopping mode

## 7.7.2 Radiated Emission Method

Test Requirement:	FCC Part15 C Section 15.209 and 15.205					
Test Method:	ANSI C63.10:2013					
Test Frequency Range:	All of the restrict bands were tested, only the worst band's (2310MHz to 2500MHz) data was showed.					
Test site:	Measurement Distance: 3m					
Receiver setup:	Frequency	Detector	RBW	VBW	Remark	
	Above 1GHz	Peak	1MHz	3MHz	Peak Value	
		Peak	1MHz	10Hz	Average Value	
Limit:	Frequency		Limit (dBuV/m @3m)		Remark	
	Above 1GHz		54.00		Average Value	
			74.00		Peak Value	
Test setup:						
Test Procedure:	<ol style="list-style-type: none"> <li>1. The EUT was placed on the top of a rotating table 1.5 meters above the ground at a 3 meter camber. The table was rotated 360 degrees to determine the position of the highest radiation.</li> <li>2. The EUT was set 3 meters away from the interference-receiving antenna, which was mounted on the top of a variable-height antenna tower.</li> <li>3. The antenna height is varied from one meter to four meters above the ground to determine the maximum value of the field strength. Both horizontal and vertical polarizations of the antenna are set to make the measurement.</li> <li>4. For each suspected emission, the EUT was arranged to its worst case and then the antenna was tuned to heights from 1 meter to 4 meters and the rota table was turned from 0 degrees to 360 degrees to find the maximum reading.</li> <li>5. The test-receiver system was set to Peak Detect Function and Specified Bandwidth with Maximum Hold Mode.</li> <li>6. If the emission level of the EUT in peak mode was 10dB lower than the limit specified, then testing could be stopped and the peak values of the EUT would be reported. Otherwise the emissions that did not have 10dB margin would be re-tested one by one using peak, quasi-peak or average method as specified and then reported in a data sheet.</li> </ol>					
Test Instruments:	Refer to section 6.0 for details					
Test mode:	Refer to section 5.2 for details					
Temp. / Hum.	Temp.:	25 °C	Humid.:	52%	Press.:	1 012mbar
Test results:	Pass					



**Measurement Data**

Remark:

1. Pre-scan all kind of the place mode (X-axis, Y-axis, Z-axis), and found the Y-axis which it is worse case.

Test channel:	Lowest	Polarization:	Horizontal
---------------	--------	---------------	------------

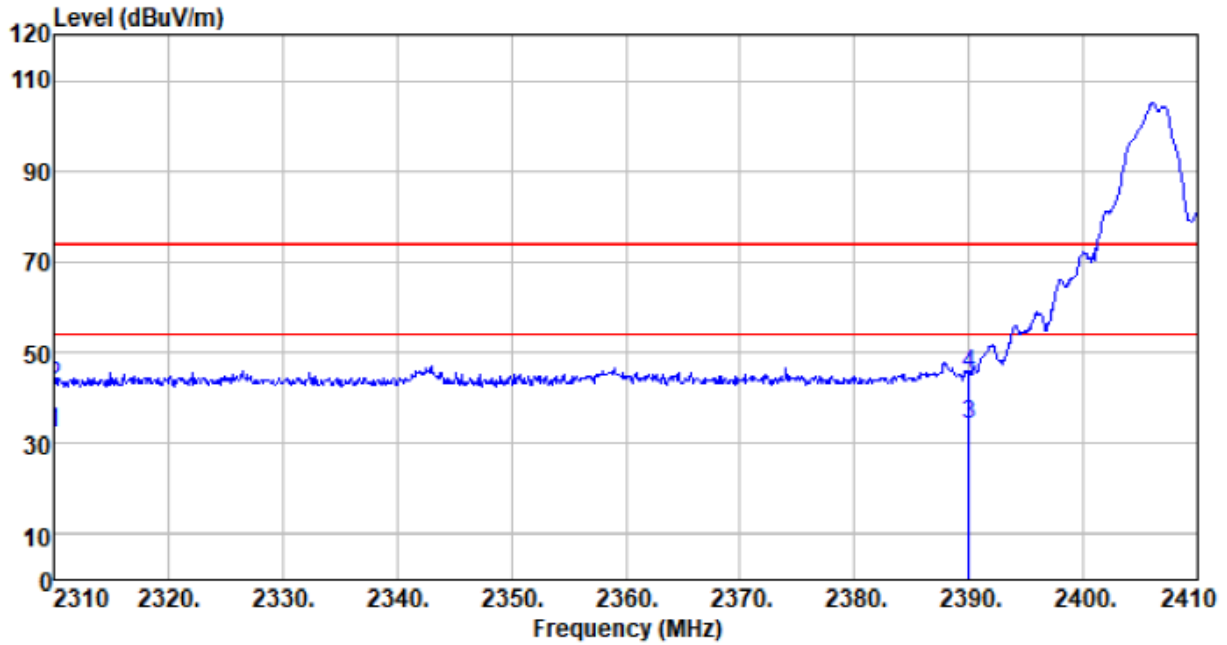

Freq MHz	Reading level dBuV	Antenna factor dB/m	Cable loss dB	Preamp factor dB	level dBuV/m	Limit level dBuV/m	Over limit dB	Remark
2310.000	32.73	27.14	2.81	30.43	32.25	54.00	-21.75	Average
2310.000	43.10	27.14	2.81	30.43	42.62	74.00	-31.38	Peak
2390.000	34.01	27.37	2.91	30.24	34.05	54.00	-19.95	Average
2390.000	45.02	27.37	2.91	30.24	45.06	74.00	-28.94	Peak

Test channel:	Lowest	Polarization:	Vertical
---------------	--------	---------------	----------

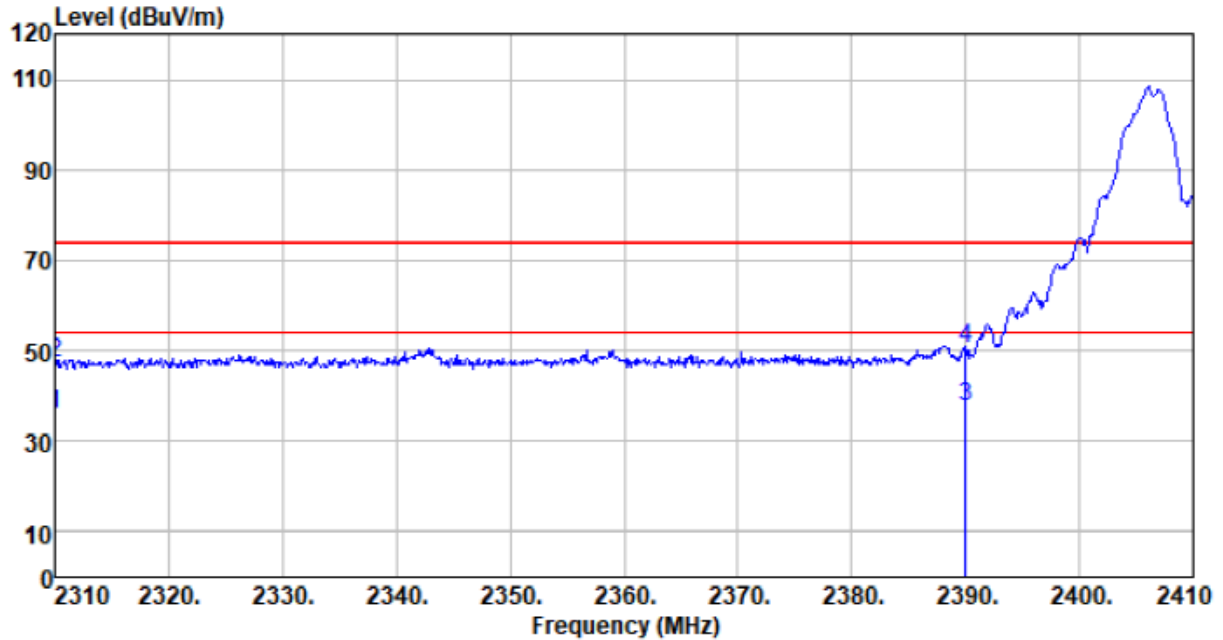

Freq MHz	Reading level dBUV	Antenna factor dB/m	Cable loss dB	Preamp factor dB	level dBUV/m	Limit level dBUV/m	Over limit dB	Remark
2310.000	36.53	27.14	2.81	30.43	36.05	54.00	-17.95	Average
2310.000	48.00	27.14	2.81	30.43	47.52	74.00	-26.48	Peak
2390.000	37.69	27.37	2.91	30.24	37.73	54.00	-16.27	Average
2390.000	50.46	27.37	2.91	30.24	50.50	74.00	-23.50	Peak

Test channel:	Highest	Polarization:	Horizontal
---------------	---------	---------------	------------

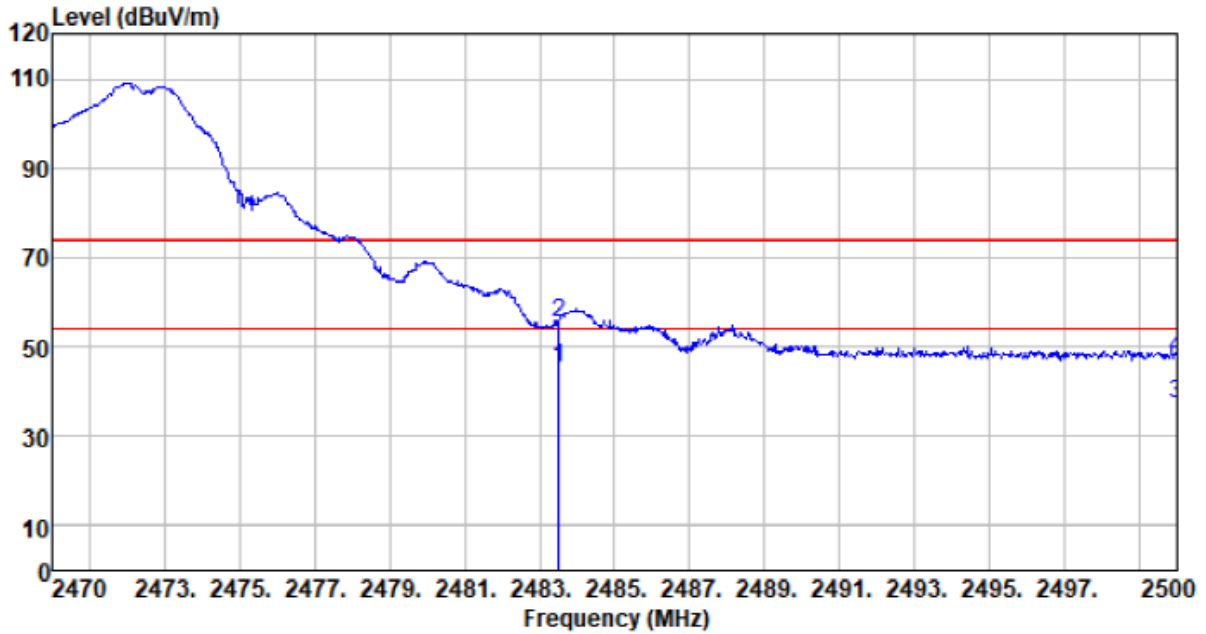

Freq MHz	Reading level dBUV	Antenna factor dB/m	Cable loss dB	Preamp factor dB	level dBUV/m	Limit level dBUV/m	Over limit dB	Remark
2483.500	44.83	27.66	2.99	30.12	45.36	54.00	-8.64	Average
2483.500	54.83	27.66	2.99	30.12	55.36	74.00	-18.64	Peak
2500.000	36.50	27.70	3.01	30.13	37.08	54.00	-16.92	Average
2500.000	47.02	27.70	3.01	30.13	47.60	74.00	-26.40	Peak

Test channel:	Highest	Polarization:	Vertical
---------------	---------	---------------	----------

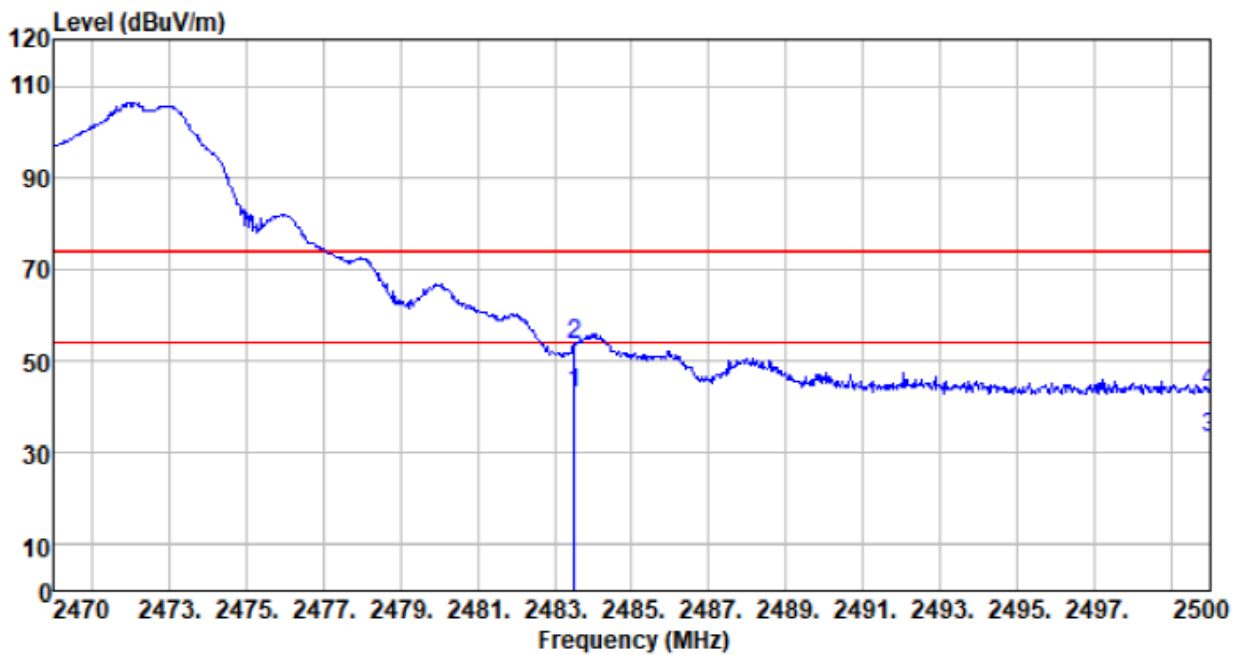

Freq MHz	Reading level dBuV	Antenna factor dB/m	Cable loss dB	Preamp factor dB	level dBuV/m	Limit level dBuV/m	Over limit dB	Remark
2483.500	42.33	27.66	2.99	30.12	42.86	54.00	-11.14	Average
2483.500	52.91	27.66	2.99	30.12	53.44	74.00	-20.56	Peak
2500.000	32.50	27.70	3.01	30.13	33.08	54.00	-20.92	Average
2500.000	42.87	27.70	3.01	30.13	43.45	74.00	-30.55	Peak

**Remark:**

1. *Final Level = Receiver Read level + Antenna Factor + Cable Loss – Pre-amplifier Factor*
2. *The emission levels of other frequencies are very lower than the limit and not show in test report.*

## 7.8 Spurious Emission

### 7.8.1 Conducted Emission Method

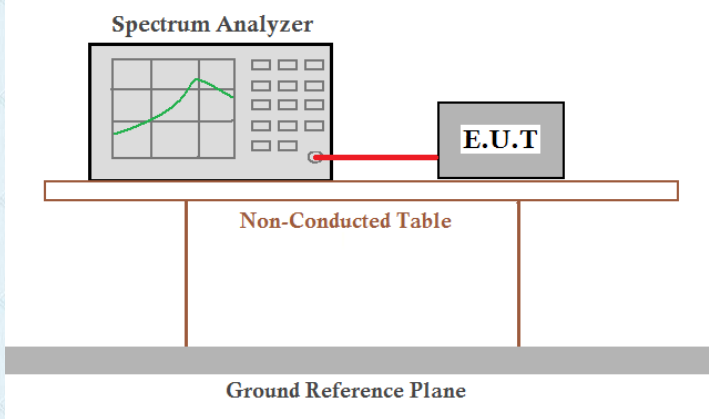
Test Requirement:	FCC Part15 C Section 15.247 (d)
Test Method:	ANSI C63.10:2013
Limit:	In any 100 kHz bandwidth outside the frequency band in which the spread spectrum intentional radiator is operating, the radio frequency power that is produced by the intentional radiator shall be at least 20 dB below that in the 100 kHz bandwidth within the band that contains the highest level of the desired power, based on either an RF conducted or a radiated measurement.
Test setup:	 <p>The diagram illustrates the test setup. A Spectrum Analyzer is connected to an E.U.T. (Equipment Under Test) via a red cable. Both are placed on a Non-Conducted Table, which sits on a Ground Reference Plane.</p>
Test Instruments:	Refer to section 6.0 for details
Test mode:	Refer to section 5.2 for details
Test results:	Pass

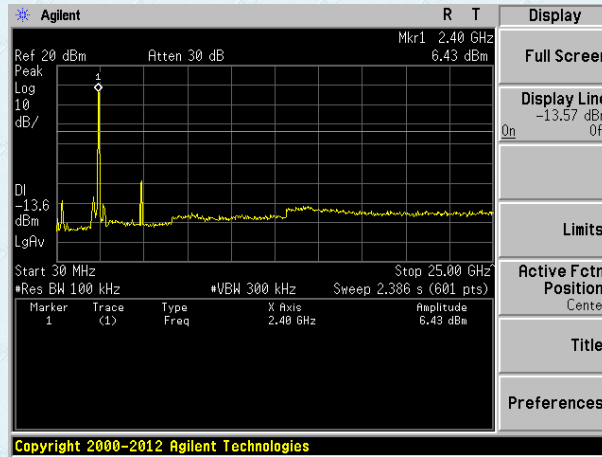

Lowest channel: 30MHz~25GHz

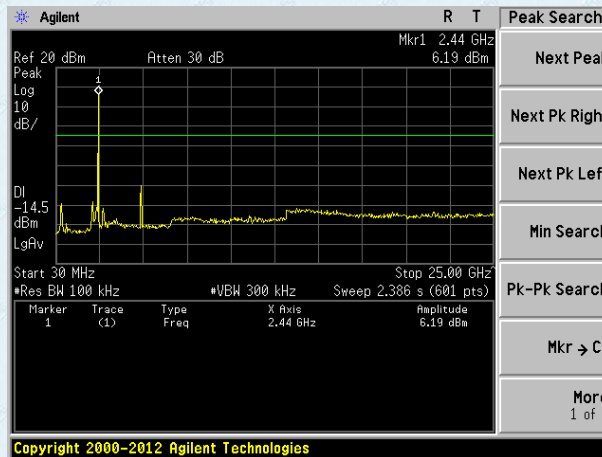

Middle channel: 30MHz~25GHz

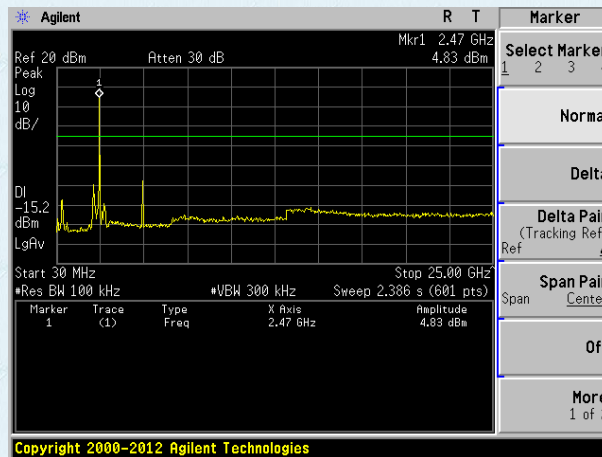

Highest channel: 30MHz~25GHz

## 7.8.2 Radiated Emission Method

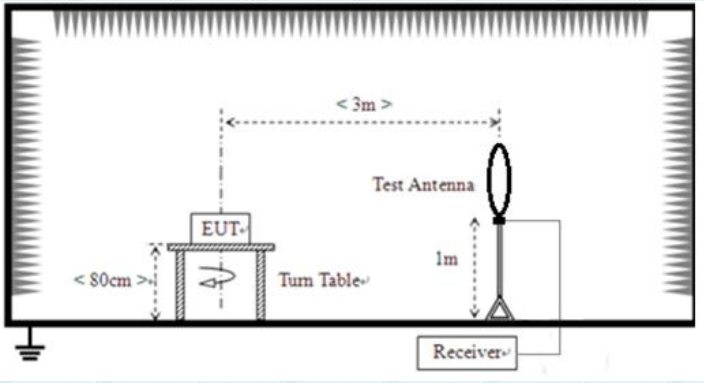
Test Requirement:	FCC Part15 C Section 15.209				
Test Method:	ANSI C63.10:2013				
Test Frequency Range:	9kHz to 25GHz				
Test site:	Measurement Distance: 3m				
Receiver setup:	Frequency	Detector	RBW	VBW	Value
	9KHz-150KHz	Quasi-peak	200Hz	600Hz	Quasi-peak
	150KHz-30MHz	Quasi-peak	9KHz	30KHz	Quasi-peak
	30MHz-1GHz	Quasi-peak	120KHz	300KHz	Quasi-peak
	Above 1GHz	Peak	1MHz	3MHz	Peak
Peak		1MHz	10Hz	Average	
Limit: (Spurious Emissions)	Frequency	Limit (uV/m)	Value	Measurement Distance	
	0.009MHz-0.490MHz	2400/F(KHz)	PK,AV,QP	300m	
	0.490MHz-1.705MHz	24000/F(KHz)	QP	30m	
	1.705MHz-30MHz	30	QP	30m	
	30MHz-88MHz	100	QP	3m	
	88MHz-216MHz	150	QP		
	216MHz-960MHz	200	QP		
	960MHz-1GHz	500	QP		
	Above 1GHz	500	Average		
5000		Peak			
Test setup:	Below 30MHz				
	 <p>The diagram illustrates the test setup for frequencies below 30 MHz. It shows an Equipment Under Test (EUT) placed on a turn table. The EUT is positioned at a height of at least 80 cm above the ground plane. A test antenna is placed at a distance of 3 meters from the EUT and is 1 meter high. The antenna is connected to a receiver. The ground plane is indicated by a ground symbol.</p>				
Below 1GHz					

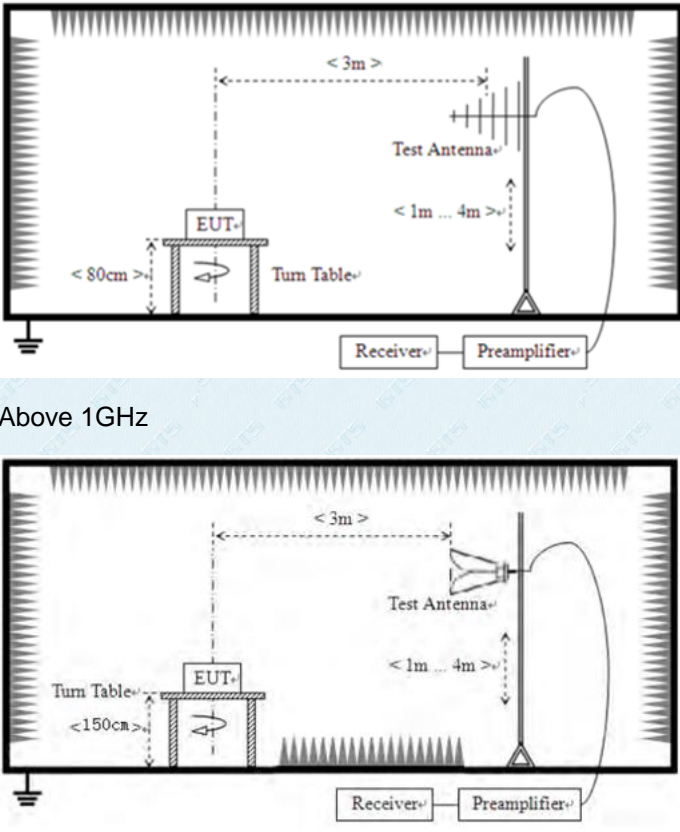
	 <p>Above 1GHz</p>						
<p>Test Procedure:</p>	<ol style="list-style-type: none"> <li>1. The EUT was placed on the top of a rotating table (0.8 meters for below 1GHz and 1.5meters for above 1GHz) above the ground at a 3 meter camber. The table was rotated 360 degrees to determine the position of the highest radiation.</li> <li>2. The EUT was set 3 meters away from the interference-receiving antenna, which was mounted on the top of a variable-height antenna tower.</li> <li>3. The antenna height is varied from one meter to four meters above the ground to determine the maximum value of the field strength. Both horizontal and vertical polarizations of the antenna are set to make the measurement.</li> <li>4. For each suspected emission, the EUT was arranged to its worst case and then the antenna was tuned to heights from 1 meter to 4 meters and the rota table was turned from 0 degrees to 360 degrees to find the maximum reading.</li> <li>5. The test-receiver system was set to Peak Detect Function and Specified Bandwidth with Maximum Hold Mode.</li> <li>6. If the emission level of the EUT in peak mode was 10dB lower than the limit specified, then testing could be stopped and the peak values of the EUT would be reported. Otherwise the emissions that did not have 10dB margin would be re-tested one by one using peak, quasi-peak or average method as specified and then reported in a data sheet.</li> </ol>						
<p>Test Instruments:</p>	<p>Refer to section 5.8 for details</p>						
<p>Test mode:</p>	<p>Refer to section 5.2 for details</p>						
<p>Temp. / Hum.</p>	<table border="1"> <tr> <td>Temp.:</td> <td>25 °C</td> <td>Humid.:</td> <td>52%</td> <td>Press.:</td> <td>1 012mbar</td> </tr> </table>	Temp.:	25 °C	Humid.:	52%	Press.:	1 012mbar
Temp.:	25 °C	Humid.:	52%	Press.:	1 012mbar		



Test results:	Pass
---------------	------

**Remark:**

1. *Pre-scan all kind of the place mode (X-axis, Y-axis, Z-axis), and found the Y-axis which it is worse case.*

**Measurement data:**

■ **Below 30MHz**

The low frequency, which started from 9 kHz to 30 MHz, was pre-scanned and the result which was 20 dB lower than the limit line per 15.31(o) was not reported.

■ 30MHz ~ 1GHz

Test channel:	Lowest	Polarization:	Horizontal
---------------	--------	---------------	------------

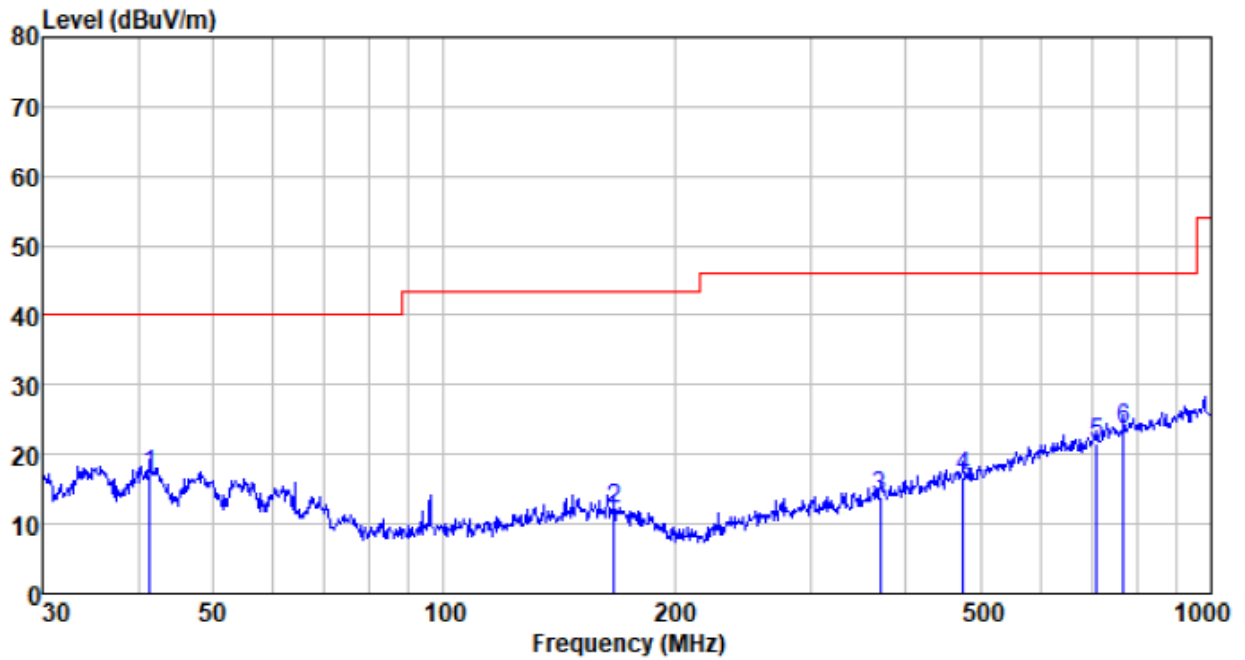

Freq MHz	Reading level dBuV	Antenna factor dB/m	Cable loss dB	Preamp factor dB	level dBuV/m	Limit level dBuV/m	Over limit dB	Remark
41.422	39.10	13.17	0.68	35.75	17.20	40.00	-22.80	QP
166.651	35.10	12.55	1.67	37.17	12.15	43.50	-31.35	QP
370.702	34.53	14.08	2.72	37.49	13.84	46.00	-32.16	QP
475.499	34.80	16.32	3.21	37.51	16.82	46.00	-29.18	QP
709.182	34.36	20.60	4.12	37.63	21.45	46.00	-24.55	QP
768.748	35.07	21.81	4.35	37.62	23.61	46.00	-22.39	QP

Test channel:	Lowest	Polarization:	Vertical
---------------	--------	---------------	----------

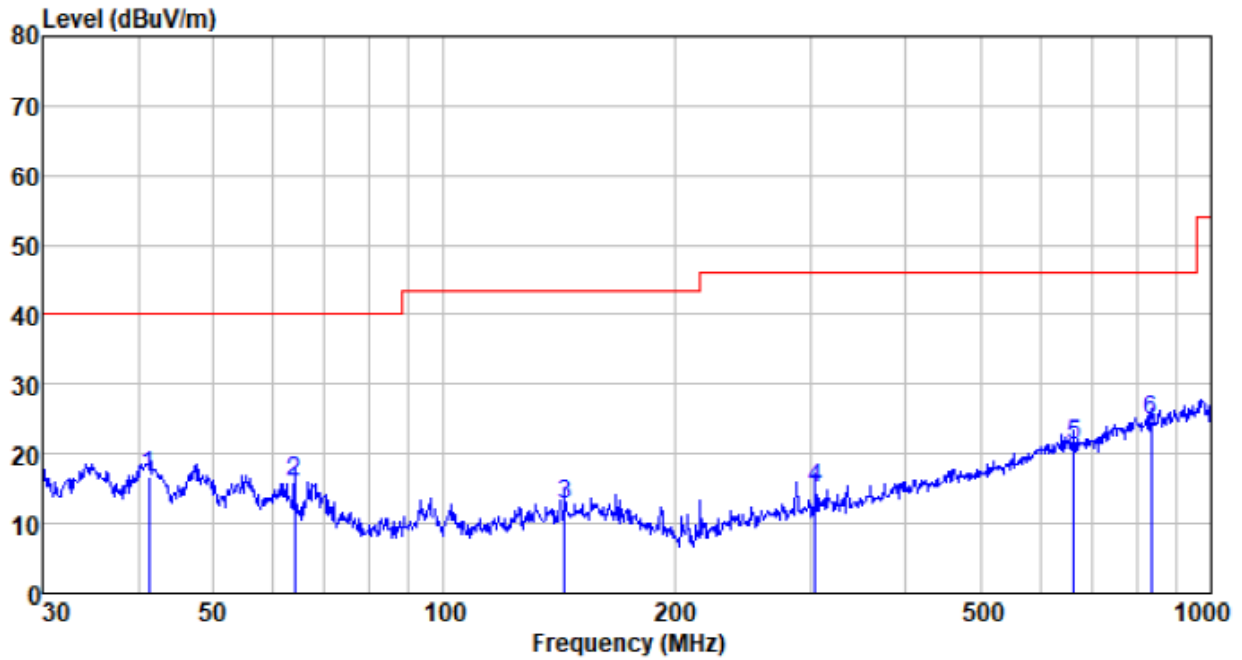

Freq MHz	Reading level dBuV	Antenna factor dB/m	Cable loss dB	Preamp factor dB	level dBuV/m	Limit level dBuV/m	Over limit dB	Remark
41.277	38.80	13.18	0.68	35.74	16.92	40.00	-23.08	QP
63.983	39.80	11.63	0.89	36.37	15.95	40.00	-24.05	QP
143.830	36.02	12.32	1.53	37.04	12.83	43.50	-30.67	QP
304.610	37.63	12.53	2.38	37.43	15.11	46.00	-30.89	QP
663.473	34.90	20.03	3.96	37.60	21.29	46.00	-24.71	QP
836.244	35.18	22.49	4.60	37.61	24.66	46.00	-21.34	QP

Test channel:	Middle	Polarization:	Horizontal
---------------	--------	---------------	------------

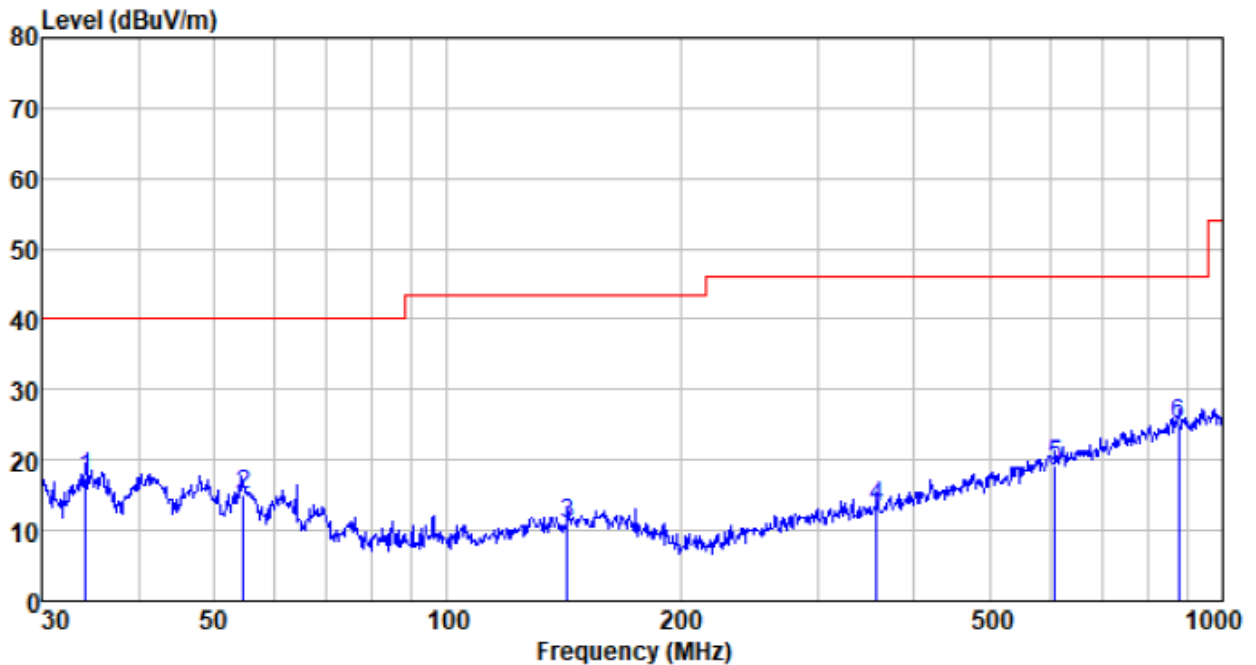

Freq MHz	Reading level dBuV	Antenna factor dB/m	Cable loss dB	Preamp factor dB	level dBuV/m	Limit level dBuV/m	Over limit dB	Remark
34.156	39.69	12.44	0.60	35.30	17.43	40.00	-22.57	QP
54.643	38.02	12.58	0.81	36.25	15.16	40.00	-24.84	QP
142.824	34.16	12.24	1.52	37.03	10.89	43.50	-32.61	QP
357.929	34.48	13.75	2.66	37.48	13.41	46.00	-32.59	QP
607.787	33.63	19.38	3.75	37.55	19.21	46.00	-26.79	QP
878.322	35.06	22.79	4.77	37.60	25.02	46.00	-20.98	QP

Test channel:	Middle	Polarization:	Vertical
---------------	--------	---------------	----------

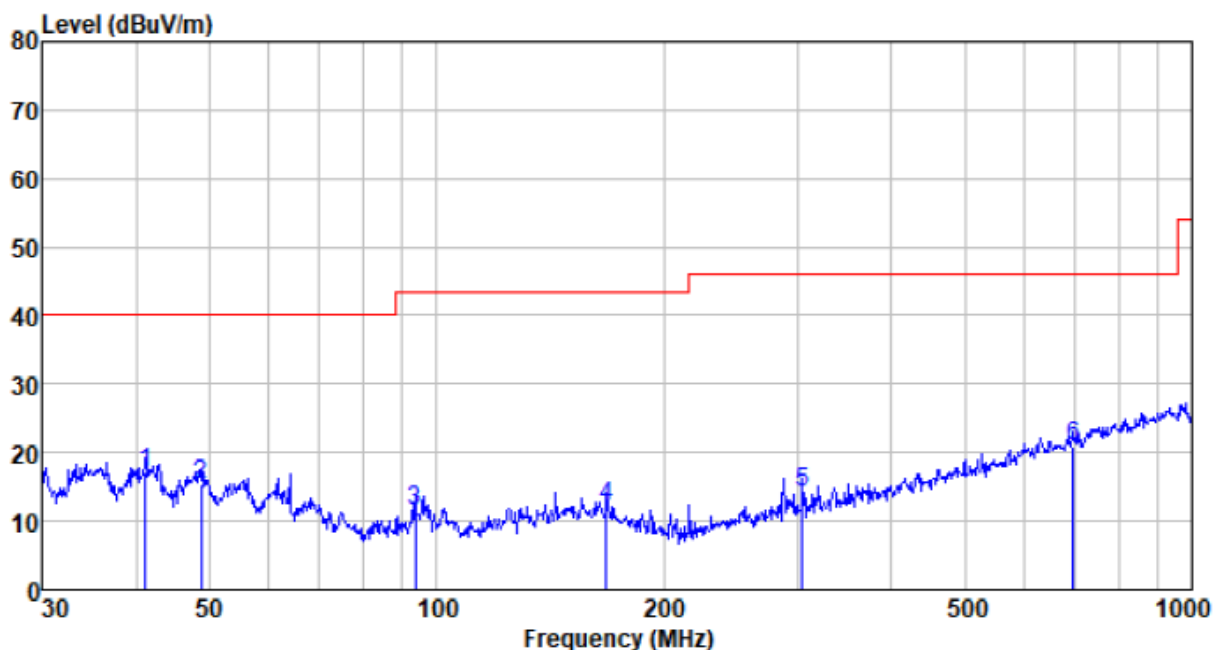

Freq MHz	Reading level dBuV	Antenna factor dB/m	Cable loss dB	Preamp factor dB	level dBuV/m	Limit level dBuV/m	Over limit dB	Remark
41.132	38.96	13.19	0.67	35.73	17.09	40.00	-22.91	QP
48.672	37.78	13.02	0.76	36.12	15.44	40.00	-24.56	QP
93.768	38.31	8.69	1.14	36.67	11.47	43.50	-32.03	QP
167.824	35.22	12.52	1.67	37.18	12.23	43.50	-31.27	QP
304.610	36.82	12.53	2.38	37.43	14.30	46.00	-31.70	QP
696.857	34.30	20.35	4.08	37.63	21.10	46.00	-24.90	QP

Test channel:	Highest	Polarization:	Horizontal
---------------	---------	---------------	------------

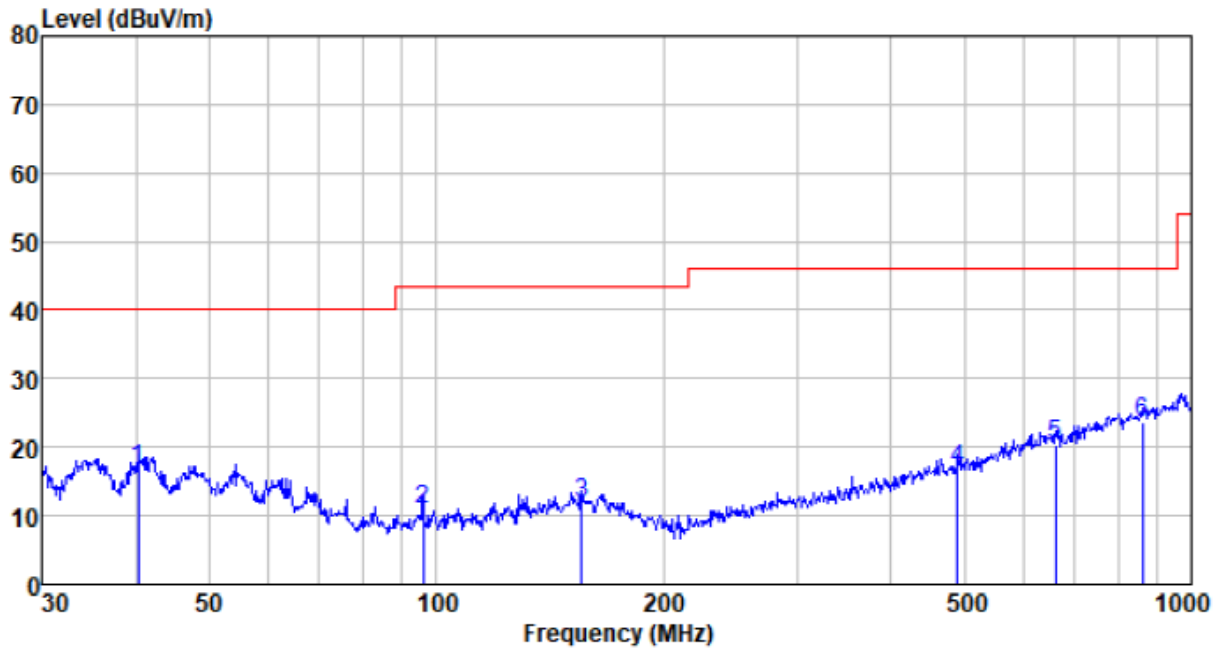

Freq MHz	Reading level dBuV	Antenna factor dB/m	Cable loss dB	Preamp factor dB	level dBuV/m	Limit level dBuV/m	Over limit dB	Remark
40.276	38.59	13.24	0.66	35.68	16.81	40.00	-23.19	QP
96.099	37.74	8.85	1.16	36.69	11.06	43.50	-32.44	QP
155.910	34.42	12.78	1.60	37.11	11.69	43.50	-31.81	QP
490.745	34.54	16.51	3.26	37.51	16.80	46.00	-29.20	QP
661.151	34.06	20.01	3.95	37.60	20.42	46.00	-25.58	QP
860.035	33.83	22.66	4.69	37.61	23.57	46.00	-22.43	QP

Test channel:	Highest	Polarization:	Vertical
---------------	---------	---------------	----------

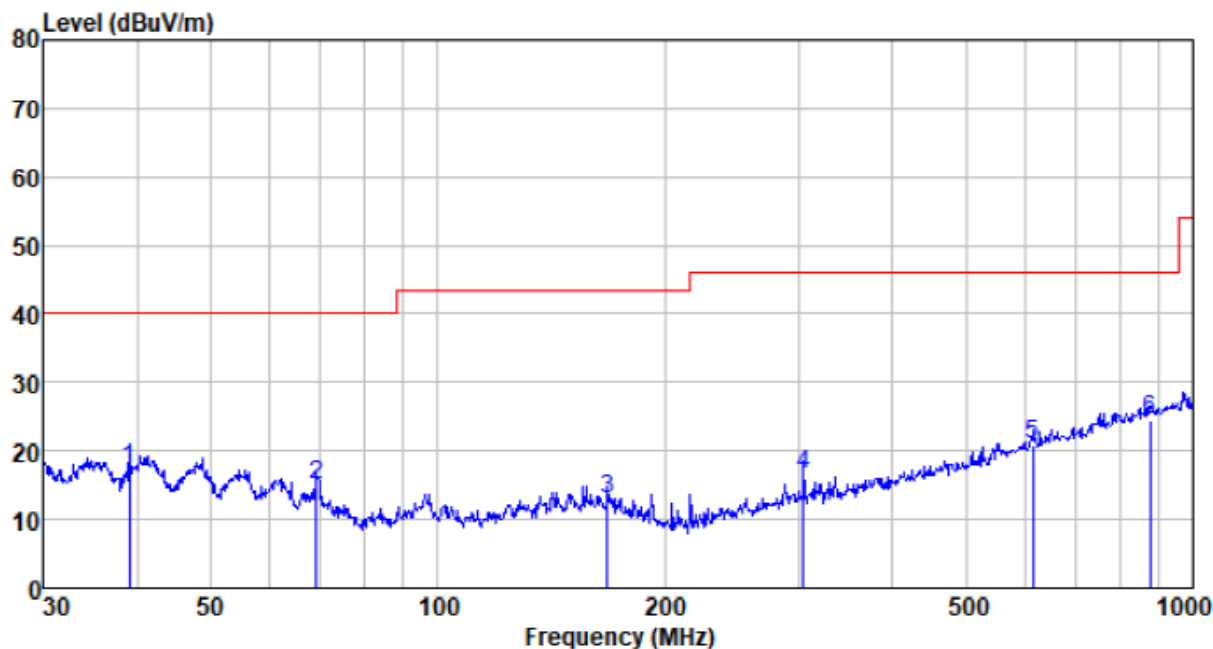

Freq MHz	Reading level dBuV	Antenna factor dB/m	Cable loss dB	Preamp factor dB	level dBuV/m	Limit level dBuV/m	Over limit dB	Remark
39.024	39.27	13.11	0.65	35.61	17.42	40.00	-22.58	QP
69.114	39.68	10.75	0.93	36.43	14.93	40.00	-25.07	QP
167.824	35.85	12.52	1.67	37.18	12.86	43.50	-30.64	QP
304.610	39.16	12.53	2.38	37.43	16.64	46.00	-29.36	QP
614.214	35.29	19.50	3.77	37.55	21.01	46.00	-24.99	QP
878.322	34.61	22.79	4.77	37.60	24.57	46.00	-21.43	QP

■ Above 1GHz

Test channel:	Lowest	Polarization:	Horizontal
---------------	--------	---------------	------------

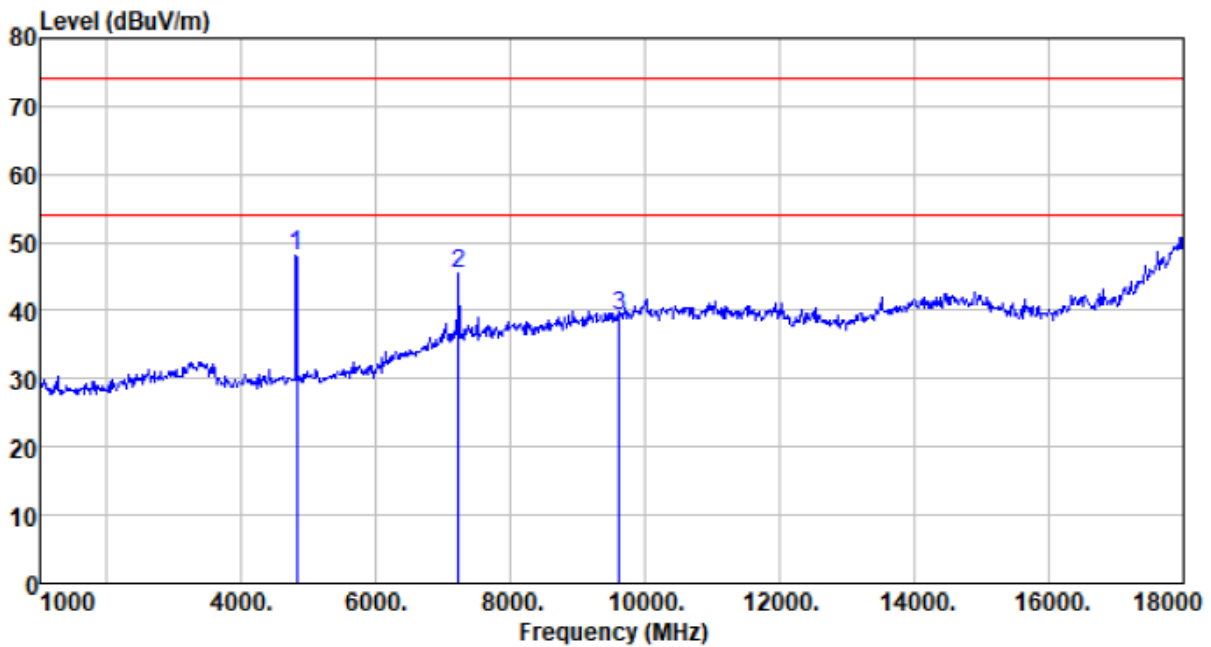

Freq MHz	Reading level dBuV	Antenna factor dB/m	Cable loss dB	Preamp factor dB	level dBuV/m	Limit level dBuV/m	Over limit dB	Remark
4812.000	49.95	31.22	4.61	37.73	48.05	74.00	-25.95	Peak
7216.000	38.32	36.20	6.50	35.63	45.39	74.00	-28.61	Peak
9618.000	28.34	37.93	7.98	34.94	39.31	74.00	-34.69	Peak



Test channel:	Lowest	Polarization:	Vertical
---------------	--------	---------------	----------

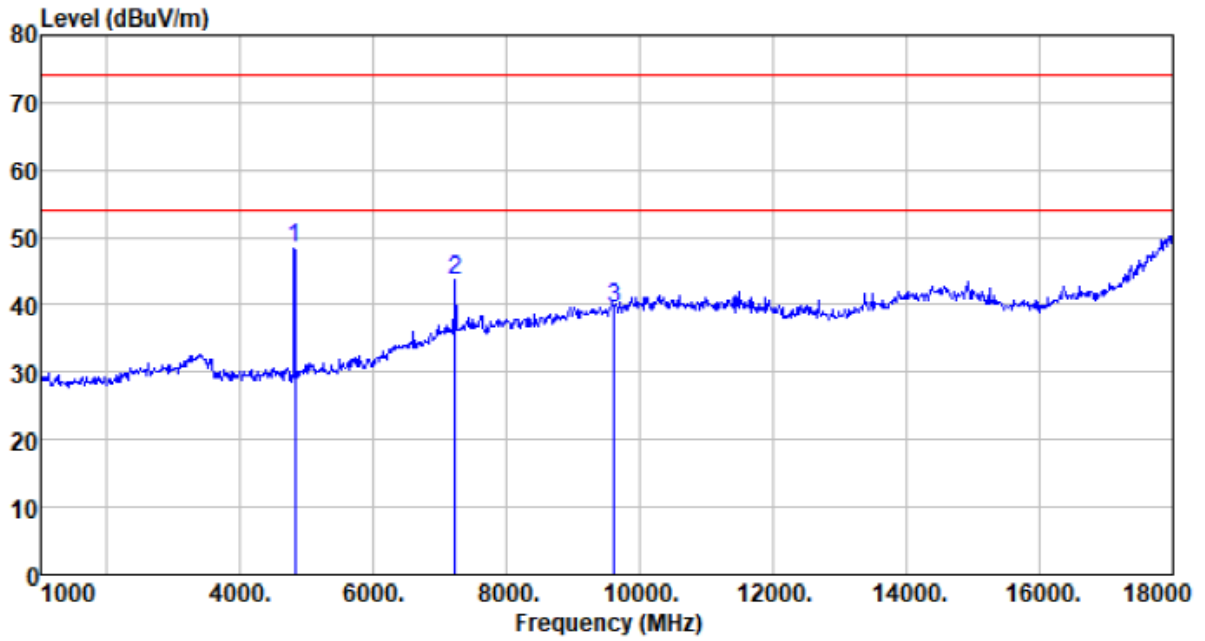

Freq MHz	Reading level dBuV	Antenna factor dB/m	Cable loss dB	Preamp factor dB	level dBuV/m	Limit level dBuV/m	Over limit dB	Remark
4812.000	50.31	31.22	4.61	37.73	48.41	74.00	-25.59	Peak
7216.000	36.77	36.20	6.50	35.63	43.84	74.00	-30.16	Peak
9618.000	28.59	37.93	7.98	34.94	39.56	74.00	-34.44	Peak

Test channel:	Middle	Polarization:	Horizontal
---------------	--------	---------------	------------

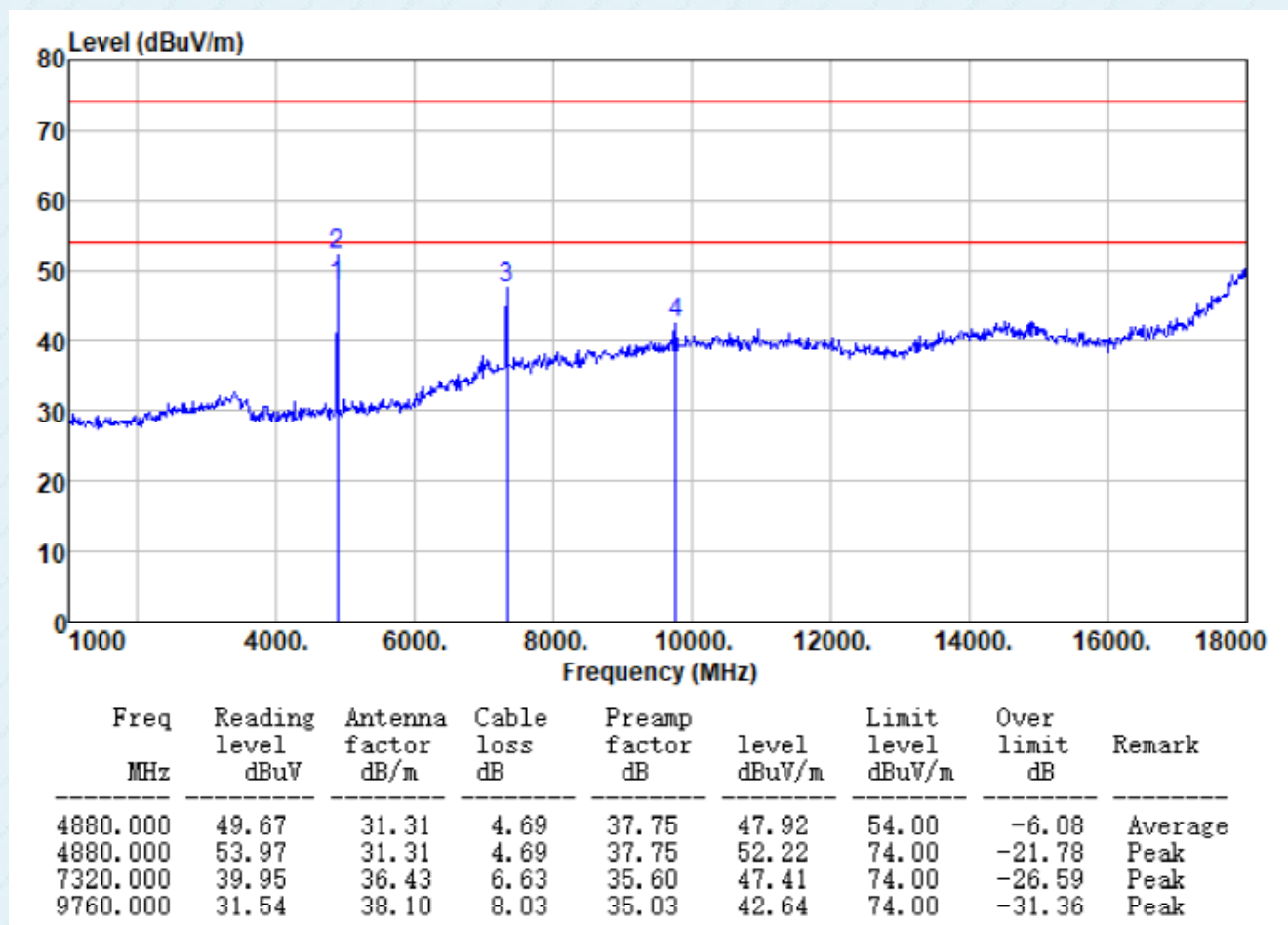

Test channel:	Middle	Polarization:	Vertical
---------------	--------	---------------	----------

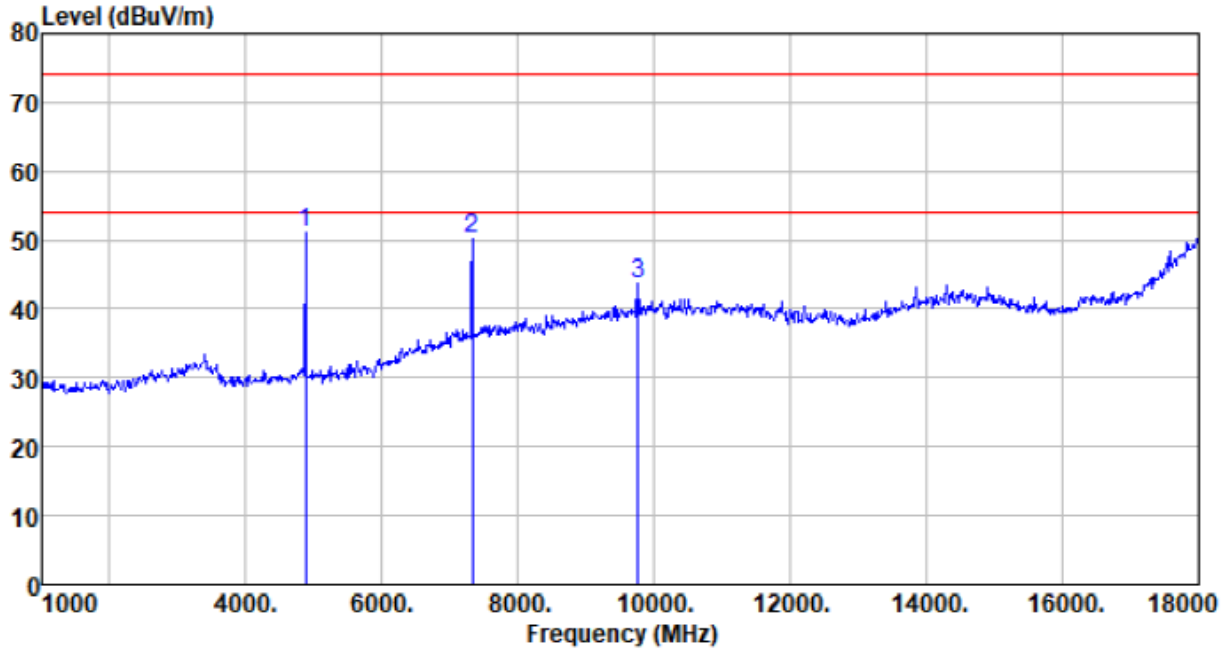

Freq MHz	Reading level dBuV	Antenna factor dB/m	Cable loss dB	Preamp factor dB	level dBuV/m	Limit level dBuV/m	Over limit dB	Remark
4880.000	52.87	31.31	4.69	37.75	51.12	74.00	-22.88	Peak
7320.000	42.80	36.43	6.63	35.60	50.26	74.00	-23.74	Peak
9760.000	32.48	38.10	8.03	35.03	43.58	74.00	-30.42	Peak

Test channel:	Highest	Polarization:	Horizontal
---------------	---------	---------------	------------

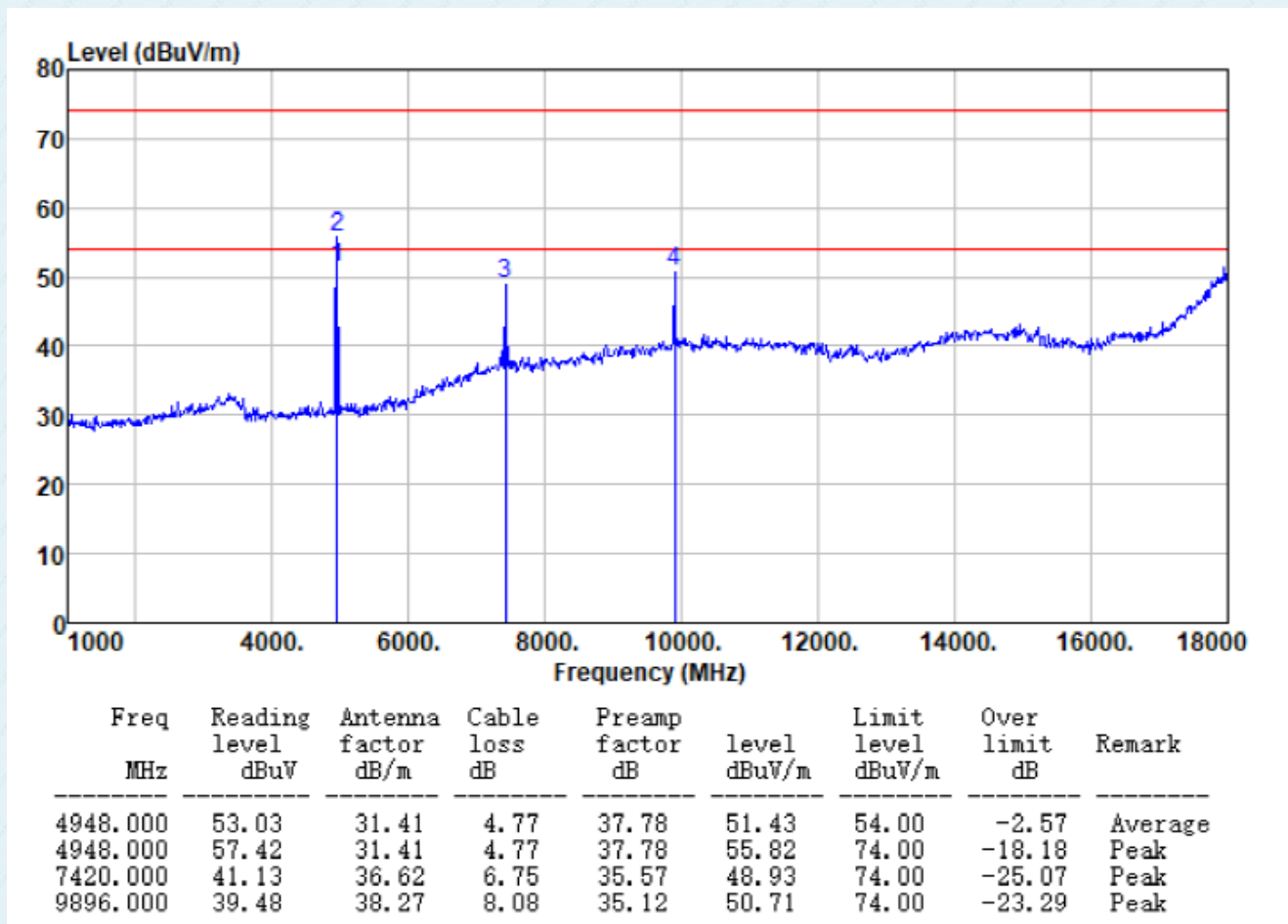

Test channel:	Highest	Polarization:	Vertical
---------------	---------	---------------	----------

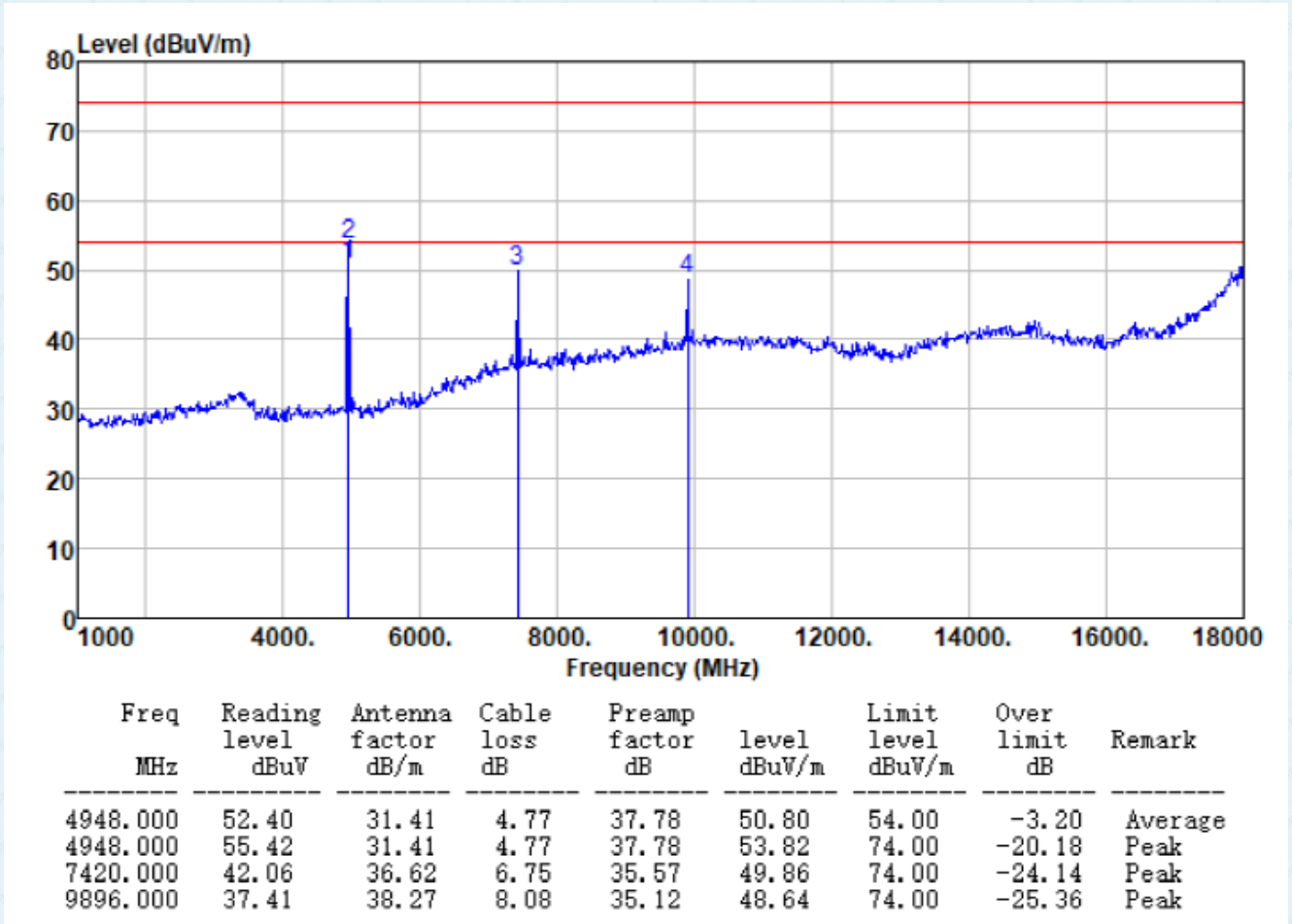

**Remark:**

1. Final Level = Receiver Read level + Antenna Factor + Cable Loss – Preamplifier Factor
2. No emission found in frequency above 18GHz.

## 8 Test Setup Photo

Reference to the **appendix I** for details.

## 9 EUT Constructional Details

Reference to the **appendix II** for details.

---End---