

# TEST REPORT

**Applicant:** FLYSKY RC MODEL TECHNOLOGY CO., LTD

**Address of Applicant:** West building3, Huangjianyuan Ind, Park QIAOLI North Gate  
Changping Town, Dongguan, China

**Manufacturer:** ShenZhen FLYSKY Technology Co.,Ltd

**Address of Manufacturer:** 16F, Huafeng Building, No. 6006 Shennan Road, Futian  
District, Shenzhen, Guangdong, China

**Factory:** Dongguan Flysky RC Model technology Co.,Ltd

**Address of Factory:** West building 3,Huangjianyuan Ind Park, QIAOLI North Gate,  
Changping Town, Dongguan, China

**Equipment Under Test (EUT)**

Product Name: Digital proportional radio control system

Model No.: HW-711, WP-1040-BRUSHED-2IN1-FS Rx-RTR

Trade Mark: FLYSKY

**FCC ID:** N4ZHW711

**Applicable standards:** FCC CFR Title 47 Part 15 Subpart C Section 15.247

**Date of sample receipt:** January 21, 2021

**Date of Test:** January 22, 2021-March 30, 2021

**Date of report issued:** March 30, 2021

**Test Result :** PASS \*

\* In the configuration tested, the EUT complied with the standards specified above.

Authorized Signature:

Robinson Lo  
Laboratory Manager

This results shown in this test report refer only to the sample(s) tested, this test report cannot be reproduced, except in full, without prior written permission of the company. The report would be invalid without specific stamp of test institute and the signatures of compiler and approver.

## 2 Version

Version No.	Date	Description
00	March 30, 2021	Original

Prepared By:



Date:

March 30, 2021

Project Engineer

Check By:



Date:

March 30, 2021

Reviewer

## 3 Contents

Page

1	COVER PAGE .....	1
2	VERSION .....	2
3	CONTENTS .....	3
4	TEST SUMMARY .....	4
4.1	MEASUREMENT UNCERTAINTY .....	4
5	GENERAL INFORMATION .....	5
5.1	GENERAL DESCRIPTION OF EUT .....	5
5.2	TEST MODE .....	7
5.3	TEST FACILITY .....	7
5.4	TEST LOCATION .....	7
5.5	DESCRIPTION OF SUPPORT UNITS .....	7
5.6	DEVIATION FROM STANDARDS.....	7
5.7	ABNORMALITIES FROM STANDARD CONDITIONS.....	7
5.8	ADDITIONAL INSTRUCTIONS.....	7
6	TEST INSTRUMENTS LIST .....	8
7	TEST RESULTS AND MEASUREMENT DATA .....	10
7.1	ANTENNA REQUIREMENT.....	10
7.2	CONDUCTED PEAK OUTPUT POWER.....	11
7.3	20dB EMISSION BANDWIDTH .....	13
7.4	CARRIER FREQUENCIES SEPARATION.....	15
7.5	HOPPING CHANNEL NUMBER .....	17
7.6	DWELL TIME .....	18
7.7	BAND EDGE .....	22
7.7.1	Conducted Emission Method .....	22
7.7.2	Radiated Emission Method .....	24
7.8	SPURIOUS EMISSION .....	29
7.8.1	Conducted Emission Method .....	29
7.8.2	Radiated Emission Method .....	31
8	TEST SETUP PHOTO .....	42
9	EUT CONSTRUCTIONAL DETAILS.....	42

## 4 Test Summary

Test Item	Section	Result
Antenna Requirement	15.203/15.247 (c)	Pass
AC Power Line Conducted Emission	15.207	N/A
Conducted Peak Output Power	15.247 (b)(1)	Pass
20dB Occupied Bandwidth	15.247 (a)(1)	Pass
Carrier Frequencies Separation	15.247 (a)(1)	Pass
Hopping Channel Number	15.247 (a)(1)	Pass
Dwell Time	15.247 (a)(1)	Pass
Pseudorandom Frequency Hopping Sequence	15.247(b)(4)	Pass
Radiated Emission	15.205/15.209	Pass
Band Edge	15.247(d)	Pass

*Pass: The EUT complies with the essential requirements in the standard.*

*N/A: Not applicable*

*Remark : Test according to ANSI C63.10:2013.*

### 4.1 Measurement Uncertainty

Test Item	Frequency Range	Measurement Uncertainty	Notes
Radiated Emission	30MHz-200MHz	3.8039dB	(1)
Radiated Emission	200MHz-1GHz	3.9679dB	(1)
Radiated Emission	1GHz-18GHz	4.29dB	(1)
Radiated Emission	18GHz-40GHz	3.30dB	(1)
AC Power Line Conducted Emission	0.15MHz ~ 30MHz	3.44dB	(1)

Note (1): The measurement uncertainty is for coverage factor of k=2 and a level of confidence of 95%.

## 5 General Information

### 5.1 General Description of EUT

Product Name:	Digital proportional radio control system
Model No.:	HW-711, WP-1040-BRUSHED-2IN1-FS Rx-RTR
Test Model No.:	HW-711
Remark:All above models are identical in the same PCB layout, interior structure and electrical circuits. The difference is model name for commercial purpose.	
Serial No.:	N/A
Test sample(s) ID:	GTS202101000172-1
Sample(s) Status	Engineer sample
Operation Frequency:	2406MHz~2472MHz
Channel separation:	3 MHz
Modulation technology:	DSSS
Antenna Type:	Integral Antenna
Antenna gain:	2.0dBi
Power supply:	DC 6V

Operation Frequency each of channel							
Channel	Frequency (MHz)	Channel	Frequency (MHz)	Channel	Frequency (MHz)	Channel	Frequency (MHz)
1	2406	2	2409	3	2412	4	2415
5	2418	6	2421	7	2424	8	2427
9	2430	10	2433	11	2436	12	2439
13	2442	14	2445	15	2448	16	2451
17	2454	18	2457	19	2460	20	2463
21	2466	22	2469	23	2472		

In section 15.31(m), regards to the operating frequency range over 10 MHz, the Lowest frequency, the middle frequency, and the highest frequency of channel were selected to perform the test, and the selected channel see below:

Channel	Frequency
The lowest channel	2406MHz
The middle channel	2439MHz
The Highest channel	2472MHz

## 5.2 Test mode

Transmitting mode	Keep the EUT in transmitting mode.
-------------------	------------------------------------

## 5.3 Test Facility

<p>The test facility is recognized, certified, or accredited by the following organizations:</p> <ul style="list-style-type: none"> <li>● <b>FCC —Registration No.: 381383</b> Global United Technology Services Co., Ltd., Shenzhen EMC Laboratory has been registered and fully described in a report filed with the (FCC) Federal Communications Commission. The acceptance letter from the FCC is maintained in files. Registration 381383.</li> <li>● <b>IC —Registration No.: 9079A</b> The 3m Semi-anechoic chamber of Global United Technology Services Co., Ltd. has been registered by Certification and Engineering Bureau of Industry Canada for radio equipment testing with Registration No.: 9079A</li> <li>● <b>NVLAP (LAB CODE:600179-0)</b> Global United Technology Services Co., Ltd., is accredited by the National Voluntary Laboratory Accreditation Program (NVLAP). LAB CODE:600179-0</li> </ul>
---

## 5.4 Test Location

All other tests were performed at:
<p>Global United Technology Services Co., Ltd. Address: No. 123-128, Tower A, Jinyuan Business Building, No.2, Laodong Industrial Zone, Xixiang Road, Baoan District, Shenzhen, Guangdong, China 518102 Tel: 0755-27798480 Fax: 0755-27798960</p>

## 5.5 Description of Support Units

Manufacturer	Description	Model	Serial Number
MEILI	DC POWER SUPPLY	MCH-305A	011121168

## 5.6 Deviation from Standards

None.
-------

## 5.7 Abnormalities from Standard Conditions

None.
-------

## 5.8 Additional Instructions

Software (Used for test) from client
Built-in by manufacturer, power set default.

## 6 Test Instruments list

Radiated Emission:						
Item	Test Equipment	Manufacturer	Model No.	Inventory No.	Cal.Date (mm-dd-yy)	Cal.Due date (mm-dd-yy)
1	3m Semi- Anechoic Chamber	ZhongYu Electron	9.2(L)*6.2(W)* 6.4(H)	GTS250	July. 02 2020	July. 01 2025
2	Control Room	ZhongYu Electron	6.2(L)*2.5(W)* 2.4(H)	GTS251	N/A	N/A
3	EMI Test Receiver	Rohde & Schwarz	ESU26	GTS203	June. 25 2020	June. 24 2021
4	BiConiLog Antenna	SCHWARZBECK MESS-ELEKTRONIK	VULB9163	GTS214	June. 25 2020	June. 24 2021
5	Double -ridged waveguide horn	SCHWARZBECK MESS-ELEKTRONIK	BBHA 9120 D	GTS208	June. 25 2020	June. 24 2021
6	Horn Antenna	ETS-LINDGREN	3160	GTS217	June. 25 2020	June. 24 2021
7	EMI Test Software	AUDIX	E3	N/A	N/A	N/A
8	Coaxial Cable	GTS	N/A	GTS213	June. 25 2020	June. 24 2021
9	Coaxial Cable	GTS	N/A	GTS211	June. 25 2020	June. 24 2021
10	Coaxial cable	GTS	N/A	GTS210	June. 25 2020	June. 24 2021
11	Coaxial Cable	GTS	N/A	GTS212	June. 25 2020	June. 24 2021
12	Amplifier(100kHz-3GHz)	HP	8347A	GTS204	June. 25 2020	June. 24 2021
13	Amplifier(2GHz-20GHz)	HP	84722A	GTS206	June. 25 2020	June. 24 2021
14	Amplifier (18-26GHz)	Rohde & Schwarz	AFS33-18002 650-30-8P-44	GTS218	June. 25 2020	June. 24 2021
15	Band filter	Amindeon	82346	GTS219	June. 25 2020	June. 24 2021
16	Power Meter	Anritsu	ML2495A	GTS540	June. 25 2020	June. 24 2021
17	Power Sensor	Anritsu	MA2411B	GTS541	June. 25 2020	June. 24 2021
18	Wideband Radio Communication Tester	Rohde & Schwarz	CMW500	GTS575	June. 25 2020	June. 24 2021
19	Splitter	Agilent	11636B	GTS237	June. 25 2020	June. 24 2021
20	Loop Antenna	ZHINAN	ZN30900A	GTS534	June. 25 2020	June. 24 2021
21	Breitband hornantenne	SCHWARZBECK	BBHA 9170	GTS579	Oct. 18 2020	Oct. 17 2021
22	Amplifier	TDK	PA-02-02	GTS574	Oct. 18 2020	Oct. 17 2021
23	Amplifier	TDK	PA-02-03	GTS576	Oct. 18 2020	Oct. 17 2021
24	PSA Series Spectrum Analyzer	Rohde & Schwarz	FSP	GTS578	June. 25 2020	June. 24 2021



<b>RF Conducted Test:</b>						
<b>Item</b>	<b>Test Equipment</b>	<b>Manufacturer</b>	<b>Model No.</b>	<b>Serial No.</b>	<b>Cal.Date (mm-dd-yy)</b>	<b>Cal.Due date (mm-dd-yy)</b>
1	MXA Signal Analyzer	Agilent	N9020A	GTS566	June. 25 2020	June. 24 2021
2	EMI Test Receiver	R&S	ESCI 7	GTS552	June. 25 2020	June. 24 2021
3	Spectrum Analyzer	Agilent	E4440A	GTS533	June. 25 2020	June. 24 2021
4	MXG vector Signal Generator	Agilent	N5182A	GTS567	June. 25 2020	June. 24 2021
5	ESG Analog Signal Generator	Agilent	E4428C	GTS568	June. 25 2020	June. 24 2021
6	USB RF Power Sensor	DARE	RPR3006W	GTS569	June. 25 2020	June. 24 2021
7	RF Switch Box	Shongyi	RFSW3003328	GTS571	June. 25 2020	June. 24 2021
8	Programmable Constant Temp & Humi Test Chamber	WEWON	WHTH-150L-40-880	GTS572	June. 25 2020	June. 24 2021

<b>General used equipment:</b>						
<b>Item</b>	<b>Test Equipment</b>	<b>Manufacturer</b>	<b>Model No.</b>	<b>Inventory No.</b>	<b>Cal.Date (mm-dd-yy)</b>	<b>Cal.Due date (mm-dd-yy)</b>
1	Humidity/ Temperature Indicator	KTJ	TA328	GTS243	June. 25 2020	June. 24 2021
2	Barometer	ChangChun	DYM3	GTS255	June. 25 2020	June. 24 2021

## 7 Test results and Measurement Data

### 7.1 Antenna requirement

<b>Standard requirement:</b>	FCC Part15 C Section 15.203 /247(c)
<p><b>15.203 requirement:</b></p> <p>An intentional radiator shall be designed to ensure that no antenna other than that furnished by the responsible party shall be used with the device. The use of a permanently attached antenna or of an antenna that uses a unique coupling to the intentional radiator, the manufacturer may design the unit so that a broken antenna can be replaced by the user, but the use of a standard antenna jack or electrical connector is prohibited.</p> <p><b>15.247(c) (1)(i) requirement:</b></p> <p>(i) Systems operating in the 2400-2483.5 MHz band that is used exclusively for fixed. Point-to-point operations may employ transmitting antennas with directional gain greater than 6dBi provided the maximum conducted output power of the intentional radiator is reduced by 1 dB for every 3 dB that the directional gain of the antenna exceeds 6dBi.</p>	
<b>EUT Antenna:</b>	
<p><i>The antenna is integral antenna, the best case gain of the antenna is 2.0dBi, reference to the appendix II for details.</i></p>	

## 7.2 Conducted Peak Output Power

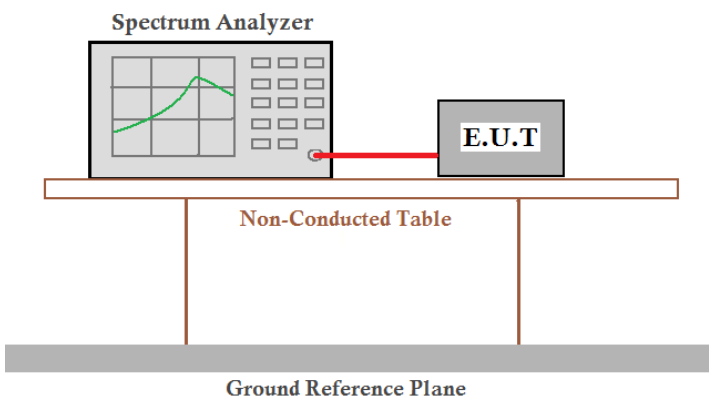
Test Requirement:	FCC Part15 C Section 15.247 (b)(1)
Test Method:	ANSI C63.10:2013
Limit:	20.97dBm
Test setup:	 <p>The diagram illustrates the test setup. A Spectrum Analyzer is connected to an E.U.T. (Equipment Under Test) via a red cable. Both are placed on a Non-Conducted Table, which is supported by a Ground Reference Plane.</p>
Test Instruments:	Refer to section 6.0 for details
Test mode:	Refer to section 5.2 for details
Test results:	Pass

### Measurement Data

Test channel	Peak Output Power (dBm)	Limit (dBm)	Result
Lowest	17.49	20.97	Pass
Middle	17.53		
Highest	17.39		

Test plot as follows:

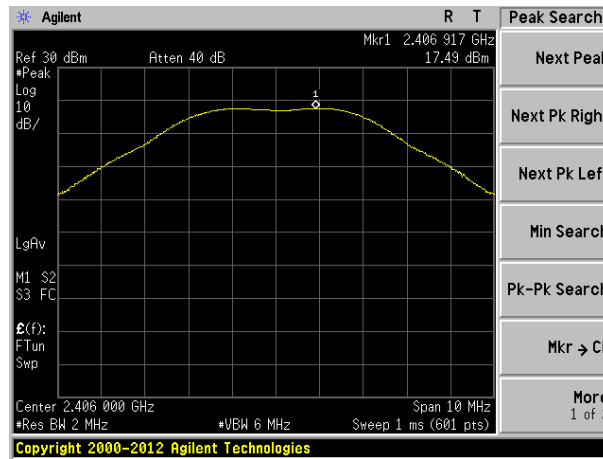

Lowest channel

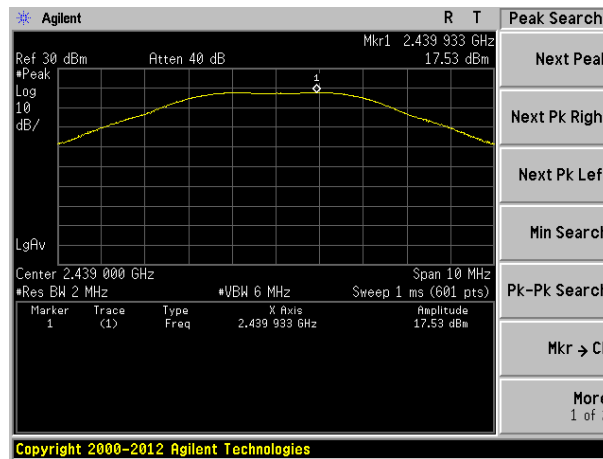

Middle channel

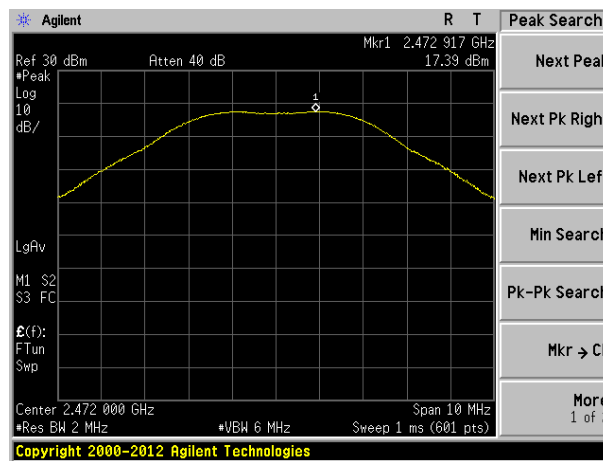

Highest channel

### 7.3 20dB Emission Bandwidth

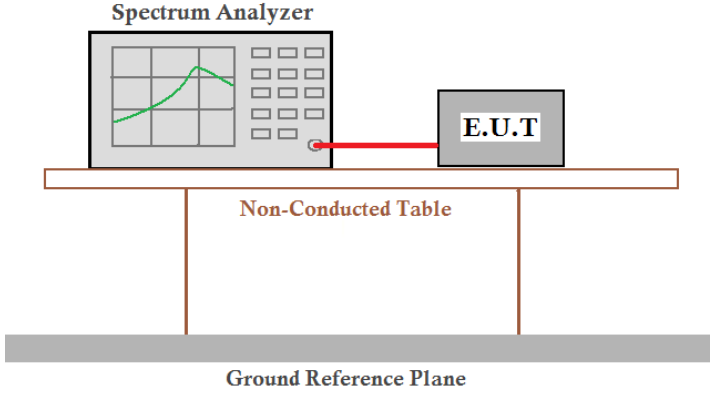
Test Requirement:	FCC Part15 C Section 15.247 (a)(1)
Test Method:	ANSI C63.10:2013
Limit:	N/A
Test setup:	 <p>The diagram illustrates the test setup. A Spectrum Analyzer is connected to an E.U.T. (Equipment Under Test) via a red cable. Both are placed on a Non-Conducted Table, which is supported by a Ground Reference Plane.</p>
Test Instruments:	Refer to section 6.0 for details
Test mode:	Refer to section 5.2 for details
Test results:	Pass

#### Measurement Data

Test channel	20dB Emission Bandwidth (MHz)	Result
Lowest	4.432	Pass
Middle	4.493	
Highest	4.458	

Test plot as follows:

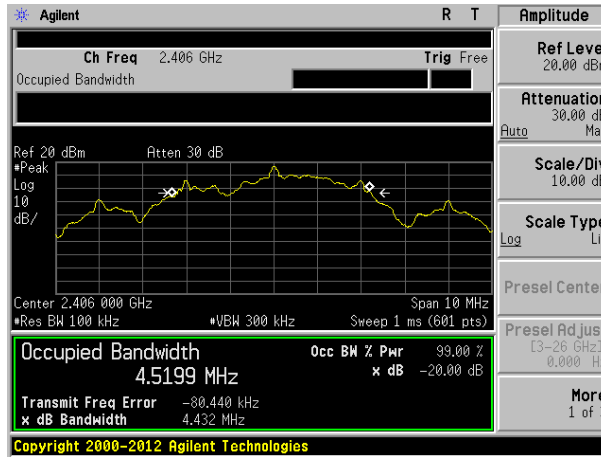

Lowest channel

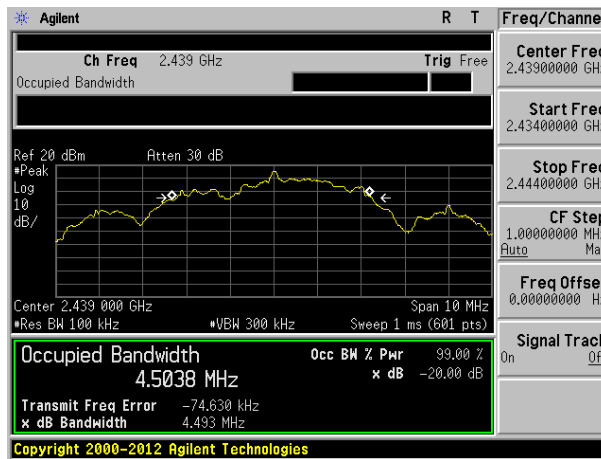

Middle channel

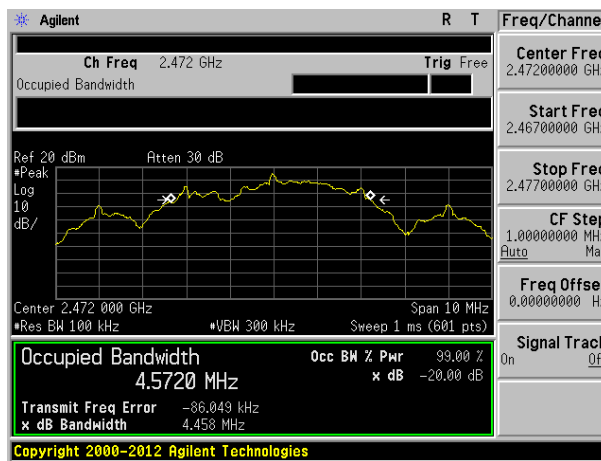

Highest channel

## 7.4 Carrier Frequencies Separation

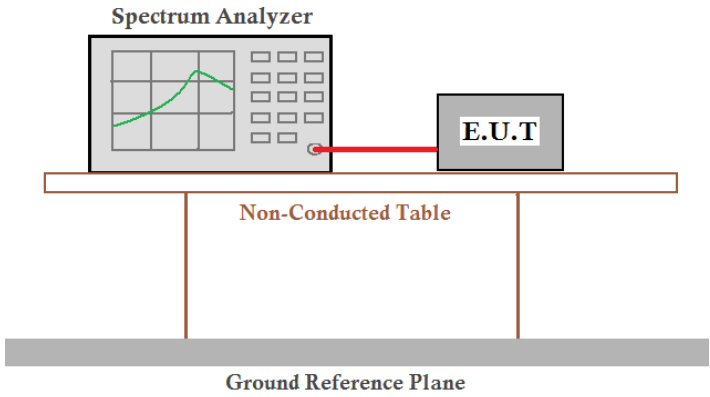
Test Requirement:	FCC Part15 C Section 15.247 (a)(1)
Test Method:	ANSI C63.10:2013
Receiver setup:	RBW=100KHz, VBW=300KHz, detector=Peak
Limit:	0.025MHz or 2/3 of the 20dB bandwidth (whichever is greater)
Test setup:	 <p>The diagram illustrates the test setup. A Spectrum Analyzer is connected to an E.U.T. (Equipment Under Test) via a red cable. Both the Spectrum Analyzer and the E.U.T. are placed on a Non-Conducted Table. The table is supported by a Ground Reference Plane.</p>
Test Instruments:	Refer to section 6.0 for details
Test mode:	Refer to section 5.2 for details
Test results:	Pass

### Measurement Data

Test channel	Carrier Frequencies Separation (kHz)	Limit (kHz)	Result
Lowest	3050	2990.67	Pass
Middle	3000	2990.67	Pass
Highest	3050	2990.67	Pass

Test plot as follows:

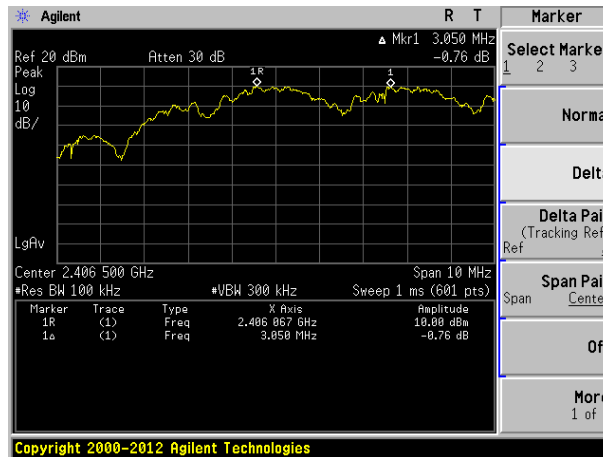

Lowest channel

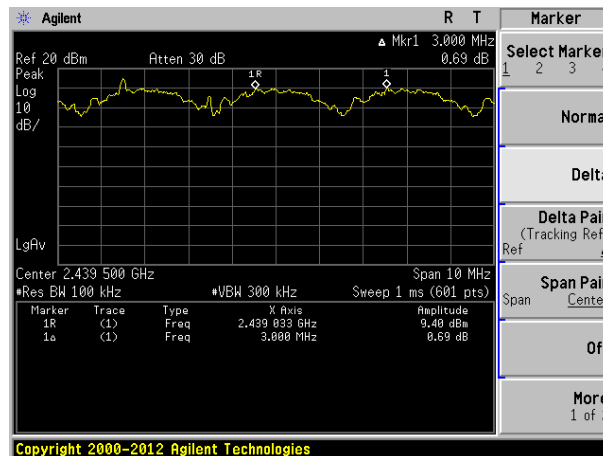

Middle channel

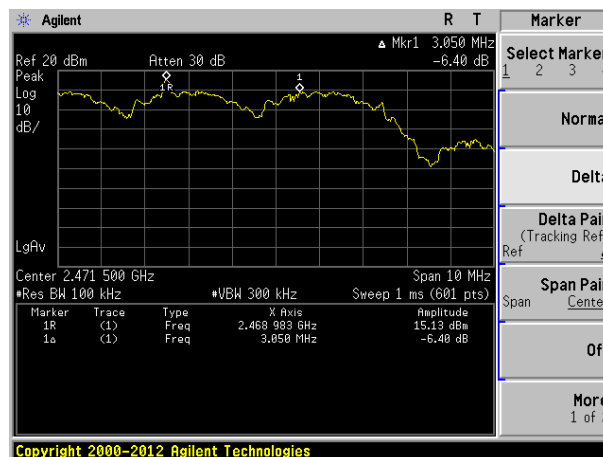

Highest channel

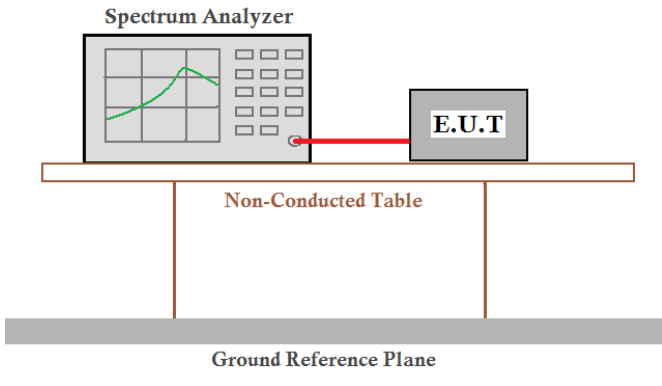

## 7.5 Hopping Channel Number

Test Requirement:	FCC Part15 C Section 15.247 (a)(1)
Test Method:	ANSI C63.10:2013
Receiver setup:	RBW=100kHz, VBW=300kHz, Frequency range=2400MHz-2483.5MHz, Detector=Peak
Limit:	15 channels
Test setup:	
Test Instruments:	Refer to section 6.0 for details
Test mode:	Refer to section 5.2 for details
Test results:	Pass

### Measurement Data:

Hopping channel numbers	Limit	Result
23	15	Pass

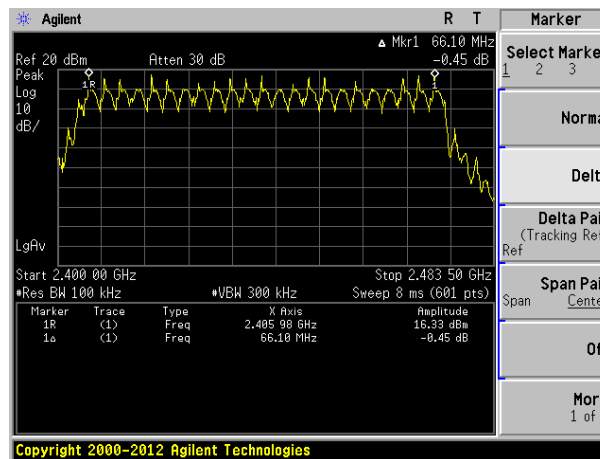

## 7.6 Dwell Time

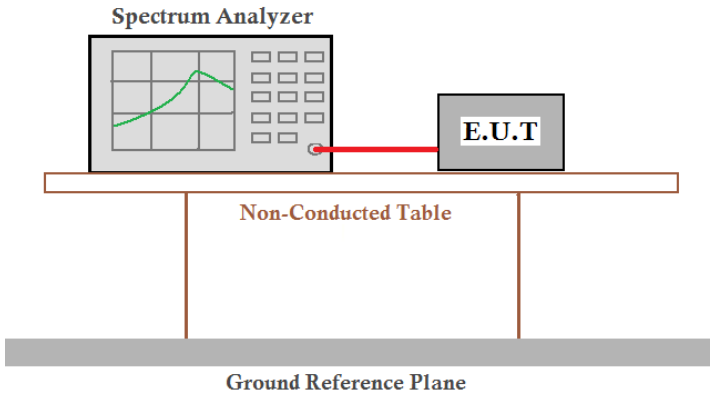
Test Requirement:	FCC Part15 C Section 15.247 (a)(1)
Test Method:	ANSI C63.10:2013
Receiver setup:	RBW=1MHz, VBW=1MHz, Span=0Hz, Detector=Peak
Limit:	0.4 Second
Test setup:	 <p>The diagram illustrates the test setup. A Spectrum Analyzer is connected via a red cable to an E.U.T. (Equipment Under Test). Both are placed on a Non-Conducted Table. Below the table is a Ground Reference Plane.</p>
Test Instruments:	Refer to section 6.0 for details
Test mode:	Refer to section 5.2 for details
Test results:	Pass

### Measurement Data

Channel	Ton (ms)	Dwell time(ms)	Limit(ms)	Result
Lowest	3.883	107.17	400	Pass
Middle	3.883	107.17	400	Pass
Highest	3.867	106.73	400	Pass

The formula as below:

Lowest: Dwell time = Ton \* Ton times in 1s \* 0.4s \* channel numbers=3.883ms\*3\*0.4\*23=107.17ms

Middle: Dwell time = Ton \* Ton times in 1s \* 0.4s \* channel numbers=3.883ms\*3\*0.4\*23=107.17ms

73Highest: Dwell time = Ton \* Ton times in 1s \* 0.4s \* channel numbers=3.867ms\*3\*0.4\*23=106.73ms

Test plot as follows:

Channel	Lowest
---------	--------

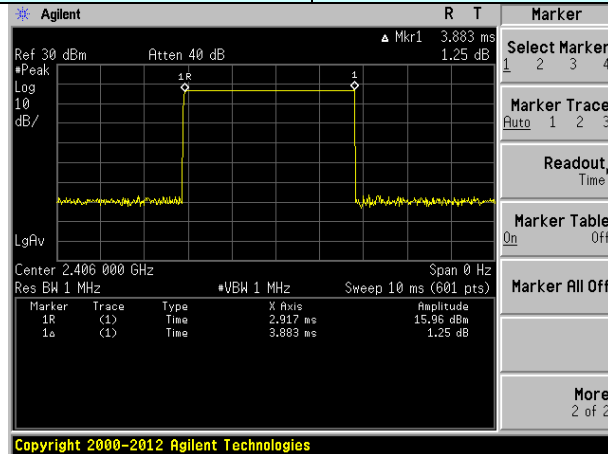

Ton

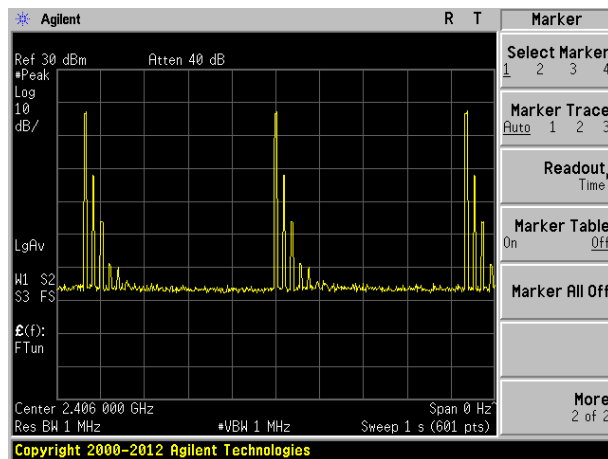

Ton times in 1s

Channel	Middle
---------	--------

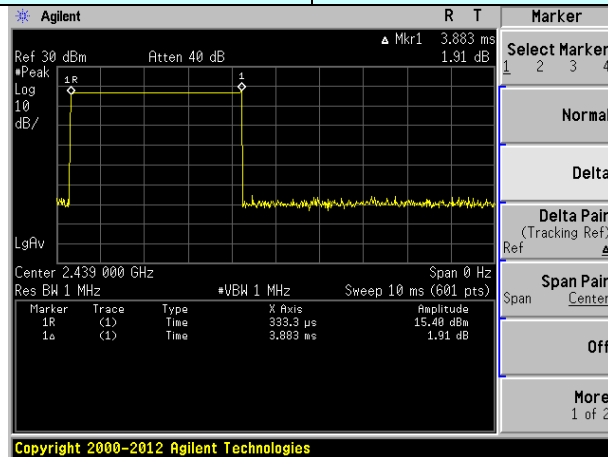

Ton

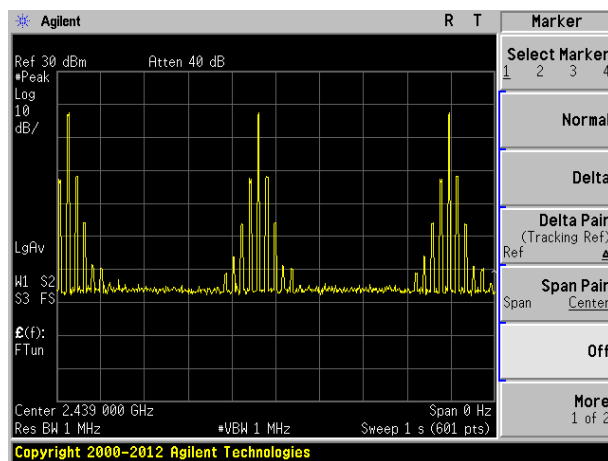

Ton times in 1s

Channel	Highest
---------	---------

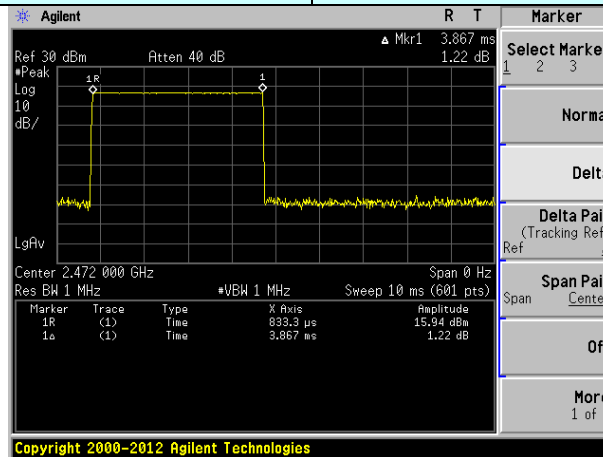

Ton

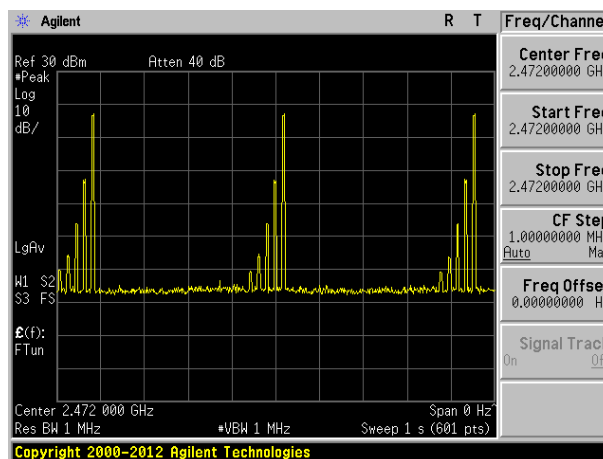

Ton times in 1s

## 7.7 Band Edge

### 7.7.1 Conducted Emission Method

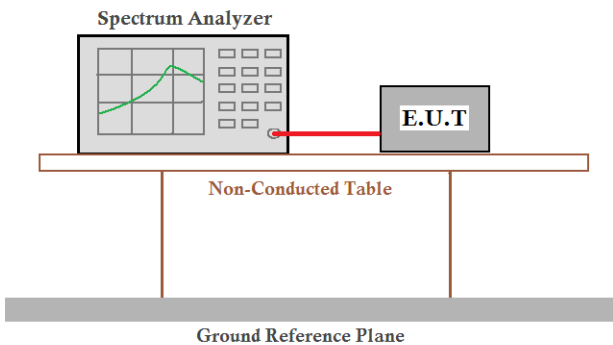
Test Requirement:	FCC Part15 C Section 15.247 (d)
Test Method:	ANSI C63.10:2013
Receiver setup:	RBW=100kHz, VBW=300kHz, Detector=Peak
Limit:	In any 100 kHz bandwidth outside the frequency band in which the spread spectrum intentional radiator is operating, the radio frequency power that is produced by the intentional radiator shall be at least 20 dB below that in the 100 kHz bandwidth within the band that contains the highest level of the desired power, based on either an RF conducted or a radiated measurement.
Test setup:	 <p>The diagram illustrates the test setup. A Spectrum Analyzer is connected to an E.U.T. (Equipment Under Test) via a red cable. Both are placed on a Non-Conducted Table, which is supported by a Ground Reference Plane.</p>
Test Instruments:	Refer to section6.0 for details
Test mode:	Refer to section 5.2 for details
Test results:	Pass

Test plot as follows:

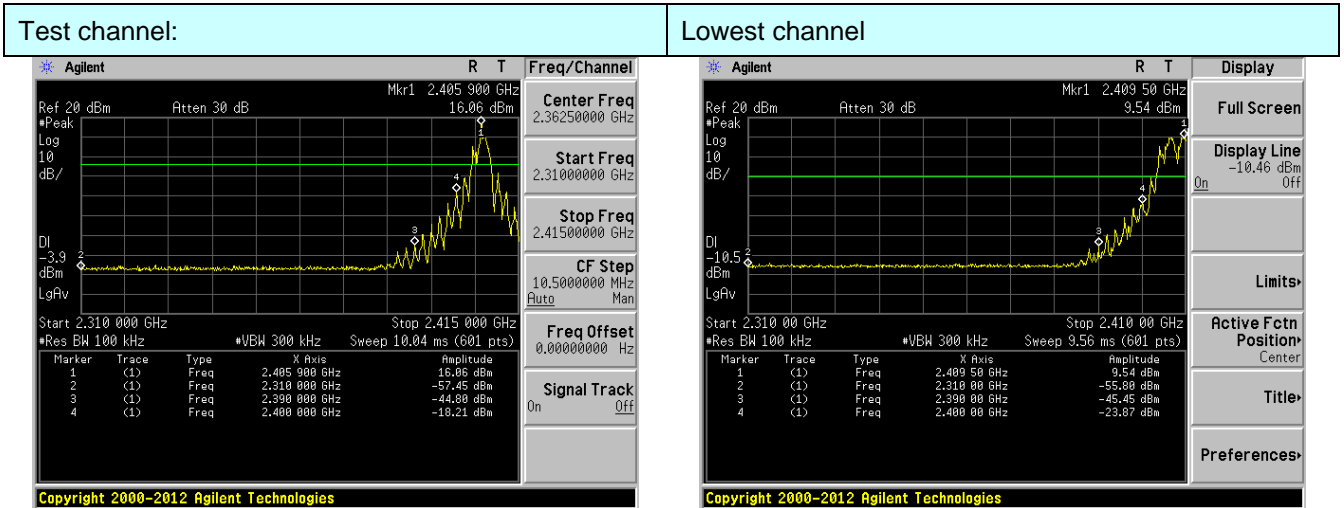

No-hopping mode

Hopping mode

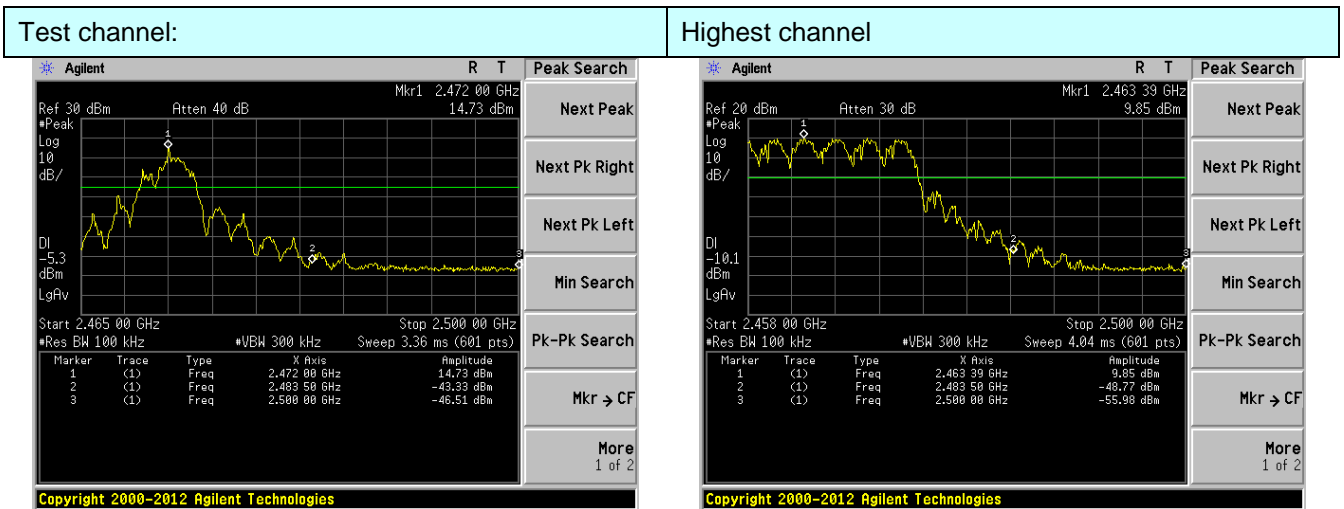

No-hopping mode

Hopping mode

## 7.7.2 Radiated Emission Method

Test Requirement:	FCC Part15 C Section 15.209 and 15.205				
Test Method:	ANSI C63.10:2013				
Test Frequency Range:	All of the restrict bands were tested, only the worst band's (2310MHz to 2500MHz) data was showed.				
Test site:	Measurement Distance: 3m				
Receiver setup:	Frequency	Detector	RBW	VBW	Remark
	Above 1GHz	Peak	1MHz	3MHz	Peak Value
		Peak	1MHz	10Hz	Average Value
Limit:	Frequency		Limit (dBuV/m @3m)		Remark
	Above 1GHz		54.00		Average Value
			74.00		Peak Value
Test setup:					
Test Procedure:	<ol style="list-style-type: none"> <li>1. The EUT was placed on the top of a rotating table 1.5 meters above the ground at a 3 meter camber. The table was rotated 360 degrees to determine the position of the highest radiation.</li> <li>2. The EUT was set 3 meters away from the interference-receiving antenna, which was mounted on the top of a variable-height antenna tower.</li> <li>3. The antenna height is varied from one meter to four meters above the ground to determine the maximum value of the field strength. Both horizontal and vertical polarizations of the antenna are set to make the measurement.</li> <li>4. For each suspected emission, the EUT was arranged to its worst case and then the antenna was tuned to heights from 1 meter to 4 meters and the rota table was turned from 0 degrees to 360 degrees to find the maximum reading.</li> <li>5. The test-receiver system was set to Peak Detect Function and Specified Bandwidth with Maximum Hold Mode.</li> <li>6. If the emission level of the EUT in peak mode was 10dB lower than the limit specified, then testing could be stopped and the peak values of the EUT would be reported. Otherwise the emissions that did not have 10dB margin would be re-tested one by one using peak, quasi-peak or average method as specified and then reported in a data sheet.</li> </ol>				
Test Instruments:	Refer to section 6.0 for details				
Test mode:	Refer to section 5.2 for details				
Temp. / Hum.	Temp.:	25 °C	Humid.:	52%	Press.: 1 012mbar
Test results:	Pass				



## Measurement Data

Remark:

1. Pre-scan all kind of the place mode (X-axis, Y-axis, Z-axis), and found the Y-axis which it is worse case.

Test channel:	Lowest	Polarization:	Vertical
---------------	--------	---------------	----------

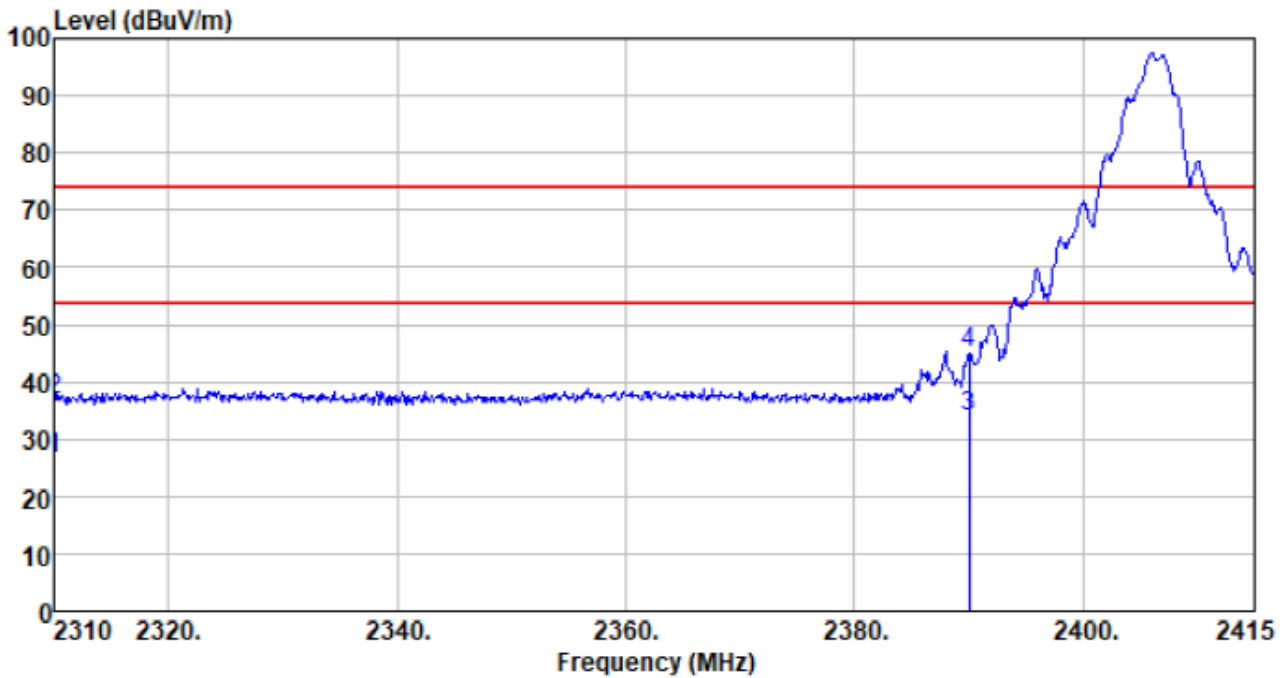

Freq MHz	Reading level dBuV	Antenna factor dB/m	Cable loss dB	Preamp factor dB	level dBuV/m	Limit level dBuV/m	Over limit dB	Remark
2310.000	33.26	27.14	2.81	36.79	26.42	54.00	-27.58	Average
2310.000	43.88	27.14	2.81	36.79	37.04	74.00	-36.96	Peak
2390.010	40.38	27.37	2.91	36.85	33.81	54.00	-20.19	Average
2390.010	51.70	27.37	2.91	36.85	45.13	74.00	-28.87	Peak

Test channel:	Lowest	Polarization:	Horizontal
---------------	--------	---------------	------------

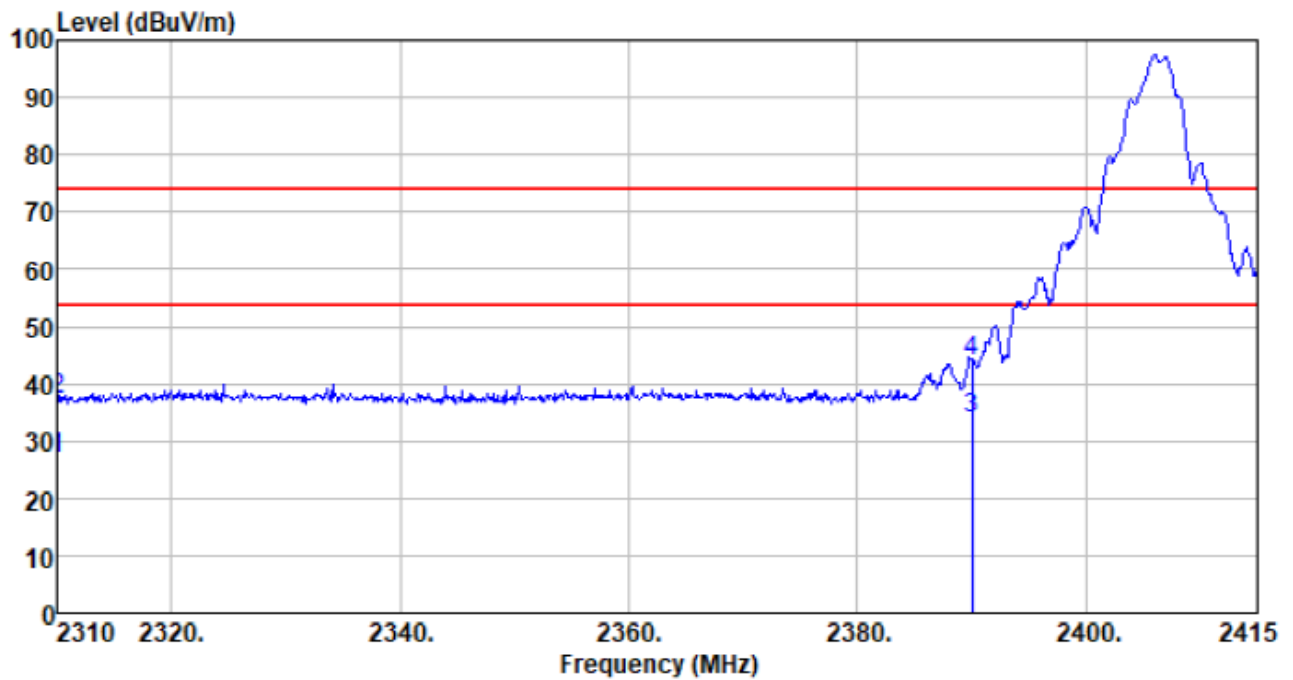

Freq MHz	Reading level dBuV	Antenna factor dB/m	Cable loss dB	Preamp factor dB	level dBuV/m	Limit level dBuV/m	Over limit dB	Remark
2310.000	33.68	27.14	2.81	36.79	26.84	54.00	-27.16	Average
2310.000	44.14	27.14	2.81	36.79	37.30	74.00	-36.70	Peak
2390.010	40.38	27.37	2.91	36.85	33.81	54.00	-20.19	Average
2390.010	50.51	27.37	2.91	36.85	43.94	74.00	-30.06	Peak

Test channel:	Highest	Polarization:	Vertical
---------------	---------	---------------	----------

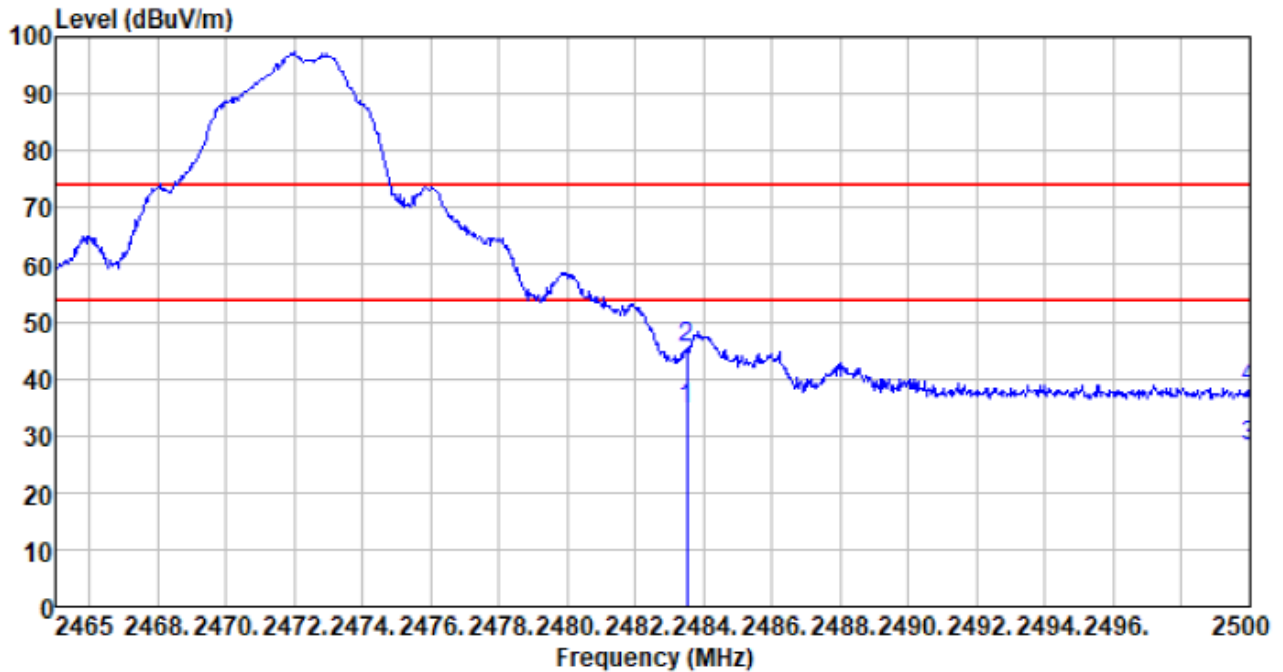

Freq MHz	Reading level dBuV	Antenna factor dB/m	Cable loss dB	Preamp factor dB	level dBuV/m	Limit level dBuV/m	Over limit dB	Remark
2483.515	40.96	27.66	2.99	36.93	34.68	54.00	-19.32	Average
2483.515	51.76	27.66	2.99	36.93	45.48	74.00	-28.52	Peak
2500.000	34.21	27.70	3.01	36.94	27.98	54.00	-26.02	Average
2500.000	44.62	27.70	3.01	36.94	38.39	74.00	-35.61	Peak

Test channel:	Highest	Polarization:	Horizontal
---------------	---------	---------------	------------

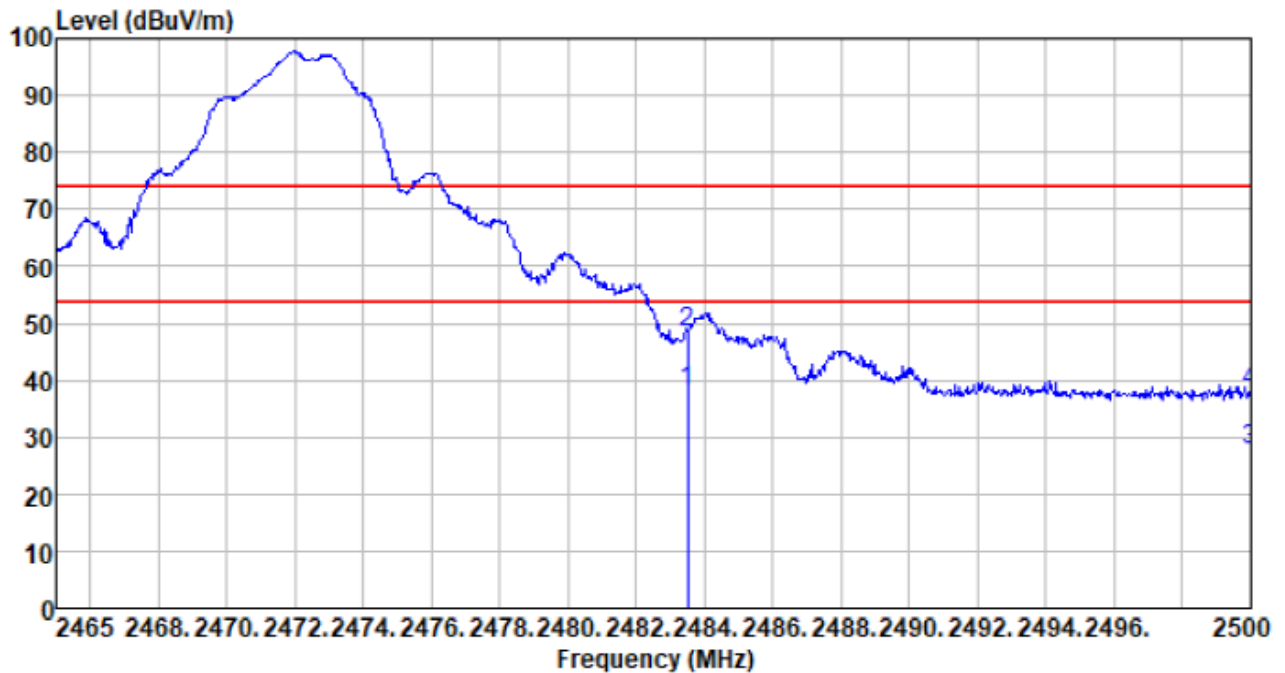

Freq MHz	Reading level dBuV	Antenna factor dB/m	Cable loss dB	Preamp factor dB	level dBuV/m	Limit level dBuV/m	Over limit dB	Remark
2483.515	44.25	27.66	2.99	36.93	37.97	54.00	-16.03	Average
2483.515	54.71	27.66	2.99	36.93	48.43	74.00	-25.57	Peak
2500.000	33.95	27.70	3.01	36.94	27.72	54.00	-26.28	Average
2500.000	44.14	27.70	3.01	36.94	37.91	74.00	-36.09	Peak

**Remark:**

1. *Final Level = Receiver Read level + Antenna Factor + Cable Loss – Pre-amplifier Factor*
2. *The emission levels of other frequencies are very lower than the limit and not show in test report.*

## 7.8 Spurious Emission

### 7.8.1 Conducted Emission Method

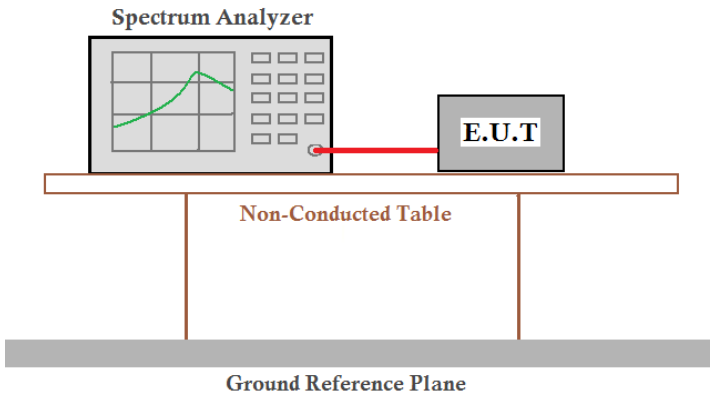
Test Requirement:	FCC Part15 C Section 15.247 (d)
Test Method:	ANSI C63.10:2013
Limit:	In any 100 kHz bandwidth outside the frequency band in which the spread spectrum intentional radiator is operating, the radio frequency power that is produced by the intentional radiator shall be at least 20 dB below that in the 100 kHz bandwidth within the band that contains the highest level of the desired power, based on either an RF conducted or a radiated measurement.
Test setup:	 <p>The diagram illustrates the test setup for conducted emission measurement. It shows a Spectrum Analyzer connected to an E.U.T. (Equipment Under Test) via a red cable. Both the Spectrum Analyzer and the E.U.T. are placed on a Non-Conducted Table, which is supported by two vertical legs. Below the table is a Ground Reference Plane.</p>
Test Instruments:	Refer to section 6.0 for details
Test mode:	Refer to section 5.2 for details
Test results:	Pass

Lowest channel

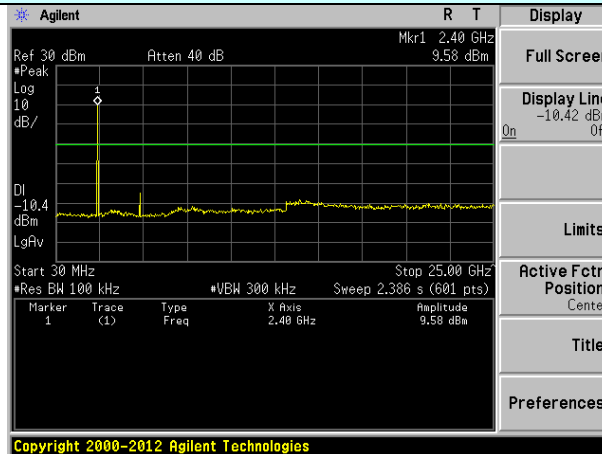

30MHz~25GHz

Middle channel

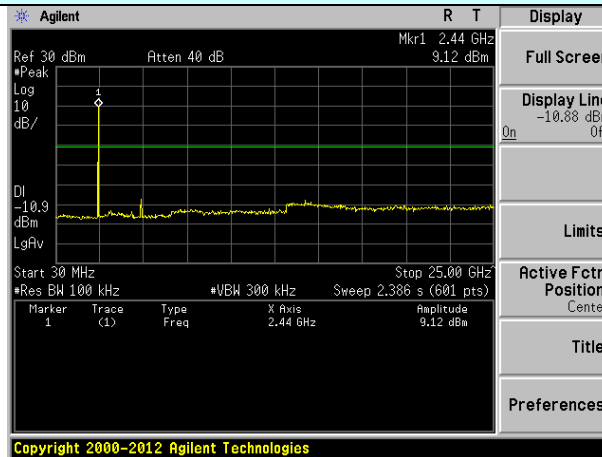

30MHz~25GHz

Highest channel

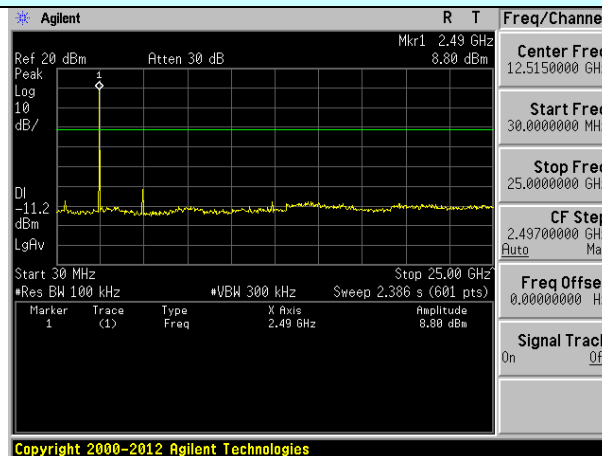

30MHz~25GHz

## 7.8.2 Radiated Emission Method

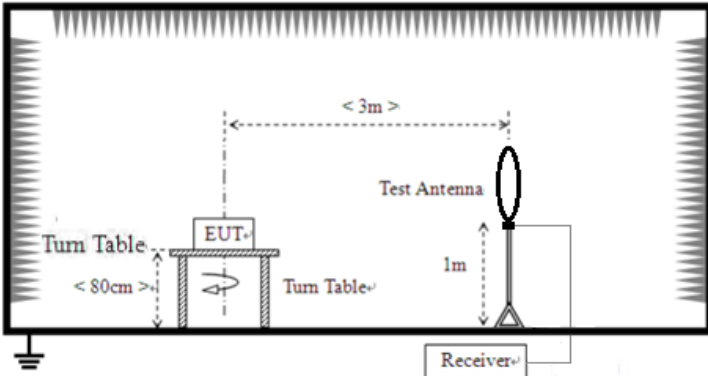
Test Requirement:	FCC Part15 C Section 15.209				
Test Method:	ANSI C63.10:2013				
Test Frequency Range:	9kHz to 25GHz				
Test site:	Measurement Distance: 3m				
Receiver setup:	Frequency	Detector	RBW	VBW	Value
	9KHz-150KHz	Quasi-peak	200Hz	600Hz	Quasi-peak
	150KHz-30MHz	Quasi-peak	9KHz	30KHz	Quasi-peak
	30MHz-1GHz	Quasi-peak	120KHz	300KHz	Quasi-peak
	Above 1GHz	Peak	1MHz	3MHz	Peak
Peak		1MHz	10Hz	Average	
Limit: (Spurious Emissions)	Frequency	Limit (uV/m)	Value	Measurement Distance	
	0.009MHz-0.490MHz	2400/F(KHz)	QP	300m	
	0.490MHz-1.705MHz	24000/F(KHz)	QP	30m	
	1.705MHz-30MHz	30	QP	30m	
	30MHz-88MHz	100	QP	3m	
	88MHz-216MHz	150	QP		
	216MHz-960MHz	200	QP		
	960MHz-1GHz	500	QP		
	Above 1GHz	500	Average		
5000		Peak			
Test setup:	Below 30MHz				
	 <p>Below 1GHz</p>				

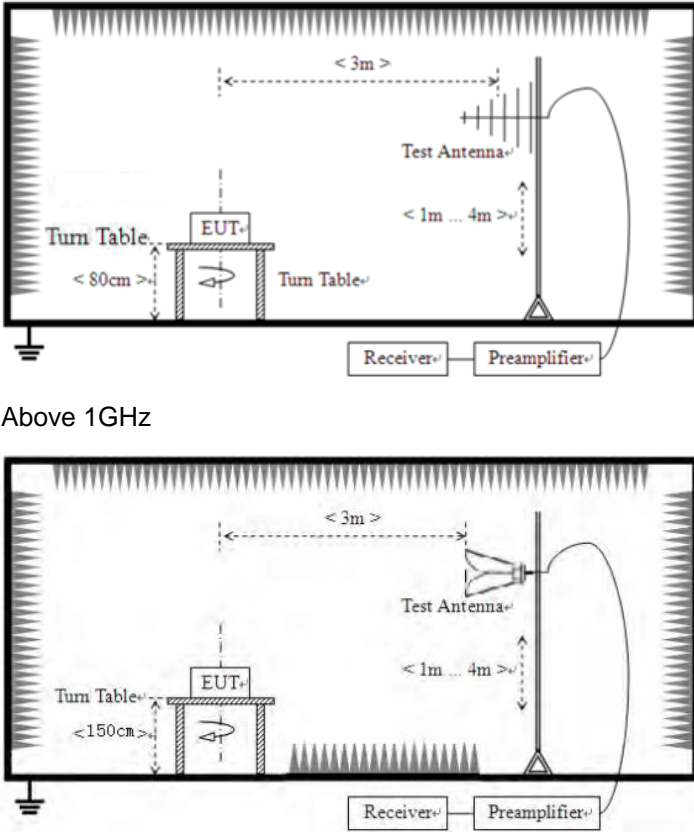
	 <p>Above 1GHz</p>						
<p>Test Procedure:</p>	<ol style="list-style-type: none"> <li>1. The EUT was placed on the top of a rotating table (0.8 meters for below 1GHz and 1.5meters for above 1GHz) above the ground at a 3 meter camber. The table was rotated 360 degrees to determine the position of the highest radiation.</li> <li>2. The EUT was set 3 meters away from the interference-receiving antenna, which was mounted on the top of a variable-height antenna tower.</li> <li>3. The antenna height is varied from one meter to four meters above the ground to determine the maximum value of the field strength. Both horizontal and vertical polarizations of the antenna are set to make the measurement.</li> <li>4. For each suspected emission, the EUT was arranged to its worst case and then the antenna was tuned to heights from 1 meter to 4 meters and the rota table was turned from 0 degrees to 360 degrees to find the maximum reading.</li> <li>5. The test-receiver system was set to Peak Detect Function and Specified Bandwidth with Maximum Hold Mode.</li> <li>6. If the emission level of the EUT in peak mode was 10dB lower than the limit specified, then testing could be stopped and the peak values of the EUT would be reported. Otherwise the emissions that did not have 10dB margin would be re-tested one by one using peak, quasi-peak or average method as specified and then reported in a data sheet.</li> </ol>						
<p>Test Instruments:</p>	<p>Refer to section 5.8 for details</p>						
<p>Test mode:</p>	<p>Refer to section 5.2 for details</p>						
<p>Temp. / Hum.</p>	<table border="1"> <tr> <td>Temp.:</td> <td>25 °C</td> <td>Humid.:</td> <td>52%</td> <td>Press.:</td> <td>1 012mbar</td> </tr> </table>	Temp.:	25 °C	Humid.:	52%	Press.:	1 012mbar
Temp.:	25 °C	Humid.:	52%	Press.:	1 012mbar		



Test results:	Pass
---------------	------

*Remark:*

1. Pre-scan all kind of the place mode (X-axis, Y-axis, Z-axis), and found the Y-axis which it is worse case.

**Measurement data:**

■ **Below 30MHz**

The low frequency, which started from 9 kHz to 30 MHz, was pre-scanned and the result which was 20 dB lower than the limit line per 15.31(o) was not reported.

■ 30MHz ~ 1GHz

Pre-scan all test modes, found worst case at 2406MHz, and so only show the test result of 2406MHz

Horizontal

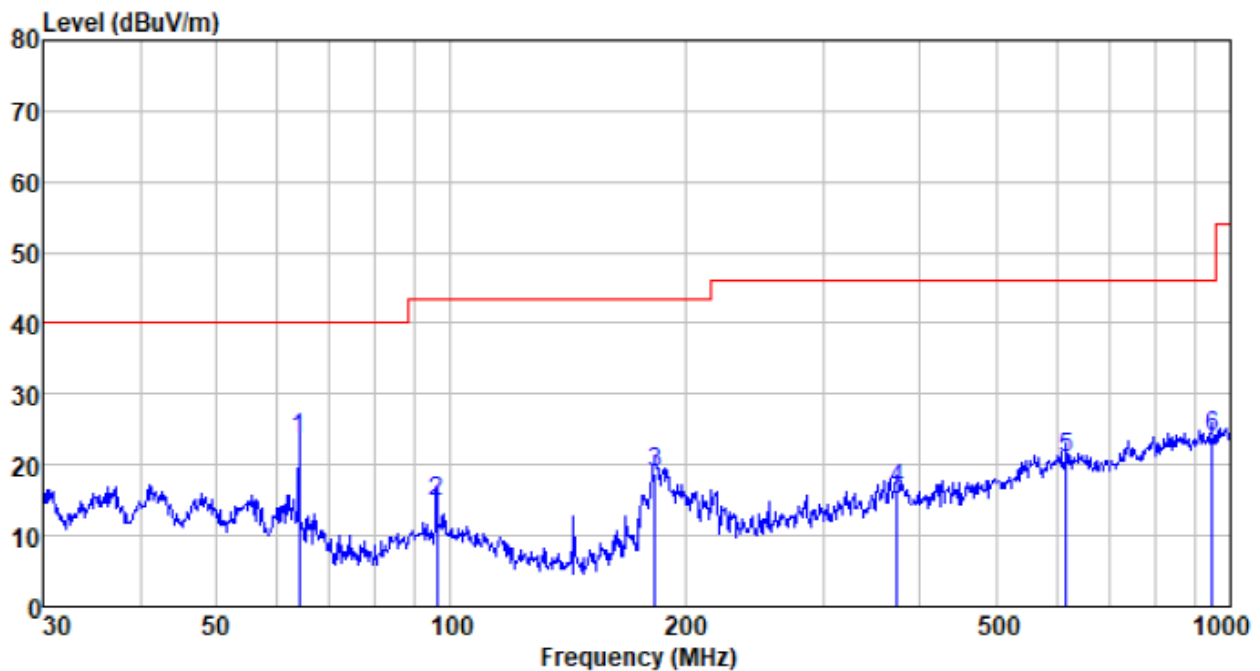

Freq MHz	Reading level dBuV	Antenna factor dB/m	Cable loss dB	Preamp factor dB	level dBuV/m	Limit level dBuV/m	Over limit dB	Remark
63.983	49.30	9.80	0.89	36.37	23.62	40.00	-16.38	QP
96.099	38.73	11.65	1.16	36.69	14.85	43.50	-28.65	QP
182.559	45.35	9.15	1.75	37.25	19.00	43.50	-24.50	QP
373.311	36.52	14.89	2.73	37.50	16.64	46.00	-29.36	QP
616.372	35.30	19.52	3.79	37.56	21.05	46.00	-24.95	QP
948.761	34.03	22.50	5.04	37.55	24.02	46.00	-21.98	QP

Vertical

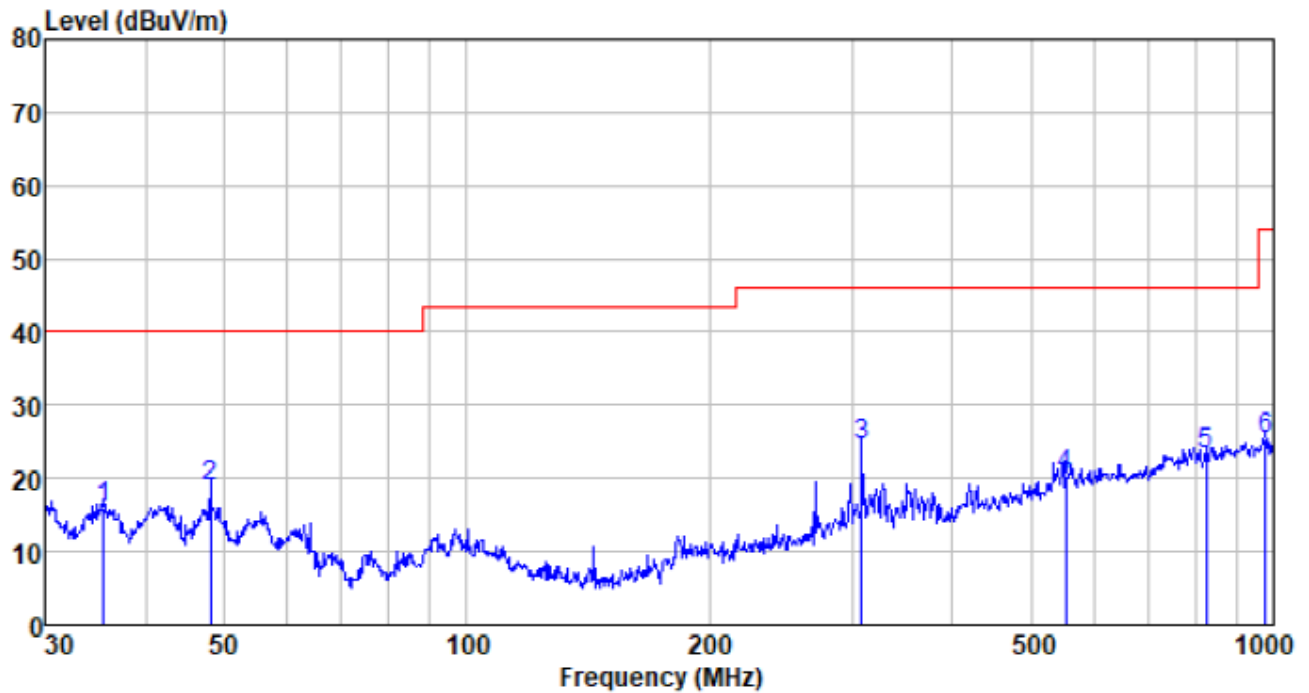

Freq MHz	Reading level dBuV	Antenna factor dB/m	Cable loss dB	Preamp factor dB	level dBuV/m	Limit level dBuV/m	Over limit dB	Remark
35.499	39.40	11.42	0.61	35.39	16.04	40.00	-23.96	QP
48.163	41.87	12.28	0.75	36.09	18.81	40.00	-21.19	QP
308.913	45.75	13.76	2.41	37.43	24.49	46.00	-21.51	QP
552.883	35.86	18.51	3.53	37.53	20.37	46.00	-25.63	QP
824.597	34.66	21.64	4.55	37.61	23.24	46.00	-22.76	QP
975.753	35.15	22.61	5.14	37.53	25.37	54.00	-28.63	QP

■ Above 1GHz

Test channel:	Lowest	Polarization:	Horizontal
---------------	--------	---------------	------------

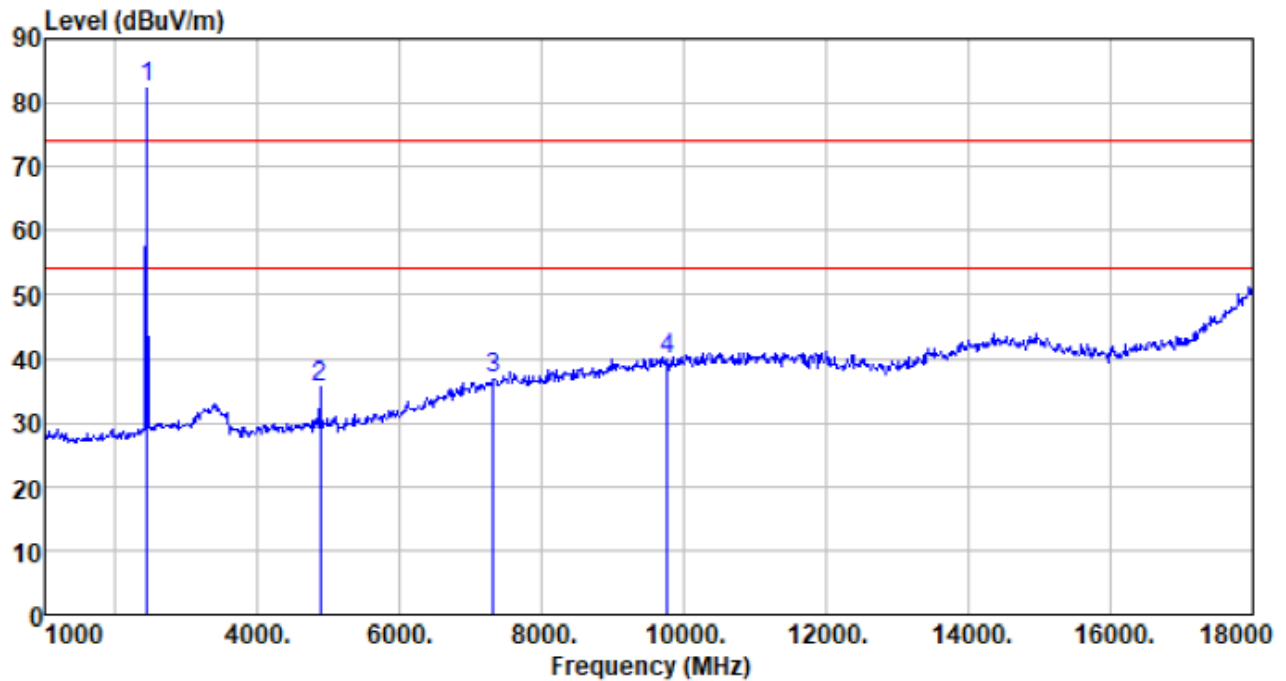

Freq MHz	Reading level dBuV	Antenna factor dB/m	Cable loss dB	Preamp factor dB	level dBuV/m	Limit level dBuV/m	Over limit dB	Remark
2439.000	88.71	27.51	2.96	36.89	82.29	74.00	8.29	Peak
4878.000	37.15	31.31	4.69	37.75	35.40	74.00	-38.60	Peak
7317.000	29.49	36.43	6.63	35.60	36.95	74.00	-37.05	Peak
9756.000	28.80	38.10	8.03	35.03	39.90	74.00	-34.10	Peak

Test channel:	Lowest	Polarization:	Vertical
---------------	--------	---------------	----------

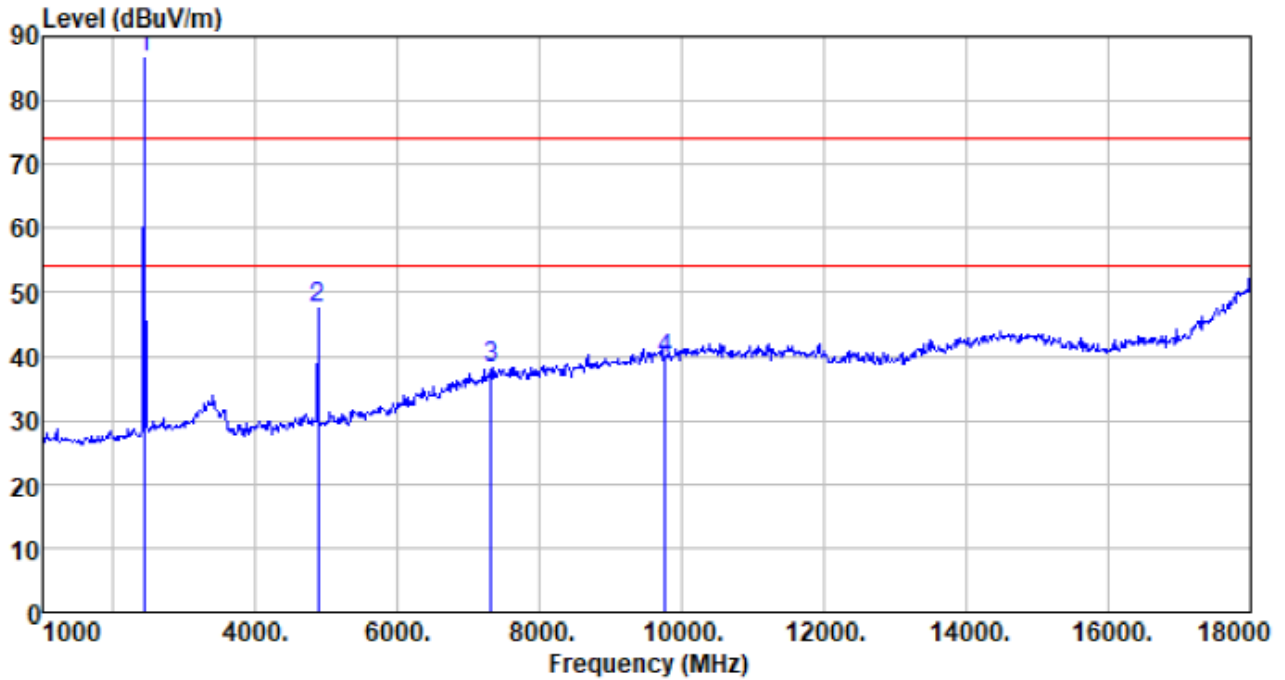

Freq MHz	Reading level dBuV	Antenna factor dB/m	Cable loss dB	Preamp factor dB	level dBuV/m	Limit level dBuV/m	Over limit dB	Remark
2439.000	93.19	27.51	2.96	36.89	86.77	74.00	12.77	Peak
4878.000	49.36	31.31	4.69	37.75	47.61	74.00	-26.39	Peak
7317.000	30.61	36.43	6.63	35.60	38.07	74.00	-35.93	Peak
9756.000	28.32	38.10	8.03	35.03	39.42	74.00	-34.58	Peak

Test channel:	Middle	Polarization:	Horizontal
---------------	--------	---------------	------------

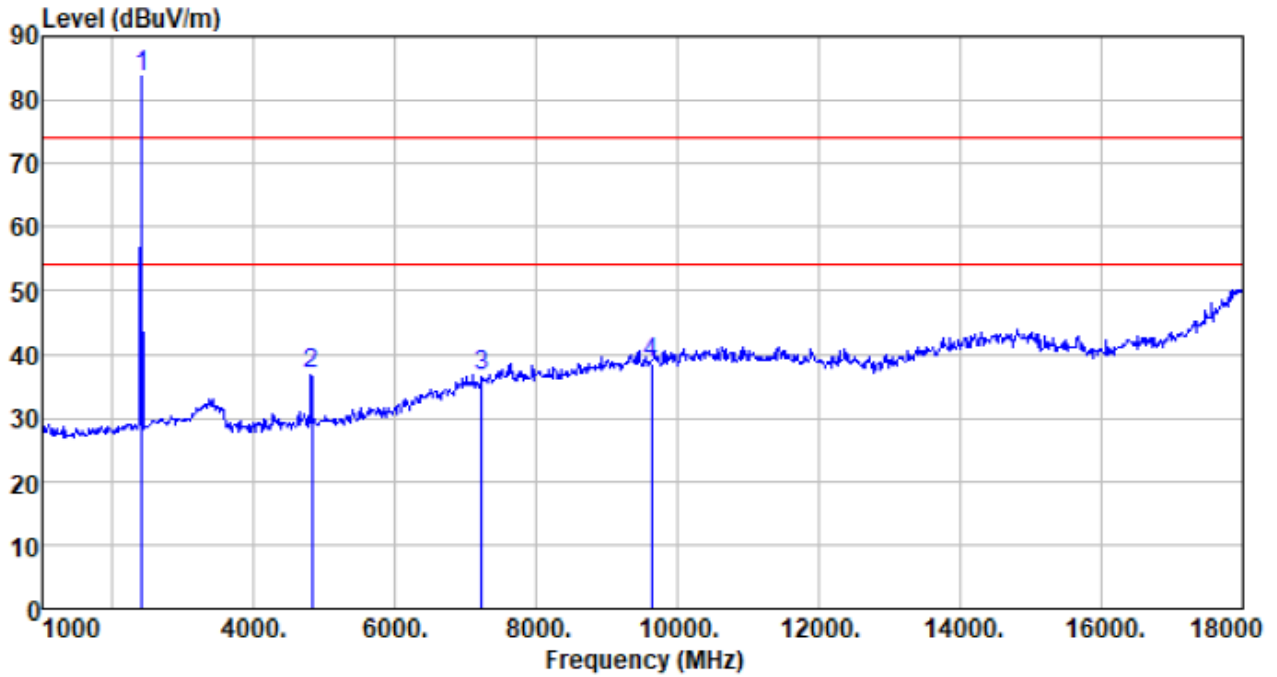

Freq MHz	Reading level dBuV	Antenna factor dB/m	Cable loss dB	Preamp factor dB	level dBuV/m	Limit level dBuV/m	Over limit dB	Remark
2406.000	90.29	27.43	2.93	36.87	83.78	74.00	9.78	Peak
4812.000	38.71	31.22	4.61	37.73	36.81	74.00	-37.19	Peak
7218.000	29.50	36.20	6.50	35.63	36.57	74.00	-37.43	Peak
9624.000	27.72	37.93	7.98	34.94	38.69	74.00	-35.31	Peak

Test channel:	Middle	Polarization:	Vertical
---------------	--------	---------------	----------

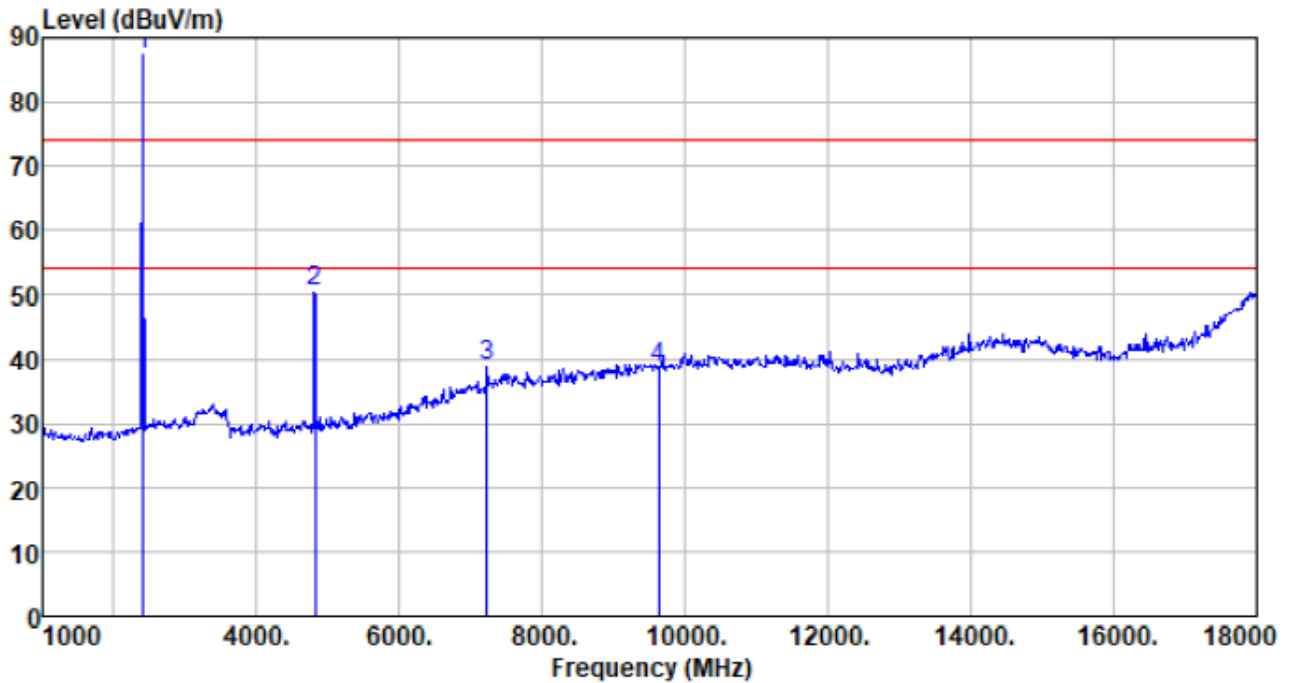

Freq MHz	Reading level dBuV	Antenna factor dB/m	Cable loss dB	Preamp factor dB	level dBuV/m	Limit level dBuV/m	Over limit dB	Remark
2406.000	93.69	27.43	2.93	36.87	87.18	74.00	13.18	Peak
4812.000	52.21	31.22	4.61	37.73	50.31	74.00	-23.69	Peak
7218.000	31.92	36.20	6.50	35.63	38.99	74.00	-35.01	Peak
9624.000	27.60	37.93	7.98	34.94	38.57	74.00	-35.43	Peak

Test channel:	Highest	Polarization:	Horizontal
---------------	---------	---------------	------------

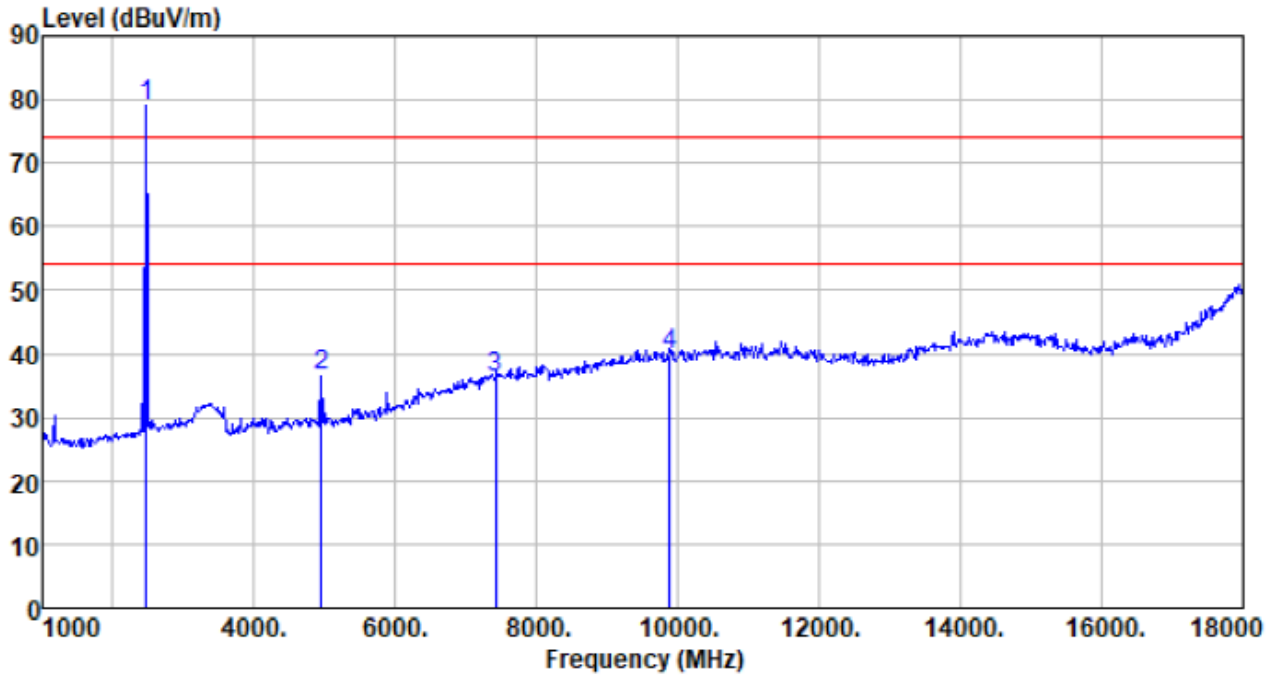

Freq MHz	Reading level dBuV	Antenna factor dB/m	Cable loss dB	Preamp factor dB	level dBuV/m	Limit level dBuV/m	Over limit dB	Remark
2472.000	85.24	27.62	2.99	36.92	78.93	74.00	4.93	Peak
4944.000	38.06	31.41	4.77	37.78	36.46	74.00	-37.54	Peak
7416.000	28.36	36.62	6.73	35.57	36.14	74.00	-37.86	Peak
9888.000	28.48	38.27	8.08	35.12	39.71	74.00	-34.29	Peak



Test channel:	Highest	Polarization:	Vertical
---------------	---------	---------------	----------

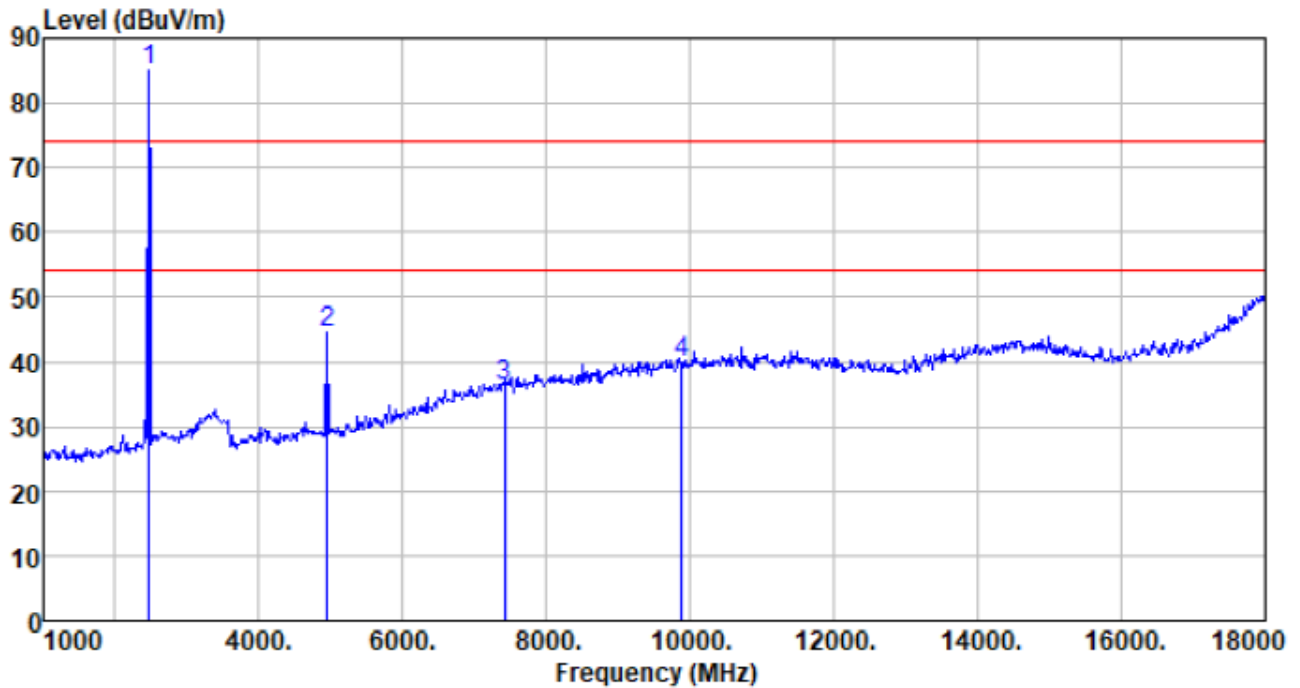

Freq MHz	Reading level dBuV	Antenna factor dB/m	Cable loss dB	Preamp factor dB	level dBuV/m	Limit level dBuV/m	Over limit dB	Remark
2472.000	91.34	27.62	2.99	36.92	85.03	74.00	11.03	Peak
4944.000	46.05	31.41	4.77	37.78	44.45	74.00	-29.55	Peak
7416.000	28.49	36.62	6.73	35.57	36.27	74.00	-37.73	Peak
9888.000	28.64	38.27	8.08	35.12	39.87	74.00	-34.13	Peak

**Remark:**

- Final Level = Receiver Read level + Antenna Factor + Cable Loss – Preamplifier Factor
- No emission found in frequency above 18GHz.

## 8 Test Setup Photo

Reference to the **appendix I** for details.

## 9 EUT Constructional Details

Reference to the **appendix II** for details.

---End---