

TEST REPORT

Applicant: FLYSKY RC MODEL TECHNOLOGY CO., LTD

Address of Applicant: West building3, Huangjianyuan Ind, Park QIAOLI North Gate
Changping Town, Dongguan, China

Manufacturer: ShenZhen FLYSKY Technology Co.,Ltd

Address of Manufacturer: 16F, Huafeng Building, No. 6006 Shennan Road, Futian
District, Shenzhen, Guangdong, China

Factory: Dongguan Flysky RC Model technology Co.,Ltd

Address of Factory: West building 3, HuangjinyuanInd Park, Qiaoli North Gate,
Changping Town, Dongguan, China

Equipment Under Test (EUT)

Product Name: Digital proportional Radio Control System

Model No.: FS-G7P, G7P

Trade Mark: FLYSKY

FCC ID: N4ZG7P00

Applicable standards: FCC CFR Title 47 Part 15 Subpart C Section 15.247

Date of sample receipt: November 24, 2021

Date of Test: November 25, 2021-December 07, 2021

Date of report issued: December 07, 2021

Test Result : PASS *

* In the configuration tested, the EUT complied with the standards specified above.

Authorized Signature:



Robinson Luo
Laboratory Manager

This results shown in this test report refer only to the sample(s) tested, this test report cannot be reproduced, except in full, without prior written permission of the company. The report would be invalid without specific stamp of test institute and the signatures of compiler and approver.

2 Version

Version No.	Date	Description
00	December 07, 2021	Original

Prepared By:

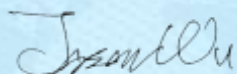

Date:

December 07, 2021

Project Engineer

Check By:

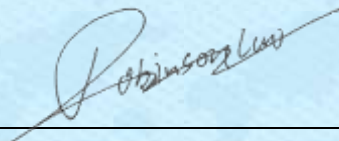

Date:

December 07, 2021

Reviewer

3 Contents

Page

1	COVER PAGE	1
2	VERSION	2
3	CONTENTS	3
4	TEST SUMMARY	4
4.1	MEASUREMENT UNCERTAINTY	4
5	GENERAL INFORMATION	5
5.1	GENERAL DESCRIPTION OF EUT	5
5.2	TEST MODE	7
5.3	TEST FACILITY.....	7
5.4	TEST LOCATION	7
5.5	DESCRIPTION OF SUPPORT UNITS	7
5.6	DEVIATION FROM STANDARDS.....	7
5.7	ABNORMALITIES FROM STANDARD CONDITIONS.....	7
5.8	ADDITIONAL INSTRUCTIONS.....	7
6	TEST INSTRUMENTS LIST	8
7	TEST RESULTS AND MEASUREMENT DATA.....	10
7.1	ANTENNA REQUIREMENT	10
7.2	CONDUCTED EMISSIONS	11
7.3	CONDUCTED PEAK OUTPUT POWER	14
7.4	20dB EMISSION BANDWIDTH	15
7.5	CARRIER FREQUENCIES SEPARATION.....	16
7.6	HOPPING CHANNEL NUMBER	17
7.7	DWELL TIME.....	18
7.8	SPURIOUS EMISSION IN NON-RESTRICTED & RESTRICTED BANDS	19
7.8.1	Conducted Emission Method.....	19
7.8.2	Radiated Emission Method.....	20
8	TEST SETUP PHOTO	39
9	EUT CONSTRUCTIONAL DETAILS	39

4 Test Summary

Test Item	Section	Result
Antenna Requirement	15.203/15.247 (c)	Pass
AC Power Line Conducted Emission	15.207	Pass
Conducted Peak Output Power	15.247 (b)(1)	Pass
20dB Occupied Bandwidth	15.247 (a)(1)	Pass
Carrier Frequencies Separation	15.247 (a)(1)	Pass
Hopping Channel Number	15.247 (a)(1)(iii)	Pass
Dwell Time	15.247 (a)(1)(iii)	Pass
Radiated Emission	15.205/15.209	Pass
Band Edge	15.247(d)	Pass

Pass: The EUT complies with the essential requirements in the standard.

Remark : Test according to ANSI C63.10:2013.

4.1 Measurement Uncertainty

Test Item	Frequency Range	Measurement Uncertainty	Notes
Radiated Emission	9kHz-30MHz	3.1dB	(1)
Radiated Emission	30MHz-200MHz	3.8039dB	(1)
Radiated Emission	200MHz-1GHz	3.9679dB	(1)
Radiated Emission	1GHz-18GHz	4.29dB	(1)
Radiated Emission	18GHz-40GHz	3.30dB	(1)
AC Power Line Conducted Emission	0.15MHz ~ 30MHz	3.44dB	(1)

Note (1): The measurement uncertainty is for coverage factor of k=2 and a level of confidence of 95%.

5 General Information

5.1 General Description of EUT

Product Name:	Digital proportional Radio Control System
Model No.:	FS-G7P, G7P
Test Model No.:	FS-G7P
Remark: All above models are identical in the same PCB layout, interior structure and electrical circuits. The only difference is model name for commercial purpose.	
Serial No.:	N/A
Hardware version:	FS-G7P-V1.5
Software version:	FS-G7P V1.0.0.13
Test sample(s) ID:	GTS202111000233-1
Sample(s) Status	Engineer sample
Operation Frequency:	2406MHz~2472MHz
Channel numbers:	133
Modulation method:	FHSS
Modulation technology:	GMSK
Antenna Type:	Integral Antenna
Antenna gain:	2.5dBi
Power supply:	DC 6V(4*1.5V Size“AA” Battery) Or Input: 5VDC

Remark: The system works in the frequency range of 2406MHz to 2472MHz. This band has been divided to 133 independent channels. Each radio system uses 20 different channels; the minimum channel separation is ≥ 3 MHz. By using various switch-on times, hopping scheme and channel frequencies, the system can guarantee a jamming free radio transmission. The channel list is below.

The test frequencies are below:

Channel	Frequency
The lowest channel	2406MHz
The middle channel	2440MHz
The Highest channel	2472MHz

Operation Frequency each of channel							
Channel	Frequency (MHz)	Channel	Frequency (MHz)	Channel	Frequency (MHz)	Channel	Frequency (MHz)
1	2406	36	2423.5	71	2441	106	2458.5
2	2406.5	37	2424	72	2441.5	107	2459
3	2407	38	2424.5	73	2442	108	2459.5
4	2407.5	39	2425	74	2442.5	109	2460
5	2408	40	2425.5	75	2443	110	2460.5
6	2408.5	41	2426	76	2443.5	111	2461
7	2409	42	2426.5	77	2444	112	2461.5
8	2409.5	43	2427	78	2444.5	113	2462
9	2410	44	2427.5	79	2445	114	2462.5
10	2410.5	45	2428	80	2445.5	115	2463
11	2411	46	2428.5	81	2446	116	2463.5
12	2411.5	47	2429	82	2446.5	117	2464
13	2412	48	2429.5	83	2447	118	2464.5
14	2412.5	49	2430	84	2447.5	119	2465
15	2413	50	2430.5	85	2448	120	2465.5
16	2413.5	51	2431	86	2448.5	121	2466
17	2414	52	2431.5	87	2449	122	2466.5
18	2414.5	53	2432	88	2449.5	123	2467
19	2415	54	2432.5	89	2450	124	2467.5
20	2415.5	55	2433	90	2450.5	125	2468
21	2416	56	2433.5	91	2451	126	2468.5
22	2416.5	57	2434	92	2451.5	127	2469
23	2417	58	2434.5	93	2452	128	2469.5
24	2417.5	59	2435	94	2452.5	129	2470
25	2418	60	2435.5	95	2453	130	2470.5
26	2418.5	61	2436	96	2453.5	131	2471
27	2419	62	2436.5	97	2454	132	2471.5
28	2419.5	63	2437	98	2454.5	133	2472
29	2420	64	2437.5	99	2455		
30	2420.5	65	2438	100	2455.5		
31	2421	66	2438.5	101	2456		
32	2421.5	67	2439	102	2456.5		
33	2422	68	2439.5	103	2457		
34	2422.5	69	2440	104	2457.5		
35	2423	70	2440.5	105	2458		

5.2 Test mode

Transmitting mode	Keep the EUT in transmitting mode.
Remark: During the test, the duty cycle >98%, the test voltage was tuned from 85% to 115% of the nominal rated supply voltage, and found that the worst case was under the nominal rated supply condition. So the report just shows that condition's data. New battery is used during all test.	

5.3 Test Facility

<p>The test facility is recognized, certified, or accredited by the following organizations:</p> <ul style="list-style-type: none"> ● FCC —Registration No.: 381383 Designation Number: CN5029 Global United Technology Services Co., Ltd., Shenzhen EMC Laboratory has been registered and fully described in a report filed with the (FCC) Federal Communications Commission. The acceptance letter from the FCC is maintained in files. ● IC —Registration No.: 9079A CAB identifier: CN0091 The 3m Semi-anechoic chamber of Global United Technology Services Co., Ltd. has been registered by Certification and Engineering Bureau of Industry Canada for radio equipment testing. ● NVLAP (LAB CODE:600179-0) Global United Technology Services Co., Ltd., is accredited by the National Voluntary Laboratory Accreditation Program (NVLAP).
--

5.4 Test Location

All other tests were performed at:
<p>Global United Technology Services Co., Ltd. Address: No. 123-128, Tower A, Jinyuan Business Building, No.2, Laodong Industrial Zone, Xixiang Road, Baoan District, Shenzhen, Guangdong, China 518102 Tel: 0755-27798480 Fax: 0755-27798960</p>

5.5 Description of Support Units

None.

5.6 Deviation from Standards

None.

5.7 Abnormalities from Standard Conditions

None.

5.8 Additional Instructions

Software (Used for test) from client
Built-in by manufacturer, power set default.

6 Test Instruments list

Radiated Emission:						
Item	Test Equipment	Manufacturer	Model No.	Inventory No.	Cal.Date (mm-dd-yy)	Cal.Due date (mm-dd-yy)
1	3m Semi- Anechoic Chamber	ZhongYu Electron	9.2(L)*6.2(W)* 6.4(H)	GTS250	July. 02 2020	July. 01 2025
2	Control Room	ZhongYu Electron	6.2(L)*2.5(W)* 2.4(H)	GTS251	N/A	N/A
3	EMI Test Receiver	Rohde & Schwarz	ESU26	GTS203	June. 24 2021	June. 23 2022
4	BiConiLog Antenna	SCHWARZBECK MESS-ELEKTRONIK	VULB9163	GTS214	June. 24 2021	June. 23 2022
5	Double -ridged waveguide horn	SCHWARZBECK MESS-ELEKTRONIK	BBHA 9120 D	GTS208	June. 24 2021	June. 23 2022
6	Horn Antenna	ETS-LINDGREN	3160	GTS217	June. 24 2021	June. 23 2022
7	EMI Test Software	AUDIX	E3	N/A	N/A	N/A
8	Coaxial Cable	GTS	N/A	GTS213	June. 24 2021	June. 23 2022
9	Coaxial Cable	GTS	N/A	GTS211	June. 24 2021	June. 23 2022
10	Coaxial cable	GTS	N/A	GTS210	June. 24 2021	June. 23 2022
11	Coaxial Cable	GTS	N/A	GTS212	June. 24 2021	June. 23 2022
12	Amplifier(100kHz-3GHz)	HP	8347A	GTS204	June. 24 2021	June. 23 2022
13	Amplifier(2GHz-20GHz)	HP	84722A	GTS206	June. 24 2021	June. 23 2022
14	Amplifier (18-26GHz)	Rohde & Schwarz	AFS33-18002 650-30-8P-44	GTS218	June. 24 2021	June. 23 2022
15	Band filter	Amindeon	82346	GTS219	June. 24 2021	June. 23 2022
16	Power Meter	Anritsu	ML2495A	GTS540	June. 24 2021	June. 23 2022
17	Power Sensor	Anritsu	MA2411B	GTS541	June. 24 2021	June. 23 2022
18	Wideband Radio Communication Tester	Rohde & Schwarz	CMW500	GTS575	June. 24 2021	June. 23 2022
19	Splitter	Agilent	11636B	GTS237	June. 24 2021	June. 23 2022
20	Loop Antenna	ZHINAN	ZN30900A	GTS534	June. 24 2021	June. 23 2022
21	Breitband hornantenne	SCHWARZBECK	BBHA 9170	GTS579	Oct. 17 2021	Oct. 16 2022
22	Amplifier	TDK	PA-02-02	GTS574	Oct. 17 2021	Oct. 16 2022
23	Amplifier	TDK	PA-02-03	GTS576	Oct. 17 2021	Oct. 16 2022
24	PSA Series Spectrum Analyzer	Rohde & Schwarz	FSP	GTS578	June. 24 2021	June. 23 2022

Conducted Emission						
Item	Test Equipment	Manufacturer	Model No.	Inventory No.	Cal.Date (mm-dd-yy)	Cal.Due date (mm-dd-yy)
1	Shielding Room	ZhongYu Electron	7.3(L)x3.1(W)x2.9(H)	GTS252	May.15 2019	May.14 2022
2	EMI Test Receiver	R&S	ESCI 7	GTS552	June. 24 2021	June. 23 2022
3	Coaxial Switch	ANRITSU CORP	MP59B	GTS225	June. 24 2021	June. 23 2022
4	ENV216 2-L-V-NETZNACHB.DE	ROHDE&SCHWARZ	ENV216	GTS226	June. 24 2021	June. 23 2022
5	Coaxial Cable	GTS	N/A	GTS227	N/A	N/A
6	EMI Test Software	AUDIX	E3	N/A	N/A	N/A
7	Thermo meter	KTJ	TA328	GTS233	June. 24 2021	June. 23 2022
8	Absorbing clamp	Elektronik-Feinmechanik	MDS21	GTS229	June. 24 2021	June. 23 2022
9	ISN	SCHWARZBECK	NTFM 8158	GTS565	June. 24 2021	June. 23 2022
10	High voltage probe	SCHWARZBECK	TK9420	GTS537	July. 09 2021	July. 08 2022

RF Conducted Test:						
Item	Test Equipment	Manufacturer	Model No.	Serial No.	Cal.Date (mm-dd-yy)	Cal.Due date (mm-dd-yy)
1	MXA Signal Analyzer	Agilent	N9020A	GTS566	June. 24 2021	June. 23 2022
2	EMI Test Receiver	R&S	ESCI 7	GTS552	June. 24 2021	June. 23 2022
3	Spectrum Analyzer	Agilent	E4440A	GTS533	June. 24 2021	June. 23 2022
4	MXG vector Signal Generator	Agilent	N5182A	GTS567	June. 24 2021	June. 23 2022
5	ESG Analog Signal Generator	Agilent	E4428C	GTS568	June. 24 2021	June. 23 2022
6	USB RF Power Sensor	DARE	RPR3006W	GTS569	June. 24 2021	June. 23 2022
7	RF Switch Box	Shongyi	RFSW3003328	GTS571	June. 24 2021	June. 23 2022
8	Programmable Constant Temp & Humi Test Chamber	WEWON	WHTH-150L-40-880	GTS572	June. 24 2021	June. 23 2022

General used equipment:						
Item	Test Equipment	Manufacturer	Model No.	Inventory No.	Cal.Date (mm-dd-yy)	Cal.Due date (mm-dd-yy)
1	Humidity/ Temperature Indicator	KTJ	TA328	GTS243	June. 24 2021	June. 23 2022
2	Barometer	ChangChun	DYM3	GTS255	June. 24 2021	June. 23 2022

7 Test results and Measurement Data

7.1 Antenna requirement

Standard requirement:	FCC Part15 C Section 15.203 /247(c)
<p>15.203 requirement:</p> <p>An intentional radiator shall be designed to ensure that no antenna other than that furnished by the responsible party shall be used with the device. The use of a permanently attached antenna or of an antenna that uses a unique coupling to the intentional radiator, the manufacturer may design the unit so that a broken antenna can be replaced by the user, but the use of a standard antenna jack or electrical connector is prohibited.</p> <p>15.247(c) (1)(i) requirement:</p> <p>(i) Systems operating in the 2400-2483.5 MHz band that is used exclusively for fixed. Point-to-point operations may employ transmitting antennas with directional gain greater than 6dBi provided the maximum conducted output power of the intentional radiator is reduced by 1 dB for every 3 dB that the directional gain of the antenna exceeds 6dBi.</p>	
EUT Antenna:	
<p><i>The antenna is integral antenna, the best case gain of the antenna is 2.5dBi, reference to the appendix II for details.</i></p>	

7.2 Conducted Emissions

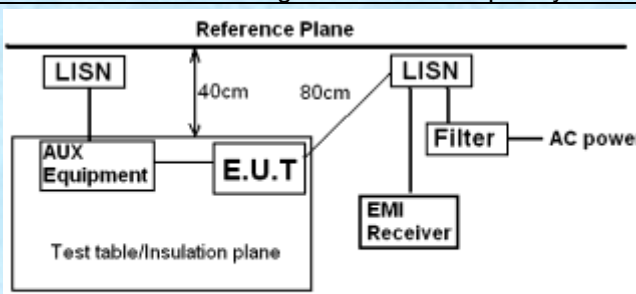
Test Requirement:	FCC Part15 C Section 15.207					
Test Method:	ANSI C63.10:2013					
Test Frequency Range:	150KHz to 30MHz					
Class / Severity:	Class B					
Receiver setup:	RBW=9KHz, VBW=30KHz, Sweep time=auto					
Limit:	Frequency range (MHz)	Limit (dBuV)				
		Quasi-peak		Average		
	0.15-0.5	66 to 56*		56 to 46*		
	0.5-5	56		46		
	5-30	60		50		
* Decreases with the logarithm of the frequency.						
Test setup:	 <p>Remark E.U.T: Equipment Under Test LISN: Line Impedance Stabilization Network Test table height=0.6m</p>					
Test procedure:	<ol style="list-style-type: none"> 1. The E.U.T and simulators are connected to the main power through a line impedance stabilization network (L.I.S.N.). This provides a 50ohm/50uH coupling impedance for the measuring equipment. 2. The peripheral devices are also connected to the main power through a LISN that provides a 50ohm/50uH coupling impedance with 50ohm termination. (Please refer to the block diagram of the test setup and photographs). 3. Both sides of A.C. line are checked for maximum conducted interference. In order to find the maximum emission, the relative positions of equipment and all of the interface cables must be changed according to ANSI C63.10:2009 on conducted measurement. 					
Test Instruments:	Refer to section 6.0 for details					
Test mode:	Refer to section 5.2 for details					
Test environment:	Temp.:	25 °C	Humid.:	52%	Press.:	1012mbar
Test voltage:	AC 120V, 60Hz					
Test results:	Pass					

Measurement data

Line:

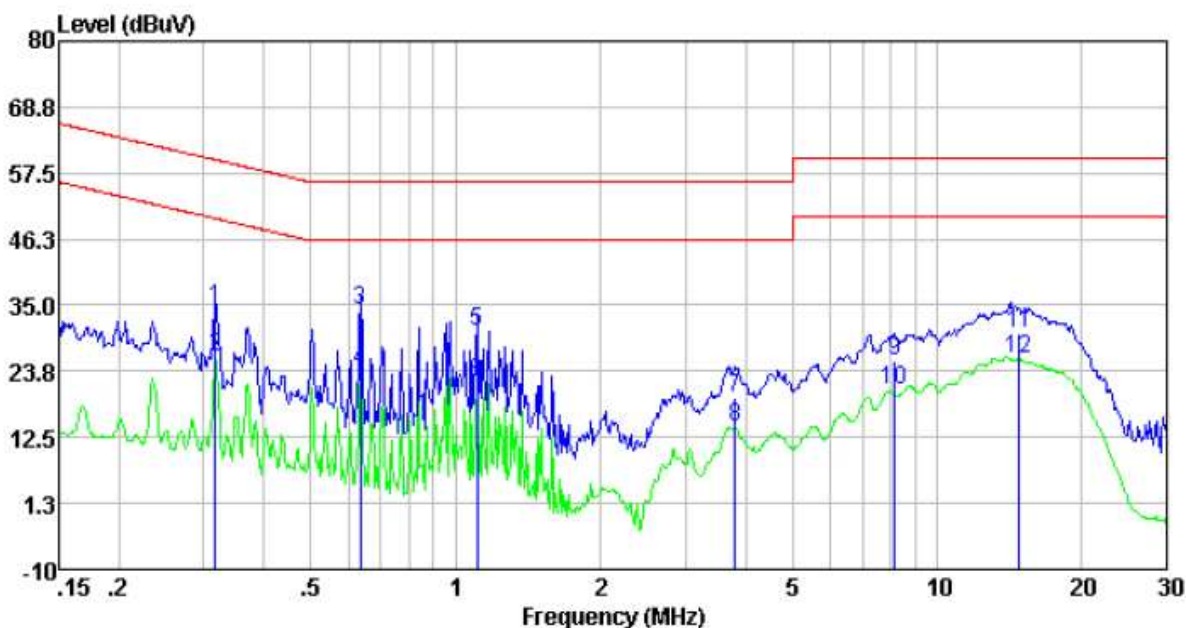

Freq	Reading level	LISN/ISN factor	Cable loss	Level	Limit level	Over limit	Remark
MHz	dBuV	dB	dB	dBuV	dBuV	dB	
0.32	24.20	10.39	0.01	34.60	59.80	-25.20	QP
0.32	15.72	10.39	0.01	26.12	49.80	-23.68	Average
0.63	23.84	10.28	0.02	34.14	56.00	-21.86	QP
0.63	13.50	10.28	0.02	23.80	46.00	-22.20	Average
1.11	20.17	10.20	0.03	30.40	56.00	-25.60	QP
1.11	11.75	10.20	0.03	21.98	46.00	-24.02	Average
3.80	8.80	10.20	0.06	19.06	56.00	-36.94	QP
3.80	4.08	10.20	0.06	14.34	46.00	-31.66	Average
8.15	15.25	10.20	0.10	25.55	60.00	-34.45	QP
8.15	10.24	10.20	0.10	20.54	50.00	-29.46	Average
14.83	19.96	10.20	0.16	30.32	60.00	-29.68	QP
14.83	15.45	10.20	0.16	25.81	50.00	-24.19	Average

Neutral:

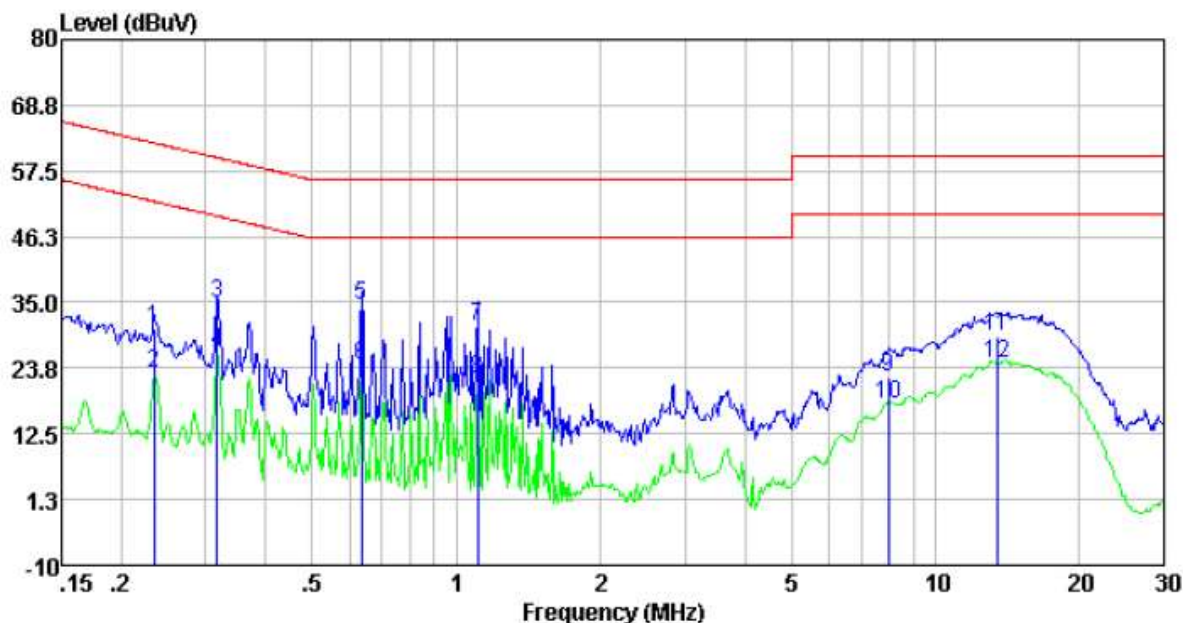

Freq	Reading level	LISN/ISN factor	Cable loss	Level	Limit level	Over limit	Remark
MHz	dBuV	dB	dB	dBuV	dBuV	dB	
0.23	20.04	10.40	0.01	30.45	62.30	-31.85	QP
0.23	12.36	10.40	0.01	22.77	52.30	-29.53	Average
0.32	24.36	10.39	0.01	34.76	59.80	-25.04	QP
0.32	15.99	10.39	0.01	26.39	49.80	-23.41	Average
0.63	24.26	10.28	0.02	34.56	56.00	-21.44	QP
0.63	13.99	10.28	0.02	24.29	46.00	-21.71	Average
1.11	20.55	10.20	0.03	30.78	56.00	-25.22	QP
1.11	11.76	10.20	0.03	21.99	46.00	-24.01	Average
7.98	11.79	10.20	0.09	22.08	60.00	-37.92	QP
7.98	7.29	10.20	0.09	17.58	50.00	-32.42	Average
13.41	18.82	10.20	0.15	29.17	60.00	-30.83	QP
13.41	14.22	10.20	0.15	24.57	50.00	-25.43	Average

Notes:

1. An initial pre-scan was performed on the line and neutral lines with peak detector.
2. Quasi-Peak and Average measurement were performed at the frequencies with maximized peak emission.
3. Final Level = Receiver Read level + LISN Factor + Cable Loss
4. If the average limit is met when using a quasi-peak detector receiver, the EUT shall be deemed to meet both limits and measurement with the average detector receiver is unnecessary.

7.3 Conducted Peak Output Power

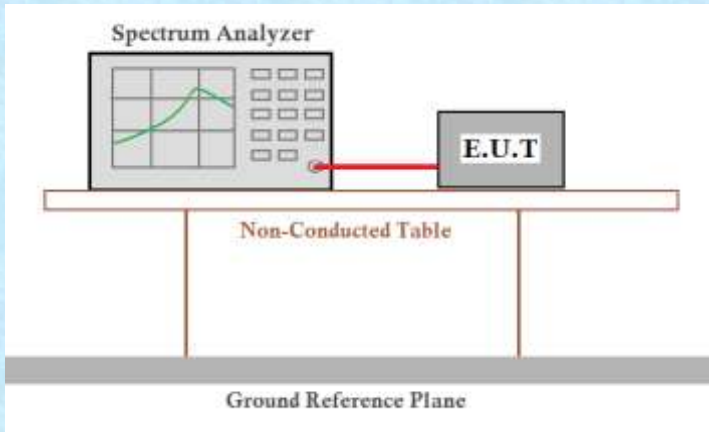
Test Requirement:	FCC Part15 C Section 15.247(a)(1)
Test Method:	ANSI C63.10:2013
Limit:	20.97dBm
Test setup:	 <p>The diagram illustrates the test setup. A Spectrum Analyzer is connected to an E.U.T. (Equipment Under Test) via a red cable. Both are placed on a Non-Conducted Table, which sits on a Ground Reference Plane.</p>
Test Instruments:	Refer to section 6.0 for details
Test mode:	Refer to section 5.2 for details
Test results:	Pass

Measurement Data: The detailed test data see Appendix for 2.4G.

7.4 20dB Emission Bandwidth

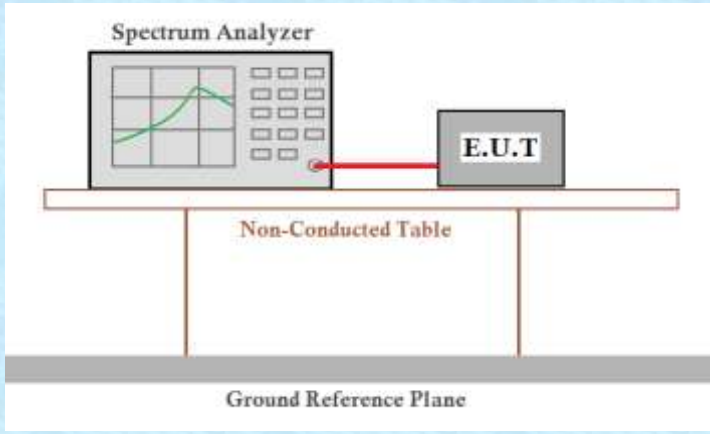
Test Requirement:	FCC Part15 C Section 15.247 (a)(1)
Test Method:	ANSI C63.10:2013
Limit:	N/A
Test setup:	 <p>The diagram illustrates the test setup. A Spectrum Analyzer is connected to an E.U.T. (Equipment Under Test) via a red cable. Both are placed on a Non-Conducted Table, which is supported by a Ground Reference Plane.</p>
Test Instruments:	Refer to section 6.0 for details
Test mode:	Refer to section 5.2 for details
Test results:	Pass

Measurement Data: The detailed test data see Appendix for 2.4G.

7.5 Carrier Frequencies Separation

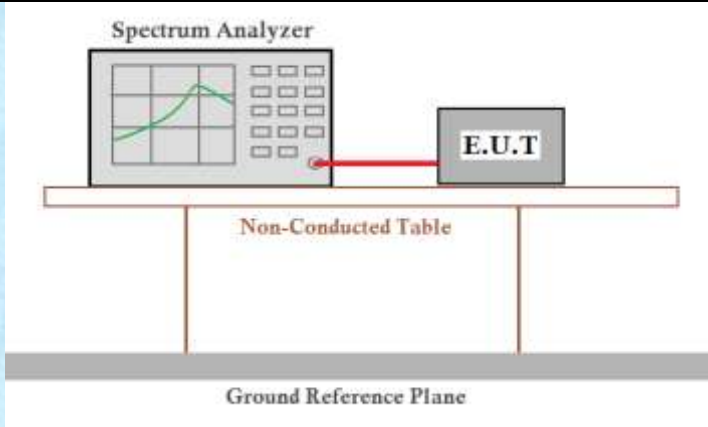
Test Requirement:	FCC Part15 C Section 15.247 (a)(1)
Test Method:	ANSI C63.10:2013
Receiver setup:	RBW=100KHz, VBW=300KHz, detector=Peak
Limit:	0.025MHz or 2/3 of the 20dB bandwidth (whichever is greater)
Test setup:	 <p>The diagram illustrates the test setup. A Spectrum Analyzer is connected to an E.U.T. (Equipment Under Test) via a red cable. Both are placed on a Non-Conducted Table, which is supported by a Ground Reference Plane.</p>
Test Instruments:	Refer to section 6.0 for details
Test mode:	Refer to section 5.2 for details
Test results:	Pass

Measurement Data: The detailed test data see Appendix for 2.4G.

7.6 Hopping Channel Number

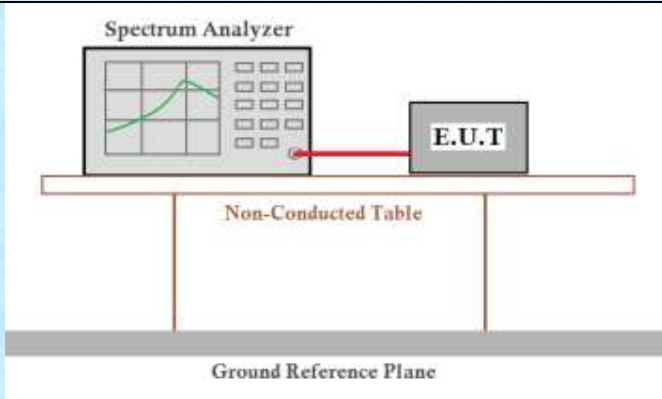
Test Requirement:	FCC Part15 C Section 15.247 (a)(1)(iii)
Test Method:	ANSI C63.10:2013
Receiver setup:	RBW=100kHz, VBW=300kHz, Frequency range=2400MHz-2483.5MHz, Detector=Peak
Limit:	15 channels
Test setup:	 <p>The diagram illustrates the test setup. A Spectrum Analyzer is connected to an E.U.T. (Equipment Under Test) via a red cable. Both are placed on a Non-Conducted Table, which sits on a Ground Reference Plane.</p>
Test Instruments:	Refer to section 6.0 for details
Test mode:	Refer to section 5.2 for details
Test results:	Pass

Measurement Data: The detailed test data see Appendix for 2.4G.

7.7 Dwell Time

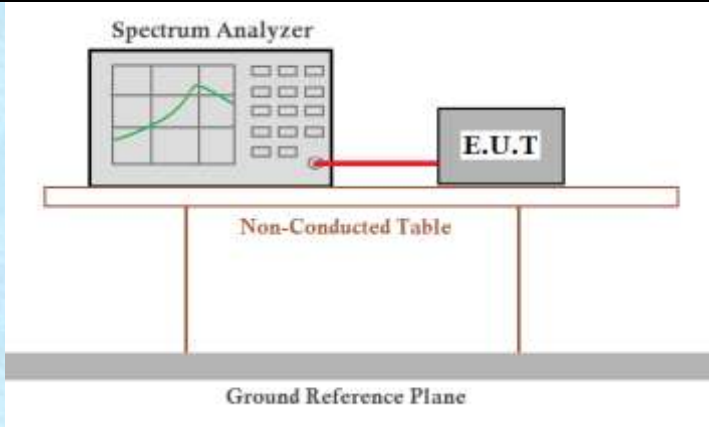
Test Requirement:	FCC Part15 C Section 15.247 (a)(1)(iii)
Test Method:	ANSI C63.10:2013
Receiver setup:	RBW=1MHz, VBW=1MHz, Span=0Hz, Detector=Peak
Limit:	0.4 Second
Test setup:	 <p>The diagram illustrates the test setup. A Spectrum Analyzer is connected to an E.U.T. (Equipment Under Test) via a red cable. Both are placed on a Non-Conducted Table, which is supported by a Ground Reference Plane.</p>
Test Instruments:	Refer to section 6.0 for details
Test mode:	Refer to section 5.2 for details
Test results:	Pass

Measurement Data: The detailed test data see Appendix for 2.4G.

7.8 Spurious Emission in Non-restricted & restricted Bands

7.8.1 Conducted Emission Method

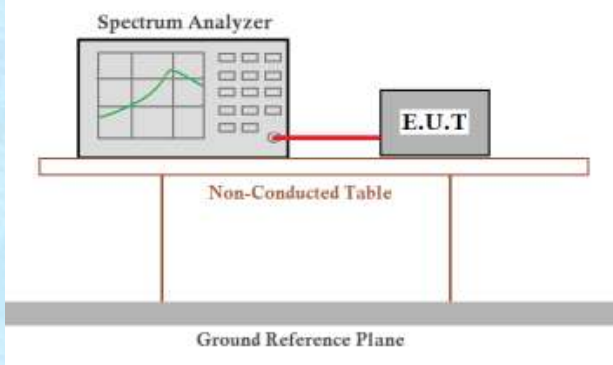
Test Requirement:	FCC Part15 C Section 15.247 (d)
Test Method:	ANSI C63.10:2013
Receiver setup:	RBW=100kHz, VBW=300kHz, Detector=Peak
Limit:	In any 100 kHz bandwidth outside the frequency band in which the spread spectrum intentional radiator is operating, the radio frequency power that is produced by the intentional radiator shall be at least 20 dB below that in the 100 kHz bandwidth within the band that contains the highest level of the desired power, based on either an RF conducted or a radiated measurement.
Test setup:	
Test Instruments:	Refer to section 6.0 for details
Test mode:	Refer to section 5.2 for details
Test results:	Pass

Measurement Data: The detailed test data see Appendix for 2.4G.

7.8.2 Radiated Emission Method

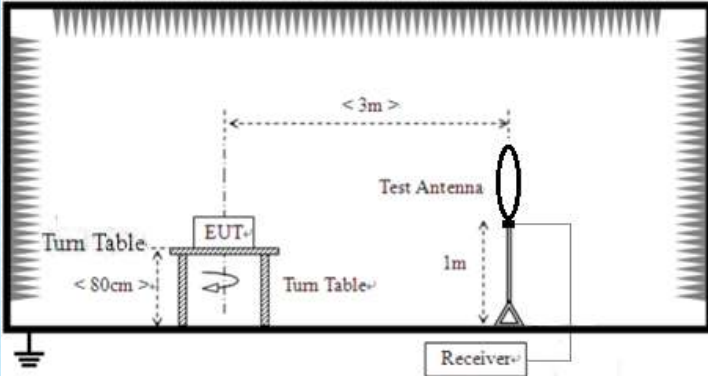
Test Requirement:	FCC Part15 C Section 15.209 and 15.205				
Test Method:	ANSI C63.10:2013				
Test Frequency Range:	9kHz to 25GHz				
Test site:	Measurement Distance: 3m				
Receiver setup:	Frequency	Detector	RBW	VBW	Value
	9KHz-150KHz	Quasi-peak	200Hz	600Hz	Quasi-peak
	150KHz-30MHz	Quasi-peak	9KHz	30KHz	Quasi-peak
	30MHz-1GHz	Quasi-peak	120KHz	300KHz	Quasi-peak
	Above 1GHz	Peak	1MHz	3MHz	Peak
Peak		1MHz	10Hz	Average	
Limit: (Spurious Emissions)	Frequency	Limit (uV/m)	Value	Measurement Distance	
	0.009MHz-0.490MHz	2400/F(KHz)	QP	300m	
	0.490MHz-1.705MHz	24000/F(KHz)	QP	30m	
	1.705MHz-30MHz	30	QP	30m	
	30MHz-88MHz	100	QP	3m	
	88MHz-216MHz	150	QP		
	216MHz-960MHz	200	QP		
	960MHz-1GHz	500	QP		
	Above 1GHz	500	Average		
5000		Peak			
Test setup:	Below 30MHz				
					
Below 1GHz					

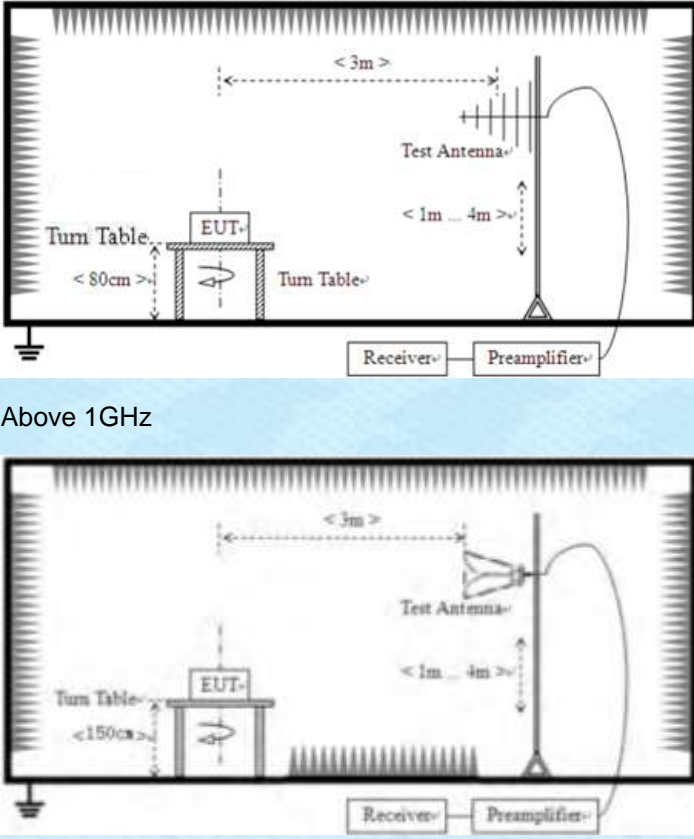
	 <p>Above 1GHz</p>						
<p>Test Procedure:</p>	<ol style="list-style-type: none"> 1. The EUT was placed on the top of a rotating table (0.8 meters for below 1GHz and 1.5 meters for above 1GHz) above the ground at a 3 meter camber. The table was rotated 360 degrees to determine the position of the highest radiation. 2. The EUT was set 3 meters away from the interference-receiving antenna, which was mounted on the top of a variable-height antenna tower. 3. The antenna height is varied from one meter to four meters above the ground to determine the maximum value of the field strength. Both horizontal and vertical polarizations of the antenna are set to make the measurement. 4. For each suspected emission, the EUT was arranged to its worst case and then the antenna was tuned to heights from 1 meter to 4 meters and the rota table was turned from 0 degrees to 360 degrees to find the maximum reading. 5. The test-receiver system was set to Peak Detect Function and Specified Bandwidth with Maximum Hold Mode. 6. If the emission level of the EUT in peak mode was 10dB lower than the limit specified, then testing could be stopped and the peak values of the EUT would be reported. Otherwise the emissions that did not have 10dB margin would be re-tested one by one using peak, quasi-peak or average method as specified and then reported in a data sheet. 						
<p>Test Instruments:</p>	<p>Refer to section 5.8 for details</p>						
<p>Test mode:</p>	<p>Refer to section 5.2 for details</p>						
<p>Temp. / Hum.</p>	<table border="1"> <tr> <td>Temp.:</td> <td>25 °C</td> <td>Humid.:</td> <td>52%</td> <td>Press.:</td> <td>1 012mbar</td> </tr> </table>	Temp.:	25 °C	Humid.:	52%	Press.:	1 012mbar
Temp.:	25 °C	Humid.:	52%	Press.:	1 012mbar		

Test results:	Pass
Test voltage:	AC 120V, 60Hz

Remark:

1. *Pre-scan all kind of the place mode (X-axis, Y-axis, Z-axis), and found the Y-axis which it is worse case.*

Measurement data:

■ **Below 30MHz**

The low frequency, which started from 9 kHz to 30 MHz, was pre-scanned and the result which was 20 dB lower than the limit line per 15.31(o) was not reported.

■ 30MHz ~ 1GHz

Test channel:	Lowest	Polarization:	Horizontal
---------------	--------	---------------	------------

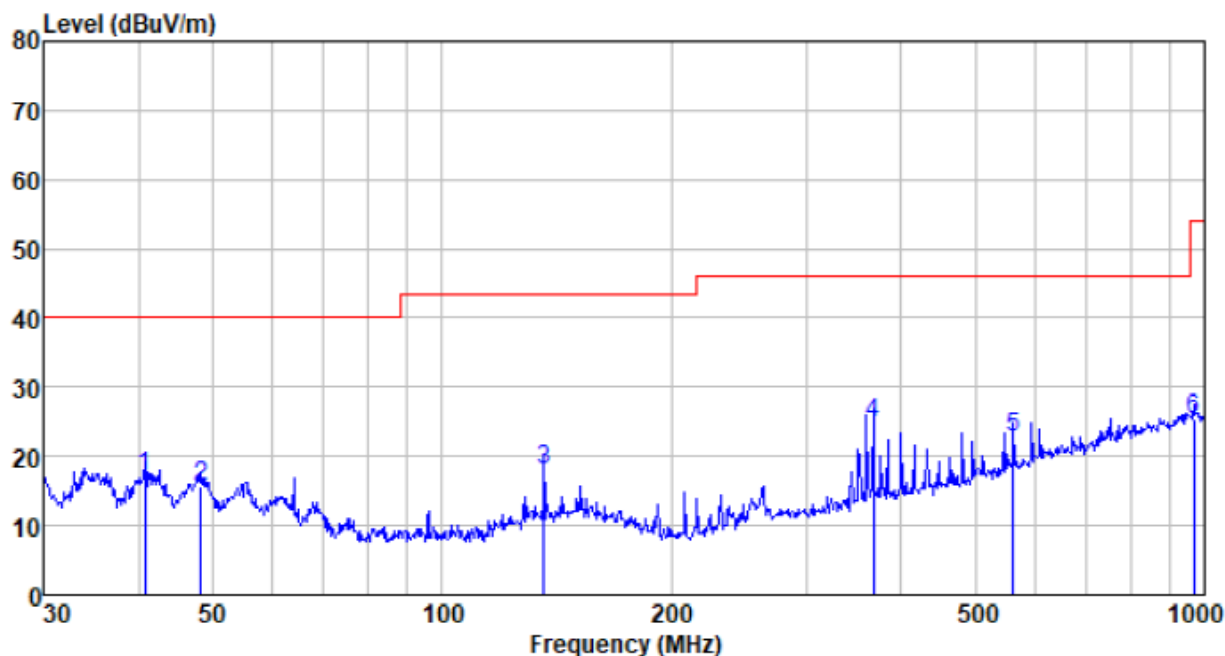

Freq MHz	Reading level dBUV	Antenna factor dB/m	Cable loss dB	Preamp factor dB	level dBUV/m	Limit level dBUV/m	Over limit dB	Remark
40.702	38.90	13.22	0.67	35.70	17.09	40.00	-22.91	QP
48.332	37.97	13.01	0.75	36.10	15.63	40.00	-24.37	QP
135.982	41.76	11.86	1.48	36.99	18.11	43.50	-25.39	QP
368.112	45.67	14.01	2.71	37.49	24.90	46.00	-21.10	QP
560.693	38.45	18.22	3.56	37.53	22.70	46.00	-23.30	QP
968.934	33.88	23.99	5.11	37.54	25.44	54.00	-28.56	QP

Test channel:	Lowest	Polarization:	Vertical
---------------	--------	---------------	----------

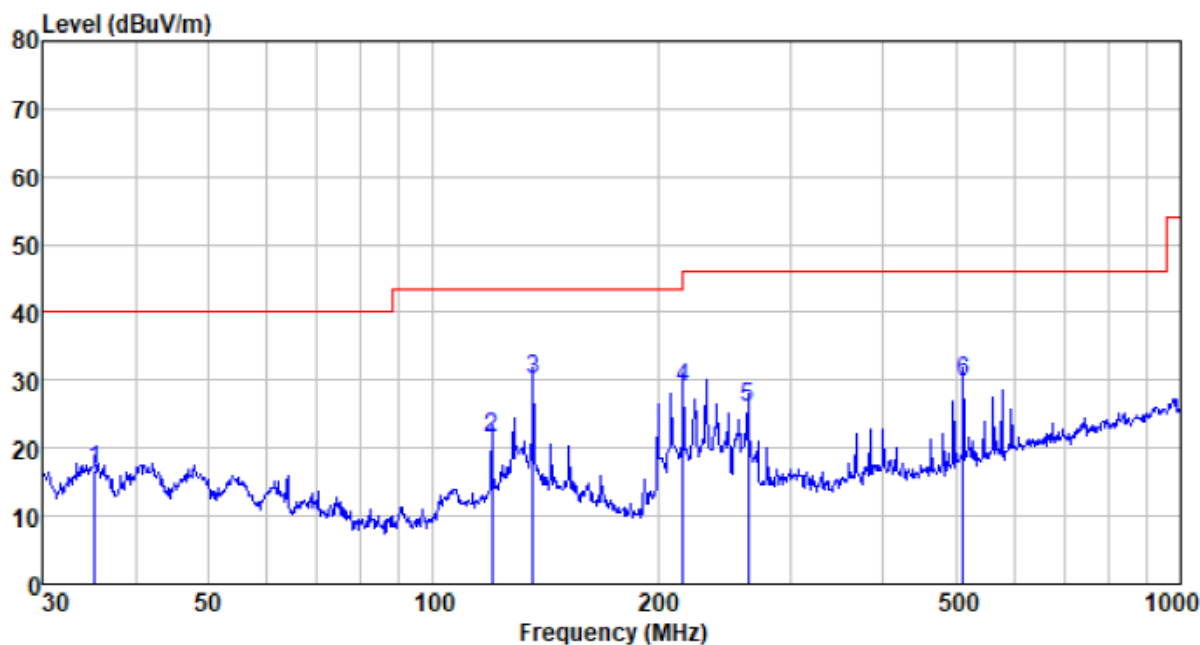

Freq MHz	Reading level dBuV	Antenna factor dB/m	Cable loss dB	Preamp factor dB	level dBuV/m	Limit level dBuV/m	Over limit dB	Remark
35.251	39.09	12.54	0.61	35.37	16.87	40.00	-23.13	QP
119.856	45.97	10.98	1.36	36.88	21.43	43.50	-22.07	QP
135.982	53.63	11.86	1.48	36.99	29.98	43.50	-13.52	QP
216.024	55.46	9.01	1.93	37.35	29.05	46.00	-16.95	QP
263.819	49.95	11.26	2.19	37.39	26.01	46.00	-19.99	QP
511.835	47.15	16.90	3.36	37.51	29.90	46.00	-16.10	QP

Test channel:	Middle	Polarization:	Horizontal
---------------	--------	---------------	------------

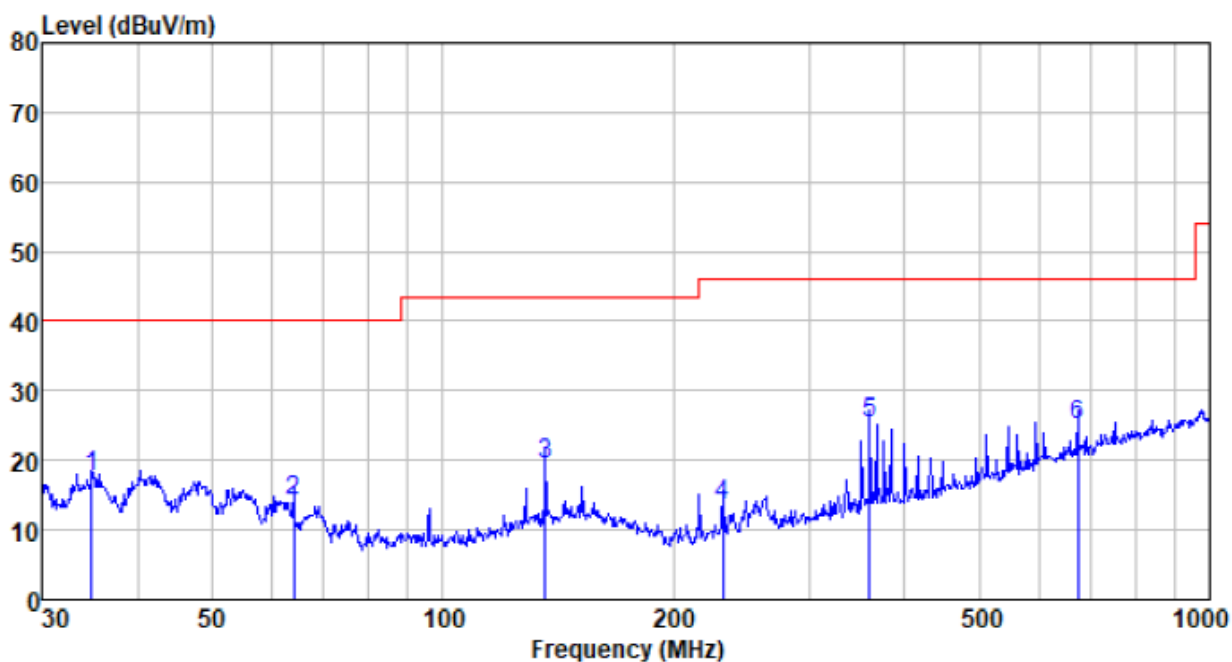

Freq MHz	Reading level dBuV	Antenna factor dB/m	Cable loss dB	Preamp factor dB	level dBuV/m	Limit level dBuV/m	Over limit dB	Remark
34.882	39.85	12.49	0.61	35.35	17.60	40.00	-22.40	QP
63.983	38.09	11.63	0.89	36.37	14.24	40.00	-25.76	QP
135.982	43.08	11.86	1.48	36.99	19.43	43.50	-24.07	QP
231.718	39.34	9.59	2.02	37.36	13.59	46.00	-32.41	QP
360.448	46.27	13.82	2.67	37.48	25.28	46.00	-20.72	QP
672.845	38.73	20.09	3.99	37.61	25.20	46.00	-20.80	QP

Test channel:	Middle	Polarization:	Vertical
---------------	--------	---------------	----------

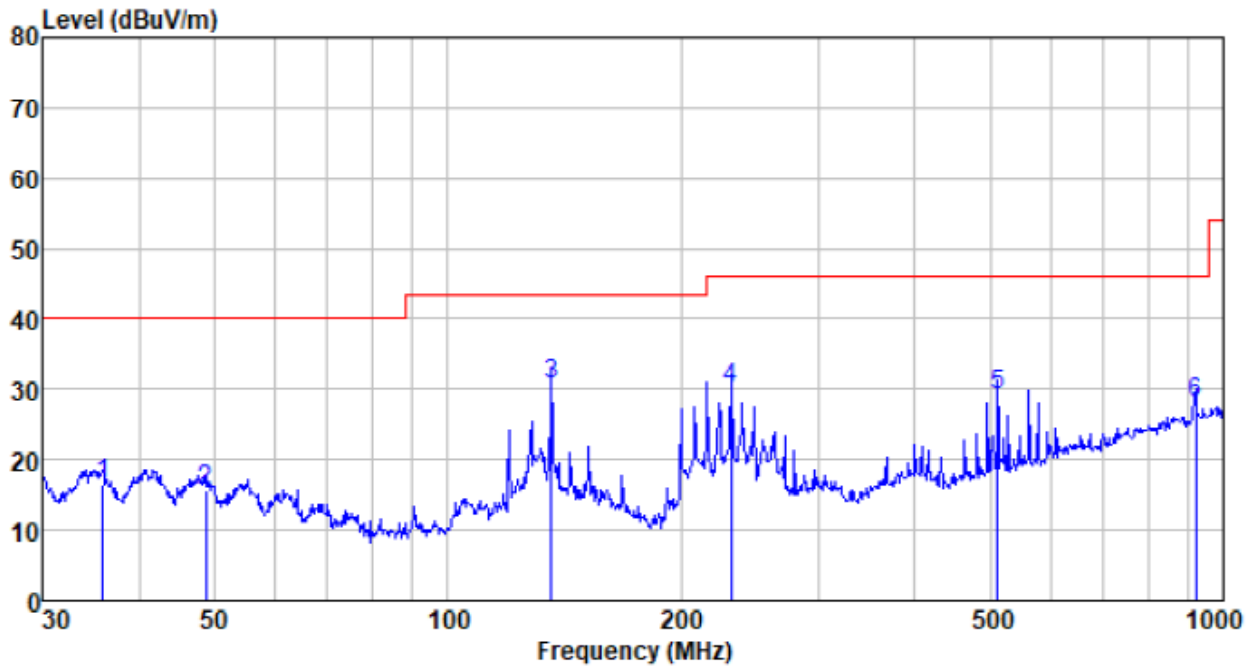

Freq MHz	Reading level dBuV	Antenna factor dB/m	Cable loss dB	Preamp factor dB	level dBuV/m	Limit level dBuV/m	Over limit dB	Remark
35.875	38.81	12.63	0.62	35.41	16.65	40.00	-23.35	QP
48.672	38.05	13.02	0.76	36.12	15.71	40.00	-24.29	QP
135.982	54.41	11.86	1.48	36.99	30.76	43.50	-12.74	QP
231.718	55.99	9.59	2.02	37.36	30.24	46.00	-15.76	QP
511.835	46.41	16.90	3.36	37.51	29.16	46.00	-16.84	QP
922.516	37.29	23.41	4.93	37.58	28.05	46.00	-17.95	QP

Test channel:	Highest	Polarization:	Horizontal
---------------	---------	---------------	------------

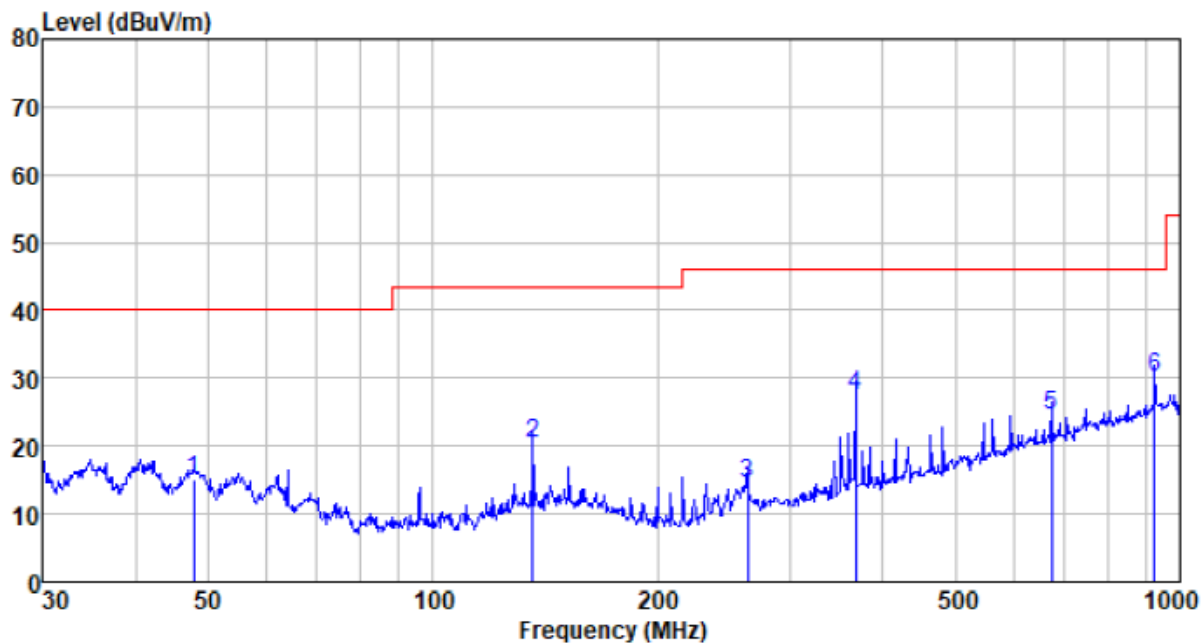

Freq MHz	Reading level dBuV	Antenna factor dB/m	Cable loss dB	Preamp factor dB	level dBuV/m	Limit level dBuV/m	Over limit dB	Remark
47.826	37.41	13.01	0.75	36.08	15.09	40.00	-24.91	QP
135.982	43.87	11.86	1.48	36.99	20.22	43.50	-23.28	QP
263.819	38.37	11.26	2.19	37.39	14.43	46.00	-31.57	QP
368.112	48.24	14.01	2.71	37.49	27.47	46.00	-18.53	QP
672.845	38.13	20.09	3.99	37.61	24.60	46.00	-21.40	QP
925.756	39.12	23.48	4.95	37.58	29.97	46.00	-16.03	QP

Test channel:	Highest	Polarization:	Vertical
---------------	---------	---------------	----------

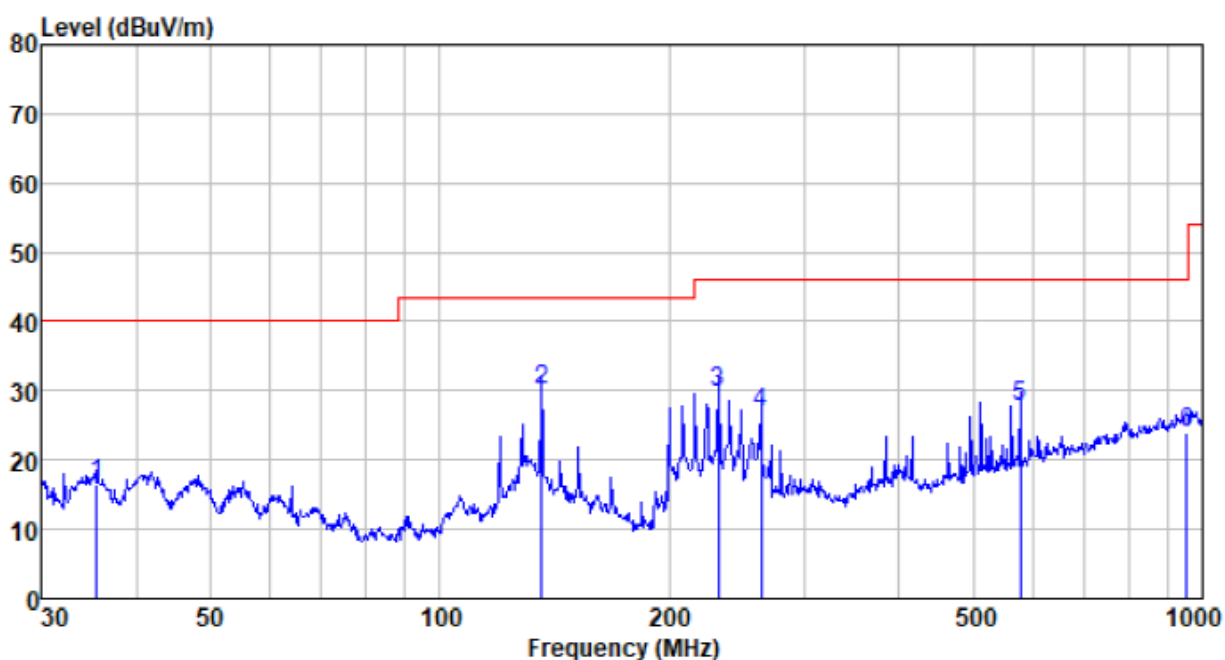

Freq MHz	Reading level dBuV	Antenna factor dB/m	Cable loss dB	Preamp factor dB	level dBuV/m	Limit level dBuV/m	Over limit dB	Remark
35.499	38.73	12.58	0.61	35.39	16.53	40.00	-23.47	QP
135.982	53.80	11.86	1.48	36.99	30.15	43.50	-13.35	QP
231.718	55.64	9.59	2.02	37.36	29.89	46.00	-16.11	QP
263.819	50.83	11.26	2.19	37.39	26.89	46.00	-19.11	QP
576.644	43.06	18.66	3.63	37.53	27.82	46.00	-18.18	QP
952.094	32.45	23.98	5.04	37.55	23.92	46.00	-22.08	QP

- Unwanted Emissions in Restricted Frequency Bands
- Above 1GHz

Test channel:	Lowest	Polarization:	Horizontal
---------------	--------	---------------	------------

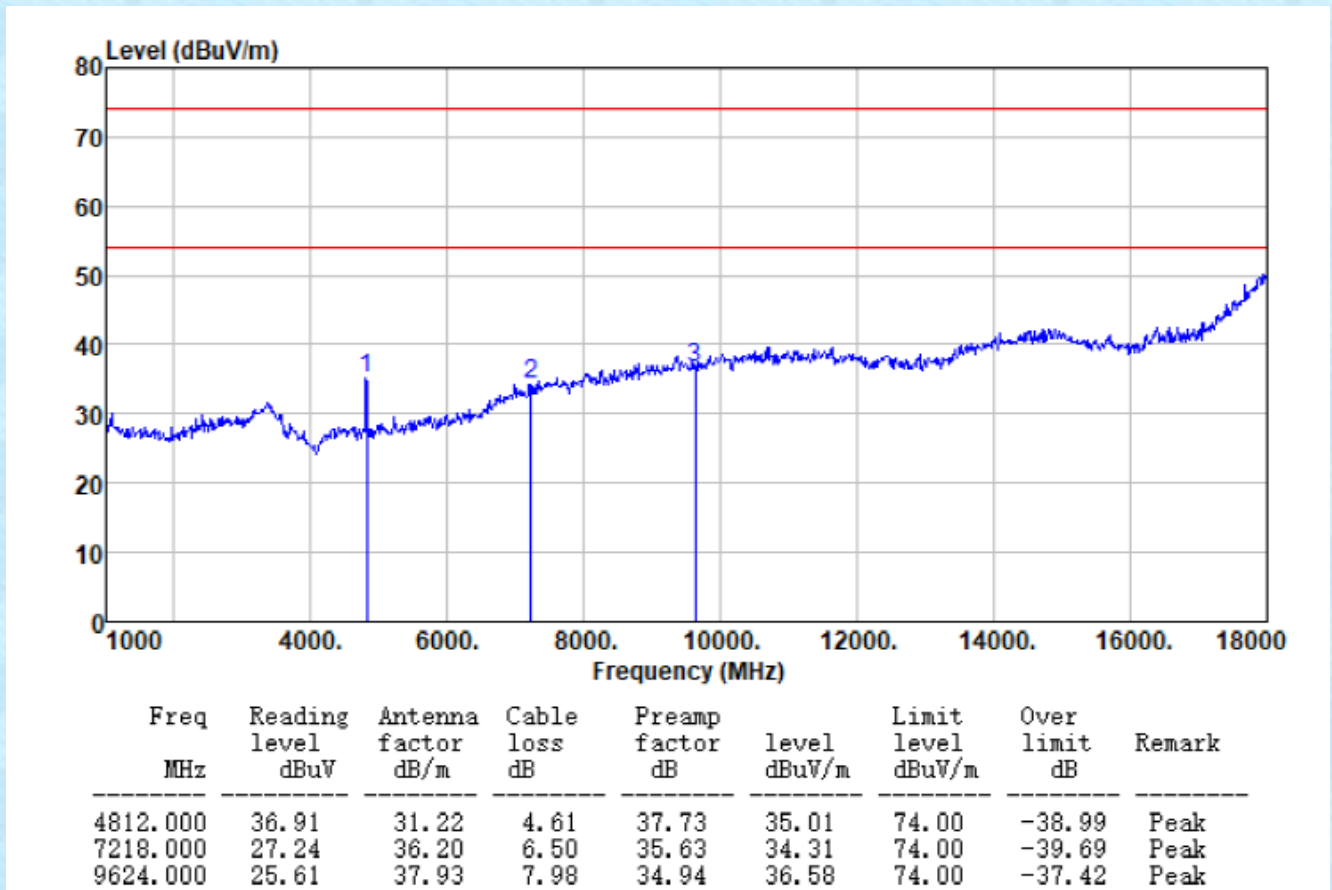

Test channel:	Lowest	Polarization:	Vertical
---------------	--------	---------------	----------

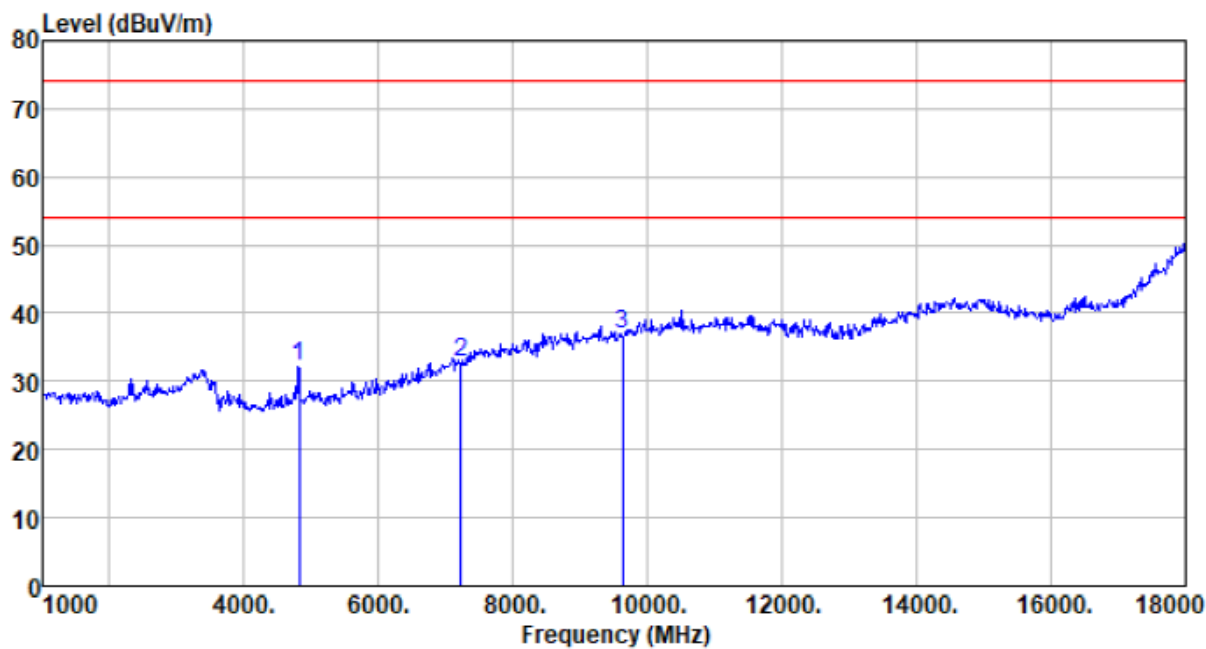

Freq MHz	Reading level dBuV	Antenna factor dB/m	Cable loss dB	Preamp factor dB	level dBuV/m	Limit level dBuV/m	Over limit dB	Remark
4812.000	34.09	31.22	4.61	37.73	32.19	74.00	-41.81	Peak
7218.000	25.61	36.20	6.50	35.63	32.68	74.00	-41.32	Peak
9624.000	25.97	37.93	7.98	34.94	36.94	74.00	-37.06	Peak

Test channel:	Middle	Polarization:	Horizontal
---------------	--------	---------------	------------

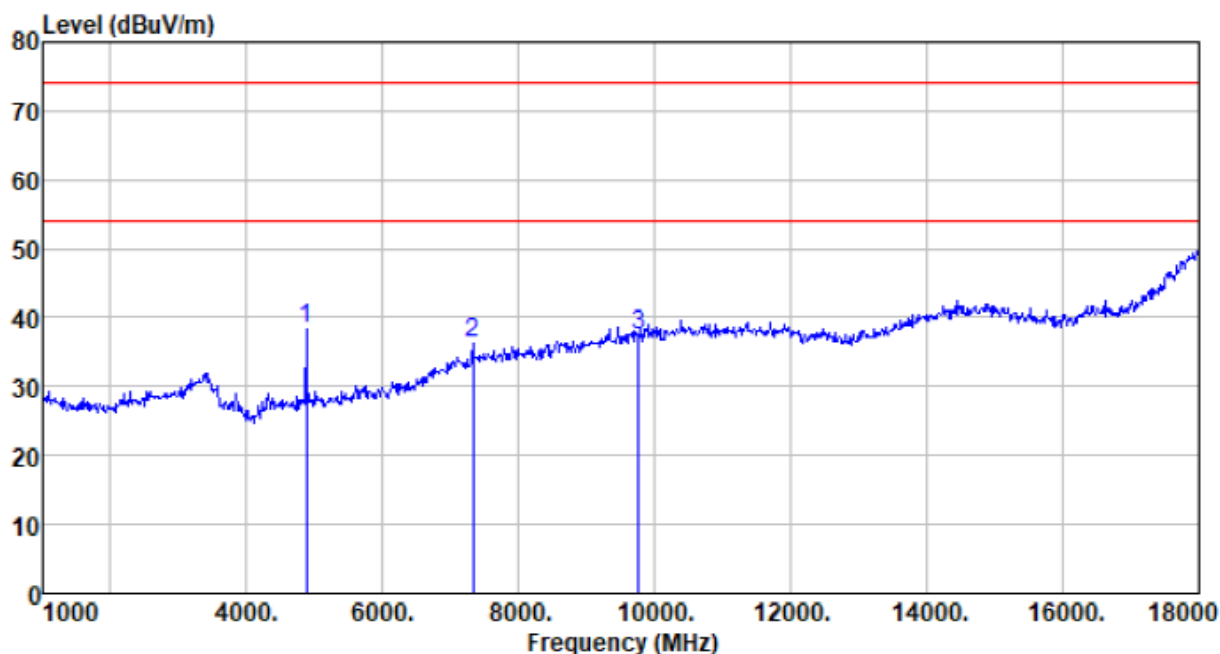

Freq MHz	Reading level dBuV	Antenna factor dB/m	Cable loss dB	Preamp factor dB	level dBuV/m	Limit level dBuV/m	Over limit dB	Remark
4880.000	40.19	31.31	4.69	37.75	38.44	74.00	-35.56	Peak
7320.000	28.94	36.43	6.63	35.60	36.40	74.00	-37.60	Peak
9760.000	26.42	38.10	8.03	35.03	37.52	74.00	-36.48	Peak

Test channel:	Middle	Polarization:	Vertical
---------------	--------	---------------	----------

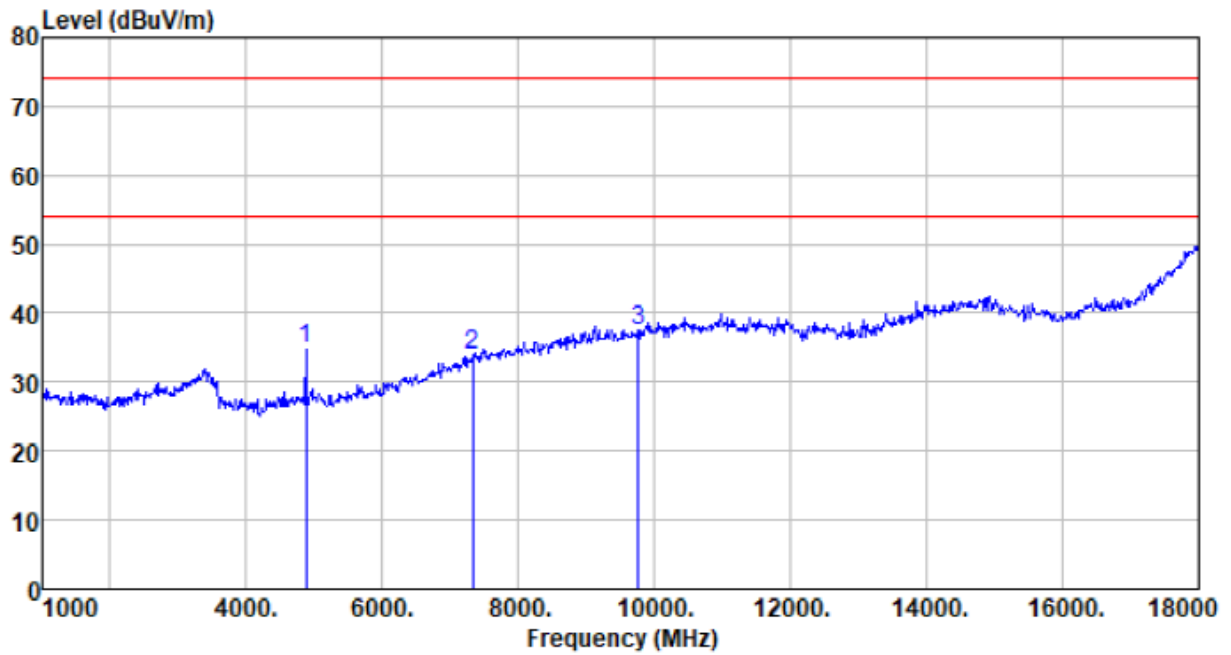

Freq MHz	Reading level dBuV	Antenna factor dB/m	Cable loss dB	Preamp factor dB	level dBuV/m	Limit level dBuV/m	Over limit dB	Remark
4880.000	36.55	31.31	4.69	37.75	34.80	74.00	-39.20	Peak
7320.000	26.52	36.43	6.63	35.60	33.98	74.00	-40.02	Peak
9760.000	26.32	38.10	8.03	35.03	37.42	74.00	-36.58	Peak

Test channel:	Highest	Polarization:	Horizontal
---------------	---------	---------------	------------

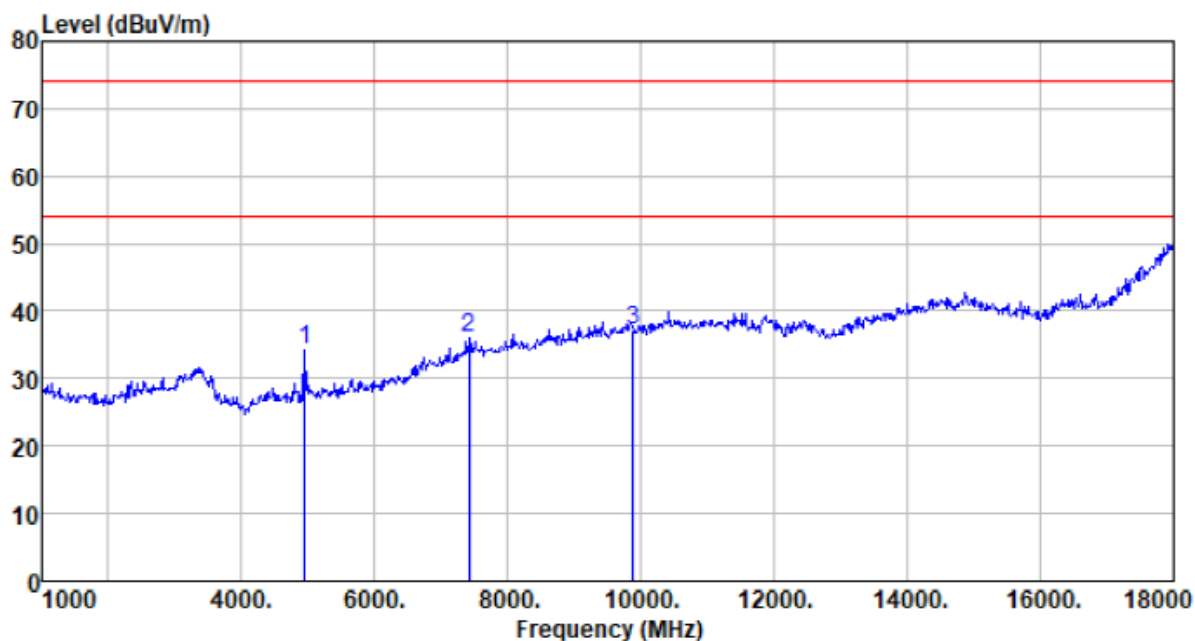

Freq MHz	Reading level dBuV	Antenna factor dB/m	Cable loss dB	Preamp factor dB	level dBuV/m	Limit level dBuV/m	Over limit dB	Remark
4944.000	35.88	31.41	4.77	37.78	34.28	74.00	-39.72	Peak
7416.000	28.28	36.62	6.73	35.57	36.06	74.00	-37.94	Peak
9888.000	25.86	38.27	8.08	35.12	37.09	74.00	-36.91	Peak

Test channel:	Highest	Polarization:	Vertical
---------------	---------	---------------	----------

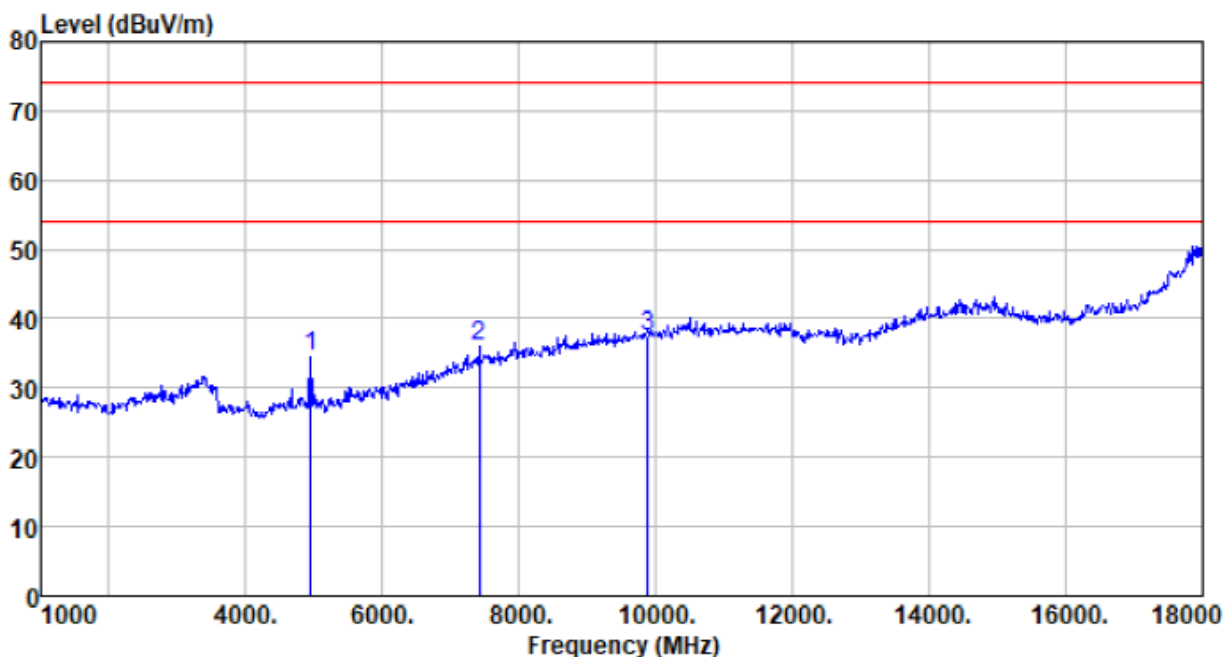

Freq MHz	Reading level dBuV	Antenna factor dB/m	Cable loss dB	Preamp factor dB	level dBuV/m	Limit level dBuV/m	Over limit dB	Remark
4944.000	36.08	31.41	4.77	37.78	34.48	74.00	-39.52	Peak
7416.000	28.23	36.62	6.73	35.57	36.01	74.00	-37.99	Peak
9888.000	26.21	38.27	8.08	35.12	37.44	74.00	-36.56	Peak

Remark:

1. Final Level = Receiver Read level + Antenna Factor + Cable Loss – Pre-amplifier Factor
2. “*”, means this data is too weak instrument of signal is unable to test.
3. The emission levels of other frequencies are very lower than the limit and not show in test report.
4. For above 18GHz, no emission found.

Unwanted Emissions in Non-restricted Frequency Bands

Test channel:	Lowest	Polarization:	Horizontal
---------------	--------	---------------	------------

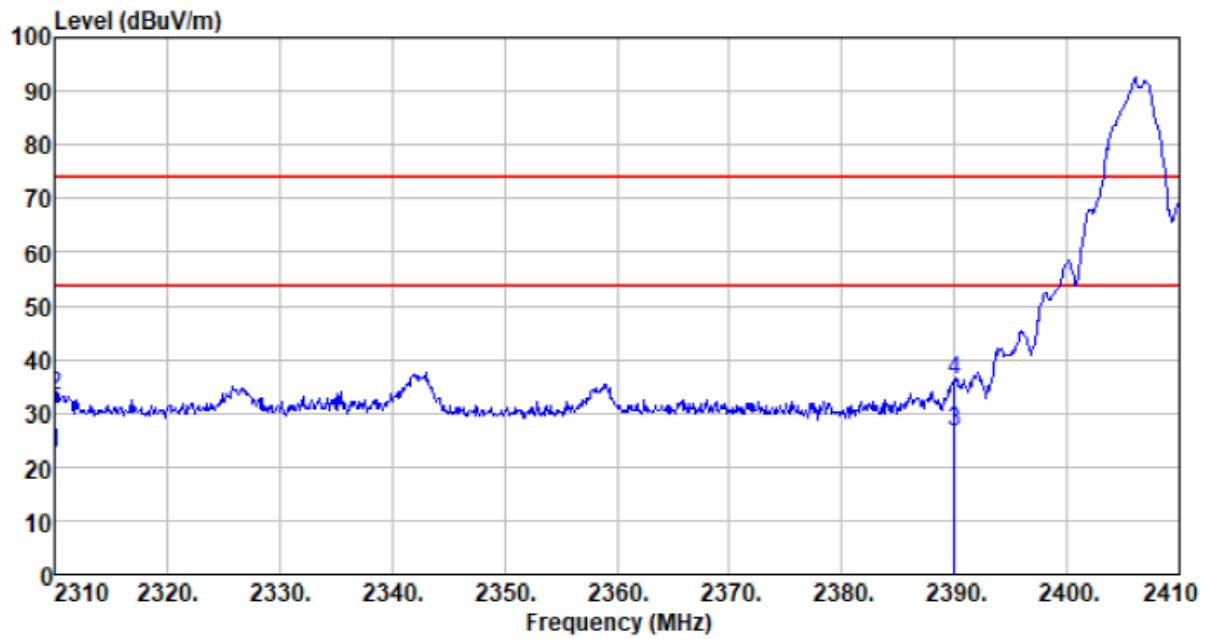

Freq MHz	Reading level dBuV	Antenna factor dB/m	Cable loss dB	Preamp factor dB	level dBuV/m	Limit level dBuV/m	Over limit dB	Remark
2310.000	31.07	27.14	2.81	38.64	22.38	54.00	-31.62	Average
2310.000	41.84	27.14	2.81	38.64	33.15	74.00	-40.85	Peak
2390.000	34.97	27.37	2.91	38.84	26.41	54.00	-27.59	Average
2390.000	44.56	27.37	2.91	38.84	36.00	74.00	-38.00	Peak

Test channel:	Lowest	Polarization:	Vertical
---------------	--------	---------------	----------

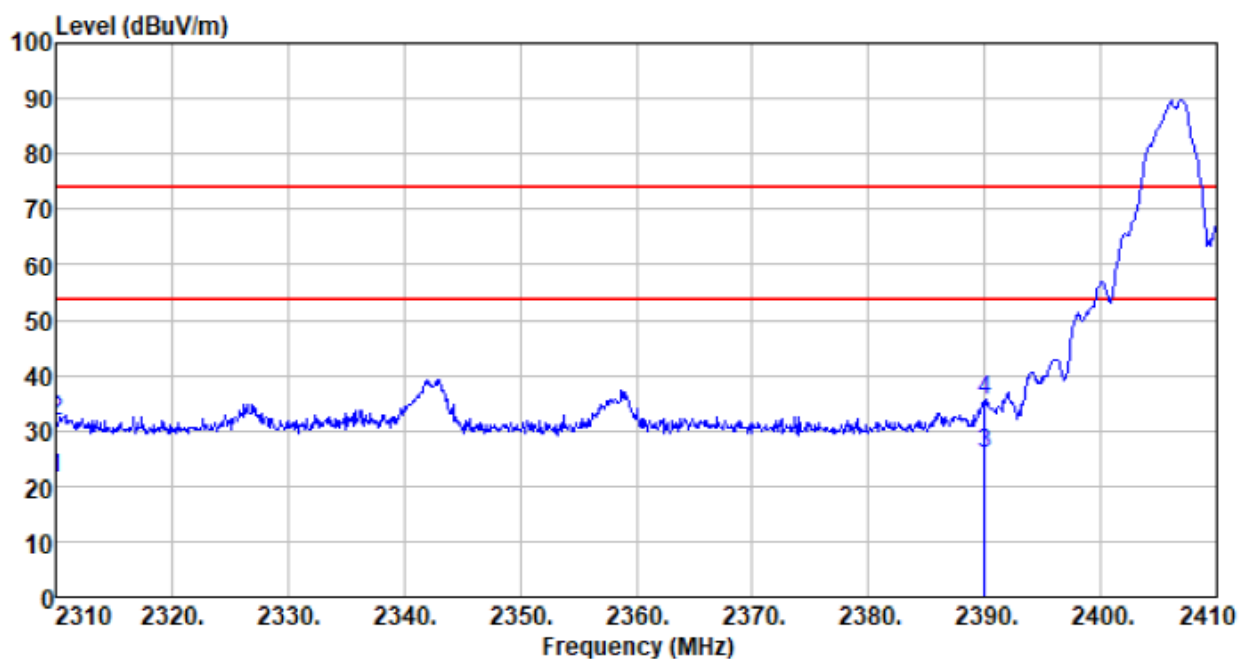

Freq MHz	Reading level dBuV	Antenna factor dB/m	Cable loss dB	Preamp factor dB	level dBuV/m	Limit level dBuV/m	Over limit dB	Remark
2310.000	30.01	27.14	2.81	38.64	21.32	54.00	-32.68	Average
2310.000	40.30	27.14	2.81	38.64	31.61	74.00	-42.39	Peak
2390.000	34.35	27.37	2.91	38.84	25.79	54.00	-28.21	Average
2390.000	44.12	27.37	2.91	38.84	35.56	74.00	-38.44	Peak

Test channel:	Highest	Polarization:	Horizontal
---------------	---------	---------------	------------

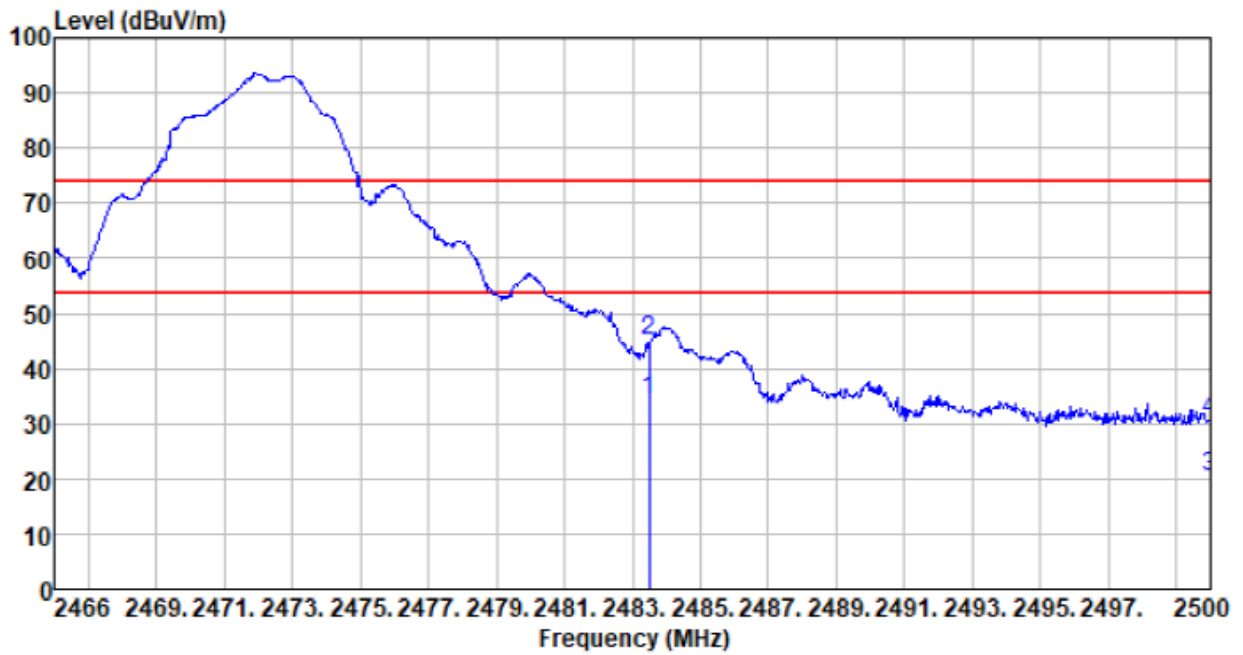

Freq MHz	Reading level dBuV	Antenna factor dB/m	Cable loss dB	Preamp factor dB	level dBuV/m	Limit level dBuV/m	Over limit dB	Remark
2483.500	42.91	27.66	2.99	39.06	34.50	54.00	-19.50	Average
2483.500	53.38	27.66	2.99	39.06	44.97	74.00	-29.03	Peak
2500.000	28.76	27.70	3.01	39.10	20.37	54.00	-33.63	Average
2500.000	38.90	27.70	3.01	39.10	30.51	74.00	-43.49	Peak

Test channel:	Highest	Polarization:	Vertical
---------------	---------	---------------	----------

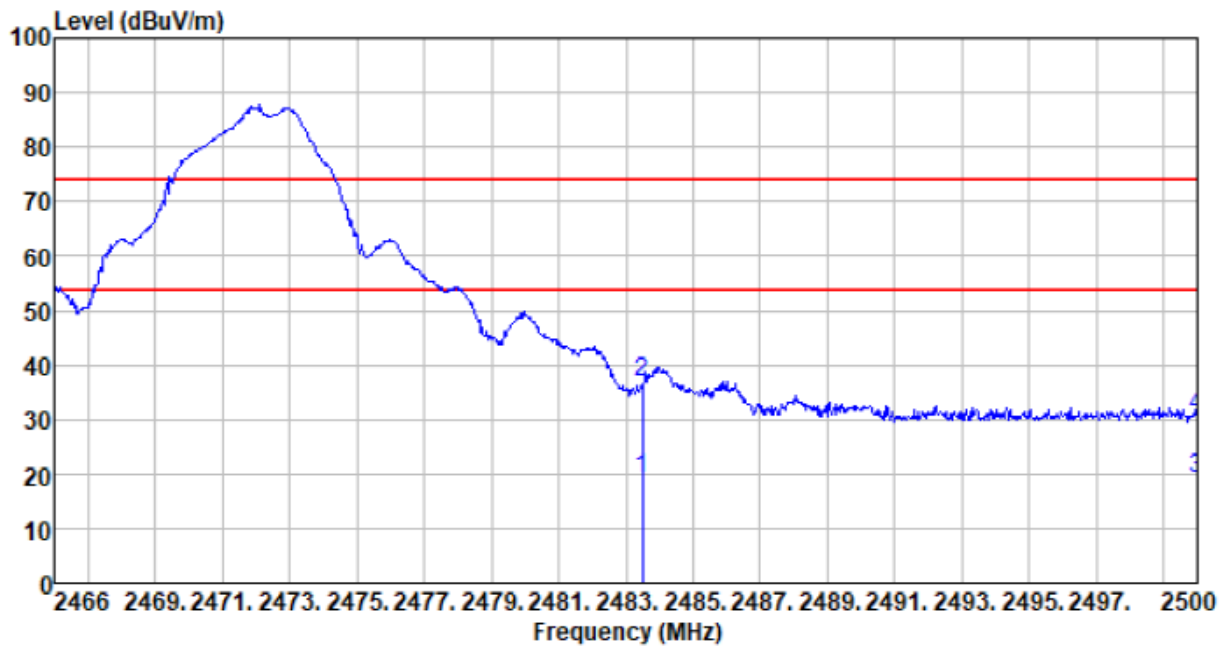

Freq MHz	Reading level dBuV	Antenna factor dB/m	Cable loss dB	Preamp factor dB	level dBuV/m	Limit level dBuV/m	Over limit dB	Remark
2483.500	27.66	27.66	2.99	39.06	19.25	54.00	-34.75	Average
2483.500	45.24	27.66	2.99	39.06	36.83	74.00	-37.17	Peak
2500.000	27.70	27.70	3.01	39.10	19.31	54.00	-34.69	Average
2500.000	39.10	27.70	3.01	39.10	30.71	74.00	-43.29	Peak

Remarks:

1. Final Level = Receiver Read level + Antenna Factor + Cable Loss – Preamplifier Factor
2. The emission levels of other frequencies are very lower than the limit and not show in test report.

8 Test Setup Photo

Reference to the **appendix I** for details.

9 EUT Constructional Details

Reference to the **appendix II** for details.

---End---