



FS-i10

Digital Proportional radio control system

INSTRUCTION MANUAL

用户手册

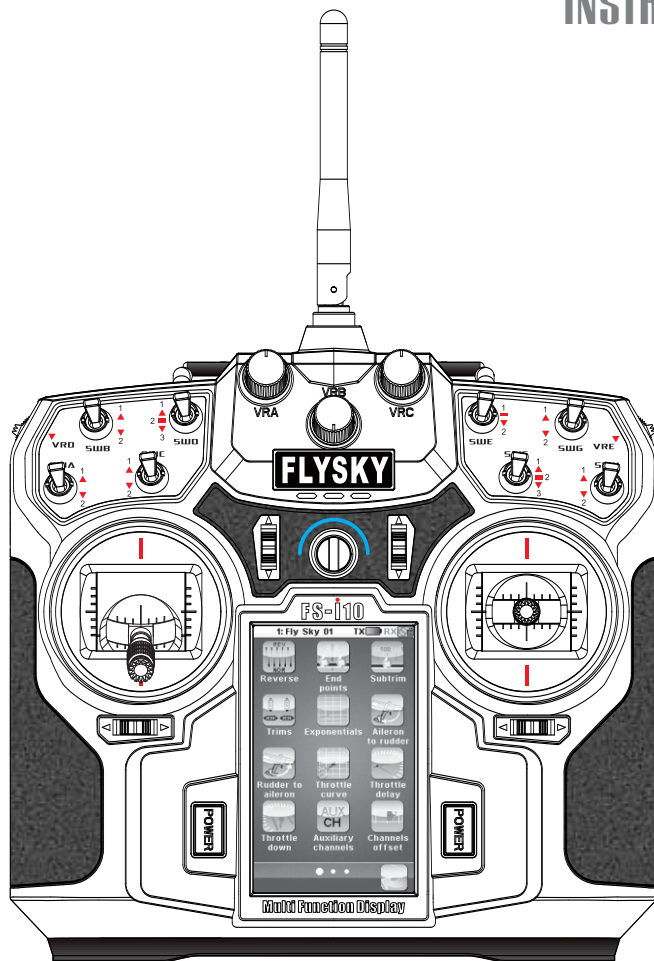

<http://www.flysky-cn.com>

Copyright©2013-2017
Flysky RC model technology Co., Ltd



CE0678FC

目录

1, 简介Introduction.....	3
2, 服务Services.....	3
3, 特殊标志Special symbols.....	4
4, 安全指导Safety guide.....	4-6
5, 2.4G系统2.4GHz System Specifications.....	7
6, 系统特征项System Characteristics.....	8
7, 电池充电注意事项Battery Charging Instructions.....	8
8, 系统简介System Overview.....	9
9, 发射机参数Transmitter specifications.....	10
10, 接收机参数Receiver specifications.....	10
10.01, FS-APD01 磁感应速度采集模块RPM telemetry (magnetic) module.....	11
10.02, FS-APD02 光感应速度采集模块RPM telemetry (optical) module.....	11
10.03, FS-ATM01 温度采集模块Temperature acquisition module.....	11
10.04, FS-AVT01 电压采集模块Voltage acquisition module.....	11
10.05, FS-AEV01 i-BUS 串行总线接收机i-bus receiver.....	11
11, 接收机与伺服器连接Receiver and servo connections.....	12
11.01, 飞机模型的安装Airplane model installation.....	13
11.02, 直升机模型的安装Helicopter model installation.....	13
12, 接收机操作说明Receiver Operational Instructions.....	14
12.01, 接口说明Port Setup.....	14
12.02, 对码Binding Setup.....	14
12.03, FS-AEV01 i-BUS 串行总线接收机连接 i-bus Receiver Connection Setup.....	15
12.04, FS-APD01 磁感应转速采集模块连接 RPM telemetry (magnetic) module Setup.....	15
12.05, FS-APD02 光感应转速采集模块连接 RPM telemetry (optical) module Setup.....	16
12.06, FS-ATM01 温度采集模块连接 Temperature telemetry module Setup.....	16
12.07, FS-AVT01 电压采集模块连接 External voltage telemetry module Setup.....	16
13, 遥控器各部件说明Control Parts Descriptions.....	17
14, 摇杆模式调整Stick mode adjustment.....	18
15, 开机Power On.....	19
15.01 开机异常保护 Boot abnormal protection.....	19
16, 关机Power Off.....	19
16.01 关机异常保护 Shutdown abnormal protection.....	19
17, 开机画面Logo/Information Screen.....	20
18, 主菜单Main menu.....	21
19, 顶部状态栏System Status.....	21
20, 功能操作General Functions Description.....	22-24
21, 通用功能菜单 General Functions Menu.....	25
21.01, 正逆转Reverse.....	25
21.02, 最大能量End points.....	25
21.03, 记忆微调Subtrim.....	25
21.04, 微调Trims.....	26

21.05, 比率及指数 Scaling Exponentials	26
21.06, 副翼方向混控 Aileron to rudder	27
21.07, 方向副翼混控 Rudder to Aileron	27
21.08, 油门曲线Throttle Curve	28
21.09, 油门延迟Throttle Delay	28
21.10, 收油门 Throttle Down	29
21.11, 辅助通道Auxillary Channels	29
21.12, 通道偏移Channels offset	30
21.13, 功能延迟 Function Delay	30
21.14, 通道延迟 Channels Delay	30
21.15, 线性混控Linear mixes	31
21.16, 曲线混控Curve Mixes	31
21.17, 状态Conditions	32
21.18, 逻辑开关Logic switches	32
21.19, 飞机结构Airplane structure	33
21.20, 定时器Timers.....	33
21.21, 教练模式Trainer Mode	34
21.22, 显示舵机Display servos	34
21.23, 模型Models	35-36
21.24, 接收设置RX Setup	37-39
21.25, 系统System	40-42
22, 固定翼机/滑翔机专有程序功能菜单	
Airplane/Glider exclusive function menu.....	42
22.01, 副翼功能Aileron function.....	43
22.02, 襟翼功能Flap function.....	43
22.03, 扰流板Spoiler function.....	43
22.04, 升降襟翼 Elevator to Flap	44
22.05, 油门曲线Throttle needle	44
22.06, 蝶形飞Butterfly	45
22.07, 升降功能Elevator function.....	45
22.08, 方向功能Rudder function.....	46
22.09, V型尾翼V-tail.....	46
22.10, 飞机结构 Airplane Structure	47
23, 直升机专有功能菜单Helicopter exclusive function menu.....	47
23.01, 油门保持Throttle Hold	47
23.02, 油门混控Throttle Mix	47
23.03, 螺距曲线Pitch Curve	47
23.04, 倾斜盘混控Swashplate Mix	48
23.05, 结构 Structure	48
23.06, 倾斜类型Swashplate type	48
23.07, 倾斜盘环Swashplate ring	49
23.08, 定速设定Governor	49
23.09, 陀螺仪Gyroskop	49
24, 报警功能说明Warning funtion Overview.....	50
25, 常见故障说明Troubleshooting guide.....	51
26, 功能逻辑关系Function Trees.....	52-53
27, 包装内容Package Contents.....	54
28, FCC声明FCC Statement of Compliance.....	55

Digital proportional radio control system **FS-i10**

1. 简介 Introduction

感谢您选择富斯出品的FS-i10十通道2.4G第二代智能遥控系统(AFHDS2)，该系统可10个通道全面兼容直升机、固定翼、滑翔机，用户按模型结构自行设定。如果这是您第一次使用智能遥控系统，这本使用手册将很快地带给您一个有趣又高端的全新世界。因此，为了确保您安全使用本产品，请仔细地完整阅读这本使用手册。

Thank you for choosing the Fly Sky FS-i10 ten channels 2.4 GHz AFHDS2 intelligent system, which is compatible with helicopter, fixed wing, glider and powered glide systems. System parameters can be set up based on the model owned by the user. If this is your first time to use an intelligent system, this user manual will provide you with the instructions you need to obtain full enjoyment from your new system. Before using your new system, please read all instructions carefully, to ensure your safety.

<http://www.flysky-cn.com>

2. 服务 Services

如果您使用时遇到任何问题，请参照此说明书。如果您的问题仍然未能解决，请直接联系当地经销商或者我们网站上的客服人员。

If you encounter any problems, while using this system, please refer to the appropriate section of this manual. After consulting this manual, you are unable to solve your problem, please contact your local dealer or connect to consult our service and support website (<http://www.flysky-cn.com/Service.asp>) for further assistance.

<http://www.flysky-cn.com>

3. 特殊标志 Special symbols

当以下标志出现在说明书的时候请注意并且仔细阅读。

Please pay attention to the following symbols when they appear in the manual and read carefully.

 **Danger:** 如果使用者不按照说明方法操作，有可能导致使用者严重受伤，甚至致命的危险。

Not following these instructions may expose the user to serious injuries or death.

 **Warning:** 如果使用者不按照说明方法操作，有可能导致使用者严重受伤。

Not following these instructions may expose the user to serious injuries.

 **Attention:** 如果使用者不按照说明方法操作，有可能导致使用者外伤，甚至严重受伤。

Not following these instructions may expose the user to minor injuries and even to serious injuries.



4. 安全指导 Safety guide



请不要在夜晚或者雷雨天使用此产品，因为恶劣的天气环境有可能导致遥控设备失控。

Do not use at night or during a lightning storm, as bad weather will adversely affect the control of your system.



操控时，请先确认模型所有舵机的动作方向与操控方向一致。

如果不一致，请调整好正确的方向。

Make sure that the motors are all moving the same direction as the operating direction.



关闭时，请务必先关闭接收机电源，然后关闭发射机，如果关闭发射机电源时接收机仍然在工作，将有可能导致遥控设备失控或者引擎继续工作而引发事故。

The shutdown sequence is as follows: 1. Disconnect the receiver battery 2. Switch off the transmitter Failure to follow this procedure may result in uncontrolled movement and damage to the system.



特别要注意，如果附近有汽车正在运行或飞机正在飞行，开机后2.4 GHz RC系统可能会影响到他们。

Please be aware, that the 2.4G R/C system may affect nearby planes or cars after you turn on the transmitter



一定要启用防失控功能。
Be sure to set the Fail Safe function.



不要在户外雨天，有水的地方或当能见度有限的时候使用。
可能水分(水或雪)会进入到系统内部，不稳定的运行和失控可能发生。
Do not operate outdoors on rainy days, run through puddles of water or use when visibility is limited.
Should any type of moisture (water or snow) enter any component of the system, erratic operation and loss of control may occur.



不要操作在以下的地方：
基站附近或其他无线电活跃的地方，
人多的地方或道路附近，
有客船的水域，
高压电线或通信广播天线附近，
干扰可能导致失控，
安装不正确，无线电控制系统可能导致模型发生严重的伤害。
Do not operate in the following places:
Near other sites where other radio control activity may occur,
Near people or roads,
On any pond when passenger boats are present,
Near high voltage power lines or communication broadcasting antennas.
Interference could cause loss of control,
Improper installation of your Radio Control System in your model could result in serious injury.



当你感到疲倦，饮酒或吸毒后，不舒服的影响下，不要操作这个R/C系统。
判断力下降，而且可能发生危险的情况下，对自己或他人可能造成严重的伤害。
Do not operate this R/C system when you are tired, not feeling well or under the influence of alcohol or drugs.
Your judgment is impaired and could result in a dangerous situation that may cause serious injury to yourself as well as others.



当模型操作或使用后，请勿触摸发动机、电机、定速设定或任何可能发热的部分，
这些部分可能非常热，会造成严重的烧伤。
Do not touch the engine, motor, speed control or any part of the model that will generate heat while the model is operating or immediately after its use. These parts may be very hot and can cause serious burns.



总是在操作模型之前进行全面的检查。
无线电控制系统出现问题以及不正确安，都有可能导致模型失控，
简单的距离测试方法：
一个人把持模型另一个人持发射机走开，检查该伺服系统运转情况。
测试时要注意到若有异常出现，请不要操作模型。
也检查模型的记忆，以确保模型的匹配是适当的。
Please have an overall check about the model before any operation.
Any problem in radio control system or improper installation may cause out of control.
Simple distance test methods:
One hold the model, and the other one carry the transmitter to a proper place to check the servo system condition.
Please stop operation if any exceptional case occurs.
Please check the model memory to make sure the matching is right.



开机时，每次都要检查发射器的油门中位是否是最低。
当发射机作出调整时，可能模型的引擎没有运行或电机没有连接，可能会发生失控或意外事故的情况。
Turn on the power, please check if the throttle neutral position is in its lowest position while turning on the transmitter every time.
When making adjustments to the model, do so with the engine not running or the motor disconnected, you may unexpectedly lose control and create a dangerous situation.

防失控功能:

检查操作步骤如下:

- (1) 打开发射机和接收机, 启动发射机防失控功能, 并设定在正确的位置。
- (2) 至少等待30秒钟, 然后关掉发射机电源开关。(发射机每5秒会自动发送防失控的数据到接收机)。
- (3) 检查在无接收时, 接收机会不会使伺服系统处于预定的位置。

这个功能是一个安全功能, 接收失败时, 预置伺服系统到预定位置, 可以最大限度地减少伤害。

然而, 如果设置为一个不当的位置, 会有相反的效果, 必须重置伺服系统操作的位置。(详情见失控保护功能设定P37)



Fail safe function:

Before running (cruising), check the fail safe function:

Check Method: Before starting the engine, check the fail safe function as follows:

- (1) Turn on the transmitter and receiver power switches.
- (2) Wait at least 30 seconds, then turn off the transmitter. (The transmitter automatically transfers the fail safe data to the receiver every 5 seconds.)
- (3) Check if the fail safe function moves the servos to the preset position when reception fails.

The fail safe function is a safety feature that minimizes set damage by moving the servos to a preset position when reception fails. However, if set to a dangerous position, it has the opposite effect.

When the reverse function was used to change the operating direction of a servo, the fail safe function must be reset. (for more information about this function please reference page 37)

电池:

- (1) 不要短路电池两极。
- (2) 不要把电池放置在有强烈冲击和振动的地方。电池可能会发生短路或过热, 电解液泄漏出来, 可能引起烧伤或化学损坏。



Battery :

- (1) Do not make the battery short circuit.
- (2) Do not drop the battery or expose it to strong shocks or vibrations. The battery may short circuit and overheat, electrolyte may leak out and cause burns or chemical damage.

模型保管:

1. 不要把无线电系统或模型放在幼童伸手可及的地方。
幼童可能会不小心操作系统, 这可能发生危险的情况, 造成伤害。

2. 不要储存你的R / C系统在以下的地方:

极热或冷的地方,
直接暴露于强光下,
在高湿度环境,
振动频繁的地方,
灰尘多的地方,
在潮湿或者过于寒冷的地方,
存储你的R / C系统在不利条件下, 可能会导致变形和许多操作问题。



Storage:

1. Do not leave the radio system or models within the reach of small children.
A small child may accidentally operate the system. This could cause a dangerous situation and injuries.
2. Do not store your R/C system in the following places.
Where it is extremely hot or cold,
Where the system will be exposed to direct sunlight,
Where the humidity is high,
Where vibration is prevalent,
Where dust is prevalent,
Where the system would be exposed to steam and condensation,
Storing your R/C system under adverse conditions could cause deformation and numerous problems with operation.

注意:

请勿放置在燃料, 电动机喷雾, 废油或排气旁边。燃料, 电动机喷雾, 废油和排气将渗透和损害塑料。

Notice:

Do not expose plastic parts to fuel, motor spray, waste oil or exhaust. The fuel, motor spray, waste oil and exhaust will penetrate and damage the plastic.

5. 2.4G系统 2.4GHz System Specifications



AFHDS2A是第二代增强版自动跳频数字系统的简写。它是一个高度精密的遥控信号传播系统，这个系统能够提供良好的距离，抗干扰能力强并且耗电量低。它是世界领先的遥控制造商之一——富斯遥控模型技术有限公司研发并测试多年的成果。

AFHDS2A stands for "Automatic Frequency Hopping Digital System 2A". This highly sophisticated radio transmission system will guarantee you a long range, jamming free and long battery life experience. This is the result of years of research and testing and makes Fly Sky one of the world leader in the market.

参数说明：

频率范围：2.405.5-2.475GHz
波段宽度：500KHz
波段个数：140个
发射功率：不高于20dBm (100mW)
发射模式：AFHDS2 (第二代自动跳频数字系统)
编码方式：GFSK
天线长度：26mm (双天线)
接收机灵敏度：-105dBm

RF specifications:

RF range: 2.405.5-2.475GHz
Channel bandwidth: 500KHz
Number of channels: 140
RF power: less than 20dBm (100mW)
RF mode: AFHDS 2(Automatic Frequency Hopping Digital System2)
Modulation type: GFSK
Antenna length: 26mmx2
RX sensitivity: -105dBm

警告!

错误使用遥控设备将可能导致严重的伤害甚至死亡。请在使用前完整阅读这本使用手册，并且在使用过程中严格按照此手册的说明操作。

Danger:

Misuse of this radio system can lead to serious injuries or death. Please read completely this manual and only operate your radio system according to it.

该2.4G无线电波段完全不同于之前所使用的低频无线电波段。使用时要保持您的模型产品飞行在您的视线范围内，因为大的障碍物将会阻断无线电频率信号从而导致遥控失控和危险。2.4G无线电频率信号是沿直线传播的，它不能绕过障碍物进行传播。在使用过程中，严禁紧握发射机天线，否则将会大大减弱无线电传播信号的质量和强度，导致遥控设备失控和危险。

The 2.4 GHz radio band has a completely different behavior than previously used lower frequency bands. Always keep your model in sight as a large object can block the RF signal and lead to loss of control and create a dangerous situation. The 2.4 GHz RF signal propagates in a straight line and cannot circumvent objects in its path. Never grip the antenna during operation as it significantly degrades the signal and may cause loss of control and damage to the system.

警告!

每次使用时，必须先打开发射机，然后再给接收机通电。停止使用时，必须先断开接收机电源，然后再关闭发射机。这样操作可以避免接收机接收到错误信号而导致的伺服器无规律的抖动。这对于电动模型来说尤为重要，因为它有可能导致马达突然转动而致使人员伤亡。

Danger:

Always turn on the transmitter first then the receiver. When turning off the system, always turn off the receiver first then the transmitter. This is to avoid having the receiver on itself as it may pick a wrong signal and lead to erratic servo movements. This is particularly important for electric powered models as it may unexpectedly turn on the motor and lead to injuries or death.

6. 系统特征 System characteristics

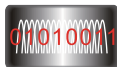

此系统工作频率范围是2.405.5到2.475GHz。整个波段被分为140个独立频点。每套遥控系统使用16个不同频点和160种不同的跳频算法。通过开机时间不同，跳频规律不同和使用不同的频点，遥控系统能避免干扰传播信号。

This radio system works in the frequency range of 2.405.5 to 2.475GHz. This band has been divided into 140 independent channels. Each radio system uses 16 different channels and 160 different types of hopping algorithm. By using various switch-on times, hopping scheme and channel frequencies, the system can guarantee a jamming free radio transmission.



此系统采用高质量的增益天线，覆盖整个波段带宽。配合高灵敏度接收机，系统能有效的避免远距离传播信号的干扰。

This radio system uses a high gain and high quality multi directional antenna. It covers the whole frequency band. Associated with a high sensitivity receiver, this radio system guarantees a jamming free long range radio transmission.



每台发射机有一个唯一的ID码，当和接收机对码之后，接收机保存这个唯一的ID码并且只接受从这个ID码发射机发出的信号。这样可以避免接收到别的发射机信号，大大增强抗干扰能力和安全性。

Each transmitter has a unique ID. When binding with a receiver, the receiver saves that unique ID and only accept data from that unique transmitter. This prevents obtaining the wrong signal from another transmitter and insures safety for your system.



此系统使用低功率电子元件和高灵敏度接收机芯片。无线频率模块采用间歇性信号传播，因此大大降低了发射功率。比较而言，此系统功耗仅为FM版本的十分之一。

This radio system uses low power electronic components and a very sensitive receiver chip. The RF modulation uses intermittent signal transmission thus reducing even more power consumption. Comparatively, this radio system uses only a tenth of the power of a standard FM system.



此系统采用信息回传功能，此功能更好的掌握当前模型的工作状态。从而增添了操控乐趣以及更加安全控制模型。

This system uses the two-way communication, which could control the working state of current model better and make the operation more enjoyable and safer than before.

7. 电池充电注意事项 Battery charging instructions



如果您的发射机或者接收机使用任何种类的可充电电池，请在每次飞行前检查电池，确保电池完好无损并且满电，否则有可能导致失控或者人员伤亡。

If your transmitter or receiver uses any type of rechargeable batteries, please check them before each flight and make sure they are in good shape and fully charged other wise it may lead to loss of control, injuries and death.



如果您使用的是可充电电池，请确保充电器符合可充电电池规格并且用适当的电流进行充电否则将导致电池过热，失火甚至爆炸。充满电后，请立即断开充电电源。如果长时间不用遥控设备，请将电池从发射机和模型中取出保存，以免有损遥控设备。

If you are using rechargeable batteries, make sure to use a suitable charger with the right charging current set otherwise it may lead to battery overheating, fire or explosion. Disconnect the battery from the charger as soon as it is fully charged. If you don't plan to use your radio system for a long period of time, remove the batteries from the transmitter and the model as it may damage them.

7.01 发射机充电

1. 将锂电池按方向装入发射机或者充电器 (合上发射机电池盖);
2. USB连上适配器;
3. 将USB线另一端插入发射机或者充电器充电接口;
4. 将适配器插入插座。

1. Install the battery into the transmitter or charger (close the transmitter battery box cover).
2. Connect the USB cable to the adapter.
3. Insert USB cable to the charge port of transmitter or charger.
4. Insert the adapter into plug seat.

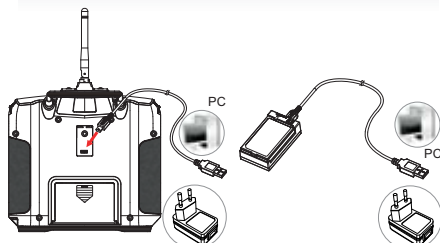

适配器 Adapter
(INPUT:100~240V
OUTPUT: 6V-1500mA)

适配器 Adapter
(INPUT:100~240V
OUTPUT: 6V-1500mA)

8. 系统简介 System Overview

- 采用最新双向遥测系统，并可兼容FLYSKY所有单双向接收机；
- 主页面可实时监控10电压，模型速度、温度、电压参数，已开启/关闭的功能，模型结构及计时器；
- 系统异常时，弧形动感LED及3D音效将及时提示；
- 3.55英寸WQVGA TFT 240*400像素触控彩屏可快速、方便的设定参数；
- 防止误操作电源开关设计，左右POWER键需同时按方可对10进行开关机；
- 8个开关，5个旋钮在大多数应用中可以指定不同的功能，其中3个旋钮可按压隐藏；
- 高精度双轴承细腻摇杆，超薄轻盈时尚机身设计，给用户一种新的体验；
- 双天线结构让2.4G频率调信号在各方向传播顺畅，信号安全性更强；
- 可存储20组模型，兼容SD卡并可与之交换数据；可寄存每组模型接收机的对码状态及模型参数。
- 免费软件在线升级，便捷又简单的方式更新系统。

The transmitter i10 :

- Adopts the latest two-way communication systems to ensure that all of the FS-brand receivers are compatible with this transmitter
- Home page menu can monitor i10 voltage, speed, temperature, voltage parameters, function conditions (on/off), model structure and timers in real time.
- The flashing LED and 3D audio effect will alert the user when a system exception occurs.
- This parameter is easily set due to the 3.55 inch, 240 by 400 pixels (WQVGA) color TFT-LCD touch screen.
- The power switch design prevents accidental power off or power on conditions. The transmitter can only be turned on/off by pushing both the left and right power buttons at the same time.
- Eight switches and five knobs can be assigned to different functions in most applications. The three knobs can be hidden by pressing them.
- The high-precision double-bearing gimbal and fashionable ultra-thin transmitter ensure a great experience for the user.
- The double antenna structure ensures the 2.4G frequency module transmits in all directions for a safer and better signal.
- The transmitter can store 20 models, including every model binding conditions. It can also store model settings on a SD card.
- Free software and upgrades to the system are available online.

- **兼容直升机、固定翼、滑翔机**，分为固定翼/滑翔机、直升机两种飞机类型，不同飞机结构匹配专有序列菜单、用户按模型结构自行设定：

• It is compatible with helicopter fixed-wing, glider, and powered glider. Airplane has two type, fixed-wing and helicopter. Different airplane structure is matching with different procedure. Users can set according to airplane structure.

• 通用功能 (General functions)

正逆转Reverse、最大舵量End points、记忆微调Subtrim、微调Trims、指数Exponentials、副翼方向Aileron to rudder、方向副翼 Rudder to aileron、油门曲线Throttle curve、油门延迟Throttle delay、收油门Throttle down、辅助通道Auxiliary channels、通道偏移Channels offset、功能延迟Function delay、通道延迟Channels delay、线性混控Linear mixes、曲线混控Curve mixes、状态Conditions、逻辑开关Logic switches、飞机结构Airplane structure、定时器Timers、教练模式Trainer mode、显示舵机Display servos、模型Models、接收机设置RX setup、系统System

• 固定翼/滑翔机 (Airplane/Glider)

默认结构 (引擎+副翼+升降+方向) Default structure (Engine+Aileron+Elevator+Rudder)

专有序列Exclusive function menu :

副翼功能Aileron function、襟翼功能Flap function、扰流板Spoiler function、升降襟翼Elevator to flap、油针曲线Throttle needle、蝶形飞Butterfly、升降功能Elevator function、方向功能Rudder function、V型尾翼V tail

• 直升机(Helicopter)

默认结构 (固定螺距) Default structure (fixed pitch)

专有序列Exclusive function menu :

油门保持Throttle hold、油门混控Throttle mix、螺距曲线Pitch curve、倾斜盘Swashplate mix、倾斜盘类型Swashplate type、倾斜盘环Swashplate ring、定速设定Governor、陀螺仪Gyroscope

9. 发射机参数 Transmitter specifications

机种参数：

- 通道个数：10
- 适合机种：直升机、固定翼、滑翔机
- 频率范围：2.405.5-2.475GHz
- 波段宽度：500KHz
- 波段个数：140个
- 发射功率：不高于20dBm
- 2.4G模式：第二代自动跳频数字系统
- 编码方式：GFSK
- 通道分辨率：1024级
- 低电压报警：有（低于3.75伏时）
- 数据输出：有（USB，HID）
- SD卡接口：有
- 天线长度：26mm（双天线）
- 机身重量：653.5g(含电池)
- 输入电源：3.7伏（1700毫安时）
- 外形尺寸：102mm*96mm*53mm
- 外观颜色：银色
- 认证：CE0678，FCC

Transmitter specifications:

- Channels: 10
- Model type: helicopter/ airplane/ glider
- RF range: 2.405.5-2.475GHz
- Bandwidth: 500KHz
- Band: 140
- RF power: less than 20 dBm
- 2.4G system: AFHDS2
- Code type: GFSK
- Sensitivity: 1024
- Low voltage warning: yes (less than 3.75V)
- DSC port: yes(USB, HID)
- SD port: yes
- ANT length: 26mmx2
- Weight: 653.5g (Include Battery)
- Power: 3.7V (1700mAh)
- Size: 102mm*96mm*53mm
- Color: Silver
- Certificate: CE0678, FCC

AFHDS 2A
 AUTOMATIC FREQUENCY HOPPING DIGITAL SYSTEM
MODEL: FS-110

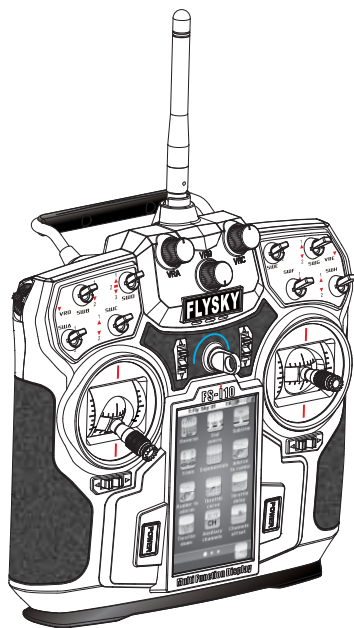

10. 接收机参数 Receiver specifications

机种参数：

- 通道个数：10
- 适合机种：直升机、固定翼、滑翔机
- 频率范围：2.405.5-2.475GHz
- 波段个数：140个
- 发射功率：不高于20dBm
- 接收灵敏度：-105DBm
- 2.4G：第二代自动跳频数字系统
- 编码方式：GFSK
- 天线长度：26mm（双天线）
- 输入电源：4.0-6.5V/DC
- 机身重量：19g
- 外形尺寸：47mm*33.5mm*15mm
- 外观颜色：黑色
- 认证：CE0678，FCC
- i-BUS 接口：有
- 数据采集接口：有

Specifications:

- Channels: 10
- Model type: helicopter/ airplane/ glider
- RF range: 2.405.5-2.475GHz
- Band: 140
- RF power: less than 20 dBm
- Sensitivity: -105DBm
- 2.4G system: AFHDS2
- Code type: GFSK
- ANT length: 26mmx2
- Power: 4.0-6.5V/DC
- Weight: 19g
- Size: 47mm*33.5mm*15mm
- Color: Black
- Certificate: CE0678, FCC
- i-BUS Port: yes
- Date Acquisition port: yes

AFHDS 2A
 AUTOMATIC FREQUENCY HOPPING DIGITAL SYSTEM
MODEL: FS-iA10

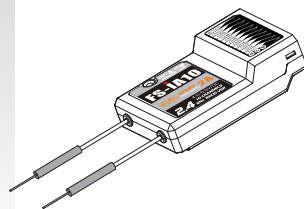

Digital proportional radio control system FS-i10

10. 01. 磁感应速度采集模块 RPM Telemetry (magnetic) module

机种参数 :	Specifications:
<ul style="list-style-type: none"> ● 适合机种 : i系列 ● 采集速度范围 : 0-16000转/分钟 ● 机身重量 : 3.9g ● 输入电源 : 4.0-6.5V/DC ● 外形尺寸 : 24.4*14*8毫米 ● 外观颜色 : 黑色 	<ul style="list-style-type: none"> ● Model type: helicopter/ airplane/ glider ● Monitor range of speed: 0-16000RPM ● Weight: 3.9g ● Power: 4.0-6.5V/DC ● Size: 24.4*14*8mm ● Color: Black



10. 02. 光感应速度采集模块 RPM Telemetry (optical) module

机种参数 :	Specifications:
<ul style="list-style-type: none"> ● 适合机种 : i系列 ● 采集速度范围 : 0-16000转/分钟 ● 机身重量 : 3.9g ● 输入电源 : 4.0-6.5V/DC ● 外形尺寸 : 24.4*14*8毫米 ● 外观颜色 : 黑色 	<ul style="list-style-type: none"> ● Model type: helicopter/ airplane/ glider ● Monitor range of speed: 0-16000RPM ● Weight: 3.9g ● Power: 4.0-6.5V/DC ● Size: 24.4*14*8mm ● Color: Black



10. 03. 温度采集模块 Temperature telemetry module

机种参数 :	Specifications:
<ul style="list-style-type: none"> ● 适合机种 : i系列 ● 采集温度范围 : -40-100摄氏度 ● 机身重量 : 3.9克 ● 输入电源 : 4.0-6.5V/DC ● 外形尺寸 : 24.4*14*8毫米 ● 外观颜色 : 黑色 	<ul style="list-style-type: none"> ● Model type: helicopter/ airplane/ glider ● Monitor range of temperature: -40-100°C ● Weight: 3.9g ● Power: 4.0-6.5V/DC ● Size: 24.4*14*8mm ● Color: Black



10. 04. 电压采集模块 Voltage telemetry module

机种参数 :	Specifications:
<ul style="list-style-type: none"> ● 适合机种 : i系列 ● 电压采集范围 : 4.0-30V/DC ● 机身重量 : 3.9克 ● 输入电源 : 4.0-6.5V/DC ● 外形尺寸 : 24.4*14*8毫米 ● 外观颜色 : 黑色 	<ul style="list-style-type: none"> ● Model type: helicopter/ airplane/ glider ● Monitor range of Voltage: 4.0-30V/DC ● Weight: 3.9g ● Power: 4.0-6.5V/DC ● Size: 24.4*14*8mm ● Color: Black



10. 05. i-BUS 串行总线接收机 i-bus receiver

机种参数 :	Specifications:
<ul style="list-style-type: none"> ● 通道个数 : 4 ● 适合机种 : i系列 ● 机身重量 : 6.7克 ● 输入电源 : 4.0-6.5V/DC ● 外形尺寸 : 30*25.6*13毫米 ● 外观颜色 : 黑色 ● i-BUS 接口 : 有 	<ul style="list-style-type: none"> ● Channels: 4 ● Model type: helicopter/ airplane/ glider ● Weight: 6.7g ● Power: 4.0-6.5V/DC ● Size: 30*25.6*13mm ● Color: Black ● i-BUS Port: yes

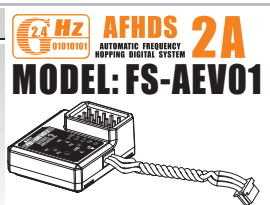

11. 接收机与伺服器连接 Receiver and servo connections



为了让发射及接收距离更远，请注意以下几点：

- 1、尽量保证双天线笔直，否则将会减小控制范围；
- 2、双天线的夹角保持在 90° (如图三种方式)，这并不是精确的垂直角度，重要的是尽可能保持天线互相远离；
- 3、天线应该尽可能远离金属导体，至少要有1.5cm左右的距离。轴电缆段不受此限制，但不要过度弯曲；
- 4、尽可能保持天线远离电动机、调速器，和其它的噪声源。

In order to make sure maximum distance between the transmitter and receive can be obtained please follow the directions below:

1. The two antennas must be kept as straight as possible. Otherwise, control range will be reduced.
2. The two antennas should be placed at a 90 degree angle to each other, as illustrated in the three pictures below.
3. The antennas must be kept away from conductive materials, such as metal and carbon. A distance of at least 15 cm is required for safe operation. Conductive materials will not affect the coaxial part of the antenna, but it is important that the coaxials are not bent to a severe radius.
4. Keep antennas away from the motor, speed controller and other noise sources as much as possible.

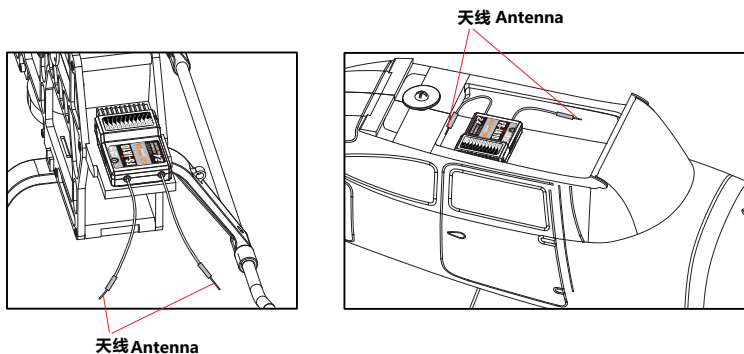
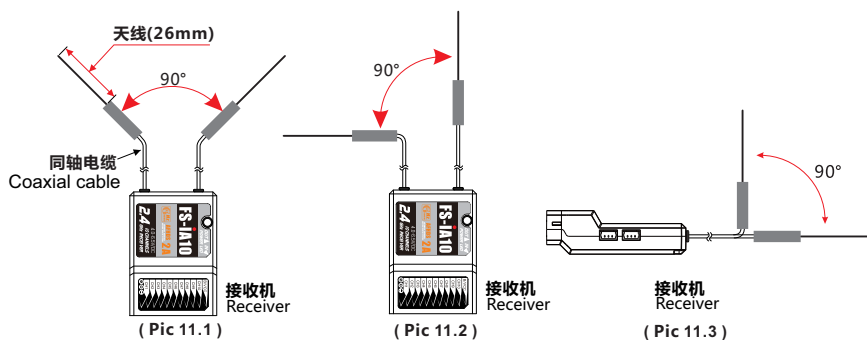

Digital proportional radio control system FS-110

11.01 飞机模型的安装 Airplane model installation

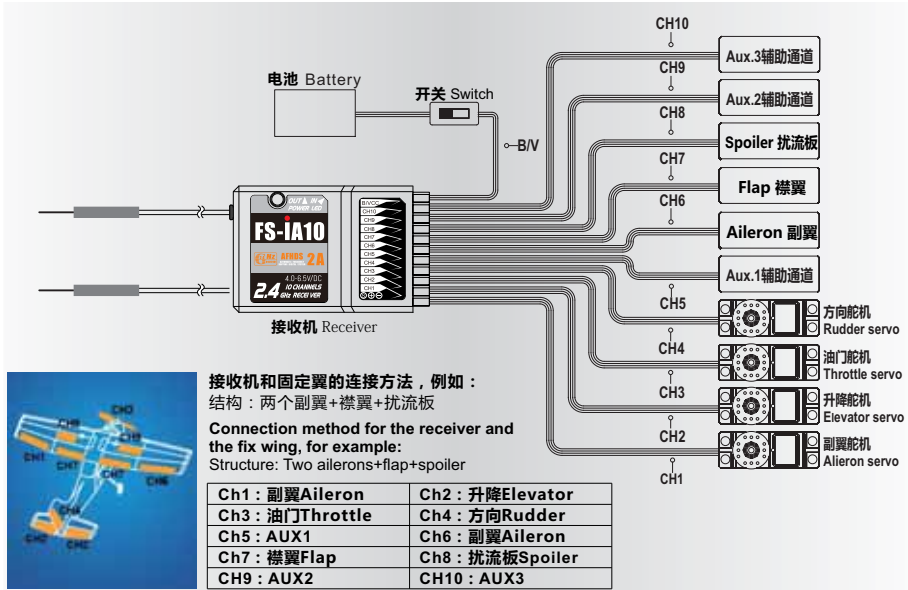

11.02 直升机模型的安装 Helicopter model installation

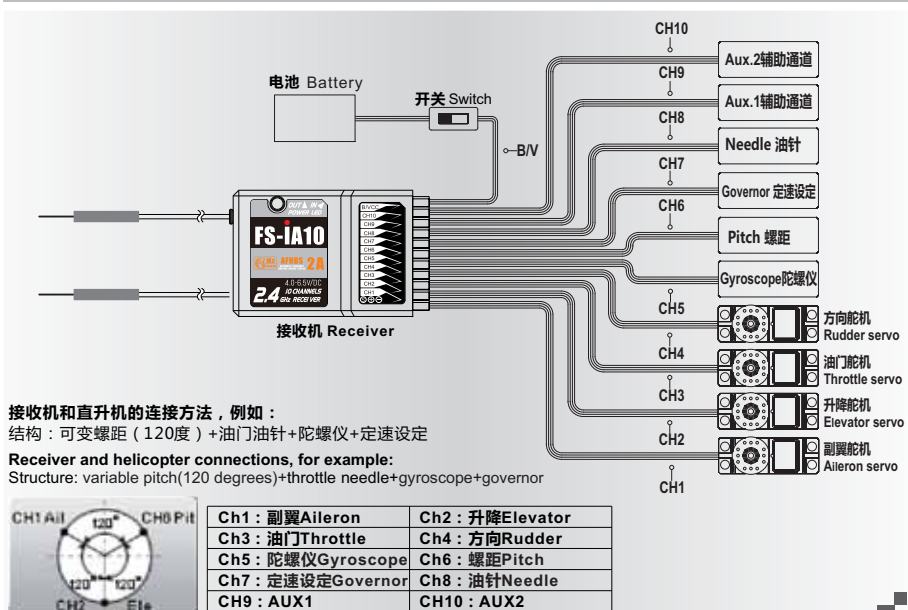

12. 接收机操作说明 Receiver operation instruction

12.01 接口说明 Port Setup

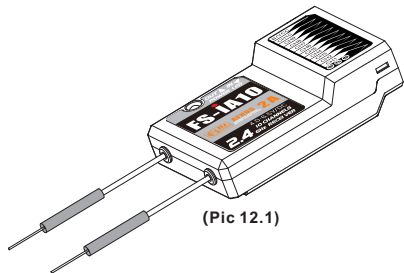

(Pic 12.1)

CH1-CH10 : 表示接收机的相应通道 ;
Bind,VCC : 表示用于对码和输入电源的通道 ;
OUT : 表示输出PPM数据的I-BUS接口, 用于连接串行总线接收机, 扩展通道 ;
IN : 表示各种传感器数据的输入接口, 数据采集模块可随意串接 ;

CH1-CH10: represent relevant channel of transmitter.
Bind,VCC: represent the channel used for matching and input power respectively.
OUT: Represent i-BUS port of outputting PPMs data and be used for connecting the serial bus receiver to expand channels.
IN: Represent input ports of all kinds of sensor data, and data acquisition modules can be connected in serial optionally.

12.02 对码 Binding Setup

所有的发射机和接收机, 在出厂前都已对码, 无需再次对码, 若您需要与另一发射机进行对码和使用, 请按以下方法操作:

1. 发射机装上电池, 打开电源;
2. 进入主界面, 选择**接收机设置**功能。点触**对码**进入对码状态;
3. 用产品包装所配的对码线, 插入接收机B/VCC通道;
4. 使用4.0-6.5VDC电源, 按正确极性, 插入CH1- Ch10的任一通道, 即可进入对码状态, 此时LED灯闪烁;
5. 成功对码后, 发射机会自动退出对码状态;
6. 拔掉对码线, 重启接收机LED常亮, 此时即可插入舵机及其它数据采集模块, 检测其工作是否正常;
7. 如果对码失败, 可重复以上动作, 重新对码。

All receivers are bound to their respective transmitter at production time. If you want to bind it with another transmitter, please follow the steps below:

1. Install the battery in the transmitter, and turn on the power.
2. Open the main menu, and select "RX setup" function in the second page, then touch "Bind with a receiver" to enter bind mode.
3. Insert the standard bind cable into the power supply channel.
4. Connect the 6VDC power connector to any channel from CH1 to CH10 with correct polarity to enter bind mode, The receiver LED will flash at this time.
5. The transmitter will exit the bind mode automatically after having successfully bound with the transmitter.
6. Pull off the bind cable and restart the receiver. Please connect the servos and other telemetry modules to the receiver to check if everything operates normally.
7. If anything is wrong, please repeat the above steps to bind again.



注意: 配对好的发射机与接收机, 当发射机或接收机因误操作而进入对码状态后, 会出现不能遥控的现象, 一般情况下, 关闭电源重启机即可恢复正常, 倘若还是不行, 则需要重新对码。

Notice: The bound transmitter and receiver will work abnormally if the transmitter or the receiver enters the binding state by mistake. In other words, the receiver cannot be controlled by the transmitter. If so, you need to restart the transmitter and the receiver.

Attention

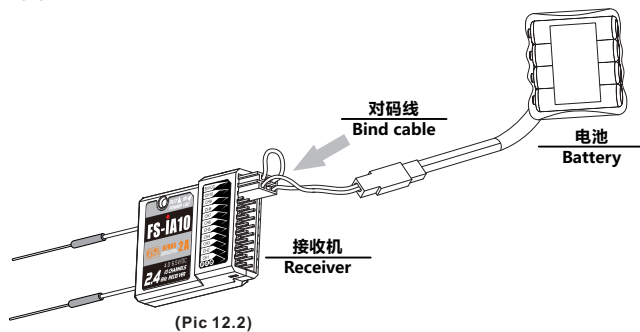

(Pic 12.2)



12.03 FS-AEV01 i-BUS 串行总线接收机连接说明 i-bus Receiver Connection instruction Setup

功能说明：

此功能是为了应对某些模型通道太多而做的，当通道不够时可采用此配件来增加通道输出。

串行总线接收机，最多可串联4个模块，共18个通道；按键K1-K4分别对应C1-C4。用于对相应通道的设定；

操作说明：

1. FS-SEV01 i-BUS接收机的“IN”端口对应接收机的“OUT”端口；
2. FS-SEV01 i-BUS接收机的“OUT”端口，用于串接后级的FS-SEV01接收机，以串联的方式使用。
3. 将此总线接收机插入接收机，打开已配对的发射机，接收机电源，LED点亮；
4. 操作发射机触控屏，选择接收机设定的主菜单，进入到舵机设定界面；
5. 选择需要扩展的通道，此时，总线接收机的LED熄灭；
6. 用对码线上的胶针，按下需要的，相应通道的按键，LED自动点亮，表示设定成功；
7. 插入舵机，检查设定是否成功；
8. 重复以上操作即可完成总线接收机4个通道的设定；
9. 当需要更多的通道扩展时，只需要在第一级总线接收机的“OUT”端口，串接新的总线接收机即可，设定的操作方法相同。

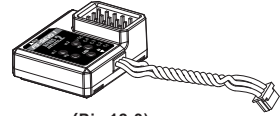

(Pic 12.3)

Function Details：

The system is able to support many channels. This allows the user of the system to change to a different output channel should signal strength be insufficient

i-BUS receiver, can connect 4 modules with 18 channels in serial at most. Button K1 and K4 correspond to C1 and C4 respectively.

Operation instruction:

1. FS-SEV01 i-BUS The "IN" port of FS-SEV01 receiver corresponds to "OUT" port of receiver.
2. FS-SEV01 i-BUS The "OUT" port of FS-SEV01 receiver is used to connect post level FS-SEV01 receiver.
3. Insert the bus receiver to receiver, and then switch on the matched transmitter and receiver. The LED will be on.
4. Select main menu of receiver setup to enter the interface of servo setup.
5. Select channel which need to be expanded, meanwhile LED of bus receiver is off.
6. Push relevant channel button by plastic needle of matching line. The setup is successful if LED flashes automatically.
7. Insert servo to check.
8. Set up 4 channels of bus receiver as above steps.
9. Just connect a new bus receiver with "OUT" port of first stage bus receiver if more channel needed. Set up the new one as above steps.



注意：当总线接收机的负载过重，电流较大时，请将主接收机的电源分支出来并联接入，单独供电加大负载的能力，否则可能会因电流过大，烧坏串联的线材。

Danger

Notice: When the load of serial bus receiver is excessive and electric current is higher than usual, please supply power directly to the serial bus receiver or it will break cables.

12.04 FS-APD01 磁感应转速采集模块 RPM telemetry (magnetic) module setup

功能说明：

此功能是为了检测到模型的转速而设定的，用户可通过发射机来观察监测模型的转速，当用户需要监测转速时可使用此配件。

操作使用说明：

1. 将所配的3 PIN插头，一端插入**速度采集模块**的“OUT”位置，另一端插入接收机的“IN”位置或接另外的感应器的“IN”位置，如图12.4所示；
2. 如图12.5所示，将传感器放在磁铁的旁边，磁铁固定在需要测试的轴向转动的地方，如直升机的齿轮上面，传感器与磁铁相距两毫米以内，磁铁的南极或北极与传感器保持平行。
3. 打开发射机，接收机电源，在显示屏的接收机窗口内，会发现并显示“Motor speed 2.0RPM”，试着转动，转速的值会发生变化，则表示安装成功。



(Pic 12.4)

Function Details：

This function allows the user to monitor turning speed via the transmitter. This is a very useful function when determination of turning speed is required

Operation:

1. Insert one end of standard 3 PIN plug into "OUT" port of **RPM telemetry (magnetic) module**, and insert the other end into "IN" port of receiver or other sensor, as shown in the picture 12.4.
2. As shown in the picture 12.5: Inside the hub of the model, the distance between sensor and magnet is less than 2mm. The North Pole or the south pole of the **magnet** has to be parallel with sensor.
3. Switch on transmitter and receiver. "Motor speed 2.0RPM" will be shown in receiver window in display screen. Speed value changes as turning wheel, which means installation is successful.

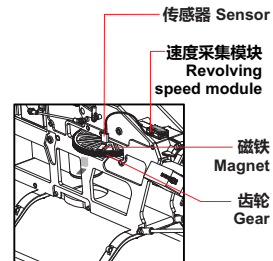

(Pic 12.5)

12.05 FS-AP002 光感应转速采集模块 RPM Telemetry (optical) module setup

功能说明

此功能是为了能检测到模型的转速而做的，用户可通过遥控器来观察和监测模型的转速，当用户需要监测转速时，可使用此配件。

操作使用说明

1. 将所配的3PIN插头，一端插入速度采集模块的“OUT”位置，另一端插入接收机的“IN”位置或接另外的感应器的“IN”位置，如图12.6所示；
2. 如图12.7所示，将传感器与反射贴纸固定在测试的轴向转动，如安装在飞机的螺旋桨上，保持贴纸平整，并与传感器垂直，传感器和贴纸距离要保持适中。
3. 打开发射机，接收机电源，在显示屏的接收机窗口内，会发现并显示“Motor speed 2 : 0RPM”，试着转动，转速的值会发生变化，则表示安装成功。

Function Details :

This function allows the user to monitor turning speed via the transmitter. This is a very useful function when determination of turning speed is required

Operation instruction :

1. Connect one end of the standard 3 PIN plug to the "out" port of the speed telemetry module and the other end to the "in" port of the receiver or the previous sensors "in" port as shown in the picture 12.6.
2. As shown in the picture 12.7: Affix the sensor and the reflection decals on the flat surface of the side of any rotating part. Keep decals flat and perpendicular to the sensor. Maintain sufficient safety distance between the sensor and the decals to avoid any damage.
3. Switch on the transmitter and the receiver. "Motor speed 2 : 0RPM" will be displayed in the main screen. The speed displayed will follow the speed of the rotating part monitored by the rotation speed sensor, indicating a successful installation.

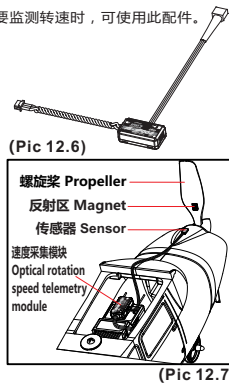

12.06 ATM01 温度采集模块连接 Temperature telemetry module connection setup

功能说明：

此功能是为了监测模型重要部件（马达，电池，调速器）温度而做的，用户可通过遥控器来观察和监测重要部件的温度，必要时可设定报警。当用户需要检测重要部件温度时可使用此配件。

操作使用说明：

1. 将所配的3 PIN连接线，一端插入温度采集模块的“OUT”位置，另一端插入接收机的“IN”位置或接另外的感应器的“IN”位置，如图12.8所示；
2. 将温度的传感器本体，使用海绵双面胶粘在适当的位置（如：马达，电池本体上），并与被测物体表面紧贴；
3. 打开发射机，接收机电源，在显示屏的接收机窗口内，会发现并显示“Temperature 1 : 25.0°C”，表示安装成功，25.0°C即为采集到的温度数据。

Function Details :

This function allows the user to monitor the temperature of important operating parts of the system.

This will ensure that the user can be aware of any severe temperature changes which would adversely affect system operation. The system will automatically set an alarm if the temperature is outside of safe operating norms

Operation instruction :

1. Insert one end of standard 3 PIN plug into "OUT" port of temperature module, and insert the other end into "IN" port of receiver or other sensor, as shown in the picture 12.8.
2. Adhere temperature sensor to proper place (such as motor and battery) tightly by sponge double stick.
3. Switch on transmitter and receiver. "Temperature 1:25.0°C" will be shown in receiver window in display screen, which means installation is successful, and 25.0°C is the temperature collected.

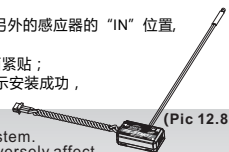

12.07 FS-AVT01 电压采集模块连接 External voltage telemetry module connection setup

功能说明：

此功能是为了监测模型电池电压的，用户可通过遥控器来观察和检测电池的电压情况，必要时可进行设定报警。用户需要观察和监测电池电压时可使用此配件。

操作使用说明：

1. 将所配的3 PIN连接线，一端插入电压采集模块的“OUT”位置，另一端插入接收机的“IN”位置或接另外的感应器的“IN”位置如图12.9所示；
2. 打开发射机，接收机电源，在显示屏的接收机窗口内，会发现并显示“Ext.voltage4:0V”，表示安装成功；
3. 将用于检测的红黑线插针分别插入电池的插头内，红色线为正极，黑色线为负极，如图12.9所示：在显示屏的接收机窗口内，显示“Ext.voltage4:12.40V”，表示已检测到外部的电池电压为：12.40V。

注意：用于检测的红黑线，不能接反，否则会损坏接收机。

注意：请不要将采集模块的“IN”和“OUT”接反，否则发射机将无法识别到该模块及相连的后面的模块的编号。

Function Details :

This function allows the user to monitor the battery voltage of the system. This will ensure that the user can be aware of any severe voltage changes which would adversely affect battery operation. The system will automatically set an alarm if the voltage is outside of safe operating norms

Operation instruction :

1. Insert one end of standard 3 PIN plug into "OUT" port of external voltage module, and insert the other end into "IN" port of receiver or other sensor, as shown in the picture 12.9.
2. Switch on transmitter and receiver. "Ext.voltage4:12.40V" will be shown in receiver window in display screen, which means the installation is successful.
3. Insert red and black contact pin into battery port respectively. The red one is positive pole and the black one is negative pole. as shown in the picture 12.9 "Ext.voltage4:12.40V" is shown in the receive widow in display screen, which means the tested voltage is 12.40V.

Notice: The polarity of red and black line can not be reversed, or the receiver will be damaged.

Notice: Be sure the IN and OUT ports are connected correctly. Improper connections will cause the transmitter to be unable to distinguish between telemetry modules.

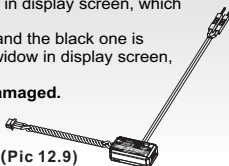

Digital proportional radio control system FS-i10

13. 遥控器各部件说明 Control Parts Descriptions

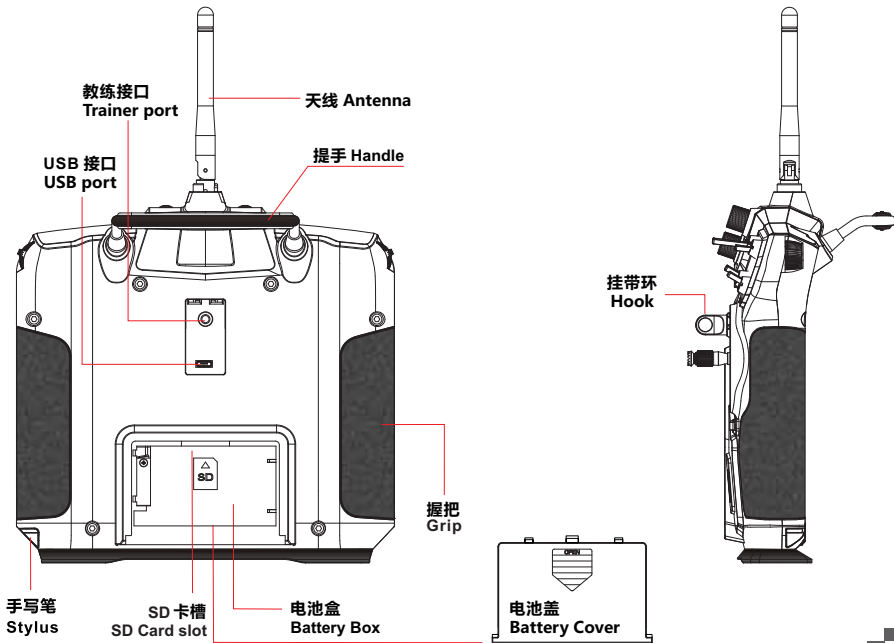
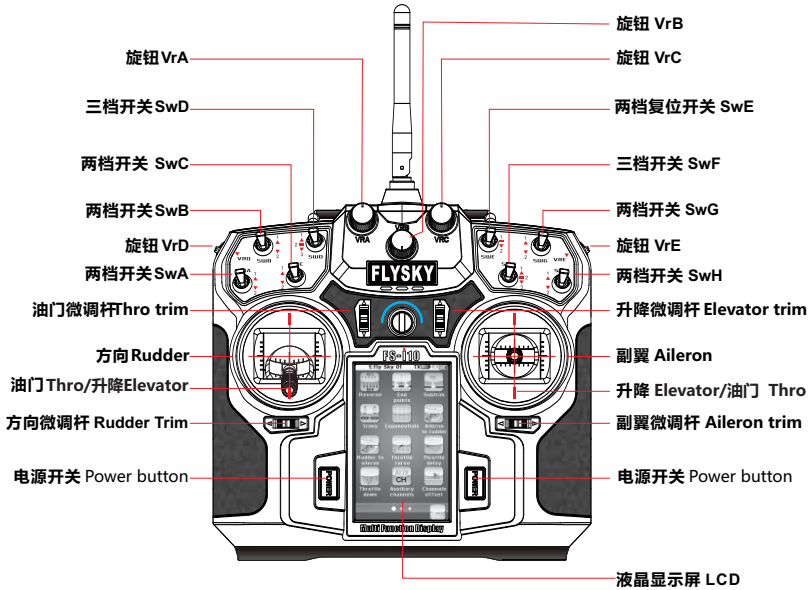

14. 摇杆模式调整 Stick mode adjustment

功能说明：

此功能是针对不同用户的不同操作习惯而设定的，用户可通过以下操作方式进行调整

将发射机默认摇杆模式调整为1、3、4；

步骤如下：

- 1、点触系统选择**摇杆模式**，可见摇杆模式默认为**模式2** (如图14.1)；
- 2、**模式4**调整：由**模式2**切换为**模式4**即可 (如图14.2)；
- 3、**模式1、3**调整
 - 1)、切换为**模式1**或**模式3** (如图14.3, 14.4)；
 - 2)、打开发射机的**电池盖**，取下**电池**；
 - 3)、拨下发射机**左右握把**；
 - 4)、用**内六角螺丝刀**卸下锁住发射机后盖的**6颗螺丝** (如图14.5)，并妥善放置；
 - 5)、轻轻地拨下发射机后盖**电线插头**，即可看到和 (图14.6) 一样的布局；
 - 6)、用**小型十字螺丝刀**卸下**总成8颗螺丝**，并妥善放置；
 - 7)、将**左右总成座**互换位置旋转180度，排好电线，并锁紧螺丝；
 - 8)、将发射机后盖**电线插头**小心地插入主板，重新合上发射机的后盖，并锁紧**螺丝**；
 - 9)、装上**左右握把**，装入**电池**，盒上**电池盖**；
 - 10)、打开发射机点触**显示器舵机**检查通道及方向是否正确，拨动**微调杆**检查**微调**及方向是否正确。



(Pic 14.1)

(Pic 14.2)

Stick Mode Adjustment

The mode can be changed based on user preferences

The instructions for changing default mode 2 are detailed below:

1. Touch system option to select the stick mode as shown in picture 14.1.
2. Change mode to 4.
3. Adjustment of mode 1 and mode 3 as shown in pictures 14.3 and 14.4
 - 1). Change mode 1 and mode 3 to mode 1 or mode 3.
 - 2). Open the battery box and remove the battery.
 - 3). Remove the transmitters left and right grips.
 - 4). Use the inner hexagonal screwdriver to remove the six screws on the back of the transmitter and put them in a safe place as shown in picture 14.5.
 - 5). Disconnect the transmitter back cover plug carefully and you will see the layout as shown in picture 14.6.
 - 6). Remove the eight screws with a small cross screwdriver and put them in a safe place.
 - 7). Switch the left and right gimbal, rotate 180 degrees, adjust the wire and then lock the screw.
 - 8). Insert the transmitter back **cover wire** to main board. Then close the back cover and lock the **screw**.
 - 9). Install the **left and right grip**, and then install the battery. After that, close the battery cover.
 - 10). Turn on the transmitter to ensure the channel and direction are working correctly by touching the servo display. Check the trim direction by sliding the trim.



(Pic 14.3)

(Pic 14.4)

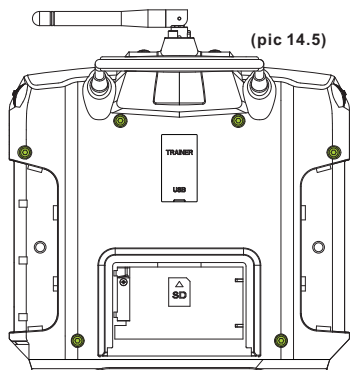

● 6颗螺丝
six screws

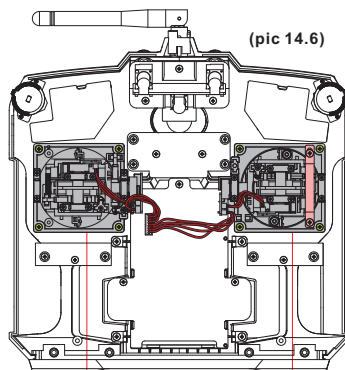

右总成座 ● 8颗螺丝 左总成座
right gimbal eight screws left gimbal

15. 开机 Power On

1. 连接好所有部件，
2. 按住两个电源开关，打开发射机，
3. 接通接收机电源，
4. 接收机红色指示灯常亮说明信号连接正常，
5. 发射机的误码率小于5%，接收信号强度稳定 (TX/RX电量充足时)，
6. 操作系统可以使用。

1. Connect all parts,
2. Press the two power buttons to power on the unit. Switch on the transmitter,
3. Connect the receiver battery,
4. The receiver red LED indicator is solid indicating the presence of a correct signal,
5. When the error rate of transmitter is less than 5%, the signal of receiver is stable,
6. Use the radio system.



(pic 15.1)



开机
Power on

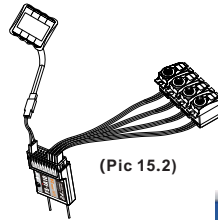

(Pic 15.2)

15.01 开机异常保护 Boot Abnormal Protection

如果开机时遇到如图所示界面时,说明有如下情况出现需解决后才能正常开机

1. 开关没有复位(往上).
2. 油门操纵杆没有最低

If the screen looks like picture 15.1.1, there is a system problem. You must resolve the problem before restarting the system

1. The switch is not reset. (You need to push switch up.)
2. Thro Stick (Push to lowest setting)

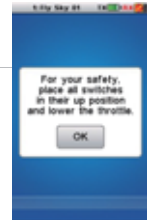

(pic 15.1.1)

16. 关机 Power off

1. 断开接收机电源，
2. 按住两个电源开关，关闭发射机。

1. Cut off power source of receiver,
2. Press the two power buttons to power off the unit. Switch off the transmitter.

注：未断开接收机电源，发射机电源是无法关闭的。

Attention: transmitter cannot be turned off if the power source of receiver is not cut off.

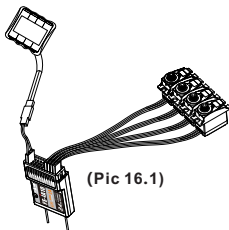

(Pic 16.1)



关机
Power off

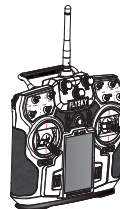

(Pic 16.2)

16.01 关机异常保护 Shutdown Abnormal Protection

如果关机时遇到如图所示保护界面时,说明接收机还没有关闭,您需先关闭接收机后,才能关闭发射机。

If the screen looks like picture 16.1.1 you need to turn off the receiver first and then turn off the transmitter



(Pic 16.1.1)

17. 开机画面 Logo/Information Screen

开机画面显示了富斯公司的标志，两秒后画面自动进入到主菜单。主菜单显示的具体内容如下图：

The FlySky logo will be shown on the screen when first switching on the transmitter. After two seconds the main menu will be displayed.



(Pic 17.1)



(Pic 17.2)

18. 主菜单 Main menu



(Pic 18.1)



(Pic 18.2)



(Pic 18.3)



(Pic 18.4)

点触屏幕下方的设置图标  进入主菜单。

主菜单有三个平行页面组成，每个页面包含最多12个图标，分别代表12个不同的功能。

主菜单图标默认为26个，具体数量会根据飞机结构的不同发生变化，最少21个，最多或33个

- 屏幕底部的白色球体表示显示的菜单页面，大的白色球体代表当前显示的页面。
- 点触当前页的任何位置由右向左滑动可显示下一页。
- 点触当前页的任何位置由左向右滑动可显示上一页。
- 点触相对应的图标可进入该功能。

点触底部的文件盘上的返回图标  可返回主屏幕。

The main menu can be accessed by touching the settings icon  at the bottom of the main screen.

The main menu is organized in horizontal pages. Each page contains up to 12 icons representing 12 different functions.

The main menu has 26 icons by default, but may have as few as 21 or as many as 33, depending on the model of the aircraft

- The white balls in the bottom tray indicate which menu page is displayed.
- The big white ball represents the currently displayed page.
- To display the next page, touch the current page anywhere on its right part and slide it to the left.
- To display the previous page, touch the current page anywhere on its left part and slide it to the right.
- To enter a function, simply touch its corresponding  icon.

To return to the main screen, touch the back button in the bottom tray.

19. 顶部状态栏 System Status



屏幕顶部一直显示整个系统的主要状态。

The System Status of the screen constantly displays the main status of the whole system.

显示接收机电池的状态。如果电压太低，可听见警报，并且这个图标将闪烁。
如何设置接收机电池低电压报警将在后文说明。

Displays the status of the receiver battery. If the voltage is too low, an audible alarm rings and this symbol blinks.
See further how to set up the receiver battery alarm voltage.

显示发射机电池的状态。如果电压太低，可听见警报，并且这个图标将闪烁。

Displays the status of the remote control battery. If the voltage is too low, an audible alarm rings and this symbol blinks.

显示当前选定的模型编号和名称。

Displays the number and the name of the currently selected model.

显示模型接收到信号的强度。最强信号是5格，当信号强度等于或低于2格，将听到警报。

Displays the signal strength received by the vehicle.
The strongest signal is represented with 5 bars, when the signal strength is lower or equal to two bars, an audible alarm rings.

 充电中 Charging

 电量饱满 Fully charged

 充电完成 Charging is complete

 电量低 (需要充电) Low battery (Needs charging)

 表示接收机没有连接 Receiver disconnected

 表示接收机电量饱满 Receiver battery fully charged

 表示发射机收不到接收机的电流、电压返回信号,此时请检查外部传感器的连接是否正确。

No signals of current and voltage of receivers (Needs checking the connection of sensors)

20. 功能操作 General Functions Description

20.01 功能介绍 Introduction



(Pic 20.1)

所有的功能使用一套标准的用户界面对象。

屏幕底部包含以下图标：

All functions use a set of standard user interface objects.
The bottom tray can contain the following buttons:

返回图标用于返回上一页面。

The back button returns to the previous screen.

默认图标可将当前页参数恢复到默认值。

The default button sets back the current page parameters to their default values.

一些功能需分配**开关**、**逻辑开关**、**摇杆**或**旋钮**来控制。有些功能需分配**开关**或**逻辑开关**来开启/关闭,有些功能需分配**摇杆**或**旋钮**来调节参数

Some functions require usage of 1-4 as stated in 20.02 below to enable proper control.

Some functions require usage of 1 and 4 as stated in 20.02 below to turn on or off.

Some functions require usage of 2 and 3 as stated in 20.02 below to adjust parameters.

这两个按钮代表当前功能开启和关闭。

当您点击此图标时会出现如下对话框 当前功能开启 当前功能关闭

These 2 buttons respectively enable and disable the current function.

When you touch this icon the turn on and turn off icons will be displayed

20.02 开关功能说明 Switch Function Details:



(Pic 20.2)

1 分配**开关** (SwA~SwH) 定义功能开启/关闭, 可点开关方向为**向下**、**中间**或**向上**为开启。

Choose one switch direction from upward direction, middle direction and downward direction as the open status when the switches (SwA~SwH) are assigned to enable or disable functions.

2 分配**摇杆** (Ail、Ele、Thro、Rud) 调节功能的比率, 将会模拟**摇杆**成线性变化。

The sticks(Ail、Ele、Thro、Rud) are assigned to adjust the function rates.

3 分配**旋钮** (VrA~VrE) 调节功能的参数, 将会成线性变化。

The knobs (VrA ~ VrE) are assigned parameters to adjust the function rates.

4 分配**逻辑开关** (LSW, LS1~LS3) 定义功能开关/关闭, 逻辑开关功能见 **Pic 20.2**

The logic function needs to be defined at first when logic switches (LSW,LS1~LS3) are assigned to enable or disable functions. Logic switches function as shown in picture 20.2

如图**Pic 20.2**所示, 为默认四通道飞机结构, CH5辅助通道。

Picture 20.2 shows the default four channel aircraft structure and CH5 auxiliary structure

20.03 复位功能说明 Reset Function Details:

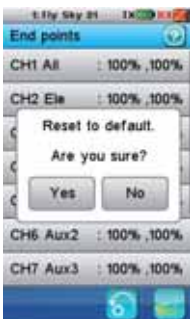

(Pic 20.3)

当您点击此图标时会出现如下对话框:

是: 返回到默认值

否: 无操作

Pressing this icon will display screen as shown in picture 20.3

Yes: reset to default the current displayed function

No: no operation

菜单右上角 点开可获得帮助信息

Please touch the in the top right corner to get help information

备注: 做出确定时您要小心, 它会将此功能的参数全部恢复到出厂值。

Please use this function with care, as this will reset all parameters to factory settings and you will lose any changes you have made



20.04 帮助功能说明 Online Help Function Details:

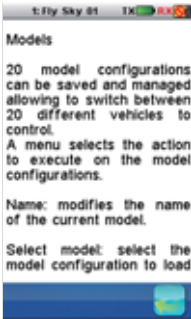

(Pic 20.4)

标题栏显示当前功能或菜单。

A title bar displays the name of the current function or menu.

点触标题栏右边的问号可获得操作提示。

A white question mark on the right of a title bar indicates that contextual help is available. Touch the question mark to see the help details.

点触下方任意方向向上滑动，帮助页面将会向下滚动。

点触下方任意方向向下滑动，帮助页面将会向上滚动。

点触页面下方的返回图标回到上一功能。

To scroll down a help page, touch the bottom of the page and slide up.

To scroll up a help page, touch the top of the page and slide down.

Touch the back button in the bottom tray to return to the function page.

20.05 上下滑动菜单说明1 Scrolling Menu Details:



(Pic 20.5)

可以选择垂直方向的菜单其中一个选项即可进入下一级菜单或者对其某些功能做直接选定确认。

To select an option use the vertical menu.

此示例显示System设置。右边灰色竖条说明菜单的长度和当前位置。

This example selects the System option.

The gray vertical bar on the right is used for scrolling.

点触下方任意方向向上滑动，垂直方向的菜单向下滚动。

点触上方任意方向向下滑动，垂直方向的菜单向上滚动。

点触选定的菜单项即可完成选择。

To scroll down the vertical menu, touch it at the bottom and slide up.

To scroll up the vertical menu, touch it at the top and slide down.

To select a menu item, simply touch it.

例1：怎样开启或关闭声音

Example one :How to turn on or off sound



(Pic 20.6)

关闭声音
No sound



(Pic 20.7)

开启声音
Sound enabled

例2：怎样进入下一级子菜单

Example two : How to enter the next submenu

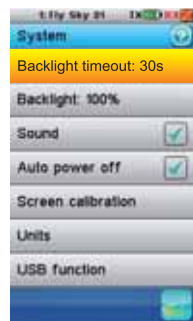

(Pic 20.8)

调整背光时间
Set backlight timeout

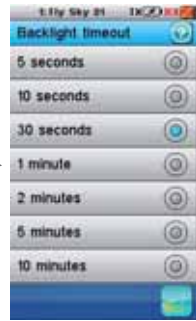

(Pic 20.9)

20.06 上下滑动菜单说明2 Vertical Scrolling Function Details:



(Pic 20.10)

此类菜单是针对有多个选项菜单的操纵方式

This is the default menu for selecting system parameters

此示例显示Select model设置。右边灰色竖条说明菜单的长度和当前位置。

This example selects the sytem parameter to set.

The right gray vertical bar indicates the lengths of the menu and the current position in it.

点触下方任意地方向上滑动，垂直方向的菜单向下滚动。

点触上方任意地方向下滑动，垂直方向的菜单向上滚动。

点触选定的菜单项即可完成选择。

To scroll down a vertical menu, touch it anywhere on its bottom and slide it up.

To scroll up a vertical menu, touch it anywhere on its top and slide it down.

To select one of the menu items, simply touch it.

蓝色球体代表当前选择的选项，如需选择其它的选项，只需点击该选项。

The blue ball indicates the currently selected value. To select another value, simply touch it.

例如：如图20.10所示,表示当前选定的是Fly Sky 01项

For example : picture 20.6 has selected the Fly Sky 01 option

20.7 多项功能设定对话框功能操作说明 Multi-function dialog settings:



(Pic 20.11)

大部分功能是通过对话框设置的。

对话框包含一套不同的对象。

点触一个按钮将执行或选择相对应的功能。

Most functions are set using a dialog box.

A dialog box contains a set of different objects.

Touching a button will execute or select the function associated to it.

此图包含了以下内容：

This example contains the following objects:

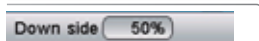

(Pic 20.12)

被选择的参数数值将会显示在对话框上端的数值框内。

The value of the selected parameter is displayed in the value box on the top of the dialog box.



(Pic 20.13)

图示为当前舵机端点位置

Servo end point position



(Pic 20.14)

低端和高端按钮是选择需调整的参数。

点触按钮即可激活该功能。

被选中功能的图标显示为黄色。

The 2 buttons "down side" and "up side" select the parameter to modify.

To activate a button, simply touch it.

The selected option is highlighted in yellow.



(Pic 20.15)

图示为当前通道输出值

Channel - Aileron output value



(Pic 20.16)

页面底部的转轮用于调整被选参数数值。

向左滑动转轮可减少参数值，向右转动滑轮可增加参数值。

The wheel at the bottom allows modification of the selected parameter value.

To decrease the parameter value, touch the wheel any where on the right and slide it to the left. To increase the parameter value, touch the wheel anywhere on the left and slide it to the right.

21. 通用功能菜单 General function menu

21.01. 正逆转 Reverse

功能说明：

此功能主要是针对不同类型的舵机其通道输出方向不同，以及不同机种的安装方式的不同，而做的一个配套功能。用以调整舵机及通道的输出方向。此功能对任一通道都可以做调整，最终使所有通道输出达到控制要求！

正逆转功能可分别逆转10个通道的舵机方向。

点触**正逆转**下需设置的通道，包括10个复选框勾选后，即可实现该通道方向逆转。

如图21.1所示：只有CH3是反向的，其它通道是正常操作的。

！请务必在设置任何其它功能之前完成舵机逆转。如果使用飞机中有混控功能控制多个舵机必须事先将各个功能设定好，否则很容易混淆哪个舵机需要逆转，如果在设置其它功能后完成舵机逆转，其它功能也会逆转。

！操控时，请先确认飞机所有舵机的动作方向与操控方向一致。如果不一致，请调整好正确的方向。

Function Details

This function enables the user to modify the direction of operation of each of the ten servos. For each channel the user can toggle a reverse state based on demand

The **reverse** function individually reverses the direction of operation of the servos on the 10 channels. This menu contains 10 check boxes, one for each channel. To toggle the **reverse** state of a channel, just touch it.

As shown in the picture 21.1, only the third channel is reversed, the other channels operate normally.

！Always complete your servo reversing prior to any other programming. If mix functions control multiple servos, it may be confusing to tell whether the servo needs to be reversed or a setting in the function needs to be reversed.

！Always check servo directions prior to make sure they are in the same way with operation direction. If not, please adjust to right direction.



(Pic 21.1)

21.02. 最大舵量 End points

功能说明：

此功能主要是此功能主要是针对不同类型的舵机及通道输出大量做调整。以便让舵机输出及通道数据输出符合结构设计，以及对性能的要求。最终达到最佳的控制效果！此功能可针对任一通道做调整。

舵机最大行程可分别调节10个通道的舵机高低行程限制。按照飞机的结构调节舵机最大行程。

点触**舵机最大行程**下需设置的通道，拨动摇杆或点触选择**高端**、**低端**，被选中的一侧会呈现黄色，红色指针代表选定的位置，滑动转轮调节**舵机最大行程**数值。拨动**摇杆**相关通道的位置即时呈现。

如图21.2所示：点触选择了CH2的**舵机最大行程**的高端，滑动转轮调节至50%，此时**CH2摇杆**打到最上边。通道的位置处于50%。

Function Details:

This function enables the user to control the low and high travel limits for each servo. For each channel the user can set the low and high limits. This ensures that the channel data for the servo is consistent with structural design and performance requirements to ensure the best results. Adjustments can be made for any channel

The **end points** function individually adjusts the low and high travel limit of each servo on the 10 channels. Set the end points according to your airplane structure.

To choose the side of one channel **end point** to set, move the **stick** to the desired **low or high side** or just touch the corresponding button. The selected side will be highlighted in yellow. The red needle represents the selected side. Use the wheel to move it and modify the **end point** value. The position of the corresponding channel is displayed in real time.

As shown in the picture 21.2, the acceleration side of the elevator is selected and the elevator trigger is half accelerating.

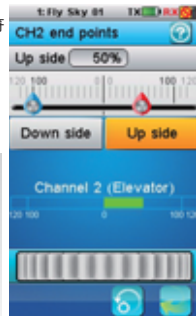

CH2摇杆打到最右边
Ch2 stick to the far right
(Pic 21.2)

21.03. 记忆微调 Subtrim

功能说明：

此功主要是针对舵机与结构安装配合时产生的角度差，及舵机因结构固有间隙产生的角度差而要进行修正调试时用于调整此类问题。最终达到最佳的控制效果！

记忆微调可分别调节10个通道舵机的中位。当舵机调节不能满足需要时，该功能的调节作用就尤为明显。

点触**记忆微调**下需设置的通道，滑动转轮调节所选通道的**记忆微调**数值，红色指针为当前位置。相关通道位置即时呈现。

点触选择了CH1，红色指针处于50%状态，通道的位置如图21.3所示。

Function Details:

This function enables the user to control the structure and angle difference for each channel on the servo. This allows the user to make adjustments to get the best results for their system

The **subtrims** function individually adjusts the center position of each servo of the 10 channels. This is particularly useful when the servo mechanics doesn't allow an adjustment fine enough.

Touch the channel which **subtrim** must be adjusted. Use the wheel to move the red needle and modify the **subtrim** value of the selected channel. The position of the corresponding channel is displayed in real time

As shown in the picture 21.3, the channel 1 has been selected and the red needle is at the position of 50% .

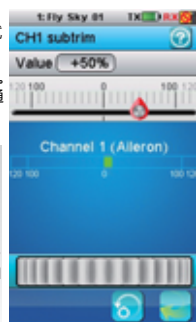

(Pic 21.3)

21.04 微调 Trims

功能说明：

此功能是针对通道输出做修正用的，用于修正通道的输出值。现在很多玩家主要用于修正模型的重心问题及空气动力所产生的反扭力等问题的补偿。从而让模型在空中能保持稳定的姿态！此功能只针对CH1-CH4通道做调整。

微调可分别调节4个通道摇杆的中位，可复位和实时显示4个**摇杆**及**微调杆**的位置。

点触**微调**将实时显示当前**微调**位置，当点击**复位**键时当前设定的**微调**均返回0。在任何界面下拨动**微调杆**，也会显示当前**微调**位置，等待2秒后会返回原功能界面；

点触选择了**油门**通道，拨动**微调杆**至+20，通道的位置如图21.4所示。

Function Details:

This function is to amend channels' output and value of channels' output. So far there are a lot of players use it to amend center gravity of model and Revomix caused by aerodynamic, etc. So it makes model more stable in the air. This function is only available for CH1-CH4

The **trims** function individually adjusts the center position of each servo of the 4 channels. It also can reset and display in real time the conditions of 4 **sticks** and **trim button**.

The current condition of the **trim** will be displayed after touching the **Trims** icon. Touch the **reset button** and all the **trim** value will be back to 0. The trims condition will be displayed when moving the **trim stick** in any condition and it will be back to the original interface after 2 seconds.

As shown in the picture 21.4, the **throttle** is selected and move the **trim sticks** to the position of +20.



(PicP 21.4)

21.05. 指数 Scaling Exponentials

功能说明：

此功能是一个特殊功能，它有两个子功能：一个是双重比率设定，一个是指数设定，双重比率功能主要是针对不同的飞行要求，所做的不同比率设定。比如：做3D时要求动作要大，而做3A时则要求动作要小，对新手来说动作要大一些，均可以通过比率设定来完成。指数功能主要针对专业人员所做的一项设定，以达到最佳的控制效果。当Exp为正数时，中立点数据输出灵敏度降低，两个端点的数据输出灵敏度升高，如果为负则反之。

指数用于调节摇杆或电位器的**比率**和**指数**，该功能一旦被激活，则有2个按钮用来选择需要修正的参数数值。此功能可分别在5个**状态**下设定。

比率：用于调整曲线的倾斜度。倾斜度越小，对应的输出量的抛物线越短。

指数：可分别调节所有**摇杆**或**旋钮** (Ail、Ele、Thro、Rud、VrA~VrE) 的**转换曲线**。**指数**数值是0时，**曲线**是线性的。正值会减少中位附近的灵敏度，增加两端的灵敏度。负值则增加中位附近的灵敏度，减少两端的灵敏度。

垂直的点线显示**摇杆**或**旋钮**即时位置。水平的点线显示**指数**功能调整后的通道输出的位置。

点触**指数**下需设置的**摇杆**或**旋钮**，激活开启按钮后选择**比率**或**指数**按钮，滑动转轮调节相应数值。可选择**一个开关** (SwA~SwH、LSw)来控制**指数**功能的**开启**或**关闭**，**比率**和**指数**功能也可分配给**一个摇杆**或**旋钮** (VrA~VrE) 来控制。

如图21.5所示：点触选择了VrA，激活开启按钮并调节**指数**参数至最大值。垂直的点线表示VrA当前在左边60的位置，在这种设定下通道输出，即水平的点处于低端20~40之间。

Function Details:

This function is a special function which has two sub-functions: one is dual rate setup and the other is exponent setup. Dual rate function is used to set different rate according to different type of aircraft. For example: Aircraft needs larger movement when you choose 3D and it needs smaller movement when choose 3A. In addition, smaller movement is appropriate for beginners and larger movement is appropriate for practiced ones. All above needs to be completed by setting rate. Exponential function is used to get a better effect for professionals. When exp is positive, the sensitivity of neutral point data's output will be decreased and the sensitivity of two terminal points will be increased. It is opposite when Exp is negative

Exponentials function is used to adjust the **rate** and **exponential** of the airplane. Once activated, 2 buttons select which parameter value to modify. The function can be set in 5 **conditions**. (Condition instruction can be acquired on manual from page1 to page 7).

Rate: adjust the slope of the curve. The smaller is the slope, the shorter is the throw of the corresponding servo.

Exp: adjust the linearity **curve** of all **sticks** or **knobs** (Ail、Ele、Thro、Rud、VrA~VrE). A value of 0 corresponds to a perfectly linear **curve**. A positive value decreases the sensitivity near the neutral position and increases it on the extreme sides. A negative value increase the sensitivity near the neutral position and decreases it on the extreme sides.

The vertical dotted line displays in real time the position of the curve. The horizontal dotted line displays in real time the curve position after the **exponential** function.

Select the **stick** or the **Knob** which need to set. After that, touch the enable button to enable this function and then select the **Rate** button or the **Exp**. button. Use the wheel to modify the corresponding value.

As shown in the picture 21.5, VrA is selected. The **exponential** function is activated. The selected parameter is rate and is set to its maximum value. The horizontal dotted line shows the VrA 60 on the left side. But the horizontal dotted line indicates that the resulting channel output is at the position between 20 and 40 under the middle position showing the efficiency of the exponential function.



(Pic 21.5)

21.06. 副翼方向 Aileron to rudder

功能说明：

当飞机结构有副翼和方向舵时，如果将副翼混控到方向舵进行预编程混控，可以用作飞机自动协调转弯；此设置调节飞机对应混控通道舵量的比例，默认均为10%，当结构没有副翼或方向舵将没有副翼混控至方向舵功能，主菜单中没有此功能图标。此功能可分别在5个状态下设定。

激活开启按钮后点触需设置的低端或高端比率进行设置，滑动转轮调节相应数值；可选择一个开关(SwA~SwH、LSw)来控制此功能的开启或关闭。

如图21.6，21.7所示：激活开启按钮并选择低端调节数值至20%，高端调节数值至20%，在这种设定下副翼摇杆打到最左边，副翼通道位置显示在左边100位置，而方向舵通道位置显示在左边20位置；副翼摇杆打到最右边，副翼通道位置显示在右边100位置，而方向舵通道位置则显示在左边20位置。

Function Details：

The **aileron to rudder** automatically creates a coordinated turn for the aircraft with **aileron** and **rudder**. It is the pre-programmed mix which controls the **rudders** with the **aileron** operation and can modify the master channels rate, which is 10% by default. If the aircraft does not have the **aileron** or the **rudder**, these two function icons will not be displayed. This function can be set in five conditions.

Select the desired **low side** or **high side** to set the rate and move the wheel to modify the corresponding values after activating this function. This function can be assigned to a **switch** (SwA~SwH、LSw).

For this example: The **low side rate** is set to 20% and the **high side rate** to 20%. Move the **rudder stick** to the far left, and the corresponding channels are displayed as shown in picture 21.6. Move the **aileron stick** to the far right, and the corresponding channels are displayed as shown in picture 21.7.



副翼摇杆打到最左边
Aileron to the far left
(Pic 21.6)

副翼摇杆打到最右边
Aileron to the far right
(Pic 21.7)

21.07. 方向副翼 Rudder to aileron

功能说明：

当飞机结构有方向舵和副翼时，如果将方向舵混控到副翼进行预编程混控，可以用作防止飞机随着方向舵输入时产生的不必要的横滚，尤其是在做侧飞时；此设置调节飞机对应混控通道舵量的比例，默认均为10%，当结构没有方向舵或副翼将没有方向舵混控至副翼功能，主菜单中没有此功能图标。此功能可分别在5个状态下设定。

激活开启按钮后点触需设置的低端或高端比率进行设置，滑动转轮调节相应数值；可选择一个开关(SwA~SwH、LSw)来控制此功能的开启或关闭。

如图21.8，21.9所示：激活开启按钮并选择低端调节数值至20%，高端调节数值至20%，在这种设定下方向舵摇杆打到最左边，方向舵通道位置显示在左边100位置，而副翼通道位置显示在左边20位置；方向舵摇杆打到最右边，方向舵通道位置显示在右边100位置，而副翼通道位置则显示在左边20位置。

Function Details:

This function can be used to counteract undesirable roll of aircraft with **rudders** and **ailerons**. This happens with the **rudder** input, when it is crabbing. It is the pre-programmed mix which mixes the **aileron** with the **rudder** operation. This setup can modify the master channel's rate, and the default value is 10%. If the aircraft does not have the **aileron** or the **rudder**, these two function icons will not be displayed. This function can be set up in each of five conditions.

Select the desired **low side** or **high side** to set the rate and move the wheel to modify the corresponding value after activating this function. This function can be assigned to a **switch** (SwA~SwH、LSw).

As shown in pictures 21.8 and 21.9: The **low side rate** is set to 20% and the **high side rate** to 20%. Move the **rudder stick** to the far left, and the corresponding channels are displayed as shown in picture 21.8. Move the **rudder stick** to the far right, and the corresponding channels are displayed as shown in picture 21.9.



方向舵摇杆打到最左边
Rudder stick to the far left
(Pic 21.8)

方向舵摇杆打到最右边
Rudder stick to the far right
(Pic 21.9)

21.08. 油门曲线 Throttle Curve

功能说明:

用来调节飞机油门的操作曲线,使**摇杆**动作和**油门**的响应相协调,为了补偿油门非线性问题;

此设置可以调节**油门曲线**的11个点(L, 2~10, H)从0%调整到100%,水平的点线显示油门**摇杆**的即时位置,垂直的点线显示此功能应用后**油门输出**的即时位置;当飞机结构没有**引擎**(如**滑翔机**)时将没有**油门曲线**功能,主菜单中没有此功能图标。此功能可分别在5个**状态**下设定。

激活开启按钮后点触需设置的点进行设置,滑动转轮调节相应数值。

如图21.10所示:点触**开启**按钮激活了**油门曲线**功能,调节2点数值至20.0%,3点数值至36.5%,4点51.5%,5点64.0%,6点74.1%,7点80.0%,8点85.5%,9点90.0%,10点95.0%,在这种设定下**油门摇杆**在中位以下(即L, 2~6点)油门输出相对**油门摇杆**在中位以上(即6~10, H点)加油较快。

Function Details:

This function enable the user to adjust the operation curve of the aircraft throttle and make it coordinate the **stick** movement and **throttle** output to compensate the non-linear problems of the throttle.

The 11 points (L, 2~10, H) of **throttle curve** can be adjusted from 0% to 100%. The horizontal dotted line displays in real time the throttle **stick** position. The vertical dotted line displays in real time the position of the **throttle output** after the **throttle curve** function has been applied. If the airplane and helicopter does not have an **engine**, this icon will not be displayed. This function can be set in five **conditions**.

Select the desired point to set and move the wheel to modify the corresponding value after activating this function.

For this example 21.10: The **throttle curve** function is activated. Point 2 is set 20%, point 3 30%, point 4 40% and point 5 50%, point 6 74.1%, point 7 80%, point 8 85.5%, point 9 90.0% and point 10 95.0%. In this situation, when the position of the **throttle** below the neutral, that is (L, 2~6), the acceleration of the **throttle needle** output is faster than its position above the neutral (that is 6-10, H point).



(Pic 21.10)

21.09. 油门延迟 Throttle Delay

功能说明:

用来降低油门输出的响应速度,比如模仿涡轮发动机的慢速响应等。可设定0~10s,默认为0s。当飞机结构没有**引擎**(如**滑翔机**)时将没有**油门延迟**功能,主菜单中没有此功能图标。

滑动转轮调节延迟时间,红色条线图表示油门**摇杆**的位置,绿色条线图表示通道的位置。

如图21.11所示:调节延迟时间为5s,此时油门**摇杆**从最低端打到最高端,因为有5秒延迟,当前位置为1秒时的油门通道即时位置,显示为20%。

Function Details:

Throttle delay is used to reduce the response speed of throttle output and imitate turbine **engine** in airbrake, which can be set from 0s to 10s. If the airplane does not have an **engine**, such as a **glider**, this icon will not be displayed.

Move the wheel to set the throttle delay time. The red bar represents throttle **stick** position and the green bar represents channel position.

As shown in the picture 21.11: The delay time is 5 seconds. There will be 5 seconds delay when moving throttle **stick** from bottom side to top side. Due to 5 seconds delay, the throttle is in the position when it is one second and it displays 20%

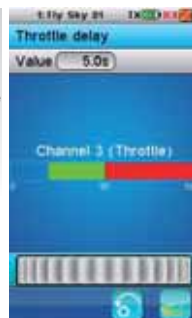

(Pic 21.11)

21.10. 收油门 Throttle Down

功能说明：

此功能分为两项，第一项为**怠速**设定，第二项为**油门锁定**设定，它们都是在调试及调整模型时使用的。其中怠速用于有引擎的模型让它保持低转速而不熄火。而**油门锁定**则是让模型油门完全让遥控器锁定不做输出。

此功能用来调节**低怠速**的比率和**熄火功能**的**开启或关闭**，低怠速从可0~50%间调节。此功能可分别在5个**状态**下设定。

低怠速功能开启时油门输出将会减去设定的比率值。

熄火功能开启时油门输出会降到最低。

熄火功能优先于**低怠速**功能；当**熄火**功能开启后调节油门摇杆时油门没有输出。默认**低怠速**和**熄火**功能均为**关闭**，**低怠速**默认比率为10%。

点触选择两个开关(SwA~SwH、Lsw)分别控制这两个功能的**开启或关闭**。当飞机结构没有引擎（如滑翔机）将没有**收油门**功能，主菜单中没有此功能图标。

点触选择两个开关开启**低怠速**和**熄火**功能，滑动转轮调节**低怠速**功能数值。

如图21.12所示：**低怠速**和**熄火**功能已开启，调节**低怠速**至20%，因为**熄火**功能已开启，油门通道将没有输出。

Function Details:

This function contains two options: option one is **idle** setup and option two is **throttle hold**. Two options would be set when you adjust models. The idle is useful for the models with engines and make models keep low rpm without shutting down. And the **throttle hold** is to completely lock model's throttle without shutting down.

Throttle down function is to enable **idle down** rate adjustment and **throttle cut** function turned on or **off**. Modify the rate from 0% to 50% after idle function is applied. This function can be set in five **conditions**.

Idle down: the throttle output minus the rate set in advance after this function is applied.

Throttle cut: the throttle output will be in its lowest point after this function is applied.

Throttle cut function is prior to **idle down** function. There is no output while moving throttle stick if **throttle cut** function is applied. **Idle down** function and **throttle cut** function are **turned off** by default. The default value of **idle down** is 10%.

These two functions can be assigned to 2 **switches** (SwA~SwH、Lsw). If the **airplane** does not have an **engine**, this icon will not be displayed.

Select two switches to enable or disable **idle down** and **throttle cut** function and move the wheel to modify the corresponding value after activating this function.

As shown in the picture 21.12: The **idle down** function and **throttle cut** are applied, and adjust the **idle down** to 20%. There is no output of throttle channel.



(Pic 21.12)

21.11. 辅助通道 Auxiliary Channels

功能说明：

当模型装配调整基本完成后，如果发现还有一些结构功能没有设置，此时可通过**辅助通道**来进行辅助调整完成。

辅助通道当飞机结构设定完成后，为剩下的通道选择一个**开关、旋钮、逻辑开关**或**摇杆**作为**辅助通道**。因飞机结构默认为四通固定翼，所以默认辅助通道为CH5~CH10；

点触此功能下需设置的**辅助通道**，选择一个**开关、旋钮、逻辑开关**或**摇杆**对通道进行设置。

如图21.14所示：设置**辅助通道**CH5，并选择SwD向上控制该通道的开启，此时拨动开关SwD向下时，**显示舵机**（显示舵机功能见说明书P34页）里通道显示为左边100位置。

Function Details :

The model function allows users to set additional **auxiliary channels** if the model has more than the default 4 channels. Some aircraft have more than four auxiliary channels, so these additional channels can be modified using this function.

Assign the **auxiliary channel** a **switch**, a **knob**, a **logic switch** or a **stick** after finishing the airplane structure setting. The default structure is 4-channel fix wing, so auxiliary channels are from CH5 to CH10.

Touch the auxiliary channel needed and select a **switch**, a **knob**, a **logic switch** or a **stick** to control this function.

For this example: Select CH5 as **auxiliary channel** and push SwD upward to enable this function. At this time, the channel in **Servo display** is displayed as shown in picture 21.14



(Pic 21.13)

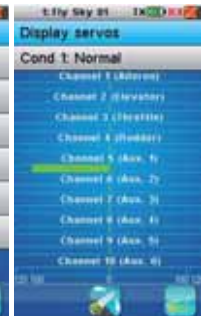

(Pic 21.14)

拨动开关SwD向下时
Push swd downward

21.12. 通道偏移 Channels offset

功能说明：

此功能用于调整模型时使用，当模型结构还有一些偏差时，可以用此功能进行修正。

通道偏移用来设定通道数据的偏移比率，可以设定-50%至50%，默认为0%。此功能可分别在5个状态下设定。

点触通道偏移下需设置的通道，滑动转轮调节来调节通道偏移数值。相关通道位置即时呈现。

如图21.15, 21.16所示：设置CH2通道偏移数值为10%，此时摇杆打到最左边，通道位置为左边90，打到最右边，通道位置为右边100。

Function Details:

This function is used to revise model when there are some deviations in structures.

Set **channel offset** rate from -50% to 50% based on the channel neutral position. The default is 0%. This function can be set in five **conditions**.

Select the desired point to set and move the wheel to modify the corresponding value after activating this function. The position of the corresponding **channel** is displayed in real time.

The **offset** value of CH2 is adjusted to 10%. Move the **stick** to the far left, and the channel is displayed as shown in picture 21.15. Move the **stick** to the far right and the channel is displayed as shown in picture 21.16.

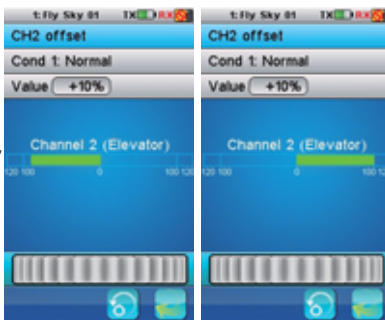

Ch2摇杆打到最左边
Ch2 stick to the far left
(Pic 21.15)

Ch2摇杆打到最右边
Ch2 stick to the far right
(Pic 21.16)

21.13. 功能延迟 Function Delay

功能说明：

此功能主要用于模拟一些真飞机的动作，比如Flap的收放动作，另外在做一些比较特殊动作时用于过渡用的，比如：飞3D时从NOR切换到3D时必须过渡的变化，来进行平滑处理。

功能延迟是用来降低基本功能的响应速度（基本功能说明见说明书P31页），可设定0~10s，默认为0s。

点触功能延迟下需设置的基本功能，滑动转轮调节延迟时间，相关基本功能的位置即时呈现。红色条线图表示摇杆的位置，绿色条线图表示显示此功能应用后通道输出的即时位置。

如图21.18所示：调节副翼功能的延迟时间为5s，此时副翼摇杆从最低端打到最高端，将会延迟5s。

Function Details:

This function is used to imitate some movements of real aircraft, like flap movement and some other special movements. For example, when the user is flying 3D, he could do some smoothing to change from NOR to 3D

Functions delay is used to slow down the response speed of **basic function** (**basic function** can be acquired in the manual from page 31). It can be adjusted from 0 seconds to 10 seconds and the default is 0 seconds.

Select the desired basic channel and move the wheel to modify the delay time. The position of the corresponding basic channel is displayed in real time. The red bar represents **stick** position and the green bar represents channel position after setting.

As shown in picture 21.18: The delay time is set to 5 seconds. At this time, there will be a 5s delay when moving **aileron stick** from bottom side to top side.



(Pic 21.17)

(Pic 21.18)

21.14. 通道延迟 Channels delay

功能说明：

此功能主要用于模拟一些真飞机的动作，比如Flap的收放动作。

通道延迟是用来降低输出通道的响应速度，可设定0~10s，默认为0s。

点触通道延迟下需设置的通道，滑动转轮调节延迟时间，通道输出的位置即时呈现。红色条线图表示摇杆的位置，绿色条线图表示通道输出的位置。

如图21.20所示：调节CH2升降延迟时间为5s，此时升降摇杆从最低端打到最高端，将会延迟5s。

Function Details:

This function is used to imitate some movements of real aircraft like the flap

Channels delay is used to slow down the response speed of **channel output**. It can be adjusted from 0 seconds to 10 seconds and the default is 0seconds.

Select desired **basic channel** and move the wheel to modify the delay time. The position of the corresponding channel output is displayed in realtime. The red bar represents the **stick** position and the green bar represents channel output position.

As shown in picture 21.20: The delay time of **CH2** is set to 5 seconds. At this time, there will be a 5s delay when moving the **rudder stick** from bottom side to top side.



(Pic 21.19)

(Pic 21.20)

21.15. 线性混控 Linear mixes

功能说明：

此功能在进行一些特殊动作且需要混控时可以使用。

线性混控可以设置任意两个摇杆、基本功能及输出通道之间的混控。此功能可分别在5个状态下设定。

激活线性混控，被混控通道将会受混控通道对应比率的影响，呈线性变化。混控通道（主通道）可选择摇杆/旋钮、基本功能或输出通道，被混控通道可选择基本功能或输出通道，但被混控通道只能选择混控通道功能后的选项，如当混控通道选择基本功能时，被混控通道只能选择基本功能或输出通道，而不能选择基本功能之前的选项，即摇杆。可选择一个开关(SwA~SwH、LSw)来分别控制4组混控功能的开启或关闭。

摇杆/旋钮：摇杆及VrA~VrE旋钮；

基本功能：飞机动作需现实的基本功能，如：副翼功能、升降功能、油门功能、方向功能；当飞机结构有油针时的油针功能等等；

输出通道：CH1~Ch10；

低端：设置混控通道低端对被混控通道的的影响范围；

高端：设置混控通道高端对被混控通道的的影响范围；

偏移：设定通道数据的偏移比率；

当调节低端混控、高端混控或者偏移时，通道的位置即时呈现。

如图21.22所示：第1个混控被激活，混控通道为副翼功能，被混控通道为CH2升降，低端混控设置到+50%，高端混控设置+100%，当摇杆打到最左边时，副翼功能将处于为左边100，CH2升降将处于左边50位置。

Function Details:

This function could be helpful when you are flying some special movements and need mix control function

Linear Mixes can set 4 groups of mix controls among any two sticks, basic functions and output channels. This function can be set in five conditions.

The slave channel will be affected by corresponding rate of master channel, which will be changed in a linear fashion after linear mix function is applied. **Master channel** contains stick/knob option and basic function option or output channel option. **Slave channel** contains basic function option or output channel option. But when output channel option is selected in master channel function, there is only one output channel option in slave channel options. Otherwise, no matter what option you select in the master channel function, any option channel could be selected in the slave channel. The master channel and the slave channel can be assigned to sticks or knobs, basic channels or output channels. The 4 mix functions can be assigned to a switch.

Stick/knob: stick and knob from VrA to VrE.

Basic function: It is the basic function for the aircraft movement. For example: aileron function, rudder function, throttles function, and rudder function and the throttle needle function for the aircraft structure with the throttle needle, etc.

Output channel: CH1~Ch10;

Low side: Set how much the channel is affected by low side of master channel.

High side: set how much the channel is affected by high side of master channel.

Offset: set the deviation rate of the channel, based on the channel neutral position.

The position of the corresponding channel output is displayed in real time while adjusting the low end mix, high end mix or offset.

As shown in picture 21.22: The first set of mix is activated, and the master channel is aileron function and the slave channel is elevator Ch2, The low side mix is set to +50% and the high side mix is set to +100%. Move the stick to the far left, the channel position is displayed.

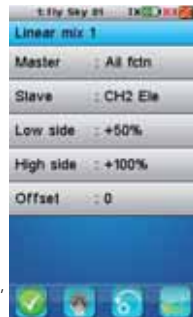

(Pic 21.21)

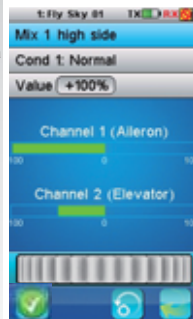

(Pic 21.22)

21.16. 曲线混控 Curve Mixes

功能说明：

此功能在进行一些特殊动作且需要混控时可以使用。

曲线混控同线性混控一样，可设置4个混控。此功能可分别在5个状态下设定。

激活线性混控，被混控通道将会受混控通道影响，呈曲线变化。曲线可调节11个点(L, 2~10, H)从-100%调整到100%，水平的点线显示摇杆的即时位置，垂直的点线显示此功能应用后被混控通道输出的即时位置；混控通道（主通道）和被混控通道（从通道）可选择摇杆/旋钮、基本功能或输出通道。可选择一个开关(SwA~SwH、LSw)来分别控制4组混控功能的开启或关闭。

当调节曲线时，通道的位置即时呈现。

如图21.23所示：第1组混控被激活，混控通道为副翼功能，被混控通道为CH2升降，调节L点数值至-90%，H点90%，其它点数值不调节，在这种设定下副翼摇杆在L-2点及10-H点时CH2升降通道输出较平缓，且比率从-90%~90%。

Function Details:

This function can be helpful when you fly with some special movements and need some mix control function

The curve mixes like linear mixes can be set to 4 set of mixes. This function can be set in 5 conditions..

The slave channel will be affected by master channel after linear mixes are applied, which will be presented with curve distribution. Set 11 points (L, 2~10, H) from -100% to 100% to adjust the curve. The horizontal dotted line displays in real time the stick position and the vertical dotted line displays in real time the position of slave channel output after this function. The master channel and channel can be from stick or knob, basic and output channel. These 4 sets of mixes can be assigned to a switch(SwA~SwH、LSw) respectively.

The position of the corresponding channel output is displayed in real time while adjusting the curve.

As shown in picture 21.23 The first mix is activated. The master channel is aileron function and the slave channel is CH2 Ele. Adjust the value of point L to -90%, and point H to 90. Do not adjust other points. At this time, the output will be shown as curve in picture

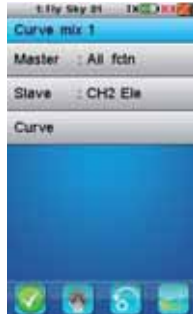

(Pic 21.23)



(Pic 21.24)

21.17. 状态 Conditions

功能说明：

模型在操作时会有不同的状态出现，此功能为模型提供了5种不同状态。

状态功能可设定飞机的飞行状态，最多有五种状态C1-C5，默认名字为Normal、Take off、Hight speed、3D fight、Landing，可以修改状态名字，C2~C5可以分配一个开关来控制状态的开启或关闭，状态之间可以复制（复制内容不包括设定的开关），一般设置好一个状态参数后，用复制来创建其它状态参数，再进行微调，可以节省调试时间。默认状态没有分配开关，所以默认为C1.其它状态C2~C5为关闭。

分配一个开关开启了其它状态时，关闭此开关会切换到正常状态；同时分配两个或以上开关时，设置听从于级别高的状态，C5为最高级、C1为最低级。

点触此功能下需设置的状态，可修改状态名字、进行状态之间的复制和选择开关（SwA~SwH）。

如图21.25所示：点触选择了C2:Take off，定义SwA两档开关的向下方向为开启。

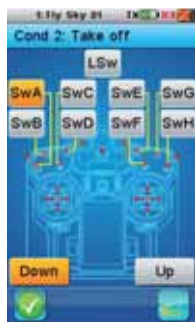

(Pic 21.25)

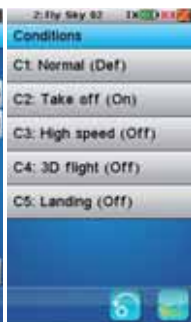

(Pic 21.26)

Function Details:

This function enables the user to select five different conditions for the model.

This function can set the flight condition and there are 5 conditions at most. The default name is Normal, Take off, High speed, 3D fight, Landing, which can be amended. C2 - C5 can be assigned to one switch to be turned on or off and can be copied (excluding the switches you set). After setting parameter of one condition, you can copy it to create a new one and then sub trim it, which can help you save setting time. No assigned switches are set by default. So C1 is the default and C2-C5 is off.

When any other conditions are assigned to a switch, it will be Normal condition after turning off this switch.

The high level condition is available if assigning two or more conditions at the same time. C5 is the highest level and C1 is the lowest level.

Select one condition, and you can amend the condition name, copy the condition and assign it to a switch.

As shown in picture 21.25: C2: Take off is selected. Push the SwA downward to enable this function

21.18. 逻辑开关 Logic switches

功能说明：

当需要用一组开关来进行预设一些功能时，可使用此功能。

逻辑开关是由2个开关加数学逻辑关系组成的虚拟开关，来控制一些功能的开启或关闭。可设定3组逻辑开关（Lsw1, Lsw2, Lsw3），选择SwA~SwH进行组合，逻辑关系有与、或、异或，组合功能如下表所示：

Function Details:

The logic switch is a virtual switch which consists of two switches plus a mathematical logical relationship. The logic switch is used to control turning on or turning off of some functions

The logic switch is a virtual switch which consists of two switches plus a mathematical logical relationship. The logic switch is used to control turning on or turning off of some functions two switches control one function. There are 3 sets of logic switches (Lsw1, Lsw2, Lsw3). Select switches from SwA to SwH to combine the logic switch. The logic relationship includes 'And', 'Or' and 'Xor'. The combination is as follows

开关 switch	开关Swith2	逻辑关系	logic relationship	
关 off	关 off	和 And	或 Or	异或 Xor
关 off	关 off	关 off	关 off	关 off
关 off	开 on	关 off	开 on	开 on
开 on	关 on	关 off	开 on	开 on
开 on	开 on	开 on	开 on	关 off

例如设定固定翼飞机放轮子后再熄火，如图Pic21.27所示，点触选择了Lsw1，SwA向上，Swb向上，逻辑关系为或，并在辅助通道中设定SwA为放轮子，Lsw1为熄火，此时拨动SwA向下放轮子，SwA向下加SwB向下才可以熄火。

As shown in the picture 21.27: Select SwA up and SwB up and the logic relationship is set to or. Sw1, Sw2 and logic switch are displayed in real time. SwA is used to lower the wheels and logic Sw1 is to cut the engine. To accomplish this you need to access the auxiliary channels screen. So, if SwA and SwB pushed down at the same time, the engines will be cut



(Pic 21.27)



(Pic 21.28)

21.19. 定时器 Timers

功能说明：

此功能是用控制时间及降低风险而使用的，您如需要时可开启此功能。

定时器有3种不同的方式定时。

模型引擎定时器：模型定时器为模型打开的总时间，以小时为单位，精确到分钟；**引擎定时器**为油门超过一定设定值后的时间，以分钟为单位，精确到秒。两个定时器均可以点触对应的**复位**进行复位，**引擎定时器**可以调节转轮修改开始定时的设定值。

如图所示：油门当前位置超过设定值-80%的位置，**引擎定时器**开始计时。

多功能定时器1、2：多功能定时器1、2可选择定时方向向上向下或向下后向上计时，分别可以对时间进行**开始、停止、复位**操作，并设定一下开关或逻辑开关**开始**或**停止**操作。

向上计时：从0开始计时。可进行**开始、停止**和**复位**三种操作；

向下计时：默认从1分钟开始倒计时，可以调节转轮修改倒计时时间；

向下然后向上：默认从1分钟开始倒计时，计时到1分钟后开始向上计时；调可调节转轮修改倒计时时间；使倒数计时时间返回到开始设定的时间。

如图所示21.29：计时器已开始计时。

如图所示21.30：倒数计时器设定到5分钟，此时倒数计时器是停止状态。记时器**开始、停止**可分配给一个按键控制。



(Pic 21.29)

(Pic 21.30)

Function Details:

This function is used to control time and reduce the risk of aircraft crashing

There are three choices for timing. Select Timers to set the timers function.

Model/Engine: Model timer is the total time of turning on the model. **Engine timer** counts the time when throttle value exceeds the set value. Both timers can be **reset** by touching 'Reset' button, and **engine timer** can modify throttle value by moving wheel on the screen.

As shown in pictures 21.31 and 21.32: When throttle exceeds -80%, the engine timer starts to time.

Multi-purpose timer 1 and 2: **Multi-purpose timer 1 and 2** can select **Up timer, Down timer, and Down then up** for timing. It can individually **start, stop, and reset** and you can also set a switch or logic switch to **start or stop** it.

Up timer: Timing starts from 0s. It can be **started, stopped and reset**.

Down timer: Default count down from 1 minute, it can be modified by moving wheel.

Down then up: Default count down from 1 minute, and it start to up timing after 1 minute. It can be modified by moving wheel.

As shown in picture 21.29: Make countdown time back to beginning time you set.

As shown in picture 21.30: Down timer set to 5 minutes and it stops now. The race timer **start, stop** function can be assigned to a push button

21.20 教练模式 Trainer Mode

功能说明：

此功能用于初学者进行训练时，可使用**教练线**（见P53页可选件）将两个发射机连接起来，由教练机对学习机进行飞行指导。

取**教练线**连接两个发射机**教练接口**（见P17页），点触**教练模式**激活学习机**教练功能**，教练机可对学习机的8个通道进行控制，即可设置学习机的8个通道对应教练机的通道，并可选择**摇杆/旋钮、基本功能、输出通道**或**无**。点触进入**显示舵机**，拨动并按住**两档复位开关 SwE**，拨动教练机的**摇杆**，学习机对应的通道即时显示；

激活了学习机**教练功能**，设置通道1为**副翼功能**，通道5~8为**无**，此时进入**显示舵机**，拨动并按住**两档复位开关 SwE**，拨动教练机的**两边摇杆**至左上角，此时学习机舵机即时显示如图21.34。

Function Details:

This function allows you to connect 2 transmitters together using a **dedicated cable** (see page 53, No.14 optional) connected to the back interface. Once enabled, switching on the selected trainer switch will set up the remote as the instructor and use the trainer transmitter to control the model.

Use **dedicated cable** to connect two transmitters and touching **trainer mode** to activate function. The trainer transmitter can control 8 channels of learner model, and you can select **stick or knob, basic function, output channel or none**. Select **display servos** function, push down **SwE** and hold it, learner model's channels will display in real time.

Activated trainer mode function, setting Channel 1 to **aileron function**, channel 5-8 is None. Learner model's channels will **display**. As shown in picture 21.32.



(Pic 21.31)

(Pic 21.32)

学习机舵机显示
Display servos of trainer transmitter

21.21. 显示舵机 Display servos

功能说明：

此功能在调试模型时，方便快速观察当前模型输出状态而使用的，同时也可对所有输出通道进行自动检测用。

此功能显示10个舵机的即时位置。

点触测试按钮 让10个舵机在其最大行程内缓慢移动，可测试模型机械的一致性。

Function Details:

This function is to display model channel output and automatically test all output channels.

This function displays in real time the position of the 10 servos.

The test button lets the 4 servos move slowly between their respective end points.

This allows testing of the consistency of the mechanics of the model.

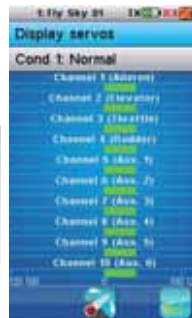

(Pic 21.33)

21.22. 模型 Models

功能说明：

此功能用于设置模型类型，固定翼/滑翔机、直升机类型，可以保存20个不同类型及参数的飞机，可切换，可复制，可重命名。导出模型保存至SD卡上，可导入并可删除SD卡上的文件。

Function Details:

This function is used to set the **model** type, airplane/glider/helicopter. It can save twenty different **model** type parameters. It is changeable, copiable and renameable. You can move model parameters so a SD card and delete them from the SD card.



只兼容2.0版本，1GB以上的SD卡。

Only compatible with the SD card 2.0, whose capacity is over 1GB



(Pic 21.34)

名称：

修改当前模型的名称。

Name:

Modifies the name of the current model.



(Pic 21.35)

选择模型：

选择可使用的模型。如图选择了第一个模型。点触其它模型菜单项即可选择和使用该项。

Select model:

Select the model configuration to load and use. In this example, the first model is selected. Simply touch another model menu item to load and use it.



(Pic 21.36)

复制模型：

复制一个模型数据到另一个模型，目标数据将丢失，取而代之的是来源模型数据。点击确认按钮完成该操作。

第一个菜单选择来源模型数据。

操作方法：

1. 进入“模型”点击“复制模型”，选择一个被复制对象。
2. 此时系统会自动跳到复制目标。
3. 选择一个复制目标后会自动弹出对话框“确定”复制完成，“取消”复制。

Copy model:

Copies a model configuration to another. The target configuration is lost and replaced by the source configuration.

The first menu selects the source model configuration to copy from.

How to operate:

1. Enter model function and press copy model to select which one you need to copy
2. The screen will change to the model you copied.
3. After selecting one copied model, the window will automatically open with a message asking if you are sure to copy, YES or NO. Shown in picture 21.



(Pic 21.37)

第二个菜单选择需要复制的目标模型数据。

The second menu selects the target model configuration to copy to.

来源模型数据写入到目标模型，点击确认按钮即可完成。如图21.39所示：点击确认按钮后，模型4的所有数据将丢失，被模型2的数据代替。

Since the target model configuration is overwritten by the source model configuration, a confirmation is requested.

As shown in the picture 21.40: After touching the "Yes" button, the model configuration 4 will be lost and replaced by the model configuration 2.



(Pic 21.38)



(Pic 21.39)

导出模型：

导出当前的模型并保存至SD卡上，默认保存文件的名称为模型名称，用户可自行定义。

操作方法：

1. 进入“模型”点击“导出模型”
2. 选择一个要替换的文件。
3. 按“确定”完成替换并存储新的文件
4. 如果是要建立一个新文件，则点击“新建文件”建立一个新文件并存储。

Export models:

Export the current model parameters and save them in the SD card. The default file name which can be modified is model name.

How to operate:

1. Enter model function and press export model
2. Select one replacement
3. Press OK to complete replacing and save the new one
4. If you want to create a new file, jut press Create a new file and save it.

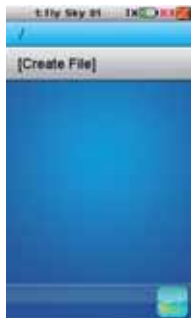

(Pic 21.40)



(Pic 21.41)

导入模型：

导入SD卡上的模型，并会覆盖当前的模型。

操作方法：

1. 进入“模型”点击“导入模型”。
2. 选择一个想要导入的模型参数文件。
3. 按“确定”完成导入。

Import models:

Import the model parameter from the SD card and the current model will be covered.

How to operate:

1. Enter model function and press import model
2. Select one model you want to import
3. Press OK to complete importing



(Pic 21.42)

删除文件：

用来删除SD卡中的模型文件。

操作方法：

1. 进入“模型”点击“删除文件”。
2. 选择一个想要删除的文件。
3. 按“确定”完成删除。

Delete files:

Delete the model file in the SD card.

How to operate:

1. Enter model function and press file deleted
2. Select one file you need to delete
3. Press OK to complete deleting

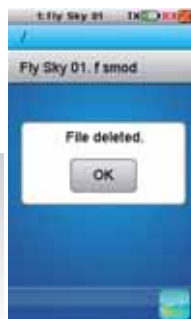

(Pic 21.43)

设置模型类型：

此功能是将当前模型参数设置复位到默认固定翼/滑翔机或直升机的状态，进入相应结构设置，点触进入**飞机结构**设置，**固定翼/滑翔机**结构默认为4通道（引擎+副翼+升降+方向），点触复选框可进行修改；直升机默认为**固定螺距**，点触复选框可修改为**可变螺距**，并可对倾斜盘类型进行设置；

如图21.44所示：对名称为Flysky01的模型结构修改，点触**设置模型类型**，选择**固定翼/滑翔机**类型后，模型Flysky01将会复位到默认固定翼/滑翔机状态，点触勾选了**油针**、两个**副翼**、两个**襟翼**，点触返回键修改后的结构如图21.45所示。

Setting model type:

All the model settings must be reset to default state of airplane or glider, then enter 'structure setting'. The default **structure of airplane or glider** is 4 channels (**throttle, aileron, elevator and rudder**), the structure can be changed by touching the check box. The default structure of helicopter is **fixed pitch**; it can be changed to **variable pitch** by touching check box. At the same time, the swash plate type can be set

As shown in picture 21.44, modifies the structure of Flysky01, touch "setting model type", after selecting the **airplane or glider** type, the Flysky01 will reset to default state. Select **throttle needle**, two **ailerons**, two **flaps**, and then touch back key. The modified structure will be as shown in picture 21.45



(Pic 21.44)

(Pic 21.45)

21.23 接收设置 RX setup

功能说明:

此功能用来设置接收机及外挂模块的相关参数；接收设置主菜单(如图21.46)所示。

对码：发射机进入对码模式。一旦对码成功，自动退出对码模式。点触返回按钮取消对码(如图21.48)。

AFHDS2：默认为双向系统，点触复选框可以切换为AFHDS单向系统，并可兼容FLYSKY所有双向接收机；

电池检测：检测接收机电池的电压(如图21.47)。

外部传感器：当复选时，用外部传感器来检测电池电压，不使用接收机内部电压传感器。当接收机使用电子调速器供电时，可用外部传感器。直接连接这个外部传感器到主电池。

低电压：设置电压值，当电池电压低于该数值时，显示电池处于没电状态，默认低电压为4.00V。

警报电压：设置电压值，低于此电压可以听见警报并且屏幕顶部上方的接收机电池标识开始闪烁(如图21.49)。默认警报电压为4.20V。

高电压：设置电压值，当电池电压为该电压值时，显示电池处于满电状态。默认高电压为5.00V。

Function Details:

Set up the receiver. This function is used to set the corresponding parameter of the receiver and the sensors connected. RX setup menu. (As shown in picture 21.46)

Bind with a receiver: The transmitter enters in bind mode. Once the receiver is correctly bound, press the back button to return to normal operation. (As shown in picture 21.48)

AFHDS2: the default is a two-way communication system. Touch the check box to toggle the two-way communication telemetry

RX battery monitor: Monitors the receiver battery voltage.

External sensor: Do not monitor the receiver power supply voltage but use an external sensor instead. This is useful when the receiver is powered by an ESC. Connect the external sensor directly to the main battery. (As shown in the picture 21.47)

Low voltage: set the minimum voltage when the battery is almost empty. default low voltage value is 4.00V.

Alarm voltage: set the voltage under which an audible alarm rings and the receiver battery icon in the top tray blinks. (As shown in the picture 21.49)

High voltage: set the maximum voltage when the battery is full. default high voltage value is 5.00V.



(Pic 21.46)

(Pic 21.47)



(Pic 21.48)

(Pic 21.49)

失控保护功能 failsafe function:

功能说明:

此功能是在接收机收不到信号时,可以采用预先设定的参数,进行保护。点触**失控保护功能**显示当前10个通道的预设状态;通道状态显示为**关闭**时当接收机丢失信号,相关联的舵机将保持最后收到的位置信号;开启时舵机将返回预先设定位置。所有通道设置可以设置当前已开启的所有通道的位置。

如图21.50所示,当接收机丢失信号,CH2升降设置到-50%位置,其它将保持它们最后收到信号时的位置。

Function Details :

This function is used to protect aircraft with parameters set in advance when the receivers don't receive the signals.

Press **failsafe function** and it will display the current setting of 10 channels. **Off** means that in case of a loss of signal, the corresponding servo will keep its last received position.. The servo will move the position you preset . All the channel is able to be set failsafe.

As shown in picture 21.50: Only **CH2 Ele** is set to -50% in case of a loss of signal. The others will keep their previous position.



(Pic 21.50)

(Pic 21.51)

设置方法 :

点触一个通道设置**失控保护功能**并激活(点击图标,如图),将对应该通道**开关、旋钮、逻辑开关**或**摇杆**通道拨到需要的位置,然后保持该位置并点触返回按钮,舵机的位置将保存;

当激活了多个通道**失控保护功能**时,可点触**所有通道**设置,将对应的通道**开关、旋钮、逻辑开关**或**摇杆**通道拨到需要的位置,按系统提示点触**确认**按钮,舵机的位置将保存;

如图21.52所示,CH2升降及CH4方向通道的**失控保护功能**被激活,并均设置到-100%位置。

Setup:

Touch a channel to set its **failsafe** behavior. If activated, set the channel to the desired position using the corresponding channel **switch, knob, logic switch or stick** then while maintaining that position, touch the back button. The position of the servo is then memorized.

If multiple channel **failsafe** are activated, set the **channels** to the desired position using the corresponding channel **switch, knob, logic switch or stick** then while maintaining that position, touch the **back** button. The position of the servo is then memorized.

The **failsafe** on the channel 2 (elevator) and channel 4 (rudder) are activated and set to -100%.



(Pic 21.52)



(Pic 21.53)



(Pic 21.54)



为了您的安全请使用此功能。
For your safety, please use this function

传感器列表：

显示所有连接上的传感器类型、编码和数值。接收机最多可连接15个传感器。

Display sensors:

Display the type, ID and value of all connected sensors. Receiver can connect 15 sensors at most.

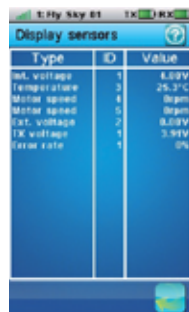

(Pic 21.55)

选择传感器：

此功能可选择需显示的传感器；主显示屏最多可以显示4个传感器的数值。选择需设置的主显示屏的位置（1至4），显示当前分配的传感器。

Choose sensors:

The main screen can display the value of up to 4 sensors. This function selects which sensors to display. Select the main screen slot to attribute (1 to 4). The currently attributed sensor is displayed. This function enable users to select sensors they want to display.

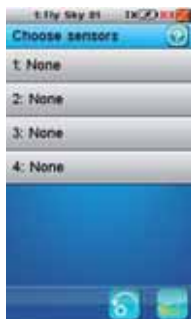

(Pic 21.56)

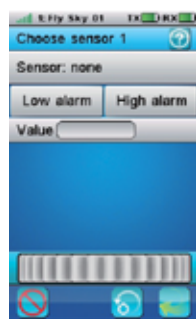

(Pic 21.57)

速度和距离：

若转速传感器与接收机连接，该功能可设置虚拟速度和里程表，如图21.58所示。

参数说明：

速度传感器，“有”表示有传感器连接，
每圈长度，表示单圈长度，
复位里程1，单次使用的里程
复位里程2，累计使用的里程

Speed and distance:

As shown in picture 21.55, if a rotation speed sensor is connected to the receiver, this function set up the virtual speed and odometers sensors.

Parameter Details:

Speed sensor : Number shows over one mean that there are sensors connecting
Set rotation length means length of each rotation
Reset odometer 1 means odometer when single use
Reset odometer 2 means the odometer of total use

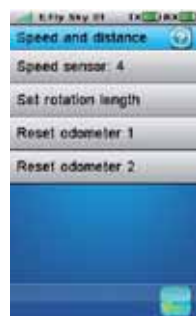

(Pic 21.58)

转速传感器：

选择转速传感器。没有选择，该功能将被禁用，如果有连接传感器，则如图。

Speed sensor:

Select the rotation speed sensor to use. If none is selected, this function is disabled.

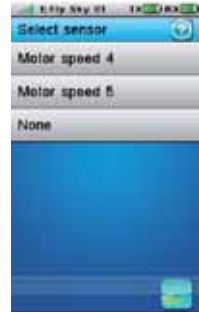

(Pic 21.59)

每圈长度：

设置旋转一圈行程。该距离用于计算虚拟速度和里程表传感器。

点击“每圈长度”，设置模型每圈的能走的距离(单位：毫米)，点击返回即可，如图21.60：

Set rotation length:

Set the model travel distance corresponding to one rotation speed sensor. This distance is used to control the virtual speed and odometers sensors.

Touch "Set rotation length" to set distance traveled by the model in one revolution of wheel (Unit: mm). As shown in Picture 21.60, touch back button to return.



(Pic 21.60)

复位里程表：

点击“复位里程表1”或“复位里程表2”，可用于清零相应的里程表内的数值。

里程表1：作为单次里程表，记录每次使用时模型车跑的里程。

里程表2：作为总里程表，累计记录所有的里程。

Reset odometer:

Touch "Reset odometer 1" or "Reset odometer 2" to reset the corresponding odometer.

Odometer 1: It is used for recording the distance traveled by the vehicle one time.

Odometer 2: It is used for recording total distance traveled by the vehicle.



(Pic 21.61)

i-BUS 设置：

如果舵机连接到外部-BUS接口则此功能有效，该功能能为每个舵机分配一个通道。

i-bus setup:

If servos are connected on the external serial interface, this function attributes a channel to each servo. Choose the channel to attribute.



(Pic 21.62)

舵机频率选择

调整接收机的输出频率，从50~380Hz。滑动转轮调节频率的数据，退出时设置成功。

Servo frequency selection:

Adjust the servo frequency from 50HZ to 380HZ. Move the wheel to modify the frequency value, which can be saved on exit.

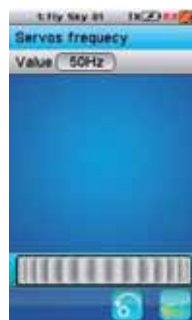

(Pic 21.63)

21.24. 系统 System

此功能主要对系统的一些基本参数进行设定。

This function is used to set some parameters of the system



(Pic 21.64)

背光延时：

设置在无任何操作的情况下屏幕背光的持续时间默认为30秒。

△屏幕背光持续的时间越长，发射机电池的使用时间越短。

Backlight timeout:

30s is the default time of backlight timeout when there is no operation.

△The longer the LCD backlight stays on, the shorter the battery of the transmitter lasts.

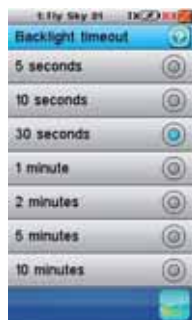

(Pic 21.65)

背光：

调整背光的亮度。在阳光明媚的天气可以使用高亮度的背光。默认为50%。

△背光越亮，发射机电池持续的时间越短。

Backlight:

This function is used to adjust the brightness of the back light. High brightness can be used on a sunny day! 50% is the default shown in picture 21.66!

△The higher the brightness is, the shorter the battery of the transmitter lasts.



(Pic 21.66)

声音：

开启或关闭发射机声音，默认为开启。

自动关机：

开启此功能后，若当五分钟内没有操作发射机时，发射机将自动报警，报警时间会持续五分钟，然后机器将自动关闭。报警的同时LED会闪烁指示，点击“自动关机”可取消自动关机功能。

Sound:

Turn on or turn off the sound. It defaults turn on the sound.

Auto power off:

After five minutes of no operation, the transmitter will sound an alarm and flash its LED. After five more minutes of no operation, the transmitter will automatically shut down. Touch "Auto power off" to cancel automatic power off function.



(Pic 21.67)

屏幕校准：

若触摸屏不够准确，可以使用此功能进行校准。用手写笔依次准确的点触，屏幕四角出现的十字的中心点，校准完成后自动退出；可中途点触返回键退出。

Screen Calibration:

You can use a pen to touch the cross center point to calibrate. After calibrating, it will exit or press return button to exit.



(Pic 21.68)

单位：

选择长度和温度的单位。

长度：

公制用毫米，千米和千米每小时三个单位。

英制用英尺，英里和英里每小时三个单位。

温度：

有摄氏和华氏温度两个单位。

Units:

Select length and the temperature unit.

Length:

Metric uses millimeter, kilometer and kilometer per hour. Imperial uses inch, mile and mile per hour.

Temperature:

Celsius and Fahrenheit degree for your option.



(Pic 21.69)



(Pic 21.70)

USB功能

无：仅提供发射机电池充电功能。

FS-i10模拟器：当发射机与电脑连接后，发射机即作为一个标准的HID设备，其拥有四个轴向（每一个轴向相当于一个通道）和10个按键（1~10），并可应用于任何与之兼容的模拟软件。

操作方法：

1. 将Micro USB线连接发射机与电脑。
2. 打开发射机电源，点击：系统-----USB功能-----FS-i10模拟器，电脑会自动识别到人机接口设备；
3. 在电脑的控制面板内，双击“游戏控制器”-----“FS-i10 emulator”菜单，可测试发射机的模拟功能是否正常。

USB Function Details:

None: the USB interface can be used only to charge the battery of the transmitter.

FS-i10: when connected to a computer, the transmitter acts as a standard HID with 4 axes (one for each channel) and 10 buttons (1-10) and can be used as the main controller in any compatible simulation software.

1. Connect the transmitter to the computer by the Micro USB cable.
2. Switch on the transmitter, then touch **system-----USB function-----FS-i10 simulator**. After that, the computer will automatic identify the HID.
3. In the computer control panel, double click **Game controller-----FS-i10 emulator** to test whether the simulating function is ok.

摇杆模式 Sticks mode



(Pic 21.71)



(Pic 21.72)

此功能用于切换摇杆Mode1、2、3、4模式，切换后对应摇杆会自动切换。按复位键后复位至默认Mode2模式。
切换方法详见P18页说明。

This function is used to switch the Mode 1, Mode 2, Mode 3, and Mode 4. After mode switching, the relevant stick will switch automatically. Press reset button to Mode 2 by the default.

语言：

用户界面可用多种语言显示。

操作方法：

选择您要的语言,按返回键完成。

Language:

The user interface can be displayed in several languages.

Setup

Select the language you want and press return button to complete.



(Pic 21.73)

恢复出厂设置：

恢复发射机所有的数据到默认值。即所有模型的数值和其他设置将丢失,并恢复到默认状态。

点触确认按钮即可恢复出厂设置。

Factory reset :

Reset the whole configuration of the transmitter to its default. All model configurations and other settings are lost and reset to their default.

A confirmation is requested.



(Pic 21.74)

固件更新：

发射机的内部软件可以通过USB接口连接电脑进行升级。

一旦这个功能被激活,发射机所有的功能将停止。进入这种模式前请关闭接收机,避免模型失控。点触确认按钮即可实现硬件升级。

当硬件升级时,不要断开USB线或拔下电池,否则发射机将不能使用。

此功能需配合电脑完成,方式如下,

1. 下载最新官方软件。
2. 将遥控器与电脑通过USB线连接,
3. 进入遥控器固件更新界面并按“确定”

双击电脑已下载的软件图标,再点击“update”按钮,4秒左右后完成更新。



(Pic 21.75)

Firmware update:

The internal software of the transmitter can be updated using the USB interface connected to a PC computer. Once this function is activated, all functions of the transmitter stop. To avoid any loss of control of the vehicle, turn its receiver off before entering this mode. A confirmation is requested.

When the firmware is updating, never disconnect the USB cable or remove the battery or the transmitter will become unusable.

This function can be helpful only when connected with computer. Follow the steps as shown below:

1. Download the newest official software
2. Connect a transmitter with a computer by USB cable
3. Enter transmitter firmware upgrade menu and press OK to complete



(Pic 21.76)

关于FS-i10

此功能用于机器的版本查询。

点击“About FS-i10”,如右图所示,显示当前版本号及日期;点击键返回。

About FS-i10

Touch 'About FS-i10', and the version of the current firmware is as shown on the left. Touch the "OK" button to go back.

22. 固定翼机/滑翔机专有程序功能菜单 Airplane/glider exclusive function menu

22.01 副翼功能 Aileron function

功能说明:

此功能是针对模型副翼功能进行调整,可达到最佳控制效果。

副翼功能可调节飞机2个副翼舵量的比例;当结构没有副翼或2个副翼联动、没有襟翼且没有升降舵时,没有此功能,主菜单中没有此功能图标;如果飞机结构有两个襟翼或升降舵,调节对应的数值比例大于0%,即可当副翼功能使用。此功能可分别在5个状态下设定。

点触副翼功能下需设置下面或上面,滑动转轮调节相应数值。

如图22.1所示:飞机结构有2个副翼,2个襟翼,2个升降舵,点触选择了副翼下、上调节数值为80%,副翼2下、上面为80%,襟翼下、上面均为10%,襟翼2下、上面均为10%,升降舵下、上面均为10%,升降舵2下、上面为10%,在这种设定下飞机2个副翼舵量为80%,2个襟翼和2个升降舵均当副翼功能使用,舵量均为10%。

Function Details :

This function is used to adjust aileron function of models and give it best control.

Aileron function can be used to adjust the proportion of the 2 ailerons end points. If the structure does not have the aileron, 2 aileron linkage, flap or elevator, then there is no this function, and no icon will be displayed. It also can be used as aileron function if the airplane structure has 2 flaps or elevators, meanwhile the corresponding value be adjusted exceed 0%. This function can be set in 5 conditions respectively.

Select desired upside or downside and move the wheel to modify the corresponding value.

For this example: The airplane structure has 2 ailerons, 2 flap and 2 elevator. Setting the value as the picture 22.1, in this situation, the end points of the two ailerons are 80%, and the 2 flaps and 2 elevators are regarded as aileron function, which the end points both are 10%.

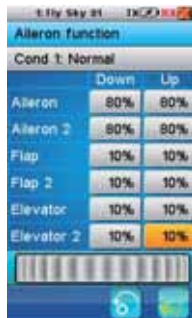

(Pic 22.1)

22.02. 襟翼功能 Flap function

功能说明:

当飞机结构副翼,襟翼或者升降只有一个或者一个以下时没有此功能,主菜单中没有此功能图标,如果飞机有副翼、襟翼、升降两个以上时,则此功能存在。

如果飞机结构有两个副翼,调节对应的数值比例大于0%,即可当襟翼功能使用;使用襟翼功能需要点触选择一个开关(SwA~SwH)来控制开启或关闭,或选择一个摇杆或旋钮(Ail、Ele、Thro、Rud、VRA~VRE)来控制数值大小。此功能可分别在5个状态下设定。

点触襟翼功能下需设置襟翼的下面或上面进行设置,滑动转轮调节相应数值。

如图22.2所示:飞机结构有2个襟翼,2个副翼,点触选择了襟翼下面调节数值为80%,襟翼2上数值为80%,副翼下、上面均为10%,副翼2下、上面均为10%,在这种设定下飞机2个襟翼舵量为80%,2个副翼当襟翼功能使用,舵量为10%。

Function Details :

This function is not available when aircraft structure has aileron, flap or only one elevator or less than one elevator, so there is no icon in the main menu. If aircraft has more than 2 ailerons, flaps and elevators, this function exist

The up/down travel of each flap can be adjusted independently at each servo according to the wing type. If the structure does not have an aileron, 2 ailerons linkage, flap or elevator, then this function is not available, and no icon will be displayed. It can be used as flap function. if the airplane structure has 2 ailerons, the corresponding value must be adjusted to more than 0%. The flap function can be assigned to a switch (SwA-SwH) to enable and disable it; it also can be assigned to a stick or a knob (Ail, Ele, Thro, Rud, VRA-VRE) to adjust the value. This function can be set in 5 conditions respectively.

Select desired upside or downside and move the wheel to modify the corresponding value.

For this example: The airplane structure has 2 flaps and 2 ailerons. Setting the value as the picture, in this situation 22.2, the end points of the two flaps are 80% and the 2 ailerons are regarded as flap function, which the end points are all 10%.

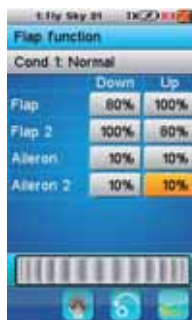

(Pic 22.2)

22.03 扰流板 Spoiler function

功能说明:

扰流板主要是在飞机降落时使用的,用于增加飞机与地面的压力,以及达到快速制动的效果。

扰流板可调节飞机的2个扰流板功能舵量的比例;当结构没有扰流板或2个扰流板联动时,没有此功能,即没有此功能图标;使用扰流板功能需点触选择一个开关(SwA~SwH)来控制,或选择一个摇杆或旋钮(Ail、Ele、Thro、Rud、VRA~VRE)来控制数值大小。此功能可分别在5个状态下设定。

点触扰流板功能选择下面或上面进行设置,滑动转轮调节相应数值。

如图22.3所示:飞机结构有2个扰流板,点触选择了扰流板下面、上面调节数值至80%,扰流板2下面、上面调节数值至75%,在这种设定下飞机2个扰流板舵量分别为80%、75%。

Function Details:

Spoiler will be used when aircraft is landing. It is used to increase pressure between aircraft and land so as to brake quickly

Spoiler function can be used to adjust the proportion of the 2 spoilers' end points. If the structure does not have spoiler or 2 spoiler linkage, then there is no this function, and no icon will be displayed. The spoiler function can be assigned to a switch (SwA-SwH) to enable and disable it, or be assigned to a stick or a knob (Ail, Ele, Thro, Rud, VRA-VRE) to adjust the value. This function can be set in 5 conditions respectively.

Select desired upside or downside and move the wheel to modify the corresponding value.

For this example: The airplane structure has 2 spoilers. Setting the value as the picture 22.3, in this situation, the end points of the 2 spoilers are 80% and 75%.



(Pic 22.3)

22.04 升降襟翼 Elevator to flap

功能说明:

当飞机结构有**升降舵**和**襟翼**时，用于调节飞机对应混控能量的比例，默认均为10%。飞机升降使襟翼跟随下降或者上升，最常用于飞行时做翻筋斗动作可使翻筋斗动作半径变小，增加动作的观赏性。在大多数情况下，当升降舵上升时襟翼就会下降；当结构没有**升降**或**襟翼**将没有**升降混控到襟翼**功能，即没有此功能图标。此功能可分别在5个状态下设定。

点触左下角开启按钮激活**升降混控到襟翼**功能，点触需设置的**低端比率**或**高端比率**进行设置，滑动转轮调节相应数值；可点触选择一个开关(SwA~SwH, LSw)来控制此功能的**开启或关闭**。

如图22.4, 22.5所示：点触开启按钮激活了**升降舵**和**襟翼**功能，点触选择**低端比率**调节数值至80%，**高端比率**调节数值至-60%，在这种设定下飞机**升降舵**打到最下边，**升降功能**应用后**通道输出**的位置显示在左边100，而**襟翼功能**显示在左边80；**升降舵**打到最上边，**升降功能**显示在右边100，而**襟翼功能**显示在左边60。

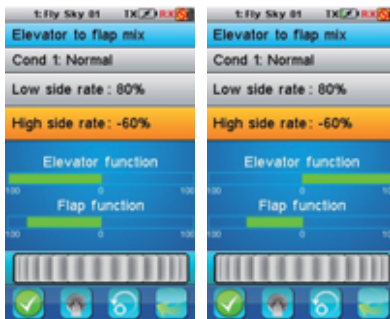

升降舵摇杆打到最下边
The elevator to the topside
(Pic 22.4)

升降舵摇杆打到最上边
The elevator to the bottom
(Pic 22.5)

Function Details:

When aircraft has **elevator** and **flap**, **elevator to flap function** is used to adjust the proportion of the corresponding mix end point, which default value is 10%. The airplane can fly up or down, which makes the flap move up or down accordingly. It is commonly used for turning somersaults during the flight. In most circumstances, the flap goes down when the elevator goes up. It is the pre-programmed mix of elevator and flap. The position of the corresponding channel is displayed in real time. If the structure does not have **Elevator** or **flap**, then this function is not available, and no icon will be displayed. This function can be set in 5 conditions respectively.

Touch the open button in the lower-left corner to activate the **elevator to flap** function, Select desired **upside** or **downside** and move the wheel to modify the corresponding value. The function can be assigned to a **switch** (SwA-SwH, LSw) to enable and disable it. Touch the open button in the lower-left corner to activate the elevator to flap function. Touch the low side rate or high side rate to set. Adjust the corresponding value by moving the wheel. The function can be assigned to a **switch** (SwA-SwH, LSw).

For this example: Activate the **elevator** function and the **flap** by touching the open button and set the value as shown in pictures 22.4 and 22.5. Push the **elevator** to the topside, the **elevator** and the **flap** function are displayed as shown in picture 22.4. Push the **elevator** to the bottom, the elevator and the **flap** function are displayed as shown in picture 22.5.

22.05 油针曲线 Throttle needle

功能说明：

当飞机结构有**引擎**并带有**油针**时，依据引擎动力输出特征进行**油针曲线**的设定，设定后**油针**位置将受**油门摇杆**影响，呈曲线变化，从而达到最佳控制效果。此设置可以调节**油针曲线**的11个点(L, 2~10, H)从0.0%调整到100.0%，水平的点线显示**油门摇杆**的即时位置，垂直的点线显示此功能应用后**油门油针**输出的即时位置；当结构没有**引擎**或有**引擎**没有**油针**时将没有**油针曲线**功能，主菜单中没有此功能图标。此功能可分别在5个状态下设定。

激活开启按钮后点触需设置的点进行设置，滑动转轮调节相应数值。

如图22.6所示：点触开启按钮激活了**油针曲线**功能，点触**开启**按钮激活了**油门曲线**功能，调节2点数值至20.0%，3点数值至36.5%，4点51.5%，5点64.0%，6点74.1%，7点80.0%，8点85.5%，9点90.0%，10点95.0%，在这种设定下**油门摇杆**在中位以下（即L, 2~6点）油门输出相对**油门摇杆**在中位以上（即6~10, H点）加油较快。

Function Details:

If the airplane structure has both an **engine** and a **needle**, set the **throttle needle** according to the features of **engine** power output. After that, the needle position effected by **throttle stick** will be presented with curve distribution, which can achieve a best flight effect. The 11 points (L, 2~10, H) of **throttle curve** can be adjusted from 0% to 100%. The horizontal dotted line displays in real time the throttle stick position, and the vertical dotted line displays in real time the position. If the structure does not have an **engine** or **engine** does not have a **needle**, then this function is not available, and no icon will be displayed. This function can be set in 5 conditions respectively.

Select the desired point and move the wheel to modify the corresponding value.

As shown in picture 22.6: Activate the **throttle needle** function by touching the open button. Setting the value as shown in picture 22.6. Point 2 is set to 20.0%, point 3 to 36.5%, point 4 to 51.5%, point 5 to 64.0%, point 6 to 74.1%, point 7 to 80.0%, point 8 to 85.5%, point 9 to 90.0% and point 10 to 95.0%. In this situation, when the position of the throttle is below the neutral, that is (L, 2~5), the acceleration of the **throttle needle** output is faster than its position above the neutral (that is 6-10, H point).

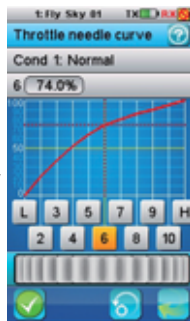

(Pic 22.6)

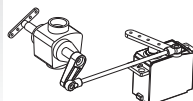

(Pic 22.7)

22.06 蝶形飞 Butterfly

功能说明:

当飞机结构有1个副翼、1个襟翼、1个扰流板、1个升降时，设定对应动作的比率，默认为+30%。此功能可同时移动副翼、襟翼、扰流板和升降，常用于使飞机进行急速下降动作或限制飞机在垂直俯冲时的速度增加。它可以通过开关及摇杆来进行开关或比率控制。以达到最佳飞行效果。当结构没有副翼、襟翼、扰流板、升降中其中一个将没有蝶形飞功能，即没有此功能图标。此功能可分别在5个状态下设定。

点触进入蝶形飞功能，点触需设置的部件进行设置，滑动转轮调节相应数值；可点触选择一个开关(SwA-SwH、LSw)来控制此功能的开启或关闭，或选择一个摇杆或旋钮(Ail、Ele、Thro、Rud、VRA-VRE)来控制数值大小。

如图22.8所示：调节副翼、副翼2、襟翼、扰流板、升降数值至20%，选择Vra旋钮来控制数值大小并调至最右边，进入显示舵机功能，此时CH1副翼、CH6副翼2通道显示为左20，其它均为右20，以达到限制速度的作用。



(Pic 22.8)

Vra旋钮调至最右边
Vra to the far right
(Pic 22.9)

Function Details:

If the airplane structure has 1 **aileron**, 1 **flap**, 1 **spoiler** and 1 **elevator**, it can be used to adjust the rate of the corresponding motion (the default rate is +30%). This function allows powerful brake operation by simultaneously raising the left and right ailerons and lowering the **flaps (camber flap, brake flap)**. It can be controlled by a switch or stick to achieve the best flight effect. If the airplane structure does not have any one of the **aileron**, **flap**, **spoiler** or **elevator**, then there is no this function, and no icon will be displayed. This function can be set in 5 **conditions** respectively.

Select the function and then adjust the relative parameter by touching the corresponding icon. Adjust the corresponding value by moving the wheel. Select a switch(SWA-SWH、LSW) by touching it to enable or disable this function or select a **stick** or **knob** (Ail、Ele、Thro、Rud、VRA-VRE) to control the value.

For this example, adjust the **aileron**, **aileron2**, **flap**, **spoiler** and **elevator** to 20% and select the knob to control the value. To the servo display function and then **CH1 (aileron)** and **CH6 (aileron2)** are displayed as picture 22.8 to limit the speed.

22.07 升降功能 Elevator function

功能说明:

此功能可调节飞机的2个升降功能舵量的比率，默认为100%；当结构没有升降或2个升降联动时，没有此功能，即没有此功能图标；此功能可分别在5个状态下设定。

点触升降功能下需设置升降的下面或上面进行设置，滑动转轮调节相应数值。

如图22.10所示：飞机结构有2个升降，点触选择了升降下面、上面调节数值至80%，升降2下面上面调节数值至75%，在这种设定下飞机2个升降舵量别为80%，75%。

Function Details:

This function can adjust the proportion of the 2 **elevators** end points and the default is 100%. There is no this functions if the airplane does not have the **elevator** or 2 **elevator** linkage. The function icon will not be shown on the screen. This function can be set in 5 conditions respectively.

Select the desired "Down" or "Up" and move the wheel to adjust the corresponding value.

For this example: The airplane has 2 **elevators**. Adjust the **Down** and **Up** value to 75%. In this situation, the **elevators** end points as shown in picture 22.10.

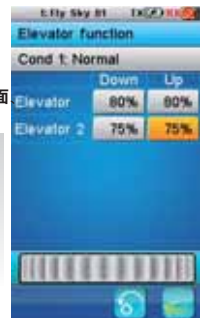

(Pic 22.10)

22.08 方向功能 Rudder function

功能说明:

此功能用于调节飞机当前状态下的2个方向舵功能舵量的比率，默认为100%；当结构没有方向或2个方向舵联动时，没有此功能，即没有此功能图标；此功能可分别在5个状态下设定。

点触方向功能下需设置方向的下面或上面进行设置，滑动转轮调节相应数值。

如图22.11所示：飞机结构有2个方向，点触选择了方向下面、上面调节数值至80%，方向2下面、上面调节数值至75%，在这种设定下飞机2个方向舵量分别为80%，75%。

Function Details:

Rudder function is used to adjust the proportion of the 2 rudders end points and the defaults are 100%. There is no function if the airplane does not have the **rudder** or 2 **rudder** linkage. The function icon will not be shown on the screen. This function can be set in 5 **conditions** respectively.

Select the desired "**Down**" or "**Up**" and move the wheel to adjust the corresponding value.

For this example: The airplane has 2 rudders. Adjust two rudders' value as picture 22.11. In this situation, the **rudder** end points will be 80% and 75% .



(Pic 22.11)

22.09 V型尾翼 V-tail

功能说明:

此功能是通过V型尾翼来控制模型的升降和方向的，默认CH2为飞机左边尾翼，CH4为右边，当尾翼同相转动时作升降功能用，反相转动时作方向功能用；此设置调整对应混控功能的比例，建议升降和方向功能比例之和不能大于100%，默认均为50%，当结构有V形尾翼且只有一个升降和方向功能才有此功能，更多或者更少将没有V形尾翼功能，即没有此功能图标。

点触V形尾翼下需设置的升降或方向比率进行设置，滑动转轮调节相应数值。

如图22.12、22.13所示：飞机结构有V形尾翼，点触选择了升降比率调节数值至60%，方向调节数值至40%，在这种设定下方向摇杆打到最左边时，CH2通道位置显示在左边40，CH4显示在右边40，打右边则反之，升降摇杆打到最上边或最下边时，CH2、CH4通道位置显示右边60或左边60，即达到升降功能。

Function Details:

This function is used to control **elevator** and **rudder** of models with **V-tails**. CH2 is a left **V-tail** by default and CH4 is right **V-tail**. When both **V-tails** move in the same direction ,they act as **elevators** and when both **V-tails** move in the opposite direction. This function lets users adjust for left and right **rudder** angle changes at **elevator** and **rudder** operation of a **V-tail** airplane. **V-tail** is when 2 servos are used together to control **rudder** movement as **Elevators**. In addition to each **rudder** side moving up and down together, each side moves in opposite directions when moving as **Elevators**. It is better that the sum of the **rudder** proportion and **elevator** proportion is no more than 100%. The defaults are 50%. The position of the corresponding channel displays in real time while moving the stick.

Select the **elevator** rate or **rudder** rate to set and move the wheel to adjust the corresponding value.

For this example: The airplane structure with the **V-tail**, will adjust the value as shown in pictures 22.12 and 22.13. Move the **rudder** stick to the far left, then CH2 channel displays at the position of 40 on the right. On the contrary, move the **rudder** stick to the far right, then CH4 displays at the position of 40 on the left. Moving the **elevator** stick to the topside or the bottom, both of the CH2 and CH4 display at the position of 60 on the right or on the left at the same time, then the **elevator** function.



方向摇杆打到最左边
The rudder to the far left
(Pic 22.12)

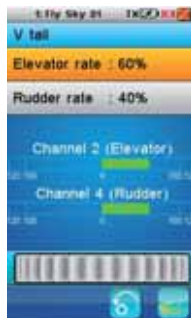

升降摇杆打到最上边
The elevator stick to the topside.
(Pic 22.13)

22.10. 飞机结构 Airplane structure

功能说明:

此功能可根据飞机的结构自行设定的模型结构。

飞机结构当设置模型类型为固定翼/滑翔机时，有引擎、油针、副翼、两个副翼、襟翼、两个襟翼、扰流板、两个扰流板、升降、两个升降、方向、两个方向、V型尾翼可供选择，当选择10个以上飞机部件时，将提示“超过了最大通道数”；(如图22.16)因为2个方向和V型尾翼不可能同时存在，所以选择2个方向时，V型尾翼自动隐藏。默认固定翼/滑翔机类型飞机部件为引擎、副翼、升降、方向的教练机；

Function Details:

This function can be set according to the airplane structure.

There are **engine**, **throttle needle**, **aileron**, **two aileron**, **flap**, **two flap**, **sopiler**, **two spoiler**, **rudder**, **two rudder**, **V-tail** to choose if the mode type is **fix wing** or **glider**. There will be a reminder **Maximum number of channels reached.** if the airplane parts selected is more than 10. Because the **two rudders** and **V-tail** can not exist at the same time, the **V-tail** will be hidden automatically when **two rudders** is selected. The default type is **Fix wing**/glider with **engine**, **aileron**, **elevator** and **rudder**.



(Pic 22.14)
飞机结构清单
airplane list



(Pic 22.15)
超过最大通道数
Maximum number
of channels reached

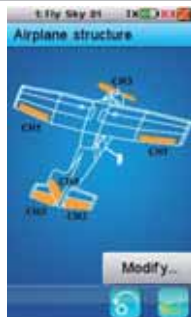

(Pic 22.16)

默认固定翼/滑翔机类型飞机
Default airplane/glider type

2.3. 直升机专有程序功能菜单 Helicopter exclusive function menu

2.3.01. 油门保持 Throttle hold

功能说明:

此功能用于锁定**油门通道**处于设定位置，默认比率为10.0%。即开启此功能时油门已锁定。它常用于练习自旋着陆。

点触进入**油门保持**进行设置，滑动转轮调节相应数值，可点触选择一个开关 (SwA~SwH, LSw) 来控制此功能的**开启或关闭**。

如图23.1所示：**油门保持**数值设定为30.0%，选择SwA向上为**开启**，油门通道即时显示至30，并提示**油门已保持**，拨动**油门摇杆**，通道将保持在30。

Function Details :

This function is used to maintain the **throttle channel** position as preset position. The default rate is 10.0%. Throttle will be in preset position after this function is applied. It is commonly used to practice auto-rotation landing.

Touch the **throttle hold** and move the wheel to modify the corresponding value. This function can be assigned to a **switch** (from SwA to SwH, LSw).

For this example: **Throttle hold** value is set to 30% and push the SwA **upward** to enable this function. The channel position is displayed at 30 in real time. Throttle value will not be changed while moving the **throttle stick**.



油门摇杆打到任意位置
Throttle stick to any position
(Pic 23.1)

2.3.02. 油门混控 Throttle mix

功能说明:

此功能是针对一些特别功能进行的预编程混控，可对**副翼**，**升降**，**方向**三个通道混控，默认值如图所示。此功能可分别在5个**状态**下设定。例如直升机前进时为了不降高度和保持速度，从而在控制**升降**的同时自动增加设定比率的油门输出，便可实现。

激活开启按钮后点触需设置通道的**下面或上面**，滑动转轮调节相应数值。

如图23.2所示：**副翼下面**数值设定为-15%，**上面**为15%，其它不设定。

Function Details :

This function is the pre-programmed mix for some special functions and it can mix **aileron** channel, **elevator** channel and **rudder** channel. The default is as shown in picture 23.2. This function can be set up in 5 **conditions**. For example, in order to not reduce the height and maintain speed, control the **elevator** and increase the throttle output automatically.

Select the desired **Down** or **Up** and move the wheel to modify the corresponding value.

As shown in the picture 23.2: The value of the **aileron downside** is set as -15% and the value of the **upside** is 15%.

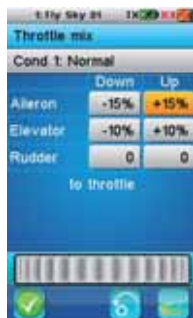

(Pic 23.2)

2.3.03. 螺距曲线 Pitch curve

功能说明:

此功能用于调整可变螺距直升机的螺距，呈曲线变化，以达到最佳的飞行效果。此设置可以调节**螺距曲线**的11个点 (L, 2~10, H) 从0%调整到100%，垂直的点线显示**油门摇杆**的即时位置，水平的点线显示此功能应用后**螺距曲线**输出的即时位置；当结构为固定螺距时将没有**螺距曲线**功能，主菜单中没有此功能图标。此功能可分别在5个**状态**下设定。

激活开启按钮后点触需设置的点进行设置，滑动转轮调节相应数值。

如图23.3所示：点触开启按钮激活了**螺距曲线**功能，调节2点数值至-72%，3点数值至-43% 4点至-15%，5点10%，6点38%，7点63%，8点85%，9点97%，其它点数值默认不调节，在这种设定下**油门摇杆**在中位以下（即L, 2~5点），**螺距曲线**输出相对**油门摇杆**在中位以上（即6~10, H点）变化较快。

Function Details :

This function is used to adjust the pitch of the helicopter with the variable pitch to achieve the best flight effect. It will be presented with curve distribution. This function can be set up in 5 **conditions** respectively, and the 11 points (L, 2~10, H) of **throttle curve** can be adjusted from 0% to 100%. The horizontal dotted line displays in real time the **throttle stick** position and the vertical dotted line displays in real time the position of **pitch curve** output after this function. This function icon will not be shown if the structure is fix pitch.

Select the desired point and move the wheel to modify the corresponding value.

For this example: The **pitch curve** function is activated. Point 2 is set to -72%, point 3 to -43%, point 4 to -15% and point 5 to 10%, point 6 to 38%, point 7 to 63%, point 8 to 85%, and point 9 to 97%. Other points are not adjusted. In this situation, when the position of the **throttle** is below the neutral, that is (L, 2~5), the acceleration of the **pitch curve** output is faster than its position above the neutral (that is 6~10, H point).



(Pic 23.3)

23.04. 倾斜盘混控 Swashplate mix

功能说明:

此功能是对直升机副翼、升降、螺距的行程进行调整的一项功能参数设定，以达到最佳的飞行效果。此功能可分别在5个状态下设定。

点触需设置的点进行设置，滑动转轮调节相应数值。

Function Details:

This function is the pre-programmed mix control of the helicopter **aileron**, **elevator** and **pitch**. Adjust the motion range of these three functions to achieve the best flight effect. This function can be set in 5 **conditions** respectively.

Select the desired point and move the wheel to modify the corresponding value.



(Pic 23.4)

23.05. 结构 structure

当设置模型类型为直升机时，有固定螺距、可变螺距、油门油针、陀螺仪、定速设定可供选择，其它可变螺距可选择6种倾斜类型。默认直升机类型飞机部件为固定螺距的4通道直升机。

Function Details:

There are **fixed pitch**, **variable pitch**, **throttle needle**, **gyros copeand governor** for your option if the airplane structure is set as helicopter. The variable pitch has 6 swash plate types. The default type is the 4-channel **fixed pitch helicopter**.

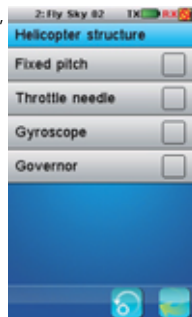

模型类型为直升机
Model type is helicopter
(Pic 23.5)

23.06. 倾斜类型 Swashplate type

功能说明:

此功能可根据飞机的结构自行设定你的模型结构。倾斜类型可选择7个不同类型直升机倾斜盘结构,用于对应市面已有的7种直升机倾斜盘结构类型。

点触进入倾斜类型进行选择，默认为固定螺距。

Function Details:

This function is used to set your model structure And it offers 7 types of swash plate structure Touch the Swash plate type to select desired type. It defaults to fixed pitch.

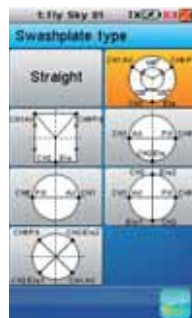

(Pic 23.6)

23.07. 倾斜盘环 Swashplate ring

倾斜盘环是对倾斜盘做行程输出设定限制，以达到最佳的飞行效果。激活开启按钮后滑动转轮调节相应数值。

This function is to set limitation for the swash plate travel to achieve the best flight effect. Move the wheel to modify the corresponding value.



(Pic 23.7)

23.08. 定速设定 Governor

定速设定是一个新功能，主要是针对有定速控制功能的直升机，锁定螺旋桨转速。当飞机结构有**定速设定**时此功能默认为CH7。此功能还需定速器一起配合才能实现。此功能可分别在5个状态下设定。

点触进入**定速设定**进行设置，滑动转轮调节相应数值。

This new function is mainly used for maintaining the propeller speed. The default channel is CH7. It can be set in 5 conditions respectively. Move the wheel to modify the corresponding value.



(Pic 23.8)

23.09. 陀螺仪 Gyroscope

此功能用于调整**陀螺仪**的感度，感度越高，**陀螺仪**修正的越多，直升机敏感度就更强或不易响应。当飞机结构有**陀螺仪**时此功能默认为CH5。此功能可分别在5个状态下设定。

点触进入**陀螺仪**进行设置，滑动转轮调节相应数值。

This function is used for adjusting the gyro sensitivity in current conditions. The higher the sensitivity is, the more correction the gyro provides and the "softer" or less responsive the helicopter feels. The default channel is CH5 and this function can be set in 5 conditions respectively.

Move the wheel to modify the corresponding value.

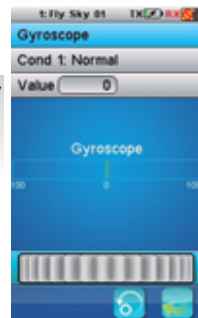

(Pic 23.9)

24. 报警功能说明 Warning function introduction

声音报警

1. 发射机电量不足，电压低于3.75V时，系统发出慢的警报声响。
2. 接收机电量不足，低于设定的报警电压时，系统发出“叭，叭”声响。
3. 误码率超过60%时，系统发出“嘟，嘟”声响。
4. 计时到达时，系统发出闹铃“Bi,Bi,Bi,Bi”声响三次。
5. 自动关机报警时，系统发出“嘟，嘟，嘟”的声响。
6. 发射机电量严重不足，电压低于3.7V时，系统发出快的警报声响，当电压低于3.65V时，发射机将自动关机。

Audible alarm

1. When the transmitter battery is low and the voltage is lower than 3.75 V, the system will make alarm which sounds slowly.
2. If the voltage is lower than setting data due to low battery of receiver, the system will make a sound "Ba,Ba".
3. When the error rate is more than 60%, the system will make a sound "Du,Du".
4. When the timer goes off, the system will make a sound "Bi, Bi, Bi, Bi" three times.
5. Before the transmitter is turned off automatically, the system will make a sound "Du Du Du".
6. When the transmitter's battery voltage is lower than 3.7 V, the system will make alarm which sounds quickly. When the voltage is lower than 3.65 V, the transmitter will be turned off automatically.

LED报警

LED报警与声音报警功能同步，但关闭声音报警，LED报警不会关闭。有以下几种情况：

1. LED常亮：各项功能状态正常。
2. LED慢闪：发射机电量不足。
3. LED快闪：
发射机电量严重不足，
误码率超过60%，
接收机电量不足，
自动关机报警。
4. LED不亮：关机状态。

LED indicator alarm:

LED indicator alarm function synchronizes with audible alarm function. It has no effect on LED indicator after turning off the audible alarm. Please check as follows:

- 1.The LED remains on: all functions are normal.
- 2.The LED flashes slowly: the transmitter battery is low.
- 3.The LED flashes quickly:
The battery of the transmitter is very low,
Error rate is more than 60%,
The battery of receive is low,
The transmitter will turn itself off soon.
- 4.LED indicator is off: power off.

25. 常见故障说明 Troubleshooting guide

常见故障说明

- 1.发射机不能开机
电池安装不到位，
电池电量不足，
开机时屏幕会闪一下，然后又关闭，表示电量不能维持系统长时间开机，开机瞬间就马上关闭，
电池弹片氧化，接触不良。
- 2.遥控距离不够
发射机或接收机天线摆放位置不对，
附近有无线电干扰，
电池电量不足，
有障碍物遮挡，屏蔽掉部分信号。
- 3.发射机不能遥控接收机
发射机或接收机误进入对码状态，重开机即可，必要时需重新对码。
- 4.多人同时比赛时，发射机有时收不到接收机反馈回来的数据
两台发射机间的距离太近，尽可能保持5米以上。
- 5.发射机屏幕内不显示采集模块的编号
采集模块的数据线插错位置，
数据线插头松脱，破损，断线。
- 6.转速采集的数据不稳定
转速传感器位置摆放不当，偏离太远。
- 7.电脑找不到模拟器
发射机USB模拟器没有打开。

Problem solving

- 1.The transmitter can not be turned on
The battery is not properly installed,
Battery is empty,
The screen flashes when the transmitter is powered on, and then the transmitter turn itself off immediately, It indicates the electric quantity can't support system for a long time and the transmitter will be turned off once it is powered on,
The battery shrapnel is oxidized and loose contact.
- 2.Remote control distance is not enough
The wrong position of transmitter antenna or receive antenna,
Nearby radio interference,
Battery is empty,
Obstacle blocks off part of the signal.
- 3.The transmitter can't control the receiver
The transmitter or receiver enters into the bound status by accident. The problem can be solved by powering on again or binding again if necessary
- 4.The transmitter may not accept the data sent by the receiver sometimes when many people race at the same time
The distance between two transmitters is too close, Please keep more than 5 meters as far as possible.
- 5.The item number of acquisition module does not appear in the transmitter screen
The data cable of acquisition module is connected to the wrong place,
The plug of data cable is damaged.
- 6.Unstable data speed acquisition
The position of speed sensor is not proper, which drifts too far.
- 7.The simulator can not be checked on the computer
The USB simulator function of transmitter is not activated.

26. 功能逻辑关系 Function tree

输入处理 Input processing

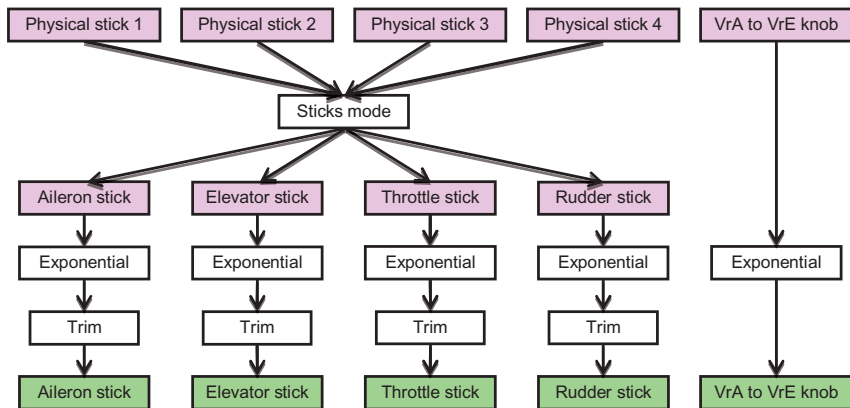

固定翼运行处理 Airplane processing

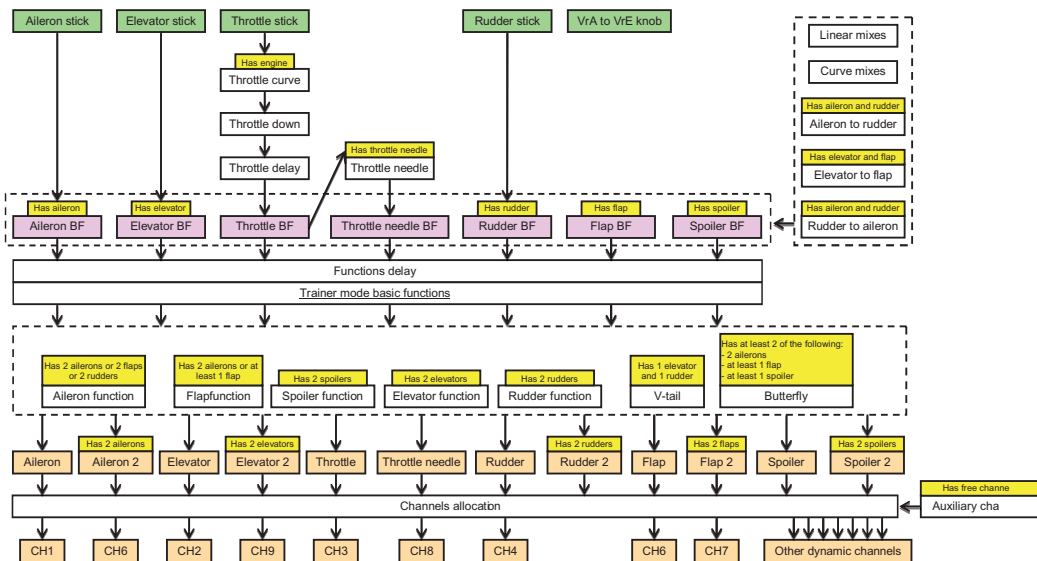

Digital proportional radio control system FS-110



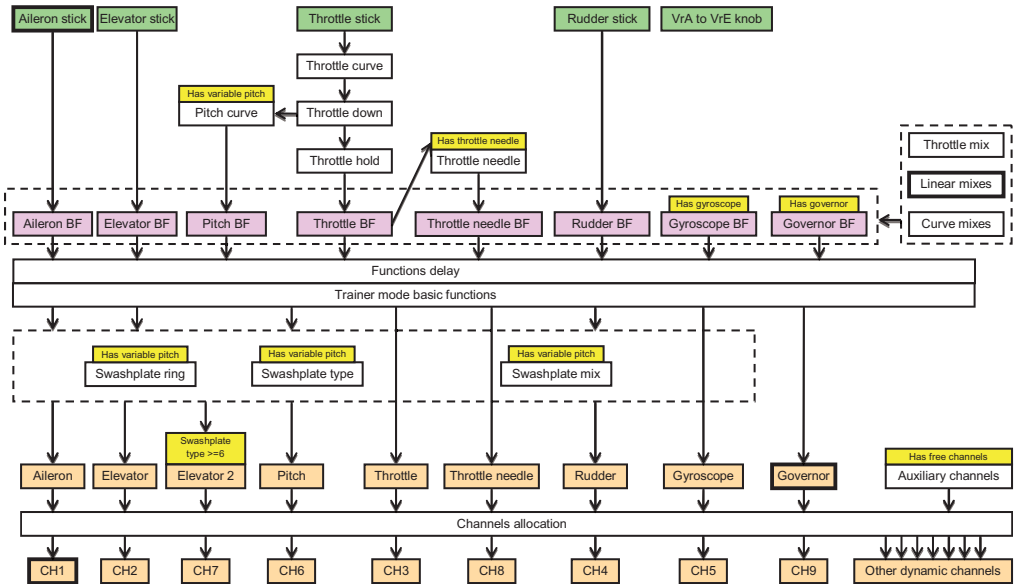



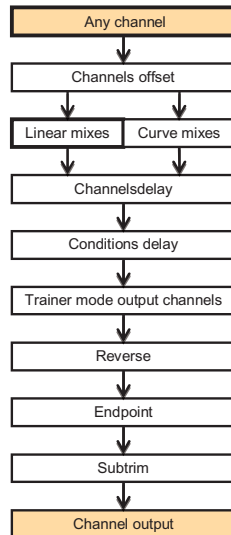

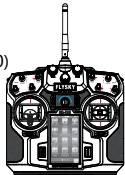

直升机运行处理 Helicopter processing

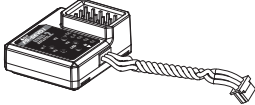

输出处理 Output processing



27. 包装内容 Packaging content

NO:	Model	Sum	Remarks
1	10通2.4G发射机 10 Channel 2.4G Transmitter (FS-i10) 	1	
2	10 通 2.4G接收机 10 Channel 2.4G receiver (FS-iR10) 	1	
3	锂电池 FS-BA1700 	1	
4	Micro USB线 USB cable 	1	
5	手写笔 Stylus 	1	
6	说明书 User manual 	1	CD
8	FS-SEV01 i-BUS 串行总线接收机 i-bus receiver connection instruction 	1	可选的 Optional
9	FS-SPD01 磁感应转速采集模块 Data telemetry connection 	1	可选的 Optional
10	FS-SPD02 光感应转速采集模块 RPM telemetry (optical) module connection 	1	可选的 Optional
11	FS-STM01 温度采集模块 Temperature telemetry module connection 	1	可选的 Optional
12	FS-SVT01 外部电压采集模块 External voltage telemetry module connection 	1	可选的 Optional
13	电源适配器 Adapter  USB cable 标准USB线  FS-BC101 充电器 Charger 	1	可选的 Optional
14	教练线 Trainer cable 	1	可选的 Optional

28. FCC 声明 FCC Statement

FCC Statement

This equipment has been tested and found to comply with the limits for a Class B digital device pursuant to part 15 of the FCC rules. These limits are designed to provide reasonable protection against harmful interference in a residential installation. This equipment generates, uses and can radiate radio frequency energy and, if not installed and used in accordance with the instructions, may cause harmful interference to radio communications. However, there is no guarantee that interference will not occur in a particular installation. If this equipment does cause harmful interference to radio or television reception, which can be determined by turning the equipment off and on, the user is encouraged to try to correct the interference by one or more of the following measures:

- Reorient or relocate the receiving antenna.
- Increase the separation between the equipment and receiver.
- Connect the equipment into an outlet on a circuit different from that to which the receiver is connected.
- Consult the dealer or an experienced radio/TV technician for help.

To assure continued compliance, any changes or modifications not expressly approved by the party responsible for compliance could void the user's authority to operate this equipment.

(Example use only shielded interface cables when connecting to computer or peripheral devices).

This device complies with Part 15 of the FCC Rules. Operation is subject to the following two conditions:

- (1) This device may not cause harmful interference, and
- (2) This device must accept any interference received, including interference that may cause undesired operation.

Changes or modifications not expressly approved by the party responsible for compliance could void the user's authority to operate the equipment.

The antenna(s) used for this transmitter must be installed to provide a separation distance of at least 20 cm from all persons and must not be co-located or operating in conjunction with any other antenna or transmitter.

Caution!

The manufacturer is not responsible for any radio or TV interference caused by unauthorized modifications to this equipment. Such modifications could void the user authority to operate the equipment.



Digital propotional radio control system

CE0678FC

<http://www.flysky-cn.com>

Copyright©2013-2017

Flysky RC model technology Co., Ltd