

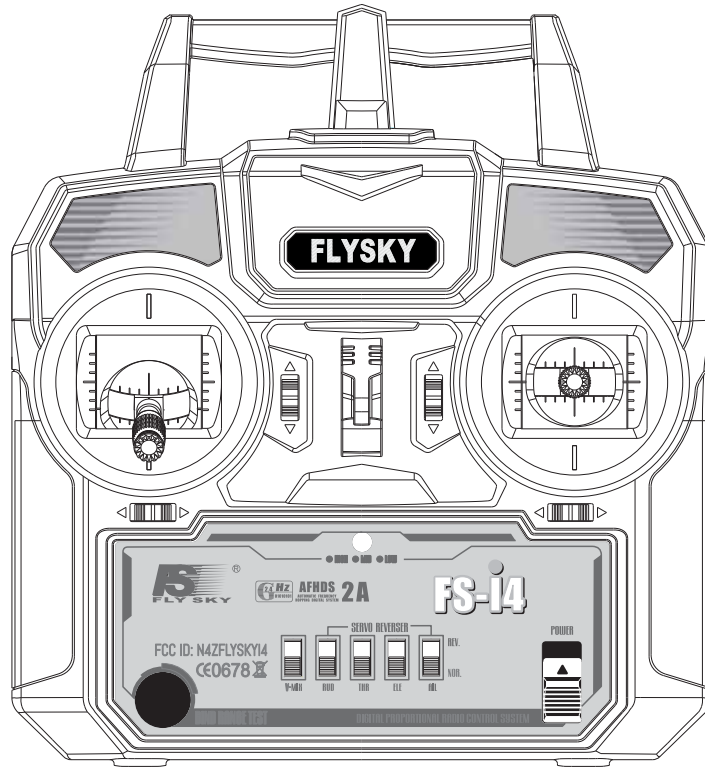

# FS-i4

Digital proportional radio control system

## INSTRUCTION MANUAL 用户手册



<http://www.flysky-cn.com>

Copyright ©2013-2017  
FlyskyRC model technology co., ltd

**WARNING:**  
This product is suitable for  
15 years old and above  
本产品不适合15岁以下儿童使用

CE0678FC

## 目录

1、 Introduction 简介.....	2
2、 Services 服务.....	2
3、 Special symbols 特殊标志.....	3
4、 Safety guide 安全指导.....	3-4
5、 2.4GHz System 2.4G系统.....	5
6、 System characteristic 系统特征.....	6
7、 Switch the system between AFHDS and AFHDS2 AFHDS与AFHDS2A系统模式互换.....	6
8、 Transmitter specifications 发射机参数.....	7
9、 Receiver specifications 接收机参数.....	7
10、 Operation receiver instruction 接收机操作说明.....	8
10.01, Receiver and servo connections 接收机与伺服器连接.....	8
10.02, Receiver specifications 接口说明.....	8
10.03, Binding 对码.....	9
11、 Definition of key functions 按键定义.....	10
12、 Right and left stick can be adjustable 左右手摇杆模式调整.....	11
13、 Power on 开机.....	12
14、 Shut down 关机.....	12
15、 Function description 功能说明.....	13
15.01, 1 Channel control 1通道控制.....	13
15.02, 2 Channel control 2通道控制.....	13
15.03, 3 Channel control 3通道控制.....	14
15.04, 4 Channel control 4通道控制.....	14
16、 Packaging content 包装内容.....	15
17、 FCC Statement 声明.....	15

# Digital proportional radio control system **FS-i4**

## 1. Introduction 简介

Thank you for choosing the Fly Sky FS-i4 4 channels 2.4GHz AFHDS2A computerized digital proportional R/C airplane and helicopter system. If it's your first use of a computerized radio system, this user manual will bring you easily to a new world of fun and sophistication. In all cases, please read carefully and completely this user manual as it contains all information to keep you safe.

感谢您选择富斯出品的FS-i4四通道2.4G可编程AFHDS2A第二代增强版自动调频数字系统，该系统可兼容飞机和直升机两种模式。如果这是您第一次使用可编程遥控系统，这本使用手册将很快地带给您一个有趣又高端的全新世界。因此，为了确保您安全使用本产品，请仔细地完整阅读这本使用手册。

## 2. Services 服务

If you encounter any problem during use, please refer to this manual. If the problem still persists, please contact your local dealer or connect to our service and support website:

<http://www.flysky-cn.com>

如果您使用时遇到任何问题，请参照此说明书。如果您的问题仍然未能解决，请直接联系当地经销商或者我们网站上的客服人员。

<http://www.flysky-cn.com>

### 3. Special symbols 特殊标志

Please pay attention to the following symbols when they appear in the manual and read carefully.

当以下标志出现在说明书的时候请注意并且仔细阅读。

 **Danger:** Not following these instructions may expose the user to serious injuries or death.  
如果使用者不按照说明方法操作，有可能导致使用者严重受伤，甚至致命的危险。

 **Warning:** Not following these instructions may expose the user to serious injuries.  
如果使用者不按照说明方法操作，有可能导致使用者严重受伤。

 **Attention:** Not following these instructions may expose the user to minor injuries and even to serious injuries.  
如果使用者不按照说明方法操作，有可能导致使用者外伤，甚至严重受伤。

 **Prohibited**  
禁止

 **Mandatory**  
强制

### 4. Safety guide 安全指导





 Don't fly at night or in bad weather like rain or thunderstorm as this can cause erratic operation or loss of control.  
请不要在夜晚或者雷雨天使用此产品，因为恶劣的天气环境有可能导致遥控设备失控。

 Make sure moving direction of all motors be same with the operating direction. If not, please adjust direction first.  
操控时，请先确认模型所有舵机的动作方向与操控方向一致。  
如果不一致，请调整好正确的方向。

 The shutdown sequence must be to first disconnect the receiver battery then to switch off the transmitter, if the transmitter is switched off while the receiver is still powered, it may lead to uncontrolled movement or engine start and may cause an accident.  
关闭时，请务必先关闭接收机电源，然后关闭发射机，如果关闭发射机电源时接收机仍然在工作，将有可能导致遥控设备失控或者引擎继续工作而引发事故。

 In particular, the 2.4G R/C system will affect the plane or the car nearby after you turn on the transmitter.  
特别要注意，如果附近有汽车正在运行或飞机正在飞行，开机后2.4 GHz RC系统可能会影响到他们。

# Digital proportional radio control system **FS-i4**

-  Do not operate outdoors on rainy days, run through puddles of water or use when visibility is limited. Should any type of moisture (water or snow) enter any component of the system, erratic operation and loss of control may occur.
- 不要在户外雨天，有水的地方或当能见度有限的时候使用。  
可能水分(水或雪)会进入到系统内部，不稳定的运行和失控可能发生。
- Do not operate in the following places:  
Near other sites where other radio control activity may occur,  
Near people or roads,  
On any pond when passenger boats are present,  
Near high tension power lines or communication broadcasting antennas,  
Interference could cause loss of control,  
Improper installation of your Radio Control System in your model could result in serious injury.
-  不要操作在以下的地方：  
基站附近或其他无线电活跃的地方，人多的地方或道路附近，  
有客船的水域，高压电线或通信广播天线附近，干扰可能导致失控，  
安装不正确，无线电控制系统可能导致模型发生严重的伤害。
-  Do not operate this R/C system when you are tired, not feeling well or under the influence of alcohol or drugs. Your judgment is impaired and could result in a dangerous situation that may cause serious injury to yourself as well as others.
- 当你感到疲倦，饮酒或吸毒后，不舒服的影响下，不要操作这个R / C系统。  
判断力下降，而且可能发生危险的情况下，对自己或他人可能造成严重的伤害。
-  Do not touch the engine, motor, speed control or any part of the model that will generate heat while the model is operating or immediately after its use. These parts may be very hot and can cause serious burns.
- 当模型操作或使用后，请勿触摸发动机、电机、定速设定或任何可能发热的部分，  
这些部分可能非常热，会造成严重的烧伤。
- Please have an overall check about the model before any operation.  
Any problem in radio control system or improper installation may cause out of control.  
Simple distance test methods:  
One hold the model, and the other one carry the transmitter to a proper place to check the servo system condition.  
Please stop operation if any exceptional case occurs.  
Please check the model memory to make sure the matching is right.
- 总是在操作模型之前进行全面的检查。  
无线电控制系统出现问题以及不正确安装，都有可能导致模型失控，  
简单的距离测试方法：一个人把持模型另一个人持发射机走开，检查该伺服系统运转情况。  
测试时要注意到若有异常出现，请不要操作模型。  
也检查模型的记忆，以确保模型的匹配是适当的。
-  Turn on the power, please check if the throttle neutral position is in its lowest position while turning on the transmitter every time. When making adjustments to the model, do so with the engine not running or the motor disconnected, you may unexpectedly lose control and create a dangerous situation.
- 开机时，每次都要检查发射器的油门中位是否是最低。  
当发射机作出调整时，可能模型的引擎没有运行或电机没有连接，可能会发生失控或意外事故的情况。

## 5. 2.4GHz System 2.4G系统



AFHDS2A stands for "Automatic Frequency Hopping Digital System 2A". This highly sophisticated radio transmission system will guarantee you a long range, jamming free and long battery life experience. This is the result of years of research and testing and makes Fly Sky one of the world leader in the market.

AFHDS2A是第二代增强版自动跳频数字系统的简写。它是一个高度精密的遥控信号传播系统，这个系统能够提供良好的距离，抗干扰能力强并且耗电量低。它是世界领先的遥控制造商之一——富斯遥控模型技术有限公司研发并测试多年的成果。

### RF specifications:

RF range: 2.4055-2.475GHz  
 Channel bandwidth: 500KHz  
 Number of channels: 142  
 RF power: less than 20dBm  
 RF mode: AFHDS2A. Second generation automatic frequency hopping digital system.  
 (Including the first generation system)  
 Modulation type: GFSK  
 Antenna length: 26mm\*2(dual antenna)

### 参数说明:

频率范围: 2.4055-2.475GHz  
 波段宽度: 500KHz  
 波段个数: 142个  
 发射功率: 不高于20dBm  
 发射模式: AFHDS2A第二代增强版自动跳频数字系统  
 (含第一代系统)  
 编码方式: GFSK  
 天线长度: 26毫米\*2(双天线)

### Danger:

Misuse of this radio system can lead to serious injuries or death. Please read completely this manual and only operate your radio system according to it.

The 2.4GHz radio band has a completely different behavior than previously used lower frequency bands. Keep always your model in sight as a large object can block the RF signal and lead to loss of control and danger. The 2.4GHz RF signal propagates in straight lines and cannot get around objects on its path. Never grip the transmitter antenna when operating a model as it degrades significantly the RF signal quality and strength and may cause loss of control and danger

#### 警告!

错误使用遥控设备将可能导致严重的伤害甚至死亡。请在使用前完整阅读这本使用手册，并且在使用过程中严格按照此手册的说明操作。

该2.4G无线电波段完全不同于之前所使用的低频无线电波段。使用时要保持您的模型产品飞行在您的视线范围内，因为大的障碍物将会阻断无线电频率信号从而导致遥控失控和危险。2.4G无线电频率信号是沿直线传播的，它不能绕过障碍物进行传播。在使用过程中，严禁紧握发射机天线，否则将会大大减弱无线电传播信号的质量和强度，导致遥控设备失控和危险。

### Danger:

Always turn on the transmitter first then the receiver. When turning off the system, always turn off the receiver first then the transmitter. This is to avoid having the receiver on itself as it may pick a wrong signal and lead to erratic servo movements. This is particularly important for electric powered models as it may unexpectedly turn on the motor and lead to injuries or death.

A separation distance of at least 20 cm from all persons is required during operation.

#### 警告!

每次使用时，必须先打开发射机，然后再给接收机通电。停止使用时，必须先断开接收机电源，然后再关闭发射机。这样操作可以避免接收机接收到错误信号而导致的伺服器无规律的抖动。这对于电动模型来说尤为重要，因为它有可能导致马达突然转动而致人员伤亡。

多人一起操作的时候 间距至少要20CM以上。

# Digital proportional radio control system **FS-I4**

## 6. System Characteristic 系统特征

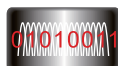

This radio system works in the frequency range of 2.405 to 2.475GHz. This band has been divided into 142 independent channels. Each radio system uses 16 different channels and 160 different types of hopping algorithm. By using various switch-on times, hopping scheme and channel frequencies, the system can guarantee a jamming free radio transmission.

此系统工作频率范围是2.405到2.475GHz。整个波段被分为142个独立频点。每套遥控系统使用16个不同频点和160种不同的跳频算法。通过开机时间不同，跳频规律不同和使用不同的频点，遥控系统能避免干扰传播信号。



This radio system uses a high gain and high quality multi directional antenna. It covers the whole frequency band. Associated with a high sensitivity receiver, this radio system guarantees a jamming free long range radio transmission.

此系统采用高质量的增益天线，覆盖整个波段带宽。配合高灵敏度接收机，系统能有效的避免远距离传播信号的干扰。



Each transmitter has a unique ID. When binding with a receiver, the receiver saves that unique ID and can accept only data from that unique transmitter. This avoids picking another transmitter signal and dramatically increases interference immunity and safety.

每台发射机有一个唯一的ID码，当和接收机对码之后，接收机保存这个唯一的ID码并且只接受从这个ID码发射机发出的信号。这样可以避免接收到别的发射机信号，大大增强抗干扰能力和安全性。



This radio system uses low power electronic components and a very sensitive receiver chip. The RF modulation uses intermittent signal transmission thus reducing even more power consumption. Comparatively, this radio system uses only a tenth of the power of a standard FM system.

此系统使用低功率电子元件和高灵敏度接收机芯片。无线电频率模块采用间歇性信号传播，因此大大降低了发射功率。比较而言，此系统功耗仅为FM版本的十分之一。



This system uses the two-way communication, which could control the working state of current model better and make the operation more enjoyable and safer than before.

此系统采用信息回传功能，此功能更好的掌握当前模型的工作状态。从而增添了操控乐趣以及更加安全控制模型。

## 7. Switch the system between AFHDS and AFHDS2

### 系统模式切换 AFHDS AFHDS2A

- 1 摇杆打到左下角。  
Move the stick to lower-left corner
- 2 开机，进行系统模式切换。  
Turn on the transmitter and switch the system
- 3

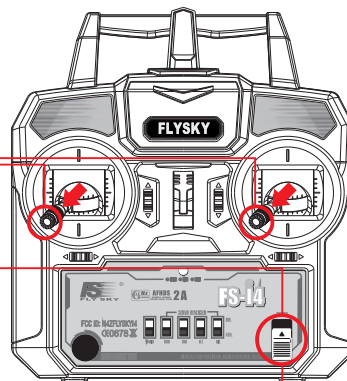

开机后，如果只有LED灯闪（闪烁周期为1S）的话，为AFHDS系统，然后关机保存为AFHDS系统；

开机后，如果既有LED灯闪（闪烁周期为1S），同时又有蜂鸣器“滴滴”响，表示已切换到了AFHDS2A系统。

It is the AFHDS system if the LED flashes and flash period is 1 second after turning on the transmitter. Turn off the radio to save the system as AFHDS.

After turned on, if both LED lights blink (blinking 1S), and there is buzzer "drops" sound at the same time, which means that the system has been switched to the AFHDS2A

## 8. Transmitter specifications 发射机参数

### Transmitter specifications:

Number of channels: 4  
 Model type: fixed-wing/glider/ helicopter  
 Channel resolution: 1024 steps  
 Power supply: 6V (1.5V AA x4)  
 Low voltage warning: <4.2. Red LED will flash  
     4.2-4.5V Red  
     4.6-5V Orange  
     5-6V Green  
     <3.2V Buzzer goes off to alarm  
 2.4GHz type: AFHDS2A. Second generation automatic frequency hopping digital system.  
 (Including the first generation system)  
 (When it is equipped with two-way receiver, single and bidirectional mode can be interchangeable)  
 Antenna length: 26mm\*2 ( dual antenna)  
 Color: Black  
 Size: 174\*89\*190mm  
 Weight: 335g  
 Certification: CE, FCC

  
**MODELS: FS-I4**

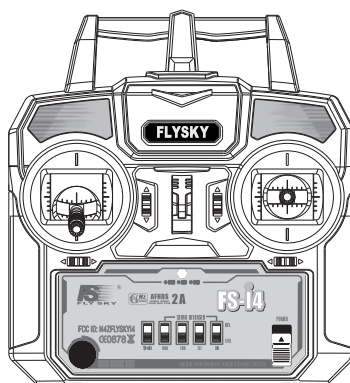

### 机种参数

1. 通道个数 : 4
2. 适合机种 : 固定翼/滑翔机/直升机
3. 数据分辨率: 1024级
4. 输入电压: 6V (1.5V AA x 4)
5. 低电压报警 : 低于4.2V 红色LED灯闪 ,  
    4.2-4.5V 红色 ,  
    4.6-5V 橙色 ,  
    5-6V 绿色,  
    低于3.2V 蜂鸣器报警
6. 2.4G模式 : **AFHDS2A** 第二代增强版自动跳频数字系统(含第一代系统)  
    (在配备双向接收机时单双向模式可互换)
7. 天线长度: 26毫米\*2(双天线)
8. 外观颜色: 黑色
9. 外形尺寸: 174\*89\*190毫米
10. 整机重量: 335克
11. 安规认证: CE, FCC

## 9. Receiver specifications 接收机参数

 **MODEL: FS-A6**

### SPECIFICATIONS :

Number of channels: 6  
 Model type: fixed-wing/glider/ helicopter  
 RF receiver sensitivity: -105dBm;  
 Modulation : GFSK  
 System type: AFHDS2A  
 Channel resolution: 1024 steps  
 Bind port: yes  
 Power port: yes(VCC)  
 Power: 4.0-6.5VDC  
 Weight: 13g  
 Antenna length: 26mm  
 Size: 45\*23\*9mm  
 Color: transparent grey  
 Certification: CE, FCC.

### 机种参数:

1. 通道个数 : 6个通道
2. 适合机种 : 固定翼/滑翔机/直升机
3. 接收灵敏度 : -105dBm
4. 调制方式: GFSK
5. 系统模式: 第二代增强版自动调频数字系统
6. 数据分辨率: 1024级
7. 对码接口: 有
8. 电源接口: 有(VCC)
9. 电源标准: 4.0-6.5V DC
10. 整机重量: 13克
11. 天线长度: 26毫米
12. 外型尺寸: 45\*23\*9毫米
13. 外观颜色: 透明灰色
14. 安规认证: CE, FCC.

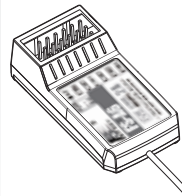



# Digital proportional radio control system **FS-i4**

## 10. operation instruction 接收机操作说明

### 10. 01. Receiver and servo connections 接收机与伺服器连接

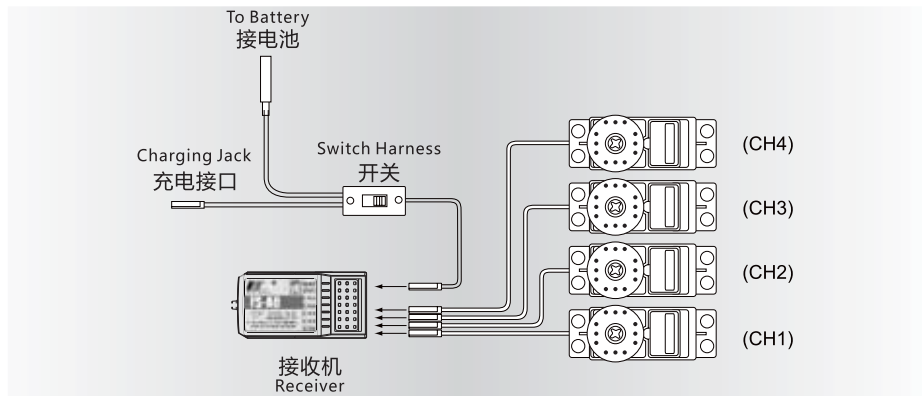

**注意:** 为保证良好的遥控距离,请将接收机天线与飞机机身垂直放置并远离金属物体。  
**Note:** To ensure good remote distance, please set the receiver antenna and the aircraft fuselage vertically and leave away from metal objects.

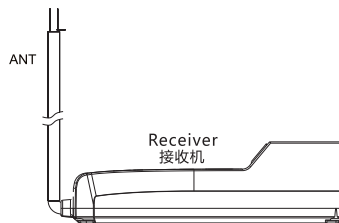

### 10. 02. Connector instruction 接口说明

**CH1-CH6:** 表示接收机的相应通道 ;

**BAT:** 表示用于对码和输入电源的通道 ;

**CH1-CH6:** represents corresponding channels.

**BAT:** represents the binding channel and power supply channel.

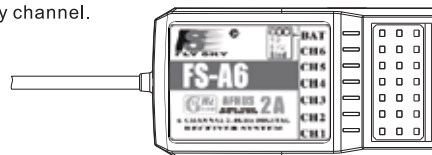

### 10.03. Binding 对码

The supplied transmitter and receiver are already bound at production time so you don't need to do it. If you are using another transmitter or receiver, you have to first bind them before use as described below:

1. Install batteries in the transmitter and turn it off.
2. Connect the binding jumper to the battery port of the receiver.
3. Connect the battery of the receiver to any channel power supply. The red LED with blink indicating that it is in binding mode.
4. Press and hold the bind key of the transmitter and turn it on.
5. The red LED of the receiver should stop to blink meaning a successful binding.
6. Disconnect the receiver battery.
7. Turn off then back on the transmitter.
8. Connect all the servos to the receiver and then connect its battery.
9. Check if all servos are working as expected.
10. If anything is wrong, restart this procedure from the beginning.

所有遥控产品在出厂的时候都已经对好码，您无需再次对码。如果您需要和其他发射机或接收机对码，您必须在使用前按照以下方法对码：

1. 将电池装入发射机然后关闭发射机。
2. 将对码线插到接收机电池通道插口。
3. 将接收机电池连接至接收机任意通道，接收机红色指示灯闪烁表明处于对码状态。
4. 按住发射机对码按键不松手，同时打开发射机。
5. 接收机红色指示灯停止闪烁表明对码成功。
6. 断开接收机电源。
7. 关闭发射机电源。
8. 将所有舵机连接至接收机，然后就将电池连接到接收机。
9. 检查是否所有的舵机按照要求工作正常。
10. 如果对码失败，请按以上步骤从头再来。

**注意：配对好的发射机与接收机，当发射机或接收机因误操作而进入对码状态后，会出现不能遥控的现象，一般情况下，关闭电源重开机即可恢复正常，倘若还是不行，则需要重新对码。**

Note: When transmitter or receiver enters into binding state by operation mistake, the well-matched transmitters and receivers will be out of control. In general, turning off the power to reboot can return to normal, but if not, you will need to rebind.

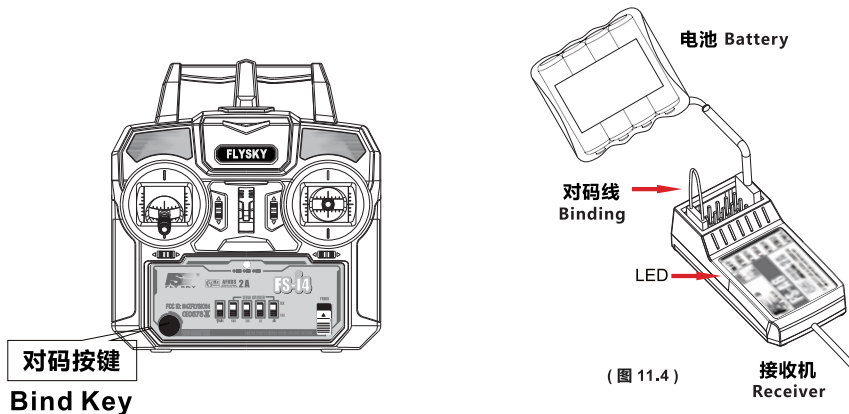

# Digital proportional radio control system **FS-14**

## 11. Definition of key functions 按键定义

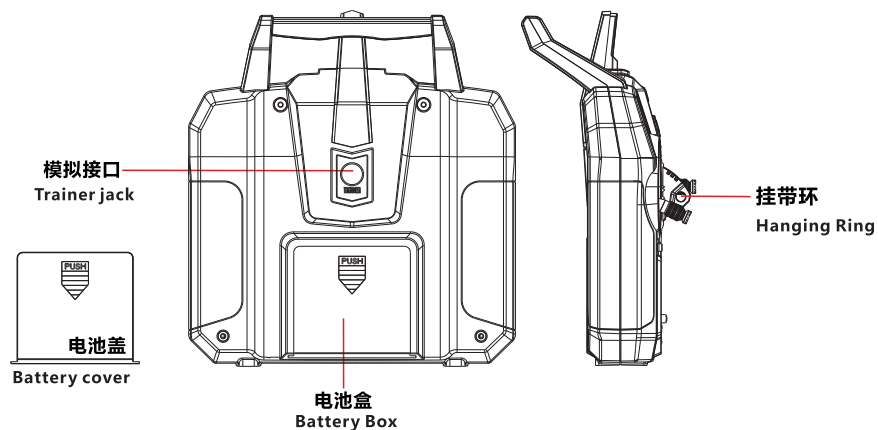
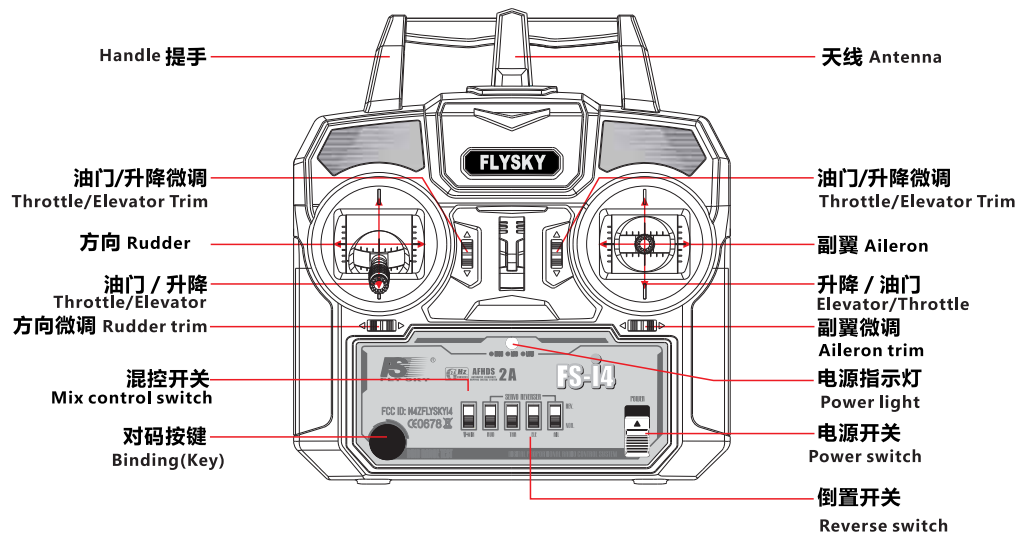

## 12. Right and left stick can be adjustable. 左右手摇杆模式调整

Function discription:

This feature is set for different operating habits of different users , and the user can adjust by the following operation.

How to interchange right and left stick mode of transmitter

1. Open the transmitter battery cover, and remove the battery;
2. Use a screwdriver to remove 4 screws that the locking back cover of transmitter (Figure 13.1), and properly placed;
3. Gently unplug the plug wires of transmitter cover , and you can see layout like (figure 13.2) shown.
4. Put the hat of jumper cables on the S16;
5. Remove 8 screws from the seat assembly with a small screwdriver , and properly placed;
6. Rotated transposition of the left and right seat assembly to 180 degrees, and organize line wire well, and locking the screws;
7. Plug wires of the transmitter cover carefully into the mainboard, re-close the transmitter cover and locking the screws;
8. Insert the battery and close the battery cover;
9. Turn on the transmitter and move the trim stick to check whether trim and direction is correct.

功能说明：

此功能是针对不同用户的不同操作习惯而设定的，用户可通过以下操作方式进行调整。

发射机左右手摇杆模式互换的步骤如下：

- 1、打开发射机的电池盖，取下电池；
- 2、用螺丝刀卸下锁住发射机后盖的4颗螺丝（如图13.1），并妥善放置；
- 3、轻轻地拨下发射机后盖电线插头，即可看到和（图13.2）一样的布局；
- 4、将跳线帽插在S16上
- 5、用小型十字螺丝刀卸下总成8颗螺丝，并妥善放置；
- 6、将左右总成座互换位置旋转180度，排好电线，并锁紧螺丝；
- 7、将发射机后盖电线插头小心地插入主板，重新合上发射机的后盖，并锁紧螺丝；
- 8、装入电池，盒上电池盖；
- 9、打开发射机拨动微调杆检查微调及方向是否正确。

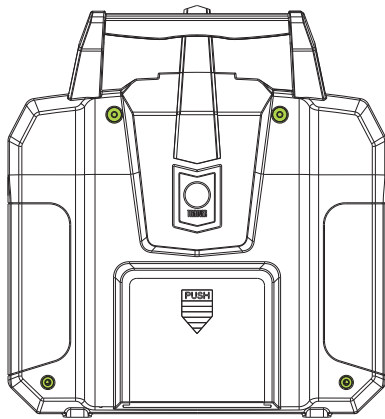

● 4颗螺丝 4 screws  
(图 13.1)

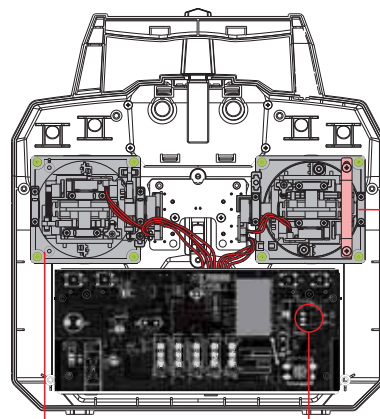

右总成座 ● 8颗螺丝 8 screws S16 左总成座  
right seat assembly (图 13.2) left seat assembly

# Digital proportional radio control system **FS-I4**

## 13. Power on 开机

1. Connect all components.
2. Switch transmitter power on.
3. Connect to receiver power supply.
4. The receiver light remains on.
5. Use.

1. 将各部件连接好。
2. 打开发射机电源开关。
3. 连接接收机电源。
4. 接收机恒亮
5. 使用。

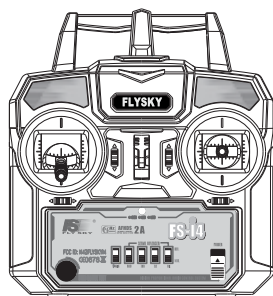

Tx power ON

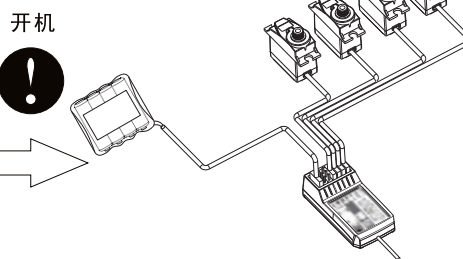

Rx power ON

## 14. Shut down 关机

1. Cut off the receiver power supply.
2. Switch the transmitter power off.

1. 切断接收机电源。
2. 关闭发射机电源。

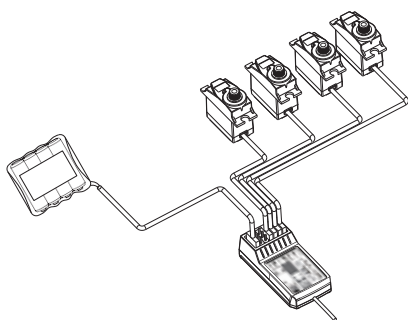

Rx power off

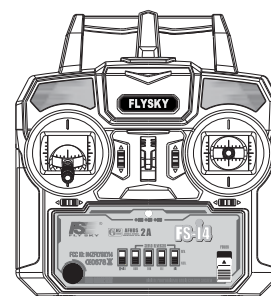

Tx power off

## 15. Function description 功能说明

### 15.01. 1 Channel control 1通道控制

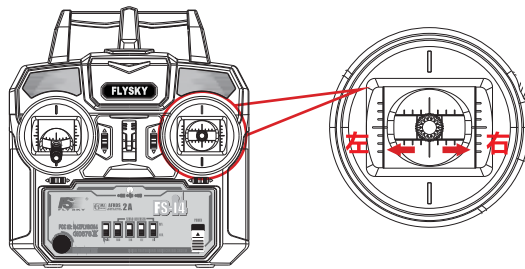

当您发射机的通道1操纵杆向左边移动时，飞机将往左边倾斜，同时飞机向左边移动（图16.1）  
 当您发射机的通道1操纵杆向右边移动时，飞机将往右边倾斜，同时飞机向右边移动（图16.2）

when you move channel one stick of transmitter to the left, the aircraft will tilt to the left, and the aircraft will move to the left at the same time (figure 16.1)  
 When you move the channel one stick of transmitter to the right, the aircraft will tilt to the right, the aircraft will move to the right at the same time (figure 16.2)



图16.1



图16.2

### 15.02 2 Channel control 2通道控制

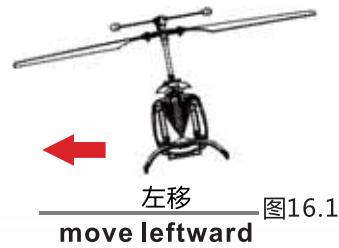
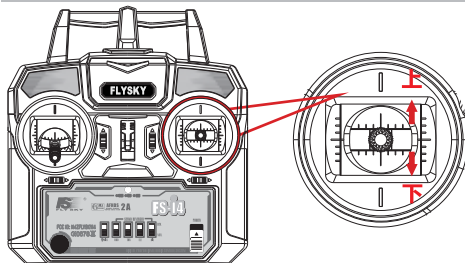

此通道用于飞机向前和向后控制，其功能如图。  
 当您发射机的通道2操纵杆向上边移动时，飞机将往前飞行，同时飞机向前方移动。（图16.5）  
 当您发射机的通道2操纵杆向下边移动时，飞机将往后飞行，同时飞机向后方移动。（图16.6）

This channel is used to control the forward and backward of aircraft, this function as shown in the figure.  
 When you move the channel 2 stick of the transmitter up, the aircraft will fly forward, and the aircraft moves forward. (Figure 16.5).  
 When you move the Channel 2 stick of transmitter down, the aircraft will fly backward, and the aircraft moves back (Figure 16.6)



图16.3



图16.4

## 15. 03. 3 Channel control 3通道控制

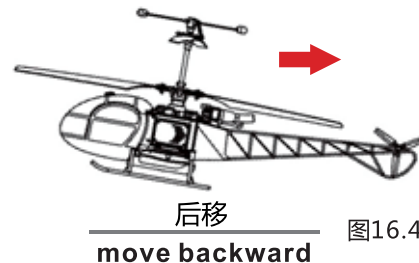
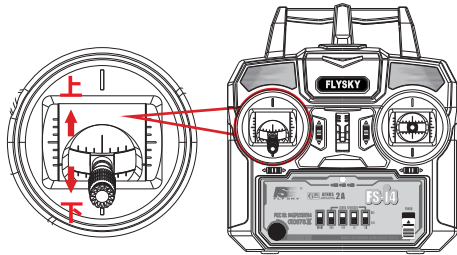

上升 go up 图16.5

此通道用于飞机动力油门控制，其功能如图。  
 当您发射机的通道3操纵杆向上边移动时，飞机的动力将会增加，同时飞机向上升起。（图16.3）  
 当您发射机的通道3操纵杆向下边移动时，飞机的动力将会减小，同时飞机向下降落。（图16.4）  
 This channel is used to control the aircraft power, this function is shown in the figure.  
 When you move the channel 3 stick of transmitter up, the power of aircraft will increase, and the aircraft rises upward at the same time. (Figure 16.3)  
 When you move channel 3 stick of the transmitter down, the aircraft's power will reduce, and the aircraft will land down at the same time. (figure 16.4)



下降 go down 图16.6

## 15. 04 4 Channel control 4通道控制

此通道用于飞机向左和向右转弯控制，其功能如图。  
 当您发射机的通道4操纵杆向左边移动时，飞机向右边转弯。（图16.8）  
 当您发射机的通道4操纵杆向右边移动时，飞机向左边转弯（图16.7）  
 This channel is used to . The function is shown as shown in the picture.  
 When you move channel four stick of the transmitter to the left, the aircraft turns right at the same time. (figure 16.8).  
 When you move channel four stick of the transmitter to the right, the aircraft turns left at the same time. (figure 16.7)

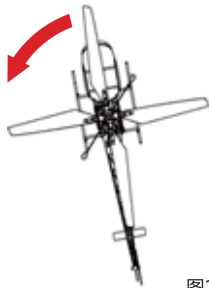
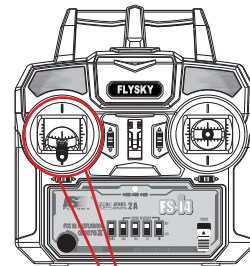

左转弯 turn left 图16.8



右转弯 turn right 图16.7

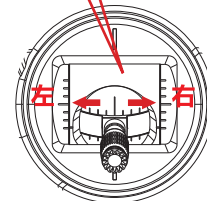

## 16. Packaging content 包装内容

NO:	Model	Sum	Remarks
1	4 channel 2.4G transmitter (FS-i4) 4 通2.4G发射机(FS-i4)	1	
2	6 channel 2.4G receiver (FS-A6) 6 通2.4G接收机(FS-A6)	1	
3	User manual 说明书	1	CD
4	Servo 伺服器 FS-DS0009	2	Optional 可选的
5	Simulator cable 模拟线 FS-SM100	1	Optional 可选的

## 17. FCC Statement 声明

### FCC Statement

This equipment has been tested and found to comply with the limits for a Class B digital device pursuant to part 15 of the FCC rules. These limits are designed to provide reasonable protection against harmful interference in a residential installation. This equipment generates, uses and can radiate radio frequency energy and, if not installed and used in accordance with the instructions, may cause harmful interference to radio communications. However, there is no guarantee that interference will not occur in a particular installation. If this equipment does cause harmful interference to radio or television reception, which can be determined by turning the equipment off and on, the user is encouraged to try to correct the interference by one or more of the following measures:

- Reorient or relocate the receiving antenna.
- Increase the separation between the equipment and receiver.
- Connect the equipment into an outlet on a circuit different from that to which the receiver is connected.
- Consult the dealer or an experienced radio/TV technician for help.

To assure continued compliance, any changes or modifications not expressly approved by the party responsible for compliance could void the user's authority to operate this equipment. (Example use only shielded interface cables when connecting to computer or peripheral devices).

This equipment complies with Part 15 of the FCC Rules. Operation is subject to the following two conditions:

- (1) This device may not cause harmful interference, and
- (2) This device must accept any interference received, including interference that may cause undesired operation.

### Caution!

The manufacturer is not responsible for any radio or TV interference caused by unauthorized modifications to this equipment. Such modifications could void the user authority to operate the equipment.





**Digital proportional radio control system**

**CE0678FC**

<http://www.flysky-cn.com>

Copyright ©2013-2017 Flysky co., Ltd