

FCC Report

Applicant: FLYSKY RC MODEL TECHNOLOGY CO., LTD

Address of Applicant: West building3, Huangjianyuan Ind, Park QIAOLI North Gate
Changping Town Dongguan CN.

Equipment Under Test (EUT)

Product Name: Digital propotional radio control system

Model No.: FS-i4

FCC ID: N4ZFLYSKYI4

Applicable standards: FCC CFR Title 47 Part 15 Subpart C Section 15.247:2013

Date of sample receipt: May 15, 2014

Date of Test: May 16-19, 2014

Date of report issued: May 20, 2014

Test Result : PASS *

* In the configuration tested, the EUT complied with the standards specified above.

Authorized Signature:

A circular logo for GTS (Global United Technology Services Co., Ltd.) with the text "GLOBAL TESTING" inside. A handwritten signature in black ink is written over the logo.

Robinson Lo
Laboratory Manager

This report details the results of the testing carried out on one sample. The results contained in this test report do not relate to other samples of the same product and does not permit the use of the GTS product certification mark. The manufacturer should ensure that all products in series production are in conformity with the product sample detailed in this report.

This report may only be reproduced and distributed in full. If the product in this report is used in any configuration other than that detailed in the report, the manufacturer must ensure the new system complies with all relevant standards. Any mention of GTS or testing done by GTS in connection with, distribution or use of the product described in this report must be approved by GTS in writing.

This document cannot be reproduced except in full, without prior written approval of the Company. Any unauthorized alteration, forgery or falsification of the content or appearance of this document is unlawful and offenders may be prosecuted to the fullest extent of the law. Unless otherwise stated the results shown in this test report refer only to the sample(s) tested and such sample(s) are retained for 90 days only.

2 Version

Version No.	Date	Description
00	May 20, 2014	Original

Prepared By:

Sam. Gao

Date:

May 20, 2014

Project Engineer

Check By:

Hans. Hu

Date:

May 20, 2014

Reviewer

3 Contents

	Page
1 COVER PAGE	1
2 VERSION	2
3 CONTENTS	3
4 TEST SUMMARY	4
5 GENERAL INFORMATION	5
5.1 CLIENT INFORMATION	5
5.2 GENERAL DESCRIPTION OF EUT	5
5.3 TEST MODE	8
5.4 TEST FACILITY.....	8
5.5 TEST LOCATION	8
5.6 OTHER INFORMATION REQUESTED BY THE CUSTOMER.....	8
5.7 DESCRIPTION OF SUPPORT UNITS	8
5.8 TEST INSTRUMENTS LIST.....	9
6 TEST RESULTS AND MEASUREMENT DATA.....	10
6.1 ANTENNA REQUIREMENT.....	10
6.2 CONDUCTED PEAK OUTPUT POWER.....	11
6.3 20dB EMISSION BANDWIDTH	13
6.4 CARRIER FREQUENCIES SEPARATION.....	15
6.5 HOPPING CHANNEL NUMBER	17
6.6 DWELL TIME.....	18
6.7 BAND EDGE	22
6.7.1 Conducted Emission Method.....	22
6.7.2 Radiated Emission Method.....	24
6.8 SPURIOUS EMISSION.....	26
6.8.1 Conducted Emission Method.....	26
6.8.2 Radiated Emission Method.....	28
7 TEST SETUP PHOTO	34
8 EUT CONSTRUCTIONAL DETAILS	36

4 Test Summary

Test Item	Section	Result
Antenna Requirement	15.203/15.247 (c)	Pass
AC Power Line Conducted Emission	15.207	N/A
Conducted Peak Output Power	15.247 (b)(1)	Pass
20dB Occupied Bandwidth	15.247 (a)(1)	Pass
Carrier Frequencies Separation	15.247 (a)(1)	Pass
Hopping Channel Number	15.247 (a)(1)	Pass
Dwell Time	15.247 (a)(1)	Pass
Pseudorandom Frequency Hopping Sequence	15.247(b)(4)&TCB Exclusion List (7 July 2002)	Pass
Radiated Emission	15.205/15.209	Pass
Band Edge	15.247(d)	Pass

Pass: The EUT complies with the essential requirements in the standard.

5 General Information

5.1 Client Information

Applicant:	FLYSKY RC MODEL TECHNOLOGY CO., LTD
Address of Applicant:	West building3, Huangjianyuan Ind, Park QIAOLI North Gate Changping Town Dongguan CN.
Manufacturer:	FLYSKY RC MODEL TECHNOLOGY CO., LTD
Address of Manufacturer:	West building3, Huangjianyuan Ind, Park QIAOLI North Gate Changping Town Dongguan CN.
Factory:	FLYSKY RC MODEL TECHNOLOGY CO., LTD
Address of Factory:	West building3, Huangjianyuan Ind, Park QIAOLI North Gate Changping Town Dongguan CN.

5.2 General Description of EUT

Product Name:	Digital propotional radio control system
Model No.:	FS-i4
Operation Frequency:	2405.5MHz~2475.0MHz
Channel numbers:	16
Modulation technology:	GFSK
Antenna Type:	Integral
Antenna gain:	2dBi
Power supply:	DC 6V(4*1.5V "AA" Battery)

Operation Frequency each of channel							
Channel	Frequency (MHz)	Channel	Frequency (MHz)	Channel	Frequency (MHz)	Channel	Frequency (MHz)
1	2405.50	36	2423.00	71	2440.50	106	2458.00
2	2406.00	37	2423.50	72	2441.00	107	2458.50
3	2406.50	38	2424.00	73	2441.50	108	2459.00
4	2407.00	39	2424.50	74	2442.00	109	2459.50
5	2407.50	40	2425.00	75	2442.50	110	2460.00
6	2408.00	41	2425.50	76	2443.00	111	2460.50
7	2408.50	42	2426.00	77	2443.50	112	2461.00
8	2409.00	43	2426.50	78	2444.00	113	2461.50
9	2409.50	44	2427.00	79	2444.50	114	2462.00
10	2410.00	45	2427.50	80	2445.00	115	2462.50
11	2410.50	46	2428.00	81	2445.50	116	2463.00
12	2411.00	47	2428.50	82	2446.00	117	2463.50
13	2411.50	48	2429.00	83	2446.50	118	2464.00
14	2412.00	49	2429.50	84	2447.00	119	2464.50
15	2412.50	50	2430.00	85	2447.50	120	2465.00
16	2413.00	51	2430.50	86	2448.00	121	2465.50
17	2413.50	52	2431.00	87	2448.50	122	2466.00
18	2414.00	53	2431.50	88	2449.00	123	2466.50
19	2414.50	54	2432.00	89	2449.50	124	2467.00
20	2415.00	55	2432.50	90	2450.00	125	2467.50
21	2415.50	56	2433.00	91	2450.50	126	2468.00
22	2416.00	57	2433.50	92	2451.00	127	2468.50
23	2416.50	58	2434.00	93	2451.50	128	2469.00
24	2417.00	59	2434.50	94	2452.00	129	2469.50
25	2417.50	60	2435.00	95	2452.50	130	2470.00
26	2418.00	61	2435.50	96	2453.00	131	2470.50
27	2418.50	62	2436.00	97	2453.50	132	2471.00
28	2419.00	63	2436.50	98	2454.00	133	2471.50
29	2419.50	64	2437.00	99	2454.50	134	2472.00
30	2420.00	65	2437.50	100	2455.00	135	2472.50
31	2420.50	66	2438.00	101	2455.50	136	2473.00
32	2421.00	67	2438.50	102	2456.00	137	2473.50
33	2421.50	68	2439.00	103	2456.50	138	2474.00
34	2422.00	69	2439.50	104	2457.00	139	2474.50
35	2422.50	70	2440.00	105	2457.50	140	2475.00

In section 15.31(m), regards to the operating frequency range over 10 MHz, the Lowest frequency, the middle frequency, and the highest frequency of channel were selected to perform the test, and the selected channel see below:

Channel	Frequency
The lowest channel	2405.5MHz
The middle channel	2440.0MHz
The Highest channel	2475.0MHz

5.3 Test mode

Transmitting mode	Keep the EUT in transmitting mode.
<i>Remark: During the test, the new battery was used.</i>	

5.4 Test Facility

<p>The test facility is recognized, certified, or accredited by the following organizations:</p> <ul style="list-style-type: none">● CNAS —Registration No.: CNAS L5775 CNAS has accredited Global United Technology Services Co., Ltd. To ISO/IEC 17025 General Requirements for the competence of testing and calibration laboratories (CNAS-CL01 Accreditation Criteria for the Competence of Testing and Calibration Laboratories) for the competence in the field of testing.● FCC —Registration No.: 600491 Global United Technology Services Co., Ltd., Shenzhen EMC Laboratory has been registered and fully described in a report filed with the (FCC) Federal Communications Commission. The acceptance letter from the FCC is maintained in files. Registration 600491, June 28, 2013.● Industry Canada (IC) —Registration No.: 9079A-2 The 3m Semi-anechoic chamber of Global United Technology Services Co., Ltd. has been registered by Certification and Engineering Bureau of Industry Canada for radio equipment testing with Registration No.: 9079A-2, June 26, 2013.

5.5 Test Location

All other tests were performed at:
Global United Technology Services Co., Ltd. Address: 2nd Floor, Block No.2, Laodong Industrial Zone, Xixiang Road Baoan District, Shenzhen, China Tel: 0755-27798480 Fax: 0755-27798960

5.6 Other Information Requested by the Customer

None.

5.7 Description of Support Units

None.

5.8 Test Instruments list

Radiated Emission:						
Item	Test Equipment	Manufacturer	Model No.	Inventory No.	Cal.Date (mm-dd-yy)	Cal.Due date (mm-dd-yy)
1	3m Semi- Anechoic Chamber	ZhongYu Electron	9.2(L)*6.2(W)* 6.4(H)	GTS250	Mar. 29 2013	Mar. 28 2015
2	Control Room	ZhongYu Electron	6.2(L)*2.5(W)* 2.4(H)	GTS251	N/A	N/A
3	Spectrum Analyzer	Agilent	E4440A	GTS536	Nov. 20, 2013	Nov. 19, 2014
4	EMI Test Receiver	Rohde & Schwarz	ESU26	GTS203	Jul. 02 2013	Jul. 01 2014
5	Loop Antenna	ZHINAN	ZN30900A	GTS534	Feb. 23 2014	Feb. 22 2015
6	BiConiLog Antenna	SCHWARZBECK MESS-ELEKTRONIK	VULB9163	GTS214	Feb. 23 2014	Feb. 22 2015
7	Double -ridged waveguide horn	SCHWARZBECK MESS-ELEKTRONIK	9120D-829	GTS208	June 28 2013	June 27 2014
8	Horn Antenna	ETS-LINDGREN	3160	GTS217	Mar. 29 2013	Mar. 28 2015
9	EMI Test Software	AUDIX	E3	N/A	N/A	N/A
10	Coaxial Cable	GTS	N/A	GTS213	Mar. 29 2013	Mar. 28 2015
11	Coaxial Cable	GTS	N/A	GTS211	Mar. 29 2013	Mar. 28 2015
12	Coaxial cable	GTS	N/A	GTS210	Mar. 29 2013	Mar. 28 2015
13	Coaxial Cable	GTS	N/A	GTS212	Mar. 29 2013	Mar. 28 2015
14	Amplifier(100kHz-3GHz)	HP	8347A	GTS204	Jul. 02 2013	Jul. 01 2014
15	Amplifier(2GHz-20GHz)	HP	8349B	GTS206	Jul. 02 2013	Jul. 01 2014
16	Amplifier (18-26GHz)	Rohde & Schwarz	AFS33-18002 650-30-8P-44	GTS218	June 28 2013	June 27 2014
17	Band filter	Amindeon	82346	GTS219	Mar. 29 2013	Mar. 28 2015

6 Test results and Measurement Data

6.1 Antenna requirement

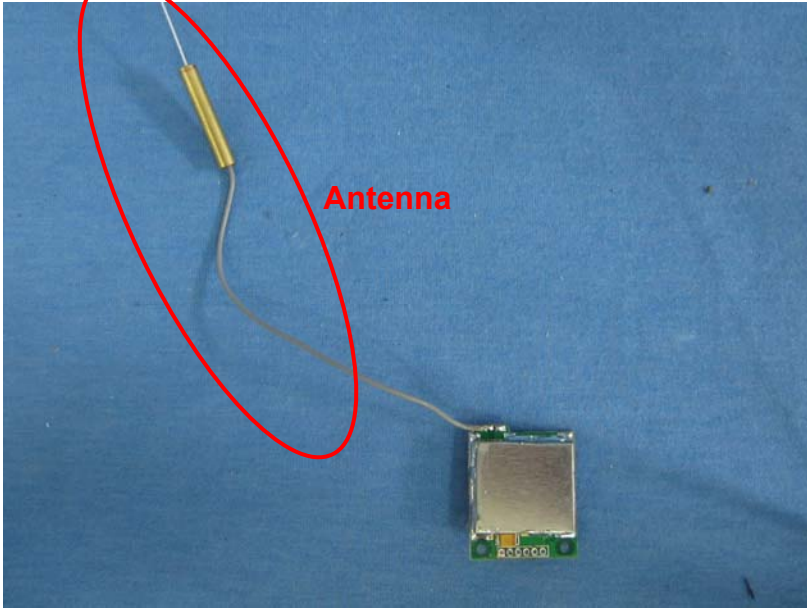
Standard requirement:	FCC Part15 C Section 15.203 /247(c)
<p>15.203 requirement:</p> <p>An intentional radiator shall be designed to ensure that no antenna other than that furnished by the responsible party shall be used with the device. The use of a permanently attached antenna or of an antenna that uses a unique coupling to the intentional radiator, the manufacturer may design the unit so that a broken antenna can be replaced by the user, but the use of a standard antenna jack or electrical connector is prohibited.</p> <p>15.247(c) (1)(i) requirement:</p> <p>(i) Systems operating in the 2400-2483.5 MHz band that is used exclusively for fixed. Point-to-point operations may employ transmitting antennas with directional gain greater than 6dBi provided the maximum conducted output power of the intentional radiator is reduced by 1 dB for every 3 dB that the directional gain of the antenna exceeds 6dBi.</p>	
E.U.T Antenna:	
<p><i>The antenna is Integral Antenna, the best case gain of the antenna is 2dBi</i></p> 	

6.2 Conducted Peak Output Power

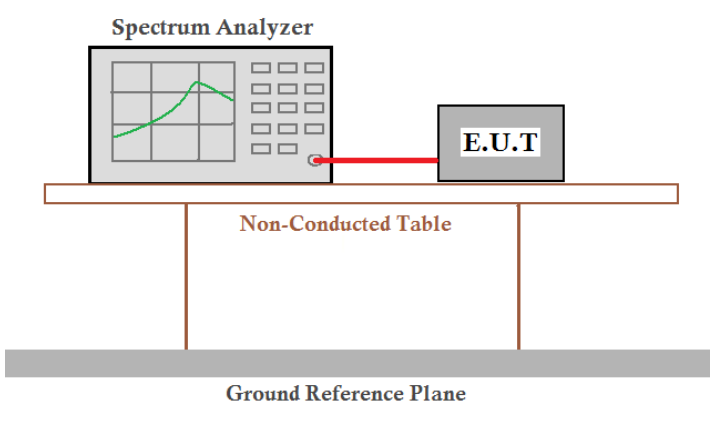
Test Requirement:	FCC Part15 C Section 15.247 (b)(1)
Test Method:	DA 00-705, ANSI C63.10:2009
Limit:	20.97dBm
Test setup:	 <p>The diagram illustrates the test setup. A Spectrum Analyzer is connected to an E.U.T. (Equipment Under Test) via a red cable. Both are placed on a Non-Conducted Table, which is supported by a Ground Reference Plane.</p>
Test Instruments:	Refer to section 5.8 for details
Test mode:	Refer to section 5.3 for details
Test results:	Pass

Measurement Data

Test channel	Peak Output Power (dBm)	Limit (dBm)	Result
Lowest	16.15	20.97	Pass
Middle	16.41		
Highest	16.47		

Test plot as follows:

Test mode:	GFSK mode
------------	-----------

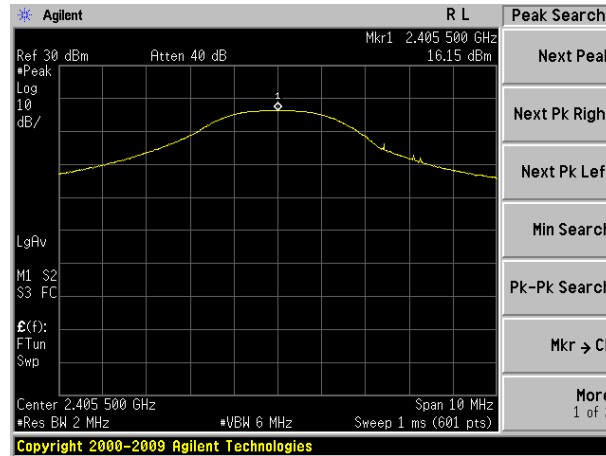

Lowest channel

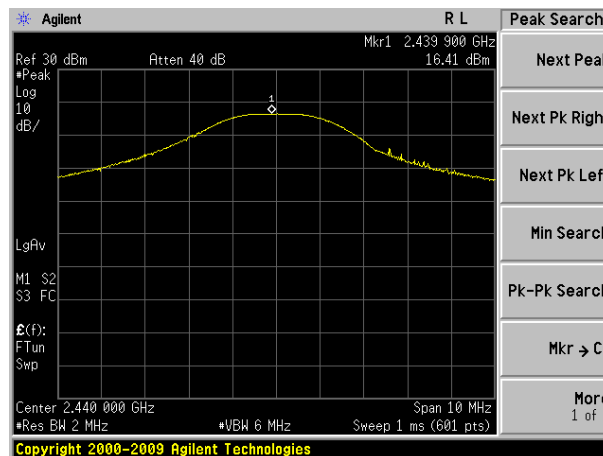

Middle channel

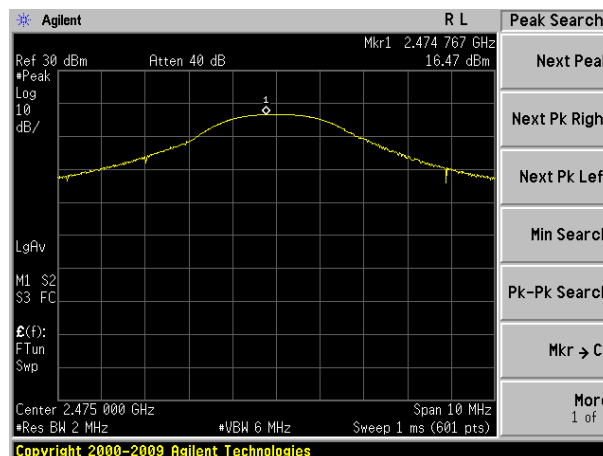

Highest channel

6.3 20dB Emission Bandwidth

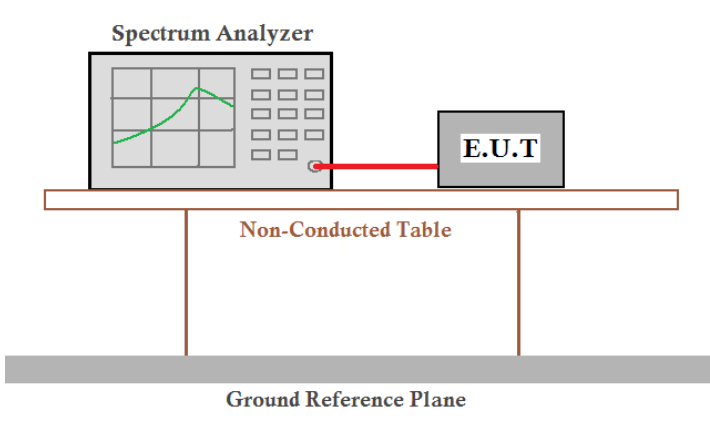
Test Requirement:	FCC Part15 C Section 15.247 (a)(1)
Test Method:	DA 00-705, ANSI C63.10:2009
Limit:	N/A
Test setup:	 <p>The diagram illustrates the test setup. A Spectrum Analyzer is connected to an E.U.T. (Equipment Under Test) via a red cable. Both are placed on a Non-Conducted Table, which is supported by a Ground Reference Plane.</p>
Test Instruments:	Refer to section 5.8 for details
Test mode:	Refer to section 5.3 for details
Test results:	Pass

Measurement Data

Test channel	20dB Emission Bandwidth (MHz)	Result
Lowest	1.047	Pass
Middle	1.046	
Highest	1.050	

Test plot as follows:

Test mode:	GFSK mode
------------	-----------

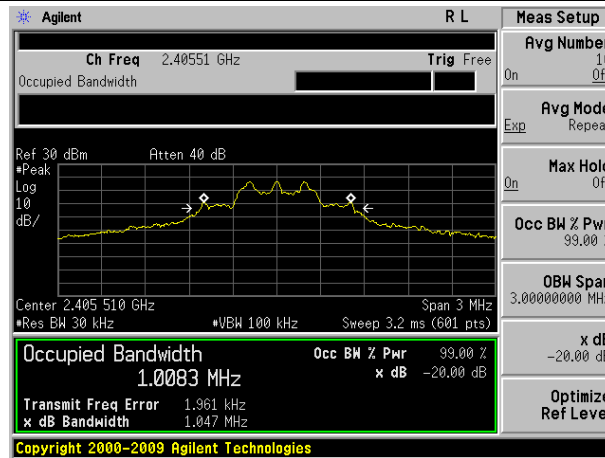

Lowest channel

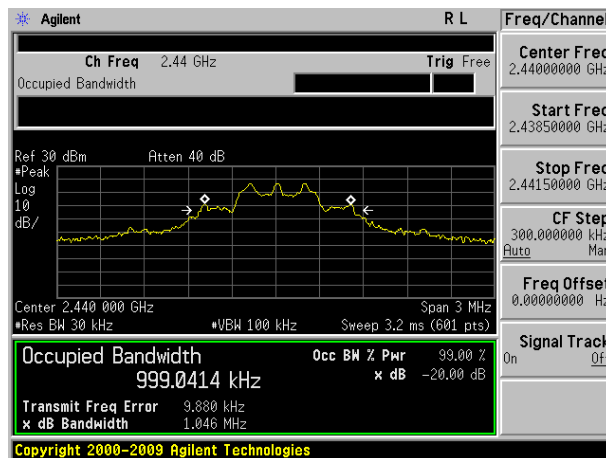

Middle channel

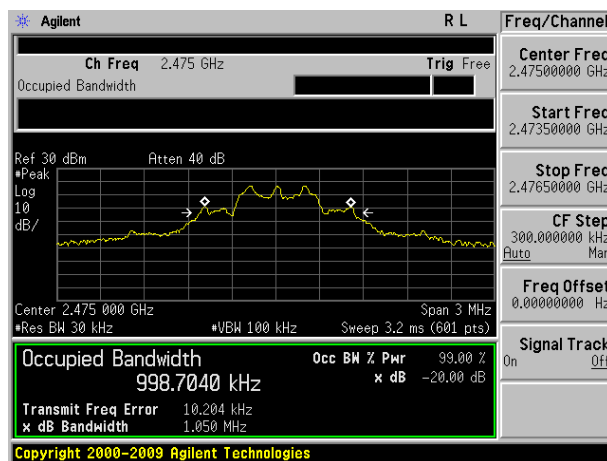

Highest channel

6.4 Carrier Frequencies Separation

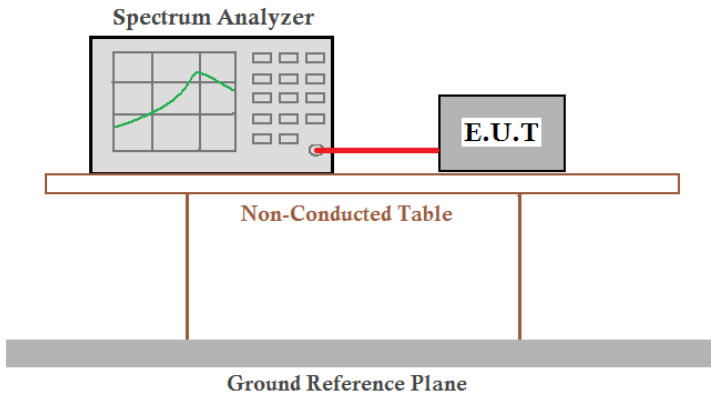
Test Requirement:	FCC Part15 C Section 15.247 (a)(1)
Test Method:	DA 00-705, ANSI C63.10:2009
Receiver setup:	RBW=100KHz, VBW=300KHz, detector=Peak
Limit:	0.025MHz or 2/3 of the 20dB bandwidth (whichever is greater)
Test setup:	 <p>The diagram shows a Spectrum Analyzer and an E.U.T. (Equipment Under Test) connected by a red cable. They are placed on a Non-Conducted Table, which is supported by a Ground Reference Plane.</p>
Test Instruments:	Refer to section 5.8 for details
Test mode:	Refer to section 5.3 for details
Test results:	Pass

Measurement Data

GFSK mode			
Test channel	Carrier Frequencies Separation (kHz)	Limit (kHz)	Result
Lowest	8000	700	Pass
Middle	2013	700	Pass
Highest	3517	700	Pass

Note: According to section 6.3

Mode	20dB bandwidth (kHz) (worse case)	Limit (kHz) (Carrier Frequencies Separation)
GFSK	1050	700

Test plot as follows:

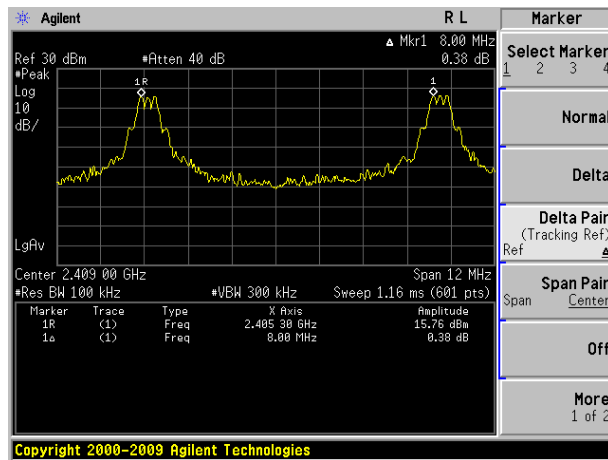

Lowest channel

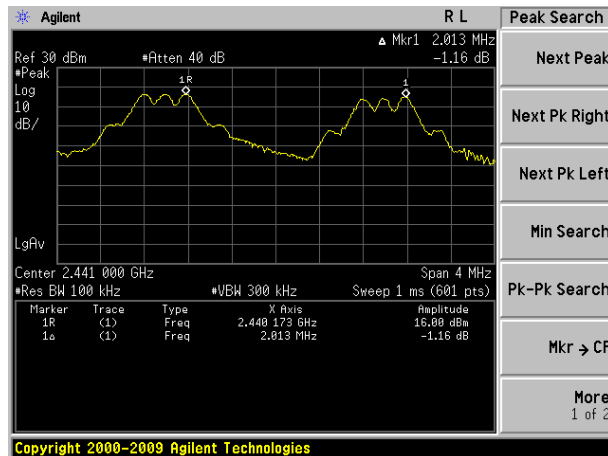

Middle channel

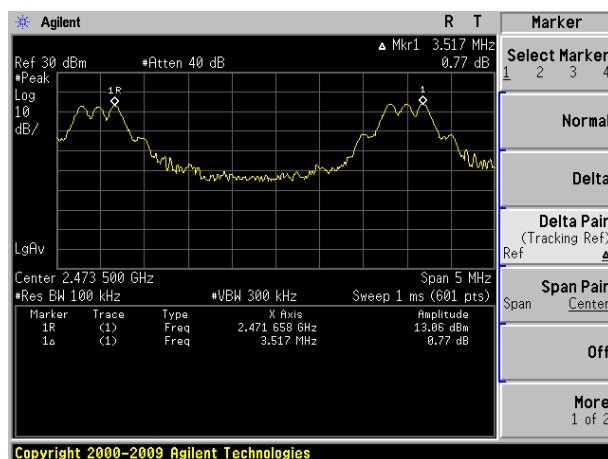

Highest channel

6.5 Hopping Channel Number

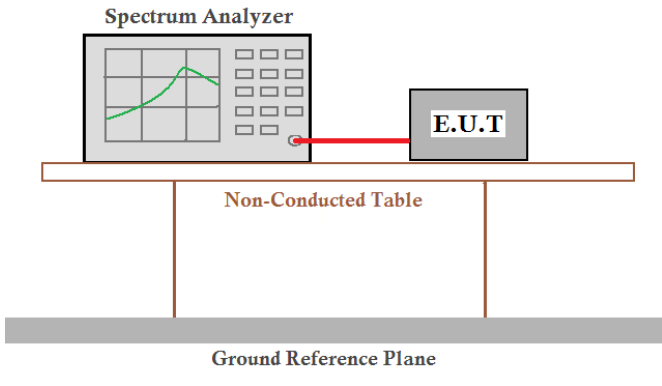
Test Requirement:	FCC Part15 C Section 15.247 (a)(1)(iii)
Test Method:	DA 00-705, ANSI C63.10:2009
Receiver setup:	RBW=100kHz, VBW=300kHz, Frequency range=2400MHz-2483.5MHz, Detector=Peak
Limit:	15 channels
Test setup:	
Test Instruments:	Refer to section 5.8 for details
Test mode:	Refer to section 5.3 for details
Test results:	Pass

Measurement Data:

Mode	Hopping channel numbers	Limit	Result
GFSK	16	15	Pass

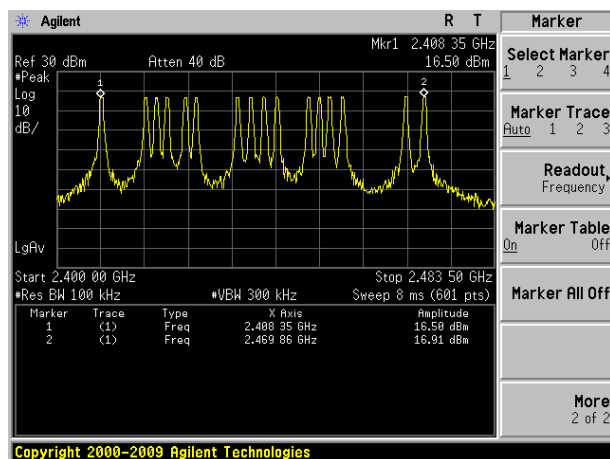

6.6 Dwell Time

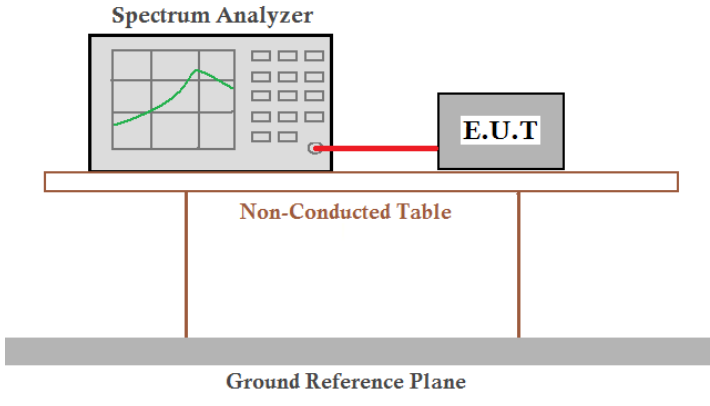
Test Requirement:	FCC Part15 C Section 15.247 (a)(1)(iii)
Test Method:	DA 00-705, ANSI C63.10:2009
Receiver setup:	RBW=1MHz, VBW=1MHz, Span=0Hz, Detector=Peak
Limit:	0.4 Second
Test setup:	
Test Instruments:	Refer to section 5.8 for details
Test mode:	Refer to section 5.3 for details
Test results:	Pass

Measurement Data

Frequency	Ton (ms)	Dwell time(ms)	Limit(ms)	Result
2.4055GHz	1.317	278.15	400	Pass
2.440GHz	1.308	276.25	400	Pass
2.475GHz	1.317	278.15	400	Pass

The formula as below:

2405.5MHz: Dwell time = Ton * Ton times in 1s * 0.4s * channel numbers=1.317ms*33*0.4*16=278.15ms

2440MHz: Dwell time = Ton * Ton times in 1s * 0.4s * channel numbers=1.308ms*33*0.4*16=276.25ms

2475MHz: Dwell time = Ton * Ton times in 1s * 0.4s * channel numbers=1.317ms*33*0.4*16=278.15ms

Test plot as follows:

Frequency: 2405.5MHz

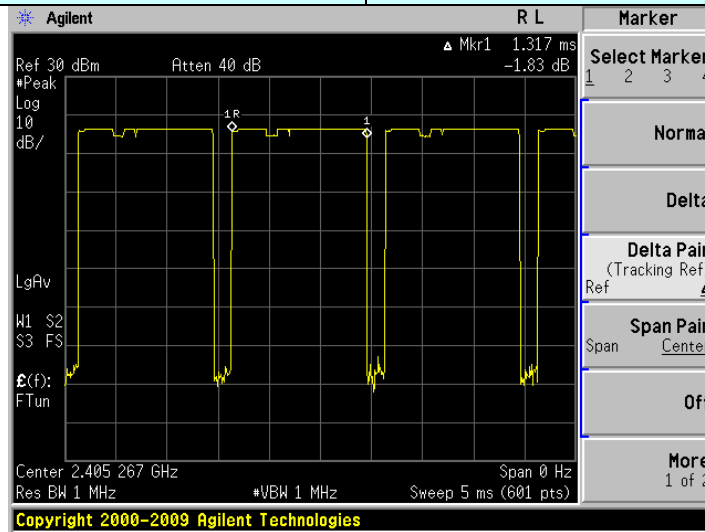

Ton

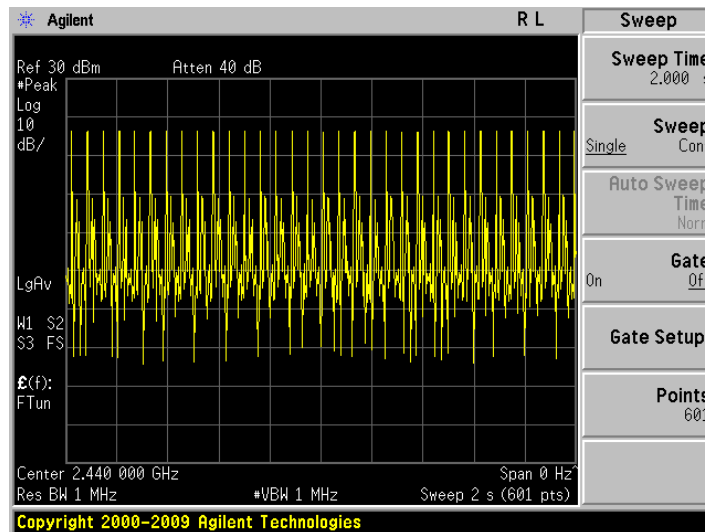

Ton times in 1s

Frequency: 2440MHz

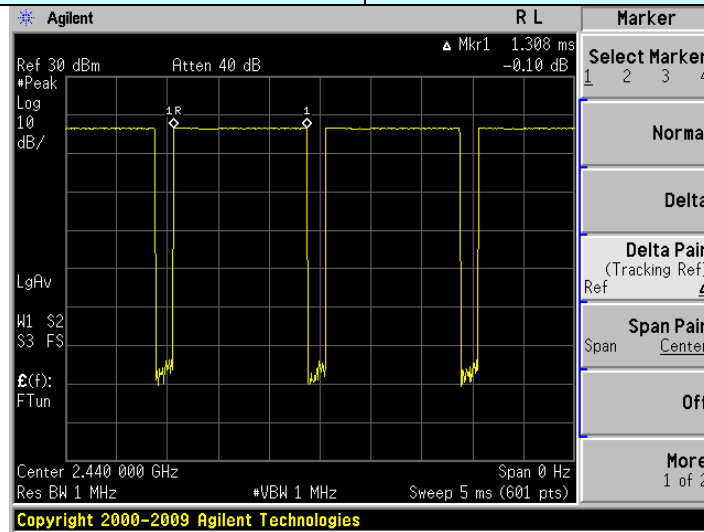

Ton

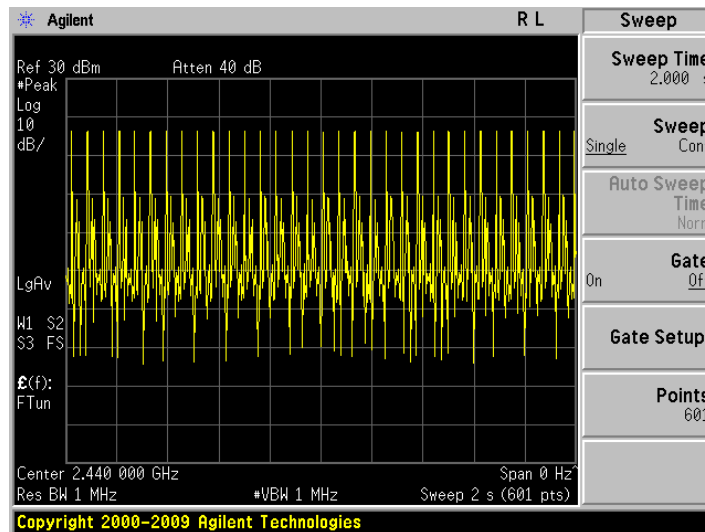

Ton times in 1s

Frequency: 2475MHz

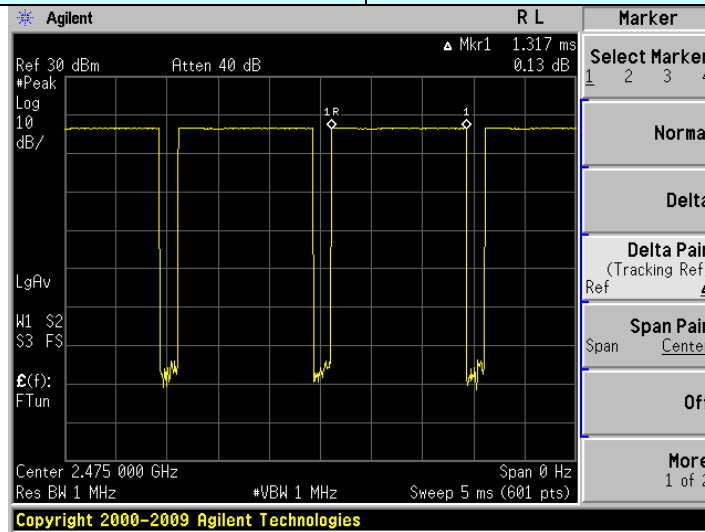

Ton

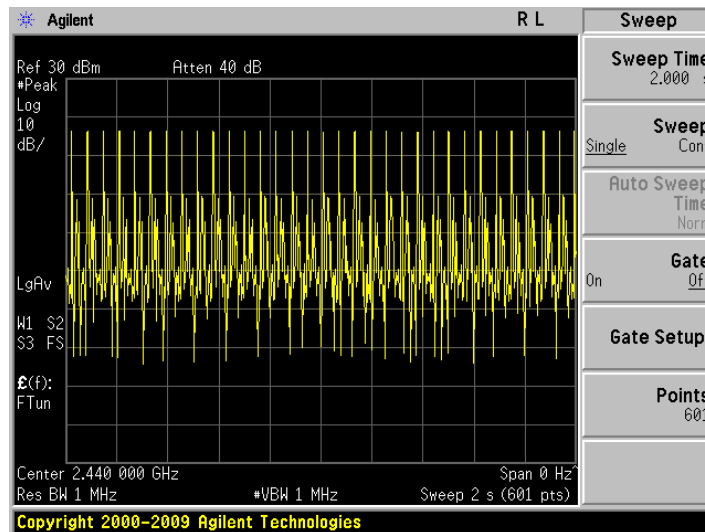

Ton times in 1s

6.7 Band Edge

6.7.1 Conducted Emission Method

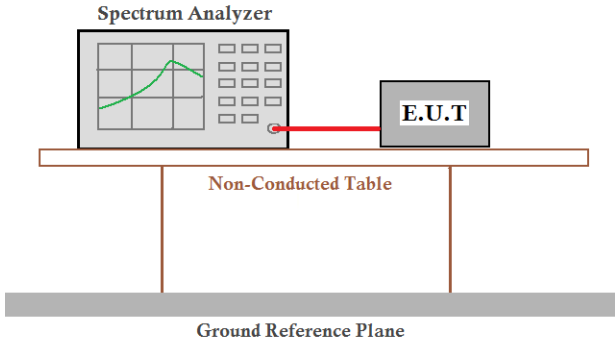
Test Requirement:	FCC Part15 C Section 15.247 (d)
Test Method:	DA 00-705, ANSI C63.10:2009
Receiver setup:	RBW=100kHz, VBW=300kHz, Detector=Peak
Limit:	In any 100 kHz bandwidth outside the frequency band in which the spread spectrum intentional radiator is operating, the radio frequency power that is produced by the intentional radiator shall be at least 20 dB below that in the 100 kHz bandwidth within the band that contains the highest level of the desired power, based on either an RF conducted or a radiated measurement.
Test setup:	 <p>The diagram illustrates the test setup. A Spectrum Analyzer is connected to an E.U.T. (Equipment Under Test) via a red cable. Both are placed on a Non-Conducted Table, which is supported by a Ground Reference Plane.</p>
Test Instruments:	Refer to section 5.8 for details
Test mode:	Refer to section 5.3 for details
Test results:	Pass

Test plot as follows:

Test channel: Lowest channel

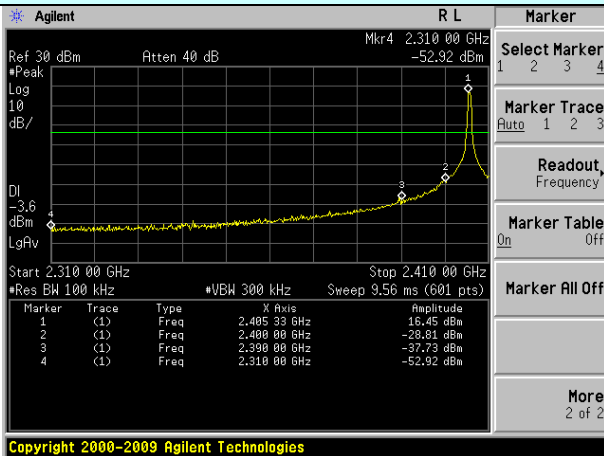

No-hopping mode

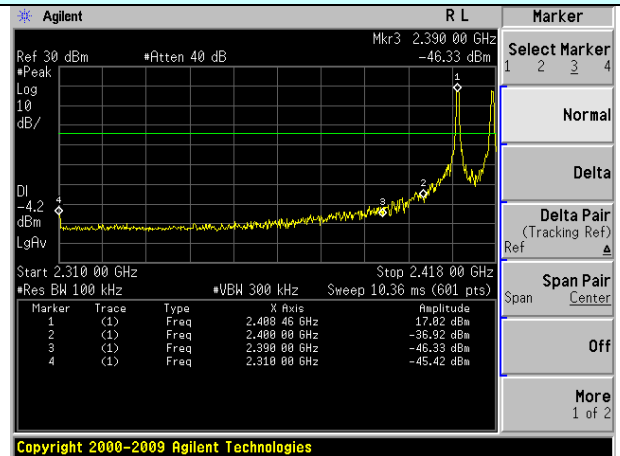

Hopping mode

Test channel: Highest channel

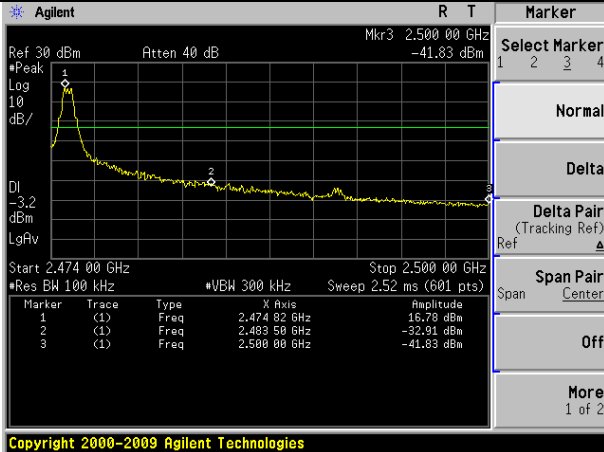

No-hopping mode

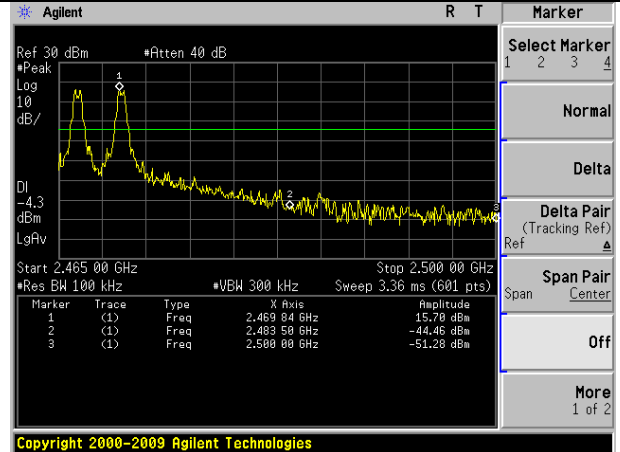

Hopping mode

6.7.2 Radiated Emission Method

Test Requirement:	FCC Part15 C Section 15.209 and 15.205				
Test Method:	ANSI C63.10: 2009				
Test Frequency Range:	All restriction band have been tested, and 2.3GHz to 2.5GHz band is the worse case				
Test site:	Measurement Distance: 3m				
Receiver setup:	Frequency	Detector	RBW	VBW	Remark
	Above 1GHz	Peak	1MHz	3MHz	Peak Value
		Peak	1MHz	10Hz	Average Value
Limit:	Frequency		Limit (dBuV/m @3m)		Remark
	Above 1GHz		54.00		Average Value
			74.00		Peak Value
Test setup:					
Test Procedure:	<ol style="list-style-type: none"> 1. The EUT was placed on the top of a rotating table 0.8 meters above the ground at a 3 meter camber. The table was rotated 360 degrees to determine the position of the highest radiation. 2. The EUT was set 3 meters away from the interference-receiving antenna, which was mounted on the top of a variable-height antenna tower. 3. The antenna height is varied from one meter to four meters above the ground to determine the maximum value of the field strength. Both horizontal and vertical polarizations of the antenna are set to make the measurement. 4. For each suspected emission, the EUT was arranged to its worst case and then the antenna was tuned to heights from 1 meter to 4 meters and the rota table was turned from 0 degrees to 360 degrees to find the maximum reading. 5. The test-receiver system was set to Peak Detect Function and Specified Bandwidth with Maximum Hold Mode. 6. If the emission level of the EUT in peak mode was 10dB lower than the limit specified, then testing could be stopped and the peak values of the EUT would be reported. Otherwise the emissions that did not have 10dB margin would be re-tested one by one using peak, quasi-peak or average method as specified and then reported in a data sheet. 				
Test Instruments:	Refer to section 5.8 for details				
Test mode:	Refer to section 5.3 for details				
Test results:	Pass				

Remark:

1. Pre-scan all kind of the place mode (X-axis, Y-axis, Z-axis), and found the Y-axis which it is worse case.

Test channel:	Lowest
---------------	--------

Peak value:

Frequency (MHz)	Read Level (dBuV)	Antenna Factor (dB/m)	Cable Loss (dB)	Preamp Factor (dB)	Level (dBuV/m)	Limit Line (dBuV/m)	Over Limit (dB)	Polarization
2390.00	44.49	27.91	5.30	30.37	47.33	74.00	-26.67	Horizontal
2400.00	61.50	27.59	5.38	30.18	64.29	74.00	-9.71	Horizontal
2390.00	57.47	27.91	5.30	30.37	60.31	74.00	-13.69	Vertical
2400.00	66.75	27.59	5.38	30.18	69.54	74.00	-4.46	Vertical

Average value:

Frequency (MHz)	Read Level (dBuV)	Antenna Factor (dB/m)	Cable Loss (dB)	Preamp Factor (dB)	Level (dBuV/m)	Limit Line (dBuV/m)	Over Limit (dB)	Polarization
2390.00	28.96	27.91	5.30	30.37	31.80	54.00	-22.20	Horizontal
2400.00	38.47	27.59	5.38	30.18	41.26	54.00	-12.74	Horizontal
2390.00	27.93	27.91	5.30	30.37	30.77	54.00	-23.23	Vertical
2400.00	43.04	27.59	5.38	30.18	45.83	54.00	-8.17	Vertical

Test channel:	Highest
---------------	---------

Peak value:

Frequency (MHz)	Read Level (dBuV)	Antenna Factor (dB/m)	Cable Loss (dB)	Preamp Factor (dB)	Level (dBuV/m)	Limit Line (dBuV/m)	Over Limit (dB)	Polarization
2483.50	64.32	27.53	5.47	29.93	67.39	74.00	-6.61	Horizontal
2500.00	54.11	27.55	5.49	29.93	57.22	74.00	-16.78	Horizontal
2483.50	69.60	27.53	5.47	29.93	72.67	74.00	-1.33	Vertical
2500.00	61.55	27.55	5.49	29.93	64.66	74.00	-9.34	Vertical

Average value:

Frequency (MHz)	Read Level (dBuV)	Antenna Factor (dB/m)	Cable Loss (dB)	Preamp Factor (dB)	Level (dBuV/m)	Limit Line (dBuV/m)	Over Limit (dB)	Polarization
2483.50	43.87	27.53	5.47	29.93	46.94	54.00	-7.06	Horizontal
2500.00	27.52	27.55	5.49	29.93	30.63	54.00	-23.37	Horizontal
2483.50	50.45	27.53	5.47	29.93	53.52	54.00	-0.48	Vertical
2500.00	38.05	27.55	5.49	29.93	41.16	54.00	-12.84	Vertical

Remark:

1. Final Level = Receiver Read level + Antenna Factor + Cable Loss – Pre-amplifier Factor
2. The emission levels of other frequencies are very lower than the limit and not show in test report.

6.8 Spurious Emission

6.8.1 Conducted Emission Method

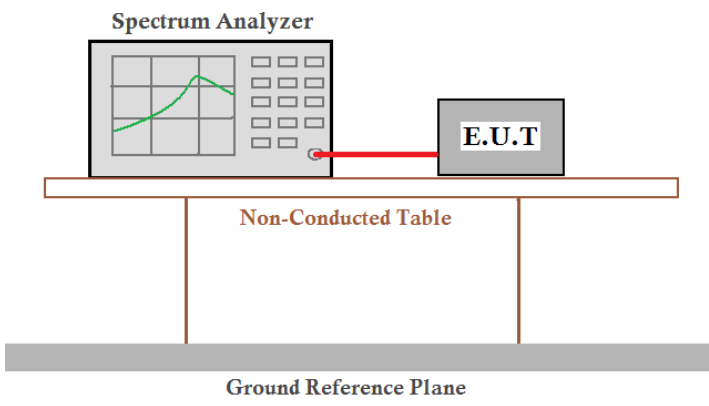
Test Requirement:	FCC Part15 C Section 15.247 (d)
Test Method:	ANSI C63.10:2009
Limit:	In any 100 kHz bandwidth outside the frequency band in which the spread spectrum intentional radiator is operating, the radio frequency power that is produced by the intentional radiator shall be at least 20 dB below that in the 100 kHz bandwidth within the band that contains the highest level of the desired power, based on either an RF conducted or a radiated measurement.
Test setup:	 <p>The diagram illustrates the test setup. A Spectrum Analyzer is connected to an E.U.T. (Equipment Under Test) via a red cable. Both are placed on a Non-Conducted Table, which sits on a Ground Reference Plane.</p>
Test Instruments:	Refer to section 5.8 for details
Test mode:	Refer to section 5.3 for details
Test results:	Pass

Test channel: Lowest channel

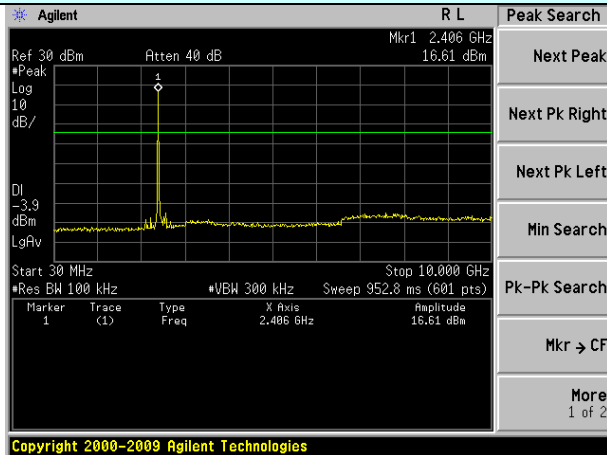

30MHz~10GHz

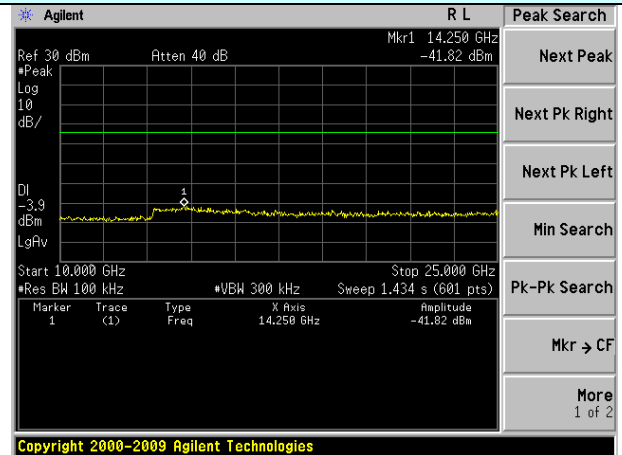

10GHz~25GHz

Test channel: Middle channel

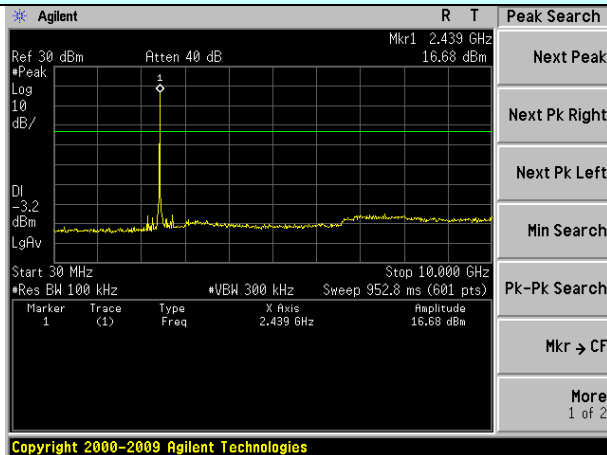

30MHz~10GHz

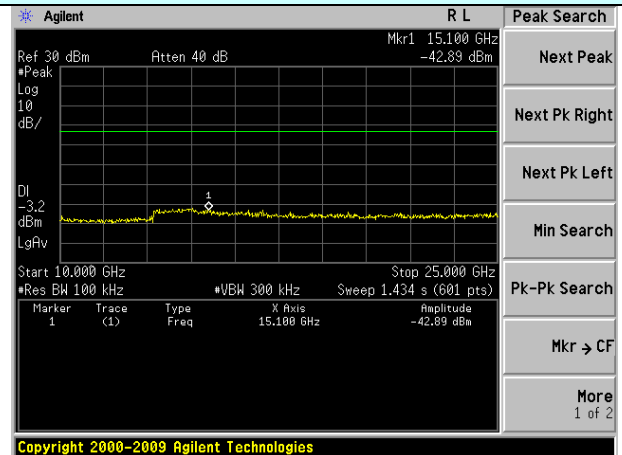

10GHz~25GHz

Test channel: Highest channel

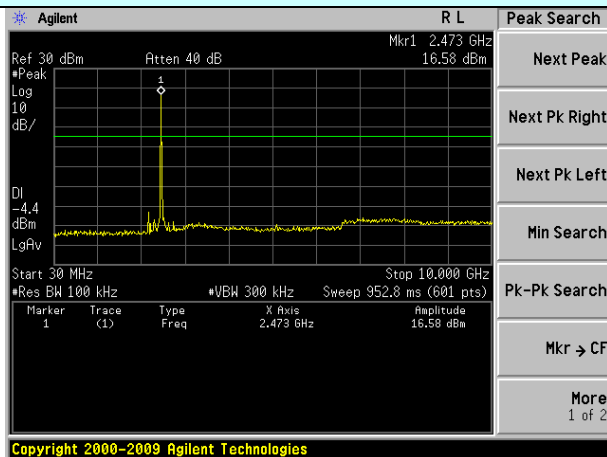

30MHz~10GHz

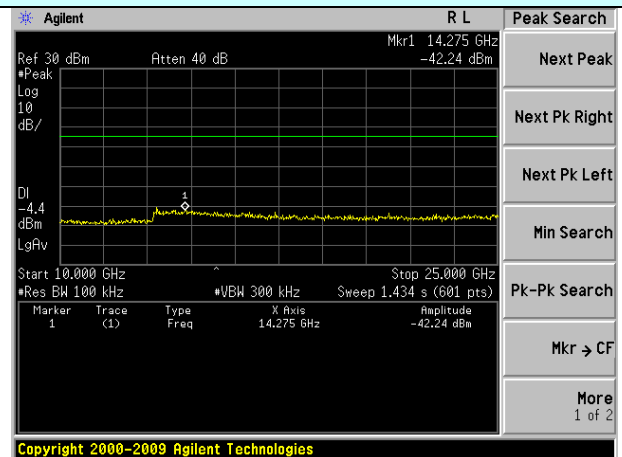

10GHz~25GHz

6.8.2 Radiated Emission Method

Test Requirement:	FCC Part15 C Section 15.209				
Test Method:	ANSI C63.10: 2009				
Test Frequency Range:	9kHz to 25GHz				
Test site:	Measurement Distance: 3m				
Receiver setup:	Frequency	Detector	RBW	VBW	Value
	9KHz-150KHz	Quasi-peak	200Hz	600Hz	Quasi-peak
	150KHz-30MHz	Quasi-peak	9KHz	30KHz	Quasi-peak
	30MHz-1GHz	Quasi-peak	100KHz	300KHz	Quasi-peak
	Above 1GHz	Peak	1MHz	3MHz	Peak
Peak		1MHz	10Hz	Average	
Limit: (Field strength of the fundamental signal)	Frequency	Limit (dBuV/m @3m)		Remark	
	2400MHz-2483.5MHz	94.00		Average Value	
		114.00		Peak Value	
Limit: (Spurious Emissions)	Frequency	Limit (uV/m)	Value	Measurement Distance	
	0.009MHz-1.705MHz	2400/F(KHz)	QP	300m	
	0.490MHz-1.705MHz	24000/F(KHz)	QP	300m	
	1.705MHz-30MHz	30	QP	30m	
	30MHz-88MHz	100	QP	3m	
	88MHz-216MHz	150	QP		
	216MHz-960MHz	200	QP		
	960MHz-1GHz	500	QP		
	Above 1GHz	500	Average		
		5000	Peak		
Test setup:	Below 1GHz				
	<p>Above 1GHz</p>				

	<p>The diagram illustrates the test setup. An EUT (Equipment Under Test) is placed on a turn table that is 0.8 meters above the ground. The turn table is rotated 360 degrees. The EUT is positioned 3 meters away from the antenna tower. The antenna tower is a variable-height structure with a horn antenna mounted on top. The antenna height is varied from 1 meter to 4 meters above the ground. The antenna is connected to an amplifier, which is then connected to a spectrum analyzer.</p>
<p>Test Procedure:</p>	<ol style="list-style-type: none"> 1. The EUT was placed on the top of a rotating table 0.8 meters above the ground at a 3 meter camber. The table was rotated 360 degrees to determine the position of the highest radiation. 2. The EUT was set 3 meters away from the interference-receiving antenna, which was mounted on the top of a variable-height antenna tower. 3. The antenna height is varied from one meter to four meters above the ground to determine the maximum value of the field strength. Both horizontal and vertical polarizations of the antenna are set to make the measurement. 4. For each suspected emission, the EUT was arranged to its worst case and then the antenna was tuned to heights from 1 meter to 4 meters and the rota table was turned from 0 degrees to 360 degrees to find the maximum reading. 5. The test-receiver system was set to Peak Detect Function and Specified Bandwidth with Maximum Hold Mode. 6. If the emission level of the EUT in peak mode was 10dB lower than the limit specified, then testing could be stopped and the peak values of the EUT would be reported. Otherwise the emissions that did not have 10dB margin would be re-tested one by one using peak, quasi-peak or average method as specified and then reported in a data sheet.
<p>Test Instruments:</p>	<p>Refer to section 5.8 for details</p>
<p>Test mode:</p>	<p>Refer to section 5.3 for details</p>
<p>Test results:</p>	<p>Pass</p>

Remark:

1. Pre-scan all kind of the place mode (X-axis, Y-axis, Z-axis), and found the Y-axis which it is worse case.

Measurement data:

■ **Below 30MHz**

Frequency (kHz)	Read Level (dBuV)	Antenna Factor (dB/m)	Cable Loss (dB)	Preamp Factor (dB)	Level (dBuV/m)	Limit @3m (dBuV/m)	Over Limit (dB)	ANT. Polarization
164.00	68.54	21.58	0.20	0.00	89.34	103.31	-12.99	Vertical
733.00	*					70.30		Vertical
1250.00	*					65.67		Vertical
164.00	65.18	21.58	0.20	0.00	86.09	103.31	-16.35	Horizontal
733.00	*					70.30		Horizontal
1250.00	*					65.67		Horizontal

Remark:

1. *Limit dBuV/m @3m = Limit dBuV/m @300m+ 80, Limit dBuV/m @3m = Limit dBuV/m @30m + 40*
 2. *Final Level = Receiver Read level + Antenna Factor + Cable Loss – Preamplifier Factor*
 3. *The emission levels of other frequencies are very lower than the limit and not show in test report.*
- “*” , means this data is the too weak instrument of signal is unable to test.*

■ **30MHz ~ 1GHz**

Frequency (MHz)	Read Level (dBuV)	Antenna Factor (dB/m)	Cable Loss (dB)	Preamp Factor (dB)	Level (dBuV/m)	Limit Line (dBuV/m)	Over Limit (dB)	Polarization
39.16	33.51	15.34	0.65	32.06	17.44	40.00	-22.56	Vertical
65.11	33.71	12.57	0.90	31.91	15.27	40.00	-24.73	Vertical
119.44	35.07	12.58	1.36	31.86	17.15	43.50	-26.35	Vertical
254.73	33.26	14.06	2.15	32.16	17.31	46.00	-28.69	Vertical
375.94	35.05	16.56	2.75	31.95	22.41	46.00	-23.59	Vertical
798.98	34.17	22.06	4.45	31.32	29.36	46.00	-16.64	Vertical
44.12	34.01	15.56	0.71	32.02	18.26	40.00	-21.74	Horizontal
94.10	33.58	14.67	1.14	31.74	17.65	43.50	-25.85	Horizontal
164.91	33.55	10.82	1.66	32.03	14.00	43.50	-29.50	Horizontal
356.68	34.92	16.38	2.65	32.00	21.95	46.00	-24.05	Horizontal
541.37	32.83	19.41	3.49	31.33	24.40	46.00	-21.60	Horizontal
739.66	34.16	21.29	4.24	31.25	28.44	46.00	-17.56	Horizontal

■ Above 1GHz

Test channel:	Lowest
---------------	--------

Peak value:

Frequency (MHz)	Read Level (dBuV)	Antenna Factor (dB/m)	Cable Loss (dB)	Preamp Factor (dB)	Level (dBuV/m)	Limit Line (dBuV/m)	Over Limit (dB)	Polarization
4811.00	40.08	31.78	8.60	32.09	48.37	74.00	-25.63	Vertical
7216.50	28.14	36.15	11.66	31.99	43.96	74.00	-30.04	Vertical
9622.00	23.11	38.01	14.14	31.60	43.66	74.00	-30.34	Vertical
12027.50	*					74.00		Vertical
14433.00	*					74.00		Vertical
4811.00	43.46	31.78	8.60	32.09	51.75	74.00	-22.25	Horizontal
7216.50	31.75	36.15	11.66	31.99	47.57	74.00	-26.43	Horizontal
9622.00	25.80	38.01	14.14	31.60	46.35	74.00	-27.65	Horizontal
12027.50	*					74.00		Horizontal
14433.00	*					74.00		Horizontal

Average value:

Frequency (MHz)	Read Level (dBuV)	Antenna Factor (dB/m)	Cable Loss (dB)	Preamp Factor (dB)	Level (dBuV/m)	Limit Line (dBuV/m)	Over Limit (dB)	Polarization
4811.00	23.40	31.78	8.60	32.09	31.69	54.00	-22.31	Vertical
7216.50	11.78	36.15	11.66	31.99	27.60	54.00	-26.40	Vertical
9622.00	6.90	38.01	14.14	31.60	27.45	54.00	-26.55	Vertical
12027.50	*					54.00		Vertical
14433.00	*					54.00		Vertical
4811.00	26.87	31.78	8.60	32.09	35.16	54.00	-18.84	Horizontal
7216.50	14.75	36.15	11.66	31.99	30.57	54.00	-23.43	Horizontal
9622.00	8.97	38.01	14.14	31.60	29.52	54.00	-24.48	Horizontal
12027.50	*					54.00		Horizontal
14433.00	*					54.00		Horizontal

Remark:

1. *Final Level = Receiver Read level + Antenna Factor + Cable Loss – Pre-amplifier Factor*
2. *“*”*, means this data is too weak instrument of signal is unable to test.
3. *The emission levels of other frequencies are very lower than the limit and not show in test report.*

Test channel:	Middle
---------------	--------

Peak value:

Frequency (MHz)	Read Level (dBuV)	Antenna Factor (dB/m)	Cable Loss (dB)	Preamp Factor (dB)	Level (dBuV/m)	Limit Line (dBuV/m)	Over Limit (dB)	Polarization
4880.00	38.43	31.85	8.66	32.12	46.82	74.00	-27.18	Vertical
7320.00	27.26	36.37	11.72	31.89	43.46	74.00	-30.54	Vertical
9760.00	21.51	38.35	14.25	31.59	42.52	74.00	-31.48	Vertical
12200.00	*					74.00		Vertical
14640.00	*					74.00		Vertical
4880.00	41.43	31.85	8.66	32.12	49.82	74.00	-24.18	Horizontal
7320.00	31.51	36.37	11.72	31.89	47.71	74.00	-26.29	Horizontal
9760.00	25.66	38.35	14.25	31.59	46.67	74.00	-27.33	Horizontal
12200.00	*					74.00		Horizontal
14640.00	*					74.00		Horizontal

Average value:

Frequency (MHz)	Read Level (dBuV)	Antenna Factor (dB/m)	Cable Loss (dB)	Preamp Factor (dB)	Level (dBuV/m)	Limit Line (dBuV/m)	Over Limit (dB)	Polarization
4880.00	21.35	31.85	8.66	32.12	29.74	54.00	-24.26	Vertical
7320.00	10.12	36.37	11.72	31.89	26.32	54.00	-27.68	Vertical
9760.00	4.61	38.35	14.25	31.59	25.62	54.00	-28.38	Vertical
12200.00	*					54.00		Vertical
14640.00	*					54.00		Vertical
4880.00	4880.00	24.63	31.85	8.66	32.12	33.02	54.00	Horizontal
7320.00	7320.00	14.98	36.37	11.72	31.89	31.18	54.00	Horizontal
9760.00	9760.00	8.94	38.35	14.25	31.59	29.95	54.00	Horizontal
12200.00	*					54.00		Horizontal
14640.00	*					54.00		Horizontal

Remark:

1. *Final Level = Receiver Read level + Antenna Factor + Cable Loss – Pre-amplifier Factor*
2. *“*”*, means this data is the too weak instrument of signal is unable to test.
3. *The emission levels of other frequencies are very lower than the limit and not show in test report.*

Test channel:	Highest
---------------	---------

Peak value:

Frequency (MHz)	Read Level (dBuV)	Antenna Factor (dB/m)	Cable Loss (dB)	Preamp Factor (dB)	Level (dBuV/m)	Limit Line (dBuV/m)	Over Limit (dB)	Polarization
4950.00	40.61	31.91	8.71	32.16	49.07	74.00	-24.93	Vertical
7425.00	26.52	36.56	11.79	31.80	43.07	74.00	-30.93	Vertical
9900.00	24.06	38.81	14.35	31.85	45.37	74.00	-28.63	Vertical
12375.00	*					74.00		Vertical
14850.00	*					74.00		Vertical
4950.00	38.29	31.91	8.71	32.16	46.75	74.00	-27.25	Horizontal
7425.00	27.23	36.56	11.79	31.80	43.78	74.00	-30.22	Horizontal
9900.00	22.52	38.81	14.35	31.85	43.83	74.00	-30.17	Horizontal
12375.00	*					74.00		Horizontal
14850.00	*					74.00		Horizontal

Average value:

Frequency (MHz)	Read Level (dBuV)	Antenna Factor (dB/m)	Cable Loss (dB)	Preamp Factor (dB)	Level (dBuV/m)	Limit Line (dBuV/m)	Over Limit (dB)	Polarization
4950.00	23.77	31.91	8.71	32.16	32.23	54.00	-21.77	Vertical
7425.00	9.34	36.56	11.79	31.80	25.89	54.00	-28.11	Vertical
9900.00	7.11	38.81	14.35	31.85	28.42	54.00	-25.58	Vertical
12375.00	*					54.00		Vertical
14850.00	*					54.00		Vertical
4950.00	21.46	31.91	8.71	32.16	29.92	54.00	-24.08	Horizontal
7425.00	7.94	36.56	11.79	31.80	24.49	54.00	-29.51	Horizontal
9900.00	5.85	38.81	14.35	31.85	27.16	54.00	-26.84	Horizontal
12375.00	*					54.00		Horizontal
14850.00	*					54.00		Horizontal

Remark:

1. Final Level = Receiver Read level + Antenna Factor + Cable Loss – Pre-amplifier Factor
2. “*”, means this data is too weak instrument of signal is unable to test.
3. The emission levels of other frequencies are very lower than the limit and not show in test report.

7 Test Setup Photo

Radiated Emission

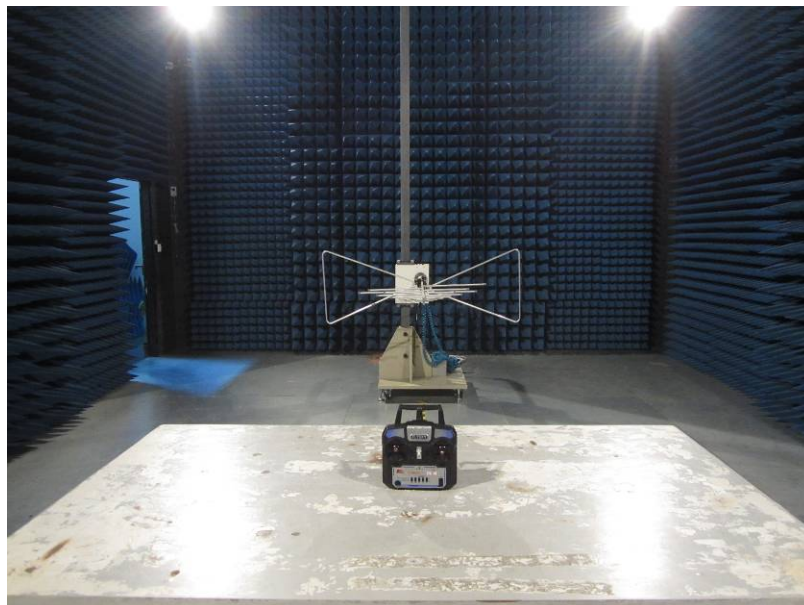
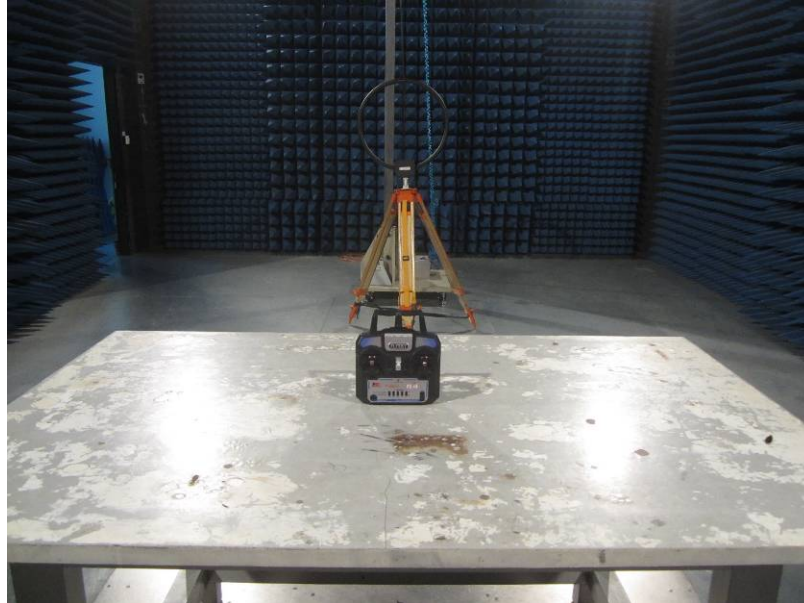

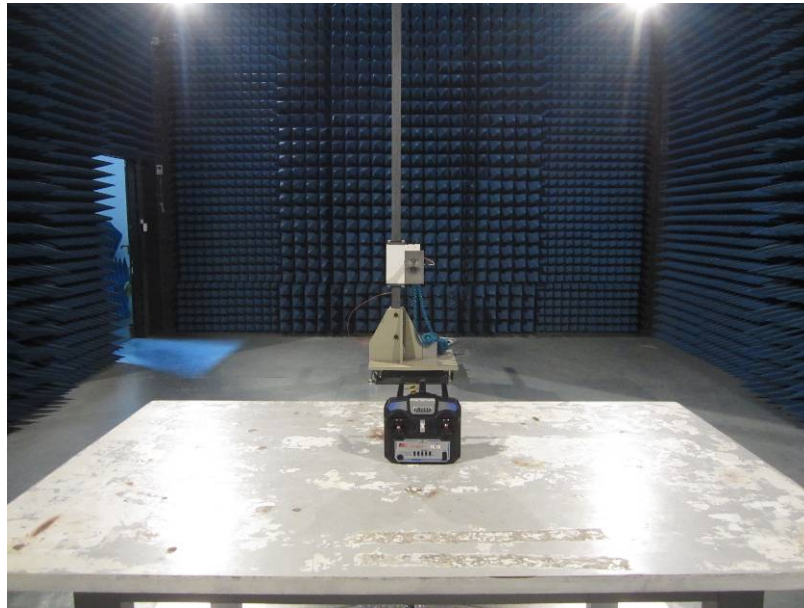

8 EUT Constructional Details





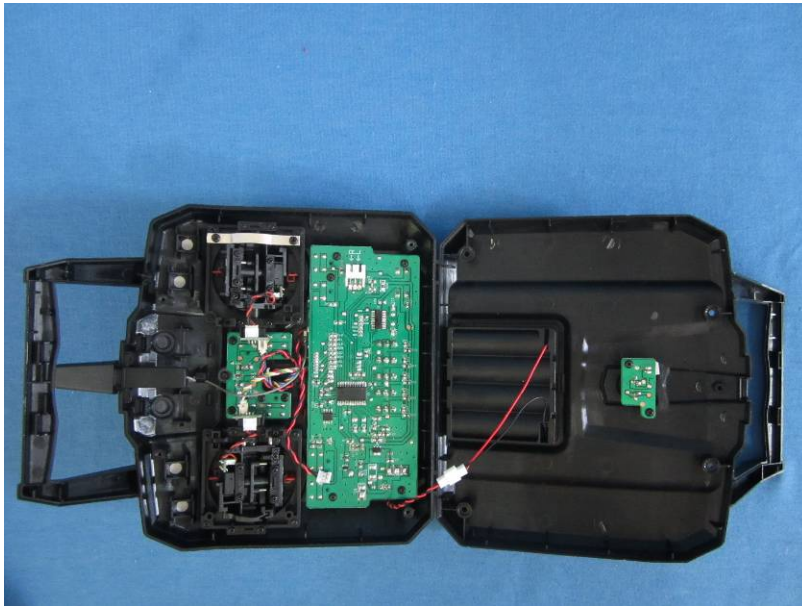
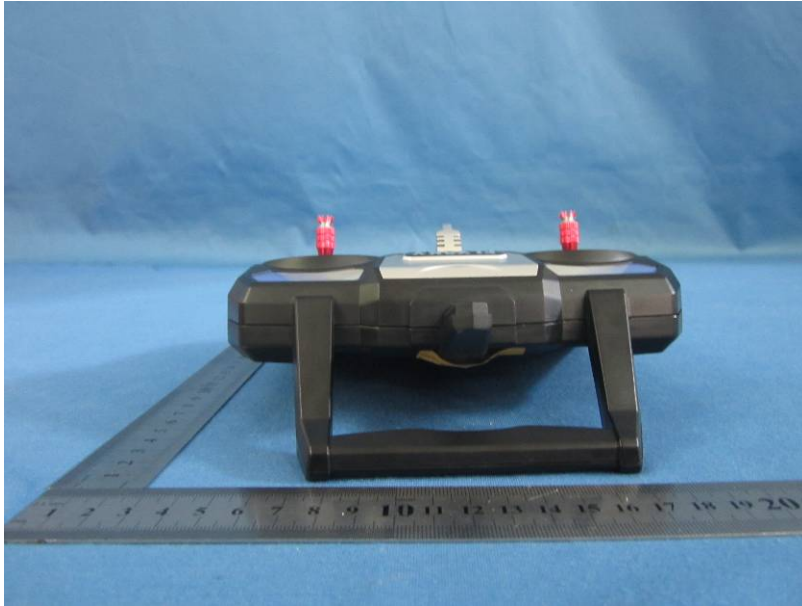

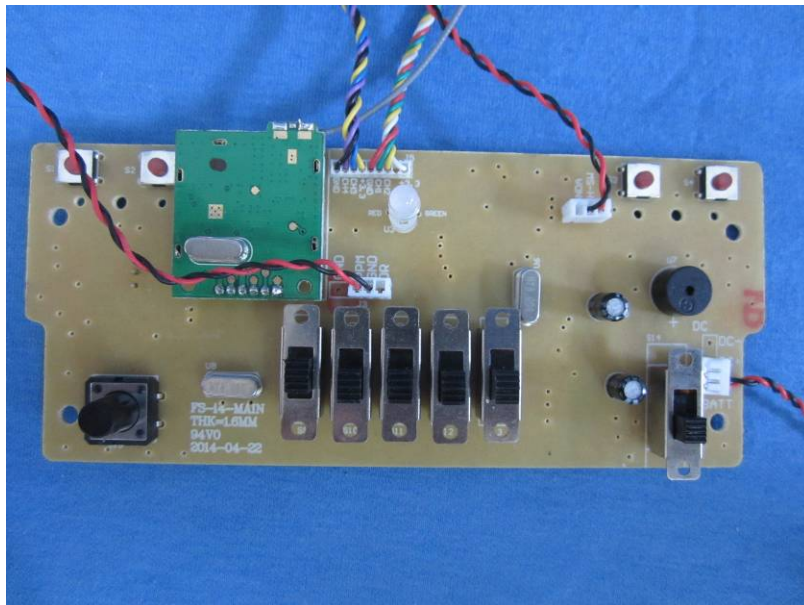
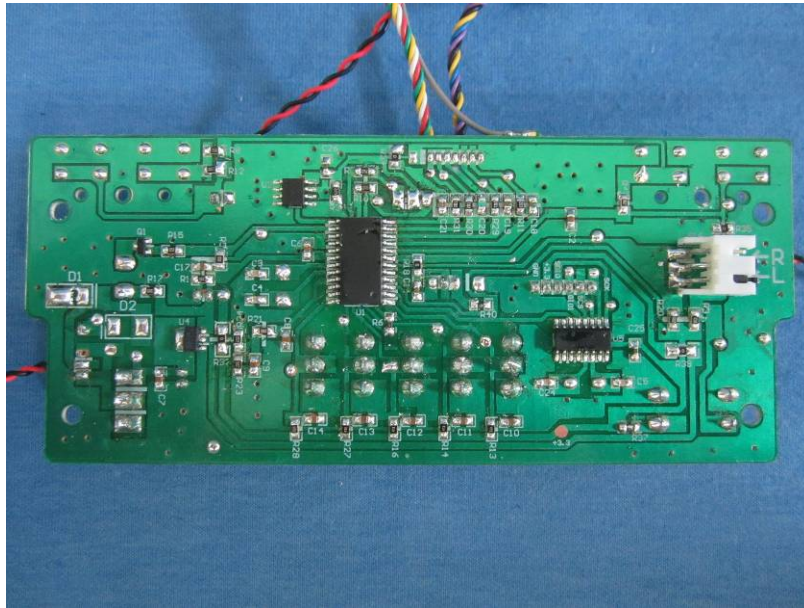

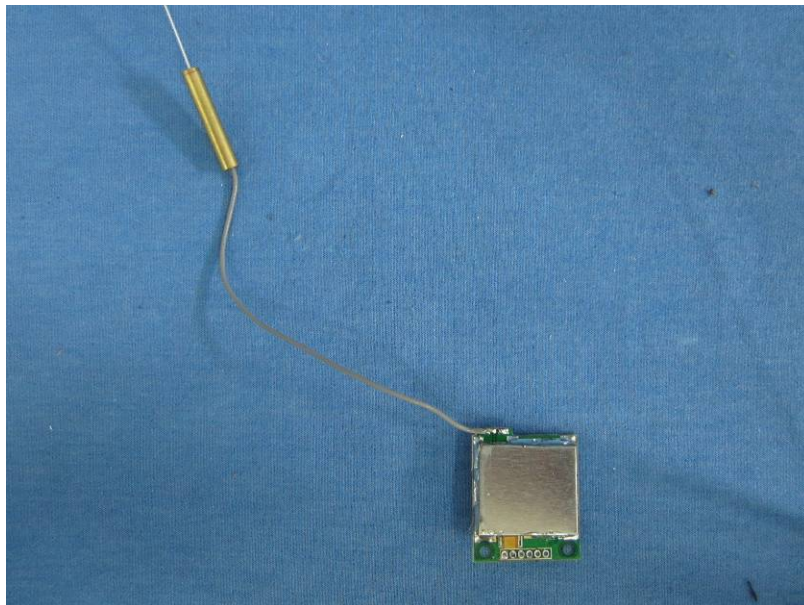
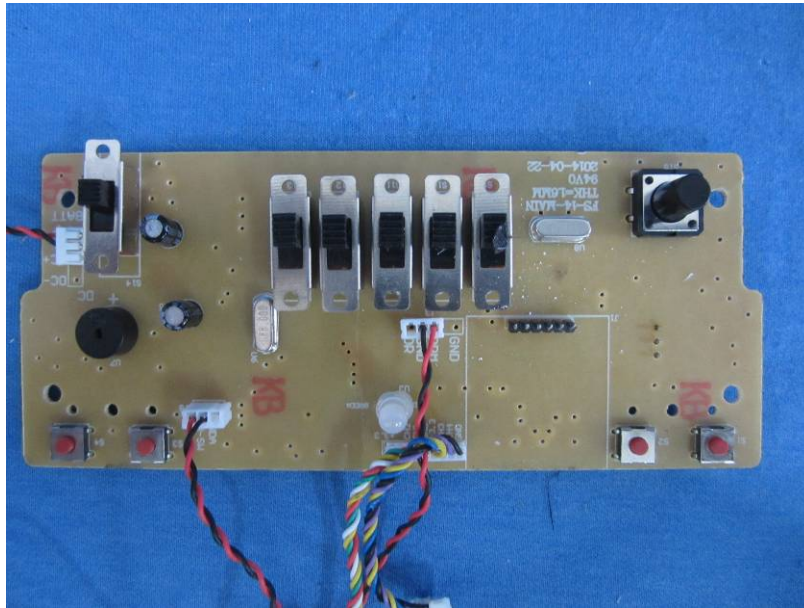

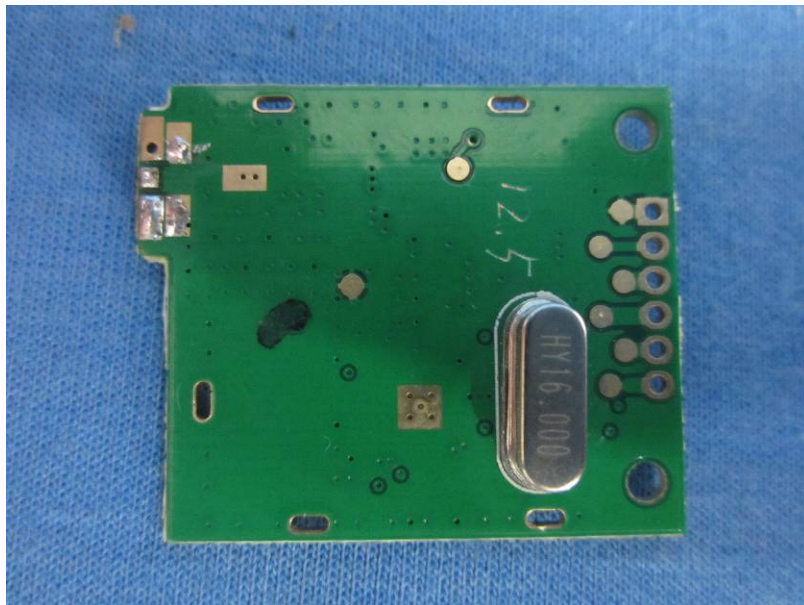
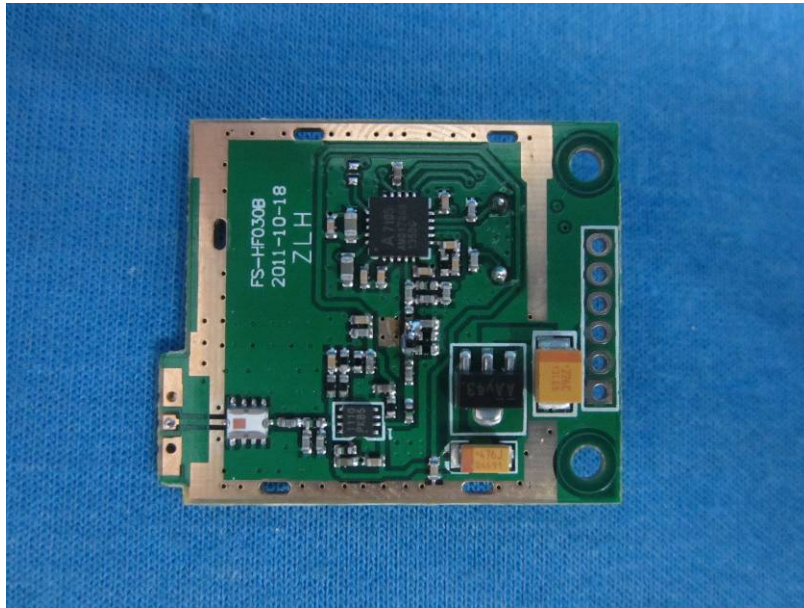

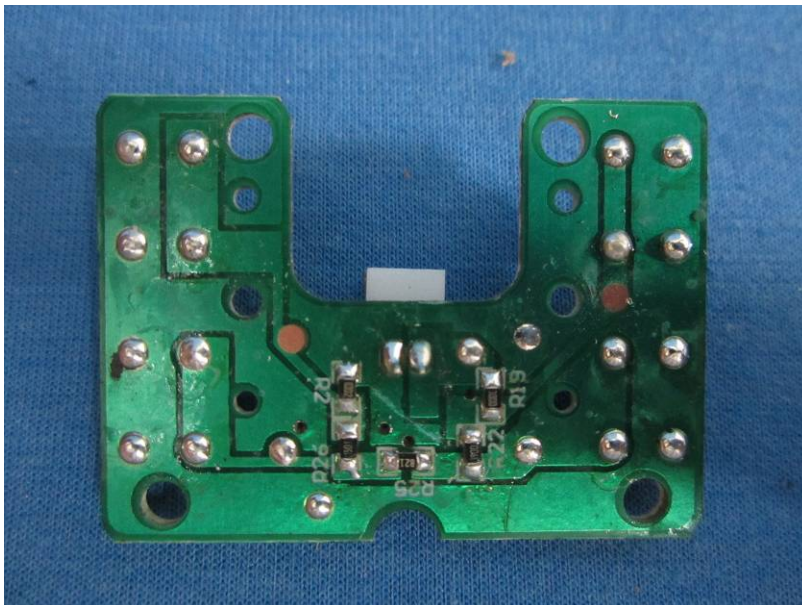
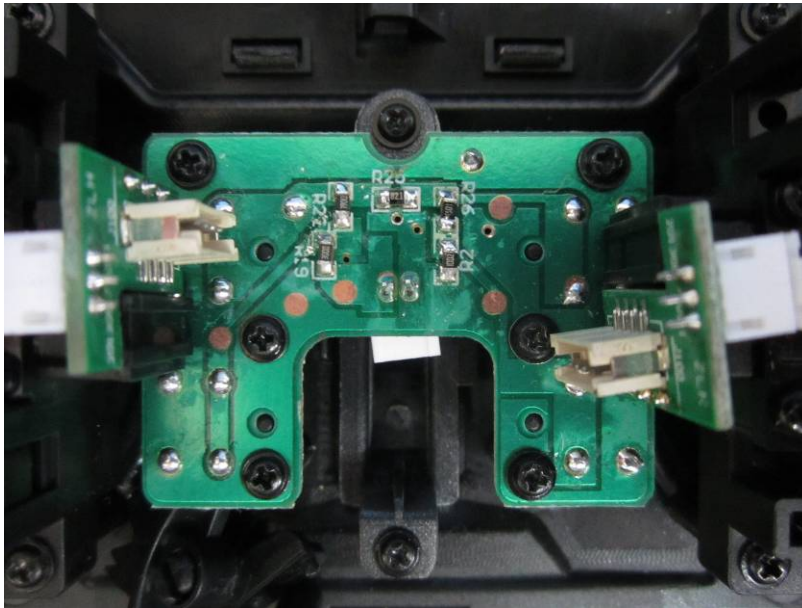

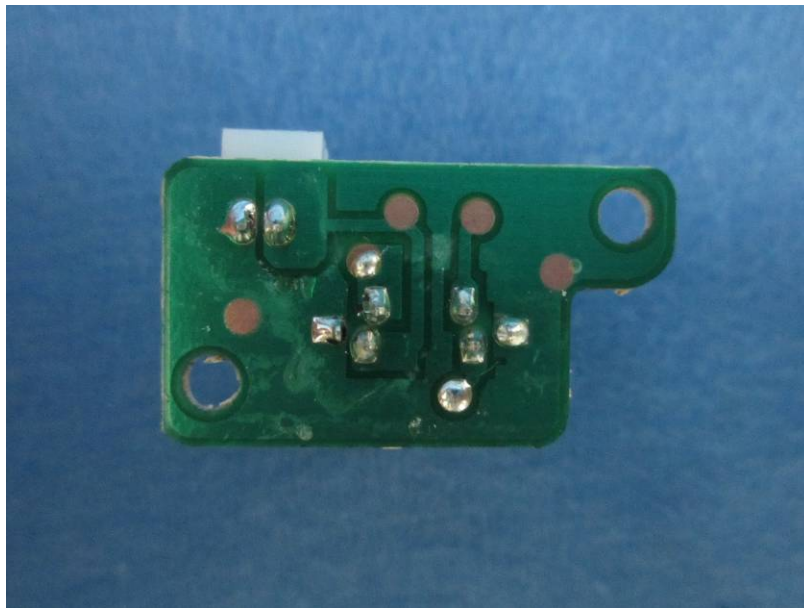
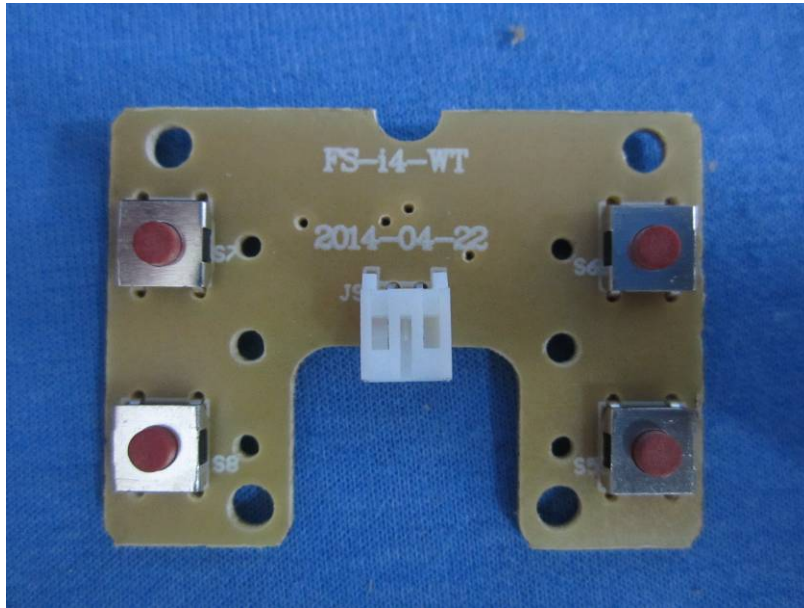



-----end---