

FCC REPORT

Applicant: FLYSKY RC MODEL TECHNOLOGY CO., LTD

Address of Applicant: West building3, Huangjianyuan Ind, Park QIAOLI North Gate
Changping Town Dongguan CN.

Equipment Under Test (EUT)

Product Name: 3CH Gun Radio

Model No.: FS-GT3B, HK-GT3B

FCC ID: N4ZFLYSKYGT3B

Applicable standards: FCC CFR Title 47 Part 15 Subpart C Section 15.249:2010

Date of sample receipt: August 03, 2012

Date of Test: August 06-08, 2012

Date of report issued: August 09, 2012

Test Result : PASS *

* In the configuration tested, the EUT complied with the standards specified above.

Authorized Signature:



Robinson Lo
Laboratory Manager

This report details the results of the testing carried out on one sample. The results contained in this test report do not relate to other samples of the same product and does not permit the use of the GTS product certification mark. The manufacturer should ensure that all products in series production are in conformity with the product sample detailed in this report.

This report may only be reproduced and distributed in full. If the product in this report is used in any configuration other than that detailed in the report, the manufacturer must ensure the new system complies with all relevant standards. Any mention of GTS International Electrical Approvals or testing done by GTS International Electrical Approvals in connection with, distribution or use of the product described in this report must be approved by GTS International Electrical Approvals in writing.

This document cannot be reproduced except in full, without prior written approval of the Company. Any unauthorized alteration, forgery or falsification of the content or appearance of this document is unlawful and offenders may be prosecuted to the fullest extent of the law. Unless otherwise stated the results shown in this test report refer only to the sample(s) tested and such sample(s) are retained for 90 days only."

2 Version

Version No.	Date	Description
00	August 09, 2012	Original

Prepared By:

Oscar. Li

Date:

August 09, 2012

Project Engineer

Check By:

Hans. Hu

Date:

August 09, 2012

Reviewer

3 Contents

	Page
1 COVER PAGE.....	1
2 VERSION.....	2
3 CONTENTS.....	3
4 TEST SUMMARY.....	4
5 GENERAL INFORMATION.....	5
5.1 CLIENT INFORMATION.....	5
5.2 GENERAL DESCRIPTION OF E.U.T.....	5
5.3 TEST MODE.....	6
5.4 DESCRIPTION OF SUPPORT UNITS.....	6
5.5 TEST FACILITY.....	6
5.6 TEST LOCATION.....	6
5.7 OTHER INFORMATION REQUESTED BY THE CUSTOMER.....	6
5.8 TEST INSTRUMENTS LIST.....	7
6 TEST RESULTS AND MEASUREMENT DATA.....	8
6.1 ANTENNA REQUIREMENT:.....	8
6.2 RADIATED EMISSION METHOD.....	9
6.2.1 <i>Field Strength of The Fundamental Signal</i>	11
6.2.2 <i>Spurious emissions</i>	12
6.2.3 <i>Bandedge emissions</i>	16
6.3 20dB OCCUPY BANDWIDTH.....	17
7 TEST SETUP PHOTO.....	19
8 EUT CONSTRUCTIONAL DETAILS.....	20

4 Test Summary

Test Item	Section in CFR 47	Result
Antenna requirement	15.203	Pass
AC Power Line Conducted Emission	15.207	N/A
Field strength of the fundamental signal	15.249 (a)	Pass
Spurious emissions	15.249 (a) (d)/15.209	Pass
Band edge	15.249 (d)/15.205	Pass
20dB Occupied Bandwidth	15.215 (c)	Pass

Pass: The EUT complies with the essential requirements in the standard.

N/A: not applicable.

5 General Information

5.1 Client Information

Applicant:	FLYSKY RC MODEL TECHNOLOGY CO., LTD
Address of Applicant:	West building3, Huangjianyuan Ind, Park QIAOLI North Gate Changping Town Dongguan CN.
Manufacturer:	FLYSKY RC MODEL TECHNOLOGY CO., LTD
Address of Manufacturer:	West building3, Huangjianyuan Ind, Park QIAOLI North Gate Changping Town Dongguan CN.
Factory:	FLYSKY RC MODEL TECHNOLOGY CO., LTD
Address of factory :	West building3, Huangjianyuan Ind, Park QIAOLI North Gate Changping Town Dongguan CN.

5.2 General Description of E.U.T.

Product Name:	3CH Gun Radio
Model No.:	FS-GT3B, HK-GT3B
Operation Frequency:	2405.5MHz~2475MHz
Channel numbers:	16
Modulation technology:	GFSK
Antenna Type:	Integral
Antenna gain:	2dBi
Power supply:	DC 12V(8*1.5V ("AA" Size battery))

5.3 Test mode

Transmitting mode	Keep transmitting mode.
-------------------	-------------------------

Per-test mode.

We have verified the construction and function in typical operation, The EUT was placed on three different polar directions; i.e. X axis, Y axis, Z axis. which was shown in this test report and defined as follows:

Axis	X	Y	Z
Field Strength(dBuV/m)	106.87	108.49	107.45

Final Test Mode:

According to ANSI C63.4 standards, the test results are both the “worst case” and “worst setup”:

Y axis (see the test setup photo)

5.4 Description of Support Units

None.

5.5 Test Facility

The test facility is recognized, certified, or accredited by the following organizations:

- **FCC —Registration No.: 600491**

Global United Technology Services Co., Ltd., Shenzhen EMC Laboratory has been registered and fully described in a report filed with the (FCC) Federal Communications Commission.

The acceptance letter from the FCC is maintained in our files. Registration 600491, July 20, 2010.

- **Industry Canada (IC)**

The 3m Semi-anechoic chamber of Global United Technology Services Co., Ltd. Has been

Registered by Certification and Engineering Bureau of Industry Canada for radio equipment testing with Registration No.: 9079A-1.

5.6 Test Location

All tests were performed at:
Global United Technology Services Co., Ltd. Address: 2nd Floor, Block No.2, Laodong Industrial Zone, Xixiang Road Baoan District, Shenzhen, China Tel: 0755-27798480 Fax: 0755-27798960

5.7 Other Information Requested by the Customer

None.

5.8 Test Instruments list

Radiated Emission:						
Item	Test Equipment	Manufacturer	Model No.	Inventory No.	Cal.Date (mm-dd-yy)	Cal.Due date (mm-dd-yy)
1	3m Semi- Anechoic Chamber	ZhongYu Electron	9.2(L)*6.2(W)* 6.4(H)	GTS250	Mar. 30 2011	Mar. 29 2013
2	Control Room	ZhongYu Electron	6.2(L)*2.5(W)* 2.4(H)	GTS251	N/A	N/A
3	EMI Test Receiver	Rohde & Schwarz	ESU26	GTS203	Jul. 03 2012	Jul. 02 2013
4	BiConiLog Antenna	SCHWARZBECK MESS-ELEKTRONIK	VULB9163	GTS214	Feb. 25 2012	Feb. 24 2013
5	Double -ridged waveguide horn	SCHWARZBECK MESS-ELEKTRONIK	9120D-829	GTS208	June 29 2012	June 28 2013
6	Horn Antenna	ETS-LINDGREN	3160	GTS217	Mar. 30 2011	Mar. 29 2013
7	EMI Test Software	AUDIX	E3	N/A	N/A	N/A
8	Coaxial Cable	GTS	N/A	GTS213	Mar. 31 2012	Mar. 30 2013
9	Coaxial Cable	GTS	N/A	GTS211	Mar. 31 2012	Mar. 30 2013
10	Coaxial cable	GTS	N/A	GTS210	Mar. 31 2012	Mar. 30 2013
11	Coaxial Cable	GTS	N/A	GTS212	Mar. 31 2012	Mar. 30 2013
12	Amplifier(100kHz-3GHz)	HP	8347A	GTS204	Jul. 03 2012	Jul. 02 2013
13	Amplifier(2GHz-20GHz)	HP	8349B	GTS206	Jul. 03 2012	Jul. 02 2013
14	Amplifier (18-26GHz)	Rohde & Schwarz	AFS33-18002 650-30-8P-44	GTS218	June 29 2012	June 28 2013
15	Band filter	Amindeon	82346	GTS219	Mar. 31 2012	Mar. 30 2013

6 Test results and Measurement Data

6.1 Antenna requirement:

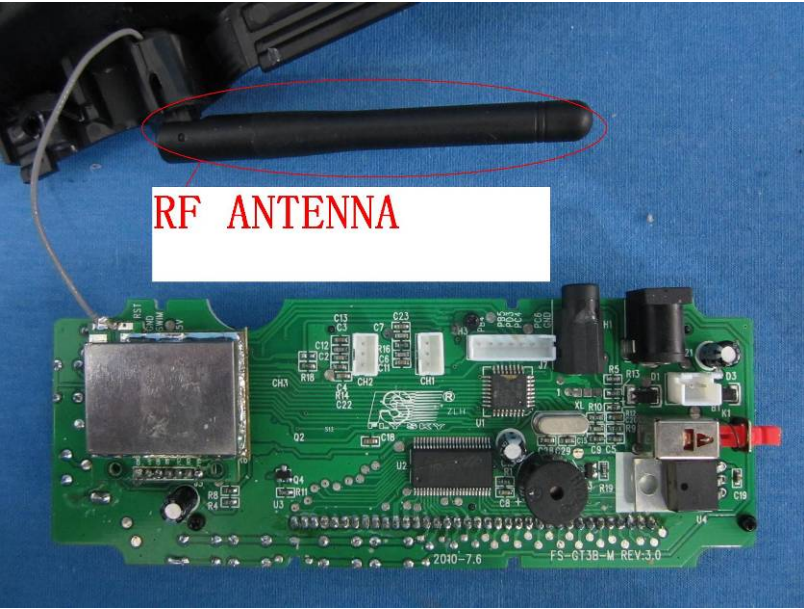
Standard requirement:	FCC Part15 C Section 15.203
<p>15.203 requirement:</p> <p>An intentional radiator shall be designed to ensure that no antenna other than that furnished by the responsible party shall be used with the device. The use of a permanently attached antenna or of an antenna that uses a unique coupling to the intentional radiator, the manufacturer may design the unit so that a broken antenna can be replaced by the user, but the use of a standard antenna jack or electrical connector is prohibited.</p>	
<p>E.U.T Antenna:</p>	
<p><i>The antenna is Integral antenna, the best case gain of the antenna is 2dBi</i></p> 	

6.2 Radiated Emission Method

Test Requirement:	FCC Part15 C Section 15.209				
Test Method:	ANSI C63.4:2003				
Test Frequency Range:	30MHz to 25GHz				
Test site:	Measurement Distance: 3m				
Receiver setup:	Frequency	Detector	RBW	VBW	Remark
	30MHz-1GHz	Quasi-peak	120KHz	300KHz	Quasi-peak Value
	Above 1GHz	Peak	1MHz	3MHz	Peak Value
AV		1MHz	10Hz	Average Value	
Limit: (Field strength of the fundamental signal)	Frequency		Limit (dBuV/m @3m)		Remark
	2400MHz-2483.5MHz		94.00		Average Value
			114.00		Peak Value
Limit: (Spurious Emissions)	Frequency		Limit (dBuV/m @3m)		Remark
	30MHz-88MHz		40.00		Quasi-peak Value
	88MHz-216MHz		43.50		Quasi-peak Value
	216MHz-960MHz		46.00		Quasi-peak Value
	960MHz-1GHz		54.00		Quasi-peak Value
	Above 1GHz		54.00		Average Value
74.00			Peak Value		
Limit: (band edge)	Emissions radiated outside of the specified frequency bands, except for harmonics, shall be attenuated by at least 50 dB below the level of the fundamental or to the general radiated emission limits in Section 15.209, whichever is the lesser attenuation.				
Test setup:	<p>Below 1GHz</p> <p>Above 1GHz</p>				

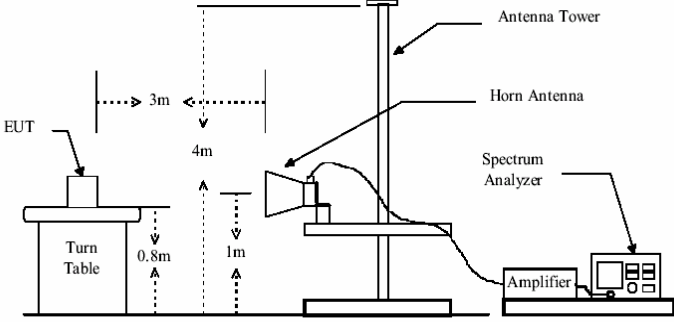
	 <p>The diagram illustrates the test setup. An EUT (Equipment Under Test) is placed on a turn table that is 0.8 meters high from the ground. The turn table is positioned 3 meters away from a horn antenna. The horn antenna is mounted on an antenna tower, and its height is adjustable, ranging from 1 meter to 4 meters above the ground. The antenna is connected to a spectrum analyzer and an amplifier.</p>
<p>Test Procedure:</p>	<ol style="list-style-type: none"> 1. The EUT was placed on the top of a rotating table 0.8 meters above the ground at a 3 meter camber. The table was rotated 360 degrees to determine the position of the highest radiation. 2. The EUT was set 3 meters away from the interference-receiving antenna, which was mounted on the top of a variable-height antenna tower. 3. The antenna height is varied from one meter to four meters above the ground to determine the maximum value of the field strength. Both horizontal and vertical polarizations of the antenna are set to make the measurement. 4. For each suspected emission, the EUT was arranged to its worst case and then the antenna was tuned to heights from 1 meter to 4 meters and the rota table was turned from 0 degrees to 360 degrees to find the maximum reading. 5. The test-receiver system was set to Peak Detect Function and Specified Bandwidth with Maximum Hold Mode. 6. If the emission level of the EUT in peak mode was 10dB lower than the limit specified, then testing could be stopped and the peak values of the EUT would be reported. Otherwise the emissions that did not have 10dB margin would be re-tested one by one using peak, quasi-peak or average method as specified and then reported in a data sheet.
<p>Test Instruments:</p>	<p>Refer to section 5.8 for details</p>
<p>Test mode:</p>	<p>Transmitting mode</p>
<p>Test results:</p>	<p>Pass</p>

Measurement data:

6.2.1 Field Strength of The Fundamental Signal

Peak value:

Frequency (MHz)	Read Level (dBuV)	Antenna Factor (dB/m)	Cable Loss (dB)	Preamp Factor (dB)	Level (dBuV/m)	Limit Line (dBuV/m)	Over Limit (dB)	polarization
2405.50	95.52	27.57	5.40	30.12	98.37	114.00	-15.63	Horizontal
2405.50	105.64	27.57	5.40	30.12	108.49	114.00	-5.51	Vertical
2442.50	96.19	27.48	5.43	30.06	99.04	114.00	-14.96	Horizontal
2442.50	104.90	27.48	5.43	30.06	107.75	114.00	-6.25	Vertical
2475.00	97.12	27.52	5.47	29.99	100.12	114.00	-13.88	Horizontal
2475.00	105.39	27.52	5.47	29.99	108.39	114.00	-5.61	Vertical

Average value:

Frequency (MHz)	Read Level (dBuV)	Antenna Factor (dB/m)	Cable Loss (dB)	Preamp Factor (dB)	Level (dBuV/m)	Limit Line (dBuV/m)	Over Limit (dB)	polarization
2405.50	55.14	27.57	5.40	30.12	57.99	94.00	-36.01	Horizontal
2405.50	62.34	27.57	5.40	30.12	65.19	94.00	-28.81	Vertical
2442.50	56.21	27.48	5.43	30.06	59.06	94.00	-34.94	Horizontal
2442.50	60.87	27.48	5.43	30.06	63.72	94.00	-30.28	Vertical
2475.00	58.10	27.52	5.47	29.99	61.10	94.00	-32.90	Horizontal
2475.00	65.21	27.52	5.47	29.99	68.21	94.00	-25.79	Vertical

According to the follow transmitter output power (P_t) formula:

$$P_t = (E \times d)^2 / (30 \times g_t)$$

P_t =transmitter output power in watts

g_t =numeric gain of the transmitting antenna (unitless)

E=electric field strength in V/m

d= measurement distance in meters (m).

According to the above test data, $E_{max}=108.49\text{dBuV/m}=0.266\text{V/m}$, $d=3\text{m}$, $g_t=1.58$

$$P_t = (E \times d)^2 / (30 \times g_t) = (0.266 \times 3)^2 / (30 \times 1.58) = 0.0134\text{W}$$

6.2.2 Spurious emissions

■ Below 1GHz

Frequency (MHz)	Read Level (dBuV)	Antenna Factor (dB/m)	Cable Loss (dB)	Preamp Factor (dB)	Level (dBuV/m)	Limit Line (dBuV/m)	Over Limit (dB)	polarization
60.28	39.19	15.70	0.86	31.94	23.81	40.00	-16.19	Vertical
96.44	37.67	16.02	1.16	31.75	23.10	43.50	-20.40	Vertical
166.07	40.92	11.88	1.66	32.04	22.42	43.50	-21.08	Vertical
350.48	42.83	16.30	2.62	32.02	29.73	46.00	-16.27	Vertical
642.86	38.32	21.06	3.88	31.11	32.15	46.00	-13.85	Vertical
906.48	38.93	24.06	4.88	31.18	36.69	46.00	-9.31	Vertical
40.85	38.94	16.58	0.67	32.05	24.14	40.00	-15.86	Horizontal
53.69	39.74	16.16	0.81	31.95	24.76	40.00	-15.24	Horizontal
103.81	38.98	15.73	1.22	31.78	24.15	43.50	-19.35	Horizontal
236.65	39.75	14.99	2.05	32.16	24.63	46.00	-21.37	Horizontal
478.85	39.40	18.07	3.22	31.63	29.06	46.00	-16.94	Horizontal
796.18	39.53	23.01	4.45	31.31	35.68	46.00	-10.32	Horizontal

■ Above 1GHz

Test channel:	Lowest channel
---------------	----------------

Peak value:

Frequency (MHz)	Read Level (dBuV)	Antenna Factor (dB/m)	Cable Loss (dB)	Preamp Factor (dB)	Level (dBuV/m)	Limit Line (dBuV/m)	Over Limit (dB)	polarization
4810.00	38.96	31.78	8.60	24.17	55.17	74.00	-18.83	Vertical
7215.00	39.29	36.15	11.66	26.46	60.64	74.00	-13.36	Vertical
9620.00	39.03	38.01	14.14	25.45	65.73	74.00	-8.27	Vertical
12025.00	*					74.00		Vertical
14430.00	*					74.00		Vertical
4810.00	37.68	31.78	8.60	24.17	53.89	74.00	-20.11	Horizontal
7215.00	37.65	36.15	11.66	26.46	59.00	74.00	-15.00	Horizontal
9620.00	37.44	38.01	14.14	25.45	64.14	74.00	-9.86	Horizontal
12025.00	*					74.00		Horizontal
14430.00	*					74.00		Horizontal

Average value:

Frequency (MHz)	Read Level (dBuV)	Antenna Factor (dB/m)	Cable Loss (dB)	Preamp Factor (dB)	Level (dBuV/m)	Limit Line (dBuV/m)	Over Limit (dB)	polarization
4810.00	18.66	31.78	8.60	24.17	34.87	54.00	-19.13	Vertical
7215.00	18.89	36.15	11.66	26.46	40.24	54.00	-13.76	Vertical
9620.00	18.63	38.01	14.14	25.45	45.33	54.00	-8.67	Vertical
12025.00	*					54.00		Vertical
14430.00	*					54.00		Vertical
4810.00	16.58	31.78	8.60	24.17	32.79	54.00	-21.21	Horizontal
7215.00	17.05	36.15	11.66	26.46	38.40	54.00	-15.60	Horizontal
9620.00	16.64	38.01	14.14	25.45	43.34	54.00	-10.66	Horizontal
12025.00	*					54.00		Horizontal
14430.00	*					54.00		Horizontal

Remark:

1. Final Level = Receiver Read level + Antenna Factor + Cable Loss – Preamplifier Factor
2. The emission levels of other frequencies are very lower than the limit and not show in test report.
3. “*”, means this data is the too weak instrument of signal is unable to test.

Test channel:	Middle channel
---------------	----------------

Peak value:

Frequency (MHz)	Read Level (dBuV)	Antenna Factor (dB/m)	Cable Loss (dB)	Preamp Factor (dB)	Level (dBuV/m)	Limit Line (dBuV/m)	Over Limit (dB)	polarization
4884.00	39.07	31.86	8.67	24.10	55.50	74.00	-18.50	Vertical
7326.00	41.04	36.41	11.72	26.78	62.39	74.00	-11.61	Vertical
9768.00	39.19	38.35	14.27	25.35	66.46	74.00	-7.54	Vertical
12210.00	*					74.00		Vertical
14652.00	*					74.00		Vertical
4884.00	39.32	31.86	8.67	24.10	55.75	74.00	-18.25	Horizontal
7326.00	38.98	36.41	11.72	26.78	60.33	74.00	-13.67	Horizontal
9768.00	37.06	38.35	14.27	25.35	64.33	74.00	-9.67	Horizontal
12210.00	*					74.00		Horizontal
14652.00	*					74.00		Horizontal

Average value:

Frequency (MHz)	Read Level (dBuV)	Antenna Factor (dB/m)	Cable Loss (dB)	Preamp Factor (dB)	Level (dBuV/m)	Limit Line (dBuV/m)	Over Limit (dB)	polarization
4884.00	18.57	31.86	8.67	24.10	35.00	54.00	-19.00	Vertical
7326.00	20.64	36.41	11.72	26.78	41.99	54.00	-12.01	Vertical
9768.00	18.79	38.35	14.27	25.35	46.06	54.00	-7.94	Vertical
12210.00	*					54.00		Vertical
14652.00	*					54.00		Vertical
4884.00	18.62	31.86	8.67	24.10	35.05	54.00	-18.95	Horizontal
7326.00	18.68	36.41	11.72	26.78	40.03	54.00	-13.97	Horizontal
9768.00	16.96	38.35	14.27	25.35	44.23	54.00	-9.77	Horizontal
12210.00	*					54.00		Horizontal
14652.00	*					54.00		Horizontal

Remark:

1. *Final Level = Receiver Read level + Antenna Factor + Cable Loss – Pre-amplifier Factor*
2. *The emission levels of other frequencies are very lower than the limit and not show in test report.*
3. *“**”, means this data is the too weak instrument of signal is unable to test.*

Test channel:	Highest channel
---------------	-----------------

Peak value:

Frequency (MHz)	Read Level (dBuV)	Antenna Factor (dB/m)	Cable Loss (dB)	Preamp Factor (dB)	Level (dBuV/m)	Limit Line (dBuV/m)	Over Limit (dB)	polarization
4950.00	44.94	31.91	8.71	24.03	61.53	74.00	-12.47	Vertical
7425.00	40.77	36.56	11.79	27.03	62.09	74.00	-11.91	Vertical
9900.00	37.49	38.81	14.35	25.27	65.38	74.00	-8.62	Vertical
12375.00	*					74.00		Vertical
14850.00	*					74.00		Vertical
4950.00	39.60	31.91	8.71	24.03	56.19	74.00	-17.81	Horizontal
7425.00	39.14	36.56	11.79	27.03	60.46	74.00	-13.54	Horizontal
9900.00	37.55	38.81	14.35	25.27	65.44	74.00	-8.56	Horizontal
12375.00	*					74.00		Horizontal
14850.00	*					74.00		Horizontal

Average value:

Frequency (MHz)	Read Level (dBuV)	Antenna Factor (dB/m)	Cable Loss (dB)	Preamp Factor (dB)	Level (dBuV/m)	Limit Line (dBuV/m)	Over Limit (dB)	polarization
4950.00	24.54	31.91	8.71	24.03	41.13	54.00	-12.87	Vertical
7425.00	20.37	36.56	11.79	27.03	41.69	54.00	-12.31	Vertical
9900.00	17.09	38.81	14.35	25.27	44.98	54.00	-9.02	Vertical
12375.00	*					54.00		Vertical
14850.00	*					54.00		Vertical
4950.00	19.20	31.91	8.71	24.03	35.79	54.00	-18.21	Horizontal
7425.00	18.54	36.56	11.79	27.03	39.86	54.00	-14.14	Horizontal
9900.00	16.85	38.81	14.35	25.27	44.74	54.00	-9.26	Horizontal
12375.00	*					54.00		Horizontal
14850.00	*					54.00		Horizontal

Remark:

1. *Final Level = Receiver Read level + Antenna Factor + Cable Loss – Preamplifier Factor*
2. *The emission levels of other frequencies are very lower than the limit and not show in test report.*
3. *“**”, means this data is the too weak instrument of signal is unable to test.*

6.2.3 Bandedge emissions

Test channel:	Lowest channel
---------------	----------------

Peak value:

Frequency (MHz)	Read Level (dBuV)	Antenna Factor (dB/m)	Cable Loss (dB)	Preamp Factor (dB)	Level (dBuV/m)	Limit Line (dBuV/m)	Over Limit (dB)	Polarization
2310.00	40.17	27.91	5.30	30.37	43.01	74.00	-30.99	Horizontal
2390.00	51.28	27.59	5.38	30.18	54.07	74.00	-19.93	Horizontal
2310.00	47.42	27.91	5.30	30.37	50.26	74.00	-23.74	Vertical
2390.00	60.12	27.59	5.38	30.18	62.91	74.00	-11.09	Vertical

Average value:

Frequency (MHz)	Read Level (dBuV)	Antenna Factor (dB/m)	Cable Loss (dB)	Preamp Factor (dB)	Level (dBuV/m)	Limit Line (dBuV/m)	Over Limit (dB)	Polarization
2310.00	20.07	27.91	5.30	30.37	22.91	54.00	-31.09	Horizontal
2390.00	31.08	27.59	5.38	30.18	33.87	54.00	-20.13	Horizontal
2310.00	26.12	27.91	5.30	30.37	28.96	54.00	-25.04	Vertical
2390.00	38.12	27.59	5.38	30.18	40.91	54.00	-13.09	Vertical

Test channel:	Highest channel
---------------	-----------------

Peak value:

Frequency (MHz)	Read Level (dBuV)	Antenna Factor (dB/m)	Cable Loss (dB)	Preamp Factor (dB)	Level (dBuV/m)	Limit Line (dBuV/m)	Over Limit (dB)	Polarization
2483.50	58.99	27.53	5.47	29.93	62.06	74.00	-11.94	Horizontal
2500.00	47.49	27.55	5.49	29.93	50.60	74.00	-23.40	Horizontal
2483.50	67.21	27.53	5.47	29.93	70.28	74.00	-3.72	Vertical
2500.00	63.40	27.55	5.49	29.93	66.51	74.00	-7.49	Vertical

Average value:

Frequency (MHz)	Read Level (dBuV)	Antenna Factor (dB/m)	Cable Loss (dB)	Preamp Factor (dB)	Level (dBuV/m)	Limit Line (dBuV/m)	Over Limit (dB)	Polarization
2483.50	38.59	27.53	5.47	29.93	41.66	54.00	-12.34	Horizontal
2500.00	27.39	27.55	5.49	29.93	30.50	54.00	-23.50	Horizontal
2483.50	45.61	27.53	5.47	29.93	48.68	54.00	-5.32	Vertical
2500.00	41.30	27.55	5.49	29.93	44.41	54.00	-9.59	Vertical

Remark:

- Final Level = Receiver Read level + Antenna Factor + Cable Loss – Preamplifier Factor

6.3 20dB Occupy Bandwidth

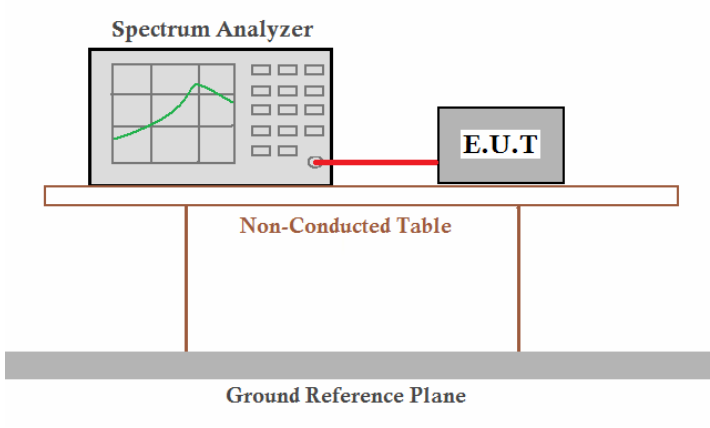
Test Requirement:	FCC Part15 C Section 15.249/15.215
Test Method:	ANSI C63.4:2003
Limit:	Operation Frequency range 2400MHz~2483.5MHz
Test setup:	 <p>The diagram illustrates the test setup. A Spectrum Analyzer is connected to an E.U.T. (Equipment Under Test) via a red cable. Both are placed on a Non-Conducted Table, which is supported by a Ground Reference Plane.</p>
Test Instruments:	Refer to section 5.8 for details
Test mode:	Transmitting mode
Test results:	Pass

Measurement Data

Test channel	20dB bandwidth(MHz)	Result
Lowest	1.143	Pass
Middle	1.137	Pass
Highest	1.134	Pass

Test plot as follows:

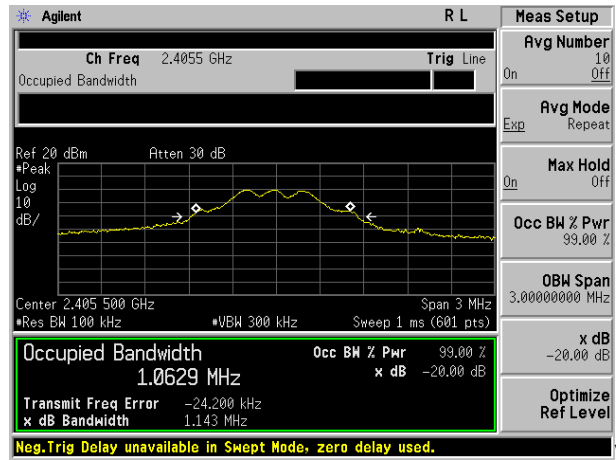

Lowest channel

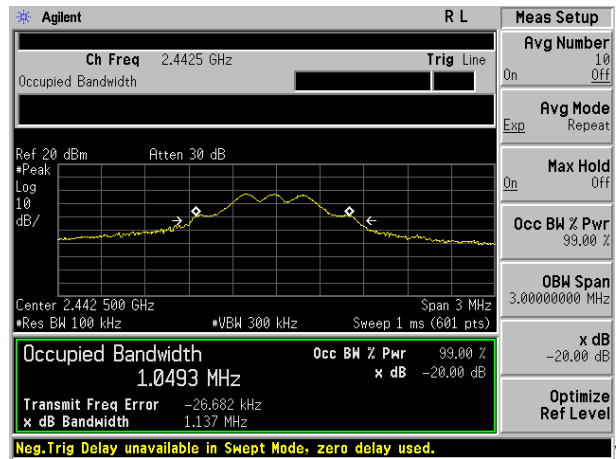

Middle channel

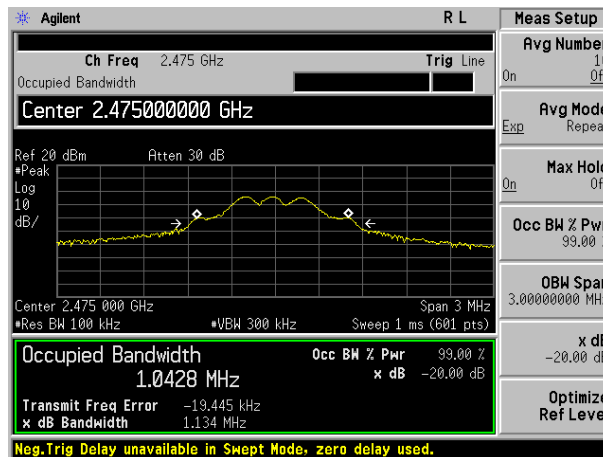

Highest channel

7 Test Setup Photo

Radiated Emission

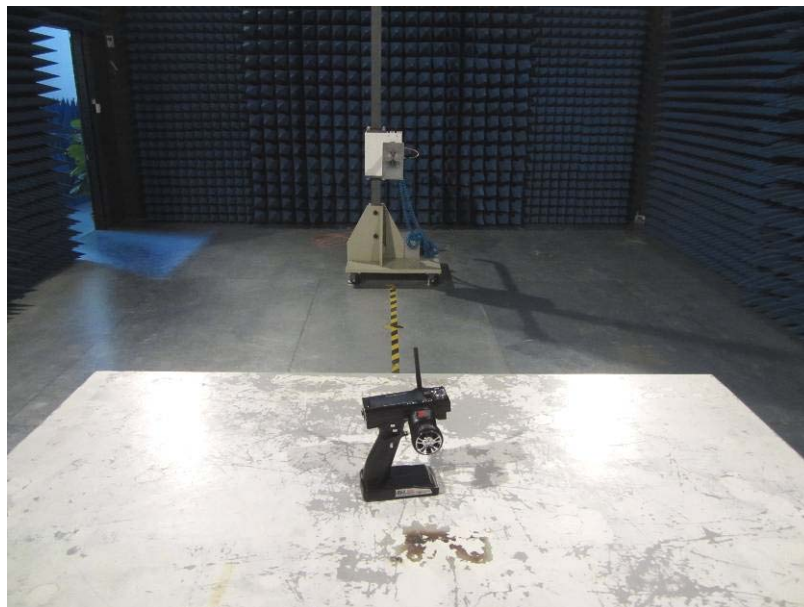
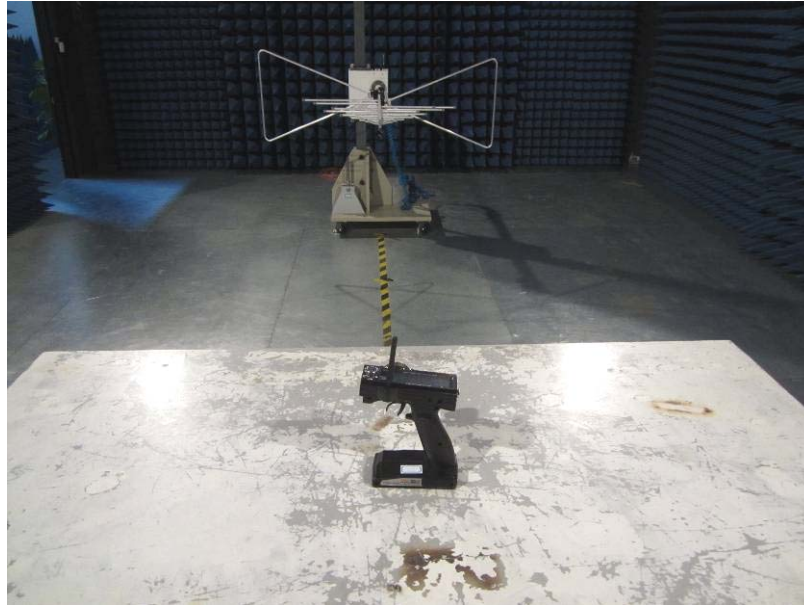

8 EUT Constructional Details

Model No.: FS-GT3B







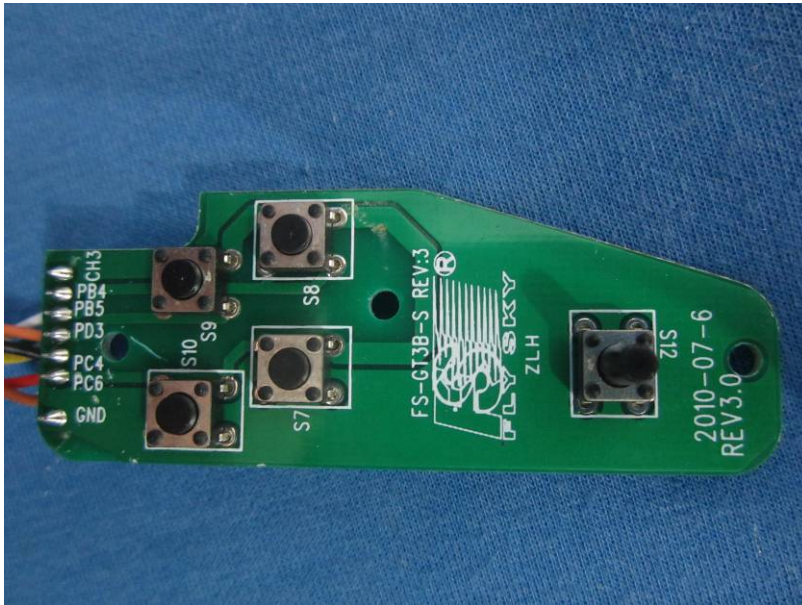

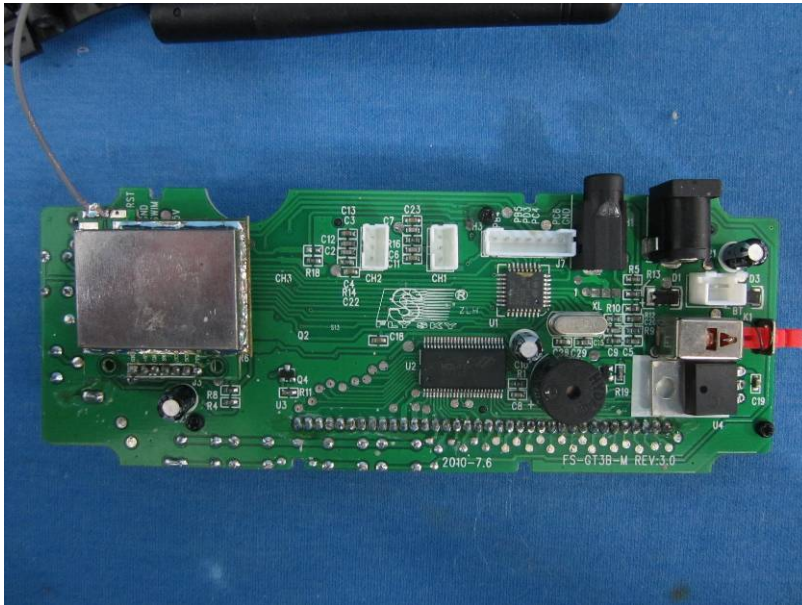
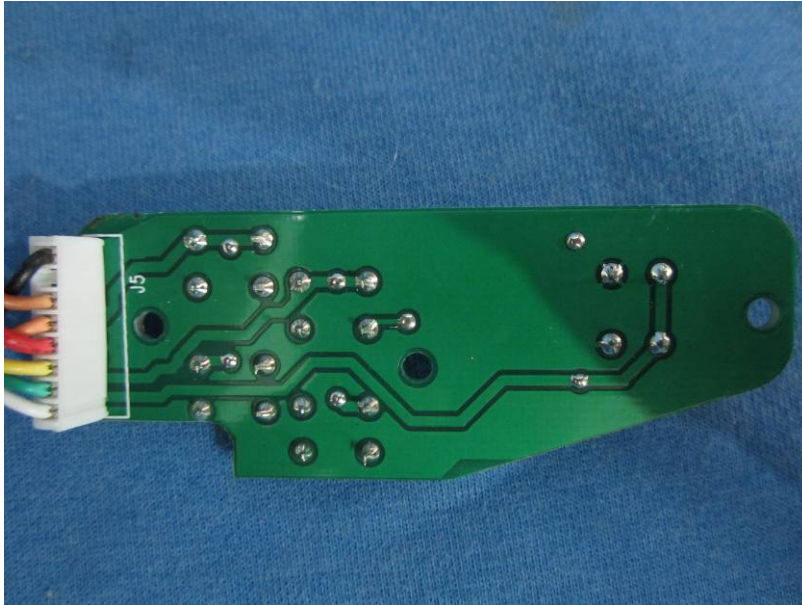

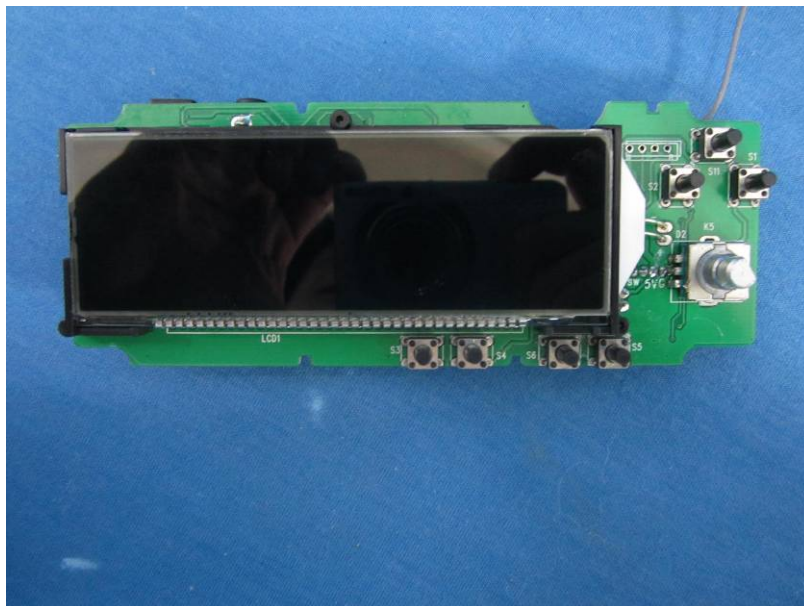
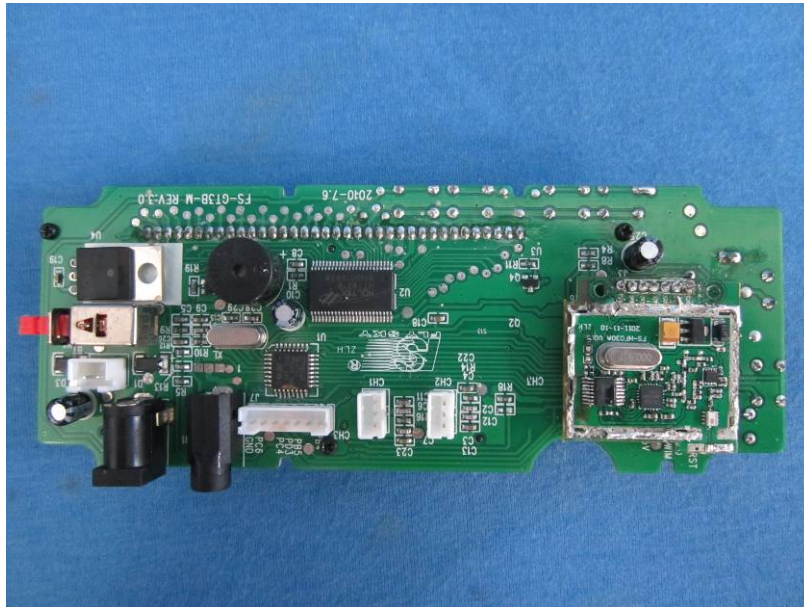

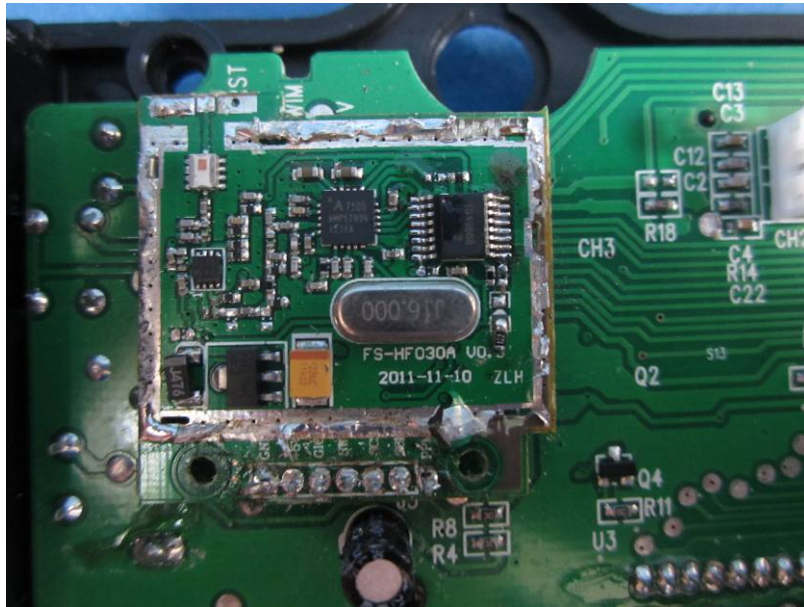

Model No.: HK-GT3B







-----End-----