

# FCC Report

**Applicant:** FLYSKY RC MODEL TECHNOLOGY CO., LTD

**Address of Applicant:** West building3, Huangjianyuan Ind, Park QIAOLI North Gate Changping Town, Dongguan, China

**Manufacturer:** ShenZhen FLYSKY Technology Co.,Ltd

**Address of Manufacturer:** 16F, Huafeng Building, No. 6006 Shennan Road, Futian District, Shenzhen, Guangdong, China

**Factory:** FLYSKY RC MODEL TECHNOLOGY CO., LTD

**Address of Factory:** West building3, Huangjianyuan Ind, Park QIAOLI North Gate Changping Town, Dongguan, China

**Equipment Under Test (EUT)**

Product Name: 2.4GHz 4CHANNELS RECEIVER

Model No.: FGr4S

Trade Mark: FLYSKY

**FCC ID:** N4ZFGRS400

**Applicable standards:** FCC CFR Title 47 Part 15 Subpart C Section 15.247

**Date of sample receipt:** September 20, 2018

**Date of Test:** September 20-November 05, 2018

**Date of report issued:** November 06, 2018

**Test Result :** PASS \*

\* In the configuration tested, the EUT complied with the standards specified above.

Authorized Signature:

Robinson Lo  
Laboratory Manager

This results shown in this test report refer only to the sample(s) tested, this test report cannot be reproduced, except in full, without prior written permission of the company. The report would be invalid without specific stamp of test institute and the signatures of compiler and approver.

## 2 Version

Version No.	Date	Description
00	November 06, 2018	Original

Prepared By:

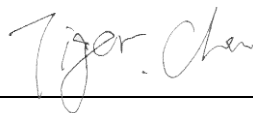

Date:

November 06, 2018

Project Engineer

Check By:



Date:

November 06, 2018

Reviewer

## 3 Contents

	Page
1 COVER PAGE .....	1
2 VERSION .....	2
3 CONTENTS .....	3
4 TEST SUMMARY .....	4
4.1 MEASUREMENT UNCERTAINTY .....	4
5 GENERAL INFORMATION .....	5
5.1 GENERAL DESCRIPTION OF EUT .....	5
5.2 TEST MODE .....	7
5.3 TEST FACILITY.....	7
5.4 TEST LOCATION .....	7
5.5 OTHER INFORMATION REQUESTED BY THE CUSTOMER .....	7
5.6 DESCRIPTION OF SUPPORT UNITS .....	7
5.7 ADDITIONAL INSTRUCTIONS.....	7
6 TEST INSTRUMENTS LIST .....	8
7 TEST RESULTS AND MEASUREMENT DATA.....	10
7.1 ANTENNA REQUIREMENT.....	10
7.2 CONDUCTED PEAK OUTPUT POWER .....	11
7.3 20dB EMISSION BANDWIDTH .....	13
7.4 CARRIER FREQUENCIES SEPARATION.....	15
7.5 HOPPING CHANNEL NUMBER .....	17
7.6 DWELL TIME.....	18
7.7 PSEUDORANDOM FREQUENCY HOPPING SEQUENCE .....	22
7.8 BAND EDGE .....	23
7.8.1 Conducted Emission Method.....	23
7.8.2 Radiated Emission Method.....	25
7.9 SPURIOUS EMISSION.....	30
7.9.1 Conducted Emission Method.....	30
7.9.2 Radiated Emission Method.....	32
8 TEST SETUP PHOTO .....	43
9 EUT CONSTRUCTIONAL DETAILS .....	44

## 4 Test Summary

Test Item	Section	Result
Antenna Requirement	15.203/15.247 (c)	Pass
AC Power Line Conducted Emission	15.207	N/A*
Conducted Peak Output Power	15.247 (b)(1)	Pass
20dB Occupied Bandwidth	15.247 (a)(1)	Pass
Carrier Frequencies Separation	15.247 (a)(1)	Pass
Hopping Channel Number	15.247 (a)(1)	Pass
Dwell Time	15.247 (a)(1)	Pass
Pseudorandom Frequency Hopping Sequence	15.247(b)(4)	Pass
Radiated Emission	15.205/15.209	Pass
Band Edge	15.247(d)	Pass

*Pass: The EUT complies with the essential requirements in the standard.*

*N/A\*: Not applicable for it won't connect to the public utility power line.*

*Remark : Test according to ANSI C63.10:2013.*

### 4.1 Measurement Uncertainty

Test Item	Frequency Range	Measurement Uncertainty	Notes
Radiated Emission	9kHz ~ 30MHz	± 4.34dB	(1)
Radiated Emission	30MHz ~ 1000MHz	± 4.24dB	(1)
Radiated Emission	1GHz ~ 26.5GHz	± 4.68dB	(1)
AC Power Line Conducted Emission	0.15MHz ~ 30MHz	± 3.45dB	(1)

Note (1): The measurement uncertainty is for coverage factor of k=2 and a level of confidence of 95%.

## 5 General Information

### 5.1 General Description of EUT

Product Name:	2.4GHz 4CHANNELS RECEIVER
Model No.:	FGr4S
Test sample(s) ID:	GTS201809000130-1
Sample(s) Status	Engineer sample
Operation Frequency:	2402MHz~2480MHz
Channel numbers:	63
Modulation technology:	CSS, GMSK
Antenna Type:	Integral Antenna
Antenna gain:	2dBi
Power supply:	DC 3.5-8.4V

Remark: The system works in the frequency range of 2402MHz to 2480MHz. This band has been divided to 63 independent channels. Each radio system uses 32 different channels; the minimum channel separation is  $\geq 1.25$ MHz. By using various switch-on times, hopping scheme and channel frequencies, the system can guarantee a jamming free radio transmission. The channel list is below.

Operation Frequency each of channel							
Channel	Frequency (MHz)	Channel	Frequency (MHz)	Channel	Frequency (MHz)	Channel	Frequency (MHz)
1	2402.4063	17	2421.9087	33	2441.4111	49	2462.0709
2	2403.6252	18	2423.1276	34	2442.63	50	2463.2898
3	2404.8441	19	2424.3465	35	2445.0063	51	2464.5087
4	2406.063	20	2425.5654	36	2446.2252	52	2465.7276
5	2407.2819	21	2426.7843	37	2447.4441	53	2466.9465
6	2408.5008	22	2428.0032	38	2448.663	54	2468.1654
7	2409.7197	23	2429.2221	39	2449.8819	55	2469.3843
8	2410.9386	24	2430.441	40	2451.1008	56	2470.6032
9	2412.1575	25	2431.6599	41	2452.3197	57	2471.8221
10	2413.3764	26	2432.8788	42	2453.5386	58	2473.041
11	2414.5953	27	2434.0977	43	2454.7575	59	2474.2599
12	2415.8142	28	2435.3166	44	2455.9764	60	2475.4788
13	2417.0331	29	2436.5355	45	2457.1953	61	2476.6977
14	2418.252	30	2437.7544	46	2458.4142	62	2477.9166
15	2419.4709	31	2438.9733	47	2459.6331	63	2479.1355
16	2420.6898	32	2440.1922	48	2460.852	64	

In section 15.31(m), regards to the operating frequency range over 10 MHz, the Lowest frequency, the middle frequency, and the highest frequency of channel were selected to perform the test, and the selected channel see below:

Channel	Frequency
The lowest channel	2402.0/2403.6252MHz
The middle channel	2440.0/2441.4111MHz
The Highest channel	2480.0/2479.1355MHz

## 5.2 Test mode

Transmitting mode	Keep the EUT in transmitting mode.
-------------------	------------------------------------

## 5.3 Test Facility

<p>The test facility is recognized, certified, or accredited by the following organizations:</p> <ul style="list-style-type: none"> <li>• <b>FCC —Registration No.: 381383</b> Global United Technology Services Co., Ltd., Shenzhen EMC Laboratory has been registered and fully described in a report filed with the (FCC) Federal Communications Commission. The acceptance letter from the FCC is maintained in files. Registration No.: 381383, January 08, 2018.</li> <li>• <b>Industry Canada (IC) —Registration No.: 9079A-2</b> The 3m Semi-anechoic chamber of Global United Technology Services Co., Ltd. has been registered by Certification and Engineering Bureau of Industry Canada for radio equipment testing with Registration No.: 9079A-2, August 15, 2016.</li> </ul>
---

## 5.4 Test Location

All other tests were performed at:
<p>Global United Technology Services Co., Ltd. Address: No. 301-309, 3/F., Jinyuan Business Building, No.2, Laodong Industrial Zone, Xixiang Road, Baoan District, Shenzhen, Guangdong, China 518102 Tel: 0755-27798480 Fax: 0755-27798960</p>

## 5.5 Other Information Requested by the Customer

None.
-------

## 5.6 Description of Support Units

Manufacturer	Description	Model	Serial Number	FCC Approval
MEILI	DC POWER SUPPLY	MCH-305A	011121168	DOC

## 5.7 Additional Instructions

EUT Software Settings:

Mode	Special test firmware was pre-built-in by manufacturer		
GFSK	Channel	Frequency (MHz)	Level Set
	Lowest	2402.0/2403.6252MHz	TX level : default
	Middle	2440.0/2441.4111MHz	
	Highest	2480.0/2479.1355MHz	

## 6 Test Instruments list

Radiated Emission:						
Item	Test Equipment	Manufacturer	Model No.	Inventory No.	Cal.Date (mm-dd-yy)	Cal.Due date (mm-dd-yy)
1	3m Semi- Anechoic Chamber	ZhongYu Electron	9.2(L)*6.2(W)* 6.4(H)	GTS250	July. 03 2015	July. 02 2020
2	Control Room	ZhongYu Electron	6.2(L)*2.5(W)* 2.4(H)	GTS251	N/A	N/A
3	EMI Test Receiver	Rohde & Schwarz	ESU26	GTS203	June. 27 2018	June. 26 2019
4	BiConiLog Antenna	SCHWARZBECK MESS-ELEKTRONIK	VULB9163	GTS214	June. 27 2018	June. 26 2019
5	Double -ridged waveguide horn	SCHWARZBECK MESS-ELEKTRONIK	BBHA 9120 D	GTS208	June. 27 2018	June. 26 2019
6	Horn Antenna	ETS-LINDGREN	3160	GTS217	June. 27 2018	June. 26 2019
7	EMI Test Software	AUDIX	E3	N/A	N/A	N/A
8	Coaxial Cable	GTS	N/A	GTS213	June. 27 2018	June. 26 2019
9	Coaxial Cable	GTS	N/A	GTS211	June. 27 2018	June. 26 2019
10	Coaxial cable	GTS	N/A	GTS210	June. 27 2018	June. 26 2019
11	Coaxial Cable	GTS	N/A	GTS212	June. 27 2018	June. 26 2019
12	Amplifier(100kHz-3GHz)	HP	8347A	GTS204	June. 27 2018	June. 26 2019
13	Amplifier(2GHz-20GHz)	HP	84722A	GTS206	June. 27 2018	June. 26 2019
14	Amplifier (18-26GHz)	Rohde & Schwarz	AFS33-18002 650-30-8P-44	GTS218	June. 27 2018	June. 26 2019
15	Band filter	Amindeon	82346	GTS219	June. 27 2018	June. 26 2019
16	Power Meter	Anritsu	ML2495A	GTS540	June. 27 2018	June. 26 2019
17	Power Sensor	Anritsu	MA2411B	GTS541	June. 27 2018	June. 26 2019
18	Wideband Radio Communication Tester	Rohde & Schwarz	CMW500	GTS575	June. 27 2018	June. 26 2019
19	Splitter	Agilent	11636B	GTS237	June. 27 2018	June. 26 2019
20	Loop Antenna	ZHINAN	ZN30900A	GTS534	June. 27 2018	June. 26 2019

General used equipment:						
Item	Test Equipment	Manufacturer	Model No.	Inventory No.	Cal.Date (mm-dd-yy)	Cal.Due date (mm-dd-yy)
1	Humidity/ Temperature Indicator	KTJ	TA328	GTS243	June. 27 2018	June. 26 2019
2	Barometer	ChangChun	DYM3	GTS255	June. 27 2018	June. 26 2019



<b>RF Conducted Test:</b>						
<b>Item</b>	<b>Test Equipment</b>	<b>Manufacturer</b>	<b>Model No.</b>	<b>Serial No.</b>	<b>Cal.Date (mm-dd-yy)</b>	<b>Cal.Due date (mm-dd-yy)</b>
1	MXA Signal Analyzer	Agilent	N9020A	GTS566	June. 27 2018	June. 26 2019
2	EMI Test Receiver	R&S	ESCI 7	GTS552	June. 27 2018	June. 26 2019
3	Spectrum Analyzer	Agilent	E4440A	GTS533	June. 27 2018	June. 26 2019
4	MXG vector Signal Generator	Agilent	N5182A	GTS567	June. 27 2018	June. 26 2019
5	ESG Analog Signal Generator	Agilent	E4428C	GTS568	June. 27 2018	June. 26 2019
6	USB RF Power Sensor	DARE	RPR3006W	GTS569	June. 27 2018	June. 26 2019
7	RF Switch Box	Shongyi	RFSW3003328	GTS571	June. 27 2018	June. 26 2019
8	EMI Test Receiver	R&S	ESCI 7	GTS552	June. 27 2018	June. 26 2019
9	Programmable Constant Temp & Humi Test Chamber	WEWON	WHTH-150L-40-880	GTS572	June. 27 2018	June. 26 2019

## 7 Test results and Measurement Data

### 7.1 Antenna requirement

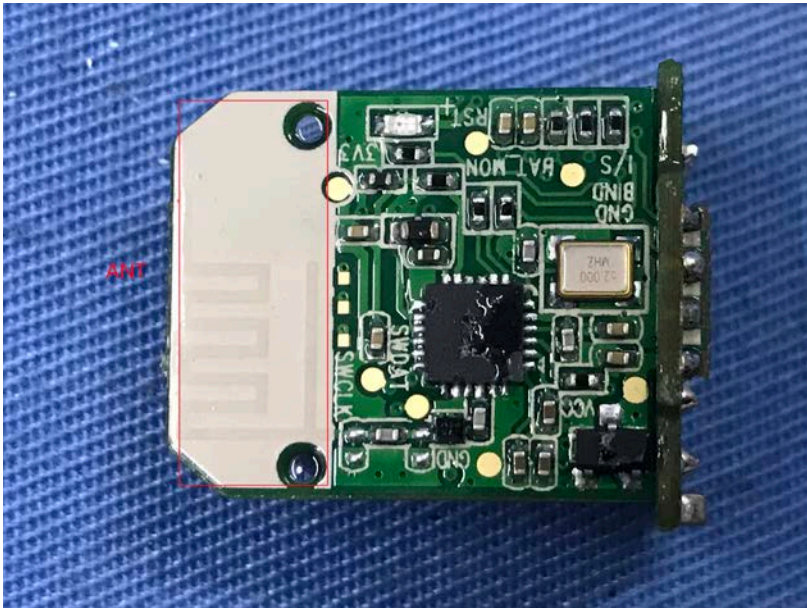
<b>Standard requirement:</b>	FCC Part15 C Section 15.203 /247(c)
<p><b>15.203 requirement:</b></p> <p>An intentional radiator shall be designed to ensure that no antenna other than that furnished by the responsible party shall be used with the device. The use of a permanently attached antenna or of an antenna that uses a unique coupling to the intentional radiator, the manufacturer may design the unit so that a broken antenna can be replaced by the user, but the use of a standard antenna jack or electrical connector is prohibited.</p> <p><b>15.247(c) (1)(i) requirement:</b></p> <p>(i) Systems operating in the 2400-2483.5 MHz band that is used exclusively for fixed. Point-to-point operations may employ transmitting antennas with directional gain greater than 6dBi provided the maximum conducted output power of the intentional radiator is reduced by 1 dB for every 3 dB that the directional gain of the antenna exceeds 6dBi.</p>	
<b>EUT Antenna:</b>	
<p><i>The antenna is integral Antenna, the best case gain of the antenna is 2dBi</i></p> 	

## 7.2 Conducted Peak Output Power

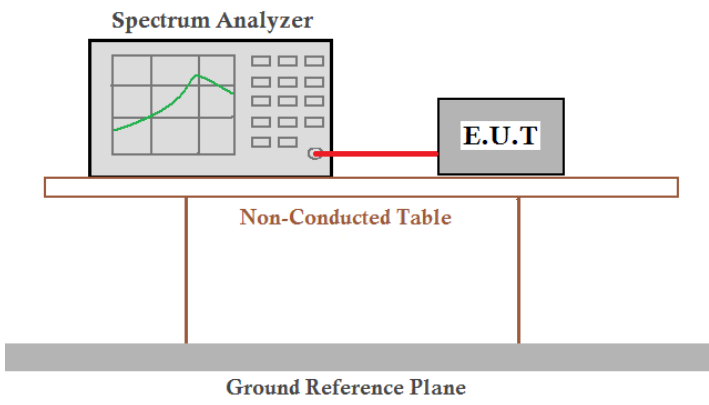
Test Requirement:	FCC Part15 C Section 15.247 (b)(3)
Test Method:	ANSI C63.10:2013
Limit:	20.97dBm
Test setup:	 <p>The diagram illustrates the test setup. A Spectrum Analyzer is connected to an E.U.T. (Equipment Under Test) via a red cable. Both are placed on a Non-Conducted Table, which is supported by a Ground Reference Plane.</p>
Test Instruments:	Refer to section 6.0 for details
Test mode:	Refer to section 5.2 for details
Test results:	Pass

### Measurement Data

Test channel	Peak Output Power (dBm)	Limit (dBm)	Result
Lowest	10.17	20.97	Pass
Middle	10.40		
Highest	10.55		

Test plot as follows:

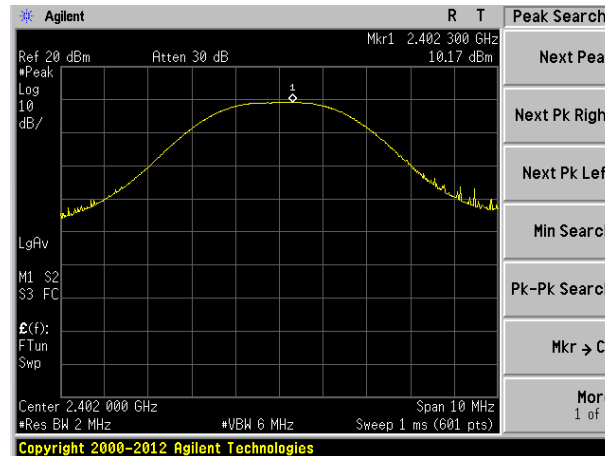

Lowest channel

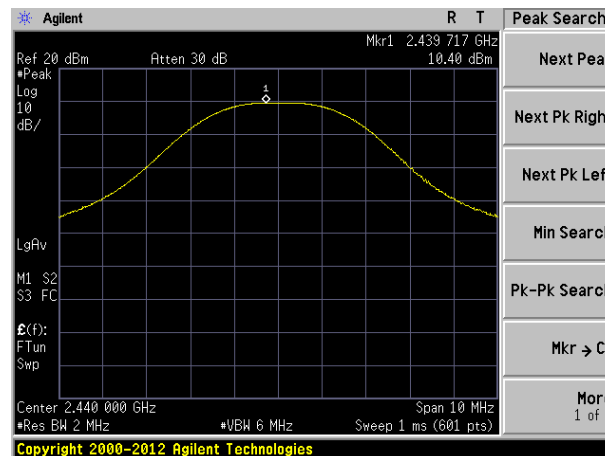

Middle channel

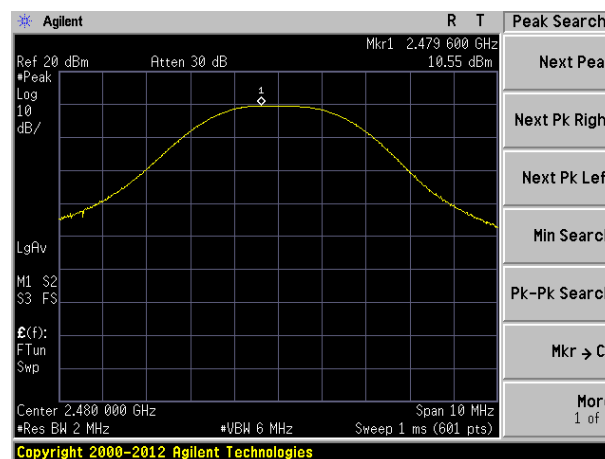

Highest channel

### 7.3 20dB Emission Bandwidth

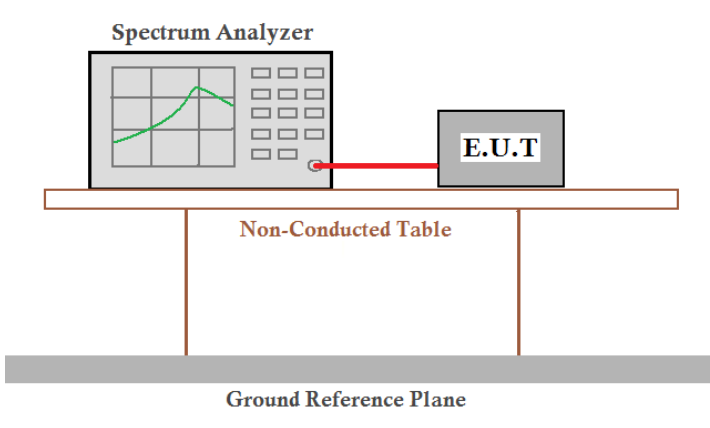
Test Requirement:	FCC Part15 C Section 15.247 (a)(2)
Test Method:	ANSI C63.10:2013
Limit:	N/A
Test setup:	 <p>The diagram illustrates the test setup. A Spectrum Analyzer is connected to an E.U.T. (Equipment Under Test) via a red cable. Both are placed on a Non-Conducted Table, which is supported by a Ground Reference Plane.</p>
Test Instruments:	Refer to section 6.0 for details
Test mode:	Refer to section 5.2 for details
Test results:	Pass

### Measurement Data

Test channel	20dB Emission Bandwidth (MHz)	Result
Lowest	1.280	Pass
Middle	1.296	
Highest	1.341	

Test plot as follows:



Lowest channel

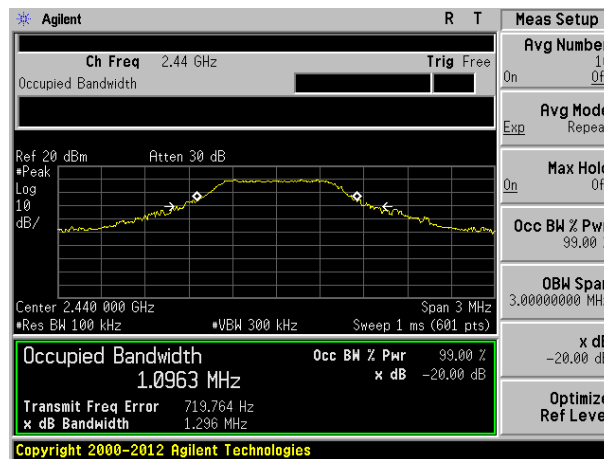

Middle channel

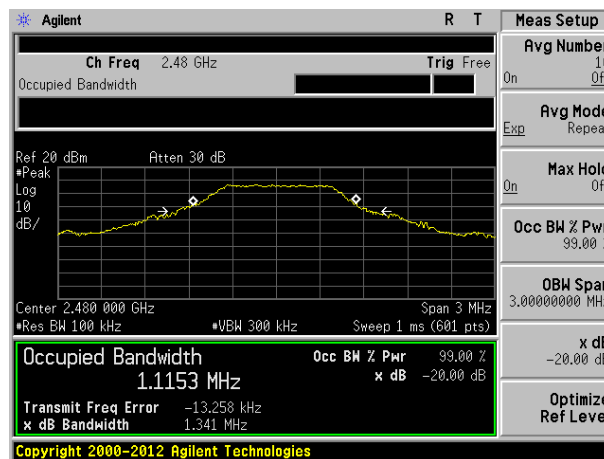

Highest channel

## 7.4 Carrier Frequencies Separation

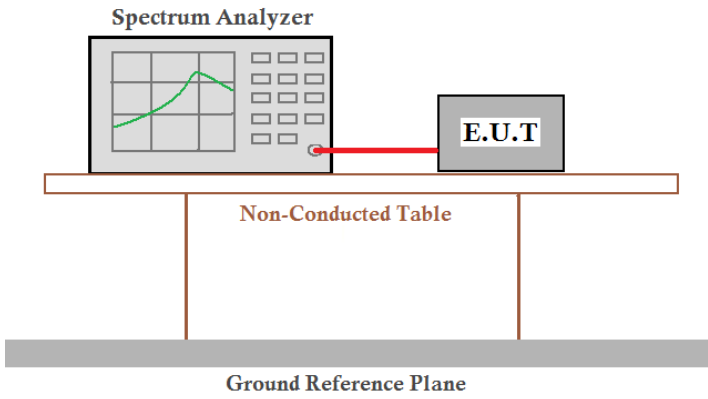
Test Requirement:	FCC Part15 C Section 15.247 (a)(1)
Test Method:	ANSI C63.10:2013
Receiver setup:	RBW=100KHz, VBW=300KHz, detector=Peak
Limit:	0.025MHz or 2/3 of the 20dB bandwidth (whichever is greater)
Test setup:	 <p>The diagram illustrates the test setup. A Spectrum Analyzer is connected to an E.U.T. (Equipment Under Test) via a red cable. Both are placed on a Non-Conducted Table, which is supported by two vertical legs. Below the table is a Ground Reference Plane.</p>
Test Instruments:	Refer to section 6.0 for details
Test mode:	Refer to section 5.2 for details
Test results:	Pass

### Measurement Data

Test channel	Carrier Frequencies Separation (kHz)	Limit (kHz)	Result
Lowest	1320	894	Pass
Middle	1220	894	Pass
Highest	1280	894	Pass

Note: According to section 7.4

Mode	20dB bandwidth (kHz) (worse case)	Limit (kHz) (Carrier Frequencies Separation)
GFSK	1341	894

Test plot as follows:

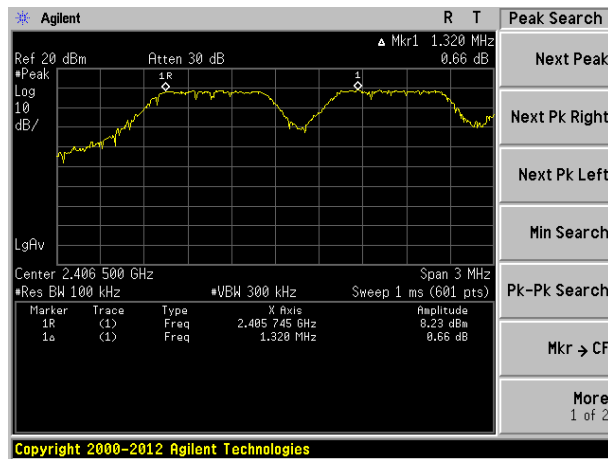

Lowest channel

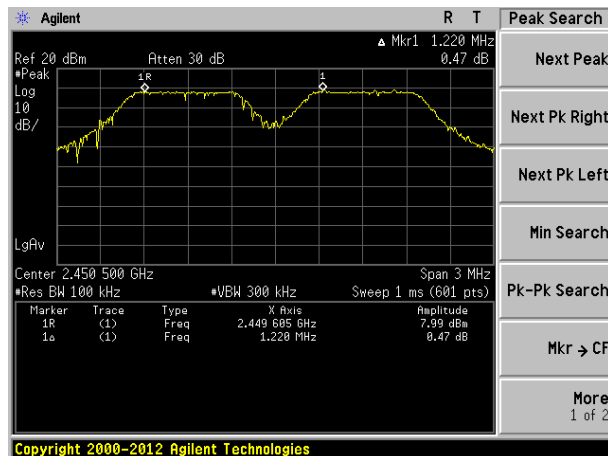

Middle channel

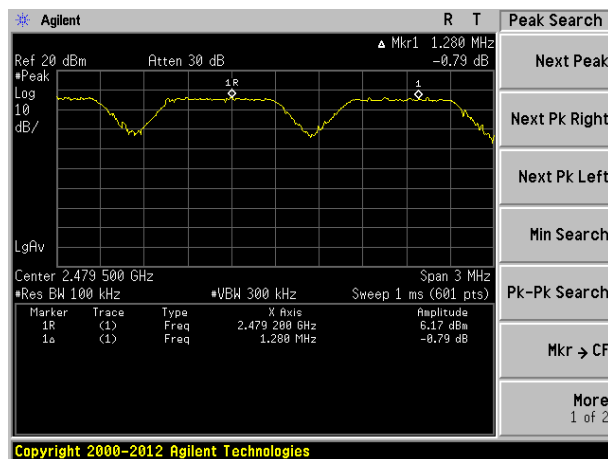

Highest channel

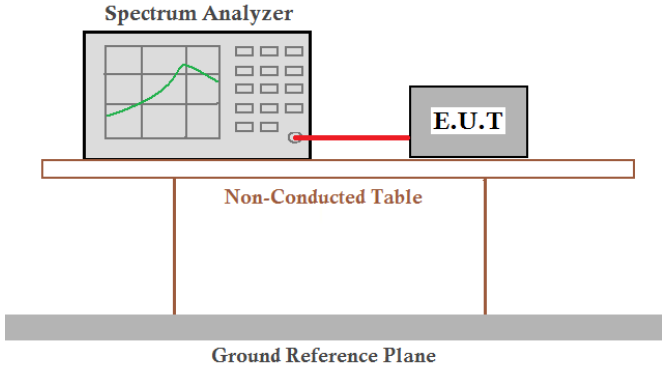

## 7.5 Hopping Channel Number

Test Requirement:	FCC Part15 C Section 15.247 (a)(1)
Test Method:	ANSI C63.10:2013
Receiver setup:	RBW=100kHz, VBW=300kHz, Frequency range=2400MHz-2483.5MHz, Detector=Peak
Limit:	15 channels
Test setup:	 <p>The diagram illustrates the test setup. A Spectrum Analyzer is connected via a red cable to an E.U.T. (Equipment Under Test). Both are placed on a Non-Conducted Table. Below the table is a Ground Reference Plane.</p>
Test Instruments:	Refer to section 6.0 for details
Test mode:	Refer to section 5.2 for details
Test results:	Pass

### Measurement Data:

Hopping channel numbers	Limit	Result
32	15	Pass

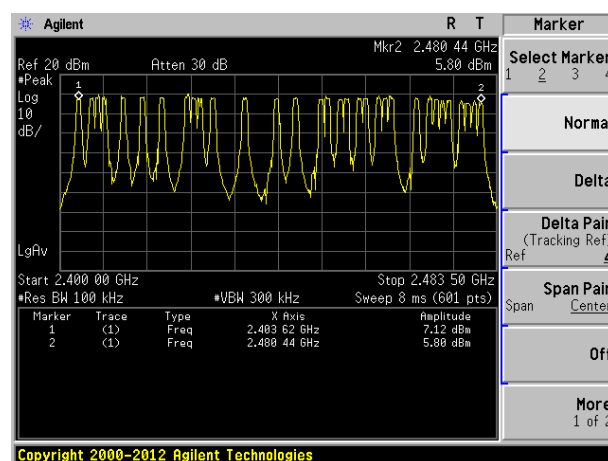

## 7.6 Dwell Time

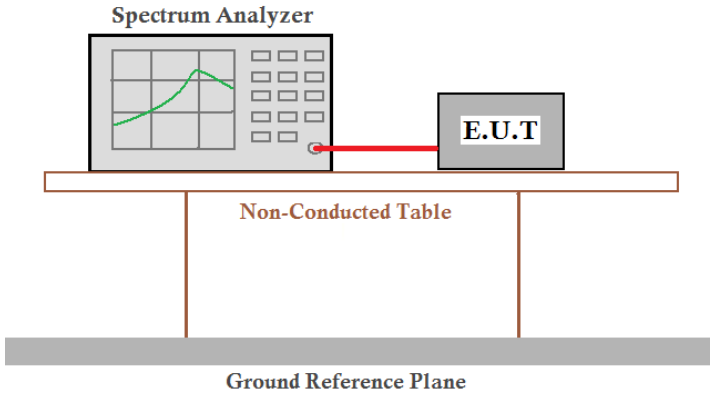
Test Requirement:	FCC Part15 C Section 15.247 (a)(1)
Test Method:	ANSI C63.10:2013
Receiver setup:	RBW=1MHz, VBW=1MHz, Span=0Hz, Detector=Peak
Limit:	0.4 Second
Test setup:	 <p>The diagram illustrates the test setup. A Spectrum Analyzer is connected via a red cable to an E.U.T. (Equipment Under Test). Both are placed on a Non-Conducted Table. Below the table is a Ground Reference Plane.</p>
Test Instruments:	Refer to section 6.0 for details
Test mode:	Refer to section 5.2 for details
Test results:	Pass

### Measurement Data

Channel	Ton (ms)	Dwell time(ms)	Limit(ms)	Result
Lowest	2.567	65.7152	400	Pass
Middle	2.550	65.2800	400	Pass
highest	2.567	131.4304	400	Pass

The formula as below:

Lowest: Dwell time = Ton \* Ton times in 1s \* 0.4s \* channel numbers=2.567ms\*2\*0.4\*32=65.7152ms

Middle: Dwell time = Ton \* Ton times in 1s \* 0.4s \* channel numbers=2.550ms\*2\*0.4\*32=65.2800ms

Highest: Dwell time = Ton \* Ton times in 1s \* 0.4s \* channel numbers=2.567ms\*4\*0.4\*32=131.4304ms

Test plot as follows:

Lowest

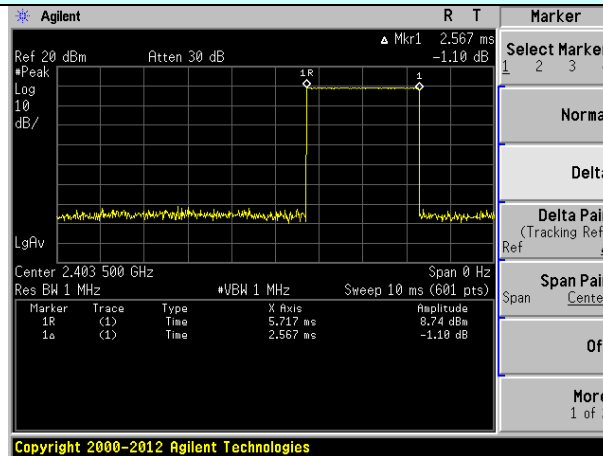

Ton

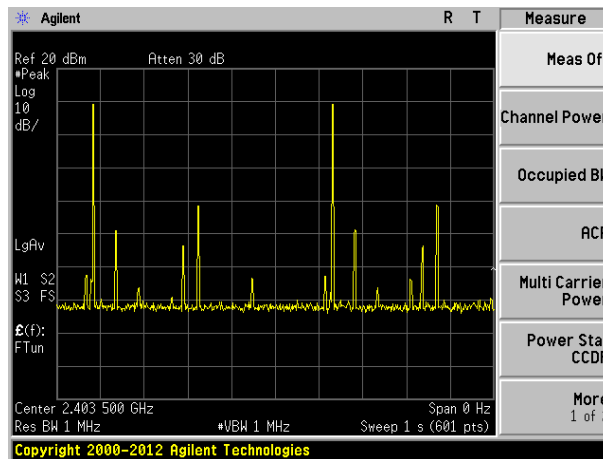

Ton times in 1s

Middle

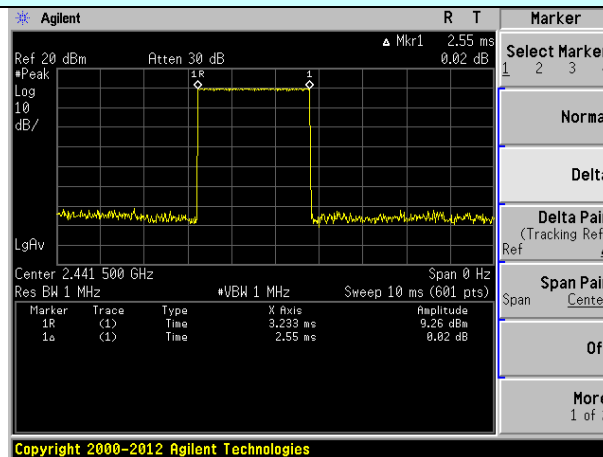

Ton

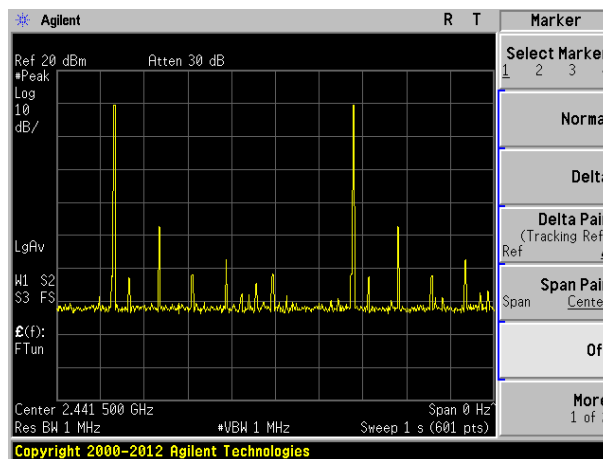

Ton times in 1s

Highest

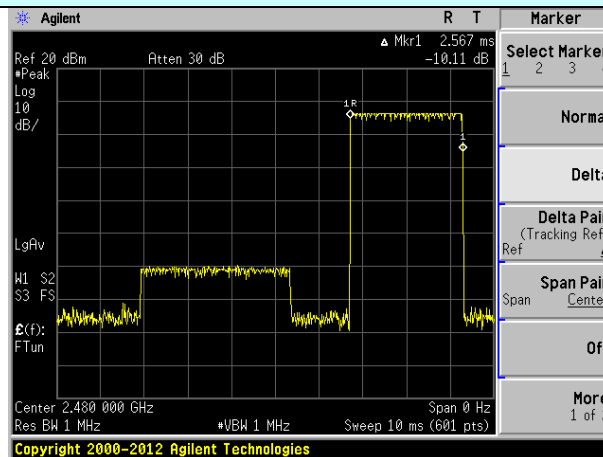

Ton

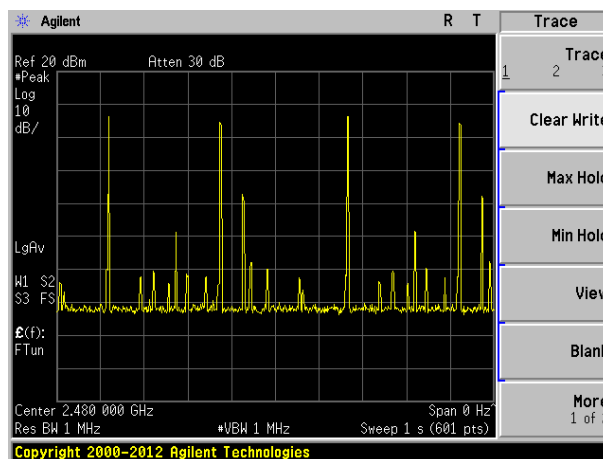

Ton times in 1s

## 7.7 Pseudorandom Frequency Hopping Sequence

Test Requirement:	FCC Part15 C Section 15.247 (a)(1) requirement:
	<p><i>a(1): Frequency hopping systems shall have hopping channel carrier frequencies separated by a minimum of 25 kHz or the 20 dB bandwidth of the hopping channel, whichever is greater.</i></p> <p><i>Alternatively. Frequency hopping systems operating in the 2400-2483.5 MHz band may have hopping channel carrier frequencies that are separated by 25 kHz or two-thirds of the 20 dB bandwidth of the hopping channel, whichever is greater, provided the systems operate with an output power no greater than 125 mW. The system shall hop to channel frequencies that are selected at the system hopping rate from a Pseudorandom ordered list of hopping frequencies. Each frequency must be used equally on the average by each transmitter. The system receivers shall have input bandwidths that match the hopping channel bandwidths of their corresponding transmitters and shall shift frequencies in synchronization with the transmitted signals.</i></p> <p><i>(g) Frequency hopping spread spectrum systems are not required to employ all available hopping channels during each transmission. However, the system, consisting of both the transmitter and the receiver, must be designed to comply with all of the regulations in this section should the transmitter be presented with a continuous data (or information) stream. In addition, a system employing short transmission bursts must comply with the definition of a frequency hopping system and must distribute its transmissions over the minimum number of hopping channels specified in this section.</i></p> <p><i>(h) The incorporation of intelligence within a frequency hopping spread spectrum system that permits the system to recognize other users within the spectrum band so that it individually and independently chooses and adapts its hopsets to avoid hopping on occupied channels is permitted. The coordination of frequency hopping systems in any other manner for the express purpose of avoiding the simultaneous occupancy of individual hopping frequencies by multiple transmitters is not permitted.</i></p>
	<p><b>EUT Pseudorandom Frequency Hopping Sequence</b></p>
	<p><i>Each frequency used equally on the average by each transmitter.</i></p> <p><i>The system receivers have input bandwidths that match the hopping channel bandwidths of their corresponding transmitters and shift frequencies in synchronization with the transmitted signals.</i></p> <p><i>it permits the system to recognize other users within the spectrum band so that it individually and independently chooses and adapts its hopsets to avoid hopping on occupied channels is permitted.</i></p>

## 7.8 Band Edge

### 7.8.1 Conducted Emission Method

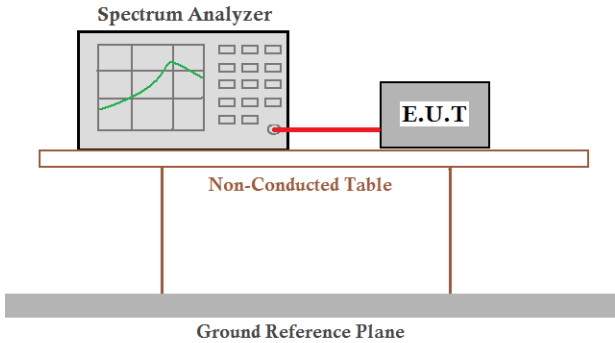
Test Requirement:	FCC Part15 C Section 15.247 (d)
Test Method:	ANSI C63.10:2013
Receiver setup:	RBW=100kHz, VBW=300kHz, Detector=Peak
Limit:	In any 100 kHz bandwidth outside the frequency band in which the spread spectrum intentional radiator is operating, the radio frequency power that is produced by the intentional radiator shall be at least 20 dB below that in the 100 kHz bandwidth within the band that contains the highest level of the desired power, based on either an RF conducted or a radiated measurement.
Test setup:	 <p>The diagram illustrates the test setup. A Spectrum Analyzer is connected to an E.U.T. (Equipment Under Test) via a red cable. Both are placed on a Non-Conducted Table, which is supported by a Ground Reference Plane.</p>
Test Instruments:	Refer to section6.0 for details
Test mode:	Refer to section 5.2 for details
Test results:	Pass

Test plot as follows:

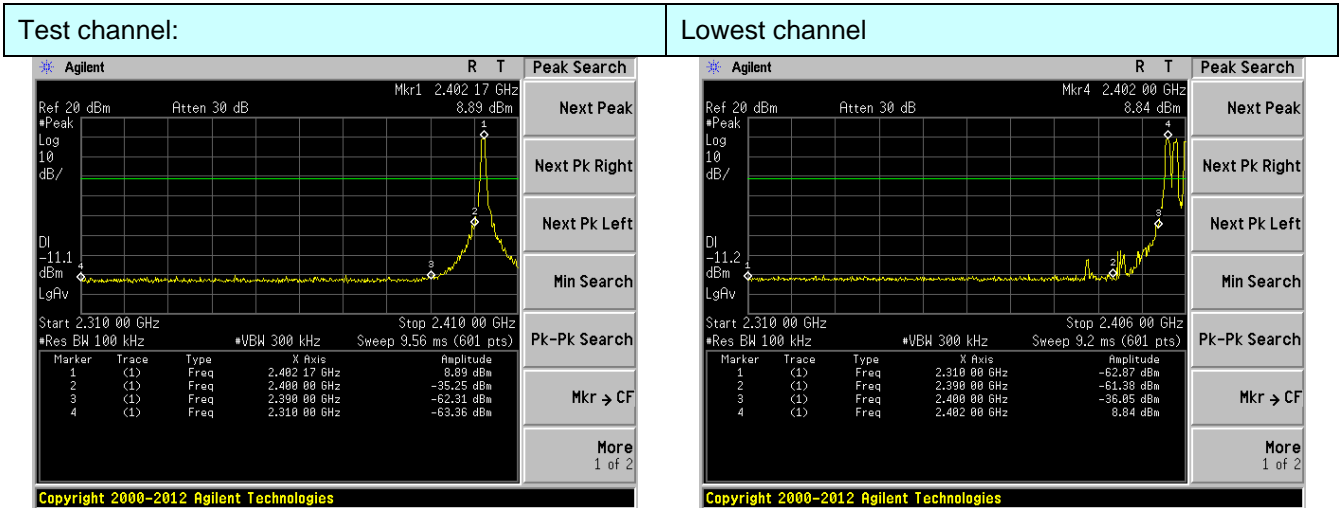

No-hopping mode

Hopping mode

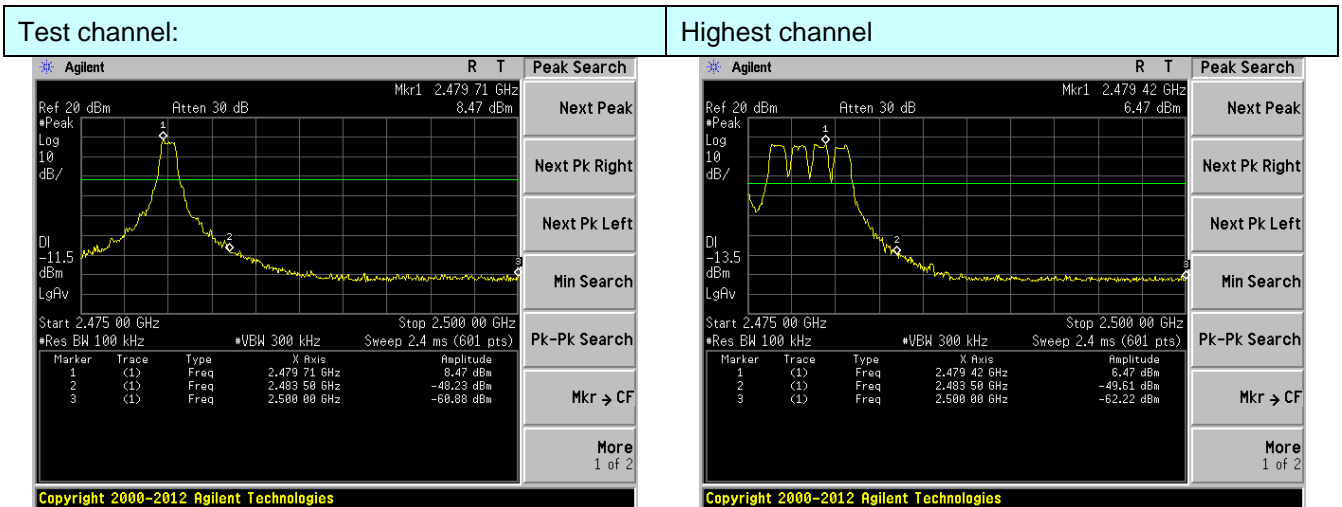

No-hopping mode

Hopping mode



## 7.8.2 Radiated Emission Method

Test Requirement:	FCC Part15 C Section 15.209 and 15.205					
Test Method:	ANSI C63.10:2013					
Test Frequency Range:	All restriction band have been tested, and 2.3GHz to 2.5GHz band is the worse case					
Test site:	Measurement Distance: 3m					
Receiver setup:	Frequency	Detector	RBW	VBW	Remark	
	Above 1GHz	Peak	1MHz	3MHz	Peak Value	
		Peak	1MHz	10Hz	Average Value	
Limit:	Frequency		Limit (dBuV/m @3m)		Remark	
	Above 1GHz		54.00		Average Value	
			74.00		Peak Value	
Test setup:						
Test Procedure:	<ol style="list-style-type: none"> <li>1. The EUT was placed on the top of a rotating table 1.5 meters above the ground at a 3 meter camber. The table was rotated 360 degrees to determine the position of the highest radiation.</li> <li>2. The EUT was set 3 meters away from the interference-receiving antenna, which was mounted on the top of a variable-height antenna tower.</li> <li>3. The antenna height is varied from one meter to four meters above the ground to determine the maximum value of the field strength. Both horizontal and vertical polarizations of the antenna are set to make the measurement.</li> <li>4. For each suspected emission, the EUT was arranged to its worst case and then the antenna was tuned to heights from 1 meter to 4 meters and the rota table was turned from 0 degrees to 360 degrees to find the maximum reading.</li> <li>5. The test-receiver system was set to Peak Detect Function and Specified Bandwidth with Maximum Hold Mode.</li> <li>6. If the emission level of the EUT in peak mode was 10dB lower than the limit specified, then testing could be stopped and the peak values of the EUT would be reported. Otherwise the emissions that did not have 10dB margin would be re-tested one by one using peak, quasi-peak or average method as specified and then reported in a data sheet.</li> </ol>					
Test Instruments:	Refer to section 6.0 for details					
Test mode:	Refer to section 5.2 for details					
Temp. / Hum.	Temp.:	25 °C	Humid.:	52%	Press.:	1 012mbar
Test results:	Pass					

Remark:

1. Pre-scan all kind of the place mode (X-axis, Y-axis, Z-axis), and found the Y-axis which it is worse case.

Test channel:	Lowest	Polarization:	Vertical
---------------	--------	---------------	----------

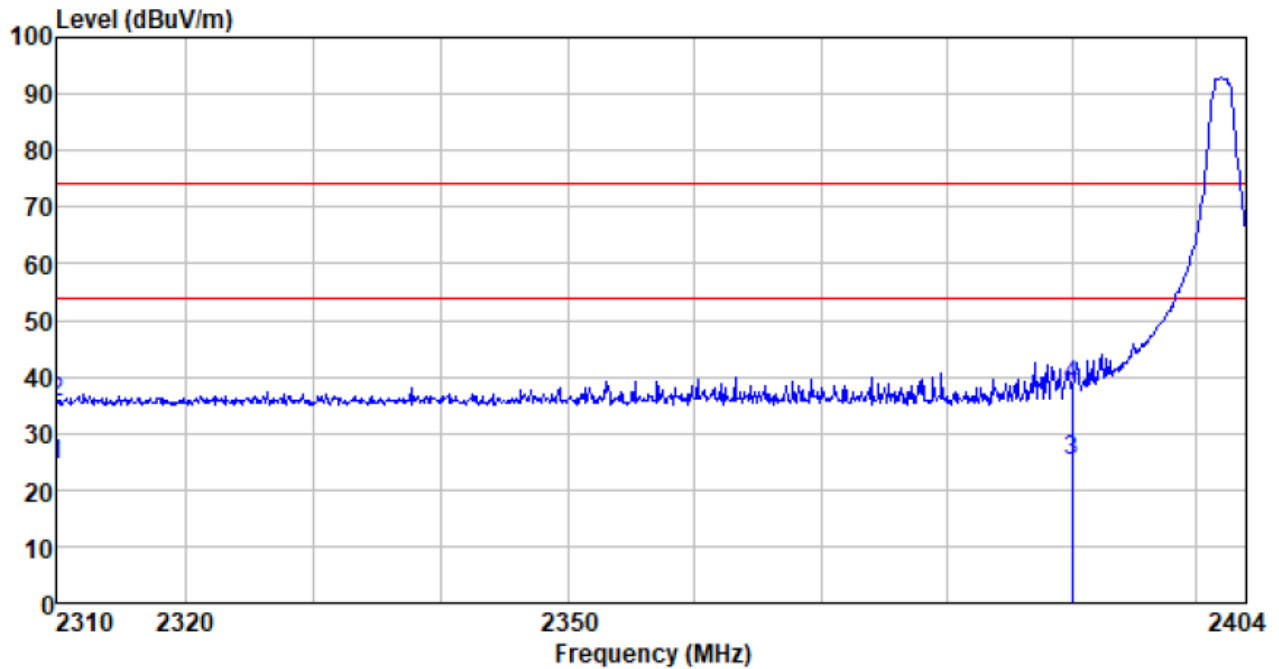

Freq MHz	Reading level dBuV	Antenna factor dB/m	Cable loss dB	Preamp factor dB	level dBuV	Limit level dBuV/m	Over limit dB	Remark
2310.000	28.05	27.21	6.19	36.95	24.50	54.00	-29.50	Average
2310.000	39.11	27.21	6.19	36.95	35.56	74.00	-38.44	Peak
2390.000	28.41	27.41	6.31	37.01	25.12	54.00	-28.88	Average
2390.000	41.51	27.41	6.31	37.01	38.22	74.00	-35.78	Peak

Test channel:	Lowest	Polarization:	Horizontal
---------------	--------	---------------	------------

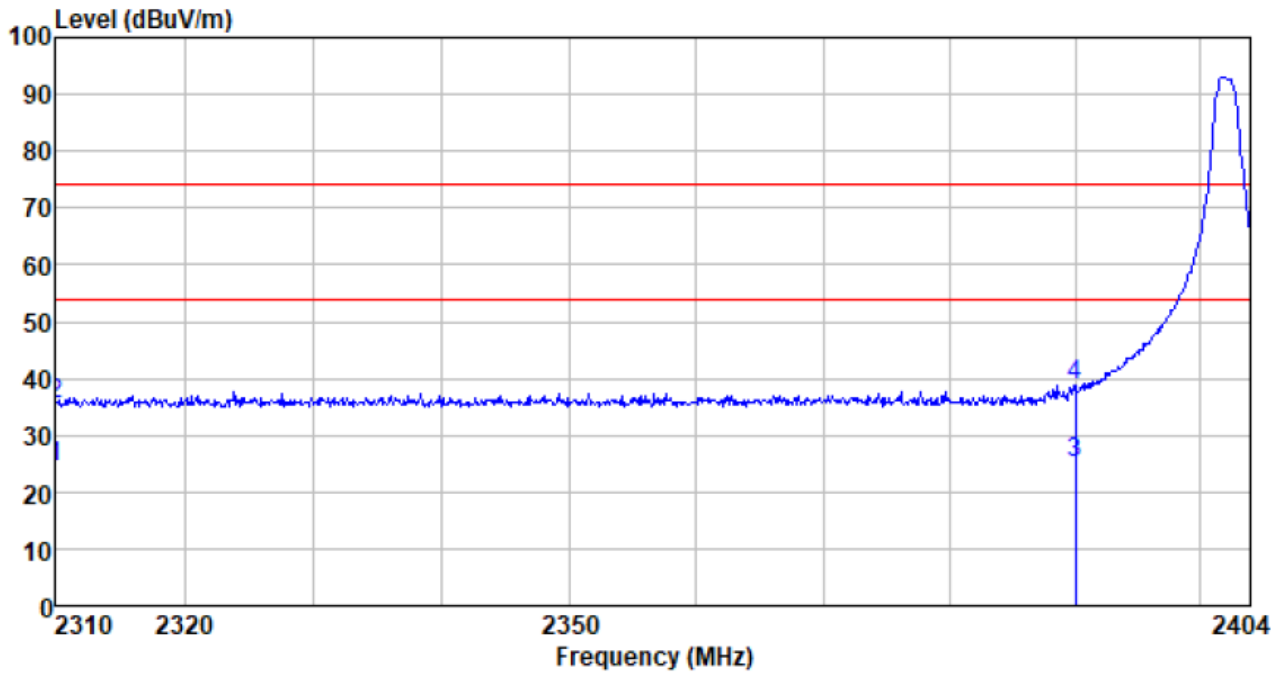

Freq MHz	Reading level dBuV	Antenna factor dB/m	Cable loss dB	Preamp factor dB	level dBuV	Limit level dBuV/m	Over limit dB	Remark
2310.000	28.00	27.21	6.19	36.95	24.45	54.00	-29.55	Average
2310.000	39.00	27.21	6.19	36.95	35.45	74.00	-38.55	Peak
2390.000	28.35	27.41	6.31	37.01	25.06	54.00	-28.94	Average
2390.000	42.01	27.41	6.31	37.01	38.72	74.00	-35.28	Peak

Test channel:	Highest-2480	Polarization:	Vertical
---------------	--------------	---------------	----------

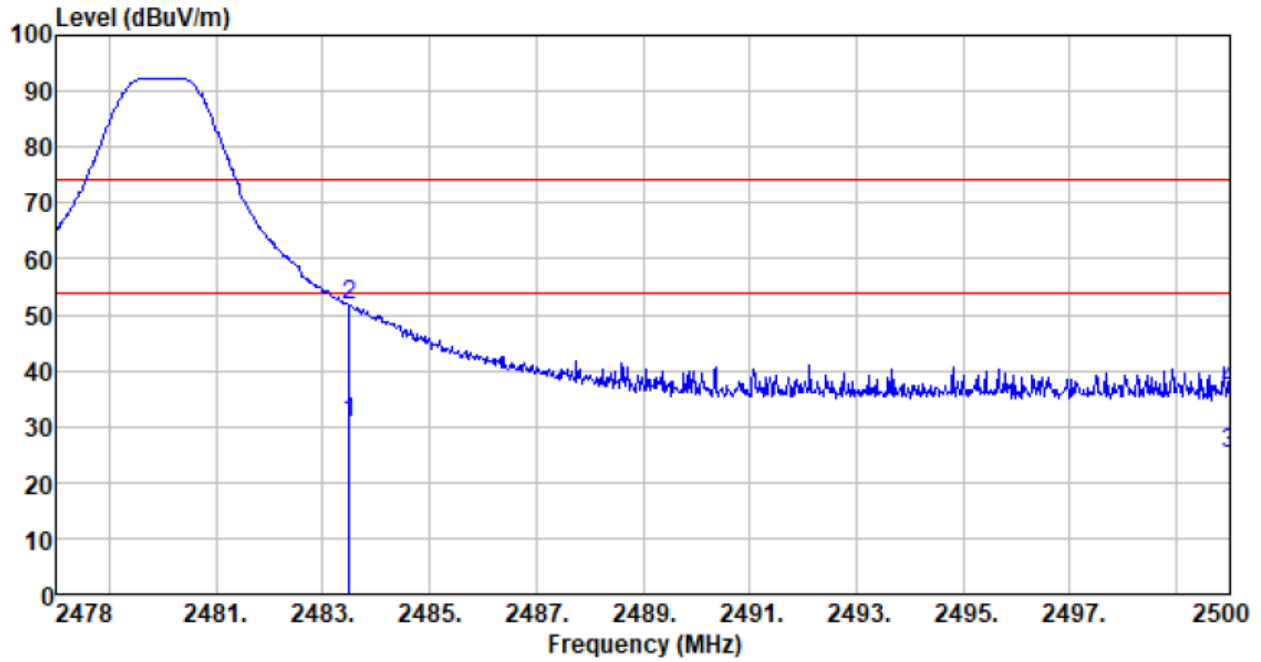

Freq MHz	Reading level dBuV	Antenna factor dB/m	Cable loss dB	Preamp factor dB	level dBuV	Limit level dBuV/m	Over limit dB	Remark
2483.500	33.41	27.66	6.45	37.07	30.45	54.00	-23.55	Average
2483.500	54.63	27.66	6.45	37.07	51.67	74.00	-22.33	Peak
2500.000	28.06	27.70	6.47	37.09	25.14	54.00	-28.86	Average
2500.000	39.56	27.70	6.47	37.09	36.64	74.00	-37.36	Peak

Test channel:	Highest-2480	Polarization:	Horizontal
---------------	--------------	---------------	------------

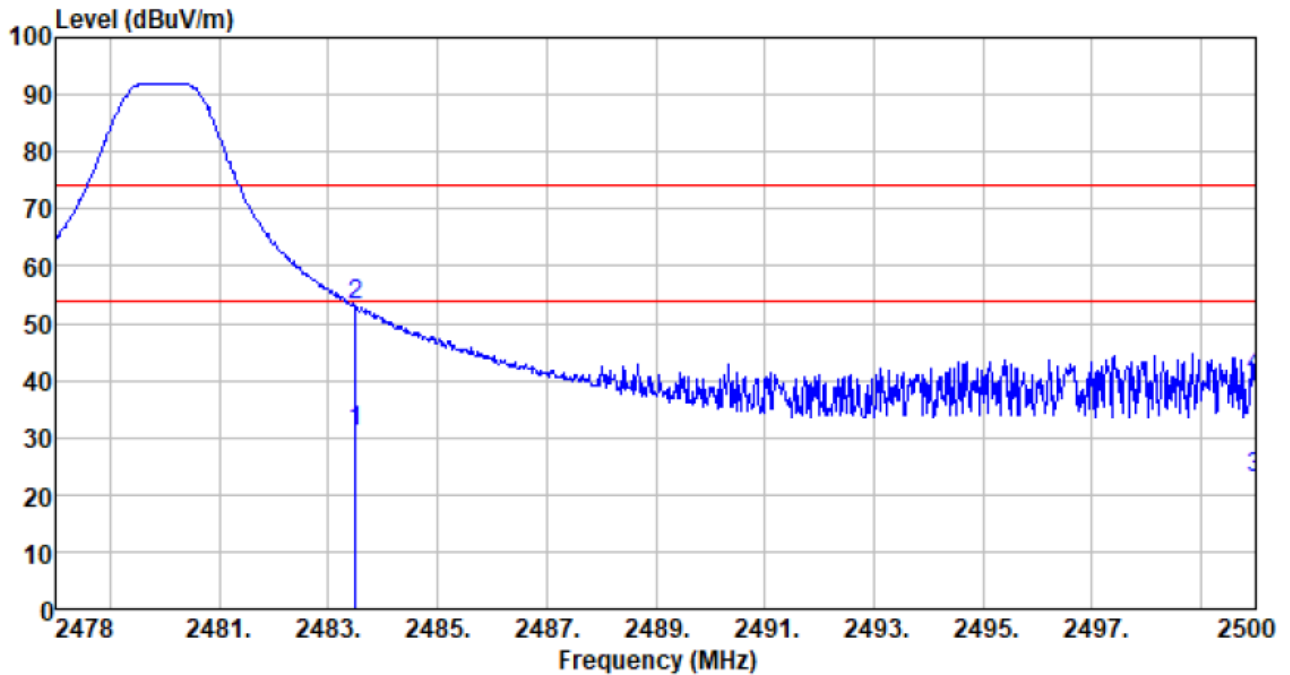

Freq MHz	Reading level dBuV	Antenna factor dB/m	Cable loss dB	Preamp factor dB	level dBuV	Limit level dBuV/m	Over limit dB	Remark
2483.500	34.12	27.66	6.45	37.07	31.16	54.00	-22.84	Average
2483.500	56.10	27.66	6.45	37.07	53.14	74.00	-20.86	Peak
2500.000	25.82	27.70	6.47	37.09	22.90	54.00	-31.10	Average
2500.000	43.49	27.70	6.47	37.09	40.57	74.00	-33.43	Peak

**Remark:**

1. *Final Level = Receiver Read level + Antenna Factor + Cable Loss – Preamplifier Factor*
2. *The emission levels of other frequencies are very lower than the limit and not show in test report.*

## 7.9 Spurious Emission

### 7.9.1 Conducted Emission Method

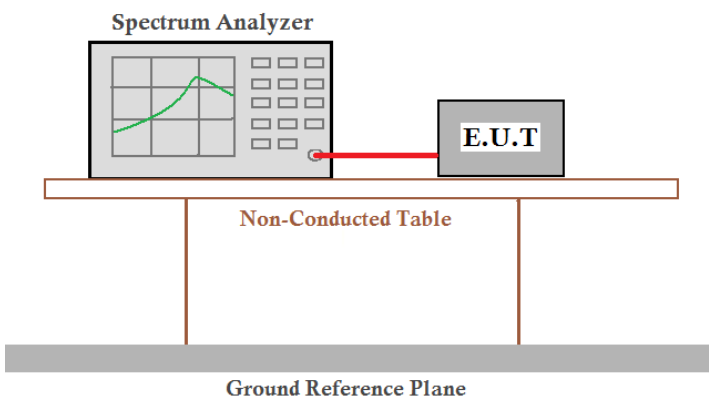
Test Requirement:	FCC Part15 C Section 15.247 (d)
Test Method:	ANSI C63.10:2013 and KDB558074 D01 Meas Guidance V04
Limit:	In any 100 kHz bandwidth outside the frequency band in which the spread spectrum intentional radiator is operating, the radio frequency power that is produced by the intentional radiator shall be at least 20 dB below that in the 100 kHz bandwidth within the band that contains the highest level of the desired power, based on either an RF conducted or a radiated measurement.
Test setup:	 <p>The diagram illustrates the test setup. A Spectrum Analyzer is connected to an E.U.T. (Equipment Under Test) via a red cable. Both are placed on a Non-Conducted Table, which is supported by two legs. Below the table is a Ground Reference Plane.</p>
Test Instruments:	Refer to section 6.0 for details
Test mode:	Refer to section 5.2 for details
Test results:	Pass

Lowest channel

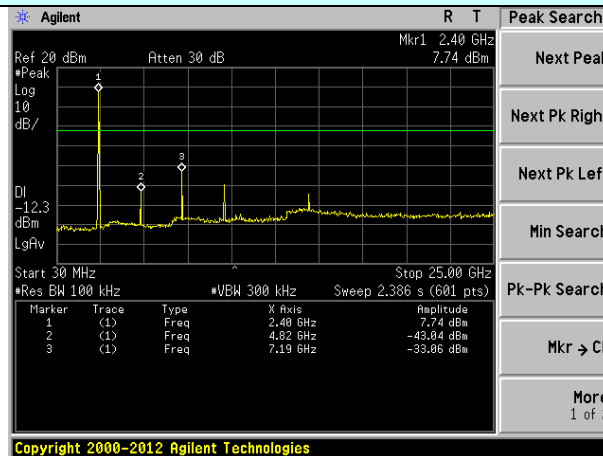

30MHz~25GHz

Middle channel

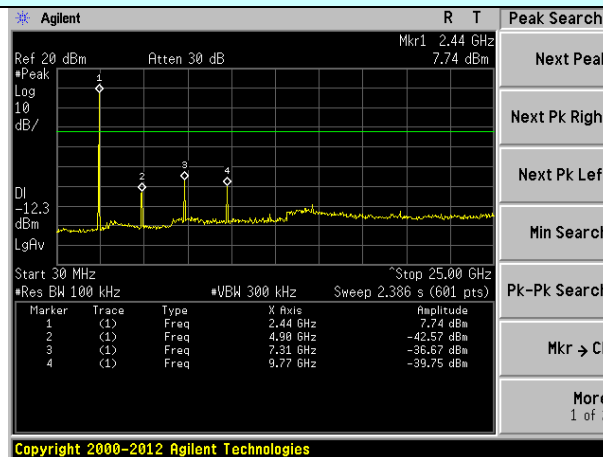

30MHz~25GHz

Highest channel

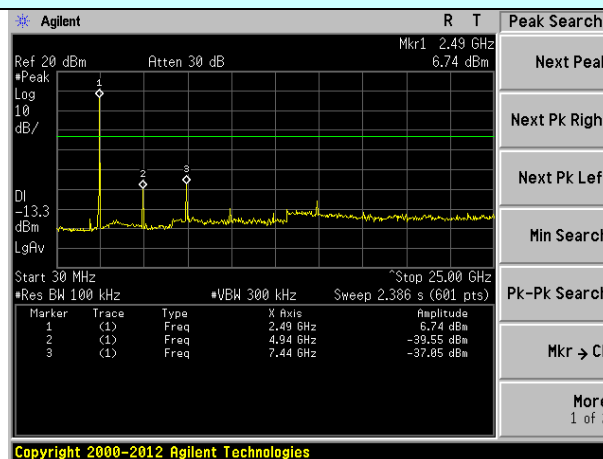

30MHz~25GHz

## 7.9.2 Radiated Emission Method

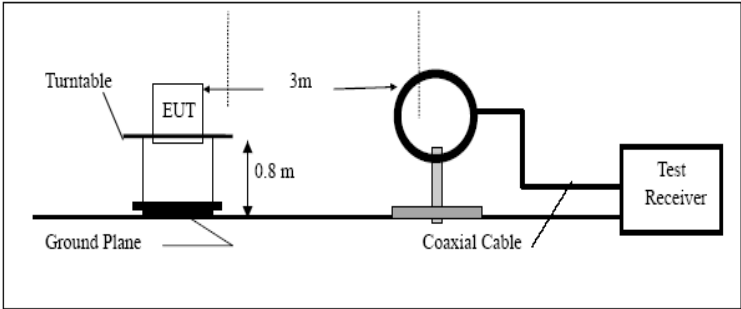
Test Requirement:	FCC Part15 C Section 15.209				
Test Method:	ANSI C63.10:2013				
Test Frequency Range:	9kHz to 25GHz				
Test site:	Measurement Distance: 3m				
Receiver setup:	Frequency	Detector	RBW	VBW	Value
	9KHz-150KHz	Quasi-peak	200Hz	600Hz	Quasi-peak
	150KHz-30MHz	Quasi-peak	9KHz	30KHz	Quasi-peak
	30MHz-1GHz	Quasi-peak	100KHz	300KHz	Quasi-peak
	Above 1GHz	Peak	1MHz	3MHz	Peak
Peak		1MHz	10Hz	Average	
Limit: (Spurious Emissions)	Frequency	Limit (uV/m)	Value	Measurement Distance	
	0.009MHz-0.490MHz	2400/F(KHz)	QP	300m	
	0.490MHz-1.705MHz	24000/F(KHz)	QP	300m	
	1.705MHz-30MHz	30	QP	30m	
	30MHz-88MHz	100	QP	3m	
	88MHz-216MHz	150	QP		
	216MHz-960MHz	200	QP		
	960MHz-1GHz	500	QP		
	Above 1GHz	500	Average		
5000		Peak			
Test setup:	Below 30MHz				
					
Below 1GHz					



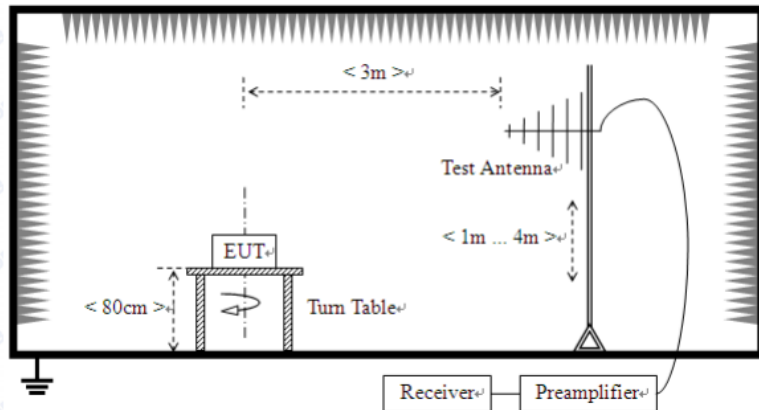

Above 1GHz

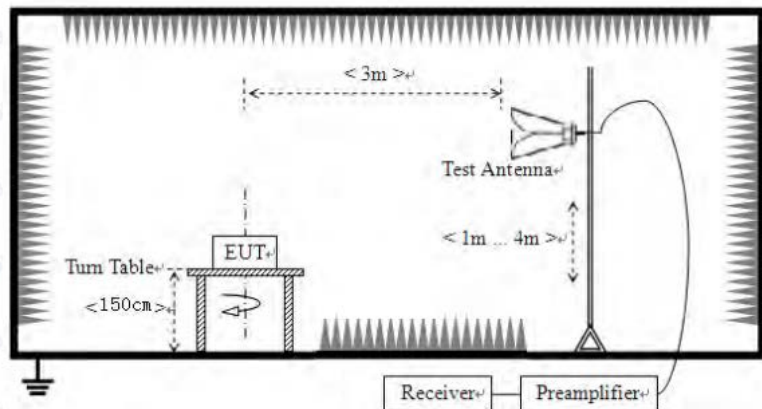

Test Procedure:

1. The EUT was placed on the top of a rotating table (0.8 meters for below 1GHz and 1.5meters for above 1GHz) above the ground at a 3 meter camber. The table was rotated 360 degrees to determine the position of the highest radiation.
2. The EUT was set 3 meters away from the interference-receiving antenna, which was mounted on the top of a variable-height antenna tower.
3. The antenna height is varied from one meter to four meters above the ground to determine the maximum value of the field strength. Both horizontal and vertical polarizations of the antenna are set to make the measurement.
4. For each suspected emission, the EUT was arranged to its worst case and then the antenna was tuned to heights from 1 meter to 4 meters and the rota table was turned from 0 degrees to 360 degrees to find the maximum reading.
5. The test-receiver system was set to Peak Detect Function and Specified Bandwidth with Maximum Hold Mode.
6. If the emission level of the EUT in peak mode was 10dB lower than the limit specified, then testing could be stopped and the peak values of the EUT would be reported. Otherwise the emissions that did not have 10dB margin would be re-tested one by one using peak, quasi-peak or

	average method as specified and then reported in a data sheet.					
Test Instruments:	Refer to section 5.8 for details					
Test mode:	Refer to section 5.2 for details					
Temp. / Hum.	Temp.:	25 °C	Humid.:	52%	Press.:	1 012mbar
Test results:	Pass					

*Remark:*

1. Pre-scan all kind of the place mode (X-axis, Y-axis, Z-axis), and found the Y-axis which it is worse case.

**Measurement data:**

■ **Below 30MHz**

The low frequency, which started from 9 kHz to 30 MHz, was pre-scanned and the result which was 20 dB lower than the limit line per 15.31(o) was not reported.

■ 30MHz ~ 1GHz

Horizontal:

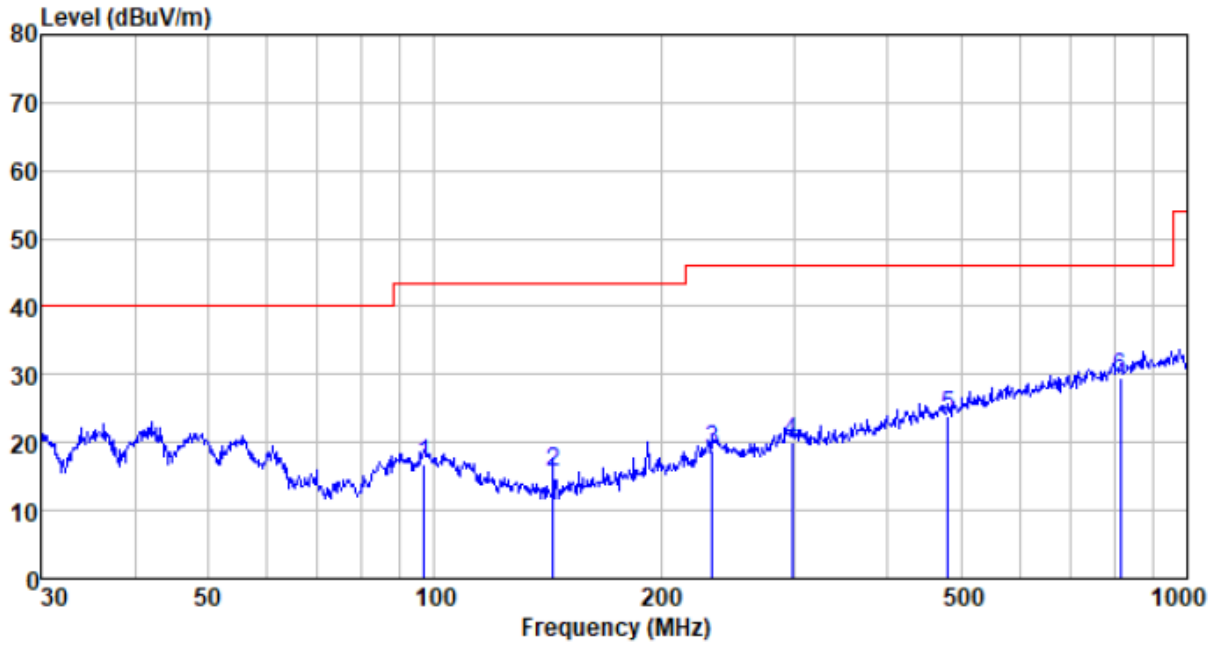

Freq MHz	Reading level dBuV	Antenna factor dB/m	Cable loss dB	Preamp factor dB	level dBuV	Limit level dBuV/m	Over limit dB	Remark
96.775	34.23	11.35	1.17	29.90	16.85	43.50	-26.65	QP
143.830	36.40	7.37	1.53	29.69	15.61	43.50	-27.89	QP
234.168	35.40	11.36	2.04	29.82	18.98	46.00	-27.02	QP
298.268	34.71	13.40	2.35	30.29	20.17	46.00	-25.83	QP
480.528	32.84	17.14	3.22	29.42	23.78	46.00	-22.22	QP
815.968	32.81	21.46	4.52	29.24	29.55	46.00	-16.45	QP

Vertical:

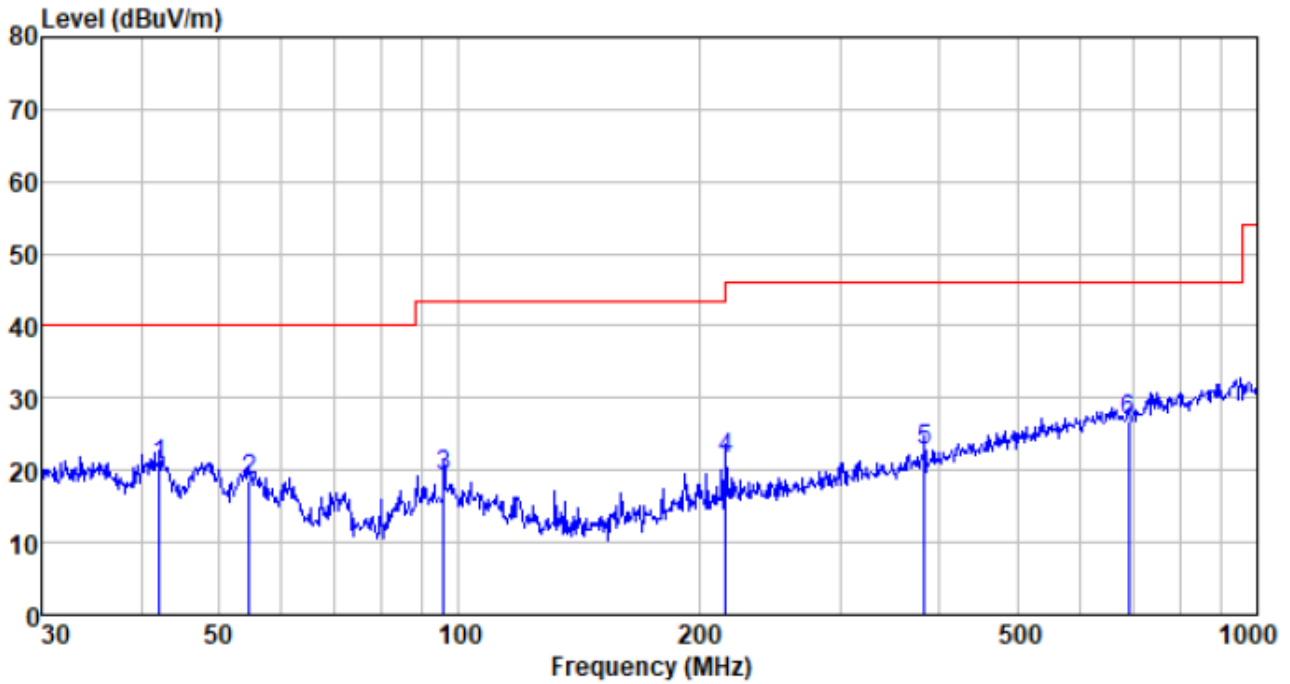

Freq MHz	Reading level dBuV	Antenna factor dB/m	Cable loss dB	Preamp factor dB	level dBuV	Limit level dBuV/m	Over limit dB	Remark
42.154	37.78	12.27	0.69	30.07	20.67	40.00	-19.33	QP
54.643	35.78	11.93	0.81	29.99	18.53	40.00	-21.47	QP
95.762	36.61	11.35	1.16	29.91	19.21	43.50	-24.29	QP
216.024	38.47	10.78	1.93	29.66	21.52	46.00	-24.48	QP
382.588	34.37	15.15	2.77	29.63	22.66	46.00	-23.34	QP
689.565	32.11	19.74	4.05	29.14	26.76	46.00	-19.24	QP

■ Above 1GHz

Test channel:	Lowest	Polarization:	Vertical
---------------	--------	---------------	----------

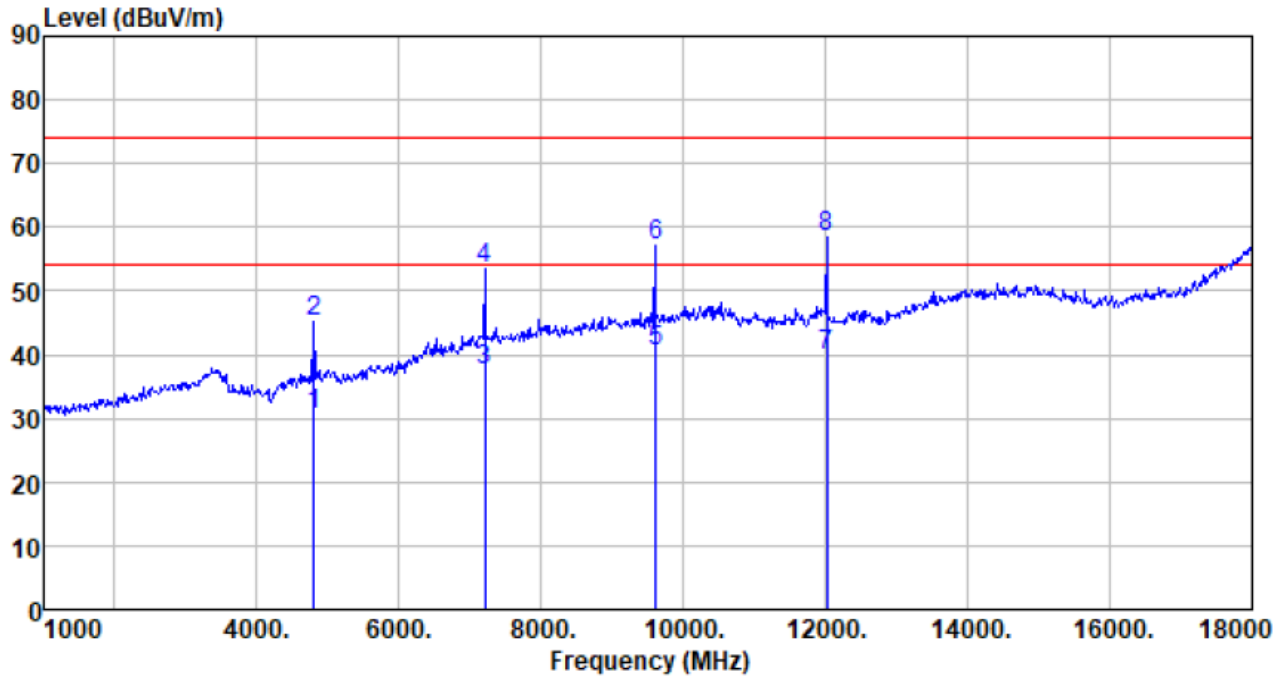

Freq MHz	Reading level dBuV	Antenna factor dB/m	Cable loss dB	Preamp factor dB	level dBuV	Limit level dBuV/m	Over limit dB	Remark
4804.000	27.37	31.35	9.36	37.58	30.50	54.00	-23.50	Average
4804.000	41.97	31.35	9.36	37.58	45.10	74.00	-28.90	Peak
7206.000	25.86	35.89	11.21	35.44	37.52	54.00	-16.48	Average
7206.000	41.97	35.89	11.21	35.44	53.63	74.00	-20.37	Peak
9608.000	24.94	37.74	12.91	34.96	40.63	54.00	-13.37	Average
9608.000	41.51	37.74	12.91	34.96	57.20	74.00	-16.80	Peak
12010.000	22.89	38.70	14.54	36.40	39.73	54.00	-14.27	Average
12010.000	41.47	38.70	14.54	36.40	58.31	74.00	-15.69	Peak

Test channel:	Lowest	Polarization:	Horizontal
---------------	--------	---------------	------------

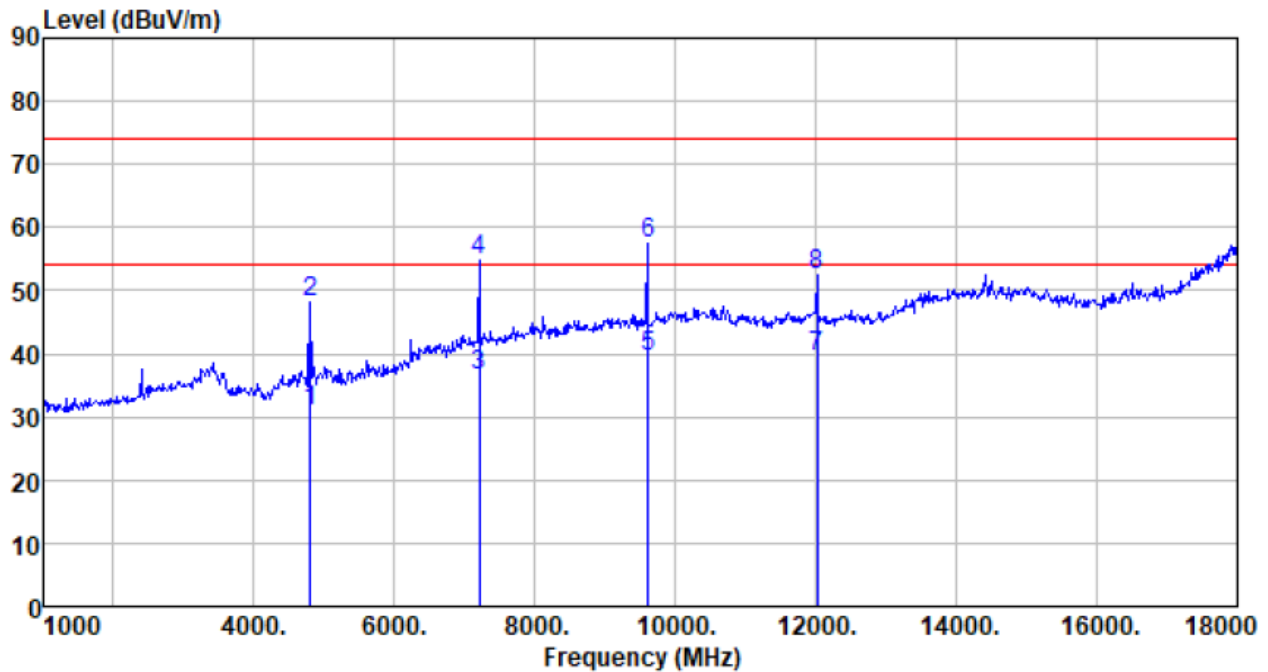

Freq MHz	Reading level dBuV	Antenna factor dB/m	Cable loss dB	Preamp factor dB	level dBuV	Limit level dBuV/m	Over limit dB	Remark
4804.000	27.75	31.35	9.36	37.58	30.88	54.00	-23.12	Average
4804.000	45.03	31.35	9.36	37.58	48.16	74.00	-25.84	Peak
7206.000	24.91	35.89	11.21	35.44	36.57	54.00	-17.43	Average
7206.000	43.09	35.89	11.21	35.44	54.75	74.00	-19.25	Peak
9608.000	23.96	37.74	12.91	34.96	39.65	54.00	-14.35	Average
9608.000	41.79	37.74	12.91	34.96	57.48	74.00	-16.52	Peak
12010.000	22.61	38.70	14.54	36.40	39.45	54.00	-14.55	Average
12010.000	35.72	38.70	14.54	36.40	52.56	74.00	-21.44	Peak

Test channel:	Middle	Polarization:	Vertical
---------------	--------	---------------	----------

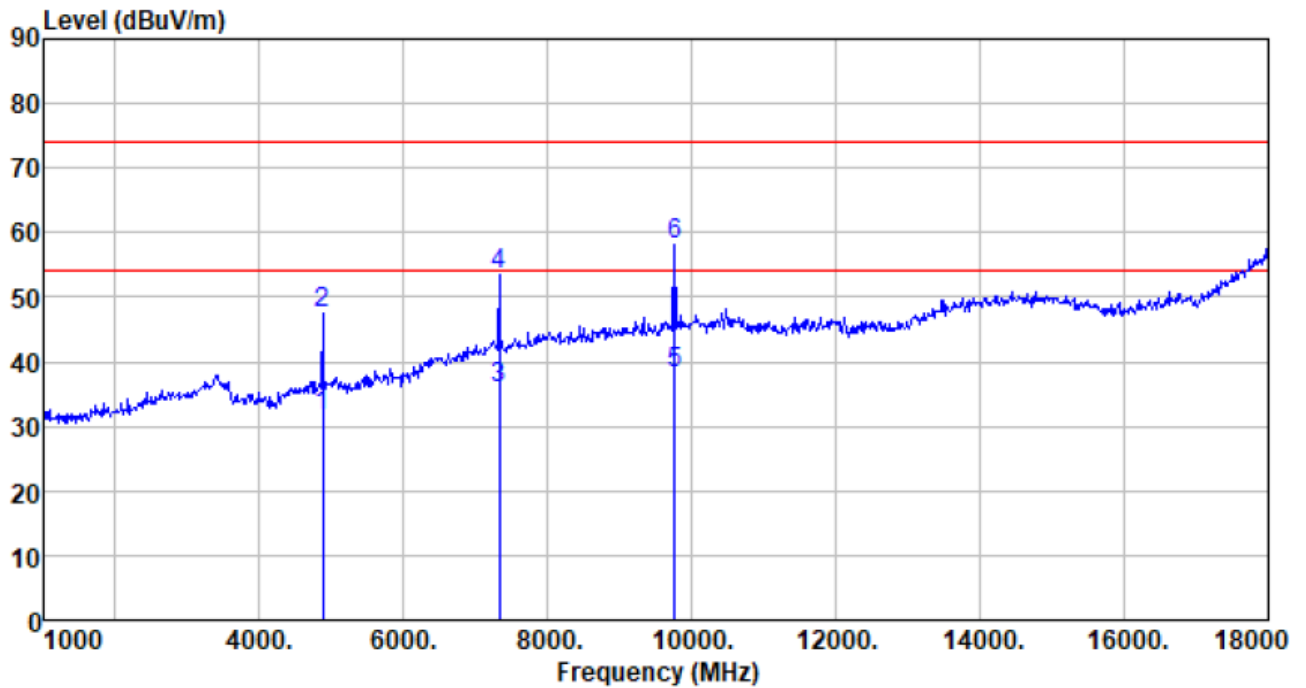

Freq MHz	Reading level dBuV	Antenna factor dB/m	Cable loss dB	Preamp factor dB	level dBuV	Limit level dBuV/m	Over limit dB	Remark
4880.000	28.37	31.48	9.42	37.59	31.68	54.00	-22.32	Average
4880.000	44.33	31.48	9.42	37.59	47.64	74.00	-26.36	Peak
7320.000	24.00	36.17	11.30	35.47	36.00	54.00	-18.00	Average
7320.000	41.58	36.17	11.30	35.47	53.58	74.00	-20.42	Peak
9760.000	22.09	38.07	13.01	35.09	38.08	54.00	-15.92	Average
9760.000	42.11	38.07	13.01	35.09	58.10	74.00	-15.90	Peak

Test channel:	Middle	Polarization:	Horizontal
---------------	--------	---------------	------------

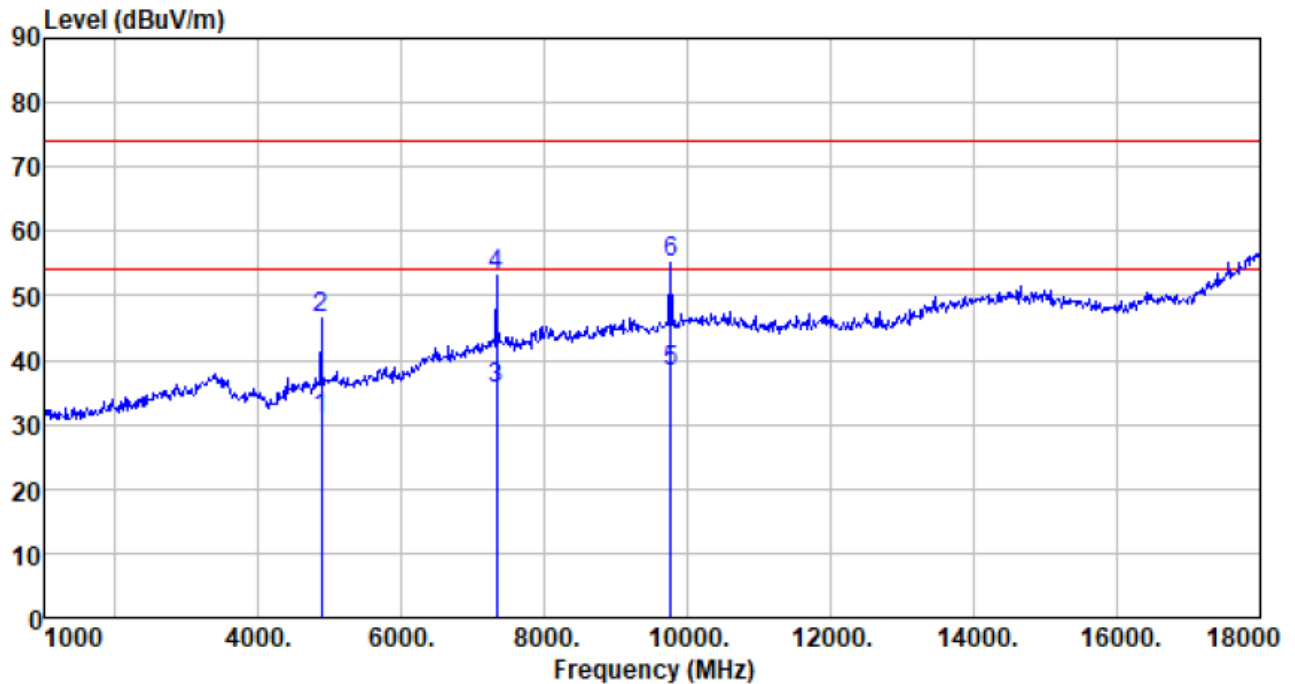

Freq MHz	Reading level dBuV	Antenna factor dB/m	Cable loss dB	Preamp factor dB	level dBuV	Limit level dBuV/m	Over limit dB	Remark
4880.000	27.62	31.48	9.42	37.59	30.93	54.00	-23.07	Average
4880.000	43.34	31.48	9.42	37.59	46.65	74.00	-27.35	Peak
7320.000	23.51	36.17	11.30	35.47	35.51	54.00	-18.49	Average
7320.000	41.30	36.17	11.30	35.47	53.30	74.00	-20.70	Peak
9760.000	22.24	38.07	13.01	35.09	38.23	54.00	-15.77	Average
9760.000	39.16	38.07	13.01	35.09	55.15	74.00	-18.85	Peak



Test channel:	Highest	Polarization:	Vertical
---------------	---------	---------------	----------

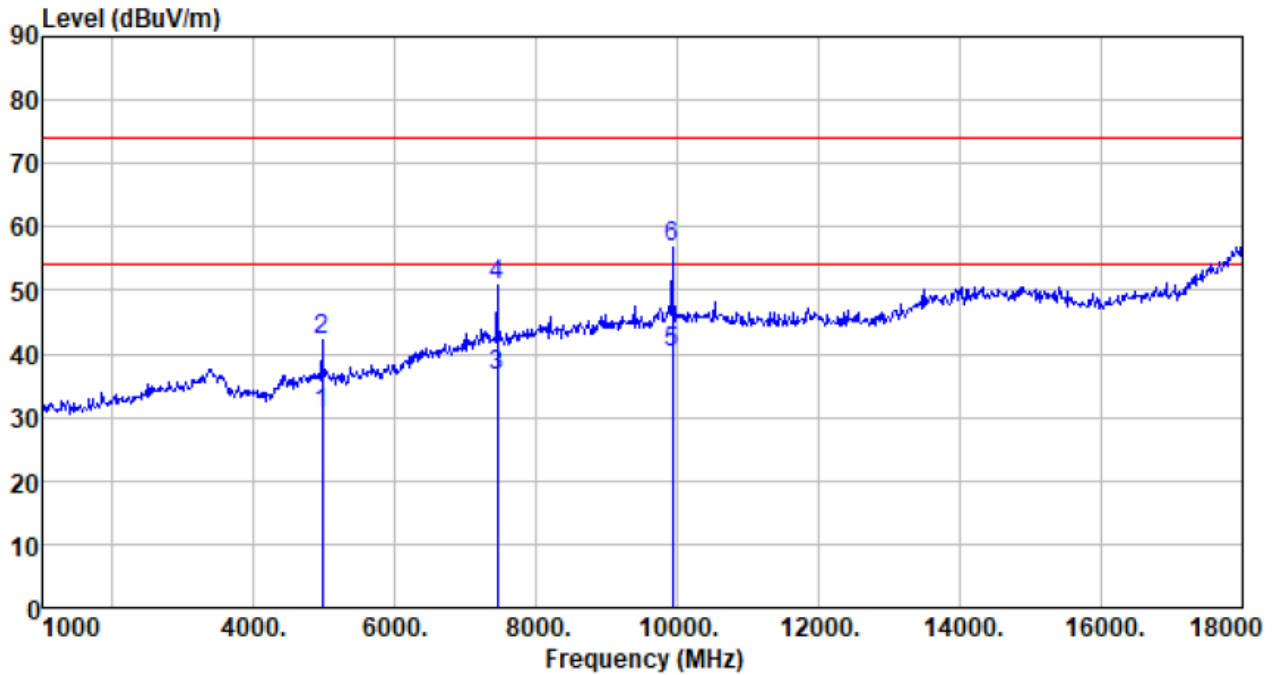

Freq MHz	Reading level dBuV	Antenna factor dB/m	Cable loss dB	Preamp factor dB	level dBuV	Limit level dBuV/m	Over limit dB	Remark
4960.000	27.04	31.63	9.48	37.60	30.55	54.00	-23.45	Average
4960.000	38.59	31.63	9.48	37.60	42.10	74.00	-31.90	Peak
7440.000	24.30	36.46	11.39	35.49	36.66	54.00	-17.34	Average
7440.000	38.40	36.46	11.39	35.49	50.76	74.00	-23.24	Peak
9920.000	23.88	38.42	13.13	35.23	40.20	54.00	-13.80	Average
9920.000	40.50	38.42	13.13	35.23	56.82	74.00	-17.18	Peak

Test channel:	Highest	Polarization:	Horizontal
---------------	---------	---------------	------------

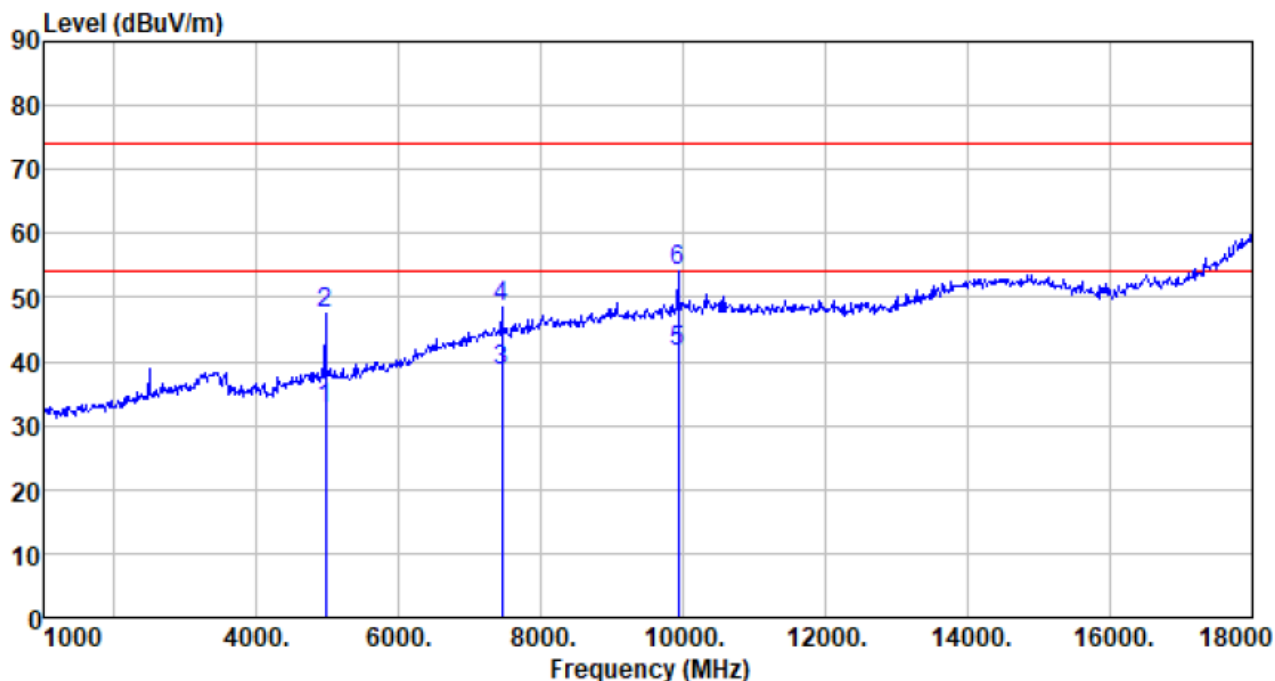

Freq MHz	Reading level dBuV	Antenna factor dB/m	Cable loss dB	Preamp factor dB	level dBuV	Limit level dBuV/m	Over limit dB	Remark
4960.000	29.18	31.63	9.48	37.60	32.69	54.00	-21.31	Average
4960.000	44.08	31.63	9.48	37.60	47.59	74.00	-26.41	Peak
7440.000	26.02	36.46	11.39	35.49	38.38	54.00	-15.62	Average
7440.000	36.08	36.46	11.39	35.49	48.44	74.00	-25.56	Peak
9920.000	25.10	38.42	13.13	35.23	41.42	54.00	-12.58	Average
9920.000	37.85	38.42	13.13	35.23	54.17	74.00	-19.83	Peak

**Remark:**

1. *Final Level = Receiver Read level + Antenna Factor + Cable Loss – Preamplifier Factor*
2. *The emission levels of other frequencies are very lower than the limit and not show in test report.*

## 8 Test Setup Photo

Radiated Emission

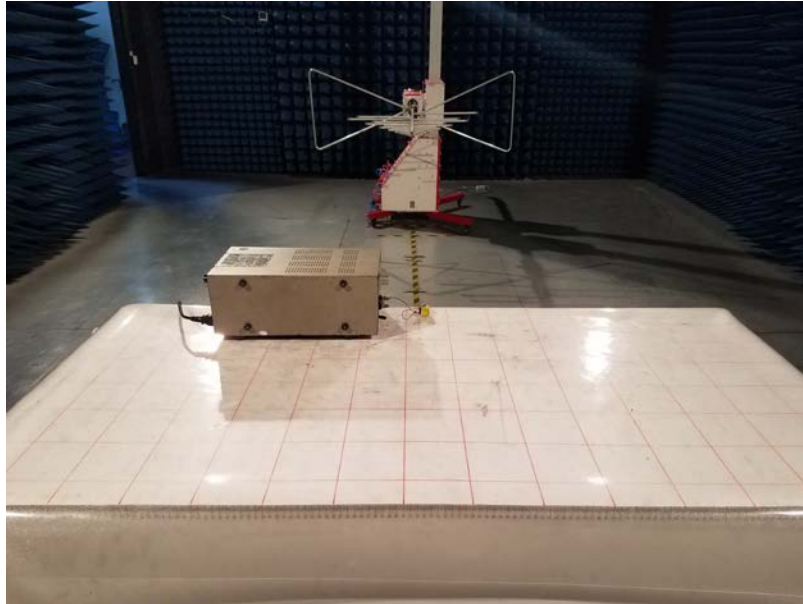

## 9 EUT Constructional Details

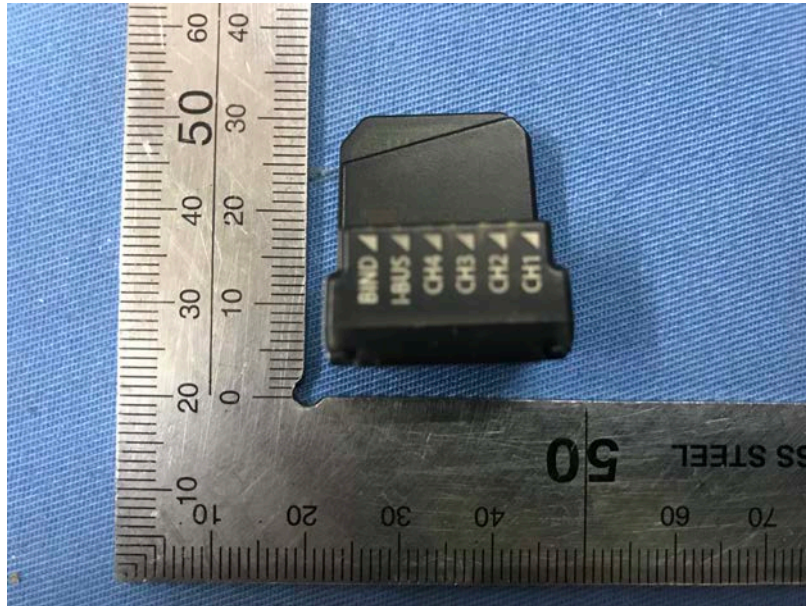



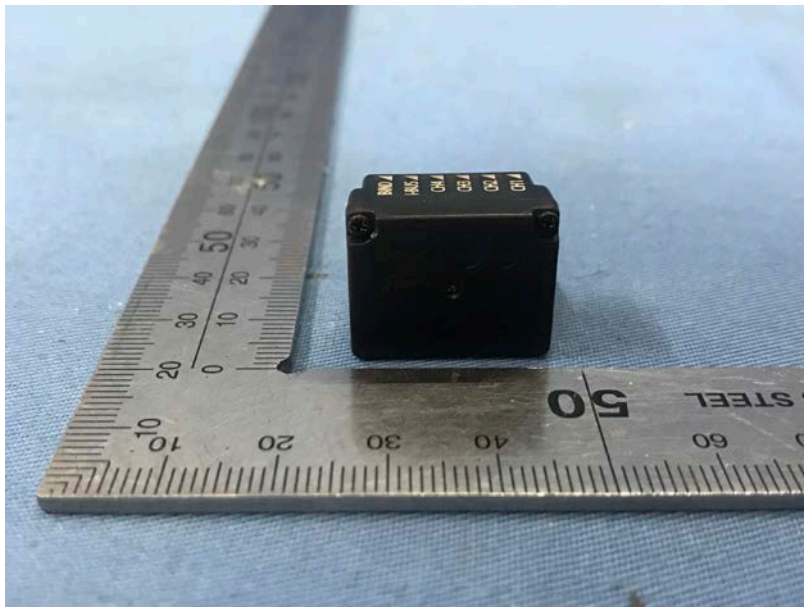

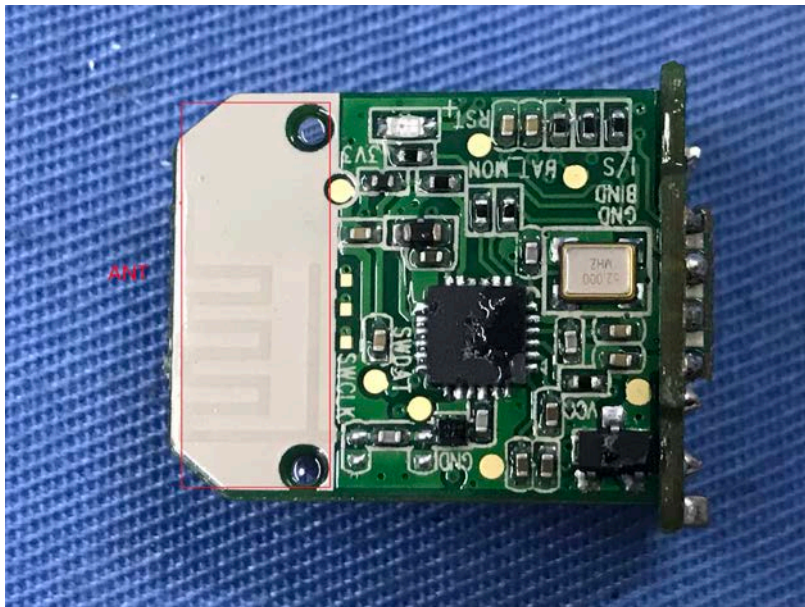
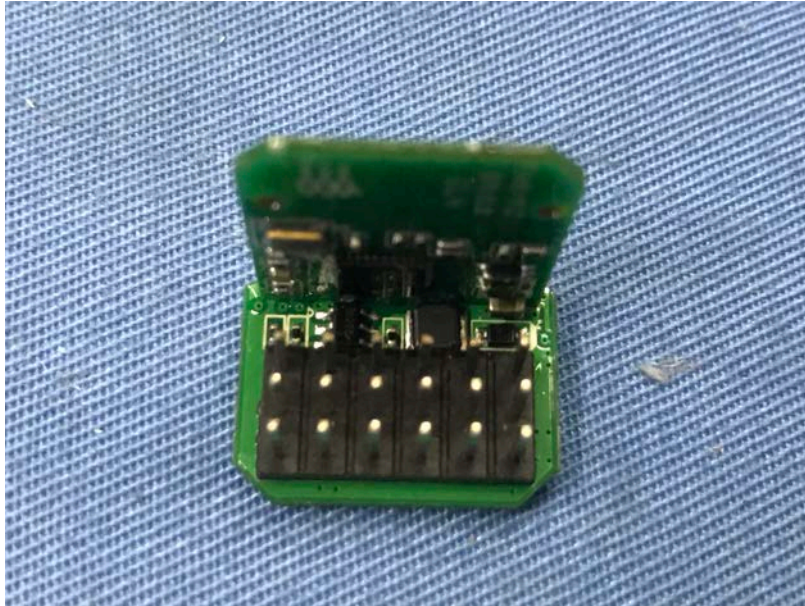

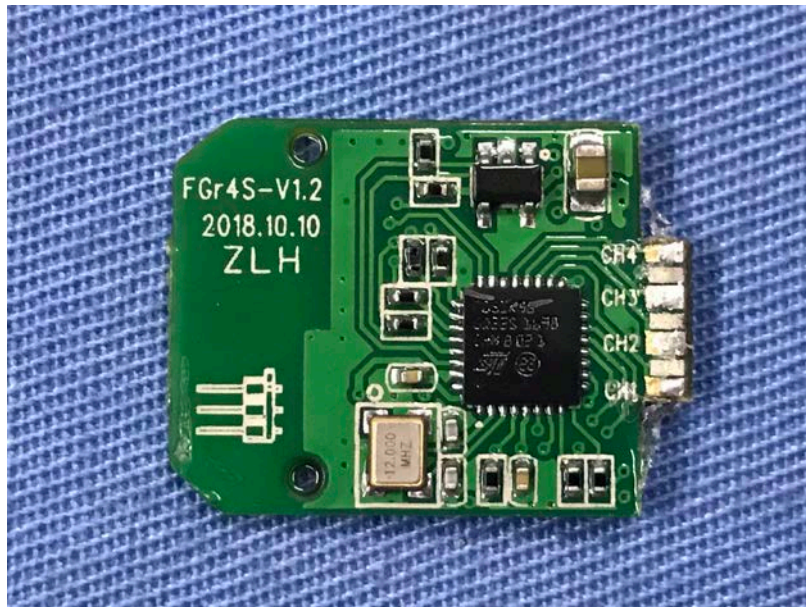

---End---