

TEST REPORT

Applicant: FLYSKY RC MODEL TECHNOLOGY CO., LTD

Address of Applicant: West building3, Huangjianyuan Ind, Park QIAOLI North Gate
Changping Town, Dongguan, China

Manufacturer: ShenZhen FLYSKY Technology Co.,Ltd

Address of Manufacturer: ADD 16F, Huafeng Building, No. 6006 Shennan Road, Futian
District, Shenzhen, Guangdong, China

Factory: Dongguan Flysky RC Model technology Co.,Ltd

Address of Factory: West building3,Huangjianyuan Ind Park QIAOLI North Gate
Changping Town Dongguan ,China

Equipment Under Test (EUT)

Product Name: 8-channel receiver

Model No.: FGr8B

Trade Mark: FLYSKY

FCC ID: N4ZFGR8B

Applicable standards: FCC CFR Title 47 Part 15 Subpart C Section 15.247

Date of sample receipt: June 12, 2020

Date of Test: June 26-28, 2020

Date of report issued: June 29, 2020

Test Result : PASS *

* In the configuration tested, the EUT complied with the standards specified above.

Authorized Signature:

A circular blue ink stamp for GTS (Global United Technology Services Co., Ltd.) is overlaid with a handwritten signature in black ink. The signature appears to be 'Robinson Lo' and includes the date 'June'.

Robinson Lo
Laboratory Manager

This results shown in this test report refer only to the sample(s) tested, this test report cannot be reproduced, except in full, without prior written permission of the company. The report would be invalid without specific stamp of test institute and the signatures of compiler and approver.

2 Version

Version No.	Date	Description
00	June 29, 2020	Original

Prepared By:  **Date:** June 29, 2020

Project Engineer

Check By:  **Date:** June 29, 2020

Reviewer

3 Contents

	Page
1 COVER PAGE	1
2 VERSION	2
3 CONTENTS	3
4 TEST SUMMARY	4
4.1 MEASUREMENT UNCERTAINTY	4
5 GENERAL INFORMATION	5
5.1 GENERAL DESCRIPTION OF EUT	5
5.2 TEST MODE	7
5.3 TEST FACILITY.....	7
5.4 TEST LOCATION	7
5.5 DESCRIPTION OF SUPPORT UNITS	7
5.6 DEVIATION FROM STANDARDS.....	7
5.7 ABNORMALITIES FROM STANDARD CONDITIONS.....	7
5.8 ADDITIONAL INSTRUCTIONS.....	7
6 TEST INSTRUMENTS LIST	8
7 TEST RESULTS AND MEASUREMENT DATA.....	10
7.1 ANTENNA REQUIREMENT.....	10
7.2 CONDUCTED PEAK OUTPUT POWER	11
7.3 20dB EMISSION BANDWIDTH	13
7.4 CARRIER FREQUENCIES SEPARATION.....	15
7.5 HOPPING CHANNEL NUMBER	17
7.6 DWELL TIME.....	18
7.7 PSEUDORANDOM FREQUENCY HOPPING SEQUENCE	22
7.8 BAND EDGE	23
7.8.1 Conducted Emission Method.....	23
7.8.2 Radiated Emission Method.....	25
7.9 SPURIOUS EMISSION.....	30
7.9.1 Conducted Emission Method.....	30
7.9.2 Radiated Emission Method.....	32
8 TEST SETUP PHOTO	47
9 EUT CONSTRUCTIONAL DETAILS	47

4 Test Summary

Test Item	Section	Result
Antenna Requirement	15.203/15.247 (c)	Pass
AC Power Line Conducted Emission	15.207	N/A
Conducted Peak Output Power	15.247 (b)(1)	Pass
20dB Occupied Bandwidth	15.247 (a)(1)	Pass
Carrier Frequencies Separation	15.247 (a)(1)	Pass
Hopping Channel Number	15.247 (a)(1)	Pass
Dwell Time	15.247 (a)(1)	Pass
Pseudorandom Frequency Hopping Sequence	15.247(b)(4)	Pass
Radiated Emission	15.205/15.209	Pass
Band Edge	15.247(d)	Pass

Pass: The EUT complies with the essential requirements in the standard.

Remark : Test according to ANSI C63.10:2013.

4.1 Measurement Uncertainty

Test Item	Frequency Range	Measurement Uncertainty	Notes
Radiated Emission	30MHz-200MHz	3.8039dB	(1)
Radiated Emission	200MHz-1GHz	3.9679dB	(1)
Radiated Emission	1GHz-18GHz	4.29dB	(1)
Radiated Emission	18GHz-40GHz	3.30dB	(1)
AC Power Line Conducted Emission	0.15MHz ~ 30MHz	3.44dB	(1)

Note (1): The measurement uncertainty is for coverage factor of k=2 and a level of confidence of 95%.

5 General Information

5.1 General Description of EUT

Product Name:	8-channel receiver
Model No.:	FGr8B
Serial No.:	N/A
Test sample(s) ID:	GTS202006000143-1
Sample(s) Status	Engineer sample
Operation Frequency:	2402.6MHz~2479.4MHz
Channel numbers:	43
Modulation technology:	GMSK, CSS
Antenna Type:	Integral Antenna
Antenna gain:	2dBi
Power supply:	DC 3.5~9V

Remark: The system works in the frequency range of 2402.6MHz to 2479.4MHz. This band has been divided to 43 independent channels. Radio system uses 32 different channels; the minimum channel separation is ≥ 1.8 MHz. By using various switch-on times, hopping scheme and channel frequencies, the system can guarantee a jamming free radio transmission. The channel list is below.

Operation Frequency each of channel							
Channel	Frequency (MHz)	Channel	Frequency (MHz)	Channel	Frequency (MHz)	Channel	Frequency (MHz)
1	2402.6	12	2422.4	23	2442.2	34	2463.2
2	2404.4	13	2424.2	24	2445.2	35	2465.0
3	2406.2	14	2426.0	25	2447.0	36	2466.8
4	2408.0	15	2427.8	26	2448.8	37	2468.6
5	2409.8	16	2429.6	27	2450.6	38	2470.4
6	2411.6	17	2431.4	28	2452.4	39	2472.2
7	2413.4	18	2433.2	29	2454.2	40	2474.0
8	2415.2	19	2435.0	30	2456.0	41	2475.8
9	2417.0	20	2436.8	31	2457.8	42	2477.6
10	2418.8	21	2438.6	32	2459.6	43	2479.4
11	2420.6	22	2440.4	33	2461.4		

In section 15.31(m), regards to the operating frequency range over 10 MHz, the Lowest frequency, the middle frequency, and the highest frequency of channel were selected to perform the test, and the selected channel see below:

Channel	Frequency
The lowest channel	2402.6MHz
The middle channel	2440.4MHz
The Highest channel	2479.4MHz

5.2 Test mode

Transmitting mode	Keep the EUT in transmitting mode.
Remark: During the test, the test voltage was tuned from DC3.5 to DC9.0V, and found that the worst case was the DC9.0V. So the report just shows that condition's data. (All modulation have been tested ,only worse case is reported)	

5.3 Test Facility

<p>The test facility is recognized, certified, or accredited by the following organizations:</p> <ul style="list-style-type: none"> ● FCC —Registration No.: 381383 Global United Technology Services Co., Ltd., Shenzhen EMC Laboratory has been registered and fully described in a report filed with the (FCC) Federal Communications Commission. The acceptance letter from the FCC is maintained in files. Registration 381383. ● IC —Registration No.: 9079A The 3m Semi-anechoic chamber of Global United Technology Services Co., Ltd. has been registered by Certification and Engineering Bureau of Industry Canada for radio equipment testing with Registration No.: 9079A ● NVLAP (LAB CODE:600179-0) Global United Technology Services Co., Ltd., is accredited by the National Voluntary Laboratory Accreditation Program (NVLAP). LAB CODE:600179-0

5.4 Test Location

All other tests were performed at:
<p>Global United Technology Services Co., Ltd. Address: No. 123-128, Tower A, Jinyuan Business Building, No.2, Laodong Industrial Zone, Xixiang Road, Baoan District, Shenzhen, Guangdong, China 518102 Tel: 0755-27798480 Fax: 0755-27798960</p>

5.5 Description of Support Units

Manufacturer	Description	Model	Serial Number
ShenZhen FLYSKY Technology Co.,Ltd	Remote control	F6S	N/A
MEILI	DC POWER SUPPLY	MCH-305A	011121168

5.6 Deviation from Standards

None.

5.7 Abnormalities from Standard Conditions

None.

5.8 Additional Instructions

Software (Used for test) from client
Built-in by manufacturer, power set default.

6 Test Instruments list

Radiated Emission:						
Item	Test Equipment	Manufacturer	Model No.	Inventory No.	Cal.Date (mm-dd-yy)	Cal.Due date (mm-dd-yy)
1	3m Semi- Anechoic Chamber	ZhongYu Electron	9.2(L)*6.2(W)* 6.4(H)	GTS250	July. 03 2015	July. 02 2020
2	Control Room	ZhongYu Electron	6.2(L)*2.5(W)* 2.4(H)	GTS251	N/A	N/A
3	EMI Test Receiver	Rohde & Schwarz	ESU26	GTS203	June. 25 2020	June. 24 2021
4	BiConiLog Antenna	SCHWARZBECK MESS-ELEKTRONIK	VULB9163	GTS214	June. 25 2020	June. 24 2021
5	Double -ridged waveguide horn	SCHWARZBECK MESS-ELEKTRONIK	BBHA 9120 D	GTS208	June. 25 2020	June. 24 2021
6	Horn Antenna	ETS-LINDGREN	3160	GTS217	June. 25 2020	June. 24 2021
7	EMI Test Software	AUDIX	E3	N/A	N/A	N/A
8	Coaxial Cable	GTS	N/A	GTS213	June. 25 2020	June. 24 2021
9	Coaxial Cable	GTS	N/A	GTS211	June. 25 2020	June. 24 2021
10	Coaxial cable	GTS	N/A	GTS210	June. 25 2020	June. 24 2021
11	Coaxial Cable	GTS	N/A	GTS212	June. 25 2020	June. 24 2021
12	Amplifier(100kHz-3GHz)	HP	8347A	GTS204	June. 25 2020	June. 24 2021
13	Amplifier(2GHz-20GHz)	HP	84722A	GTS206	June. 25 2020	June. 24 2021
14	Amplifier (18-26GHz)	Rohde & Schwarz	AFS33-18002 650-30-8P-44	GTS218	June. 25 2020	June. 24 2021
15	Band filter	Amindeon	82346	GTS219	June. 25 2020	June. 24 2021
16	Power Meter	Anritsu	ML2495A	GTS540	June. 25 2020	June. 24 2021
17	Power Sensor	Anritsu	MA2411B	GTS541	June. 25 2020	June. 24 2021
18	Wideband Radio Communication Tester	Rohde & Schwarz	CMW500	GTS575	June. 25 2020	June. 24 2021
19	Splitter	Agilent	11636B	GTS237	June. 25 2020	June. 24 2021
20	Loop Antenna	ZHINAN	ZN30900A	GTS534	June. 25 2020	June. 24 2021
21	Breitband hornantenne	SCHWARZBECK	BBHA 9170	GTS579	Oct. 19 2019	Oct. 18 2020
22	Amplifier	TDK	PA-02-02	GTS574	Oct. 19 2019	Oct. 18 2020
23	Amplifier	TDK	PA-02-03	GTS576	Oct. 19 2019	Oct. 18 2020
24	PSA Series Spectrum Analyzer	Rohde & Schwarz	FSP	GTS578	June. 25 2020	June. 24 2021

RF Conducted Test:						
Item	Test Equipment	Manufacturer	Model No.	Serial No.	Cal.Date (mm-dd-yy)	Cal.Due date (mm-dd-yy)
1	MXA Signal Analyzer	Agilent	N9020A	GTS566	June. 25 2020	June. 24 2021
2	EMI Test Receiver	R&S	ESCI 7	GTS552	June. 25 2020	June. 24 2021
3	Spectrum Analyzer	Agilent	E4440A	GTS533	June. 25 2020	June. 24 2021
4	MXG vector Signal Generator	Agilent	N5182A	GTS567	June. 25 2020	June. 24 2021
5	ESG Analog Signal Generator	Agilent	E4428C	GTS568	June. 25 2020	June. 24 2021
6	USB RF Power Sensor	DARE	RPR3006W	GTS569	June. 25 2020	June. 24 2021
7	RF Switch Box	Shongyi	RFSW3003328	GTS571	June. 25 2020	June. 24 2021
8	Programmable Constant Temp & Humi Test Chamber	WEWON	WHTH-150L-40-880	GTS572	June. 25 2020	June. 24 2021

General used equipment:						
Item	Test Equipment	Manufacturer	Model No.	Inventory No.	Cal.Date (mm-dd-yy)	Cal.Due date (mm-dd-yy)
1	Humidity/ Temperature Indicator	KTJ	TA328	GTS243	June. 25 2020	June. 24 2021
2	Barometer	ChangChun	DYM3	GTS255	June. 25 2020	June. 24 2021

7 Test results and Measurement Data

7.1 Antenna requirement

Standard requirement:	FCC Part15 C Section 15.203 /247(c)
<p>15.203 requirement:</p> <p>An intentional radiator shall be designed to ensure that no antenna other than that furnished by the responsible party shall be used with the device. The use of a permanently attached antenna or of an antenna that uses a unique coupling to the intentional radiator, the manufacturer may design the unit so that a broken antenna can be replaced by the user, but the use of a standard antenna jack or electrical connector is prohibited.</p> <p>15.247(c) (1)(i) requirement:</p> <p>(i) Systems operating in the 2400-2483.5 MHz band that is used exclusively for fixed. Point-to-point operations may employ transmitting antennas with directional gain greater than 6dBi provided the maximum conducted output power of the intentional radiator is reduced by 1 dB for every 3 dB that the directional gain of the antenna exceeds 6dBi.</p>	
EUT Antenna:	
<p><i>The antenna is integral antenna, the best case gain of the antenna is 2dBi, reference to the appendix II for details.</i></p>	

7.2 Conducted Peak Output Power

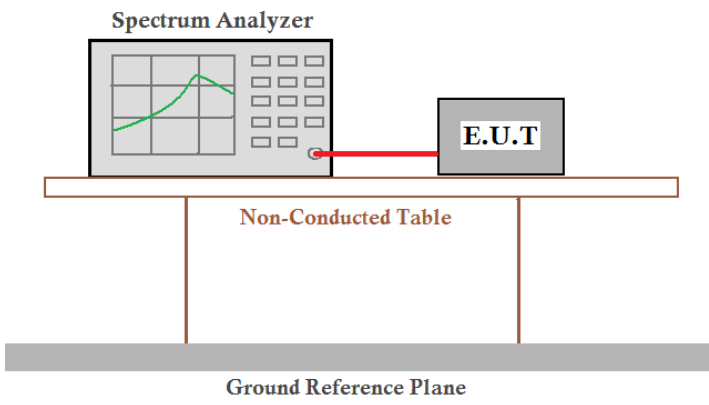
Test Requirement:	FCC Part15 C Section 15.247 (b)(1)
Test Method:	ANSI C63.10:2013
Limit:	20.97dBm
Test setup:	 <p>The diagram illustrates the test setup. A Spectrum Analyzer is connected to an E.U.T. (Equipment Under Test) via a red cable. Both are placed on a Non-Conducted Table, which is supported by a Ground Reference Plane.</p>
Test Instruments:	Refer to section 6.0 for details
Test mode:	Refer to section 5.2 for details
Test results:	Pass

Measurement Data

Test channel	Peak Output Power (dBm)	Limit (dBm)	Result
Lowest	15.64	20.97	Pass
Middle	15.35		
Highest	15.27		

Test plot as follows:

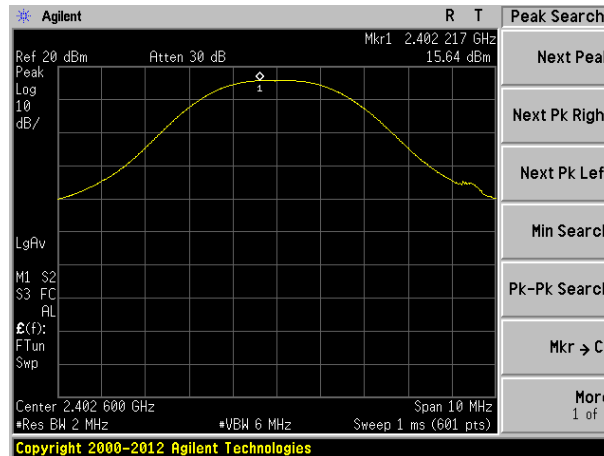

Lowest channel

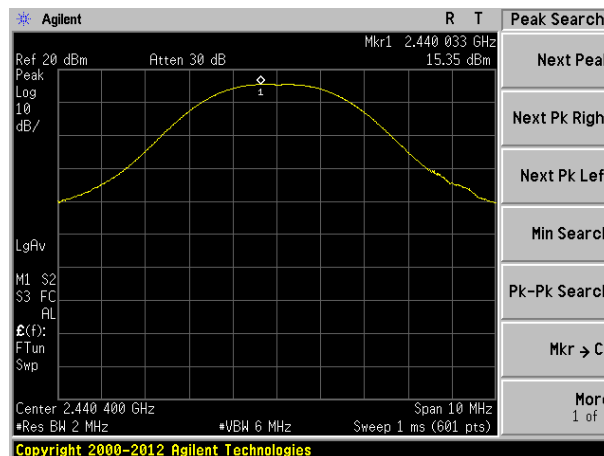

Middle channel

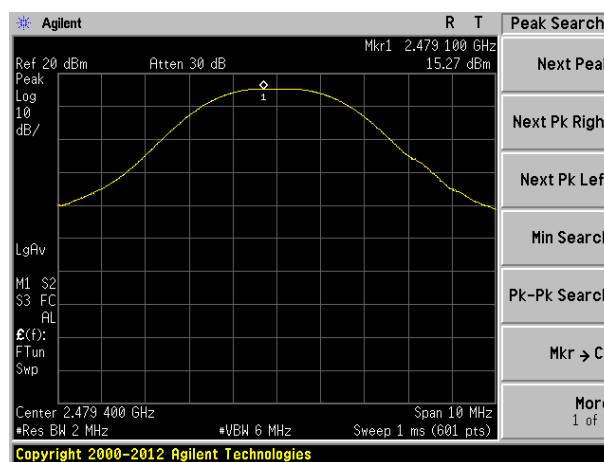

Highest channel

7.3 20dB Emission Bandwidth

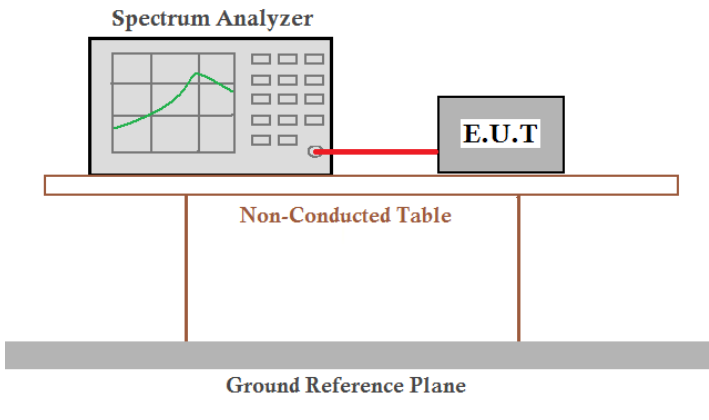
Test Requirement:	FCC Part15 C Section 15.247 (a)(1)
Test Method:	ANSI C63.10:2013
Limit:	N/A
Test setup:	 <p>The diagram illustrates the test setup. A Spectrum Analyzer is connected to an E.U.T. (Equipment Under Test) via a red cable. Both are placed on a Non-Conducted Table, which is supported by two legs. Below the table is a Ground Reference Plane.</p>
Test Instruments:	Refer to section 6.0 for details
Test mode:	Refer to section 5.2 for details
Test results:	Pass

Measurement Data

Test channel	20dB Emission Bandwidth (MHz)	Result
Lowest	1.420	Pass
Middle	1.400	
Highest	1.453	

Test plot as follows:



Lowest channel

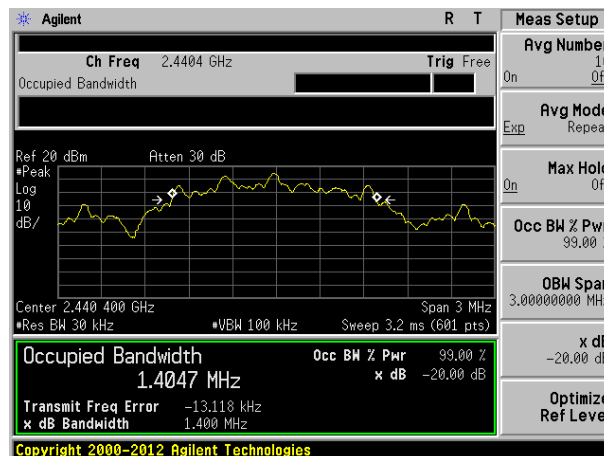

Middle channel

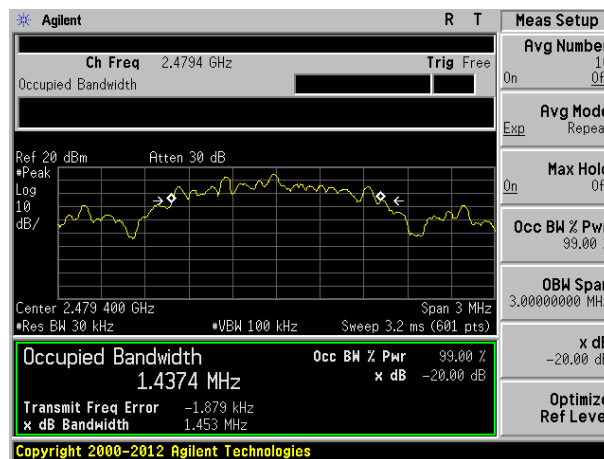

Highest channel

7.4 Carrier Frequencies Separation

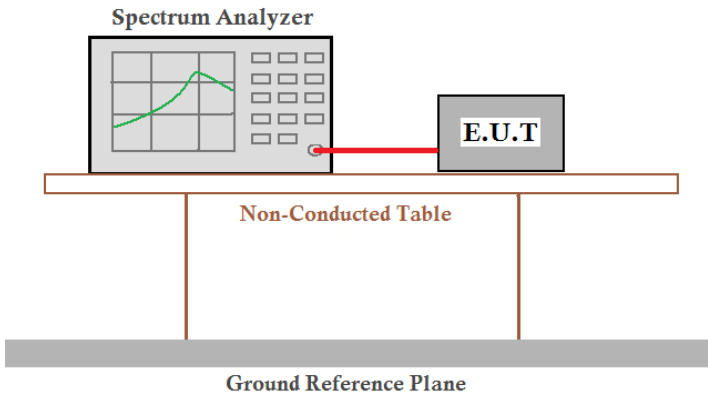
Test Requirement:	FCC Part15 C Section 15.247 (a)(1)
Test Method:	ANSI C63.10:2013
Receiver setup:	RBW=100KHz, VBW=300KHz, detector=Peak
Limit:	0.025MHz or 2/3 of the 20dB bandwidth (whichever is greater)
Test setup:	 <p>The diagram illustrates the test setup. A Spectrum Analyzer is connected to an E.U.T. (Equipment Under Test) via a red cable. Both are placed on a Non-Conducted Table, which is supported by two vertical legs. Below the table is a Ground Reference Plane.</p>
Test Instruments:	Refer to section 6.0 for details
Test mode:	Refer to section 5.2 for details
Test results:	Pass

Measurement Data

Test channel	Carrier Frequencies Separation (kHz)	Limit (kHz)	Result
Lowest	1810	969	Pass
Middle	1805	969	Pass
Highest	1805	969	Pass

Note: According to section 7.3

Mode	20dB bandwidth (kHz) (worse case)	Limit (kHz) (Carrier Frequencies Separation)
GFSK, CSS	1453	969

Test plot as follows:

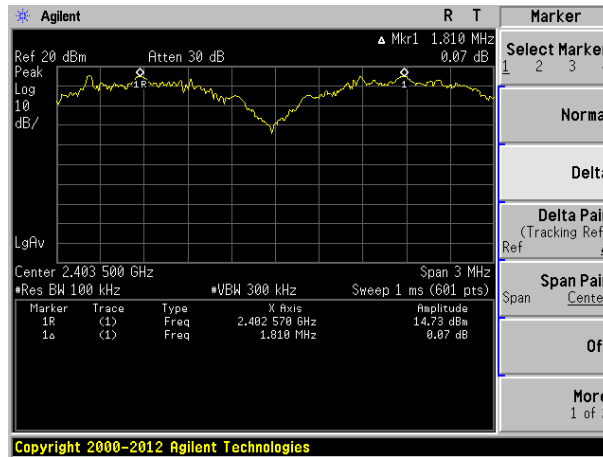

Lowest channel

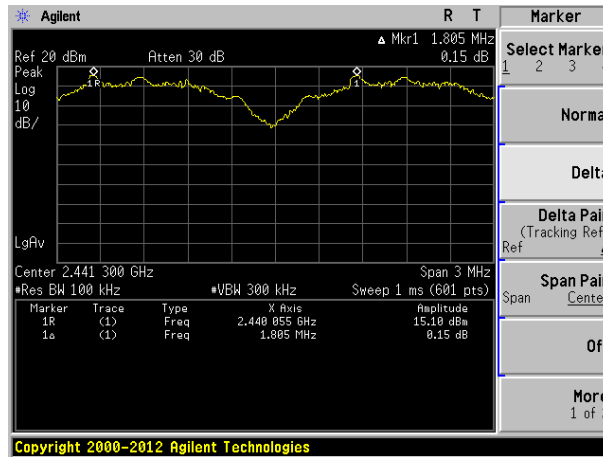

Middle channel

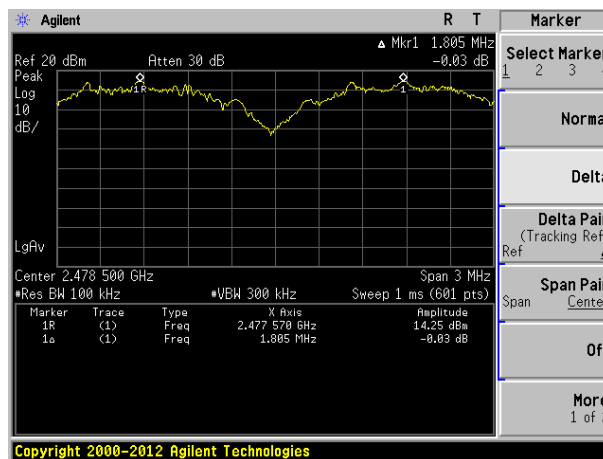

Highest channel

7.5 Hopping Channel Number

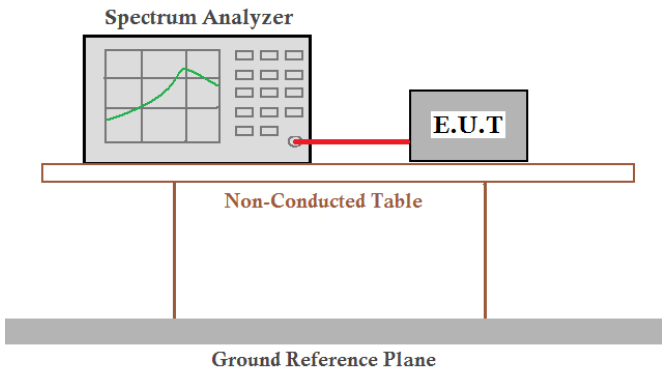
Test Requirement:	FCC Part15 C Section 15.247 (a)(1)
Test Method:	ANSI C63.10:2013
Receiver setup:	RBW=100kHz, VBW=300kHz, Frequency range=2400MHz-2483.5MHz, Detector=Peak
Limit:	15 channels
Test setup:	
Test Instruments:	Refer to section 6.0 for details
Test mode:	Refer to section 5.2 for details
Test results:	Pass

Measurement Data:

Hopping channel numbers	Limit	Result
32	15	Pass

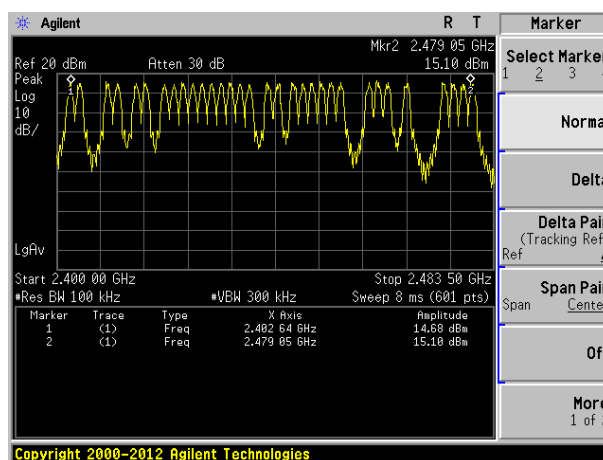

7.6 Dwell Time

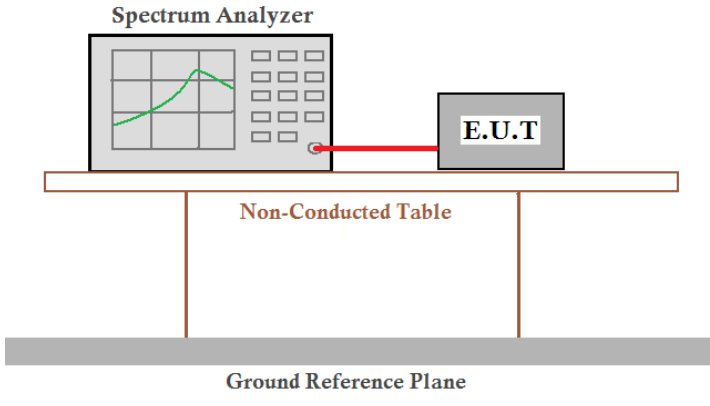
Test Requirement:	FCC Part15 C Section 15.247 (a)(1)
Test Method:	ANSI C63.10:2013
Receiver setup:	RBW=1MHz, VBW=1MHz, Span=0Hz, Detector=Peak
Limit:	0.4 Second
Test setup:	 <p>The diagram illustrates the test setup. A Spectrum Analyzer is connected via a red cable to an E.U.T. (Equipment Under Test). Both are placed on a Non-Conducted Table. Below the table is a Ground Reference Plane.</p>
Test Instruments:	Refer to section 6.0 for details
Test mode:	Refer to section 5.2 for details
Test results:	Pass

Measurement Data

Frequency(MHz)	Ton (ms)	Dwell time(ms)	Limit(ms)	Result
2402.6	0.5033	70.86	400	Pass
2440.4	0.5033	70.86	400	Pass
2479.4	0.5033	70.86	400	Pass

The formula as below:

2402.6MHz: Dwell time = Ton * Ton times in 1s * 0.4s * channel numbers=0.5033ms*11*0.4*32=70.86 ms

2440.4MHz: Dwell time = Ton * Ton times in 1s * 0.4s * channel numbers=0.5033ms*11*0.4*32=70.86 ms

2479.4MHz: Dwell time = Ton * Ton times in 1s * 0.4s * channel numbers=0.5033ms*11*0.4*32=70.86 ms

Test plot as follows:

Frequency:	2402.6MHz
------------	-----------

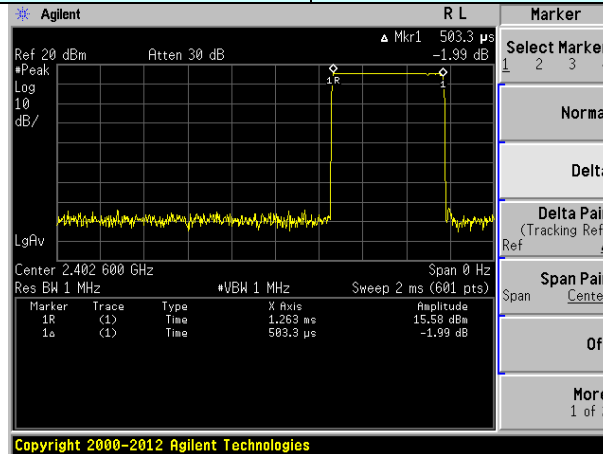

Ton

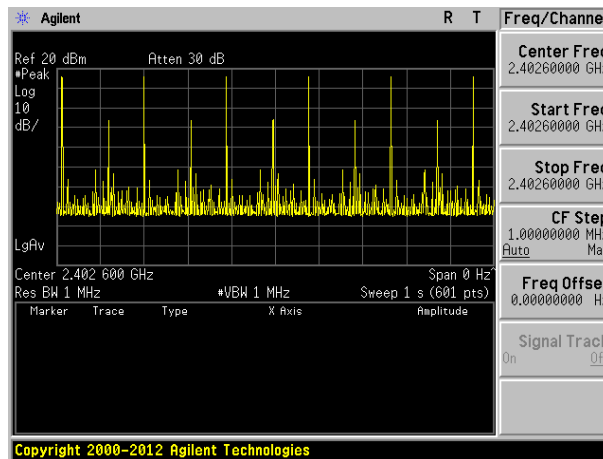

Ton times in 1s

Frequency: 2440.4MHz

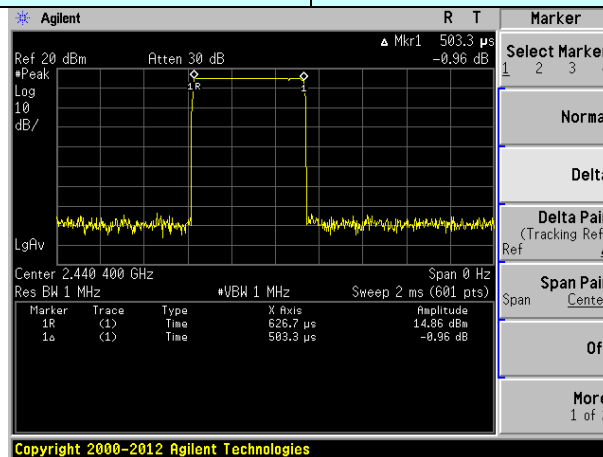

Ton

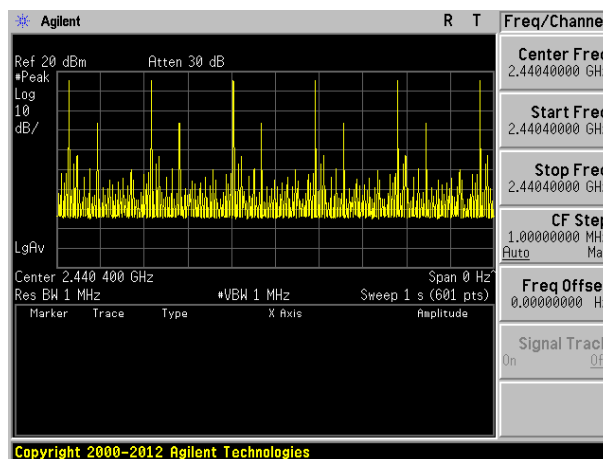

Ton times in 1s

Frequency: 2479.4MHz

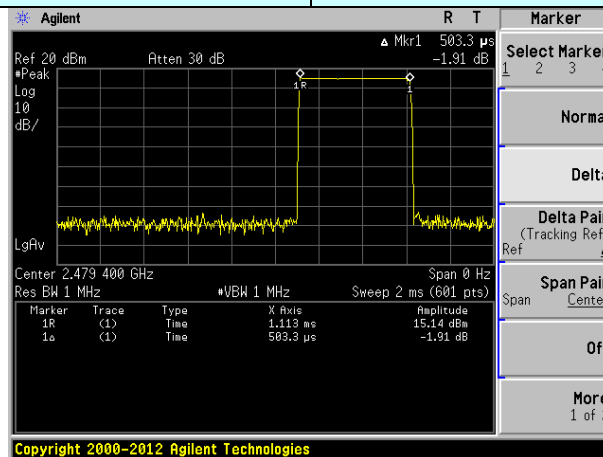

Ton

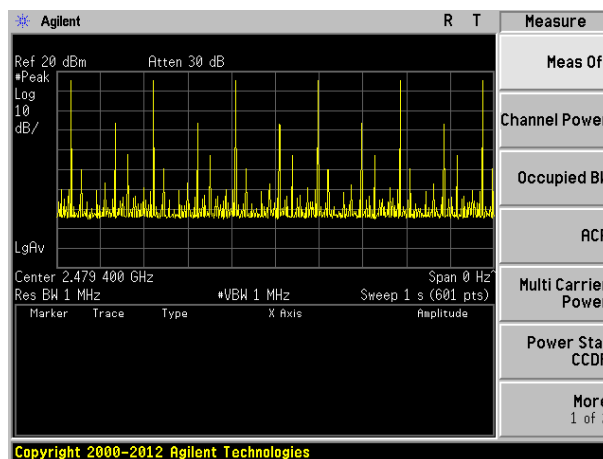

Ton times in 1s

7.7 Pseudorandom Frequency Hopping Sequence

Test Requirement:	FCC Part15 C Section 15.247 (a)(1) requirement:
<p>a(1): Frequency hopping systems shall have hopping channel carrier frequencies separated by a minimum of 25 kHz or the 20 dB bandwidth of the hopping channel, whichever is greater.</p> <p>Alternatively. Frequency hopping systems operating in the 2400-2483.5 MHz band may have hopping channel carrier frequencies that are separated by 25 kHz or two-thirds of the 20 dB bandwidth of the hopping channel, whichever is greater, provided the systems operate with an output power no greater than 125 mW. The system shall hop to channel frequencies that are selected at the system hopping rate from a Pseudorandom ordered list of hopping frequencies. Each frequency must be used equally on the average by each transmitter. The system receivers shall have input bandwidths that match the hopping channel bandwidths of their corresponding transmitters and shall shift frequencies in synchronization with the transmitted signals.</p> <p>(g) Frequency hopping spread spectrum systems are not required to employ all available hopping channels during each transmission. However, the system, consisting of both the transmitter and the receiver, must be designed to comply with all of the regulations in this section should the transmitter be presented with a continuous data (or information) stream. In addition, a system employing short transmission bursts must comply with the definition of a frequency hopping system and must distribute its transmissions over the minimum number of hopping channels specified in this section.</p> <p>(h) The incorporation of intelligence within a frequency hopping spread spectrum system that permits the system to recognize other users within the spectrum band so that it individually and independently chooses and adapts its hopsets to avoid hopping on occupied channels is permitted. The coordination of frequency hopping systems in any other manner for the express purpose of avoiding the simultaneous occupancy of individual hopping frequencies by multiple transmitters is not permitted.</p>	
<h3>EUT Pseudorandom Frequency Hopping Sequence</h3>	
<p>The pseudorandom sequence may be generated in a nine-stage shift register whose 5th and 9th stage outputs are added in a modulo-two addition stage. And the result is fed back to the input of the first stage. The sequence begins with the first ONE of 9 consecutive ONES; i.e. the shift register is initialized with nine ones.</p> <ul style="list-style-type: none"> • Number of shift register stages: 9 • Length of pseudo-random sequence: $2^9 - 1 = 511$ bits • Longest sequence of zeros: 8 (non-inverted signal) <div data-bbox="245 1272 1297 1420" style="text-align: center;"> </div> <p style="text-align: center;"><i>Linear Feedback Shift Register for Generation of the PRBS sequence</i></p> <p>An example of Pseudorandom Frequency Hopping Sequence as follow:</p> <div data-bbox="245 1525 1238 1675" style="text-align: center;"> </div> <p>Each frequency used equally on the average by each transmitter.</p> <p>The system receivers have input bandwidths that match the hopping channel bandwidths of their corresponding transmitters and shift frequencies in synchronization with the transmitted signals.</p> <p>it permits the system to recognize other users within the spectrum band so that it individually and independently chooses and adapts its hopsets to avoid hopping on occupied channels is permitted.</p>	

7.8 Band Edge

7.8.1 Conducted Emission Method

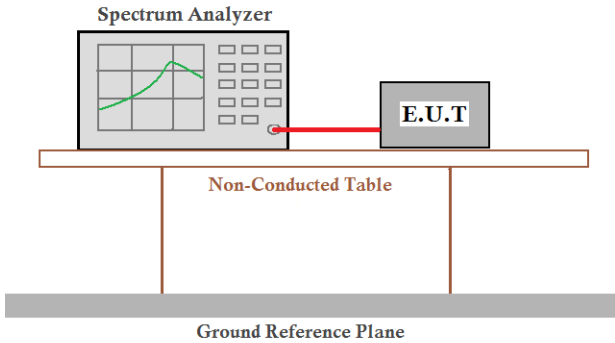
Test Requirement:	FCC Part15 C Section 15.247 (d)
Test Method:	ANSI C63.10:2013
Receiver setup:	RBW=100kHz, VBW=300kHz, Detector=Peak
Limit:	In any 100 kHz bandwidth outside the frequency band in which the spread spectrum intentional radiator is operating, the radio frequency power that is produced by the intentional radiator shall be at least 20 dB below that in the 100 kHz bandwidth within the band that contains the highest level of the desired power, based on either an RF conducted or a radiated measurement.
Test setup:	 <p>The diagram illustrates the test setup. A Spectrum Analyzer is connected to an E.U.T. (Equipment Under Test) via a red cable. Both are placed on a Non-Conducted Table, which is supported by a Ground Reference Plane.</p>
Test Instruments:	Refer to section6.0 for details
Test mode:	Refer to section 5.2 for details
Test results:	Pass

Test plot as follows:

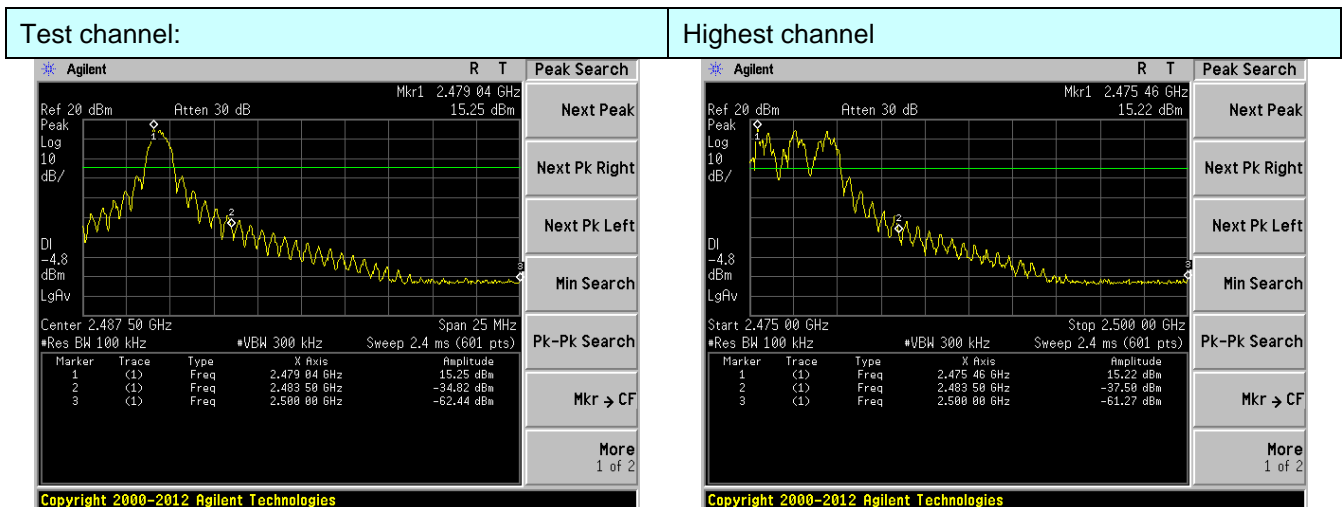
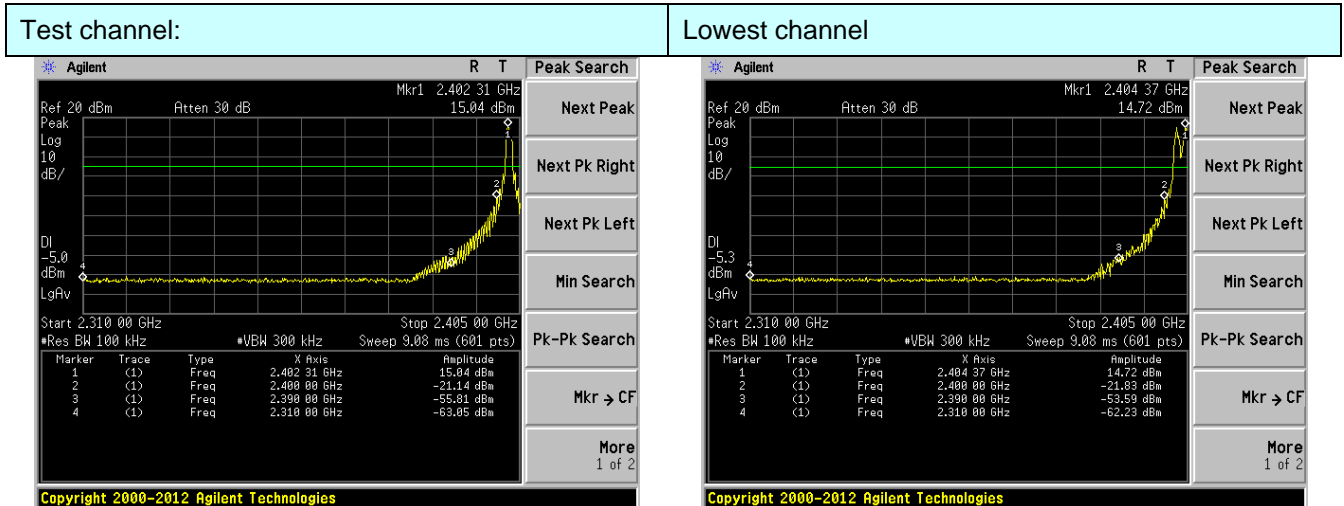

7.8.2 Radiated Emission Method

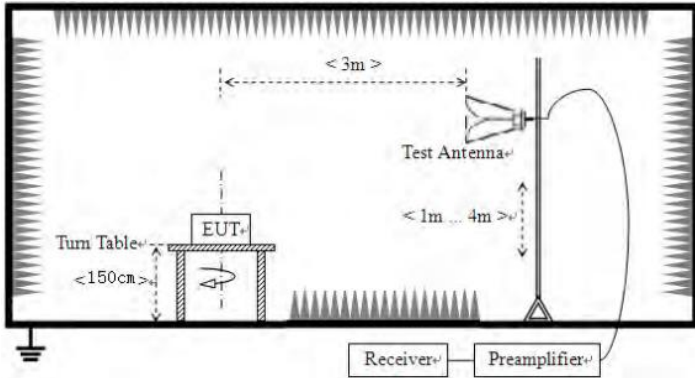
Test Requirement:	FCC Part15 C Section 15.209 and 15.205				
Test Method:	ANSI C63.10:2013				
Test Frequency Range:	All of the restrict bands were tested, only the worst band's (2310MHz to 2500MHz) data was showed.				
Test site:	Measurement Distance: 3m				
Receiver setup:	Frequency	Detector	RBW	VBW	Remark
	Above 1GHz	Peak	1MHz	3MHz	Peak Value
		Peak	1MHz	10Hz	Average Value
Limit:	Frequency		Limit (dBuV/m @3m)		Remark
	Above 1GHz		54.00		Average Value
			74.00		Peak Value
Test setup:					
Test Procedure:	<ol style="list-style-type: none"> 1. The EUT was placed on the top of a rotating table 1.5 meters above the ground at a 3 meter camber. The table was rotated 360 degrees to determine the position of the highest radiation. 2. The EUT was set 3 meters away from the interference-receiving antenna, which was mounted on the top of a variable-height antenna tower. 3. The antenna height is varied from one meter to four meters above the ground to determine the maximum value of the field strength. Both horizontal and vertical polarizations of the antenna are set to make the measurement. 4. For each suspected emission, the EUT was arranged to its worst case and then the antenna was tuned to heights from 1 meter to 4 meters and the rota table was turned from 0 degrees to 360 degrees to find the maximum reading. 5. The test-receiver system was set to Peak Detect Function and Specified Bandwidth with Maximum Hold Mode. 6. If the emission level of the EUT in peak mode was 10dB lower than the limit specified, then testing could be stopped and the peak values of the EUT would be reported. Otherwise the emissions that did not have 10dB margin would be re-tested one by one using peak, quasi-peak or average method as specified and then reported in a data sheet. 				
Test Instruments:	Refer to section 6.0 for details				
Test mode:	Refer to section 5.2 for details				
Temp. / Hum.	Temp.:	25 °C	Humid.:	52%	Press.: 1 012mbar
Test results:	Pass				

Measurement Data

Remark:

1. Pre-scan all kind of the place mode (X-axis, Y-axis, Z-axis), and found the Y-axis which it is worse case.

Test channel:	Lowest	Polarization:	Vertical
---------------	--------	---------------	----------

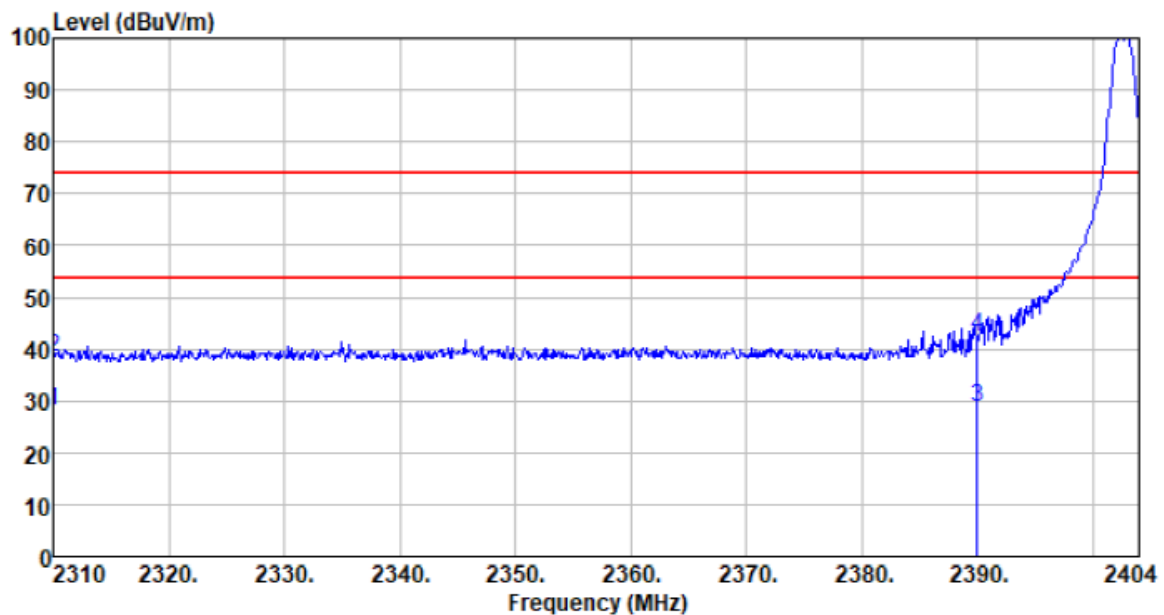

Freq MHz	Reading level dBuV	Antenna factor dB/m	Cable loss dB	Preamp factor dB	level dBuV/m	Limit level dBuV/m	Over limit dB	Remark
2310.000	28.59	27.14	2.81	30.43	28.11	54.00	-25.89	Average
2310.000	38.88	27.14	2.81	30.43	38.40	74.00	-35.60	Peak
2390.000	28.75	27.37	2.91	30.24	28.79	54.00	-25.21	Average
2390.000	42.45	27.37	2.91	30.24	42.49	74.00	-31.51	Peak

Test channel:	Lowest	Polarization:	Horizontal
---------------	--------	---------------	------------

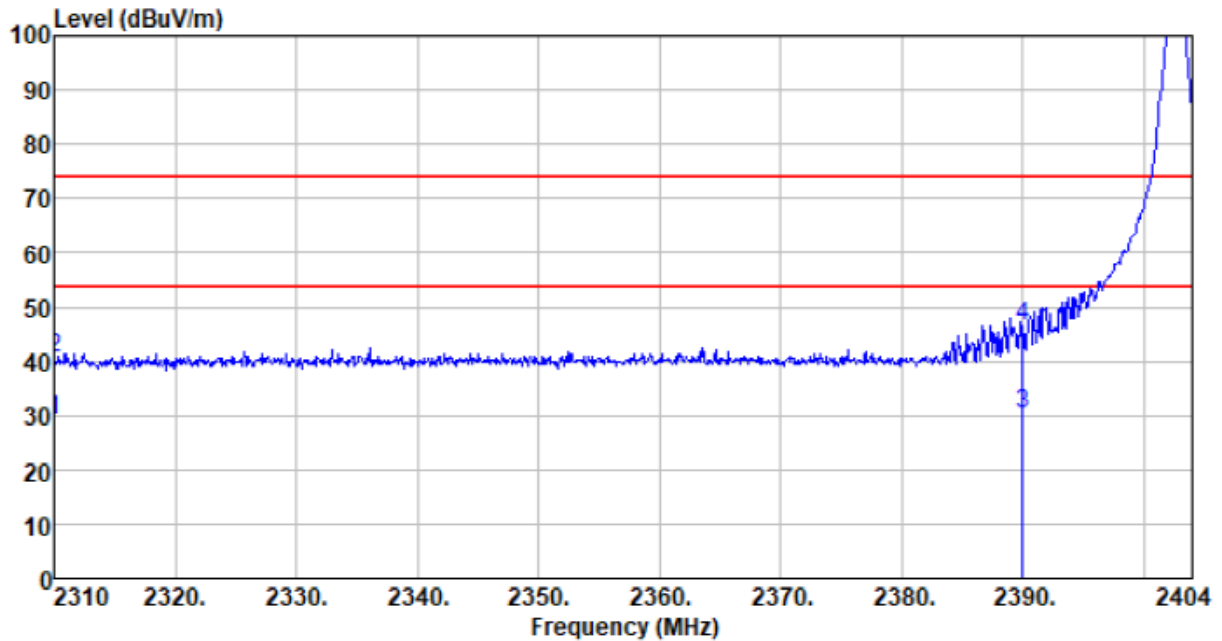

Freq MHz	Reading level dBuV	Antenna factor dB/m	Cable loss dB	Preamp factor dB	level dBuV/m	Limit level dBuV/m	Over limit dB	Remark
2310.000	29.63	27.14	2.81	30.43	29.15	54.00	-24.85	Average
2310.000	41.04	27.14	2.81	30.43	40.56	74.00	-33.44	Peak
2390.000	30.04	27.37	2.91	30.24	30.08	54.00	-23.92	Average
2390.000	46.63	27.37	2.91	30.24	46.67	74.00	-27.33	Peak

Test channel:	Highest	Polarization:	Vertical
---------------	---------	---------------	----------

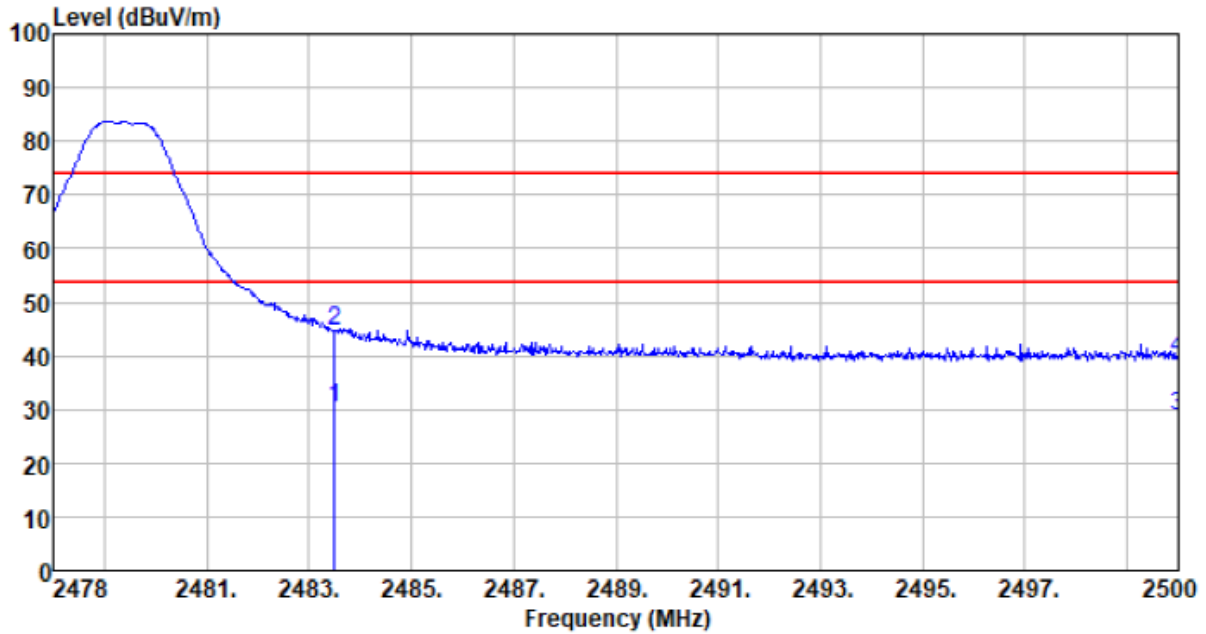

Freq MHz	Reading level dBuV	Antenna factor dB/m	Cable loss dB	Preamp factor dB	level dBuV/m	Limit level dBuV/m	Over limit dB	Remark
2483.500	29.58	27.66	2.99	30.12	30.11	54.00	-23.89	Average
2483.500	44.29	27.66	2.99	30.12	44.82	74.00	-29.18	Peak
2500.000	28.05	27.70	3.01	30.13	28.63	54.00	-25.37	Average
2500.000	39.01	27.70	3.01	30.13	39.59	74.00	-34.41	Peak

Test channel:	Highest	Polarization:	Horizontal
---------------	---------	---------------	------------

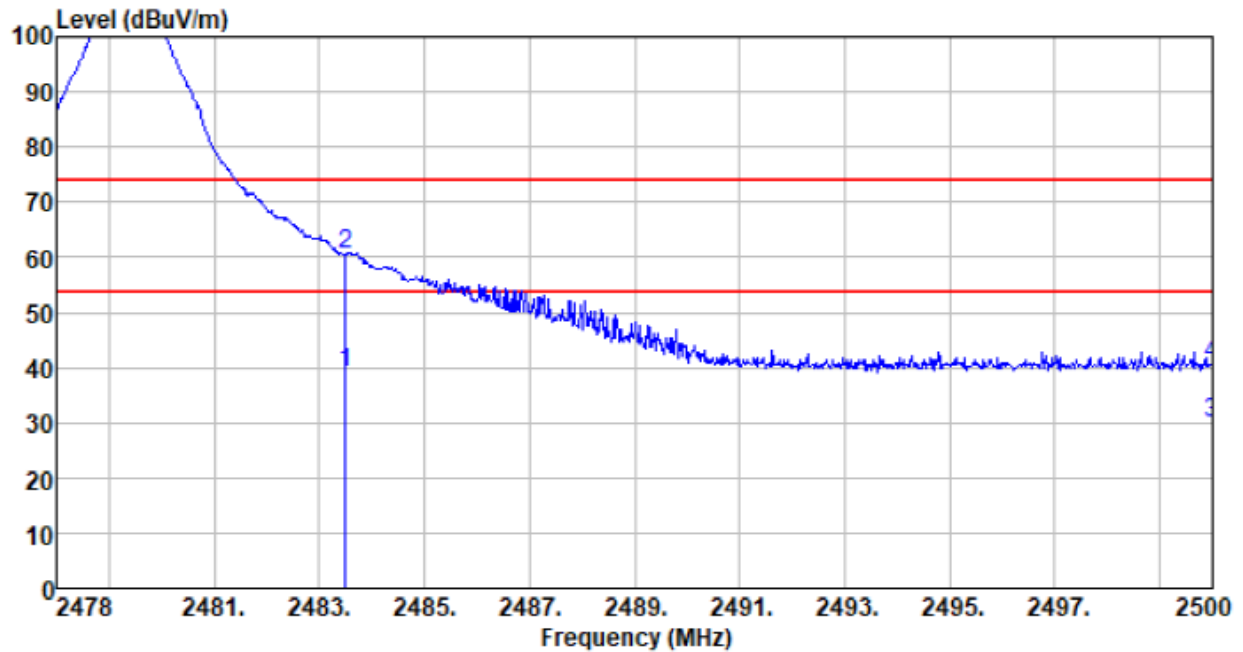

Freq MHz	Reading level dBuV	Antenna factor dB/m	Cable loss dB	Preamp factor dB	level dBuV/m	Limit level dBuV/m	Over limit dB	Remark
2483.500	38.68	27.66	2.99	30.12	39.21	54.00	-14.79	Average
2483.500	60.07	27.66	2.99	30.12	60.60	74.00	-13.40	Peak
2500.000	29.30	27.70	3.01	30.13	29.88	54.00	-24.12	Average
2500.000	39.98	27.70	3.01	30.13	40.56	74.00	-33.44	Peak

Remark:

1. Final Level = Receiver Read level + Antenna Factor + Cable Loss – Pre-amplifier Factor
2. The emission levels of other frequencies are very lower than the limit and not show in test report.

7.9 Spurious Emission

7.9.1 Conducted Emission Method

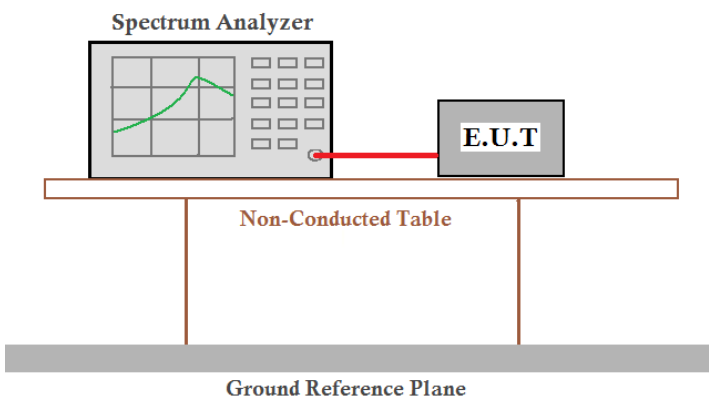
Test Requirement:	FCC Part15 C Section 15.247 (d)
Test Method:	ANSI C63.10:2013
Limit:	In any 100 kHz bandwidth outside the frequency band in which the spread spectrum intentional radiator is operating, the radio frequency power that is produced by the intentional radiator shall be at least 20 dB below that in the 100 kHz bandwidth within the band that contains the highest level of the desired power, based on either an RF conducted or a radiated measurement.
Test setup:	 <p>The diagram illustrates the test setup. A Spectrum Analyzer is connected to an E.U.T. (Equipment Under Test) via a red cable. Both are placed on a Non-Conducted Table, which is supported by a Ground Reference Plane.</p>
Test Instruments:	Refer to section 6.0 for details
Test mode:	Refer to section 5.2 for details
Test results:	Pass

Lowest channel

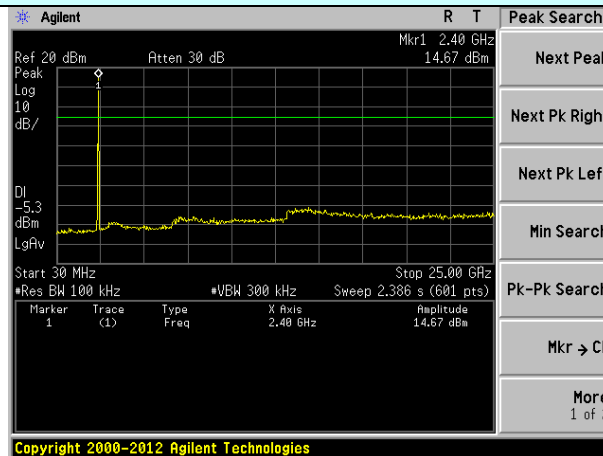

30MHz~25GHz

Middle channel

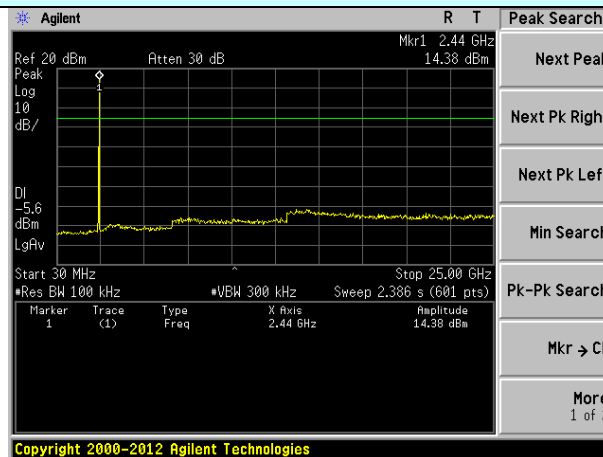

30MHz~25GHz

Highest channel

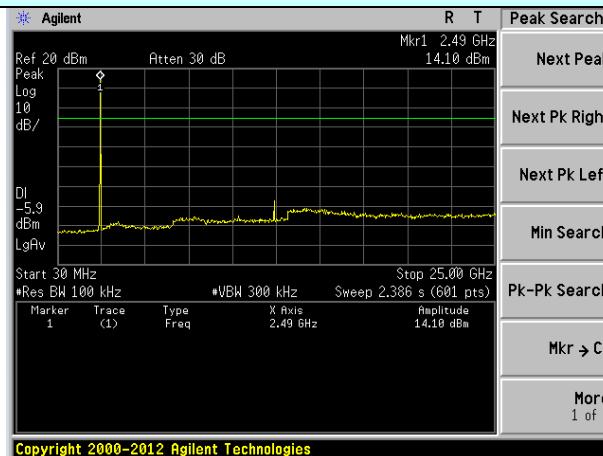

30MHz~25GHz

7.9.2 Radiated Emission Method

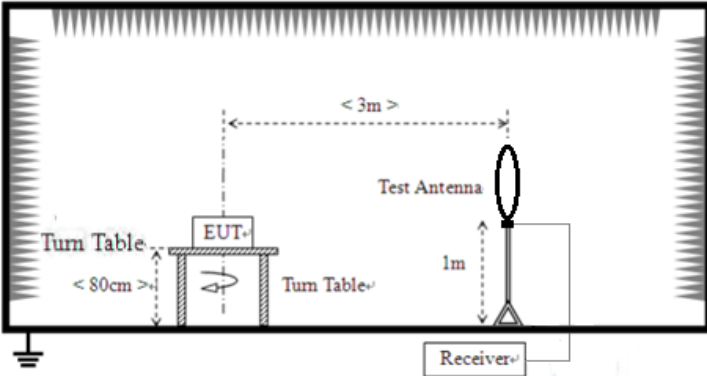
Test Requirement:	FCC Part15 C Section 15.209				
Test Method:	ANSI C63.10:2013				
Test Frequency Range:	9kHz to 25GHz				
Test site:	Measurement Distance: 3m				
Receiver setup:	Frequency	Detector	RBW	VBW	Value
	9KHz-150KHz	Quasi-peak	200Hz	600Hz	Quasi-peak
	150KHz-30MHz	Quasi-peak	9KHz	30KHz	Quasi-peak
	30MHz-1GHz	Quasi-peak	120KHz	300KHz	Quasi-peak
	Above 1GHz	Peak	1MHz	3MHz	Peak
Peak		1MHz	10Hz	Average	
Limit: (Spurious Emissions)	Frequency	Limit (uV/m)	Value	Measurement Distance	
	0.009MHz-0.490MHz	2400/F(KHz)	QP	300m	
	0.490MHz-1.705MHz	24000/F(KHz)	QP	30m	
	1.705MHz-30MHz	30	QP	30m	
	30MHz-88MHz	100	QP	3m	
	88MHz-216MHz	150	QP		
	216MHz-960MHz	200	QP		
	960MHz-1GHz	500	QP		
	Above 1GHz	500	Average		
5000		Peak			
Test setup:	Below 30MHz				
	 <p>Below 1GHz</p>				

	<p>Above 1GHz</p>						
<p>Test Procedure:</p>	<ol style="list-style-type: none"> 1. The EUT was placed on the top of a rotating table (0.8 meters for below 1GHz and 1.5meters for above 1GHz) above the ground at a 3 meter camber. The table was rotated 360 degrees to determine the position of the highest radiation. 2. The EUT was set 3 meters away from the interference-receiving antenna, which was mounted on the top of a variable-height antenna tower. 3. The antenna height is varied from one meter to four meters above the ground to determine the maximum value of the field strength. Both horizontal and vertical polarizations of the antenna are set to make the measurement. 4. For each suspected emission, the EUT was arranged to its worst case and then the antenna was tuned to heights from 1 meter to 4 meters and the rota table was turned from 0 degrees to 360 degrees to find the maximum reading. 5. The test-receiver system was set to Peak Detect Function and Specified Bandwidth with Maximum Hold Mode. 6. If the emission level of the EUT in peak mode was 10dB lower than the limit specified, then testing could be stopped and the peak values of the EUT would be reported. Otherwise the emissions that did not have 10dB margin would be re-tested one by one using peak, quasi-peak or average method as specified and then reported in a data sheet. 						
<p>Test Instruments:</p>	<p>Refer to section 5.8 for details</p>						
<p>Test mode:</p>	<p>Refer to section 5.2 for details</p>						
<p>Temp. / Hum.</p>	<table border="1"> <tr> <td>Temp.:</td> <td>25 °C</td> <td>Humid.:</td> <td>52%</td> <td>Press.:</td> <td>1 012mbar</td> </tr> </table>	Temp.:	25 °C	Humid.:	52%	Press.:	1 012mbar
Temp.:	25 °C	Humid.:	52%	Press.:	1 012mbar		

Test results:	Pass
---------------	------

Remark:

1. Pre-scan all kind of the place mode (X-axis, Y-axis, Z-axis), and found the Y-axis which it is worse case.

Measurement data:

■ **Below 30MHz**

The low frequency, which started from 9 kHz to 30 MHz, was pre-scanned and the result which was 20 dB lower than the limit line per 15.31(o) was not reported.

■ 30MHz ~ 1GHz

Test channel:	Lowest	Polarization:	Vertical
---------------	--------	---------------	----------

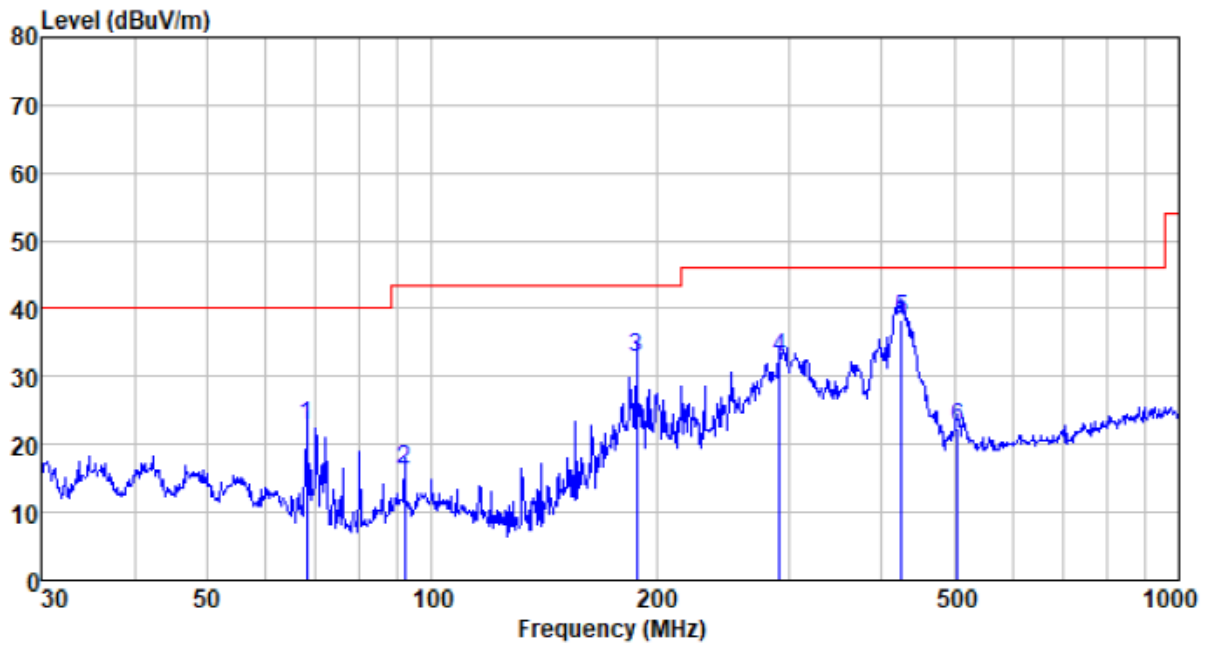

Freq MHz	Reading level dBuV	Antenna factor dB/m	Cable loss dB	Preamp factor dB	level dBuV/m	Limit level dBuV/m	Over limit dB	Remark
67.913	49.92	8.31	0.92	36.42	22.73	40.00	-17.27	QP
91.816	40.68	10.97	1.12	36.65	16.12	43.50	-27.38	QP
187.753	58.62	9.65	1.78	37.27	32.78	43.50	-10.72	QP
292.058	54.34	13.38	2.32	37.41	32.63	46.00	-13.37	QP
425.028	56.93	15.87	2.97	37.52	38.25	46.00	-7.75	QP
504.706	39.25	17.41	3.33	37.51	22.48	46.00	-23.52	QP

Test channel:	Lowest	Polarization:	Horizontal
---------------	--------	---------------	------------

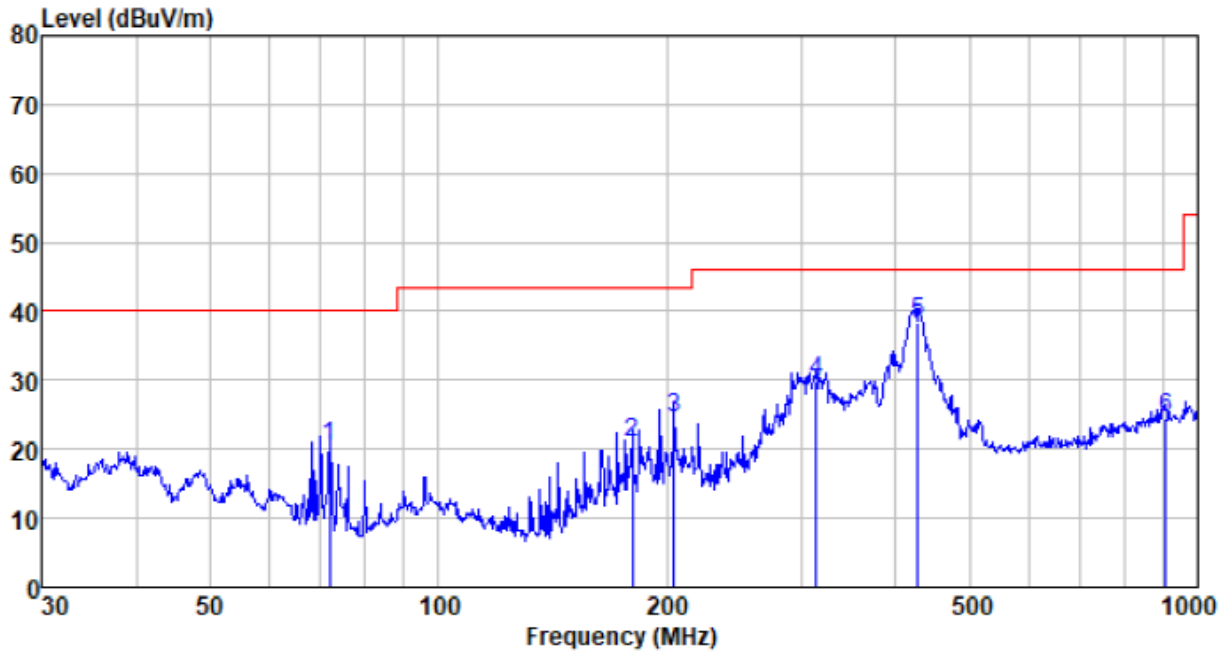

Freq MHz	Reading level dBUV	Antenna factor dB/m	Cable loss dB	Preamp factor dB	level dBUV/m	Limit level dBUV/m	Over limit dB	Remark
71.832	48.26	7.48	0.96	36.46	20.24	40.00	-19.76	QP
180.017	47.43	8.90	1.74	37.24	20.83	43.50	-22.67	QP
204.238	49.42	10.58	1.86	37.33	24.53	43.50	-18.97	QP
314.377	50.80	13.87	2.44	37.44	29.67	46.00	-16.33	QP
428.019	57.00	15.91	2.99	37.52	38.38	46.00	-7.62	QP
906.482	34.90	22.32	4.88	37.59	24.51	46.00	-21.49	QP

Test channel:	Middle	Polarziation:	Vertical
---------------	--------	---------------	----------

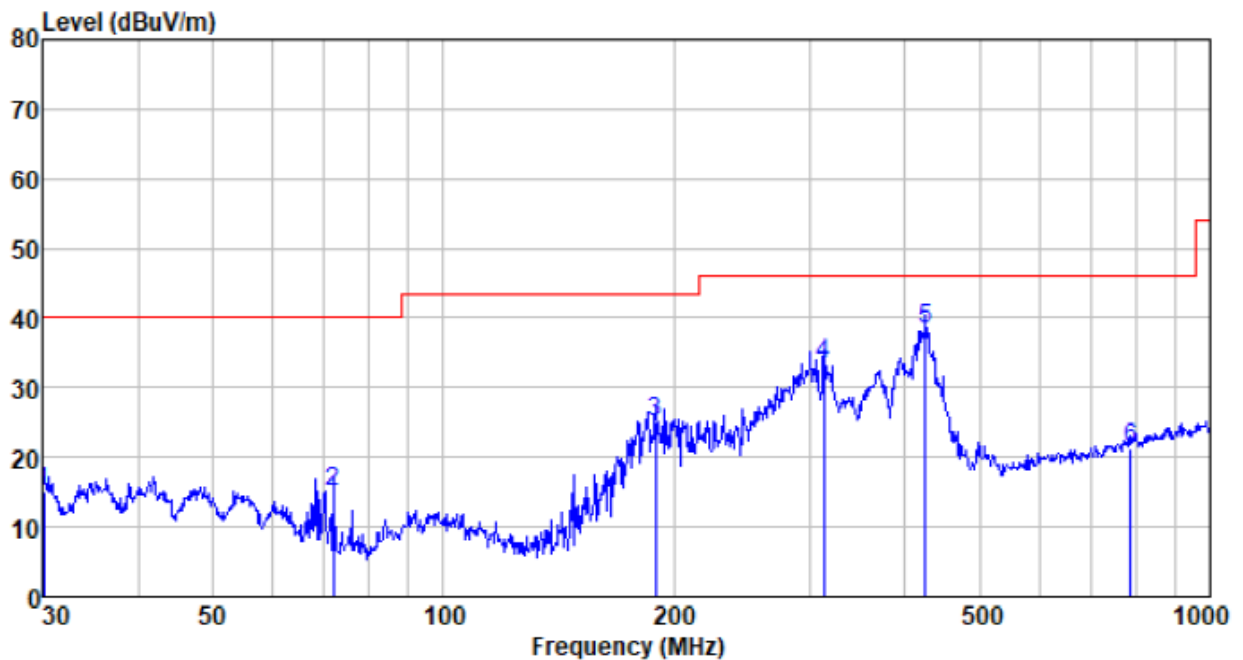

Freq MHz	Reading level dBuV	Antenna factor dB/m	Cable loss dB	Preamp factor dB	level dBuV/m	Limit level dBuV/m	Over limit dB	Remark
30.105	38.38	11.20	0.55	35.01	15.12	40.00	-24.88	QP
71.832	43.21	7.48	0.96	36.46	15.19	40.00	-24.81	QP
189.074	50.78	9.82	1.78	37.28	25.10	43.50	-18.40	QP
313.276	54.45	13.85	2.43	37.44	33.29	46.00	-12.71	QP
425.028	57.07	15.87	2.97	37.52	38.39	46.00	-7.61	QP
787.851	33.16	21.21	4.41	37.62	21.16	46.00	-24.84	QP

Test channel:	Middle	Polarization:	Horizontal
---------------	--------	---------------	------------

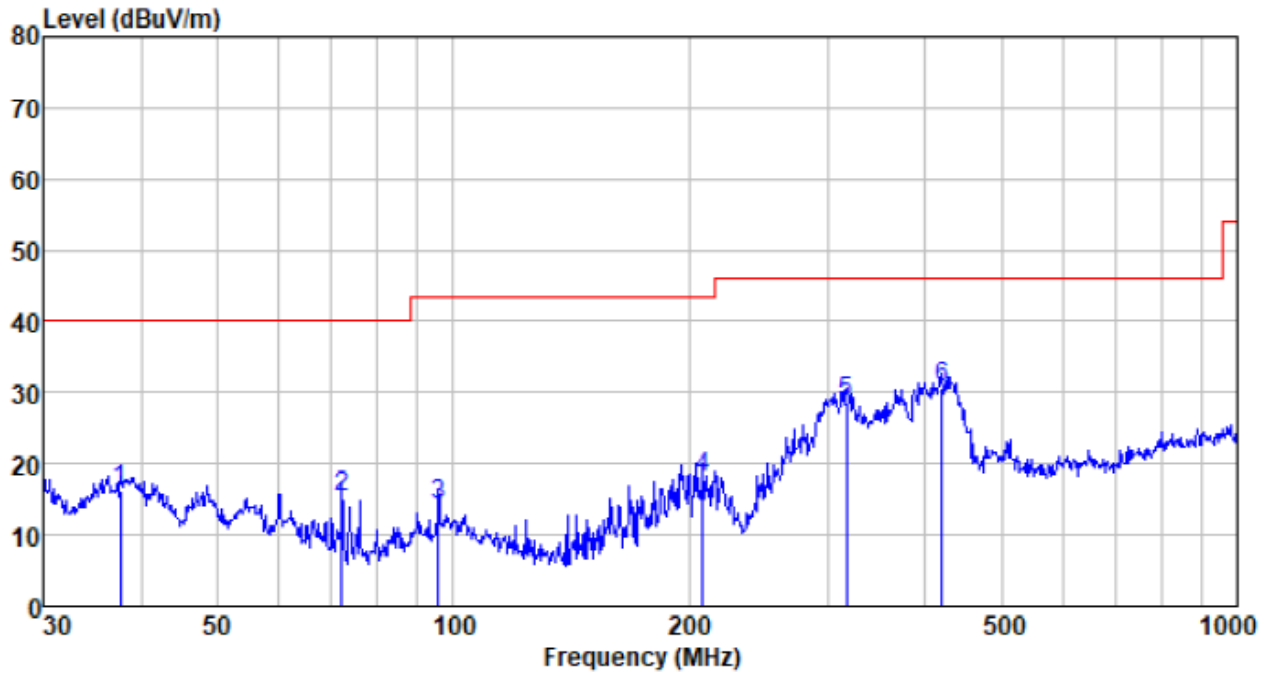

Freq MHz	Reading level dBuV	Antenna factor dB/m	Cable loss dB	Preamp factor dB	level dBuV/m	Limit level dBuV/m	Over limit dB	Remark
37.680	39.35	11.80	0.64	35.53	16.26	40.00	-23.74	QP
72.084	43.44	7.48	0.96	36.46	15.42	40.00	-24.58	QP
95.762	38.16	11.59	1.16	36.69	14.22	43.50	-29.28	QP
207.850	42.84	10.69	1.89	37.34	18.08	43.50	-25.42	QP
317.701	49.65	13.93	2.45	37.44	28.59	46.00	-17.41	QP
420.580	49.62	15.75	2.95	37.52	30.80	46.00	-15.20	QP

Test channel:	Highest	Polarization:	Vertical
---------------	---------	---------------	----------

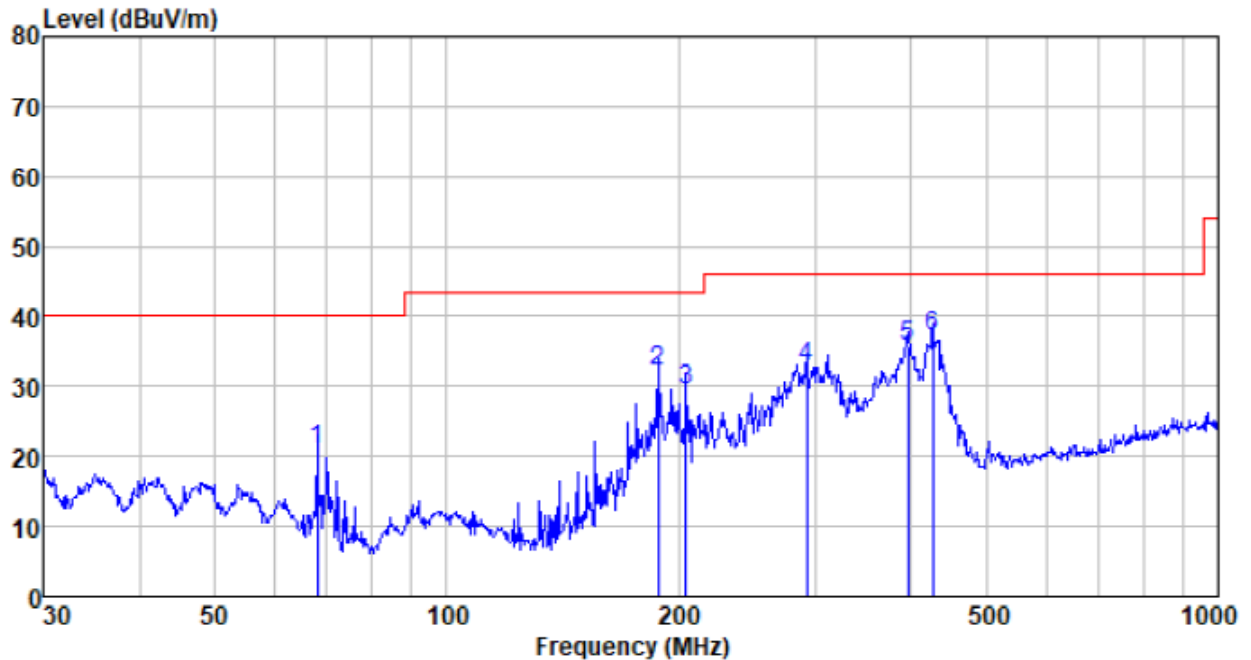

Freq MHz	Reading level dBUV	Antenna factor dB/m	Cable loss dB	Preamp factor dB	level dBUV/m	Limit level dBUV/m	Over limit dB	Remark
67.913	48.26	8.31	0.92	36.42	21.07	40.00	-18.93	QP
187.753	57.90	9.65	1.78	37.27	32.06	43.50	-11.44	QP
204.238	54.45	10.58	1.86	37.33	29.56	43.50	-13.94	QP
293.084	54.47	13.42	2.32	37.41	32.80	46.00	-13.20	QP
396.242	55.26	15.25	2.83	37.52	35.82	46.00	-10.18	QP
426.521	55.74	15.87	2.98	37.52	37.07	46.00	-8.93	QP

Test channel:	Highest	Polarization:	Horizontal
---------------	---------	---------------	------------

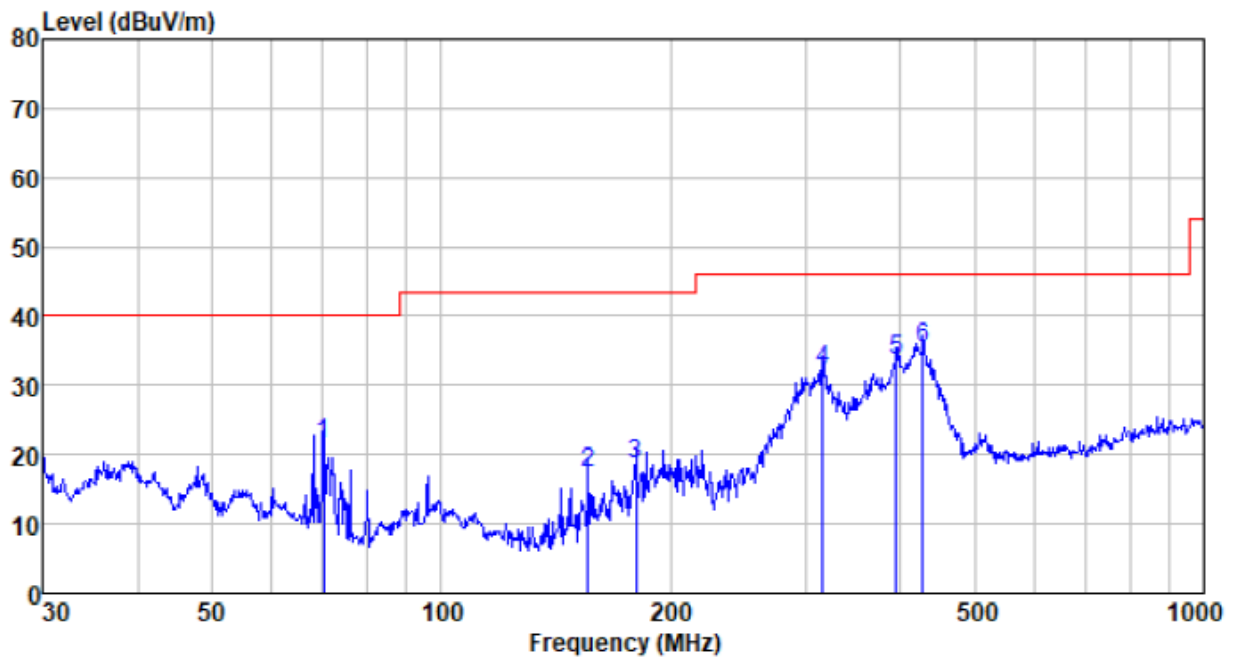

Freq MHz	Reading level dBuV	Antenna factor dB/m	Cable loss dB	Preamp factor dB	level dBuV/m	Limit level dBuV/m	Over limit dB	Remark
70.090	49.50	7.50	0.94	36.44	21.50	40.00	-18.50	QP
155.910	45.01	8.05	1.60	37.11	17.55	43.50	-25.95	QP
180.017	45.16	8.90	1.74	37.24	18.56	43.50	-24.94	QP
316.589	53.18	13.93	2.45	37.44	32.12	46.00	-13.88	QP
394.855	52.98	15.25	2.83	37.52	33.54	46.00	-12.46	QP
428.019	53.96	15.91	2.99	37.52	35.34	46.00	-10.66	QP

■ Above 1GHz

Test channel:	Lowest	Polarization:	Vertical
---------------	--------	---------------	----------

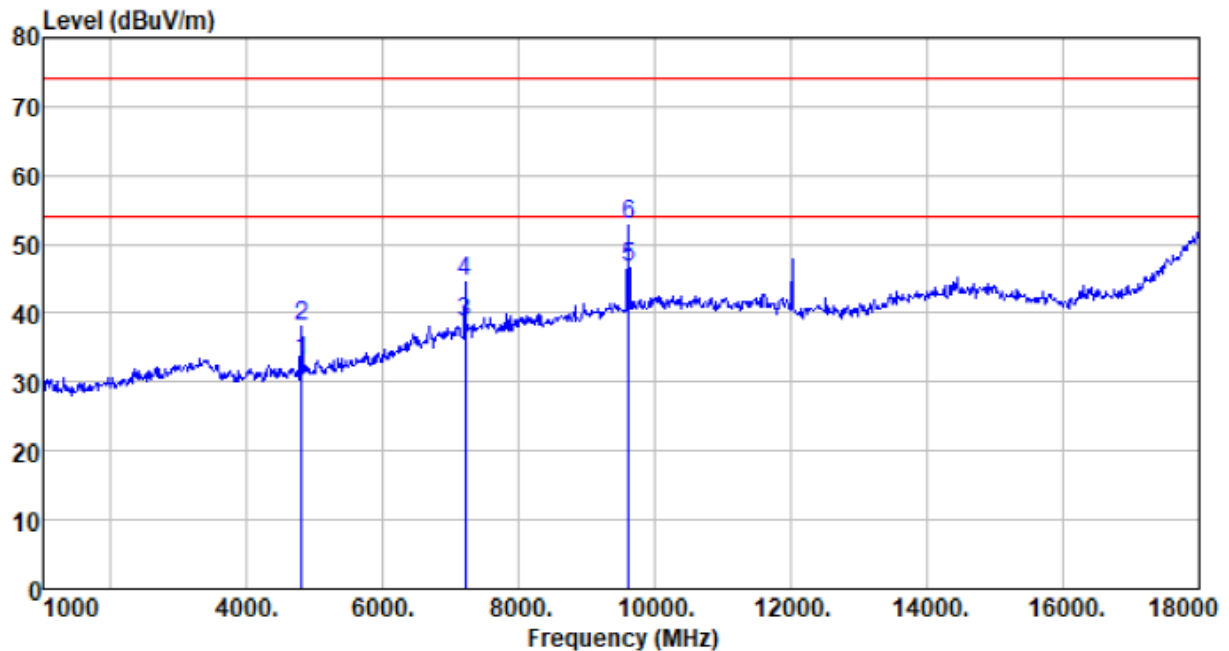

Freq MHz	Reading level dBuV	Antenna factor dB/m	Cable loss dB	Preamp factor dB	level dBuV/m	Limit level dBuV/m	Over limit dB	Remark
4804.300	34.93	31.20	4.61	37.73	33.01	54.00	-20.99	Average
4804.300	40.09	31.20	4.61	37.73	38.17	74.00	-35.83	Peak
7206.450	31.52	36.16	6.48	35.63	38.53	54.00	-15.47	Average
7206.450	37.53	36.16	6.48	35.63	44.54	74.00	-29.46	Peak
9608.600	35.64	37.93	7.97	34.94	46.60	54.00	-7.40	Average
9608.600	42.01	37.93	7.97	34.94	52.97	74.00	-21.03	Peak

Test channel:	Lowest	Polarization:	Horizontal
---------------	--------	---------------	------------

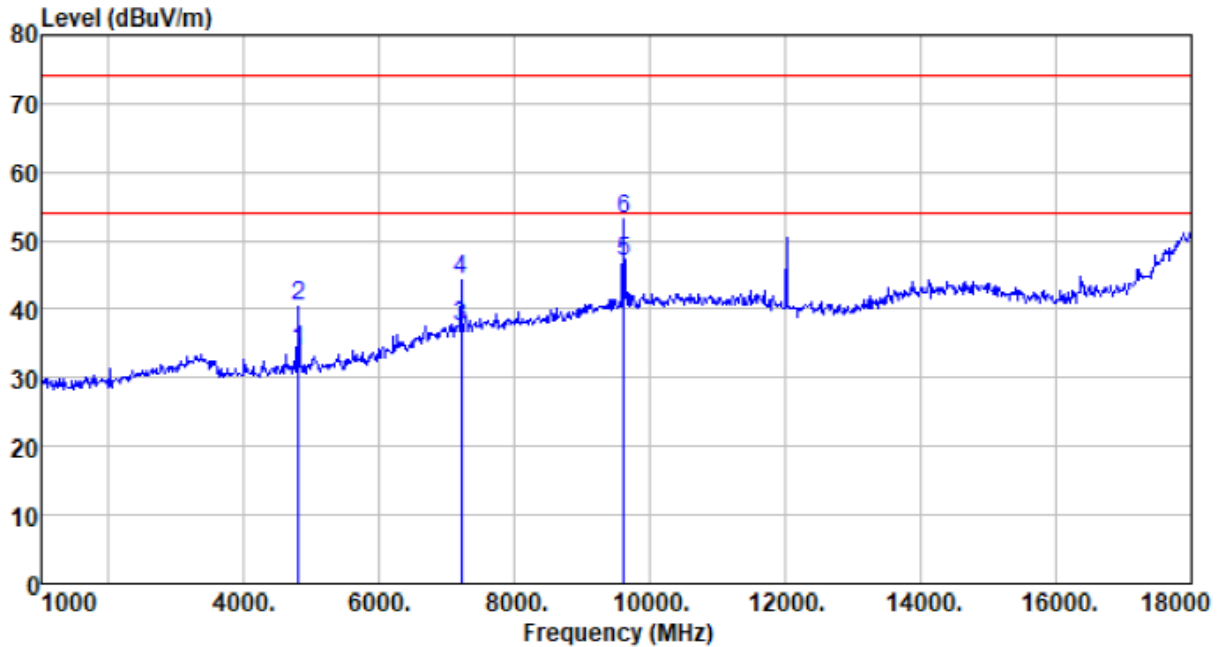

Freq MHz	Reading level dBuV	Antenna factor dB/m	Cable loss dB	Preamp factor dB	level dBuV/m	Limit level dBuV/m	Over limit dB	Remark
4804.300	35.93	31.20	4.61	37.73	34.01	54.00	-19.99	Average
4804.300	42.24	31.20	4.61	37.73	40.32	74.00	-33.68	Peak
7206.450	30.35	36.16	6.48	35.63	37.36	54.00	-16.64	Average
7206.450	37.14	36.16	6.48	35.63	44.15	74.00	-29.85	Peak
9608.600	35.84	37.93	7.97	34.94	46.80	54.00	-7.20	Average
9608.600	42.11	37.93	7.97	34.94	53.07	74.00	-20.93	Peak

Test channel:	Middle	Polarization:	Vertical
---------------	--------	---------------	----------

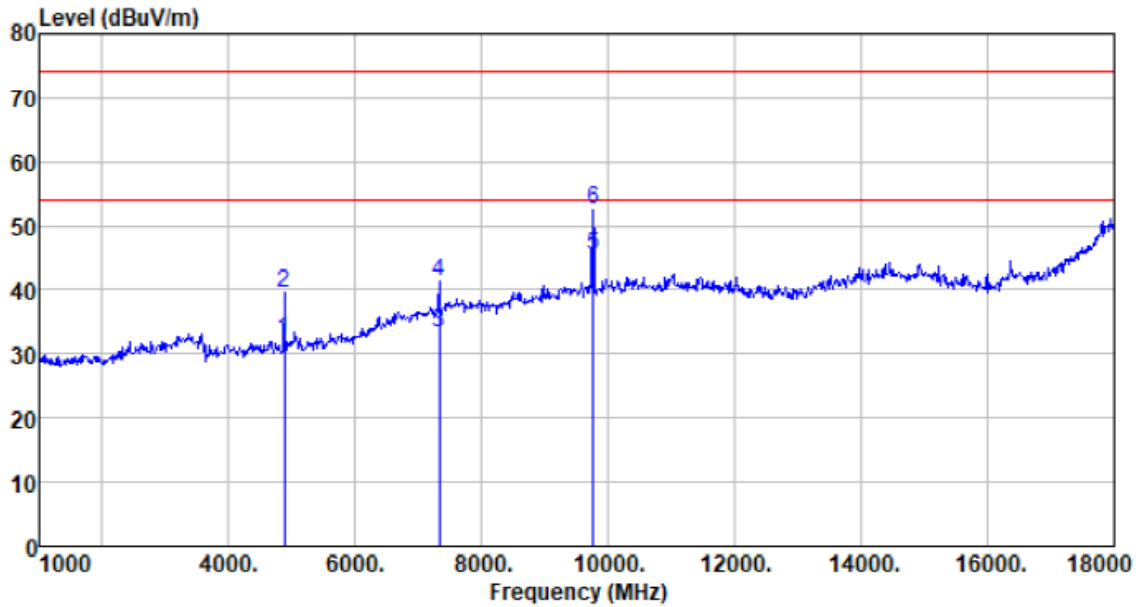

Freq MHz	Reading level dBuV	Antenna factor dB/m	Cable loss dB	Preamp factor dB	level dBuV/m	Limit level dBuV/m	Over limit dB	Remark
4880.800	34.02	31.31	4.69	37.75	32.27	54.00	-21.73	Average
4880.800	41.44	31.31	4.69	37.75	39.69	74.00	-34.31	Peak
7321.200	26.02	36.43	6.63	35.60	33.48	54.00	-20.52	Average
7321.200	33.89	36.43	6.63	35.60	41.35	74.00	-32.65	Peak
9761.600	34.24	38.10	8.03	35.03	45.34	54.00	-8.66	Average
9761.600	41.30	38.10	8.03	35.03	52.40	74.00	-21.60	Peak

Test channel:	Middle	Polarization:	Horizontal
---------------	--------	---------------	------------

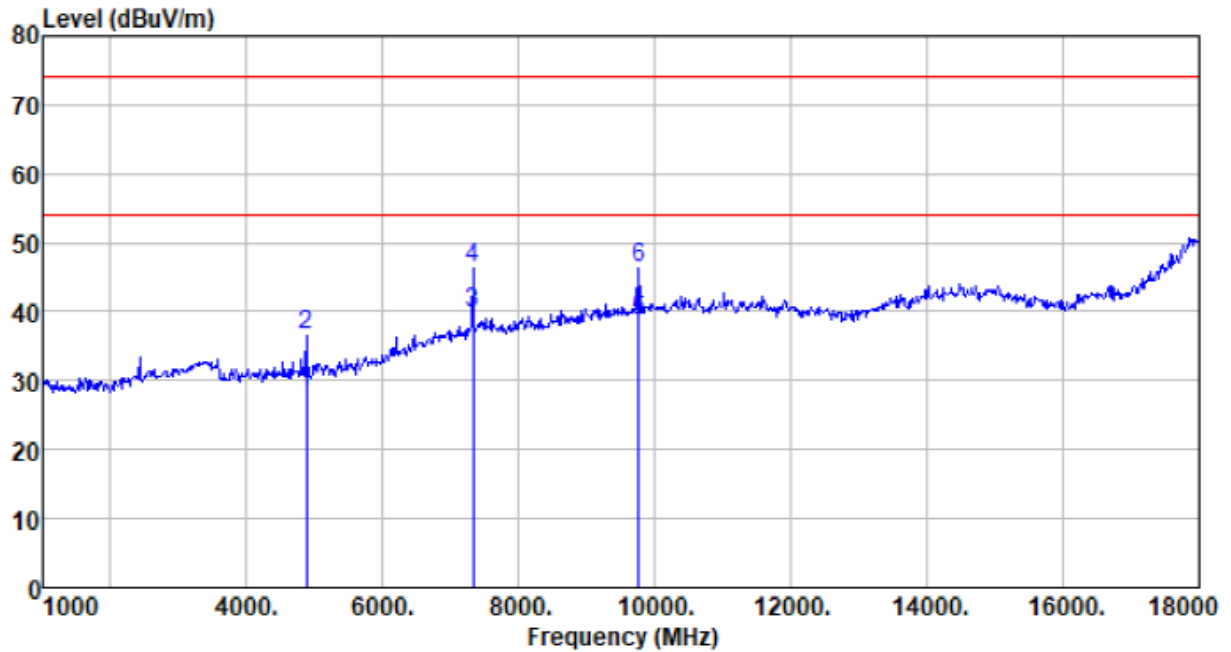

Freq MHz	Reading level dBuV	Antenna factor dB/m	Cable loss dB	Preamp factor dB	level dBuV/m	Limit level dBuV/m	Over limit dB	Remark
4880.800	30.04	31.31	4.69	37.75	28.29	54.00	-25.71	Average
4880.800	38.42	31.31	4.69	37.75	36.67	74.00	-37.33	Peak
7321.200	32.33	36.43	6.63	35.60	39.79	54.00	-14.21	Average
7321.200	38.82	36.43	6.63	35.60	46.28	74.00	-27.72	Peak
9761.600	27.51	38.10	8.03	35.03	38.61	54.00	-15.39	Average
9761.600	35.35	38.10	8.03	35.03	46.45	74.00	-27.55	Peak

Test channel:	Highest	Polarization:	Vertical
---------------	---------	---------------	----------

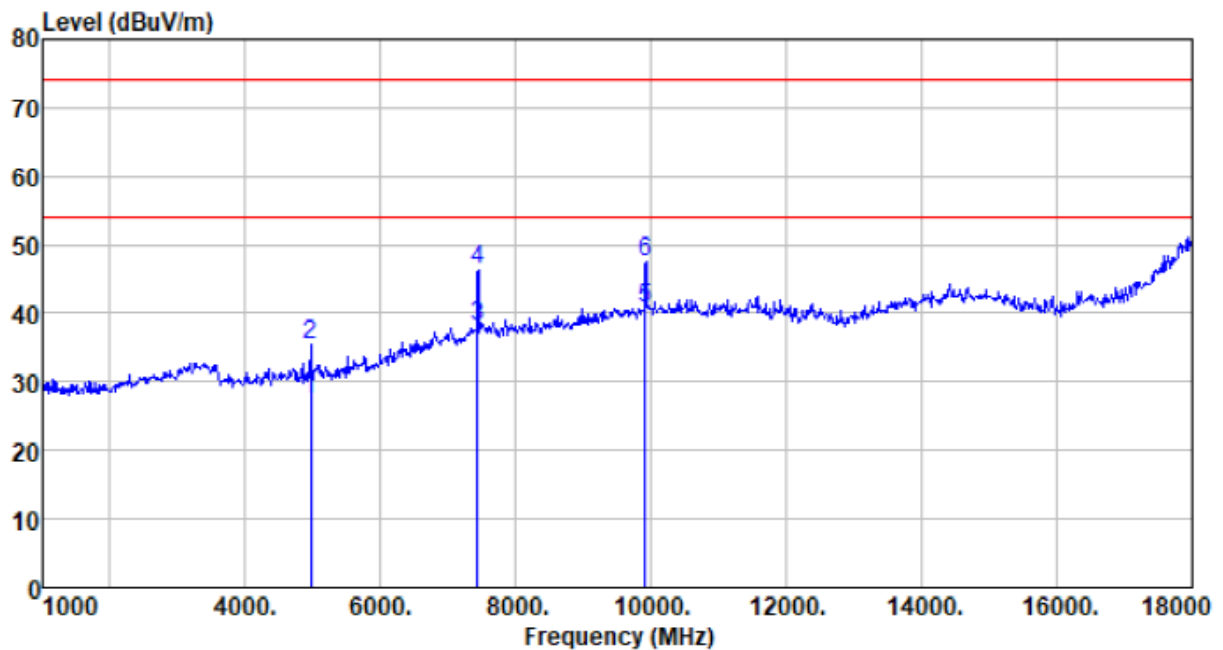

Freq MHz	Reading level dBuV	Antenna factor dB/m	Cable loss dB	Preamp factor dB	level dBuV/m	Limit level dBuV/m	Over limit dB	Remark
4958.800	29.00	31.44	4.79	37.78	27.45	54.00	-26.55	Average
4958.800	37.02	31.44	4.79	37.78	35.47	74.00	-38.53	Peak
7438.200	30.26	36.66	6.77	35.56	38.13	54.00	-15.87	Average
7438.200	38.39	36.66	6.77	35.56	46.26	74.00	-27.74	Peak
9917.600	29.52	38.30	8.09	35.14	40.77	54.00	-13.23	Average
9917.600	36.17	38.30	8.09	35.14	47.42	74.00	-26.58	Peak

Test channel:	Highest	Polarization:	Horizontal
---------------	---------	---------------	------------

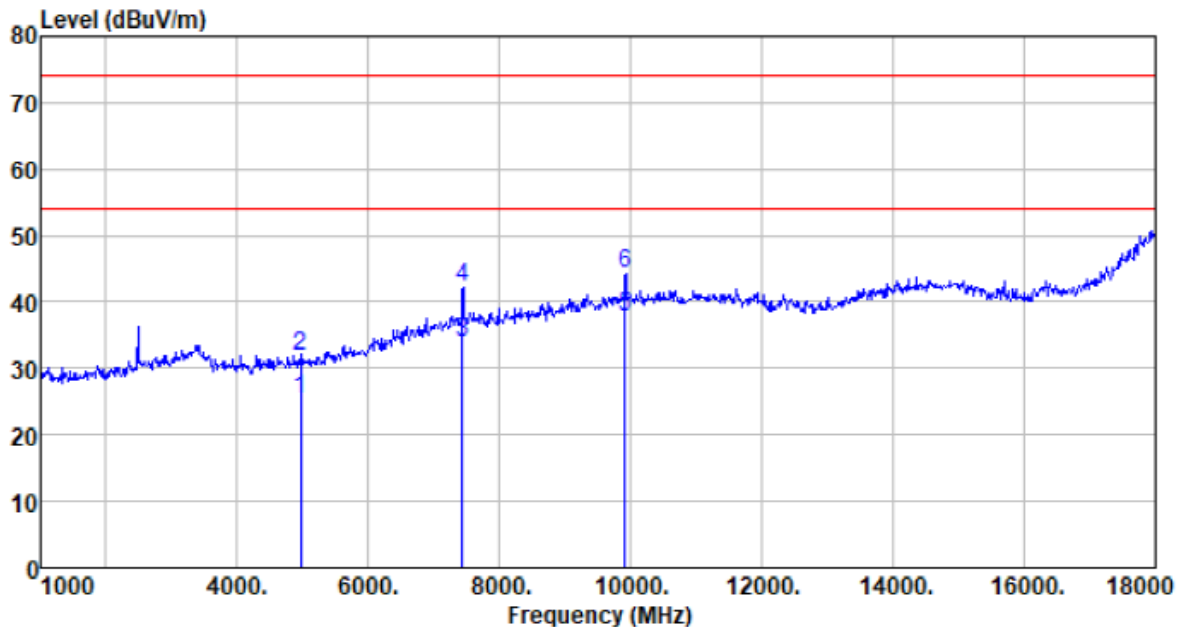

Freq MHz	Reading level dBuV	Antenna factor dB/m	Cable loss dB	Preamp factor dB	level dBuV/m	Limit level dBuV/m	Over limit dB	Remark
4958.800	27.03	31.44	4.79	37.78	25.48	54.00	-28.52	Average
4958.800	33.41	31.44	4.79	37.78	31.86	74.00	-42.14	Peak
7438.200	26.04	36.66	6.77	35.56	33.91	54.00	-20.09	Average
7438.200	34.41	36.66	6.77	35.56	42.28	74.00	-31.72	Peak
9917.600	26.65	38.30	8.09	35.14	37.90	54.00	-16.10	Average
9917.600	33.05	38.30	8.09	35.14	44.30	74.00	-29.70	Peak

Remark:

1. *Final Level = Receiver Read level + Antenna Factor + Cable Loss – Preamplifier Factor*
2. *No emission found in frequency above 18GHz.*

8 Test Setup Photo

Reference to the **appendix I** for details.

9 EUT Constructional Details

Reference to the **appendix II** for details.

---End---