



RADIO TEST REPORT

Test Report No. : 14007298H-B-R1

Applicant : Honda Motor Co., Ltd.
Type of EUT : 4.0G LET
Model Number of EUT : E4000-01
FCC ID : N43E400001
Test regulation : FCC Part 15 Subpart C: 2021
*Bluetooth (BR / EDR) parts
*For Permissive Change
Test Result : Complied (Refer to SECTION 3.2)
*Radiated Spurious Emission test only

1. This test report shall not be reproduced in full or partial, without the written approval of UL Japan, Inc.
2. The results in this report apply only to the sample tested.
3. This sample tested is in compliance with the limits of the above regulation.
4. The test results in this test report are traceable to the national or international standards.
5. This test report must not be used by the customer to claim product certification, approval, or endorsement by the A2LA accreditation body.
6. This test report covers Radio technical requirements.
It does not cover administrative issues such as Manual or non-Radio test related Requirements. (if applicable)
7. The all test items in this test report are conducted by UL Japan, Inc. Ise EMC Lab.
8. The opinions and the interpretations to the result of the description in this report are outside scopes where UL Japan, Inc. has been accredited.
9. The information provided from the customer for this report is identified in Section 1.
10. This report is a revised version of 14007298H-B. 14007298H-B is replaced with this report.

Date of test: September 13 to 26, 2021

Representative test engineer: 
Nachi Konegawa
Engineer

Approved by: 
Satofumi Matsuyama
Engineer



CERTIFICATE 5107.02

- The testing in which "Non-accreditation" is displayed is outside the accreditation scopes in UL Japan, Inc.
 There is no testing item of "Non-accreditation".

UL Japan, Inc.

Ise EMC Lab.

4383-326 Asama-cho, Ise-shi, Mie-ken 516-0021 JAPAN

Telephone : +81 596 24 8999

Facsimile : +81 596 24 8124

REVISION HISTORY

Original Test Report No.: 14007298H-B

Revision	Test report No.	Date	Page Revised Contents
- (Original)	14007298H-B	January 28, 2022	-
1	14007298H-B-R1	February 25, 2022	Correction of Type of EUT and Model Number of EUT Type of EUT: Embedded wireless module → 4.0G LET Model Number of EUT: SX-SDPAC → E4000-01
1	14007298H-B-R1	February 25, 2022	Correction of Rating of Section 2.2. DC 5 V → DC 3.3 V
1	14007298H-B-R1	February 25, 2022	Addition of below frequency band in the table for Section 2.2. 20Mband 5500 MHz to 5580 MHz → 5500 MHz to 5700 MHz 5660 MHz to 5700 MHz 40Mband 2422 MHz - 2452 MHz 5510 MHz, 5550 MHz → 5510 MHz to 5670 MHz 5670 MHz 80Mband 5530 MHz → 5530 MHz to 5610 MHz
1	14007298H-B-R1	February 25, 2022	Addition of explanatory note *2) in Section 2.2. *2) Tests were not performed following channels, because this antenna is not used these channels. - WLAN 11n40 (2.4GHz band) - 20 MHz Bandwidth (5600 MHz - 5640 MHz) - 40 MHz Bandwidth (5590 MHz - 5630 MHz) - 80 MHz Bandwidth (5610 MHz MHz)
1	14007298H-B-R1	February 25, 2022	Correction of FCC Part 15.31 (e) of Section 3.2. The stable voltage was provided to the EUT during the tests. Therefore, this EUT complies with the requirement. → The RF Module has its own regulator. The RF Module is constantly provided voltage through the regulator regardless of input voltage. Therefore, this EUT complies with the requirement.
1	14007298H-B-R1	February 25, 2022	Correction of power supply voltage of Section 4.2. DC 14 V → DC 12 V
1	14007298H-B-R1	February 25, 2022	Addition of below explanatory note in Section 4.2. RF Module and Host device have the same product name: 4.0G LET and model number: E4000-01. The EUT of this test report is RF Module. In order to distinguish between RF Module and Host device, this test report shows as follows. RF Module: 4.0G LET Host device: 4.0G LET (Host) 4.0G LET only works with 4.0G LET (Host). Therefore, the tests were performed on the RF module built into the Host device. The RF Module is constantly provided with regulated voltage of DC 3.3 V from Host device.
1	14007298H-B-R1	February 25, 2022	Addition of Test Data (Burst Rate Confirmation) of APPENDIX 1.

UL Japan, Inc.

Ise EMC Lab.

4383-326 Asama-cho, Ise-shi, Mie-ken 516-0021 JAPAN

Telephone : +81 596 24 8999

Facsimile : +81 596 24 8124

Reference: Abbreviations (Including words undescribed in this report)

A2LA	The American Association for Laboratory Accreditation	LIMS	Laboratory Information Management System
AC	Alternating Current	MCS	Modulation and Coding Scheme
AFH	Adaptive Frequency Hopping	MRA	Mutual Recognition Arrangement
AM	Amplitude Modulation	N/A	Not Applicable
Amp, AMP	Amplifier	NIST	National Institute of Standards and Technology
ANSI	American National Standards Institute	NS	No signal detect.
Ant, ANT	Antenna	NSA	Normalized Site Attenuation
AP	Access Point	OBW	Occupied BandWidth
ASK	Amplitude Shift Keying	OFDM	Orthogonal Frequency Division Multiplexing
Atten., ATT	Attenuator	P/M	Power meter
AV	Average	PCB	Printed Circuit Board
BPSK	Binary Phase-Shift Keying	PER	Packet Error Rate
BR	Bluetooth Basic Rate	PHY	Physical Layer
BT	Bluetooth	PK	Peak
BT LE	Bluetooth Low Energy	PN	Pseudo random Noise
BW	BandWidth	PRBS	Pseudo-Random Bit Sequence
Cal Int	Calibration Interval	PSD	Power Spectral Density
CCK	Complementary Code Keying	QAM	Quadrature Amplitude Modulation
Ch., CH	Channel	QP	Quasi-Peak
CISPR	Comite International Special des Perturbations Radioelectriques	QPSK	Quadrature Phase Shift Keying
CW	Continuous Wave	RBW	Resolution BandWidth
DBPSK	Differential BPSK	RDS	Radio Data System
DC	Direct Current	RE	Radio Equipment
D-factor	Distance factor	RF	Radio Frequency
DFS	Dynamic Frequency Selection	RMS	Root Mean Square
DQPSK	Differential QPSK	RNSS	Radio Navigation Satellite Service
DSSS	Direct Sequence Spread Spectrum	RSS	Radio Standards Specifications
DUT	Device Under Test	Rx	Receiving
EDR	Enhanced Data Rate	SA, S/A	Spectrum Analyzer
EIRP, e.i.r.p.	Equivalent Isotropically Radiated Power	SG	Signal Generator
EMC	ElectroMagnetic Compatibility	SVSWR	Site-Voltage Standing Wave Ratio
EMI	ElectroMagnetic Interference	TR, T/R	Test Receiver
EN	European Norm	Tx	Transmitting
ERP, e.r.p.	Effective Radiated Power	VBW	Video BandWidth
ETSI	European Telecommunications Standards Institute	Vert.	Vertical
EU	European Union	WLAN	Wireless LAN
EUT	Equipment Under Test		
Fac.	Factor		
FCC	Federal Communications Commission		
FHSS	Frequency Hopping Spread Spectrum		
FM	Frequency Modulation		
Freq.	Frequency		
FSK	Frequency Shift Keying		
GFSK	Gaussian Frequency-Shift Keying		
GNSS	Global Navigation Satellite System		
GPS	Global Positioning System		
Hori.	Horizontal		
ICES	Interference-Causing Equipment Standard		
IEC	International Electrotechnical Commission		
IEEE	Institute of Electrical and Electronics Engineers		
IF	Intermediate Frequency		
ILAC	International Laboratory Accreditation Conference		
ISED	Innovation, Science and Economic Development Canada		
ISO	International Organization for Standardization		
JAB	Japan Accreditation Board		
LAN	Local Area Network		

UL Japan, Inc.

Ise EMC Lab.

4383-326 Asama-cho, Ise-shi, Mie-ken 516-0021 JAPAN

Telephone : +81 596 24 8999

Facsimile : +81 596 24 8124

CONTENTS	PAGE
SECTION 1: Customer information.....	5
SECTION 2: Equipment under test (EUT).....	5
SECTION 3: Test specification, procedures & results.....	7
SECTION 4: Operation of EUT during testing.....	10
SECTION 5: Radiated Spurious Emission	11
APPENDIX 1: Test data	14
Radiated Spurious Emission	14
APPENDIX 2: Test instruments	26
APPENDIX 3: Photographs of test setup	27
Radiated Spurious Emission	27
Worst Case Position	28
Antenna Terminal Conducted Tests.....	29

SECTION 1: Customer information

Company Name : Honda Motor Co., Ltd.
Address : No.6-1, Hagadai, Haga-Machi, Haga-Gun, Tochigi-ken 321-3395 Japan
Telephone Number : +81-28-687-0707
Contact Person : Kazumori Sakai

The information provided from the customer is as follows;

- Applicant, Type of EUT, Model Number of EUT, FCC ID on the cover and other relevant pages
 - Operating/Test Mode(s) (Mode(s)) on all the relevant pages
 - SECTION 1: Customer information
 - SECTION 2: Equipment under test (EUT) other than the Receipt Date
 - SECTION 4: Operation of EUT during testing
- * The laboratory is exempted from liability of any test results affected from the above information in SECTION 2 and 4.

SECTION 2: Equipment under test (EUT)

2.1 Identification of EUT

Type : 4.0G LET
Model Number : E4000-01
Serial Number : Refer to SECTION 4.2
Receipt Date : Septmber 9, 2021
Condition : Engineering prototype
(Not for Sale: This sample is equivalent to mass-produced items.)
Modification : No Modification by the test lab.

2.2 Product Description

Model Number of EUT: E4000-01 (referred to as the EUT in this report) is a 4.0G LET.

Product Specification

Rating : DC 3.3 V

Radio Specification

Specification of Wireless LAN (IEEE802.11b/g/a/n-20/n-40/11ac-20/11ac-40/11ac-80)

	IEEE802.11b	IEEE802.11g/n (20 M band)	IEEE802.11a/n/ac (20 M band)	IEEE802.11n/ac (40 M band)	IEEE802.11ac (80 M band)
Frequency of operation	2412 MHz - 2462 MHz	2412 MHz - 2462 MHz	5180 MHz - 5240 MHz 5260 MHz - 5320 MHz 5500 MHz - 5700 MHz 5745 MHz - 5825 MHz	2422 MHz - 2452 MHz 5190 MHz - 5230 MHz 5270 MHz - 5310 MHz 5510 MHz - 5670 MHz	5210 MHz 5290 MHz 5530 MHz - 5610 MHz 5775 MHz
Type of modulation	DSSS (CCK, DQPSK, DBPSK)	OFDM-CCK (64QAM, 16QAM, QPSK, BPSK)	11a/n: OFDM (64QAM, 16QAM, QPSK, BPSK) 11ac: OFDM (64QAM, 16QAM, QPSK, BPSK, 256QAM)		
Channel spacing	5 MHz		20 MHz	40 MHz	80 MHz
Antenna type	PCB antenna *2)				
Antenna Gain	2.4 GHz: 3.5 dBi 5 GHz: 3.5 dBi				

Bluetooth

	Bluetooth *1)
Frequency of operation	2402 MHz - 2480 MHz
Type of modulation	BT: FHSS (GFSK, $\pi/4$ DQPSK, 8DPSK) LE: GFSK
Channel spacing	BT: 1 MHz LE: 2 MHz
Antenna type	PCB antenna
Antenna Gain	3.5 dBi

*1) This test report applies to Bluetooth (BR/EDR) part.

*2) Tests were not performed following channels, because this antenna is not used these channels.

- WLAN 11n40 (2.4GHz band)
- 20 MHz Bandwidth (5600 MHz - 5640 MHz)
- 40 MHz Bandwidth (5590 MHz - 5630 MHz)
- 80 MHz Bandwidth (5610 MHz - 5650 MHz)

SECTION 3: Test specification, procedures & results

3.1 Test Specification

Test Specification : FCC Part 15 Subpart C
FCC Part 15 final revised on May 3, 2021 and effective July 2, 2021

Title : FCC 47 CFR Part 15 Radio Frequency Device Subpart C Intentional Radiators
Section 15.207 Conducted limits
Section 15.247 Operation within the bands 902-928 MHz, 2400-2483.5 MHz,
and 5725-5850 MHz

3.2 Procedures and results

Item	Test Procedure	Specification	Worst Margin	Results	Remarks
Spurious Emission & Band Edge Compliance	FCC: KDB 558074 D01 15.247 Meas Guidance v05r02 ISED: RSS-Gen 6.13	FCC: Section15.247(d) ----- ISED: RSS-247 5.5 RSS-Gen 8.9 RSS-Gen 8.10	0.8 dB 250.0 MHz, QP, Horizontal.	Complied# a)	Radiated (above 30 MHz) *1)

Note: UL Japan, Inc.'s EMI Work Procedures No. 13-EM-W0420 and 13-EM-W0422.

*1) Radiated test was selected over 30 MHz based on section 15.247(d).

a) Refer to APPENDIX 1 (data of Radiated Spurious Emission)

Symbols:

Complied The data of this test item has enough margin, more than the measurement uncertainty.

Complied# The data of this test item meets the limits unless the measurement uncertainty is taken into consideration.

* In case any questions arise about test procedure, ANSI C63.10: 2013 is also referred.

FCC Part 15.31 (e)

The RF Module has its own regulator.

The RF Module is constantly provided voltage through the regulator regardless of input voltage.

Therefore, this EUT complies with the requirement.

FCC Part 15.203 Antenna requirement

The antenna is not removable from the EUT.

Therefore, the equipment complies with the antenna requirement of Section 15.203.

3.3 Addition to standard

No addition, exclusion nor deviation has been made from the standard.

3.4 Uncertainty

There is no applicable rule of uncertainty in this applied standard. Therefore, the results are derived depending on whether or not laboratory uncertainty is applied.

The following uncertainties have been calculated to provide a confidence level of 95 % using a coverage factor $k=2$.
Ise EMC Lab.

Radiated emission

Measurement distance	Frequency range	Uncertainty (+/-)
3 m	9 kHz to 30 MHz	3.3 dB
10 m		3.2 dB
3 m	30 MHz to 200 MHz (Horizontal) (Vertical)	4.8 dB
		5.0 dB
	200 MHz to 1000 MHz (Horizontal) (Vertical)	5.2 dB
		6.3 dB
10 m	30 MHz to 200 MHz (Horizontal) (Vertical)	4.8 dB
		4.8 dB
	200 MHz to 1000 MHz (Horizontal) (Vertical)	5.0 dB
		5.0 dB
3 m	1 GHz to 6 GHz	4.9 dB
	6 GHz to 18 GHz	5.2 dB
1 m	10 GHz to 26.5 GHz	5.5 dB
	26.5 GHz to 40 GHz	5.5 dB
10 m	1 GHz to 18 GHz	5.2 dB

3.5 Test Location

UL Japan, Inc. Ise EMC Lab.

*A2LA Certificate Number: 5107.02 / FCC Test Firm Registration Number: 884919

ISED Lab Company Number: 2973C / CAB identifier: JP0002

4383-326 Asama-cho, Ise-shi, Mie-ken 516-0021 JAPAN

Telephone: +81 596 24 8999, Facsimile: +81 596 24 8124

Test site	Width x Depth x Height (m)	Size of reference ground plane (m) / horizontal conducting plane	Other rooms	Maximum measurement distance
No.1 semi-anechoic chamber	19.2 x 11.2 x 7.7	7.0 x 6.0	No.1 Power source room	10 m
No.2 semi-anechoic chamber	7.5 x 5.8 x 5.2	4.0 x 4.0	-	3 m
No.3 semi-anechoic chamber	12.0 x 8.5 x 5.9	6.8 x 5.75	No.3 Preparation room	3 m
No.3 shielded room	4.0 x 6.0 x 2.7	N/A	-	-
No.4 semi-anechoic chamber	12.0 x 8.5 x 5.9	6.8 x 5.75	No.4 Preparation room	3 m
No.4 shielded room	4.0 x 6.0 x 2.7	N/A	-	-
No.5 semi-anechoic chamber	6.0 x 6.0 x 3.9	6.0 x 6.0	-	-
No.5 measurement room	6.4 x 6.4 x 3.0	6.4 x 6.4	-	-
No.6 shielded room	4.0 x 4.5 x 2.7	4.0 x 4.5	-	-
No.6 measurement room	4.75 x 5.4 x 3.0	4.75 x 4.15	-	-
No.7 shielded room	4.7 x 7.5 x 2.7	4.7 x 7.5	-	-
No.8 measurement room	3.1 x 5.0 x 2.7	3.1 x 5.0	-	-
No.9 measurement room	8.8 x 4.6 x 2.8	2.4 x 2.4	-	-
No.10 shielded room	3.8 x 2.8 x 2.8	3.8 x 2.8	-	-
No.11 measurement room	4.0 x 3.4 x 2.5	N/A	-	-
No.12 measurement room	2.6 x 3.4 x 2.5	N/A	-	-

3.6 Test data, Test instruments, and Test set up

Refer to APPENDIX.

UL Japan, Inc.

Ise EMC Lab.

4383-326 Asama-cho, Ise-shi, Mie-ken 516-0021 JAPAN

Telephone : +81 596 24 8999

Facsimile : +81 596 24 8124

SECTION 4: Operation of EUT during testing

4.1 Operating Mode(s)

Details of Operating Mode(s)

Test Item	Mode	Tested frequency
Spurious Emission (Radiated)	Tx (Hopping Off) DH5, 3DH5	2402 MHz 2441 MHz 2480 MHz
<p>*As a result of preliminary test, the formal test was performed with the above modes, which had the maximum payload length (except Dwell time test)</p> <p>*2DH mode (2Mb/s EDR: pi/4DQPSK) was excluded for other tests than power measurement by using 3DH mode (3 Mb/s EDR: 8DPSK) as a representative.</p> <p>* It is considered that the non-tested packet type (e.g. inquiry) can be omitted as it is complied with above all the test items based on Bluetooth Core specification.</p> <p>Power settings: Same as production model Software: Qualcomm Radio Control Tool Vert.4.0.00104.0 (Date: 2021.8.18, Storage location: Driven by connected PC)</p> <p>*This setting of software is the worst case. Any conditions under the normal use do not exceed the condition of setting. In addition, end users cannot change the settings of the output power of the product.</p>		

4.2 Configuration and peripherals

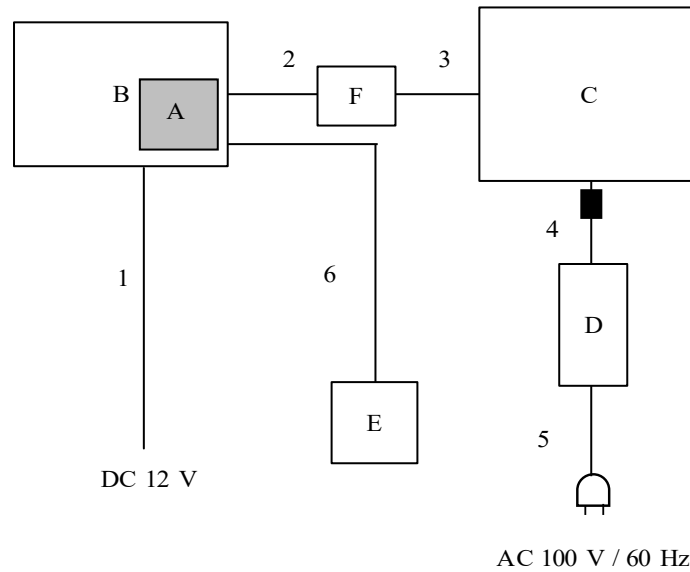

■ : Standard Ferrite Core

* Cabling and setup(s) were taken into consideration and test data was taken under worse case conditions.

Description of EUT and Support equipment

No.	Item	Model number	Serial number	Manufacturer	Remarks
A	4.0G LET	E4000-01	001	Honda Motor Co., Ltd.	EUT
B	4.0G LET(Host)	E4000-01	13116	Honda Motor Co., Ltd.	-
C	Laptop PC	CF-MX4	5FKSA17992	PANASONIC	-
D	AC Adapter	CF-AA62J2C	62J2CM21522514 38SB	Panasonic	-
E	Mouse	BSMOU27SM	A10517	Buffalo Inc.	-
F	USB 3.0 to Gigabit Ethernet Adapter	USB31000S	210513005254	StarTech.com	-

List of cables used

No.	Name	Length (m)	Shield		Remarks
			Cable	Connector	
1	DC Cable	3.3	Unshielded	Unshielded	-
2	USB Cable	0.1	Shielded	Shielded	-
3	LAN Cable	3.0	Unshielded	Unshielded	-
4	DC Cable	1.6	Unshielded	Unshielded	-
5	AC Cable	0.8	Unshielded	Unshielded	-
6	USB Cable	1.5	Shielded	Shielded	-

<Note>

RF Module and Host device have the same product name: 4.0G LET and model number: E4000-01.

The EUT of this test report is RF Module.

In order to distinguish between RF Module and Host device, this test report shows as follows.

RF Module: 4.0G LET

Host device: 4.0G LET (Host)

4.0G LET only works with 4.0G LET (Host).

Therefore, the tests were performed on the RF module built into the Host device.

The RF Module is constantly provided with regulated voltage of DC 3.3 V from Host device.

UL Japan, Inc.

Ise EMC Lab.

4383-326 Asama-cho, Ise-shi, Mie-ken 516-0021 JAPAN

Telephone : +81 596 24 8999

Facsimile : +81 596 24 8124

SECTION 5: Radiated Spurious Emission

Test Procedure

[For below 1 GHz]

EUT was placed on a urethane platform of nominal size, 1.0 m by 1.5 m, raised 0.8 m above the conducting ground plane. The Radiated Electric Field Strength has been measured in a Semi Anechoic Chamber with a ground plane.

[For above 1 GHz]

EUT was placed on a urethane platform of nominal size, 0.5 m by 0.5 m, raised 1.5 m above the conducting ground plane. The Radiated Electric Field Strength has been measured in a Semi Anechoic Chamber with absorbent materials lined on a ground plane.

The height of the measuring antenna varied between 1 m and 4 m and EUT was rotated a full revolution in order to obtain the maximum value of the electric field strength.

Test antenna was aimed at the EUT for receiving the maximum signal and always kept within the illumination area of the 3 dB beamwidth of the antenna.

The measurements were performed for both vertical and horizontal antenna polarization with the Test Receiver, or the Spectrum Analyzer.

The measurements were made with the following detector function of the test receiver and the Spectrum analyzer (in linear mode).

The test was made with the detector (RBW/VBW) in the following table.

When using Spectrum analyzer, the test was made with adjusting span to zero by using peak hold.

Test Antennas are used as below;

Frequency	30 MHz to 200 MHz	200 MHz to 1 GHz	Above 1 GHz
Antenna Type	Biconical	Logperiodic	Horn

In any 100 kHz bandwidth outside the restricted band in which the spread spectrum intentional radiator is operating, the radio frequency power that is produced by the intentional radiator confirmed 20 dB below that in the 100 kHz bandwidth within the band that contains the highest level of the desired power, based on a radiated measurement.

20 dBc was applied to the frequency over the limit of FCC 15.209 / Table 4 of RSS-Gen 8.9 (ISED) and outside the restricted band of FCC15.205 / Table 6 of RSS-Gen 8.10 (ISED).

Frequency	Below 1 GHz	Above 1 GHz		20 dBc
Instrument used	Test Receiver	Spectrum Analyzer		Spectrum Analyzer
Detector	QP	PK	AV *1)	PK
IF Bandwidth	BW 120 kHz	RBW: 1 MHz VBW: 3 MHz	RBW: 1 MHz VBW: 3 MHz Detector: Power Averaging (RMS) Trace: 100 traces Duty factor was added to the results.	RBW: 100 kHz VBW: 300 kHz

*1) Average Power Measurement was performed based on KDB 558074 D01 15.247 Meas Guidance v05r02.

UL Japan, Inc.

Ise EMC Lab.

4383-326 Asama-cho, Ise-shi, Mie-ken 516-0021 JAPAN

Telephone : +81 596 24 8999

Facsimile : +81 596 24 8124

Figure 2: Test Setup

Below 1 GHz

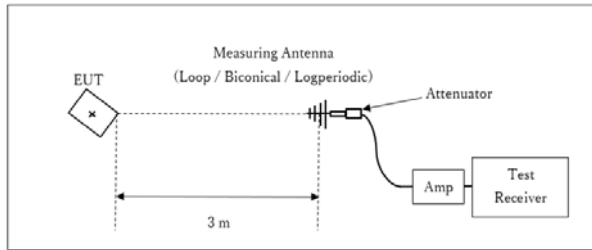

× : Center of turn table

Test Distance: 3 m

1 GHz - 10 GHz

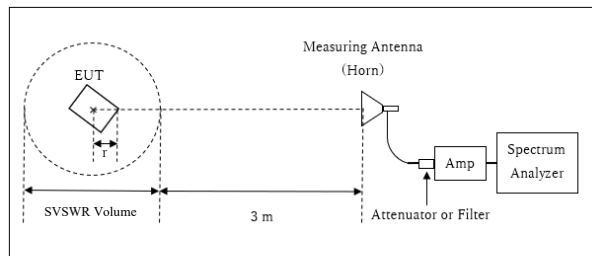

r : Radius of an outer periphery of EUT
× : Center of turn table

Distance Factor: $20 \times \log (3.9 \text{ m} / 3.0 \text{ m}) = 2.28 \text{ dB}$
* Test Distance: $(3 + \text{SVSWR Volume} / 2) - r = 3.90 \text{ m}$

SVSWR Volume : 2.0 m
(SVSWR Volume has been calibrated based on CISPR 16-1-4.)
r = 0.10 m

10 GHz - 26.5 GHz

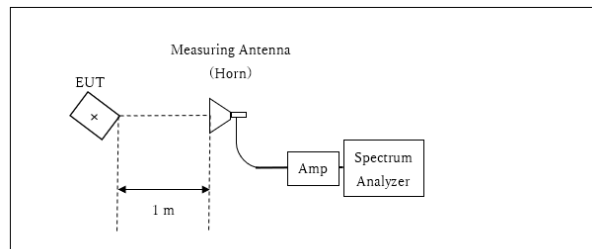

× : Center of turn table

Distance Factor: $20 \times \log (1.0 \text{ m} / 3.0 \text{ m}) = -9.5 \text{ dB}$
*Test Distance: 1 m

- The carrier level and noise levels were confirmed at each position of X, Y and Z axes of EUT to see the position of maximum noise, and the test was made at the position that has the maximum noise.

The test results and limit are rounded off to one decimal place, so some differences might be observed.

Measurement range : 30 MHz - 26.5 GHz
Test data : APPENDIX
Test result : Pass

APPENDIX 1: Test data

Burst Rate Confirmation

Report No. 14007298H
Test place Ise EMC Lab. No.4 Semi Anechoic Chamber
Date September 13, 2021
Temperature / Humidity 22 deg. C / 70 % RH
Engineer Akihiko Maeda
Mode Tx, Hopping Off

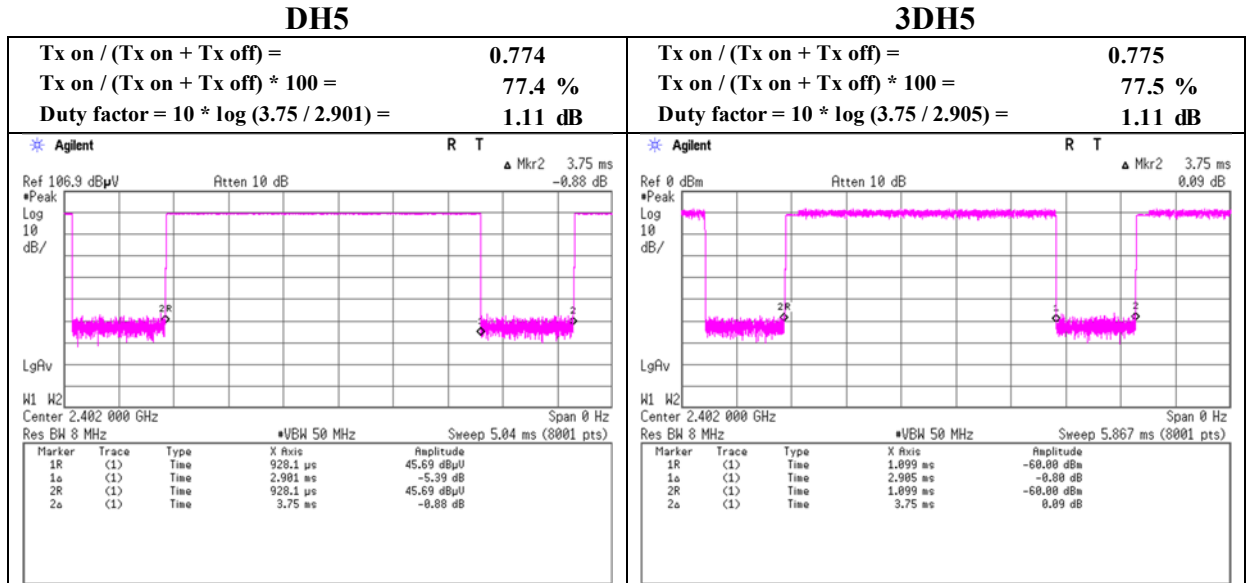

UL Japan, Inc.

Ise EMC Lab.

4383-326 Asama-cho, Ise-shi, Mie-ken 516-0021 JAPAN

Telephone : +81 596 24 8999

Facsimile : +81 596 24 8124

Radiated Spurious Emission

Report No.	14007298H			
Test place	Ise EMC Lab.			
Semi Anechoic Chamber	No.4	No.4	No.4	No.3
Date	September 13, 2021	September 14, 2021	September 15, 2021	September 26, 2021
Temperature / Humidity	22 deg. C / 70 % RH	23 deg. C / 65 % RH	22 deg. C / 67 % RH	22 deg. C / 66 % RH
Engineer	Akihiko Maeda	Nachi Konegawa	Kiyoshiro Okazaki	Hiroki Numata
	(1 GHz -10 GHz)	(10 GHz - 18 GHz)	(18 GHz - 26.5 GHz)	(Below 1 GHz)
Mode	Tx, Hopping Off, DH5 2402 MHz			

Polarity	Frequency	Reading (QP / PK)	Reading (AV)	Ant. Factor	Loss	Gain	Duty Factor	Result (QP / PK)	Result (AV)	Limit (QP / PK)	Limit (AV)	Margin (QP / PK)	Margin (AV)	Remark
[Hori/Vert]	[MHz]	[dBuV]	[dBuV]	[dB/m]	[dB]	[dB]	[dB]	[dBuV/m]	[dBuV/m]	[dBuV/m]	[dBuV/m]	[dB]	[dB]	
Hori.	61.3	38.6	-	7.5	7.7	32.3	-	21.5	-	40.0	-	18.5	-	
Hori.	250.0	55.2	-	12.5	9.7	32.1	-	45.2	-	46.0	-	0.8	-	
Hori.	350.0	50.9	-	15.5	10.4	32.1	-	44.8	-	46.0	-	1.3	-	
Hori.	450.0	42.4	-	16.8	11.1	32.1	-	38.2	-	46.0	-	7.8	-	
Hori.	650.0	40.6	-	19.4	12.3	32.1	-	40.2	-	46.0	-	5.8	-	
Hori.	750.0	40.7	-	20.4	12.8	31.8	-	42.1	-	46.0	-	3.9	-	
Hori.	2390.0	42.1	33.9	27.8	4.7	31.8	1.1	42.7	35.6	73.9	53.9	31.2	18.3	*1)
Hori.	4804.0	45.1	38.9	31.6	6.5	31.2	1.1	52.1	47.0	73.9	53.9	21.9	6.9	
Hori.	7206.0	42.9	33.9	36.2	7.4	32.4	-	54.1	45.1	73.9	53.9	19.8	8.8	Floor noise
Hori.	9608.0	42.8	34.0	38.0	8.3	32.6	-	56.5	47.7	73.9	53.9	17.4	6.2	Floor noise
Vert.	61.3	52.4	-	7.5	7.7	32.3	-	35.3	-	40.0	-	4.7	-	
Vert.	250.0	51.0	-	12.5	9.7	32.1	-	41.0	-	46.0	-	5.0	-	
Vert.	350.0	42.4	-	15.5	10.4	32.1	-	36.3	-	46.0	-	9.8	-	
Vert.	450.0	40.7	-	16.8	11.1	32.1	-	36.5	-	46.0	-	9.5	-	
Vert.	650.0	37.8	-	19.4	12.3	32.1	-	37.4	-	46.0	-	8.6	-	
Vert.	750.0	41.3	-	20.4	12.8	31.8	-	42.7	-	46.0	-	3.3	-	
Vert.	2390.0	42.1	33.8	27.8	4.7	31.8	1.1	42.7	35.5	73.9	53.9	31.2	18.4	*1)
Vert.	4804.0	44.7	38.7	31.6	6.5	31.2	1.1	51.7	46.8	73.9	53.9	22.3	7.1	
Vert.	7206.0	42.9	33.9	36.2	7.4	32.4	-	54.1	45.1	73.9	53.9	19.8	8.8	Floor noise
Vert.	9608.0	42.8	34.0	38.0	8.3	32.6	-	56.5	47.7	73.9	53.9	17.4	6.2	Floor noise

Result (QP / PK) = Reading + Ant Factor + Loss (Cable+Attenuator+Filter+Distance factor(above 1 GHz)) - Gain(Amplifier)

Result (AV)= Reading + Ant Factor + Loss (Cable+Attenuator+Filter+Distance factor(above 1 GHz)) - Gain(Amplifier) + Duty factor

*Other frequency noises omitted in this report were not seen or had enough margin (more than 20 dB).

*QP detector was used up to 1GHz.

*1) Not Out of Band emission(Leakage Power)

20dBc Data Sheet

Polarity	Frequency	Reading (PK)	Ant Factor	Loss	Gain	Result	Limit	Margin	Remark
[Hori/Vert]	[MHz]	[dBuV]	[dB/m]	[dB]	[dB]	[dBuV/m]	[dBuV/m]	[dB]	
Hori.	2402.0	95.9	27.8	4.7	31.8	96.5	-	-	Carrier
Hori.	2400.0	37.7	27.8	4.7	31.8	38.3	76.5	38.2	
Vert.	2402.0	96.4	27.8	4.7	31.8	97.0	-	-	Carrier
Vert.	2400.0	37.9	27.8	4.7	31.8	38.5	77.0	38.5	

Result = Reading + Ant Factor + Loss (Cable+Attenuator+Filter+Distance factor(above 1 GHz)) - Gain(Amplifier)

Distance factor: 1 GHz - 10 GHz 20log(3.9 m / 3.0 m) = 2.28 dB
 10 GHz - 26.5 GHz 20log(1.0 m / 3.0 m) = -9.5 dB

UL Japan, Inc.

Ise EMC Lab.

4383-326 Asama-cho, Ise-shi, Mie-ken 516-0021 JAPAN

Telephone : +81 596 24 8999

Facsimile : +81 596 24 8124

Radiated Spurious Emission
(Reference Plot for band-edge)

Report No. 14007298H
Test place Ise EMC Lab.
Semi Anechoic Chamber No.4
Date September 13, 2021
Temperature / Humidity 22 deg. C / 70 % RH
Engineer Akihiko Maeda
(1 GHz -10 GHz)
Mode Tx, Hopping Off, DH5 2402 MHz

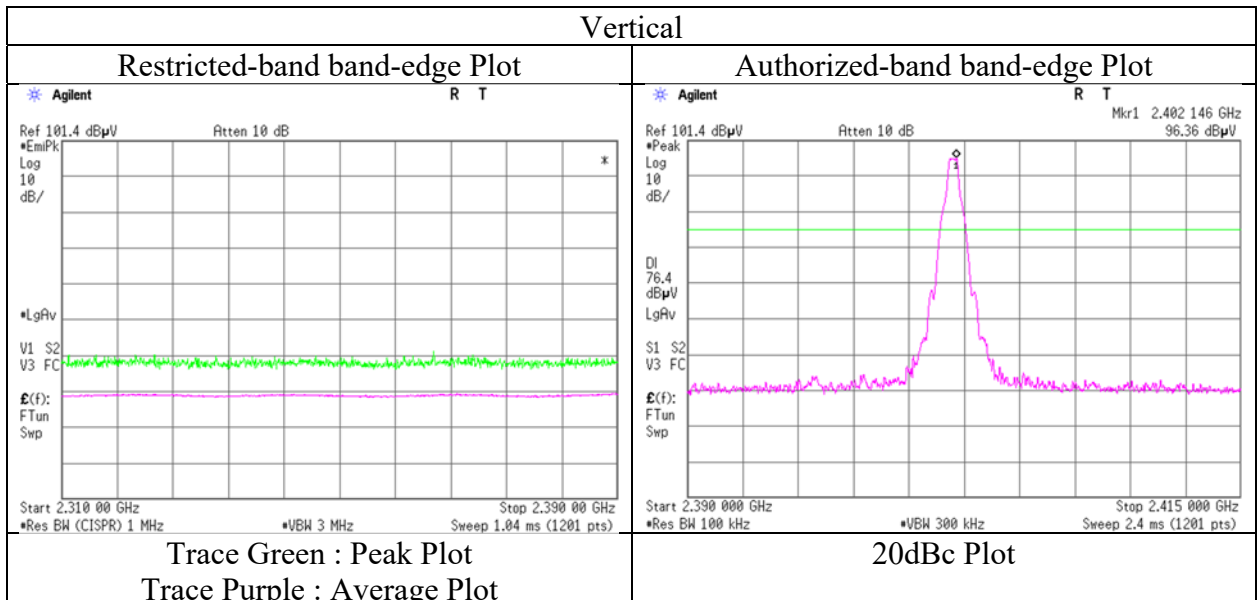
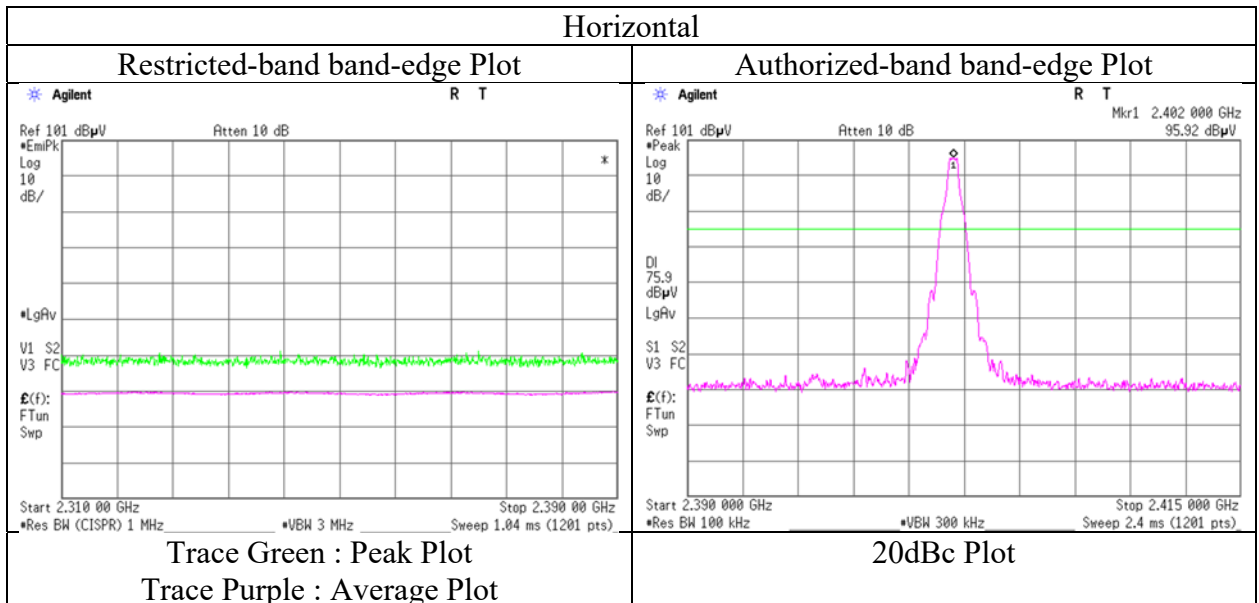

* The measurement was conducted for a sufficiently long enough time to detect any possible spurious emissions.
Final result of restricted band edge was shown in tabular data.

Radiated Spurious Emission

Report No.	14007298H			
Test place	Ise EMC Lab.			
Semi Anechoic Chamber	No.4	No.4	No.4	No.3
Date	September 13, 2021	September 14, 2021	September 15, 2021	September 26, 2021
Temperature / Humidity	22 deg. C / 70 % RH	23 deg. C / 65 % RH	22 deg. C / 67 % RH	22 deg. C / 66 % RH
Engineer	Akihiko Maeda	Nachi Konegawa	Kiyoshiro Okazaki	Hiroki Numata
	(1 GHz -10 GHz)	(10 GHz - 18 GHz)	(18 GHz - 26.5 GHz)	(Below 1 GHz)
Mode	Tx, Hopping Off, DH5 2441 MHz			

Polarity [Hori/Vert]	Frequency [MHz]	Reading (QP / PK) [dBuV]	Reading (AV) [dBuV]	Ant. Factor [dB/m]	Loss [dB]	Gain [dB]	Duty Factor [dB]	Result (QP / PK) [dBuV/m]	Result (AV) [dBuV/m]	Limit (QP / PK) [dBuV/m]	Limit (AV) [dBuV/m]	Margin (QP / PK) [dB]	Margin (AV) [dB]	Remark
Hori.	61.3	38.7	-	7.5	7.7	32.3	-	21.6	-	40.0	-	18.4	-	
Hori.	250.0	55.1	-	12.5	9.7	32.1	-	45.1	-	46.0	-	0.9	-	
Hori.	350.0	50.9	-	15.5	10.4	32.1	-	44.8	-	46.0	-	1.3	-	
Hori.	450.0	42.3	-	16.8	11.1	32.1	-	38.1	-	46.0	-	7.9	-	
Hori.	550.0	42.4	-	18.0	11.7	32.1	-	40.0	-	46.0	-	6.0	-	
Hori.	750.0	40.7	-	20.4	12.8	31.8	-	42.1	-	46.0	-	3.9	-	
Hori.	4882.0	43.7	36.7	31.6	6.5	31.2	1.1	50.7	44.8	73.9	53.9	23.2	9.1	
Hori.	7323.0	42.7	34.2	36.3	7.5	32.4	-	54.0	45.5	73.9	53.9	19.9	8.4	Floor noise
Hori.	9764.0	42.3	33.6	38.4	8.3	32.7	-	56.4	47.7	73.9	53.9	17.5	6.2	Floor noise
Vert.	61.3	52.4	-	7.5	7.7	32.3	-	35.3	-	40.0	-	4.7	-	
Vert.	250.0	51.1	-	12.5	9.7	32.1	-	41.1	-	46.0	-	4.9	-	
Vert.	350.0	42.3	-	15.5	10.4	32.1	-	36.2	-	46.0	-	9.9	-	
Vert.	450.0	40.6	-	16.8	11.1	32.1	-	36.4	-	46.0	-	9.6	-	
Vert.	550.0	40.6	-	18.0	11.7	32.1	-	38.2	-	46.0	-	7.8	-	
Vert.	750.0	41.3	-	20.4	12.8	31.8	-	42.7	-	46.0	-	3.3	-	
Vert.	4882.0	43.8	36.5	31.6	6.5	31.2	1.1	50.8	44.6	73.9	53.9	23.1	9.3	
Vert.	7323.0	42.7	34.2	36.3	7.5	32.4	-	54.0	45.5	73.9	53.9	19.9	8.4	Floor noise
Vert.	9764.0	42.3	33.6	38.4	8.3	32.7	-	56.4	47.7	73.9	53.9	17.5	6.2	Floor noise

Result (QP / PK) = Reading + Ant Factor + Loss (Cable+Attenuator+Filter+Distance factor(above 1 GHz)) - Gain(Amplifier)

Result (AV)= Reading + Ant Factor + Loss (Cable+Attenuator+Filter+Distance factor(above 1 GHz)) - Gain(Amplifier) + Duty factor

*Other frequency noises omitted in this report were not seen or had enough margin (more than 20 dB).

*QP detector was used up to 1GHz.

Distance factor:	1 GHz - 10 GHz	20log(3.9 m / 3.0 m) = 2.28 dB
	10 GHz - 26.5 GHz	20log(1.0 m / 3.0 m) = -9.5 dB

UL Japan, Inc.

Ise EMC Lab.

4383-326 Asama-cho, Ise-shi, Mie-ken 516-0021 JAPAN

Telephone : +81 596 24 8999

Facsimile : +81 596 24 8124

Radiated Spurious Emission

Report No.	14007298H			
Test place	Ise EMC Lab.			
Semi Anechoic Chamber	No.4	No.4	No.4	No.3
Date	September 13, 2021	September 14, 2021	September 15, 2021	September 26, 2021
Temperature / Humidity	22 deg. C / 70 % RH	23 deg. C / 65 % RH	22 deg. C / 67 % RH	22 deg. C / 66 % RH
Engineer	Akihiko Maeda	Nachi Konegawa	Kiyoshiro Okazaki	Hiroki Numata
	(1 GHz -10 GHz)	(10 GHz - 18 GHz)	(18 GHz - 26.5 GHz)	(Below 1 GHz)
Mode	Tx, Hopping Off, DH5 2480 MHz			

Polarity [Hori/Vert]	Frequency [MHz]	Reading (QP / PK) [dBuV]	Reading (AV) [dBuV]	Ant. Factor [dB/m]	Loss [dB]	Gain [dB]	Duty Factor [dB]	Result (QP / PK) [dBuV/m]	Result (AV) [dBuV/m]	Limit (QP / PK) [dBuV/m]	Limit (AV) [dBuV/m]	Margin (QP / PK) [dB]	Margin (AV) [dB]	Remark
Hori.	61.3	38.7	-	7.5	7.7	32.3	-	21.6	-	40.0	-	18.4	-	
Hori.	250.0	55.1	-	12.5	9.7	32.1	-	45.1	-	46.0	-	0.9	-	
Hori.	350.0	50.8	-	15.5	10.4	32.1	-	44.7	-	46.0	-	1.4	-	
Hori.	450.0	42.4	-	16.8	11.1	32.1	-	38.2	-	46.0	-	7.8	-	
Hori.	550.0	42.3	-	18.0	11.7	32.1	-	39.9	-	46.0	-	6.1	-	
Hori.	750.0	40.6	-	20.4	12.8	31.8	-	42.0	-	46.0	-	4.0	-	
Hori.	2483.5	49.7	36.3	27.7	4.7	31.8	1.1	50.3	38.0	73.9	53.9	23.6	15.9	*1)
Hori.	4960.0	42.6	35.3	31.7	6.6	31.2	1.1	49.7	43.5	73.9	53.9	24.2	10.4	
Hori.	7440.0	42.8	34.7	36.5	7.5	32.5	-	54.3	46.2	73.9	53.9	19.6	7.7	Floor noise
Hori.	9920.0	41.5	33.4	38.6	8.3	32.7	-	55.7	47.6	73.9	53.9	18.3	6.4	Floor noise
Vert.	61.3	52.5	-	7.5	7.7	32.3	-	35.4	-	40.0	-	4.6	-	
Vert.	250.0	51.0	-	12.5	9.7	32.1	-	41.0	-	46.0	-	5.0	-	
Vert.	350.0	42.4	-	15.5	10.4	32.1	-	36.3	-	46.0	-	9.8	-	
Vert.	450.0	40.7	-	16.8	11.1	32.1	-	36.5	-	46.0	-	9.5	-	
Vert.	550.0	40.6	-	18.0	11.7	32.1	-	38.2	-	46.0	-	7.8	-	
Vert.	750.0	41.3	-	20.4	12.8	31.8	-	42.7	-	46.0	-	3.3	-	
Vert.	2483.5	48.3	35.8	27.7	4.7	31.8	1.1	48.9	37.5	73.9	53.9	25.0	16.4	*1)
Vert.	4960.0	41.8	34.6	31.7	6.6	31.2	1.1	48.9	42.8	73.9	53.9	25.0	11.1	
Vert.	7440.0	42.8	34.7	36.5	7.5	32.5	-	54.3	46.2	73.9	53.9	19.6	7.7	Floor noise
Vert.	9920.0	41.5	33.4	38.6	8.3	32.7	-	55.7	47.6	73.9	53.9	18.3	6.4	Floor noise

Result (QP / PK) = Reading + Ant Factor + Loss (Cable+Attenuator+Filter+Distance factor(above 1 GHz)) - Gain(Amplifier)

Result (AV) = Reading + Ant Factor + Loss (Cable+Attenuator+Filter+Distance factor(above 1 GHz)) - Gain(Amplifier) + Duty factor

*Other frequency noises omitted in this report were not seen or had enough margin (more than 20 dB).

*QP detector was used up to 1GHz.

*1) Not Out of Band emission(Leakage Power)

Distance factor: 1 GHz - 10 GHz 20log(3.9 m / 3.0 m) = 2.28 dB

10 GHz - 26.5 GHz 20log(1.0 m / 3.0 m) = -9.5 dB

UL Japan, Inc.

Ise EMC Lab.

4383-326 Asama-cho, Ise-shi, Mie-ken 516-0021 JAPAN

Telephone : +81 596 24 8999

Facsimile : +81 596 24 8124

Radiated Spurious Emission
(Reference Plot for band-edge)

Report No.	14007298H
Test place	Ise EMC Lab.
Semi Anechoic Chamber	No.4
Date	September 13, 2021
Temperature / Humidity	22 deg. C / 70 % RH
Engineer	Akihiko Maeda (1 GHz -10 GHz)
Mode	Tx, Hopping Off, DH5 2480 MHz

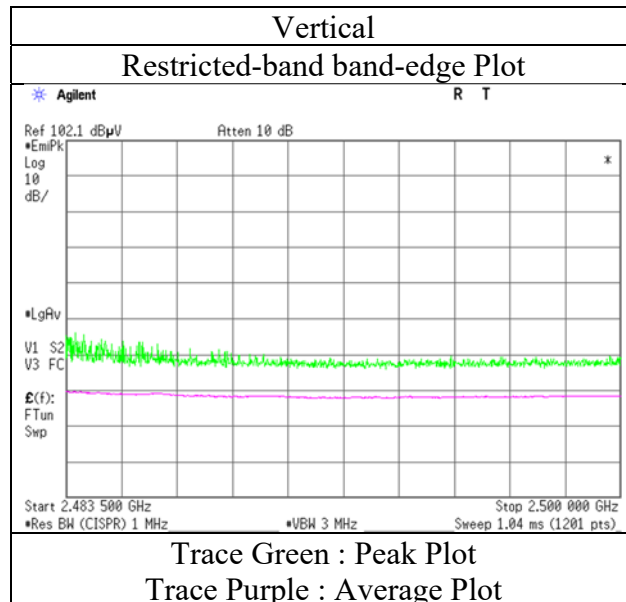
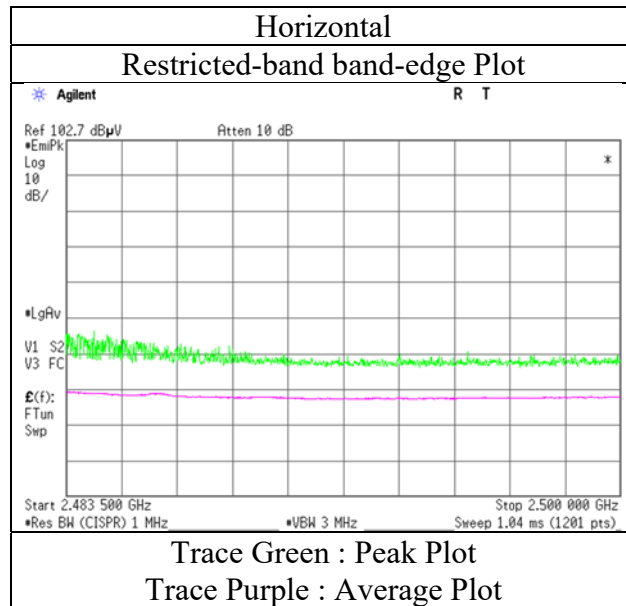

* The measurement was conducted for a sufficiently long enough time to detect any possible spurious emissions. Final result of restricted band edge was shown in tabular data.

Radiated Spurious Emission

Report No. 14007298H
Test place Ise EMC Lab.
Semi Anechoic Chamber No.4 No.4 No.4 No.3
Date September 13, 2021 September 14, 2021 September 15, 2021 September 26, 2021
Temperature / Humidity 22 deg. C / 70 % RH 23 deg. C / 65 % RH 22 deg. C / 67 % RH 22 deg. C / 66 % RH
Engineer Akihiko Maeda Nachi Konegawa Kiyoshiro Okazaki Hiroki Numata
(1 GHz -10 GHz) (10 GHz - 18 GHz) (18 GHz -26.5 GHz) (Below 1 GHz)
Mode Tx, Hopping Off, 3DH5 2402 MHz

Polarity	Frequency	Reading (QP / PK)	Reading (AV)	Ant. Factor	Loss	Gain	Duty Factor	Result (QP / PK)	Result (AV)	Limit (QP / PK)	Limit (AV)	Margin (QP / PK)	Margin (AV)	Remark
[Hori/Vert]	[MHz]	[dBuV]	[dBuV]	[dB/m]	[dB]	[dB]	[dB]	[dBuV/m]	[dBuV/m]	[dBuV/m]	[dBuV/m]	[dB]	[dB]	
Hori.	61.3	38.8	-	7.5	7.7	32.3	-	21.7	-	40.0	-	18.3	-	
Hori.	250.0	55.1	-	12.5	9.7	32.1	-	45.1	-	46.0	-	0.9	-	
Hori.	350.0	50.9	-	15.5	10.4	32.1	-	44.8	-	46.0	-	1.3	-	
Hori.	450.0	42.3	-	16.8	11.1	32.1	-	38.1	-	46.0	-	7.9	-	
Hori.	550.0	42.4	-	18.0	11.7	32.1	-	40.0	-	46.0	-	6.0	-	
Hori.	750.0	40.7	-	20.4	12.8	31.8	-	42.1	-	46.0	-	3.9	-	
Hori.	2390.0	41.5	33.7	27.8	4.7	31.8	1.1	42.1	35.4	73.9	53.9	31.8	18.5	*1)
Hori.	4804.0	45.5	37.9	31.6	6.5	31.2	1.1	52.5	46.0	73.9	53.9	21.5	7.9	
Hori.	7206.0	42.9	33.9	36.2	7.4	32.4	-	54.1	45.1	73.9	53.9	19.8	8.8	Floor noise
Hori.	9608.0	42.8	34.0	38.0	8.3	32.6	-	56.5	47.7	73.9	53.9	17.4	6.2	Floor noise
Vert.	61.3	52.5	-	7.5	7.7	32.3	-	35.4	-	40.0	-	4.6	-	
Vert.	250.0	51.0	-	12.5	9.7	32.1	-	41.0	-	46.0	-	5.0	-	
Vert.	350.0	42.5	-	15.5	10.4	32.1	-	36.4	-	46.0	-	9.7	-	
Vert.	450.0	40.7	-	16.8	11.1	32.1	-	36.5	-	46.0	-	9.5	-	
Vert.	550.0	40.5	-	18.0	11.7	32.1	-	38.1	-	46.0	-	7.9	-	
Vert.	750.0	41.2	-	20.4	12.8	31.8	-	42.6	-	46.0	-	3.4	-	
Vert.	2390.0	42.3	33.9	27.8	4.7	31.8	1.1	42.9	35.6	73.9	53.9	31.0	18.3	*1)
Vert.	4804.0	44.9	37.7	31.6	6.5	31.2	1.1	51.9	45.8	73.9	53.9	22.1	8.1	
Vert.	7206.0	42.9	33.9	36.2	7.4	32.4	-	54.1	45.1	73.9	53.9	19.8	8.8	Floor noise
Vert.	9608.0	42.8	34.0	38.0	8.3	32.6	-	56.5	47.7	73.9	53.9	17.4	6.2	Floor noise

Result (QP / PK) = Reading + Ant Factor + Loss (Cable+Attenuator+Filter+Distance factor(above 1 GHz)) - Gain(Amplifier)

Result (AV) = Reading + Ant Factor + Loss (Cable+Attenuator+Filter+Distance factor(above 1 GHz)) - Gain(Amplifier) + Duty factor

*Other frequency noises omitted in this report were not seen or had enough margin (more than 20 dB).

*QP detector was used up to 1GHz.

*1) Not Out of Band emission(Leakage Power)

20dBc Data Sheet

Polarity	Frequency	Reading (PK)	Ant Factor	Loss	Gain	Result	Limit	Margin	Remark
[Hori/Vert]	[MHz]	[dBuV]	[dB/m]	[dB]	[dB]	[dBuV/m]	[dBuV/m]	[dB]	
Hori.	2402.0	95.5	27.8	4.7	31.8	96.1	-	-	Carrier
Hori.	2400.0	40.2	27.8	4.7	31.8	40.8	76.1	35.3	
Vert.	2402.0	96.5	27.8	4.7	31.8	97.1	-	-	Carrier
Vert.	2400.0	41.2	27.8	4.7	31.8	41.8	77.1	35.3	

Result = Reading + Ant Factor + Loss (Cable+Attenuator+Filter+Distance factor(above 1 GHz)) - Gain(Amplifier)

*Above noise was synchronized with carrier frequency.

Distance factor: 1 GHz - 10 GHz 20log(3.9 m / 3.0 m) = 2.28 dB

10 GHz - 26.5 GHz 20log(1.0 m / 3.0 m) = -9.5 dB

UL Japan, Inc.

Ise EMC Lab.

4383-326 Asama-cho, Ise-shi, Mie-ken 516-0021 JAPAN

Telephone : +81 596 24 8999

Facsimile : +81 596 24 8124

Radiated Spurious Emission
(Reference Plot for band-edge)

Report No. 14007298H
Test place Ise EMC Lab.
Semi Anechoic Chamber No.4
Date September 13, 2021
Temperature / Humidity 22 deg. C / 70 % RH
Engineer Akihiko Maeda
(1 GHz -10 GHz)
Mode Tx, Hopping Off, 3DH5 2402 MHz

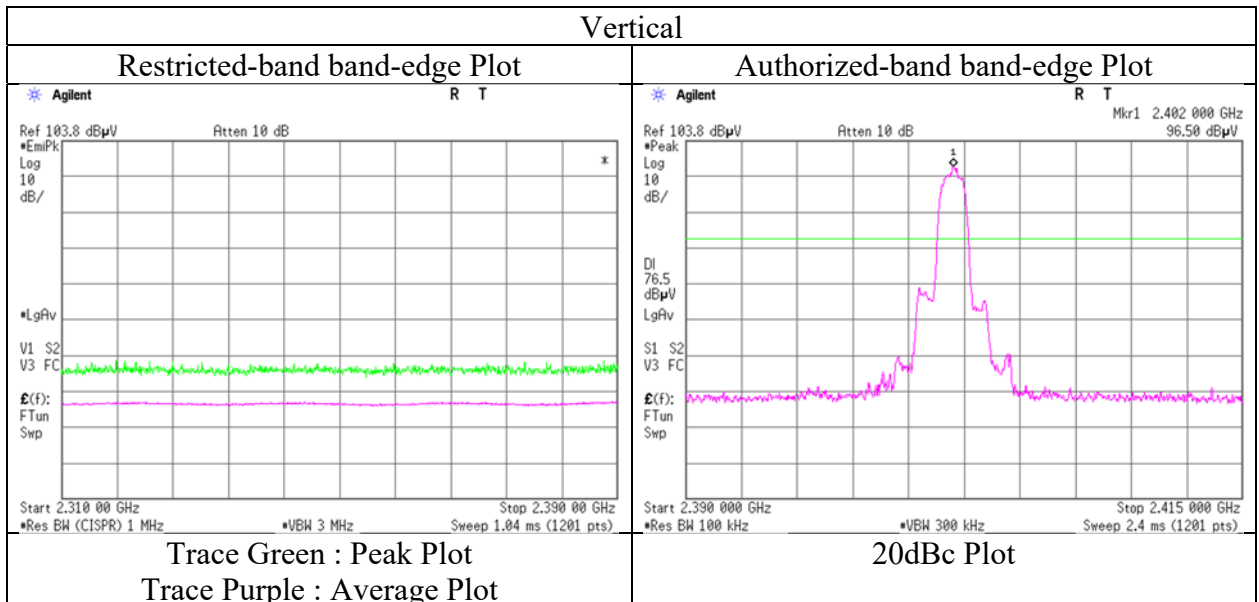
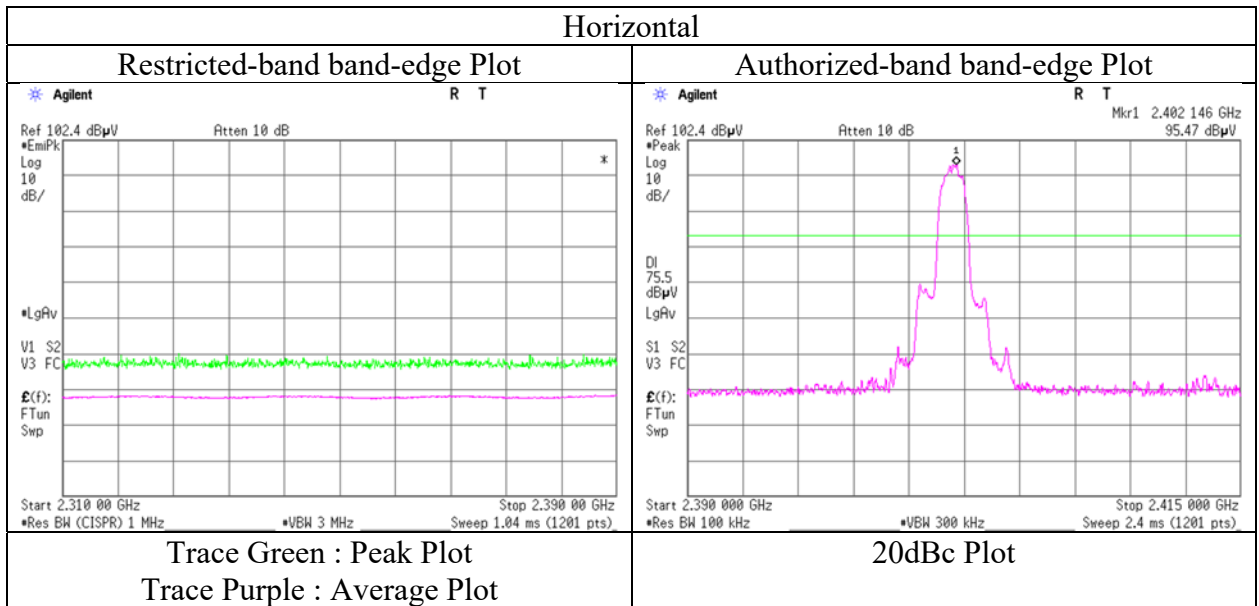

* The measurement was conducted for a sufficiently long enough time to detect any possible spurious emissions. Final result of restricted band edge was shown in tabular data.

UL Japan, Inc.

Ise EMC Lab.

4383-326 Asama-cho, Ise-shi, Mie-ken 516-0021 JAPAN

Telephone : +81 596 24 8999

Facsimile : +81 596 24 8124

Radiated Spurious Emission

Report No.	14007298H			
Test place	Ise EMC Lab.			
Semi Anechoic Chamber	No.4	No.4	No.4	No.3
Date	September 13, 2021	September 14, 2021	September 15, 2021	September 26, 2021
Temperature / Humidity	22 deg. C / 70 % RH	23 deg. C / 65 % RH	22 deg. C / 67 % RH	22 deg. C / 66 % RH
Engineer	Akihiko Maeda	Nachi Konegawa	Kiyoshiro Okazaki	Hiroki Numata
	(1 GHz - 10 GHz)	(10 GHz - 18 GHz)	(18 GHz - 26.5 GHz)	(Below 1 GHz)
Mode	Tx, Hopping Off, 3DH5 2441 MHz			

Polarity [Hori/Vert]	Frequency [MHz]	Reading (QP / PK) [dBuV]	Reading (AV) [dBuV]	Ant. Factor [dB/m]	Loss [dB]	Gain [dB]	Duty Factor [dB]	Result (QP / PK) [dBuV/m]	Result (AV) [dBuV/m]	Limit (QP / PK) [dBuV/m]	Limit (AV) [dBuV/m]	Margin (QP / PK) [dB]	Margin (AV) [dB]	Remark
Hori.	61.3	38.9	-	7.5	7.7	32.3	-	21.8	-	40.0	-	18.2	-	
Hori.	250.0	55.0	-	12.5	9.7	32.1	-	45.0	-	46.0	-	1.0	-	
Hori.	350.0	50.9	-	15.5	10.4	32.1	-	44.8	-	46.0	-	1.3	-	
Hori.	450.0	42.3	-	16.8	11.1	32.1	-	38.1	-	46.0	-	7.9	-	
Hori.	550.0	42.5	-	18.0	11.7	32.1	-	40.1	-	46.0	-	5.9	-	
Hori.	750.0	40.7	-	20.4	12.8	31.8	-	42.1	-	46.0	-	3.9	-	
Hori.	4882.0	43.0	35.9	31.6	6.5	31.2	1.1	50.0	44.0	73.9	53.9	23.9	9.9	
Hori.	7323.0	42.7	34.2	36.3	7.5	32.4	-	54.0	45.5	73.9	53.9	19.9	8.4	Floor noise
Hori.	9764.0	42.3	33.6	38.4	8.3	32.7	-	56.4	47.7	73.9	53.9	17.5	6.2	Floor noise
Vert.	61.3	52.5	-	7.5	7.7	32.3	-	35.4	-	40.0	-	4.6	-	
Vert.	250.0	51.1	-	12.5	9.7	32.1	-	41.1	-	46.0	-	4.9	-	
Vert.	350.0	42.5	-	15.5	10.4	32.1	-	36.4	-	46.0	-	9.7	-	
Vert.	450.0	40.6	-	16.8	11.1	32.1	-	36.4	-	46.0	-	9.6	-	
Vert.	550.0	40.5	-	18.0	11.7	32.1	-	38.1	-	46.0	-	7.9	-	
Vert.	750.0	41.3	-	20.4	12.8	31.8	-	42.7	-	46.0	-	3.3	-	
Vert.	4882.0	43.7	35.9	31.6	6.5	31.2	1.1	50.7	44.0	73.9	53.9	23.2	9.9	
Vert.	7323.0	42.7	34.2	36.3	7.5	32.4	-	54.0	45.5	73.9	53.9	19.9	8.4	Floor noise
Vert.	9764.0	42.3	33.6	38.4	8.3	32.7	-	56.4	47.7	73.9	53.9	17.5	6.2	Floor noise

Result (QP / PK) = Reading + Ant Factor + Loss (Cable+Attenuator+Filter+Distance factor(above 1 GHz)) - Gain(Amplifier)

Result (AV)= Reading + Ant Factor + Loss (Cable+Attenuator+Filter+Distance factor(above 1 GHz)) - Gain(Amplifier) + Duty factor

*Other frequency noises omitted in this report were not seen or had enough margin (more than 20 dB).

*QP detector was used up to 1GHz.

Distance factor: 1 GHz - 10 GHz 20log(3.9 m / 3.0 m) = 2.28 dB
 10 GHz - 26.5 GHz 20log(1.0 m / 3.0 m) = -9.5 dB

Radiated Spurious Emission

Report No.	14007298H			
Test place	Ise EMC Lab.			
Semi Anechoic Chamber	No.4	No.4	No.4	No.3
Date	September 13, 2021	September 14, 2021	September 15, 2021	September 26, 2021
Temperature / Humidity	22 deg. C / 70 % RH	23 deg. C / 65 % RH	22 deg. C / 67 % RH	22 deg. C / 66 % RH
Engineer	Akihiko Maeda	Nachi Konegawa	Kiyoshiro Okazaki	Hiroki Numata
	(1 GHz -10 GHz)	(10 GHz - 18 GHz)	(18 GHz - 26.5 GHz)	(Below 1 GHz)
Mode	Tx, Hopping Off, 3DH5 2480 MHz			

Polarity [Hori/Vert]	Frequency [MHz]	Reading (QP / PK) [dBuV]	Reading (AV) [dBuV]	Ant. Factor [dB/m]	Loss [dB]	Gain [dB]	Duty Factor [dB]	Result (QP / PK) [dBuV/m]	Result (AV) [dBuV/m]	Limit (QP / PK) [dBuV/m]	Limit (AV) [dBuV/m]	Margin (QP / PK) [dB]	Margin (AV) [dB]	Remark
Hori.	61.3	38.8	-	7.5	7.7	32.3	-	21.7	-	40.0	-	18.3	-	
Hori.	250.0	55.1	-	12.5	9.7	32.1	-	45.1	-	46.0	-	0.9	-	
Hori.	350.0	50.9	-	15.5	10.4	32.1	-	44.8	-	46.0	-	1.3	-	
Hori.	450.0	42.2	-	16.8	11.1	32.1	-	38.0	-	46.0	-	8.0	-	
Hori.	550.0	42.5	-	18.0	11.7	32.1	-	40.1	-	46.0	-	5.9	-	
Hori.	750.0	40.7	-	20.4	12.8	31.8	-	42.1	-	46.0	-	3.9	-	
Hori.	2483.5	50.8	37.1	27.7	4.7	31.8	1.1	51.4	38.8	73.9	53.9	22.5	15.1	*1)
Hori.	4960.0	42.0	33.8	31.7	6.6	31.2	1.1	49.1	42.0	73.9	53.9	24.8	11.9	
Hori.	7440.0	42.8	34.7	36.5	7.5	32.5	-	54.3	46.2	73.9	53.9	19.6	7.7	Floor noise
Hori.	9920.0	41.5	33.4	38.6	8.3	32.7	-	55.7	47.6	73.9	53.9	18.3	6.4	Floor noise
Vert.	61.3	52.5	-	7.5	7.7	32.3	-	35.4	-	40.0	-	4.6	-	
Vert.	250.0	51.3	-	12.5	9.7	32.1	-	41.3	-	46.0	-	4.7	-	
Vert.	350.0	41.6	-	15.5	10.4	32.1	-	35.5	-	46.0	-	10.6	-	
Vert.	450.0	40.5	-	16.8	11.1	32.1	-	36.3	-	46.0	-	9.7	-	
Vert.	550.0	40.6	-	18.0	11.7	32.1	-	38.2	-	46.0	-	7.8	-	
Vert.	750.0	41.2	-	20.4	12.8	31.8	-	42.6	-	46.0	-	3.4	-	
Vert.	2483.5	51.1	36.1	27.7	4.7	31.8	1.1	51.7	37.8	73.9	53.9	22.2	16.1	*1)
Vert.	4960.0	41.2	34.5	31.7	6.6	31.2	1.1	48.3	42.7	73.9	53.9	25.6	11.2	
Vert.	7440.0	42.8	34.7	36.5	7.5	32.5	-	54.3	46.2	73.9	53.9	19.6	7.7	Floor noise
Vert.	9920.0	41.5	33.4	38.6	8.3	32.7	-	55.7	47.6	73.9	53.9	18.3	6.4	Floor noise

Result (QP / PK) = Reading + Ant Factor + Loss (Cable+Attenuator+Filter+Distance factor(above 1 GHz)) - Gain(Amplifier)

Result (AV) = Reading + Ant Factor + Loss (Cable+Attenuator+Filter+Distance factor(above 1 GHz)) - Gain(Amplifier) + Duty factor

*Other frequency noises omitted in this report were not seen or had enough margin (more than 20 dB).

*QP detector was used up to 1GHz.

*1) Not Out of Band emission(Leakage Power)

Distance factor: 1 GHz - 10 GHz 20log(3.9 m / 3.0 m) = 2.28 dB

10 GHz - 26.5 GHz 20log(1.0 m / 3.0 m) = -9.5 dB

UL Japan, Inc.

Ise EMC Lab.

4383-326 Asama-cho, Ise-shi, Mie-ken 516-0021 JAPAN

Telephone : +81 596 24 8999

Facsimile : +81 596 24 8124

Radiated Spurious Emission
(Reference Plot for band-edge)

Report No. 14007298H
Test place Ise EMC Lab.
Semi Anechoic Chamber No.4
Date September 13, 2021
Temperature / Humidity 22 deg. C / 70 % RH
Engineer Akihiko Maeda
(1 GHz -10 GHz)
Mode Tx, Hopping Off, 3DH5 2480 MHz

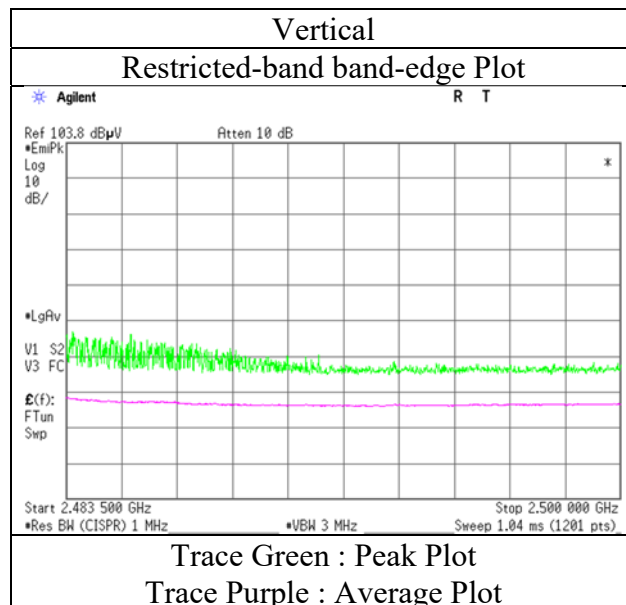
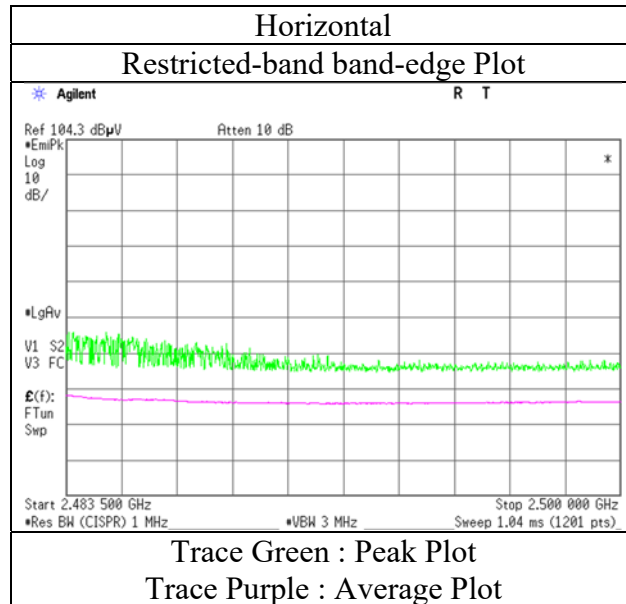

* The measurement was conducted for a sufficiently long enough time to detect any possible spurious emissions. Final result of restricted band edge was shown in tabular data.

Radiated Spurious Emission
(Plot data, Worst case mode for Maximum Peak Output Power)

Report No.	14007298H			
Test place	Ise EMC Lab.			
Semi Anechoic Chamber	No.4	No.4	No.4	No.3
Date	September 13, 2021	September 14, 2021	September 15, 2021	September 26, 2021
Temperature / Humidity	22 deg. C / 70 % RH	23 deg. C / 65 % RH	22 deg. C / 67 % RH	22 deg. C / 66 % RH
Engineer	Akihiko Maeda (1 GHz - 10 GHz)	Nachi Konegawa (10 GHz - 18 GHz)	Kiyoshiro Okazaki (18 GHz - 26.5 GHz)	Hiroki Numata (Below 1 GHz)
Mode	Tx, Hopping Off, DH5 2402 MHz			

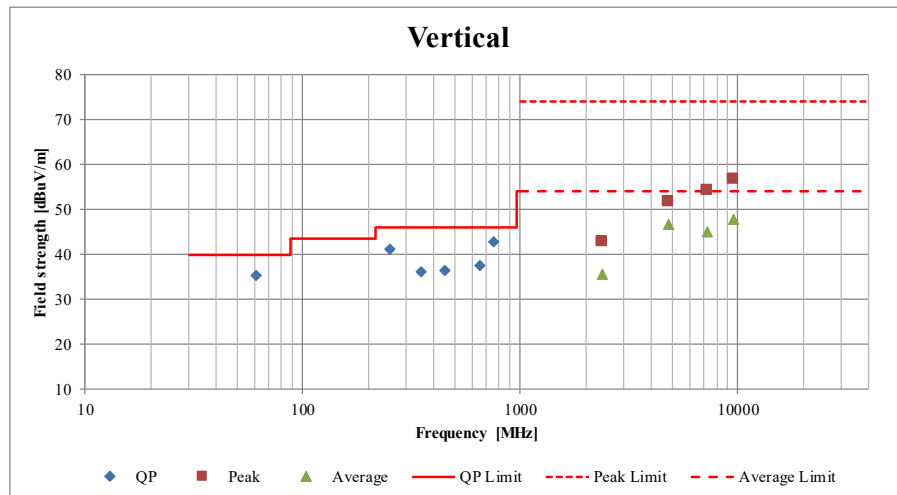
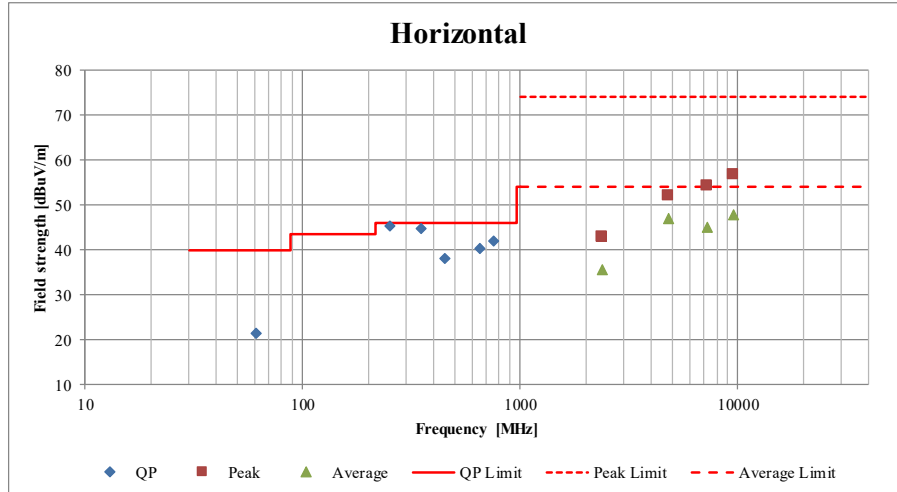

*These plots data contains sufficient number to show the trend of characteristic features for EUT.

APPENDIX 2: Test instruments

Test equipment

Test Item	Local ID	LIMS ID	Description	Manufacturer	Model	Serial	Last Calibration Date	Cal Int
RE	MOS-15	141562	Thermo-Hygrometer	CUSTOM. Inc	CTH-201	0010	01/15/2021	12
RE	MMM-10	141545	DIGITAL HiTESTER	HIOKI E.E. CORPORATION	3805	51201148	01/07/2021	12
RE	MJM-29	142230	Measure	KOMELON	KMC-36	-	-	-
RE	COTS-MEMI-02	178648	EMI measurement program	TSJ (Techno Science Japan)	TEPTO-DV	-	-	-
RE	MAEC-04-SVSWR	142017	AC4_Semi Anechoic Chamber(SVSWR)	TDK	Semi Anechoic Chamber 3m	DA-10005	04/12/2021	24
RE	MSA-03	141884	Spectrum Analyzer	Keysight Technologies Inc	E4448A	MY44020357	03/10/2021	12
RE	MHA-21	141508	Horn Antenna 1-18GHz	Schwarzbeck Mess-Elektronik OHG	BBHA9120D	557	05/10/2021	12
RE	MPA-12	141581	MicroWave System Amplifier	Keysight Technologies Inc	83017A	00650	10/19/2020	12
RE	MCC-257	208936	Microwave Cable	Huber+Suhner	SF126E/11PC35/11PC35/1000M,5000M	537061/126E / 537076/126E	07/18/2021	12
RE	MHF-06	141404	High Pass Filter 3.5-24GHz	TOKIMEC	TF323DCA	601	05/18/2021	12
RE	MHF-25	141232	High Pass Filter 3.5-18.0GHz	UL Japan	HPF SELECTOR	001	09/23/2020	12
RE	MAEC-03	142008	AC3_Semi Anechoic Chamber(NSA)	TDK	Semi Anechoic Chamber 3m	DA-10005	05/22/2020	24
RE	MOS-13	141554	Thermo-Hygrometer	CUSTOM. Inc	CTH-201	1301	01/15/2021	12
RE	MMM-08	141532	DIGITAL HiTESTER	HIOKI E.E. CORPORATION	3805	51201197	01/07/2021	12
RE	MJM-16	142183	Measure	KOMELON	KMC-36	-	-	-
RE	MAT-95	142314	Attenuator	Pasternack Enterprises	PE7390-6	D/C 1504	06/09/2021	12
RE	MBA-03	141424	Biconical Antenna	Schwarzbeck Mess-Elektronik OHG	VHA9103+ BBA9106	1915	08/21/2021	12
RE	MCC-51	141323	Coaxial cable	UL Japan	-	-	07/19/2021	12
RE	MLA-20	141264	Logperiodic Antenna (200-1000MHz)	Schwarzbeck Mess-Elektronik OHG	VUSLP9111B	189	04/10/2021	12
RE	MPA-13	141582	Pre Amplifier	SONOMA INSTRUMENT	310	260834	02/18/2021	12
RE	MTR-03	141942	Test Receiver	Rohde & Schwarz	ESCI	100300	08/05/2021	12

*Hyphens for Last Calibration Date and Cal Int (month) are instruments that Calibration is not required (e.g. software), or instruments checked in advance before use.

The expiration date of the calibration is the end of the expired month.

As for some calibrations performed after the tested dates, those test equipment have been controlled by means of an unbroken chains of calibrations.

All equipment is calibrated with valid calibrations. Each measurement data is traceable to the national or international standards.

Test item: RE: Radiated Emission test

UL Japan, Inc.

Ise EMC Lab.

4383-326 Asama-cho, Ise-shi, Mie-ken 516-0021 JAPAN

Telephone : +81 596 24 8999

Facsimile : +81 596 24 8124