

25055RE1-A HANDSET

H/S LCD POP LABEL
SIZE: 51 X 63 mm

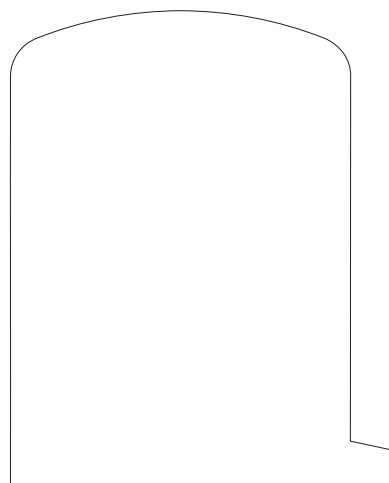

IMPORTANT SHEET
SIZE: 44 x 100 mm

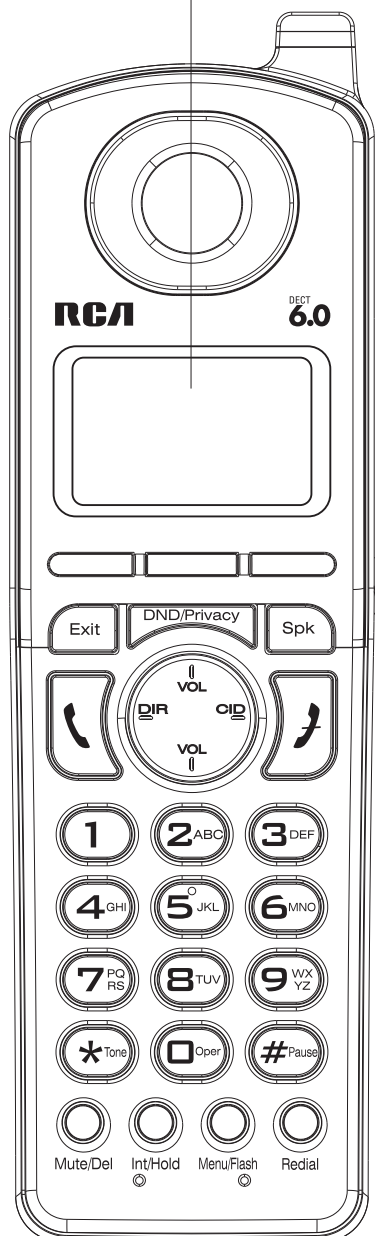
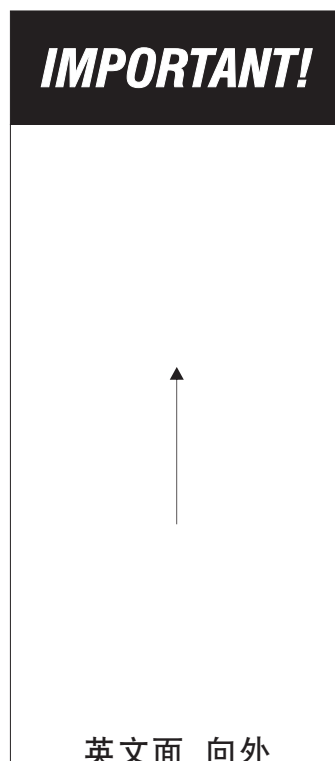

25055RE1-A HANDSET

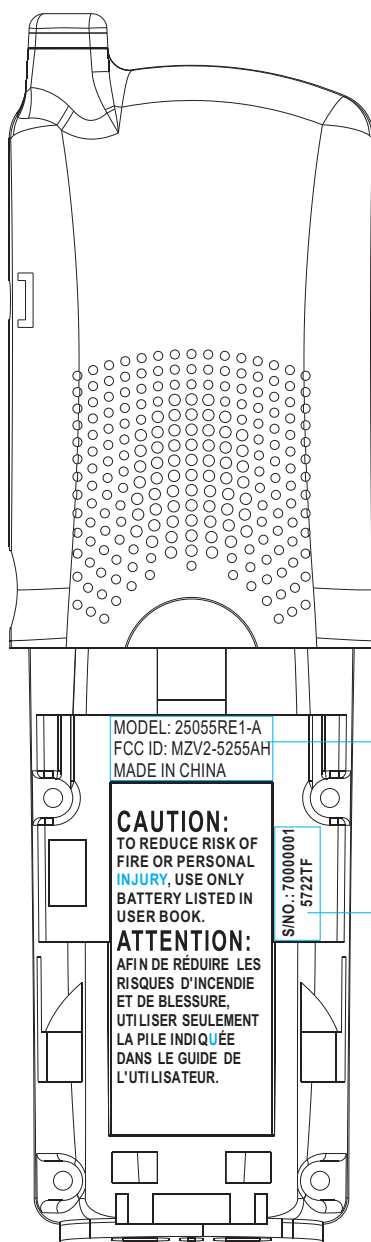
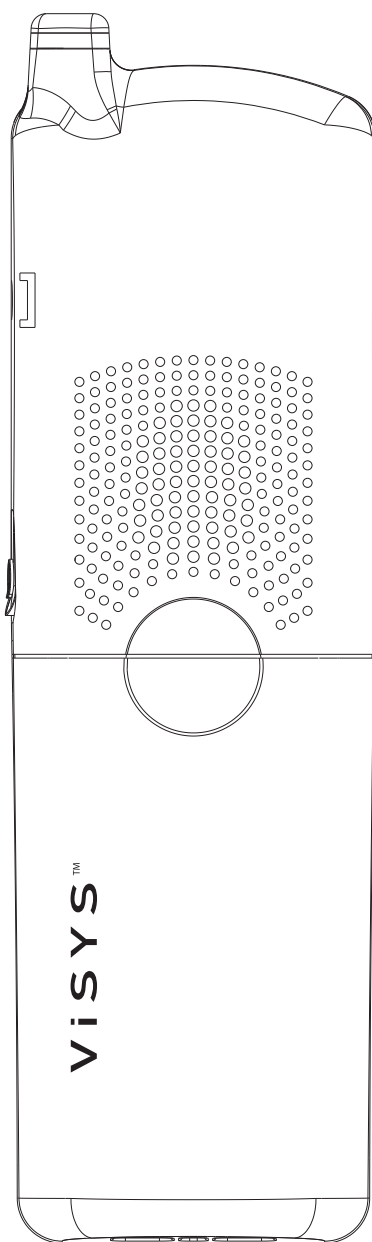

FCC ID LABEL
SIZE: 21 x 7.8 mm

S/NO. & DATE CODE LABEL
SIZE: 14.5 x 5.5 mm

MODEL: 25055RE1-A
FCC ID: MZV2-5255AH
MADE IN CHINA

CAUTION:
TO REDUCE RISK OF
FIRE OR PERSONAL
INJURY, USE ONLY
BATTERY LISTED IN
USER BOOK.

ATTENTION:
AFIN DE RÉDUIRE LES
RISQUES D'INCENDIE
ET DE BLESSURE,
UTILISER SEULEMENT
LA PILE INDICUÉE
DANS LE GUIDE DE
L'UTILISATEUR.

S/NO.: 70000001
5722TF

25055RE1-A CHARGER

CHARGER S/NO. & DATE CODE LABEL

SIZE: 52 x 13 mm

S/NO. must be the same as BASE, H/S S/NO.

DATE CODE must be the same as BASE, H/S Date code.

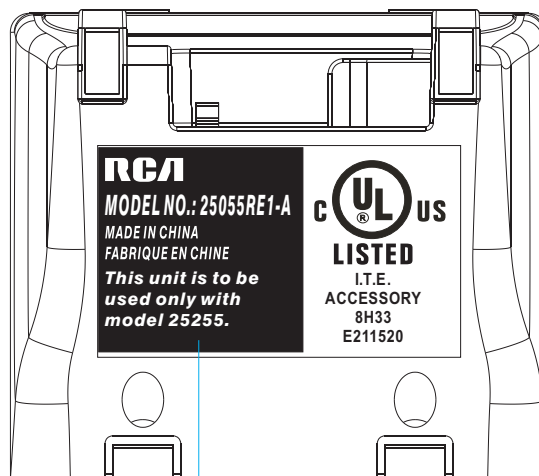
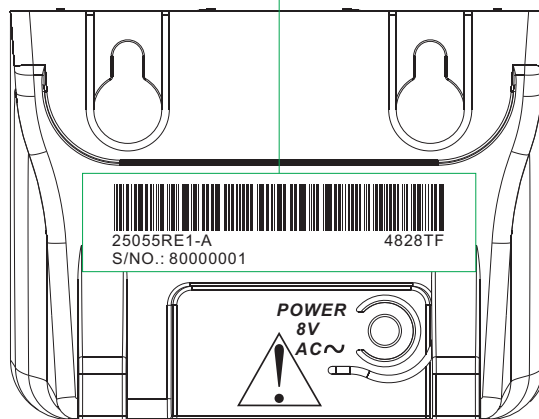
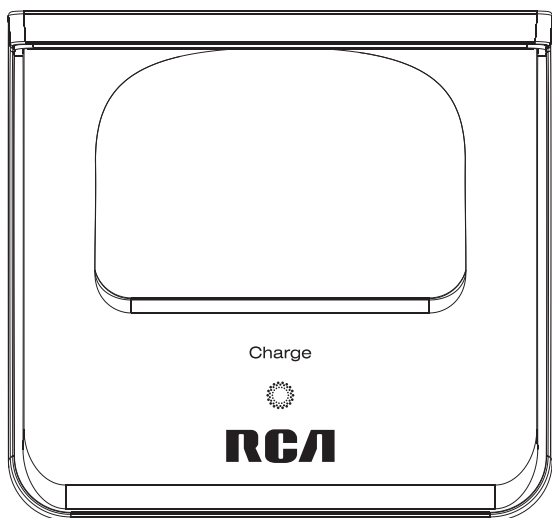

CHARGER MODEL NO. LABEL

SIZE: 27*27 mm