

LABEL, LCD POP,
SIZE: 51*63 mm

IMPORTANT SHEET
SIZE: 44*100mm

IMPORTANT!

英文面向外

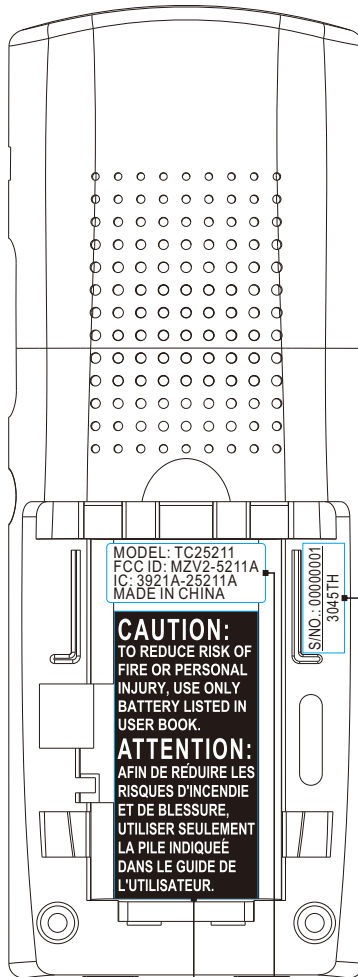

S/NO. & DATE CODE LABEL

SIZE: 14.5 * 5.5 mm

S/NO. must be the
same as base,
date code must be
the same as base
有下划线表示符合ROHS标准
TF表示广州生产,
TH表示惠州生产

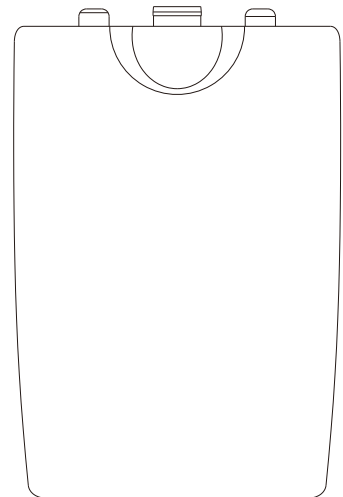

FCC ID LABEL
SIZE: 21*7.8mm

CAUTION LABEL
SIZE: 19*38mm

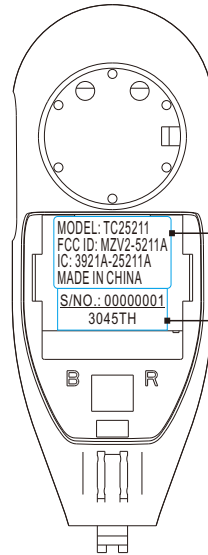

Headset battery label
Size: 15.5*9.5mm

S/NO. & DATE CODE LABEL
SIZE: 14.5 * 5.5 mm

S/NO. must be the same as base,
date code must be the same as base
有下划线表示符合ROHS标准
TF表示广州生产,
TH表示惠州生产

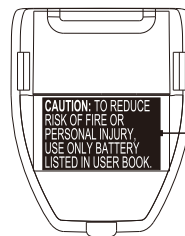

Headset caution label
Size: 15.5*9.5mm

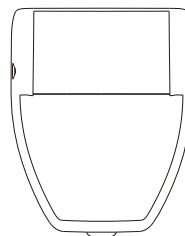

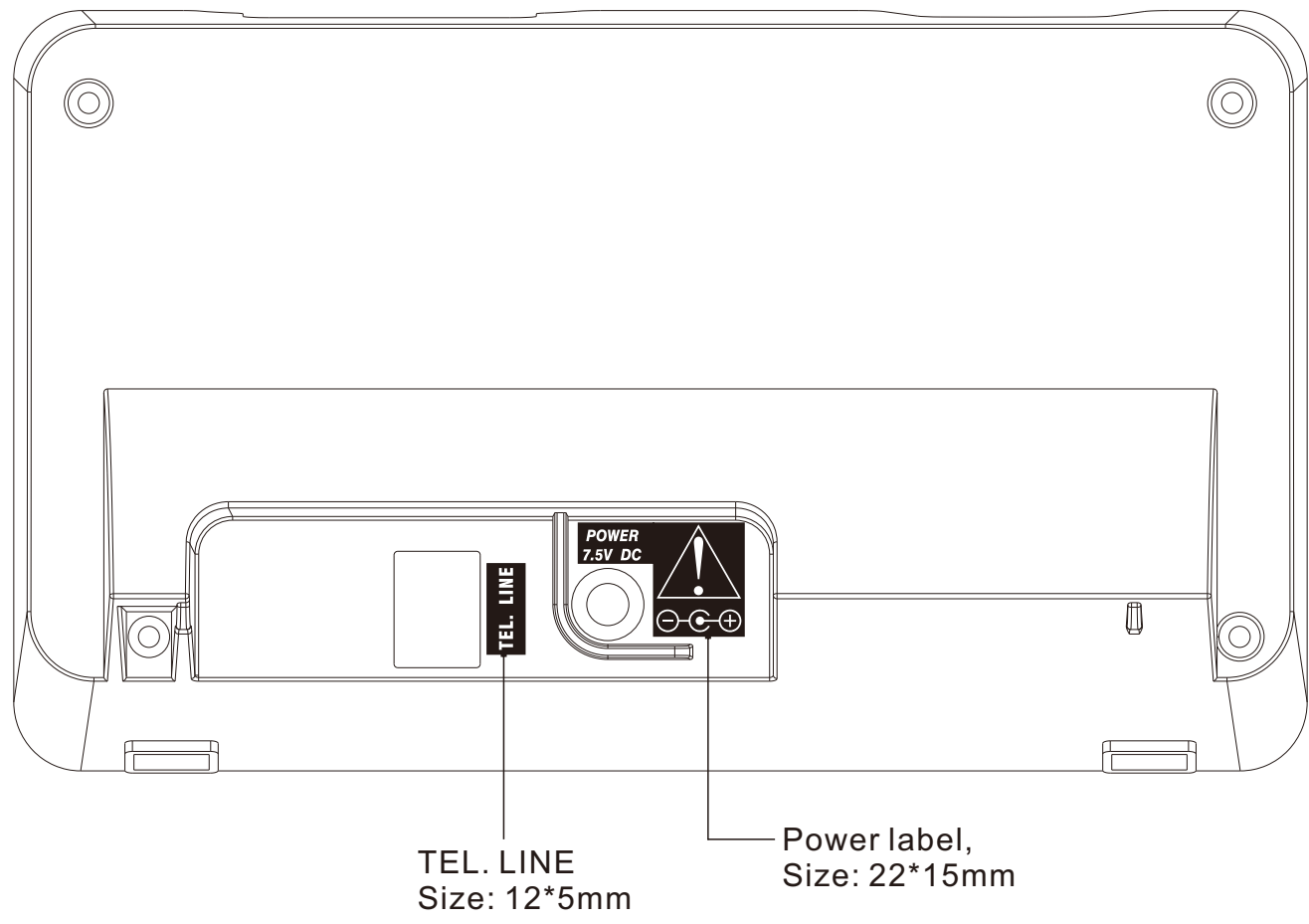

CLASS B label,
Size: 25*15mm

Model NO. label,
Size: 41.5*18.5mm
交货广州 : 4001331
交货惠州 : 4001332

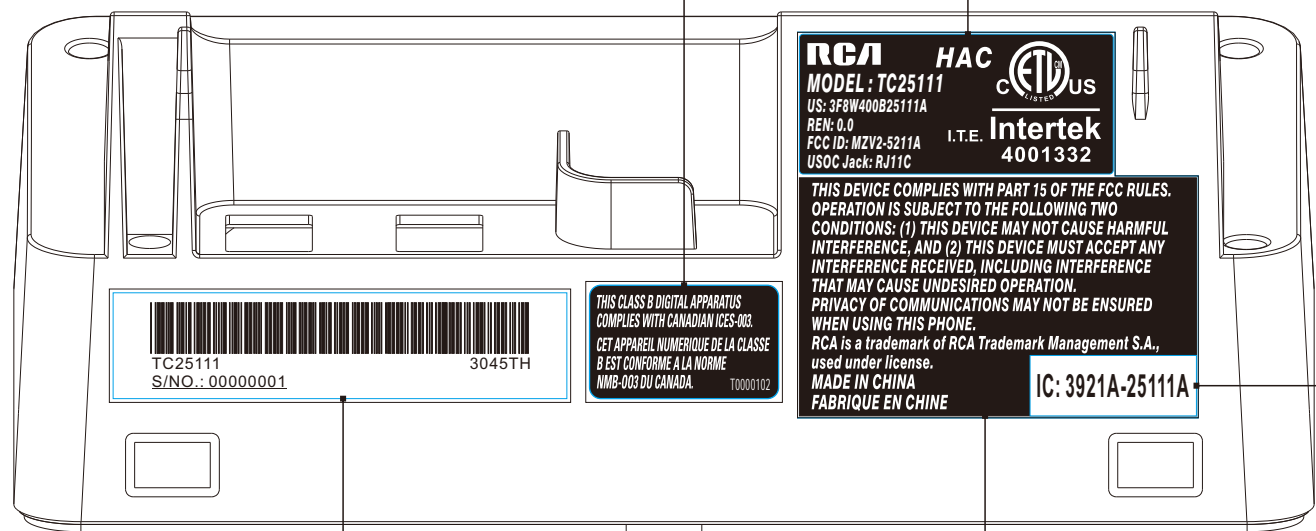

SERIAL NO. LABEL, GZ PRINT,
SIZE: 60*14 mm
TF表示广州生产, TH表示惠州生产

PART 15 LABEL label,
Size: 52.5*31.5mm

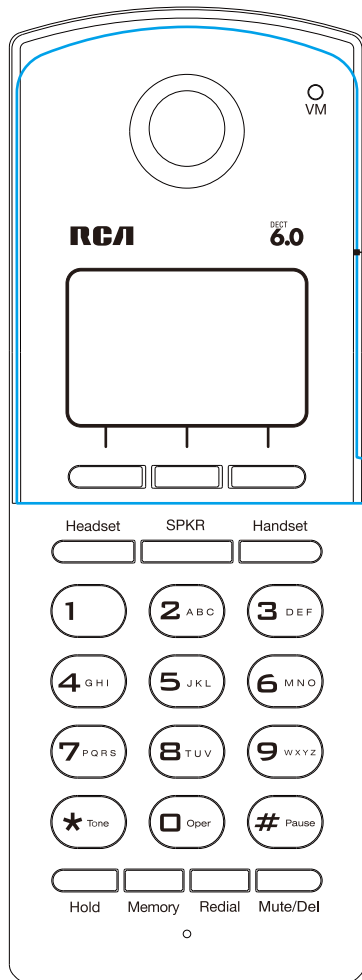

LABEL, LCD POP,
SIZE: 51*63 mm

IMPORTANT SHEET
SIZE: 44*100mm

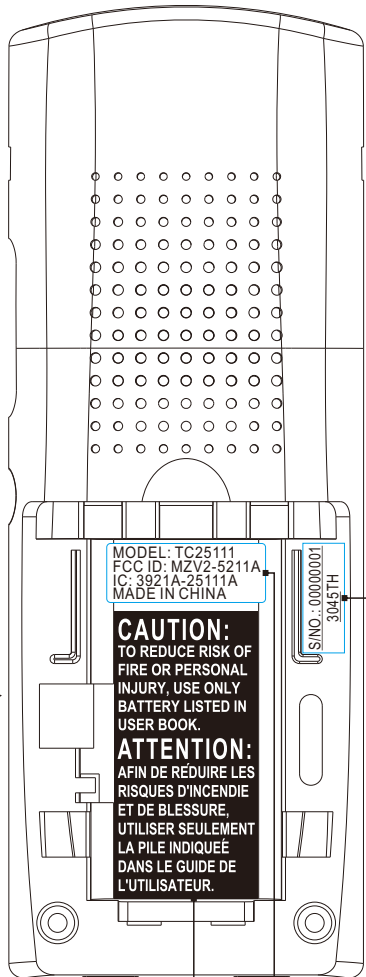

S/NO. & DATE CODE LABEL
 SIZE: 14.5 * 5.5 mm
 S/NO. must be the same as base,
 date code must be the same as base
 有下划线表示符合ROHS标准
 TF表示广州生产,
 TH表示惠州生产

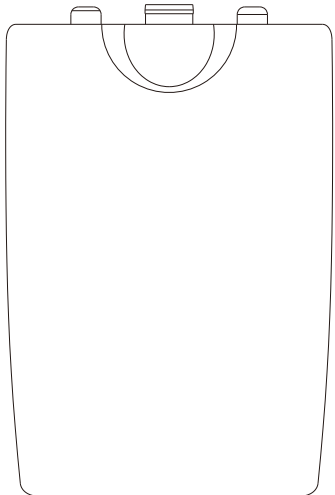

FCC ID LABEL
 SIZE: 21*7.8mm

CAUTION LABEL
 SIZE: 19*38mm

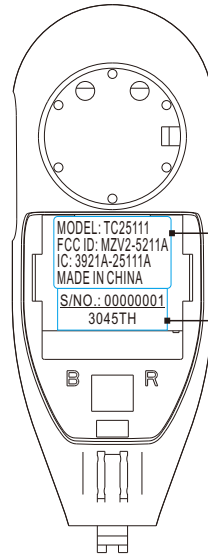

Headset battery label
Size: 15.5*9.5mm

S/NO. & DATE CODE LABEL
SIZE: 14.5 * 5.5 mm

S/NO. must be the same as base,
date code must be the same as base
有下划线表示符合ROHS标准
TF表示广州生产,
TH表示惠州生产

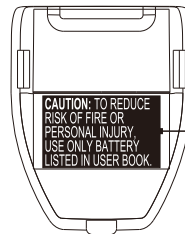

Headset caution label
Size: 15.5*9.5mm

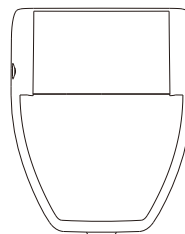

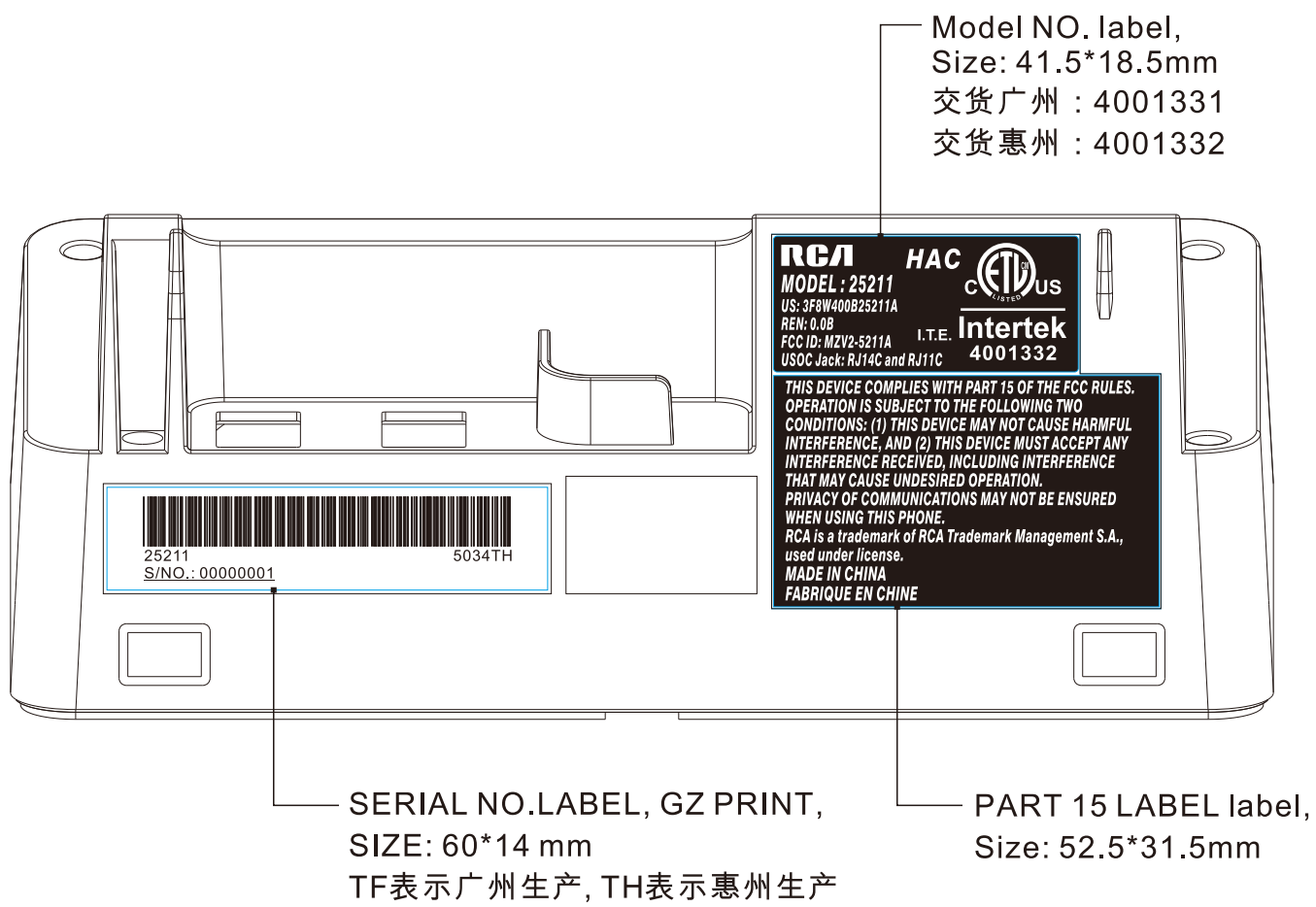
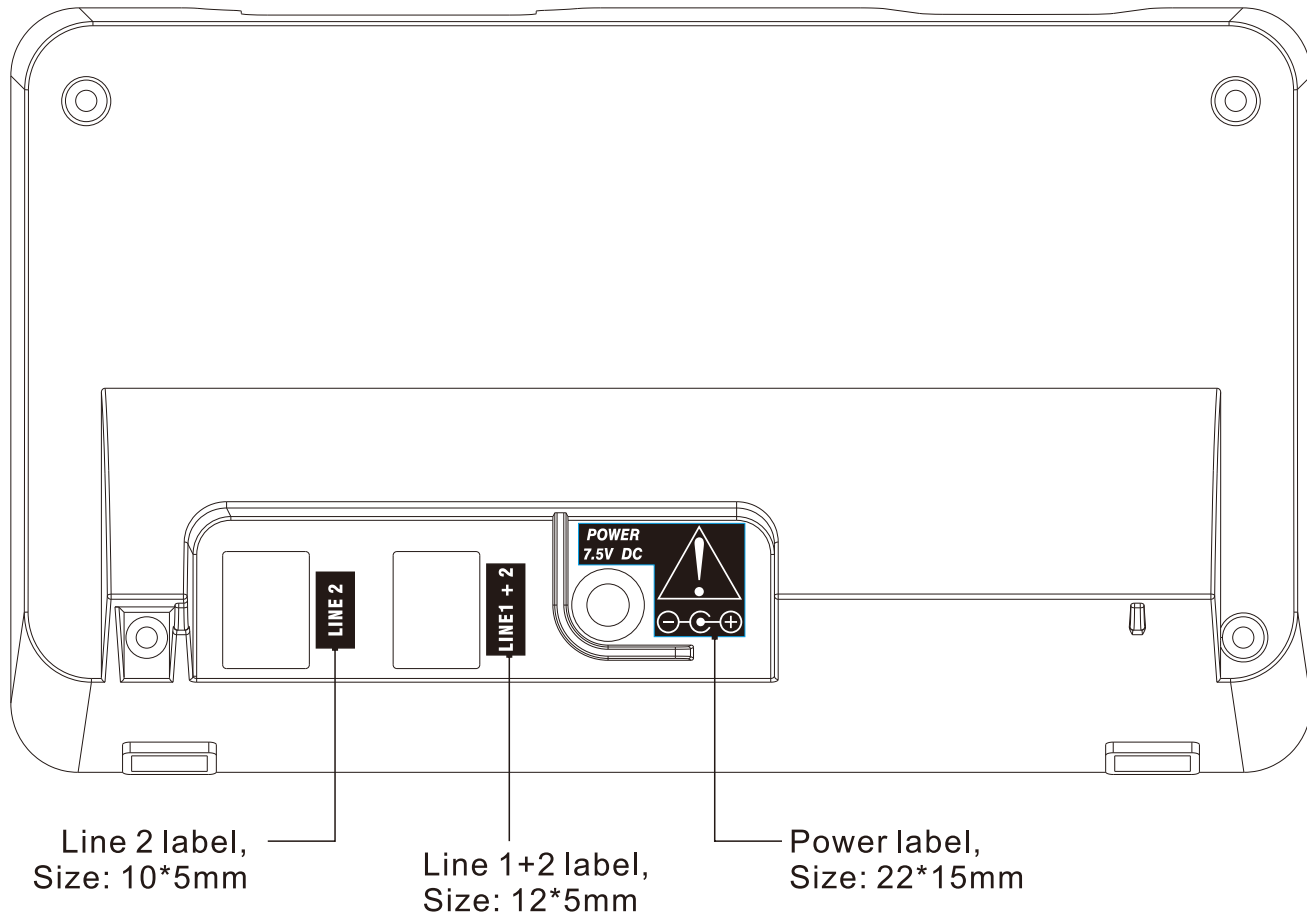

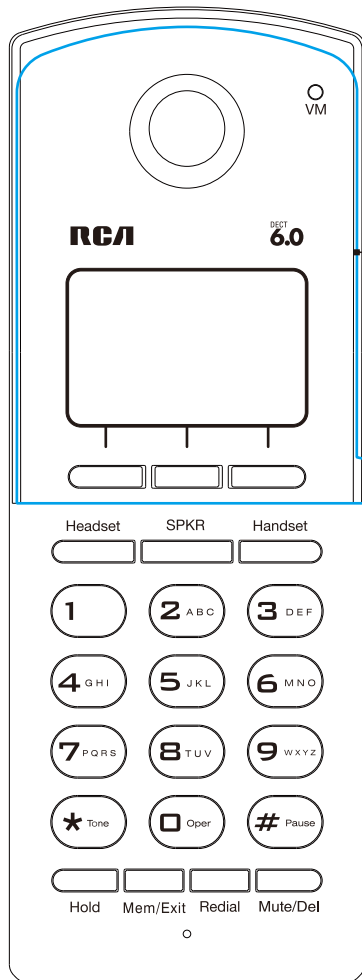

LABEL, LCD POP,
SIZE: 51*63 mm

IMPORTANT SHEET
SIZE: 44*100mm

IMPORTANT!

英文面向外

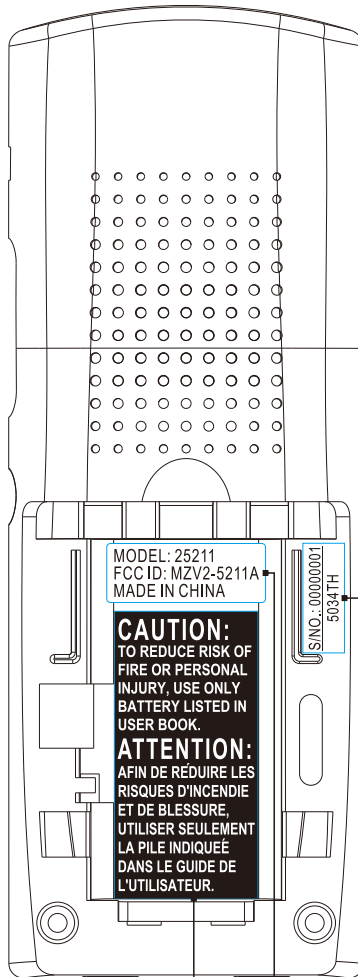

S/NO. & DATE CODE LABEL
 SIZE: 14.5 * 5.5 mm
 S/NO. must be the same as base,
 date code must be the same as base
 有下划线表示符合ROHS标准
 TF表示广州生产,
 TH表示惠州生产

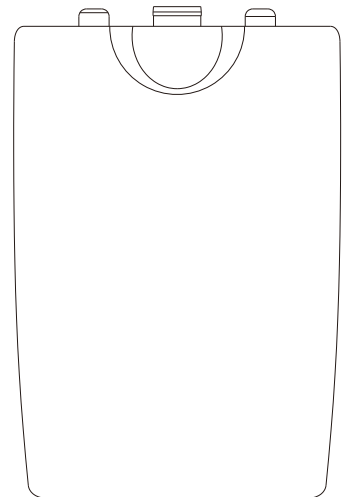

MODEL: 25211
 FCC ID: MZV2-5211A
 MADE IN CHINA

CAUTION:
 TO REDUCE RISK OF
 FIRE OR PERSONAL
 INJURY, USE ONLY
 BATTERY LISTED IN
 USER BOOK.
ATTENTION:
 AFIN DE REDUIRE LES
 RISQUES D'INCENDIE
 ET DE BLESSURE,
 UTILISER SEULEMENT
 LA PILE INDIQUEE
 DANS LE GUIDE DE
 L'UTILISATEUR.

S/NO.: 00000001
 5034TH

FCC ID LABEL
 SIZE: 21*7.8mm

CAUTION LABEL
 SIZE: 19*38mm

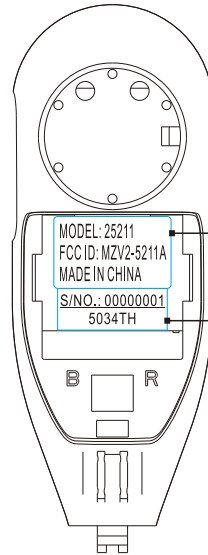

Headset battery label
Size: 15.5*9.5mm

S/NO. & DATE CODE LABEL
SIZE: 14.5 * 5.5 mm

S/NO. must be the same as base,
date code must be the same as base
有下划线表示符合ROHS标准
TF表示广州生产,
TH表示惠州生产



Headset caution label
Size: 15.5*9.5mm

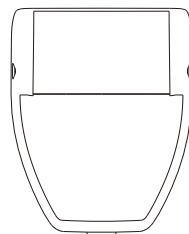

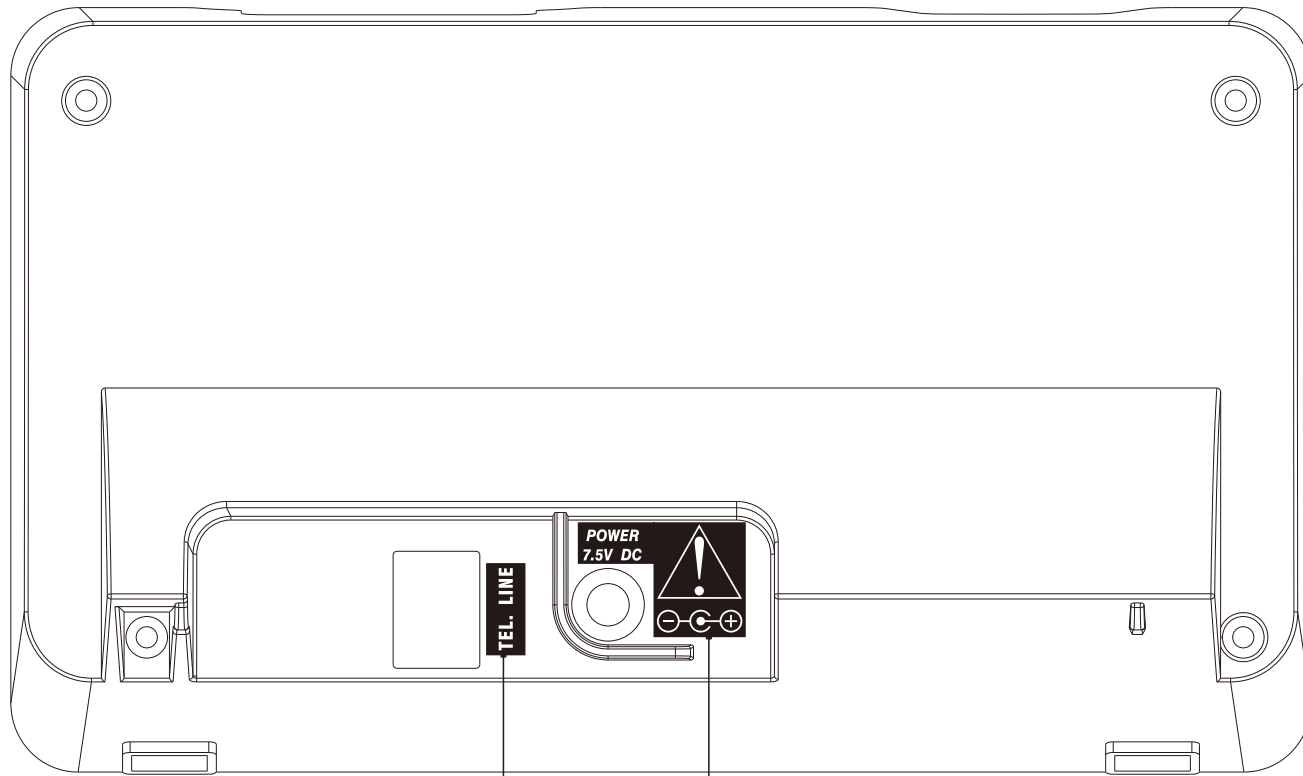

TEL. LINE
Size: 12*5mm

Power label,
Size: 22*15mm

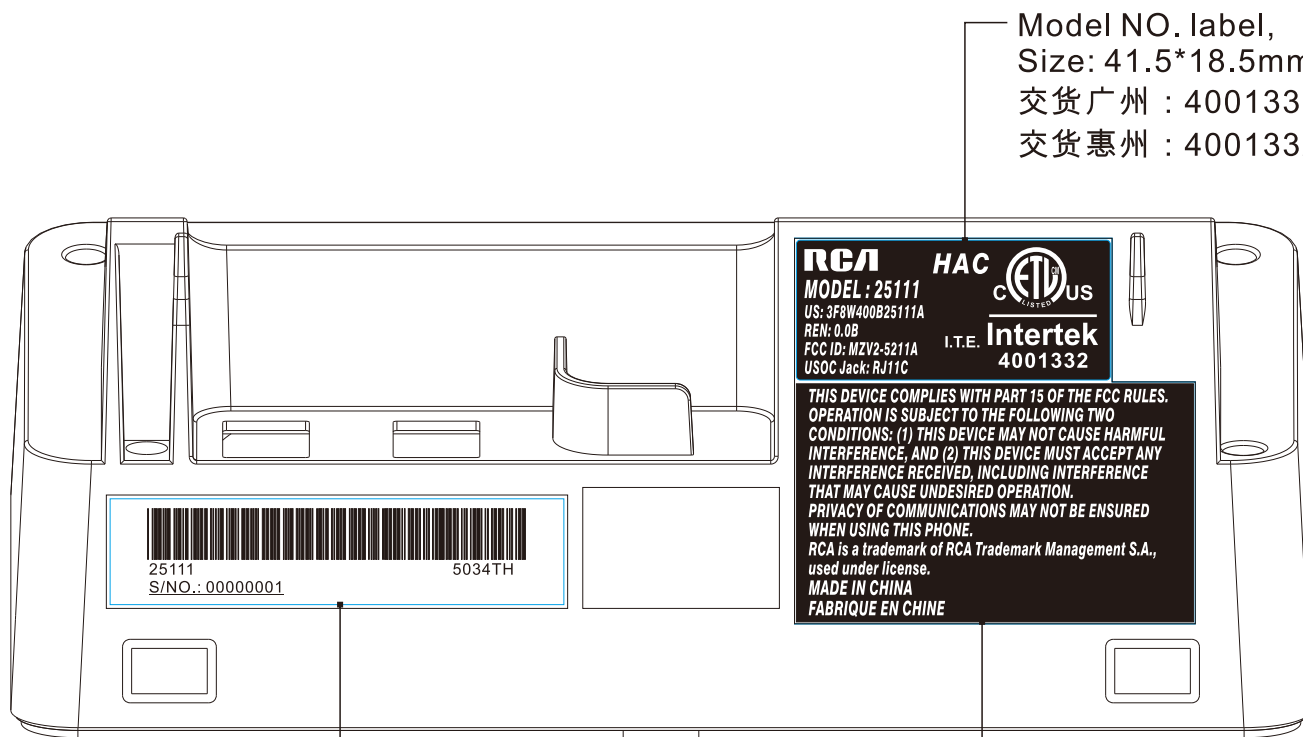

Model NO. label,
Size: 41.5*18.5mm
交货广州 : 4001331
交货惠州 : 4001332

SERIAL NO.LABEL, GZ PRINT,
SIZE: 60*14 mm
TF表示广州生产, TH表示惠州生产

PART 15 LABEL label,
Size: 52.5*31.5mm

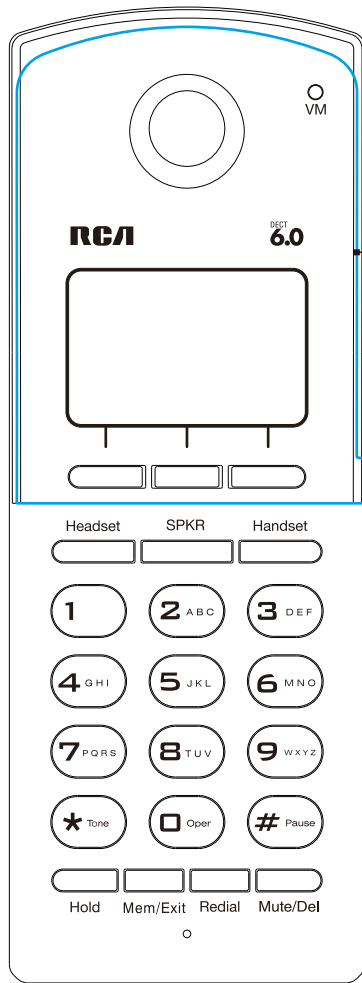

LABEL, LCD POP,
SIZE: 51*63 mm

IMPORTANT SHEET
SIZE: 44*100mm

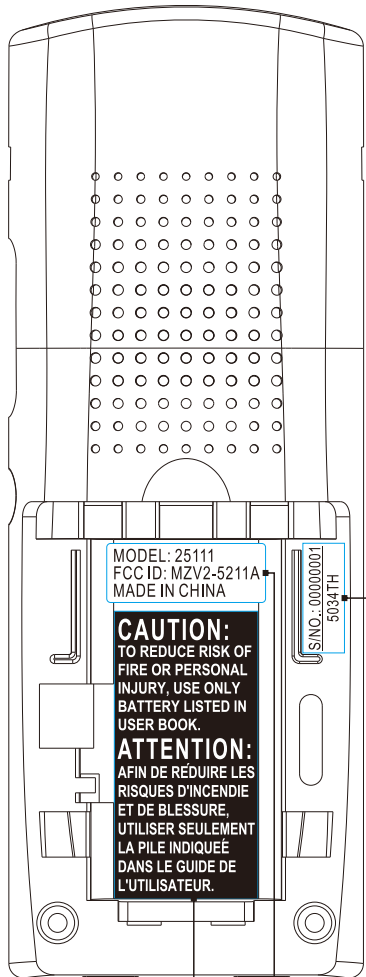

S/NO. & DATE CODE LABEL
 SIZE: 14.5 * 5.5 mm
 S/NO. must be the same as base,
 date code must be the same as base
 有下划线表示符合ROHS标准
 TF表示广州生产,
 TH表示惠州生产

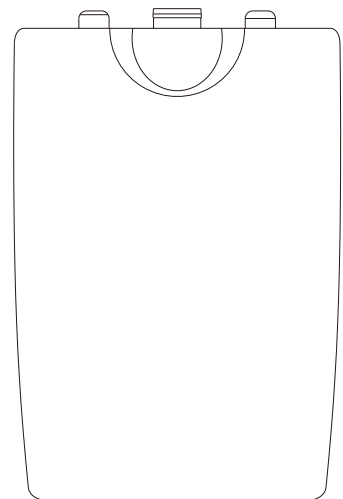

FCC ID LABEL
 SIZE: 21*7.8mm

CAUTION LABEL
 SIZE: 19*38mm

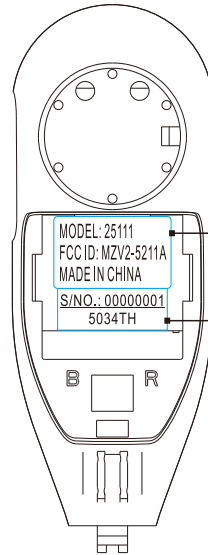

Headset battery label
Size: 15.5*9.5mm

S/NO. & DATE CODE LABEL
SIZE: 14.5 * 5.5 mm

S/NO. must be the same as base,
date code must be the same as base
有下划线表示符合ROHS标准
TF表示广州生产,
TH表示惠州生产



Headset caution label
Size: 15.5*9.5mm

