



REPORT NO : RF89081018
PRODUCT : Access Point
MODEL NO : WX1500, WX1520
BRAND NAME : GemTek
SERIAL NO : N/A
CLIENT : GemTek Technology Co., Ltd.
ADDRESS : No.1, Jen Ai Rd., Hsin Chu Industrial Park, Hu Kou, Hsin Chu 303, Taiwan R.O.C.
ISSUED BY : ADVANCE DATA TECHNOLOGY CORPORATION (ADT CORP.)
OFFICE ADDRESS : 11F, NO. 1, SEC. 4, NAN-KING EAST RD., TAIPEI, TAIWAN, R.O.C.
LABORATORY ADDRESS : NO. 47, 14 LING, CHIA PAU TSUEN, LIN KOU HSIANG, TAIPEI HSIEN, TAIWAN, R.O.C.
TEST STANDARD : 47CFR Part 15, Subpart C (15.247) & Subpart B
TEST DATE : August 16, 2000
TEST RESULT : Pass

This test report consists of 85 pages in total. This test report is the property of ADT Corp. and shall not be reproduced except in full, without the written consent of ADT. ADT hereby returns all rights in data to the client for legal use by the client. The test results contained in this report apply only to the samples tested.



Accredited Laboratory



TABLE OF CONTENTS

1 CERTIFICATION..... 4

2 SUMMARY OF TEST RESULTS & GENERAL STATEMENT OF CERTIFICATION 5

3 DECLARATION OF COMPLIANCE WITH SUBPART B..... 6

4 GENERAL INFORMATION..... 7

 4.1 GENERAL DESCRIPTION OF EUT..... 7

 4.2 DESCRIPTION OF TEST MODE..... 8

 4.3 TEST METHODOLOGY..... 8

 4.4 SUPPORT UNITS LIST..... 9

 4.5 CONFIGURATION OF SYSTEM UNDER TEST..... 9

5 GENERAL INFORMATION OF TEST FACILITY..... 10

 5.1 TEST LAB.:..... 10

 5.2 CALIBRATION INTERVAL : 10

6 TEST PROCEDURES AND TEST RESULTS..... 11

 6.1 CONDUCTED EMISSION MEASUREMENT 11

 6.1.1 Test Instruments..... 11

 6.1.2 Test Procedure 11

 6.1.3 Test Setup 12

 6.1.4 Photograph of Test Setup..... 13

 6.1.5 EUT Operating condition 14

 6.1.6 Climate Condition..... 14

 6.1.7 Test Results 15

 6.2 6DB BANDWIDTH MEASUREMENT 24

 6.2.1 Test Instruments..... 24

 6.2.2 Test Procedure 24

 6.2.3 Test Setup 24

 6.2.4 EUT Operating Condition 24

 6.2.5 Climate Condition..... 25

 6.2.6 Test Results 25

 6.3 MAXIMUM PEAK POWER OUTPUT AND RF EXPOSURE LIMIT MEASUREMENT..... 29

 6.3.1 Test Instruments..... 29

 6.3.2 Test Procedure 29



6.3.3 RF exposure limit.....29

6.3.4 Test Setup31

6.3.5 EUT Operating Condition31

6.3.6 Climate Condition.....31

6.3.7 Test Result.....32

6.4 RADIATED EMISSION MEASUREMENT36

6.4.1 Test instruments36

6.4.2 Test Procedure37

6.4.3 Test Setup38

6.4.4 Photograph of Test Setup39

6.4.5 EUT Operating Condition40

6.4.6 Climate Condition.....40

6.4.7 Test Results41

6.4.7.1 Model name: WX1500.....41

6.5 POWER SPECTRAL DENSITY MEASUREMENT.....53

6.5.1 Test Instruments.....53

6.5.2 Test Procedure53

6.5.3 Test Setup53

6.5.4 EUT Operating Condition53

6.5.5 Climate Condition.....54

6.5.6 Test Result.....54

6.6 PROCESSING GAIN OF A DIRECT SEQUENCE SPREAD SPECTRUM MEASUREMENT58

6.6.1 Test Instruments and Support Units58

6.6.2 Method of Measurement58

6.6.3 Test Setup60

6.6.4 Test Procedure61

6.6.5 EUT Operating condition62

6.6.6 Climate Condition.....62

6.6.7 Test Results63

7 ANTENNA REQUIREMENT..... 79

7.1 STANDARD APPLICABLE79

7.2 ANTENNA CONNECTED CONSTRUCTION.....79

8 EUT PHOTOS 80



1 CERTIFICATION

Issue Date: August 28, 2000

PRODUCT : Access Point
MODEL NO : WX1500, WX1520
FCC ID : MXF-WX1500
CLIENT : GemTek Technology Co., Ltd.
TEST STANDARD : FCC 47CFR Part 15, Subpart C (Section 15.247) & Subpart B
 ANSI C63.4-1992

We, **ADVANCE DATA TECHNOLOGY CORPORATION**, hereby certify that one sample of the designated sample has been tested in our facility. The test record, data evaluation and Equipment Under Test (EUT) configurations represented herein are true and accurate representation of the measurements of the sample's EMI characteristics and the energy emitted under the conditions herein specified.

TESTED BY: Ellis Wu **DATE:** Aug 28, 2000
 Ellis Wu
PREPARED BY: Delphine Hsu **DATE:** Aug 28, 2000
 Delphine Hsu
APPROVED BY: Alan Lane **DATE:** Aug 28, 2000
 Dr. Alan Lane, Manager



2 SUMMARY OF TEST RESULTS & GENERAL STATEMENT OF CERTIFICATION

The EUT has been tested according to the following specifications:

47 CFR Part 15, Subpart C			
PARAGRAPH.	TEST REQUIREMENTS	COMPLIANCE (YES/NO)	TEST RESULT
15.107	AC Power Conducted Emissions Spec.: 48 dBuV	Yes	Minimum passing margin is -6.60 dBuV At 11.987 MHz
15.247(a)(2)	Spectrum Bandwidth of a Direct Sequence Spread Spectrum System Spec.: min. 500 kHz	Yes	11.01 MHz > 500 kHz
15.247(b)	Maximum Peak Output Power Spec.: max. 30 dBm	Yes	13.47 dBm < 30 dBm
15.247(c)	Transmitter Radiated Emissions Spec.: Table 15.209	Yes	Minimum passing margin is -3.7 dBuV At 176.62 MHz
15.247(d)	Power Spectral Density Spec.: max. 8dBm	Yes	-12.00 dBm < 8 dBm
15.247(e)	Processing Gain of Direct Sequence Spread Spectrum System Spec.: min. 10 dB	Yes	11.4dB 10dB



3 DECLARATION OF COMPLIANCE WITH SUBPART B

The digital circuits and receiver portion of the EUT has been tested in ADT. The test result has been verified to comply with FCC Part 15, Subpart B, Class B – Computing Devices (FCC DoC). The engineering test report can be provided upon FCC requests.



4 GENERAL INFORMATION

4.1 General Description of EUT

Product	: Access Point
Model No	: WX1500, WX1520
Power Supply	: 5 VDC power Adapter
Modulation Type	: BPSK(1Mbps)/QPSK(2/5.5/11Mbps)
Transfer Rate	: 11/5.5/2/1 Mbps
Operating Frequency	: 2.4 - 2.4835 GHz
Number of Channel	: 11
Channel Spacing	: 5 MHz
Rated RF output power level	: 12 ± 2 dBm
Associated devices	: N/A

Note: The wireless LAN is normally used in a predefined environment. In such a network, Access Points are mounted at assigned places, each covers its own area in which wireless nodes can operate. These Access Points are connected to a wired network to communicate with each other and with servers and clients on that network.

The WX-1500 Access Point can be connected to a 10 Mbps Ethernet network through a RJ45 (UTP) connector, while the WX-1500 and the WX-1520 support 10/100 base Ethernet Interface.

The difference between WX-1500 and WX-1520 has been stated on following.

- 1. The difference on out looking (Refer to Photo 1)*
- 2. The difference on internal arrangement(Photo 11 for WX1500 & Photo 4 for WX1520)*

The other detailed information, please refer to user's manual.



4.2 Description of Test mode

1. Below 1 GHz, the channel 1, 6 and 11 were chosen for evaluation.
2. Above 1 Ghz, the channel 1, 6 and 11 were chosen for evaluation.

4.3 Test Methodology

These tests were conducted on a sample of EUT for the evaluation in compliance with FCC CFR47 Part 15, Subpart C (15.247) & Subpart B.

Both conducted and radiated emissions measurements were conducted in accordance with ANSI C63.4:1992.

Since the circuit and layout of these two models (WX1500, WX1520) are completely the same, so only the radiated emission measurement had been carried out for both of these two models in this test report. For the other testing items, testing for both models is not necessary. Because the antenna was replaced by an 50 ohm connector which provided a perfect matching with the circuit RF output port. The testing was carried out through this connector.

4.4 Support Units List

No	Product	Brand	Model No.	Serial No.	I/O Cable
1.	Note Book	DELL	PPX	968FF	Nonshielded (1.8m)

4.5 Configuration of System Under Test

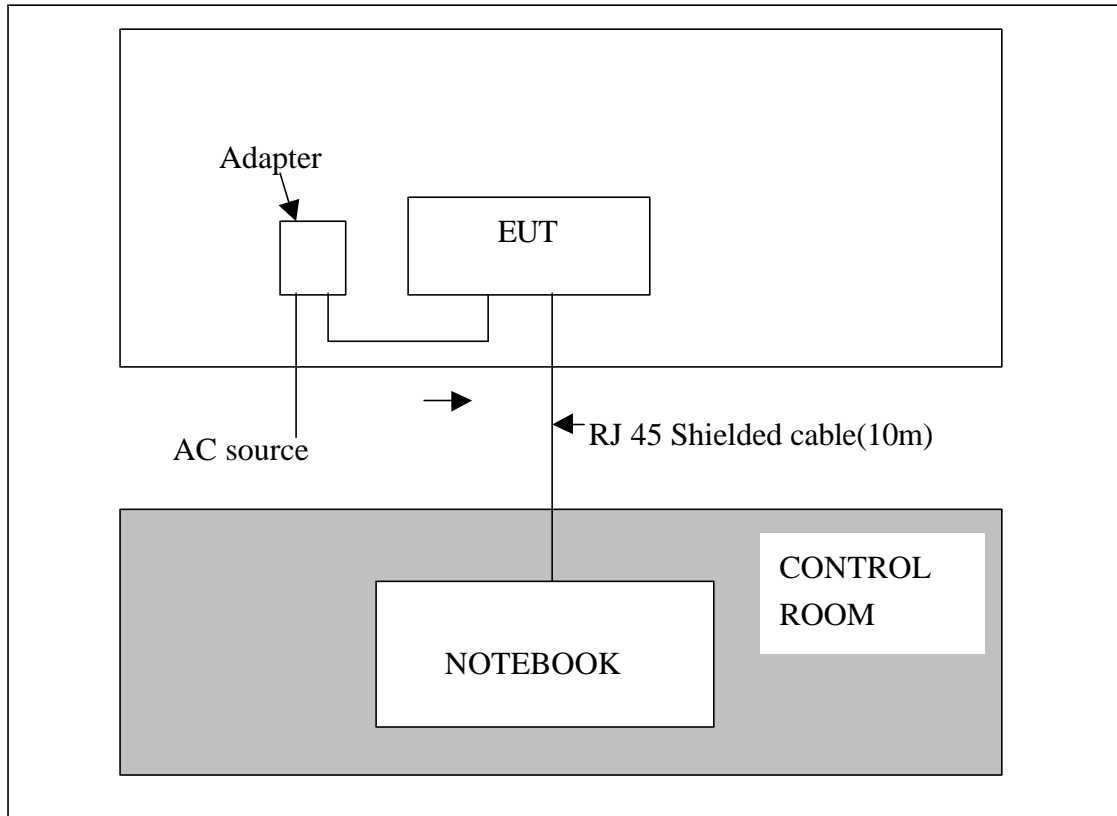



5 GENERAL INFORMATION OF TEST FACILITY

5.1 Test Lab.:

Advance Data Technology

No. 47, 14 Ling, Chia Pau Tsuen, Lin Kuo Hsiang, Taipei, Taiwan, R.O.C.

5.2 Calibration Interval :

All calibration interval of the test sites and test instruments is 12 months. The calibrations are traceable to NML/ROC and NIST/USA.



6 TEST PROCEDURES AND TEST RESULTS

6.1 Conducted Emission Measurement

6.1.1 Test Instruments

Description & Manufacturer	Model No.	Serial No.	Calibrated Until
ROHDE & SCHWARZ Test Receiver	ESH3	893495/006	July 26, 2001
ROHDE & SCHWARZ Spectrum Monitor	EZM	893787/013	July 14, 2001
ROHDE & SCHWARZ Artificial Mains Network	ESH3-Z5	892107/003	July 9, 2001
EMCO L.I.S.N.	3825/2	9504-2359	July 9, 2001
Shielded Room	Site 2	ADT-C02	NA

The measurement uncertainty is less than +/- 2.6dB, which is calculated as per NAMAS document NIS81.

6.1.2 Test Procedure

The EUT was placed 0.4 meter from the conducting wall of the shielded room with EUT being connected to the power mains through a line impedance stabilization network (LISN). Other support units were connected to the power mains through another LISN. The two LISNs provide 50 / 50 μ H coupling impedance for the measuring instrument.

Both lines of the power mains connected to the EUT were checked for maximum conducted interference.

The frequency range from 450 kHz to 30 MHz was searched. The emission levels over 10dB under the prescribed limits could not be reported.

6.1.3 Test Setup

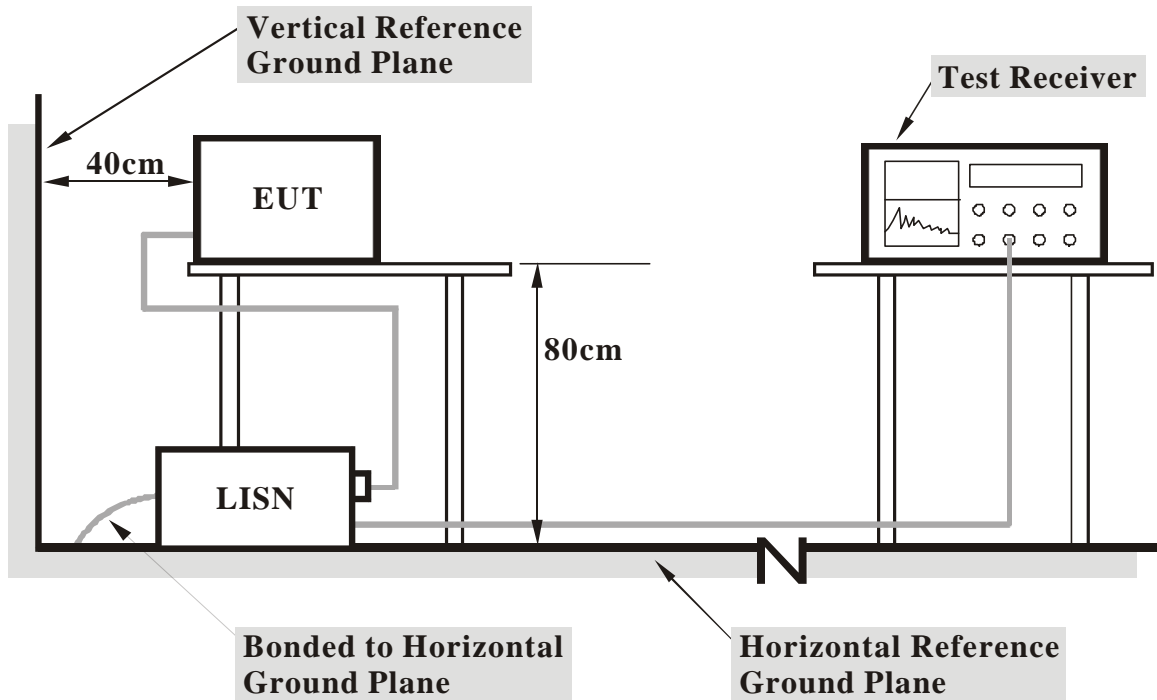

- Note:**
1. Support units were connected to second LISN.
 2. Both of LISNs (AMN) 80 cm from EUT and at the least 80 cm from other units and other metal planes support units.

6.1.4 Photograph of Test Setup





6.1.5 EUT Operating condition

The software provided by customer enabled the EUT to transmit and receive data at lowest, middle and highest channel frequencies individually. "H" patterns were sent to support units and displayed on the screen of Notebook PC for the monitor of continuous operation.

6.1.6 Climate Condition

The temperature and related humidity: 25 and 60%.



6.1.7 Test Results

MODE: CH 1		6 dB Bandwidth: 10 kHz				PHASE: LINE (L)			
Freq. [MHz]	Corr. Factor (dB)	Reading Value [dB (uV)]		Emission Level [dB (uV)]		Limit [dB (uV)]		Margin (dB)	
		Q.P.	AV.	Q.P.	AV.	Q.P.	AV.	Q.P.	AV.
0.768	0.2	37.40	-	37.60	-	48	-	-10.40	-
1.032	0.2	37.20	-	37.40	-	48	-	-10.60	-
1.446	0.2	36.10	-	36.30	-	48	-	-11.70	-
3.072	0.3	37.10	-	37.40	-	48	-	-10.60	-
11.990	0.8	40.50	-	41.30	-	48	-	-6.70	-
25.694	1.4	34.70	-	36.10	-	48	-	-11.90	-

MODE: CH1		6 dB Bandwidth: 10 kHz				PHASE: Neutral(N)			
Freq. [MHz]	Corr. Factor (dB)	Reading Value [dB (uV)]		Emission Level [dB (uV)]		Limit [dB (uV)]		Margin (dB)	
		Q.P.	AV.	Q.P.	AV.	Q.P.	AV.	Q.P.	AV.
0.768	0.2	40.40	-	40.60	-	48	-	-7.40	-
1.032	0.2	40.10	-	40.30	-	48	-	-7.70	-
1.446	0.2	41.00	-	41.20	-	48	-	-6.80	-
3.072	0.3	36.90	-	37.20	-	48	-	-10.80	-
11.990	0.7	34.20	-	34.90	-	48	-	-13.10	-
25.694	1.3	36.00	-	37.30	-	48	-	-10.70	-

- Remarks:
1. "*": Undetectable
 2. Q.P. and AV. are abbreviations of quasi-peak and average individually.
 3. "-": NA
 4. The emission levels of other frequencies were very low against the limit.
 5. Margin value = Emission level - Limit value
 6. Emission Level = Correction Factor + Reading Value.



MODE: CH 6		6 dB Bandwidth: 10 kHz				PHASE: LINE (L)			
Freq. [MHz]	Corr. Factor (dB)	Reading Value [dB (uV)]		Emission Level [dB (uV)]		Limit [dB (uV)]		Margin (dB)	
		Q.P.	AV.	Q.P.	AV.	Q.P.	AV.	Q.P.	AV.
0.681	0.2	36.70	-	36.90	-	48	-	-11.10	-
1.035	0.2	37.90	-	38.10	-	48	-	-9.90	-
1.686	0.2	35.90	-	36.10	-	48	-	-11.90	-
3.345	0.3	38.50	-	38.80	-	48	-	-9.20	-
11.990	0.8	38.90	-	39.70	-	48	-	-8.30	-
26.549	1.4	34.50	-	35.90	-	48	-	-12.10	-

MODE: CH6		6 dB Bandwidth: 10 kHz				PHASE: Neutral(N)			
Freq. [MHz]	Corr. Factor (dB)	Reading Value [dB (uV)]		Emission Level [dB (uV)]		Limit [dB (uV)]		Margin (dB)	
		Q.P.	AV.	Q.P.	AV.	Q.P.	AV.	Q.P.	AV.
0.681	0.2	40.20	-	40.40	-	48	-	-7.60	-
1.035	0.2	39.70	-	39.90	-	48	-	-8.10	-
1.686	0.2	38.90	-	39.10	-	48	-	-8.90	-
3.345	0.3	37.00	-	37.30	-	48	-	-10.70	-
11.990	0.7	40.50	-	41.20	-	48	-	-6.80	-
26.549	1.3	34.10	-	35.40	-	48	-	-12.60	-

- Remarks:
1. "*": Undetectable
 2. Q.P. and AV. are abbreviations of quasi-peak and average individually.
 3. "-": NA
 4. The emission levels of other frequencies were very low against the limit.
 5. Margin value = Emission level - Limit value
 6. Emission Level = Correction Factor + Reading Value.



MODE: CH 11		6 dB Bandwidth: 10 kHz				PHASE: LINE (L)			
Freq. [MHz]	Corr. Factor (dB)	Reading Value [dB (uV)]		Emission Level [dB (uV)]		Limit [dB (uV)]		Margin (dB)	
		Q.P.	AV.	Q.P.	AV.	Q.P.	AV.	Q.P.	AV.
0.681	0.2	37.00	-	37.20	-	48	-	-10.80	-
1.035	0.2	37.60	-	37.80	-	48	-	-10.20	-
1.451	0.2	37.90	-	38.10	-	48	-	-9.90	-
3.288	0.3	38.60	-	38.90	-	48	-	-9.10	-
11.987	0.8	36.40	-	37.20	-	48	-	-10.80	-
26.486	1.4	34.10	-	35.50	-	48	-	-12.50	-

MODE: CH11		6 dB Bandwidth: 10 kHz				PHASE: Neutral(N)			
Freq. [MHz]	Corr. Factor (dB)	Reading Value [dB (uV)]		Emission Level [dB (uV)]		Limit [dB (uV)]		Margin (dB)	
		Q.P.	AV.	Q.P.	AV.	Q.P.	AV.	Q.P.	AV.
0.681	0.2	39.20	-	39.40	-	48	-	-8.60	-
1.035	0.2	40.00	-	40.20	-	48	-	-7.80	-
1.451	0.2	40.50	-	40.70	-	48	-	-7.30	-
3.288	0.3	37.10	-	37.40	-	48	-	-10.60	-
11.987	0.7	40.70	-	41.40	-	48	-	-6.60	-
26.486	1.3	34.40	-	35.70	-	48	-	-12.30	-

- Remarks:
1. "*": Undetectable
 2. Q.P. and AV. are abbreviations of quasi-peak and average individually.
 3. "-": NA
 4. The emission levels of other frequencies were very low against the limit.
 5. Margin value = Emission level - Limit value
 6. Emission Level = Correction Factor + Reading Value.



CH1

ADT CO. Shielded Room 2
FCC CLASS B

16. Aug 00 19:33

EUT: WX1500
Op Cond: CH 1
Operator: ELLIS
Test Spec: LISN : L
Comment: 120V AC / 60Hz

Fast Scan Settings (2 Ranges)

Frequencies			Receiver Settings						
Start	Stop	Step	IF BW	Detector	M-Time	Atten	Preamp	OpRge	
450k	5M	3k	10k	PK	1ms	10dB LN	OFF	60dB	
5M	30M	3k	10k	PK	1ms	10dB LN	OFF	60dB	

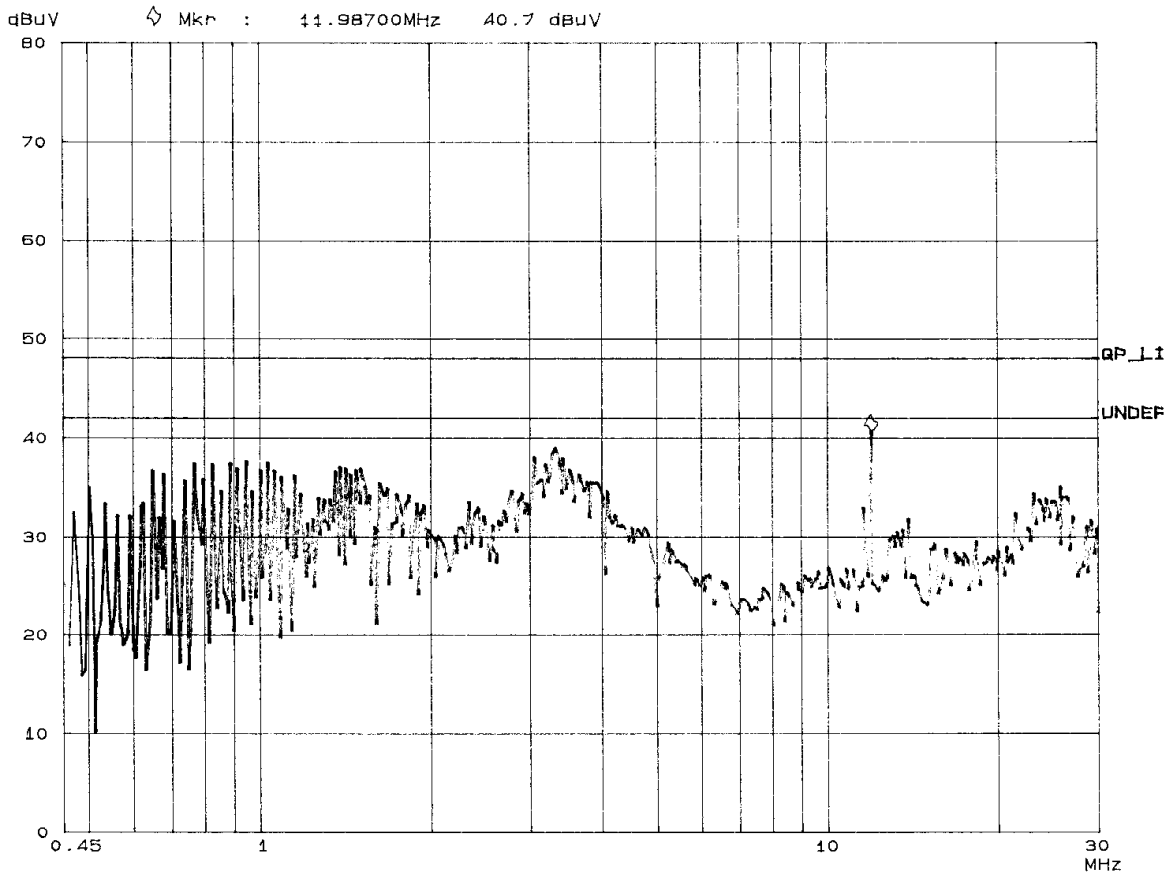



CH1

ADT CO. Shielded Room 2
FCC CLASS B

16. Aug 00 19:27

EUT: WX1500
Op Cond: CH 1
Operator: ELLIS
Test Spec: LISN : N
Comment: 120V AC / 60Hz

Fast Scan Settings (2 Ranges)			Receiver Settings					
Start	Stop	Step	IF BW	Detector	M-Time	Atten	Preamp	OpRge
450k	5M	3k	10k	PK	1ms	10dB	LN OFF	60dB
5M	30M	3k	10k	PK	1ms	10dB	LN OFF	60dB

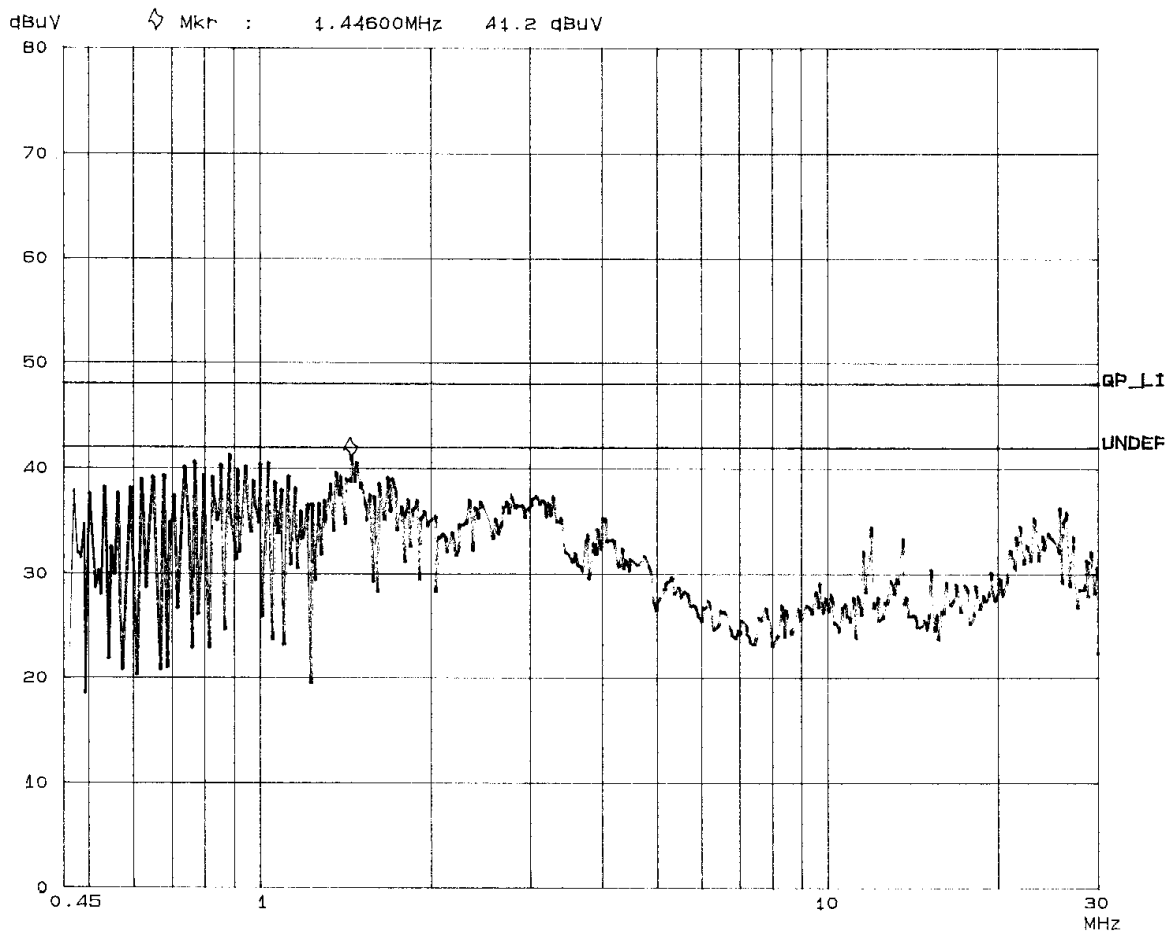



CH6

ADT CO. Shielded Room 2
FCC CLASS B

16. Aug 00 19:36

EUT: WX1500
Op Cond: CH 6
Operator: ELLIS
Test Spec: LISN : L
Comment: 120V AC / 60Hz

Fast Scan Settings (2 Ranges)

Frequencies			Receiver Settings					
Start	Stop	Step	IF BW	Detector	M-Time	Atten	Preampl	OpRge
450k	5M	3k	10k	PK	1ms	10dB	BLN OFF	60dB
5M	30M	3k	10k	PK	1ms	10dB	BLN OFF	60dB

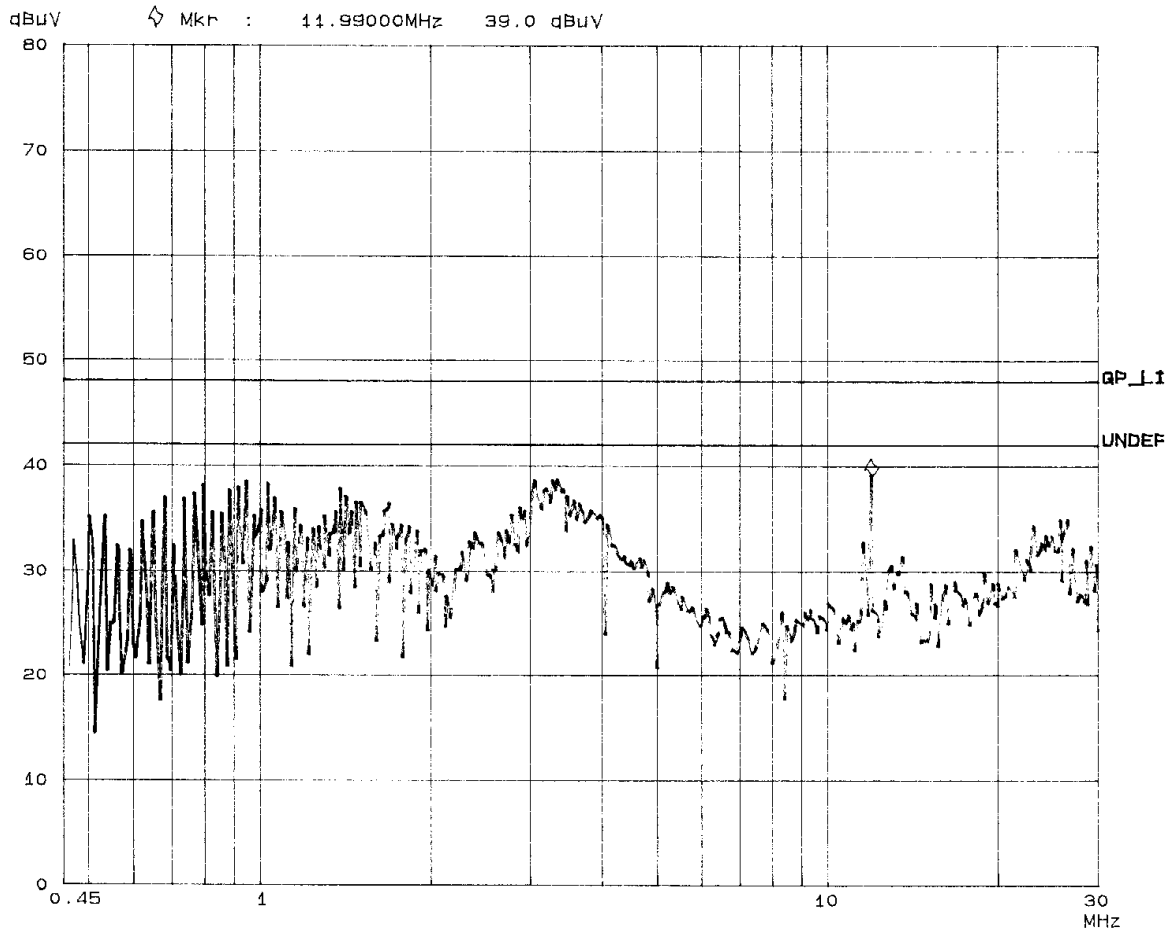



CH6

ADT CO. Shielded Room 2
FCC CLASS B

16. Aug 00 19:40

EUT: WX1500
Op Cond: CH 6
Operator: ELLIS
Test Spec: LISN : N
Comment: 120V AC / 60Hz

Fast Scan Settings (2 Ranges)

Frequencies			Receiver Settings						
Start	Stop	Step	IF BW	Detector	M-Time	Atten	Preampl	OpRge	
450k	5M	3k	10k	PK	1ms	10dB LN	OFF	60dB	
5M	30M	3k	10k	PK	1ms	10dB LN	OFF	60dB	

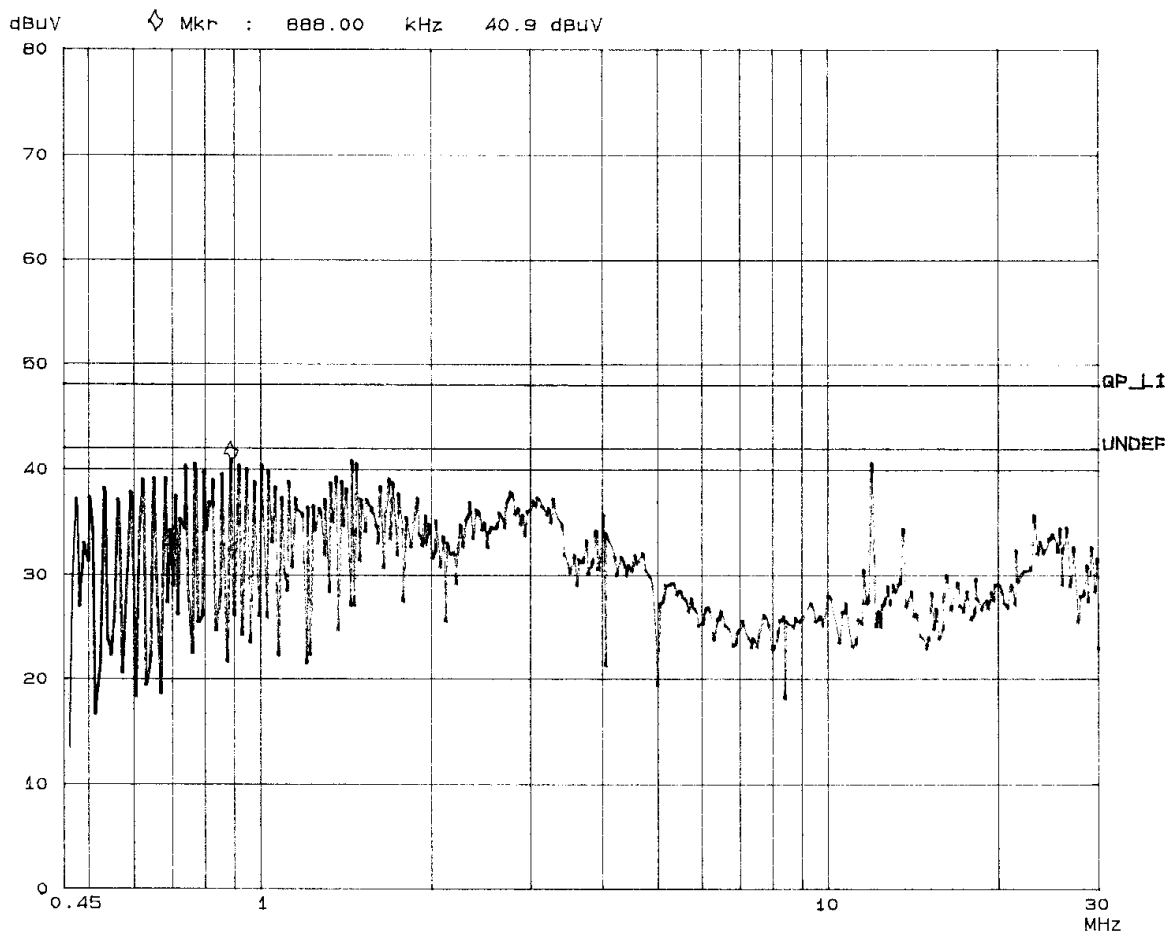



CH11

ADT CO. Shielded Room 2
FCC CLASS B

16. Aug 00 19:46

EUT: WX1500
Op Cond: CH 11
Operator: ELLIS
Test Spec: LISN : L
Comment: 120V AC / 60Hz

Fast Scan Settings (2 Ranges)			Receiver Settings					
Start	Stop	Step	IF BW	Detector	M-Time	Atten	Preamp	OpRge
450k	5M	3k	10k	PK	1ms	10dB LN	OFF	60dB
5M	30M	3k	10k	PK	1ms	10dB LN	OFF	60dB

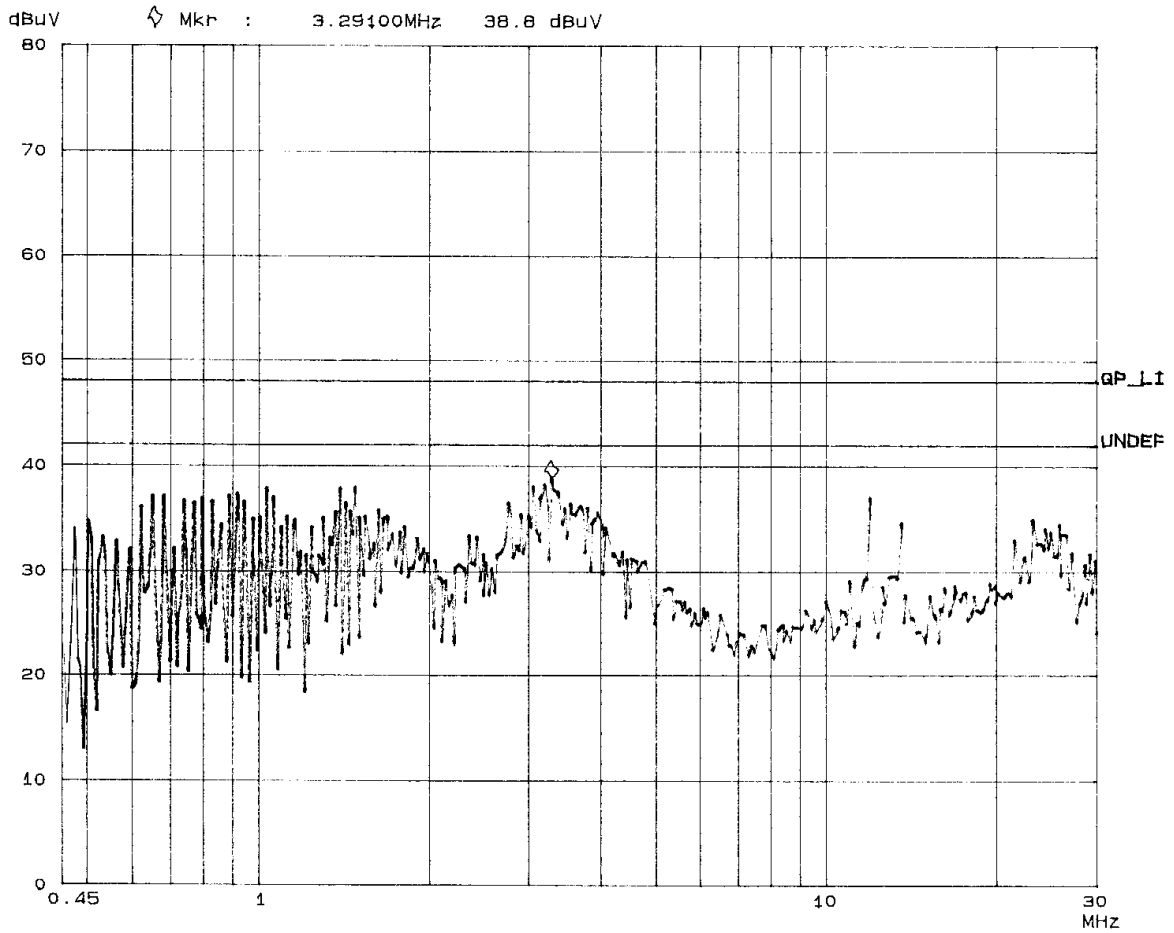



CH11

ADT CO. Shielded Room 2
FCC CLASS B

16. Aug 00 19:43

EUT: WX1500
Op Cond: CH 11
Operator: ELLIS
Test Spec: LISN : N
Comment: 120V AC / 60Hz

Fast Scan Settings (2 Ranges)			Receiver Settings					
Start	Stop	Step	IF BW	Detector	M-Time	Atten	Preamp	OpRge
450k	5M	3k	10k	PK	1ms	10dB	BLN OFF	60dB
5M	30M	3k	10k	PK	1ms	10dB	BLN OFF	60dB

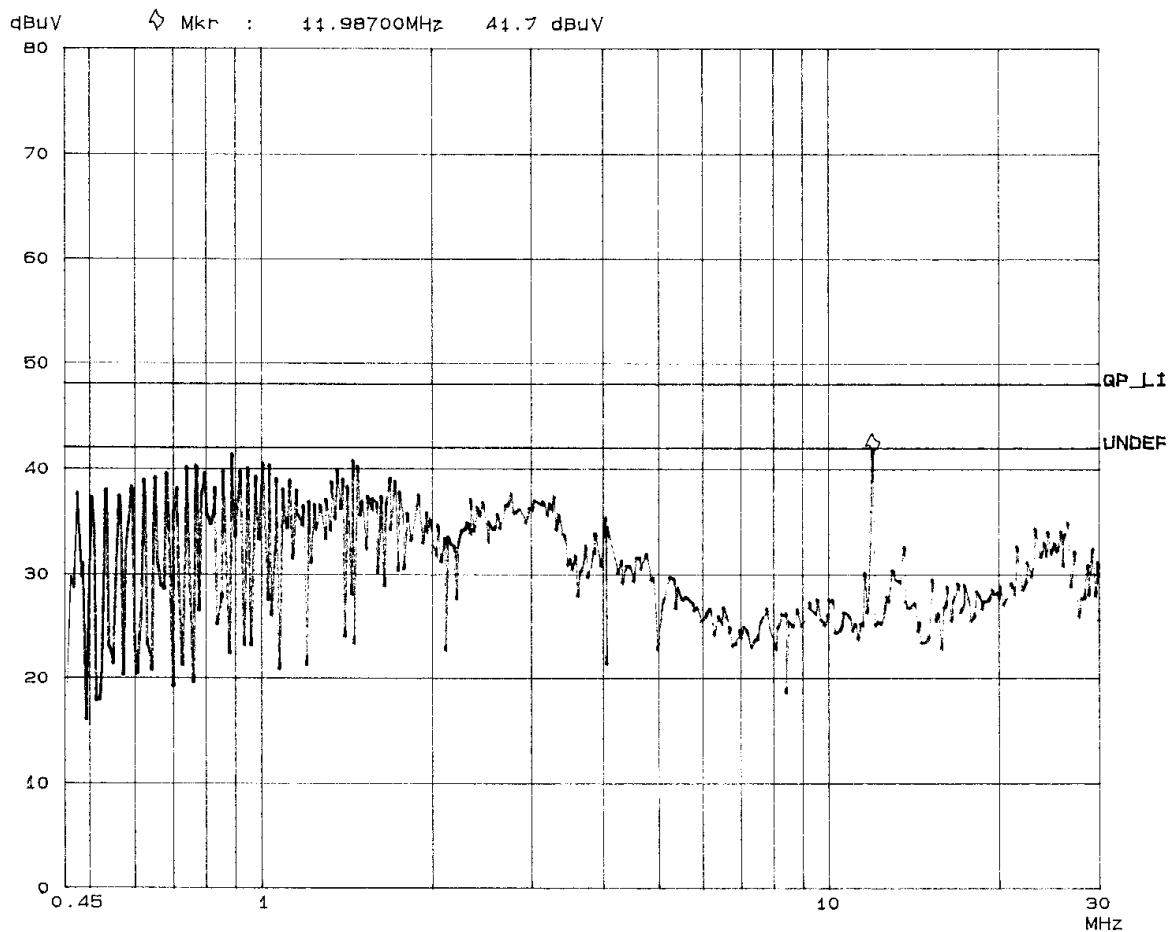

6.2 6dB Bandwidth Measurement

6.2.1 Test Instruments

Description & Manufacturer	Model No.	Serial No.	Calibrated Until
ROHDE & SCHWARZ TEST RECEIVER	ESMI	846839/018 848926/005	Dec. 03, 2000
HP ATTENUATOR	8496B	3247A18505	Cal. on use
HP PLOTTER	7475A	2641V27755	N/A

The measurement uncertainty is less than +/- 2.6dB, which is calculated as per NAMAS document NIS81.

6.2.2 Test Procedure

The transmitter output was connected to the spectrum analyzer through an attenuator. The bandwidth of the fundamental frequency was measured with the spectrum analyzer using 100 kHz RBW and 100 kHz VBW. The 6 dB bandwidth was measured and recorded.

6.2.3 Test Setup

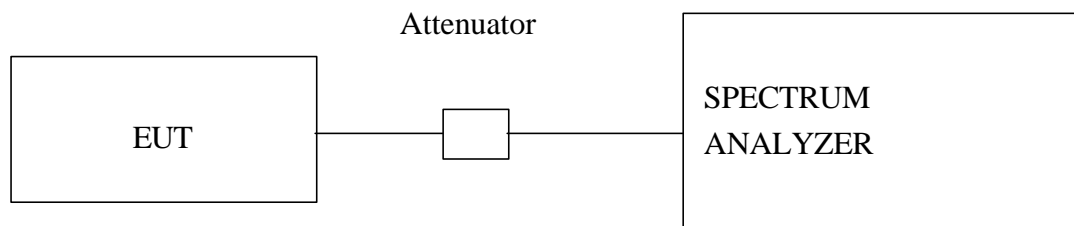

6.2.4 EUT Operating Condition

The software provided by client enabled the EUT to transmit and receive data at lowest, middle and highest channel frequencies individually.



6.2.5 Climate Condition

The temperature and related humidity: 18 and 78%

6.2.6 Test Results

CHANNEL	CHANNEL FREQUENCY (MHz)	6 dB BANDWIDTH (MHz)	MINIMUM LIMIT (MHz)	PASS/FAIL
1	2412	11.04	0.5	PASS
6	2437	11.01	0.5	PASS
11	2462	11.01	0.5	PASS

The spectrum plots of test result are attached as below.



CH1

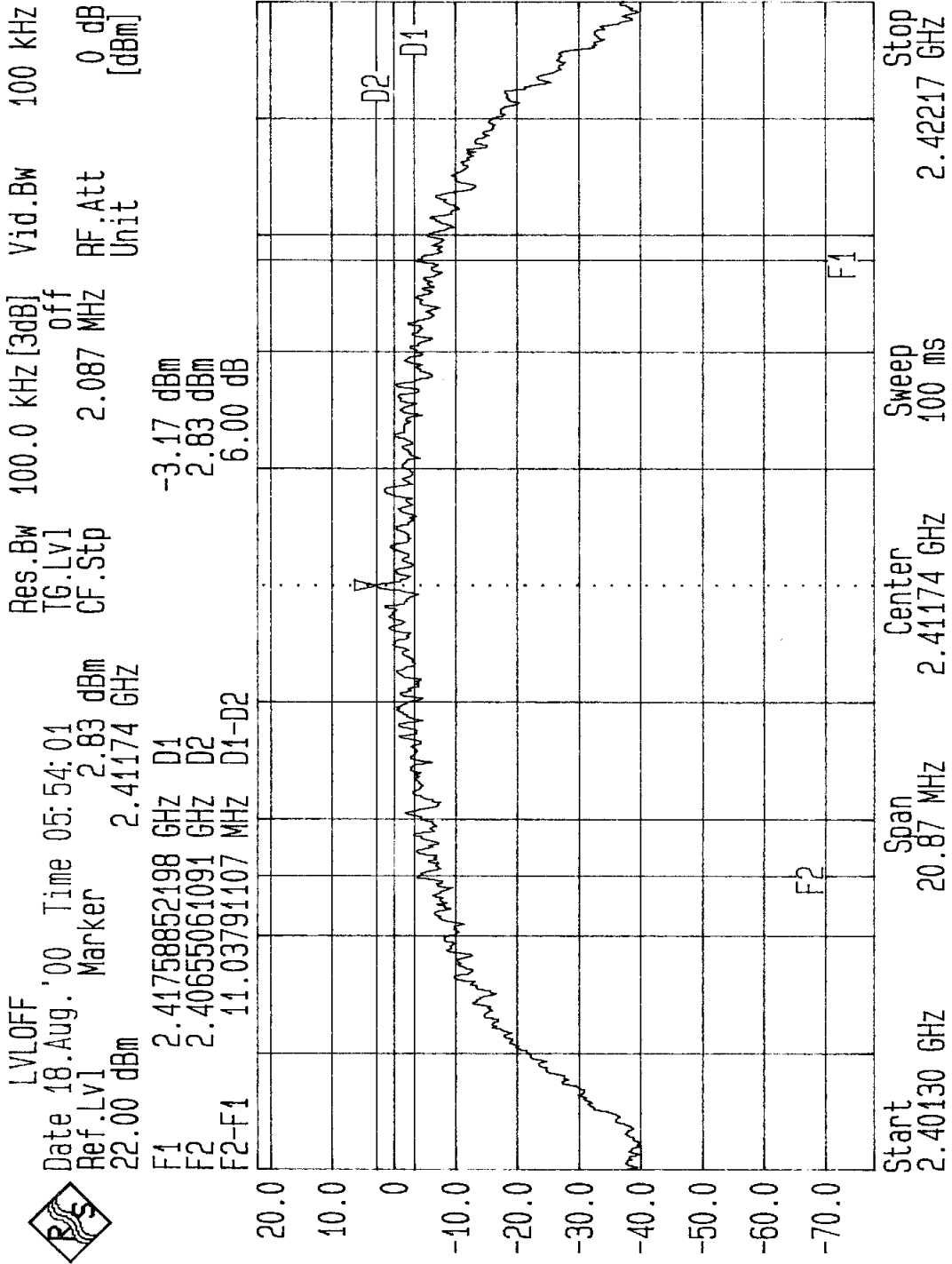



CH6

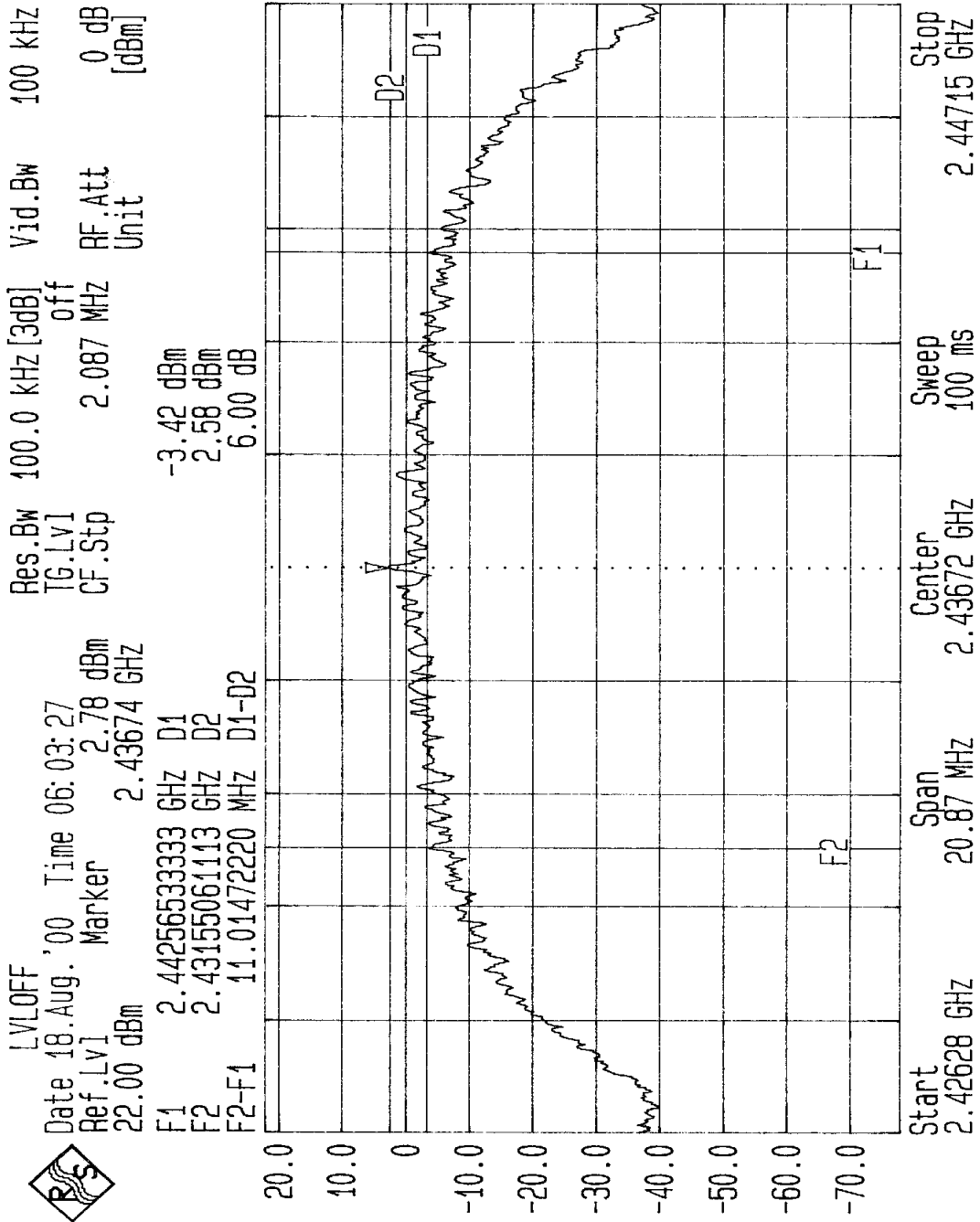



CH11

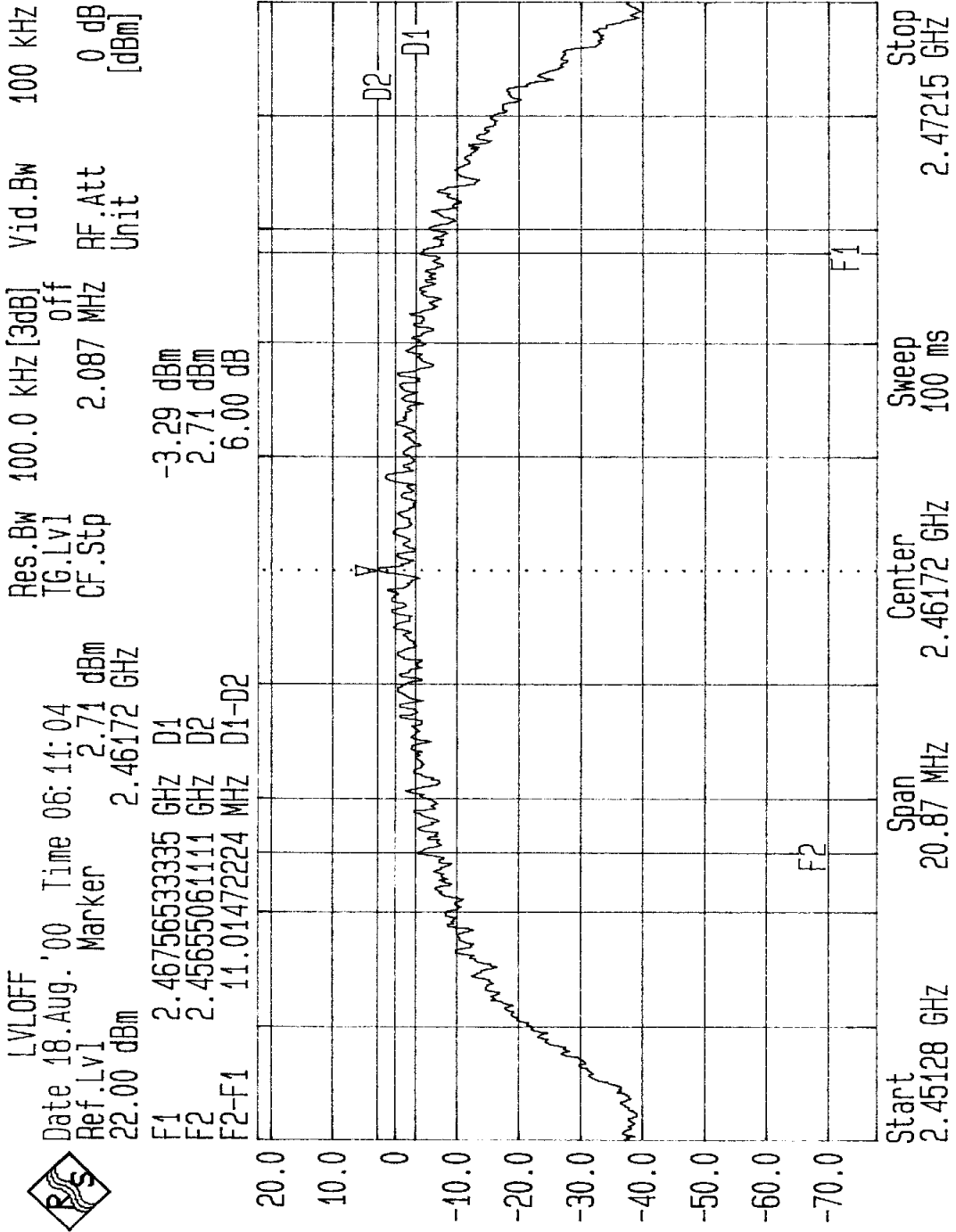



6.3 Maximum Peak Power Output and RF Exposure Limit Measurement

6.3.1 Test Instruments

Description & Manufacturer	Model No.	Serial No.	Calibrated Until
ROHDE & SCHWARZ TEST RECEIVER	ESMI	846839/018 848926/005	Dec. 03, 2000
HP ATTENUATOR	8496B	3247A18505	Cal. on use
HP PLOTTER	7475A	2641V27755	N/A

The measurement uncertainty is less than +/- 2.6dB, which is calculated as per NAMAS document NIS81.

6.3.2 Test Procedure

1. The transmitter output was connected coupled to the spectrum analyzer through an attenuator.
2. The center frequency of the spectrum analyzer is set to the fundamental frequency and using 3 MHz RBW and 3 MHz VBW.
3. The span of the spectrum analyzer should be larger than 6dB BandWidth.
4. Use Peak Search to read the peak power after Maximum Hold function is activated.
5. Shift the marker to +/- 3MHz and +/- 6MHz, and record the reading.
6. The Maximum Peak Output Power is the linear summation of the 5 readings in (4) and (5).

Alternatively, power meter is acceptable to be used in this measurement. But the average function of power meter will make the measured result smaller than that of the procedures mentioned above.

6.3.3 RF exposure limit

According to FCC 1.1310: The criteria listed in the following table shall be used to evaluate the environmental impact of human exposure to radio-frequency (RF) radiation as specified in 1.1307(b)



LIMITS FOR MAXIMUM PERMISSIBLE EXPOSURE (MPE)

Frequency Range (MHz)	Electric Field Strength (V/m)	Magnetic Field Strength (A/m)	Power Density (mW/cm ²)	Average Time (minutes)
(A)Limits For Occupational / Control Exposures				
300-1500	F/300	6
1500-100,000	5	6
(B)Limits For General Population / Uncontrolled Exposure				
300-1500	F/1500	6
1500-100,000	1.0	30

F = Frequency in MHz

The power density in the place where the human being is reached under normal use condition should be lower than the limit of MPE. Please see the calculation we followed to prove the limited harmfulness of the radiation in this product.

Friis transmission formula : $Pd = (Pout * G) / (4 * pi * r^2)$

where

Pd = power density in mW/cm²

Pout = output power to antenna in mW

G = gain of antenna in linear scale

Pi = 3.1416

R = distance between observation point and center of the radiator in cm

The limit of MPE here is 1.0 mW/cm² which makes Pd=1.0. If the Gain of the antenna and the total output power to the antenna Pout is known, then the Allowance Minimum Distance r can be calculated.

Ref. : David K. Cheng, *Field and Wave Electromagnetics*, Second Edition, Page 640, Eq. (11-133).

6.3.4 Test Setup

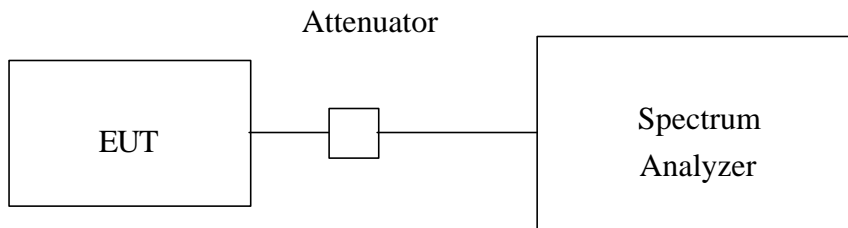

6.3.5 EUT Operating Condition

The software provided by the customer enabled the EUT to transmit and receive data at lowest, middle and highest channel frequencies individually.

6.3.6 Climate Condition

The temperature and related humidity: 18 and 78%



6.3.7 Test Result

Output Power Into Antenna:

The maximum Gain measured in Fully Anechoic Chamber is 1dBi or 1.26 in linear scale.

CHANNEL	CHANNEL FREQUENCY (MHz)	PEAK POWER OUTPUT (dBm)	PEAK POWER LIMIT (dBm)	PASS/FAIL
1	2412	13.47	30	PASS
6	2437	13.40	30	PASS
11	2462	13.24	30	PASS

RF Exposure Distance Limits :

CHANNEL	CHANNEL FREQUENCY (MHz)	OUTPUT POWER TO ANTENNA (mW)	MINIMUM ALLOWABLE DISTANCE (r) (Centi-Meter)
1	2412	22.23	1.50
6	2437	21.88	1.49
11	2462	21.09	1.46

The minimum allowable distance is very close to the enclosure of the antenna and is very far away from the human being under normal use condition. So, SAR testing is not required.



CH1

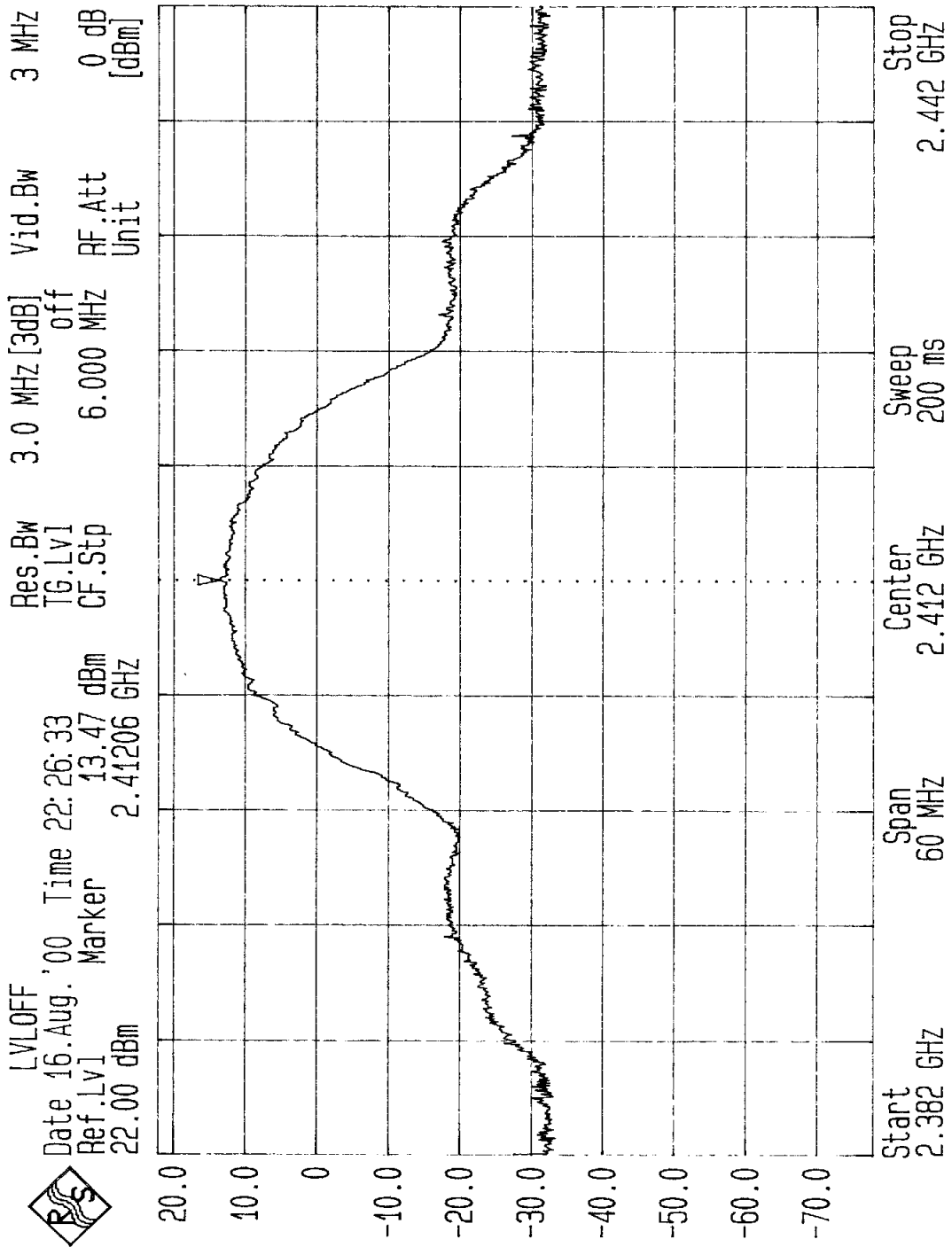



CH6

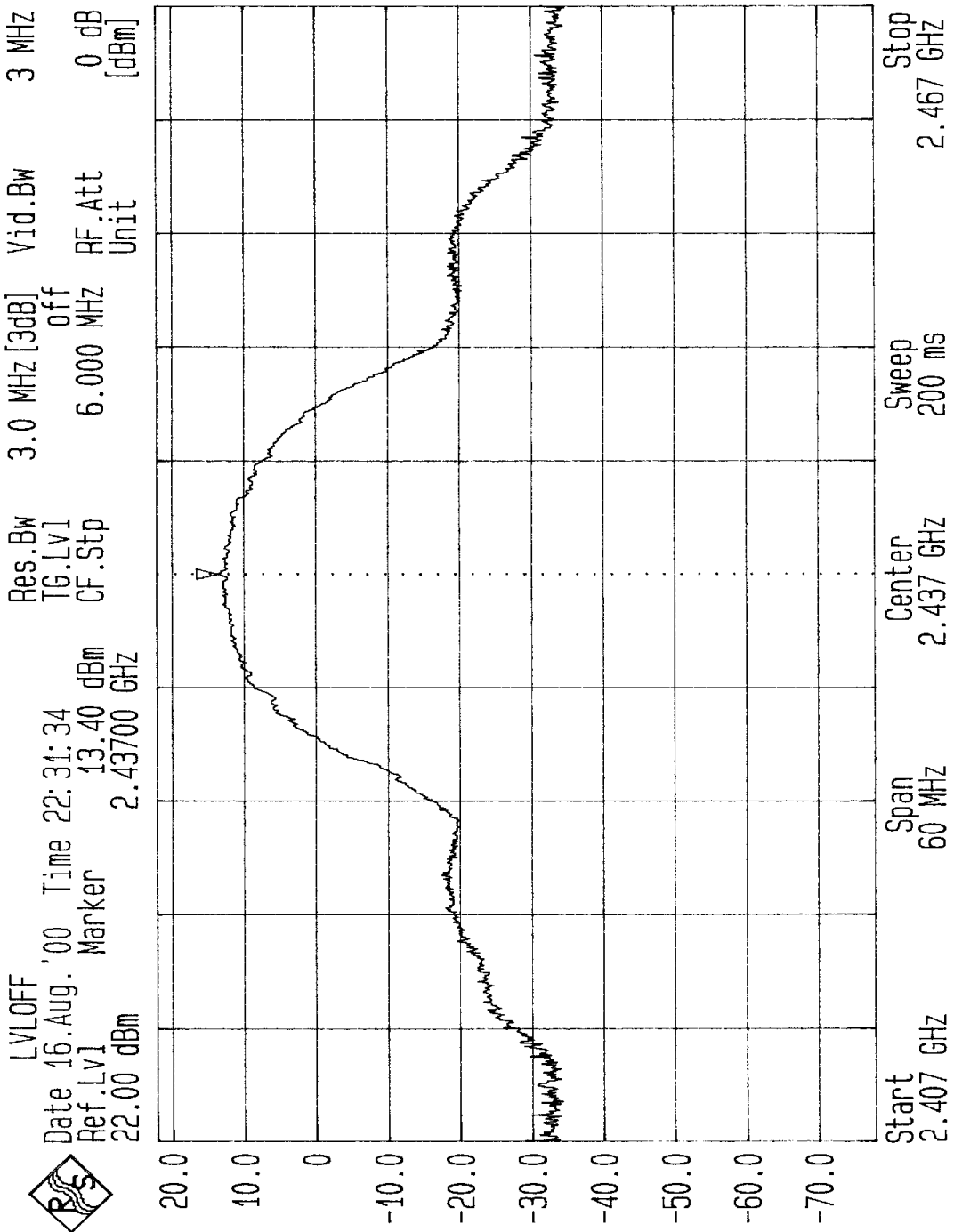



CH11

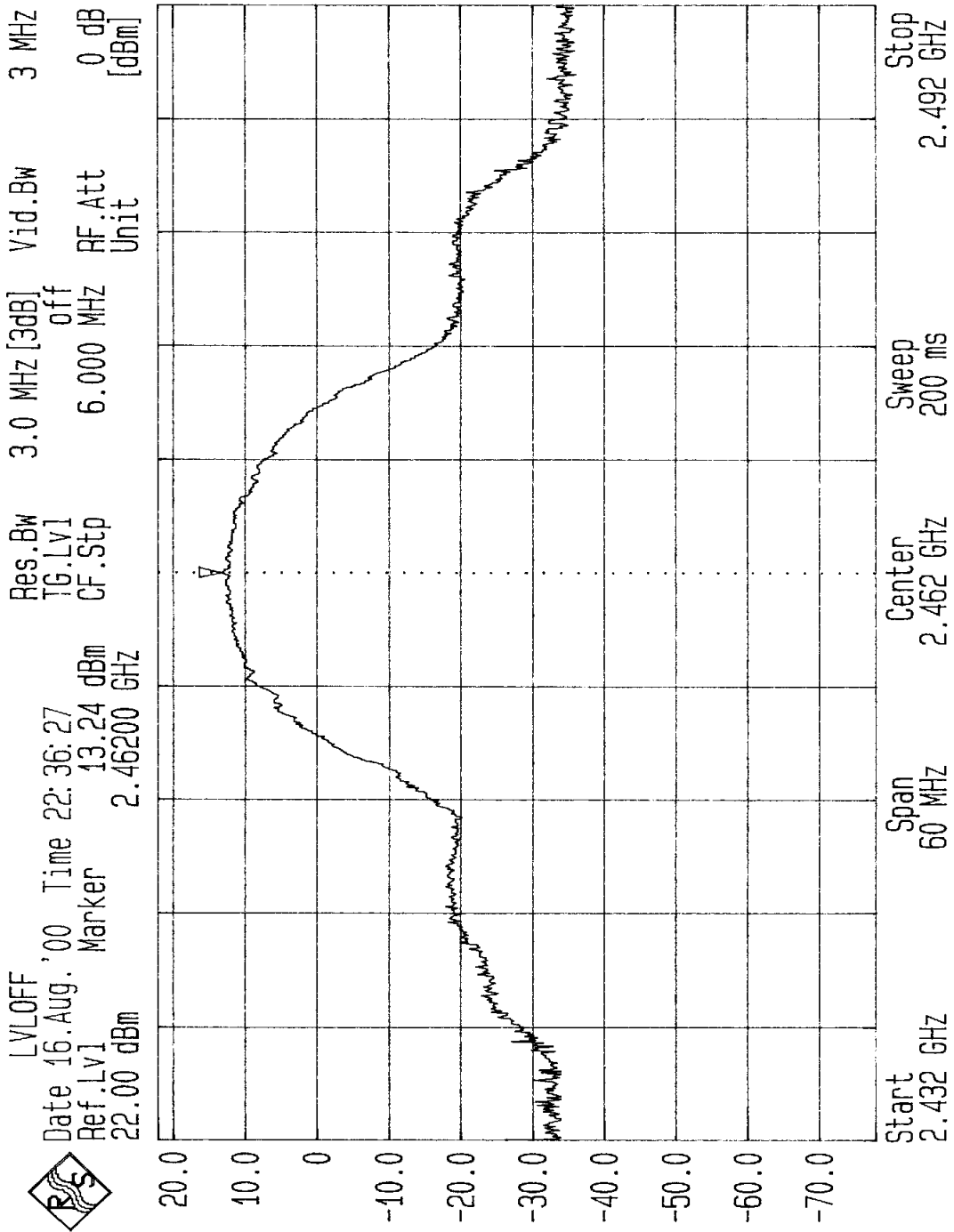



6.4 Radiated Emission Measurement

6.4.1 Test instruments

Description & Manufacturer	Model No.	Serial No.	Calibrated Until
HP Spectrum Analyzer	8590L	3544A01176	Apr 18, 2001
HP Preamplifier	8447D	2944A08485	Oct. 23, 2000
HP Preamplifier	8449B	3008A01201	Dec. 14, 2000
HP Preamplifier	8347A	3307A01088	Sep. 09, 2000
ROHDE & SCHWARZ TEST RECEIVER	ESMI	839013/007 839379/002	Aug. 3, 2001
SCHWARZBECK Tunable Dipole Antenna	VHA 9103 UHA 9105	E101051 E101055	Nov. 25, 2000
CHASE BILOG Antenna	CBL6112A	2221	Aug. 4, 2001
SCHWARZBECK Horn Antenna	BBHA9120-D	D130	Jul. 09, 2001
SCHWARZBECK Horn Antenna	BBHA9170	123	Jan. 31, 2001
EMCO Turn Table	1060	1115	N/A
SHOSHIN Tower	AP-4701	A6Y005	N/A
Open Field Test Site	Site 5	ADT-R05	Aug. 29, 2001

The measurement uncertainty is less than +/- 3dB, which is calculated as per NAMAS document NIS81.



6.4.2 Test Procedure

- a. The EUT was placed on the turn table 0.8 meter above ground in 3 meter open area test site.
- b. Set the resolution bandwidth to 120KHz in the test receiver and select Peak function to scan the frequency below 1 GHz.
- c. Shift the interference-receiving antenna located in antenna tower upwards and downwards between 1 and 4 meters above ground and find out the local peak emission on frequency domain.
- d. Locate the interference-receiving antenna at the position where the local peak reach the maximum emission.
- e. Rotate the turn table and stop at the angle where the measurement device has maximum reading
- f. Shift the interference-receiving antenna again to detect the maximum emission of the local peak
- g. If the reading of the local peak under Peak function is lower than limit by 6dB, then Quasi Peak detection is not needed and this reading should be recorded. And if it is higher than Peak limit, then the test is fail. Others, switch the receiver to Quasi Peak function, set the resolution bandwidth to 100kHz and repeat the procedures C ~ F. If the reading is lower than limit, this reading should be recorded, otherwise, the test is fail.
- h. Set the resolution and video bandwidth of the spectrum analyzer to 1MHz and repeat procedures C ~ F for frequency band from 1 GHz to 10 times carrier frequency.
- i. If the reading for the local peak is lower than the Average limit, no further testing is needed in this local peak and this reading should be recorded. If it is higher than Average limit but lower than Peak limit, then set the resolution bandwidth to 1MHz and video bandwidth to 300Hz. Repeat procedures C ~ F. If the maximum reading is lower than Average limit, then this reading should be recorded. If it is higher, then the test is fail.

6.4.3 Test Setup

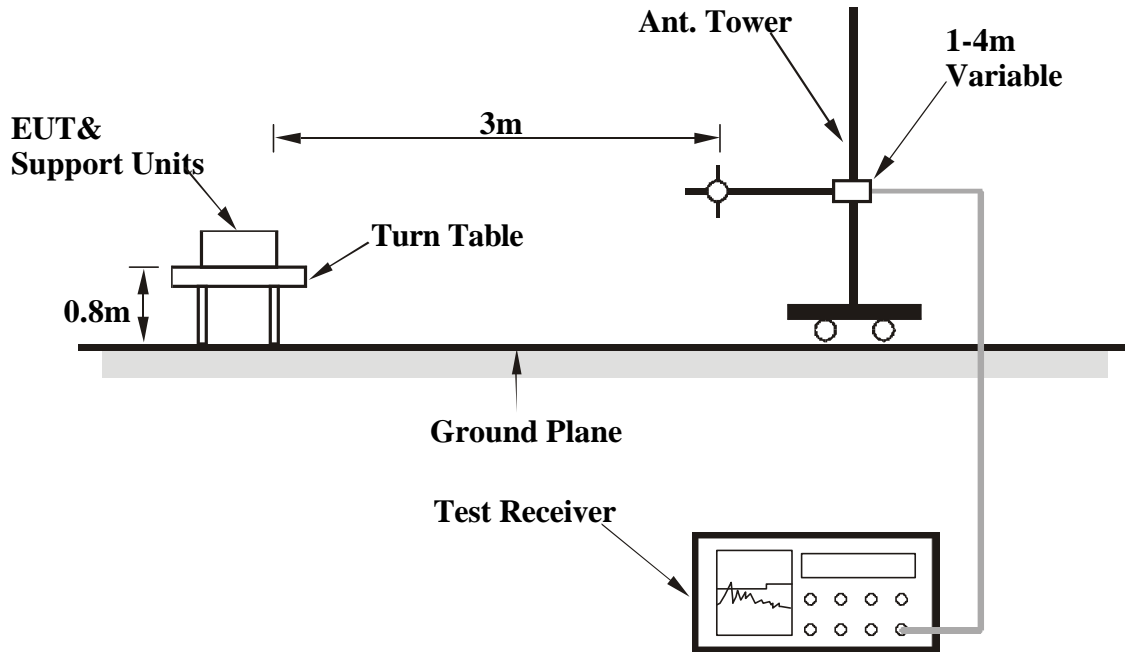

6.4.4 Photograph of Test Setup

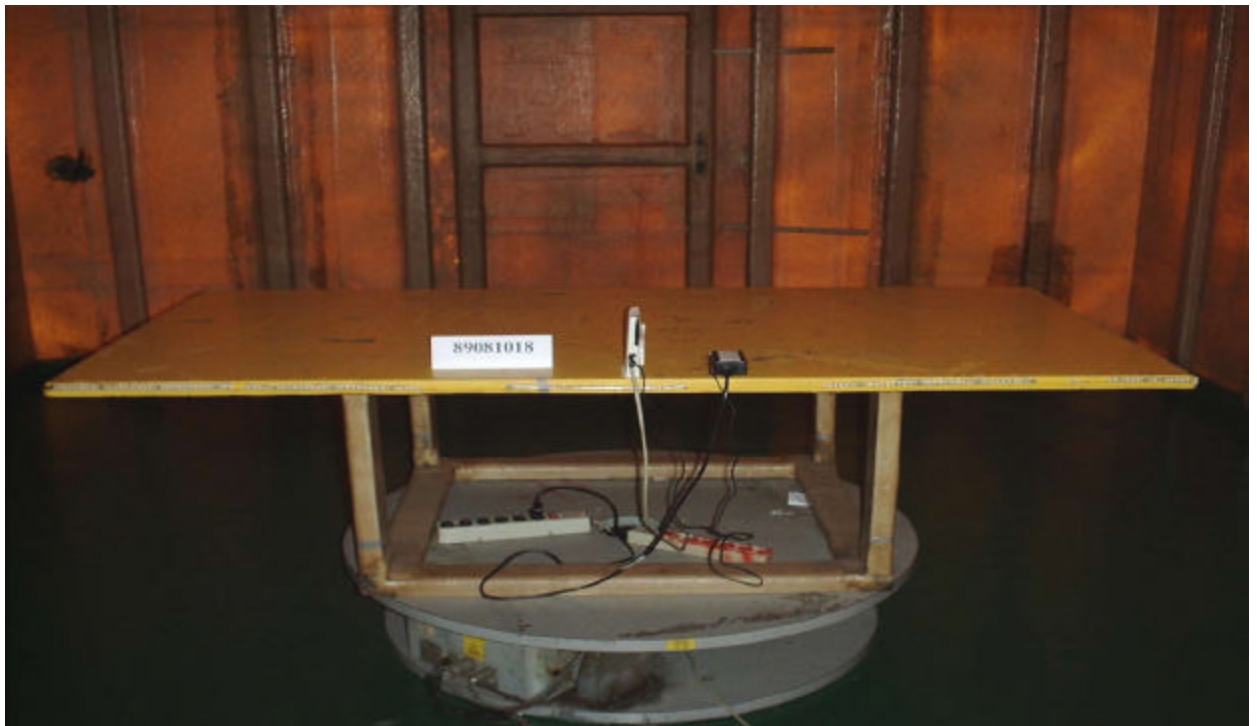



6.4.5 EUT Operating Condition

1. Place the EUT on the testing table.
2. Use RJ45 cable to connect EUT and Notebook PC (Place it outside testing area).
3. Power on.
4. The software provided by the customer enabled the EUT to transmit and receive data at lowest, middle and highest channel frequencies individually.
5. Send data to EUT (on the testing table) by command "PIN".
6. The linkage between these two PC has been established when the address of the PC on the testing table is shown on the monitor of the PC outside testing area.
7. Operate measurement instruments to proceed measurement.

6.4.6 Climate Condition

The temperature and related humidity: 25 and 65%



6.4.7 Test Results

6.4.7.1 Model name:WX1500

CHANNEL:1 ANTENNA POLARITY: Vertical		Detector Function : Quasi-Peak		6dB Bandwidth : 120 kHz.		Distance : 3 M Frequency Range : 30 – 1000 MHz.	
Frequency (MHz)	Correction Factor (dB)	Reading Value (dBuV)	Emission Level (dBuV/m)	Limit (dBuV/m)	Margin (dB)	Antenna Height (cm)	Table Angle (Degree)
120.09	12.9	12.9	25.8	43.5	-17.7	100	144
176.62	10.9	28.9	39.8	43.5	-3.7	100	356
200.03	10.2	14.0	24.2	43.5	-19.3	100	186
264.04	14.6	12.3	26.9	46.0	-19.1	102	47
300.03	14.9	14.0	28.9	46.0	-17.1	100	196
352.04	16.4	13.9	30.3	46.0	-15.7	103	196
440.07	18.5	14.4	32.9	46.0	-13.1	104	269
748.33	22.4	0.3	22.7	46.0	-23.3	103	312

CHANNEL:1 ANTENNA POLARITY: Horizontal		Detector Function : Quasi-Peak		6dB Bandwidth : 120 kHz.		Distance : 3 M Frequency Range : 30 – 1000 MHz.	
Frequency (MHz)	Correction Factor (dB)	Reading Value (dBuV)	Emission Level (dBuV/m)	Limit (dBuV/m)	Margin (dB)	Antenna Height (cm)	Table Angle (Degree)
79.99	8.9	12.6	21.5	40.0	-18.5	173	344
176.05	10.9	27.8	38.7	43.5	-4.8	222	57
219.99	11.6	8.8	20.4	46.0	-25.6	145	103
299.99	14.9	9.7	24.6	46.0	-21.4	110	274
307.99	15.1	9.5	24.6	46.0	-21.4	120	219
351.99	16.4	13.3	29.7	46.0	-16.3	116	363
352.05	16.4	17.2	33.6	46.0	-12.4	113	362
439.99	18.5	14.9	33.4	46.0	-12.6	103	113
499.99	19.8	6.8	26.6	46.0	-19.4	100	281
512.05	20.1	7.2	27.3	46.0	-18.7	145	58
747.99	22.4	6.2	28.6	46.0	-17.4	112	116



CHANNEL:6 ANTENNA POLARITY: Vertical		Detector Function : Quasi-Peak		6dB Bandwidth : 120 kHz.		Distance : 3 M Frequency Range : 30 – 1000 MHz.	
Frequency (MHz)	Correction Factor (dB)	Reading Value (dBuV)	Emission Level (dBuV/m)	Limit (dBuV/m)	Margin (dB)	Antenna Height (cm)	Table Angle (Degree)
99.99	11.7	26.4	38.1	43.5	-5.4	118	135
131.99	12.7	13.3	26.0	43.5	-17.5	115	211
175.99	10.9	25.9	36.8	43.5	-6.7	102	-1
199.99	10.2	10.5	20.7	43.5	-22.8	101	177
263.99	14.6	11.5	26.1	46.0	-19.9	102	220
299.99	14.9	17.3	32.2	46.0	-13.8	107	227
351.99	16.4	12.3	28.7	46.0	-17.3	103	206
439.99	18.5	10.1	28.6	46.0	-17.4	129	240
511.99	20.1	12.5	32.6	46.0	-13.4	139	176

CHANNEL:6 ANTENNA POLARITY: Horizontal		Detector Function : Quasi-Peak		6dB Bandwidth : 120 kHz.		Distance : 3 M Frequency Range : 30 – 1000 MHz.	
Frequency (MHz)	Correction Factor (dB)	Reading Value (dBuV)	Emission Level (dBuV/m)	Limit (dBuV/m)	Margin (dB)	Antenna Height (cm)	Table Angle (Degree)
99.99	11.7	14.2	25.9	43.5	-17.6	230	75
175.99	10.9	24.1	35.0	43.5	-8.5	140	59
199.99	10.2	12.4	22.6	43.5	-20.9	199	230
219.99	11.6	10.2	21.8	46.0	-24.2	151	94
263.99	14.6	11.6	26.2	46.0	-19.8	159	58
300.01	14.9	14.4	29.3	46.0	-16.7	131	207
351.99	16.4	13.6	30.0	46.0	-16.0	123	38
440.01	18.5	11.6	30.1	46.0	-15.9	100	253
500.01	19.8	9.0	28.8	46.0	-17.2	100	279
511.99	20.1	7.4	27.5	46.0	-18.5	151	40
880.01	23.3	7.1	30.4	46.0	-15.6	120	92



CHANNEL:11 ANTENNA POLARITY: Vertical		Detector Function : Quasi-Peak		6dB Bandwidth : 120 kHz.		Distance : 3 M Frequency Range : 30 – 1000 MHz.	
Frequency (MHz)	Correction Factor (dB)	Reading Value (dBuV)	Emission Level (dBuV/m)	Limit (dBuV/m)	Margin (dB)	Antenna Height (cm)	Table Angle (Degree)
99.99	11.7	26.6	38.3	46.5	-5.2	113	239
175.99	10.9	25.7	36.6	46.2	-6.9	106	337
199.99	10.2	10.9	21.1	43.5	-22.4	109	76
263.99	14.6	11.7	26.3	46.0	-19.7	114	109
351.99	16.4	12.3	28.7	46.0	-17.3	100	200
439.99	18.5	9.5	28.0	46.0	-18.0	145	88
511.99	20.1	12.1	32.2	46.0	-13.8	130	275
527.99	20.4	5.0	25.4	46.0	-20.6	127	51

CHANNEL:11 ANTENNA POLARITY: Horizontal		Detector Function : Quasi-Peak		6dB Bandwidth : 120 kHz.		Distance : 3 M Frequency Range : 30 – 1000 MHz.	
Frequency (MHz)	Correction Factor (dB)	Reading Value (dBuV)	Emission Level (dBuV/m)	Limit (dBuV/m)	Margin (dB)	Antenna Height (cm)	Table Angle (Degree)
99.99	11.7	14.2	25.9	43.5	-17.6	164	243
175.99	10.9	24.1	35.0	43.5	-8.5	138	67
219.99	11.6	9.2	20.8	46.0	-25.2	134	100
263.99	14.6	11.2	25.8	46.0	-20.2	110	253
299.99	14.9	12.7	27.6	46.0	-18.4	109	20
351.99	16.4	14.0	30.4	46.0	-15.6	112	42
439.99	18.5	16.4	34.9	46.0	-11.1	100	115
499.99	19.8	6.4	26.2	46.0	-19.8	121	133
511.99	20.1	5.9	26.3	46.0	-20.3	139	226
703.99	21.7	11.1	32.8	46.0	-13.2	142	263
747.99	22.4	6.7	29.1	46.0	-16.9	121	116

- Remarks: 1. Emission level (dBuV/m) = Correction Factor (dB) + Reading value (dBuV).
 2. Correction Factor (dB) = Ant. Factor (dB)+Cable loss (dB)
 3. The other emission levels were very low against the limit.
 4. Margin value = Emission level - Limit value
 5. The limit value is defined as per 15.247



Channel 1 ANTENNA POLARITY: Vertical		Detector Function : Peak Average				6dB Bandwidth : 1 MHz.				Distance : 3 M Frequency Range : Above 1000 MHz.	
Frequency (MHz)	Correction Factor (dB)	Reading Value (dBuV)		Emission Level (dBuV/m)		Limit (dBuV/m)		Margin (dB)		Antenna Height (cm)	Table Angle (Degree)
		P.K.	A.V.	P.K.	A.V.	P.K.	A.V.	P.K.	A.V.		
1672.30	31.1	15.4	-	46.5	-	74.0	54.0	-27.5	-	106	322
2038.07	33.1	17.5	-	50.6	-	74.0	54.0	-23.4	-	112	139
*2412.00	34.3	66.3	58.2	100.6	92.5	-	-	-	-	111	262
4076.12	40.0	11.2	-	51.2	-	74.0	54.0	-22.8	-	144	363
4824.00	41.3	9.0	-	50.3	-	74.0	54.0	-23.7	-	108	33
7236.00	39.7	-	-	-	-	-	-	-	-	-	-

Channel 1 ANTENNA POLARITY: Horizontal		Detector Function : Peak Average				6dB Bandwidth : 1 MHz.				Distance : 3 M Frequency Range : Above 1000 MHz.	
Frequency (MHz)	Correction Factor (dB)	Reading Value (dBuV)		Emission Level (dBuV/m)		Limit (dBuV/m)		Margin (dB)		Antenna Height (cm)	Table Angle (Degree)
		P.K.	A.V.	P.K.	A.V.	P.K.	A.V.	P.K.	A.V.		
1672.30	31.1	16.5	-	47.6	-	74.0	54.0	-26.4	-	130	203
2038.03	33.1	16.8	-	49.9	-	74.0	54.0	-24.1	-	146	-8
*2412.00	34.3	62.5	54.5	96.8	88.8	-	-	-	-	125	19
4076.20	40.0	10.4	-	50.4	-	74.0	54.0	-23.6	-	156	362
4824.00	41.3	9.2	-	50.5	-	74.0	54.0	-23.5	-	122	11
7236.00	39.7	-	-	-	-	-	-	-	-	-	-

- Remarks:**
- 1. Emission level (dBuV/m) = Correction Factor (dB) + Reading value (dBuV).**
 - 2. Correction Factor (dB) = Ant. Factor (dB)+Cable loss (dB)**
 - 3. The other emission levels were very low against the limit.**
 - 4. Margin value = Emission level - Limit value**
 - 5. The limit value is defined as per 15.247**
 - 6. “ * “ : Fundamental Frequency**



Channel 6 ANTENNA POLARITY: Vertical		Detector Function : Peak Average				6dB Bandwidth : 1 MHz.				Distance : 3 M Frequency Range : Above 1000 MHz.	
Frequency (MHz)	Correction Factor (dB)	Reading Value (dBuV)		Emission Level (dBuV/m)		Limit (dBuV/m)		Margin (dB)		Antenna Height (cm)	Table Angle (Degree)
		P.K.	A.V.	P.K.	A.V.	P.K.	A.V.	P.K.	A.V.		
1688.70	31.2	17.2	-	48.4	-	74.0	54.0	-25.6	-	122	279
2063.05	33.2	17.8	-	51.0	-	74.0	54.0	-23.0	-	122	26
*2437.00	34.4	65.4	57.2	99.8	91.6	-	-	-	-	107	276
4126.00	39.9	13.1	-	53.0	-	74.0	54.0	-21.0	-	106	362
4874.00	41.2	9.2	-	50.4	-	74.0	54.0	-23.6	-	107	366
7311.00	39.7	-	-	-	-	-	-	-	-	-	-

Channel 6 ANTENNA POLARITY: Horizontal		Detector Function : Peak Average				6dB Bandwidth : 1 MHz.				Distance : 3 M Frequency Range : Above 1000 MHz.	
Frequency (MHz)	Correction Factor (dB)	Reading Value (dBuV)		Emission Level (dBuV/m)		Limit (dBuV/m)		Margin (dB)		Antenna Height (cm)	Table Angle (Degree)
		P.K.	A.V.	P.K.	A.V.	P.K.	A.V.	P.K.	A.V.		
1688.70	31.2	16.0	-	47.2	-	74.0	54.0	-26.8	-	104	9
2063.03	33.2	18.3	-	51.5	-	74.0	54.0	-22.5	-	120	348
*2437.00	34.4	59.8	51.7	94.2	86.1	-	-	-	-	126	18
4126.00	39.9	11.7	-	51.6	-	74.0	54.0	-22.4	-	118	351
4874.00	41.2	9.3	-	50.5	-	74.0	54.0	-23.5	-	113	363
7311.00	39.7	-	-	-	-	-	-	-	-	-	-

- Remarks:**
1. Emission level (dBuV/m) = Correction Factor (dB) + Reading value (dBuV).
 2. Correction Factor (dB) = Ant. Factor (dB)+Cable loss (dB)
 3. The other emission levels were very low against the limit.
 4. Margin value = Emission level - Limit value
 5. The limit value is defined as per 15.247
 6. " * " : Fundamental Frequency



Channel 11 ANTENNA POLARITY: Vertical		Detector Function : Peak Average				6dB Bandwidth : 1 MHz.				Distance : 3 M Frequency Range : Above 1000 MHz.	
Frequency (MHz)	Correction Factor (dB)	Reading Value (dBuV)		Emission Level (dBuV/m)		Limit (dBuV/m)		Margin (dB)		Antenna Height (cm)	Table Angle (Degree)
		P.K.	A.V.	P.K.	A.V.	P.K.	A.V.	P.K.	A.V.		
2088.03	33.2	16.3	-	49.5	-	74.0	54.0	-24.5	-	100	202
*2462.00	34.5	62.0	54.0	96.5	88.5	-	-	-	-	100	103
4176.07	39.9	11.5	-	51.4	-	74.0	54.0	-22.6	-	100	-2
4924.00	41.4	10.3	-	51.7	-	74.0	54.0	-22.3	-	103	-2
7386.00	39.7	-	-	-	-	-	-	-	-	-	-

Channel 11 ANTENNA POLARITY: Horizontal		Detector Function : Peak Average				6dB Bandwidth : 1 MHz.				Distance : 3 M Frequency Range : Above 1000 MHz.	
Frequency (MHz)	Correction Factor (dB)	Reading Value (dBuV)		Emission Level (dBuV/m)		Limit (dBuV/m)		Margin (dB)		Antenna Height (cm)	Table Angle (Degree)
		P.K.	A.V.	P.K.	A.V.	P.K.	A.V.	P.K.	A.V.		
2087.61	33.2	18.9	-	52.1	-	74.0	54.0	-21.9	-	100	266
*2462.00	34.5	66.9	58.5	101.4	93.0	-	-	-	-	100	-2
4176.04	39.9	12.5	-	52.4	-	74.0	54.0	-21.6	-	100	96
4924.00	41.4	11.0	-	52.4	-	74.0	54.0	-21.6	-	100	1
7386.00	-	-	-	-	-	-	-	-	-	-	-

- Remarks:**
1. Emission level (dBuV/m) = Correction Factor (dB) + Reading value (dBuV).
 2. Correction Factor (dB) = Ant. Factor (dB)+Cable loss (dB)
 3. The other emission levels were very low against the limit.
 4. Margin value = Emission level - Limit value
 5. The limit value is defined as per 15.247
 6. “ * “ : Fundamental Frequency



6.4.7.2 Model name:WX1520

CHANNEL:1 ANTENNA POLARITY: Vertical		Detector Function : Quasi-Peak		6dB Bandwidth : 120 kHz.		Distance : 3 M Frequency Range : 30 – 1000 MHz.	
Frequency (MHz)	Correction Factor (dB)	Reading Value (dBuV)	Emission Level (dBuV/m)	Limit (dBuV/m)	Margin (dB)	Antenna Height (cm)	Table Angle (Degree)
176.12	10.9	21.4	32.3	43.5	-11.2	103	33
200.03	10.2	15.4	25.6	43.5	-17.9	100	363
352.23	16.4	16.2	32.6	46.0	-13.4	100	325
440.27	18.5	19.4	37.9	46.0	-8.1	145	230
484.58	19.4	7.4	26.8	46.0	-19.2	100	259
500.00	19.8	11.3	31.1	46.0	-14.9	154	294
528.33	20.4	15.2	35.6	46.0	-10.4	132	-2
616.39	21.1	15.4	36.5	46.0	-9.5	109	254
792.49	22.4	13.1	35.5	46.0	-10.5	103	-2
880.53	23.3	9.0	32.3	46.0	-13.7	100	62

CHANNEL:1 ANTENNA POLARITY: Horizontal		Detector Function : Quasi-Peak		6dB Bandwidth : 120 kHz.		Distance : 3 M Frequency Range : 30 – 1000 MHz.	
Frequency (MHz)	Correction Factor (dB)	Reading Value (dBuV)	Emission Level (dBuV/m)	Limit (dBuV/m)	Margin (dB)	Antenna Height (cm)	Table Angle (Degree)
176.12	10.9	18.9	29.8	43.5	-13.7	140	262
352.21	16.4	18.5	34.9	46.0	-11.1	120	75
440.27	18.5	17.2	35.7	46.0	-10.3	133	39
484.07	19.4	7.1	26.5	46.0	-19.5	100	270
500.04	19.8	10.3	30.1	46.0	-15.9	196	118
528.33	20.4	11.8	32.2	46.0	-13.8	186	104
616.38	21.1	10.5	31.6	46.0	-14.4	139	197
792.49	22.4	11.3	33.7	46.0	-12.3	131	288
880.54	23.3	13.0	36.3	46.0	-19.7	117	273



CHANNEL:6 ANTENNA POLARITY: Vertical		Detector Function : Quasi-Peak		6dB Bandwidth : 120 kHz.		Distance : 3 M Frequency Range : 30 – 1000 MHz.	
Frequency (MHz)	Correction Factor (dB)	Reading Value (dBuV)	Emission Level (dBuV/m)	Limit (dBuV/m)	Margin (dB)	Antenna Height (cm)	Table Angle (Degree)
176.12	10.9	22.3	33.2	46.5	-10.3	109	49
352.22	16.4	16.7	33.1	46.0	-12.9	106	54
440.28	18.5	18.3	36.8	46.0	-9.2	138	222
500.02	19.8	11.4	31.2	46.0	-14.8	107	134
528.33	20.4	15.2	35.6	46.0	-10.4	133	250
616.38	21.1	16.1	37.2	46.0	-8.8	103	263
704.43	21.7	16.1	37.8	46.0	-8.2	102	267
792.48	22.4	13.9	36.3	46.0	-9.7	184	280
880.55	23.3	8.9	32.2	46.0	-13.8	167	80
968.59	24.1	9.9	34.0	54.0	-20.0	132	96

CHANNEL:6 ANTENNA POLARITY: Horizontal		Detector Function : Quasi-Peak		6dB Bandwidth : 120 kHz.		Distance : 3 M Frequency Range : 30 – 1000 MHz.	
Frequency (MHz)	Correction Factor (dB)	Reading Value (dBuV)	Emission Level (dBuV/m)	Limit (dBuV/m)	Margin (dB)	Antenna Height (cm)	Table Angle (Degree)
176.12	10.9	21.7	32.6	43.5	-10.9	197	272
352.23	16.4	19.0	35.4	46.0	-10.6	150	67
440.28	18.5	18.7	37.2	46.0	-8.8	162	39
500.04	19.8	10.4	30.2	46.0	-15.8	100	267
528.33	20.4	11.8	32.2	46.0	-13.8	174	255
616.38	21.1	12.6	33.7	46.0	-12.3	153	227
704.43	21.7	17.2	38.9	46.0	-7.1	151	294
792.49	22.4	10.0	32.4	46.0	-13.6	121	141
880.54	23.3	12.6	35.9	46.0	-10.1	101	262
968.59	24.1	8.0	32.1	54.0	-21.9	108	253



CHANNEL:11 ANTENNA POLARITY: Vertical		Detector Function : Quasi-Peak		6dB Bandwidth : 120 kHz.		Distance : 3 M Frequency Range : 30 – 1000 MHz.	
Frequency (MHz)	Correction Factor (dB)	Reading Value (dBuV)	Emission Level (dBuV/m)	Limit (dBuV/m)	Margin (dB)	Antenna Height (cm)	Table Angle (Degree)
176.11	10.9	21.9	32.8	43.5	-10.7	100	363
200.49	10.2	16.5	26.7	43.5	-16.8	110	195
352.22	16.4	17.5	33.9	46.0	-12.1	100	333
440.28	18.5	20.2	38.7	46.0	-7.3	135	221
500.01	19.8	12.0	31.8	46.0	-14.2	121	129
528.33	20.4	15.1	35.5	46.0	-10.5	136	256
616.38	21.1	15.9	37.0	46.0	-9.0	100	259
704.43	21.7	16.3	38.0	46.0	-8.0	103	267
792.48	22.4	13.8	36.2	46.0	-9.8	185	282
880.54	23.3	9.9	33.2	46.0	-12.8	140	140
968.59	24.1	9.8	33.9	54.0	-20.1	133	94

CHANNEL:11 ANTENNA POLARITY: Horizontal		Detector Function : Quasi-Peak		6dB Bandwidth : 120 kHz.		Distance : 3 M Frequency Range : 30 – 1000 MHz.	
Frequency (MHz)	Correction Factor (dB)	Reading Value (dBuV)	Emission Level (dBuV/m)	Limit (dBuV/m)	Margin (dB)	Antenna Height (cm)	Table Angle (Degree)
176.12	10.9	20.4	31.3	43.5	-12.2	160	252
352.22	16.4	15.7	32.1	46.0	-13.9	100	366
440.28	18.5	15.8	34.3	46.0	-11.7	100	262
500.05	19.8	11.1	30.9	46.0	-15.1	100	271
528.32	20.4	11.9	32.3	46.0	-13.7	100	276
616.38	21.1	11.8	32.9	46.0	-13.1	114	199
704.43	21.7	17.1	38.8	46.0	-7.2	124	294
792.48	22.4	11.5	33.9	46.0	-12.1	139	302
880.54	23.3	12.8	36.1	46.0	-9.9	110	272
968.60	24.1	9.3	33.4	54.0	-20.6	103	262

- Remarks:**
1. Emission level (dBuV/m) = Correction Factor (dB) + Reading value (dBuV).
 2. Correction Factor (dB) = Ant. Factor (dB)+Cable loss (dB)
 3. The other emission levels were very low against the limit.
 4. Margin value = Emission level - Limit value
 5. The limit value is defined as per 15.247



Channel 1 ANTENNA POLARITY: Vertical		Detector Function : Peak Average				6dB Bandwidth : 1 MHz.				Distance : 3 M Frequency Range : Above 1000 MHz.	
Frequency (MHz)	Correction Factor (dB)	Reading Value (dBuV)		Emission Level (dBuV/m)		Limit (dBuV/m)		Margin (dB)		Antenna Height (cm)	Table Angle (Degree)
		P.K.	A.V.	P.K.	A.V.	P.K.	A.V.	P.K.	A.V.		
1673.03	31.1	16.1	-	47.2	-	74.0	54.0	-26.8	-	118	304
2037.75	33.1	16.2	-	49.3	-	74.0	54.0	-24.7	-	118	260
*2412.00	34.3	67.3	58.7	101.6	93.0	-	-	-	-	124	52
4824.00	41.3	9.0	-	50.3	-	74.0	54.0	-23.7	-	113	363
7236.00	39.7	-	-	-	-	-	-	-	-	-	-

Channel 1 ANTENNA POLARITY: Horizontal		Detector Function : Peak Average				6dB Bandwidth : 1 MHz.				Distance : 3 M Frequency Range : Above 1000 MHz.	
Frequency (MHz)	Correction Factor (dB)	Reading Value (dBuV)		Emission Level (dBuV/m)		Limit (dBuV/m)		Margin (dB)		Antenna Height (cm)	Table Angle (Degree)
		P.K.	A.V.	P.K.	A.V.	P.K.	A.V.	P.K.	A.V.		
1673.03	31.1	14.4	-	45.5	-	74.0	54.0	-28.5	-	144	54
2038.05	33.1	15.3	-	48.4	-	74.0	54.0	-25.6	-	170	92
*2412.00	34.3	59.7	53.9	94.0	88.2	-	-	-	-	113	328
4075.90	40.0	13.6	-	53.6	-	74.0	54.0	-20.4	-	144	316
4824.00	41.3	8.7	-	50.0	-	74.0	54.0	-24.0	-	113	-6
7236.00	39.7	-	-	-	-	-	-	-	-	-	-

- Remarks:**
1. Emission level (dBuV/m) = Correction Factor (dB) + Reading value (dBuV).
 2. Correction Factor (dB) = Ant. Factor (dB)+Cable loss (dB)
 3. The other emission levels were very low against the limit.
 4. Margin value = Emission level - Limit value
 5. The limit value is defined as per 15.247
 6. " * " : Fundamental Frequency



Channel 6 ANTENNA POLARITY: Vertical		Detector Function : Peak Average				6dB Bandwidth : 1 MHz.				Distance : 3 M Frequency Range : Above 1000 MHz.	
Frequency (MHz)	Correction Factor (dB)	Reading Value (dBuV)		Emission Level (dBuV/m)		Limit (dBuV/m)		Margin (dB)		Antenna Height (cm)	Table Angle (Degree)
		P.K.	A.V.	P.K.	A.V.	P.K.	A.V.	P.K.	A.V.		
2063.05	33.2	18.6	-	51.8	-	74.0	54.0	-22.2	-	108	261
*2437.00	34.4	64.4	56.4	98.8	90.8	-	-	-	-	108	170
4126.00	39.9	13.2	-	53.1	-	74.0	54.0	-20.9	-	116	50
4874.00	41.2	8.6	-	49.8	-	74.0	54.0	-24.2	-	107	215
7311.00	39.7	-	-	-	-	-	-	-	-	-	-

Channel 6 ANTENNA POLARITY: Horizontal		Detector Function : Peak Average				6dB Bandwidth : 1 MHz.				Distance : 3 M Frequency Range : Above 1000 MHz.	
Frequency (MHz)	Correction Factor (dB)	Reading Value (dBuV)		Emission Level (dBuV/m)		Limit (dBuV/m)		Margin (dB)		Antenna Height (cm)	Table Angle (Degree)
		P.K.	A.V.	P.K.	A.V.	P.K.	A.V.	P.K.	A.V.		
1688.80	31.2	14.8	-	46.0	-	74.0	54.0	-28.0	-	111	275
2063.10	33.2	16.8	-	50.0	-	74.0	54.0	-24.0	-	115	190
*2437.00	34.4	61.4	53.3	95.8	87.7	-	-	-	-	113	38
4126.00	39.9	13.4	-	53.3	-	74.0	54.0	-20.7	-	115	325
4874.00	41.2	8.3	-	49.5	-	74.0	54.0	-24.5	-	111	229
7311.00	39.7	-	-	-	-	-	-	-	-	-	-

- Remarks:**
1. Emission level (dBuV/m) = Correction Factor (dB) + Reading value (dBuV).
 2. Correction Factor (dB) = Ant. Factor (dB)+Cable loss (dB)
 3. The other emission levels were very low against the limit.
 4. Margin value = Emission level - Limit value
 5. The limit value is defined as per 15.247
 6. " * " : Fundamental Frequency



Channel 11 ANTENNA POLARITY: Vertical		Detector Function : Peak Average				6dB Bandwidth : 1 MHz.				Distance : 3 M Frequency Range : Above 1000 MHz.	
Frequency (MHz)	Correction Factor (dB)	Reading Value (dBuV)		Emission Level (dBuV/m)		Limit (dBuV/m)		Margin (dB)		Antenna Height (cm)	Table Angle (Degree)
		P.K.	A.V.	P.K.	A.V.	P.K.	A.V.	P.K.	A.V.		
2088.10	33.2	17.0	-	50.2	-	74.0	54.0	-23.8	-	100	298
*2462.00	34.5	63.3	55.1	97.8	89.6	-	-	-	-	107	118
4176.04	39.9	13.1	-	53.0	-	74.0	54.0	-21.0	-	100	309
4924.00	41.4	8.1	-	49.5	-	74.0	54.0	-24.5	-	104	362
7386.00	39.7	-	-	-	-	-	-	-	-	-	-

Channel 11 ANTENNA POLARITY: Horizontal		Detector Function : Peak Average				6dB Bandwidth : 1 MHz.				Distance : 3 M Frequency Range : Above 1000 MHz.	
Frequency (MHz)	Correction Factor (dB)	Reading Value (dBuV)		Emission Level (dBuV/m)		Limit (dBuV/m)		Margin (dB)		Antenna Height (cm)	Table Angle (Degree)
		P.K.	A.V.	P.K.	A.V.	P.K.	A.V.	P.K.	A.V.		
2088.04	33.2	17.1	-	50.3	-	74.0	54.0	-23.7	-	100	350
*2462.00	34.5	59.0	51.2	93.5	85.7	-	-	-	-	100	238
4176.04	39.9	11.9	-	51.8	-	74.0	54.0	-22.2	-	100	323
4924.00	41.4	8.0	-	49.4	-	74.0	54.0	-24.6	-	100	362
7386.00	-	-	-	-	-	-	-	-	-	-	-

- Remarks:**
1. Emission level (dBuV/m) = Correction Factor (dB) + Reading value (dBuV).
 2. Correction Factor (dB) = Ant. Factor (dB)+Cable loss (dB)
 3. The other emission levels were very low against the limit.
 4. Margin value = Emission level - Limit value
 5. The limit value is defined as per 15.247
 6. “ * “ : Fundamental Frequency

6.5 Power Spectral Density Measurement

6.5.1 Test Instruments

Description & Manufacturer	Model No.	Serial No.	Calibrated Until
ROHDE & SCHWARZ TEST RECEIVER	ESMI	846839/018 848926/005	Dec. 03, 2000
HP ATTENUATOR	8496B	3247A18505	Cal. on use
HP PLOTTER	7475A	2641V27755	N/A

The measurement uncertainty is less than +/- 2.6dB, which is calculated as per NAMAS document NIS81.

6.5.2 Test Procedure

The transmitter output was connected to the spectrum analyzer through an attenuator, the bandwidth of the fundamental frequency was measured with the spectrum analyzer using 3 kHz RBW and 30 kHz VBW, set sweep time=span/3kHz. The power spectral density was measured and recorded. The longer sweep time is allowed for the detection of the maximum radiation through each 3KHz filter.

6.5.3 Test Setup

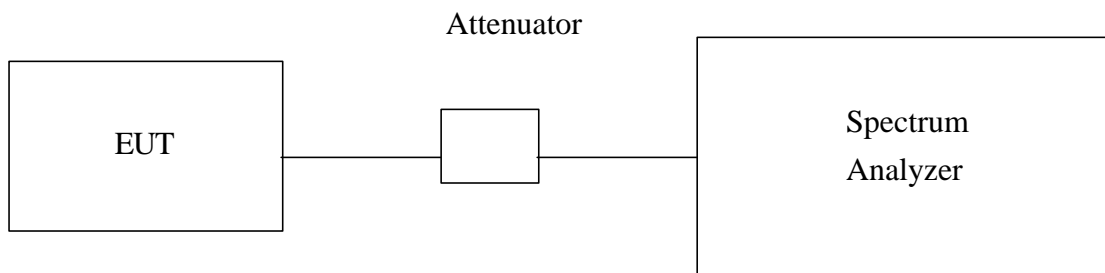

6.5.4 EUT Operating Condition

The software provided by client enabled the EUT to transmit and receive data at lowest, middle and highest channel frequencies individually.



6.5.5 Climate Condition

The temperature and related humidity: 18 and 78%

6.5.6 Test Result

CHANNEL NUMBER	CHANNEL FREQUENCY (MHz)	RF POWER LEVEL IN 3 KHz BW (dBm)	MAXIMUM LIMIT (dBm)	PASS/FAIL
1	2412	-12.00	8	PASS
6	2437	-12.33	8	PASS
11	2462	-12.38	8	PASS

The spectrum plots of test result are attached as below.



CHI

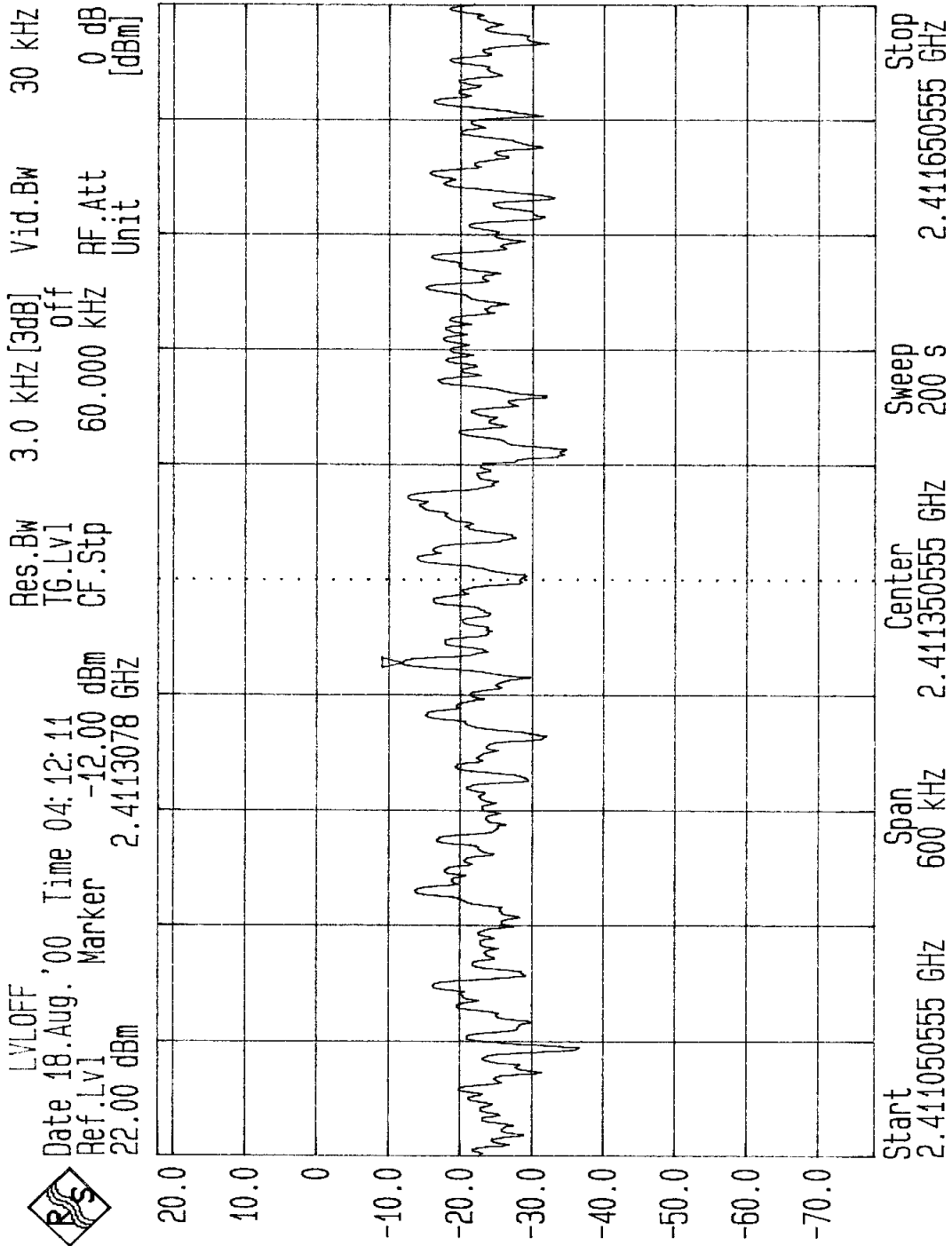



CH6

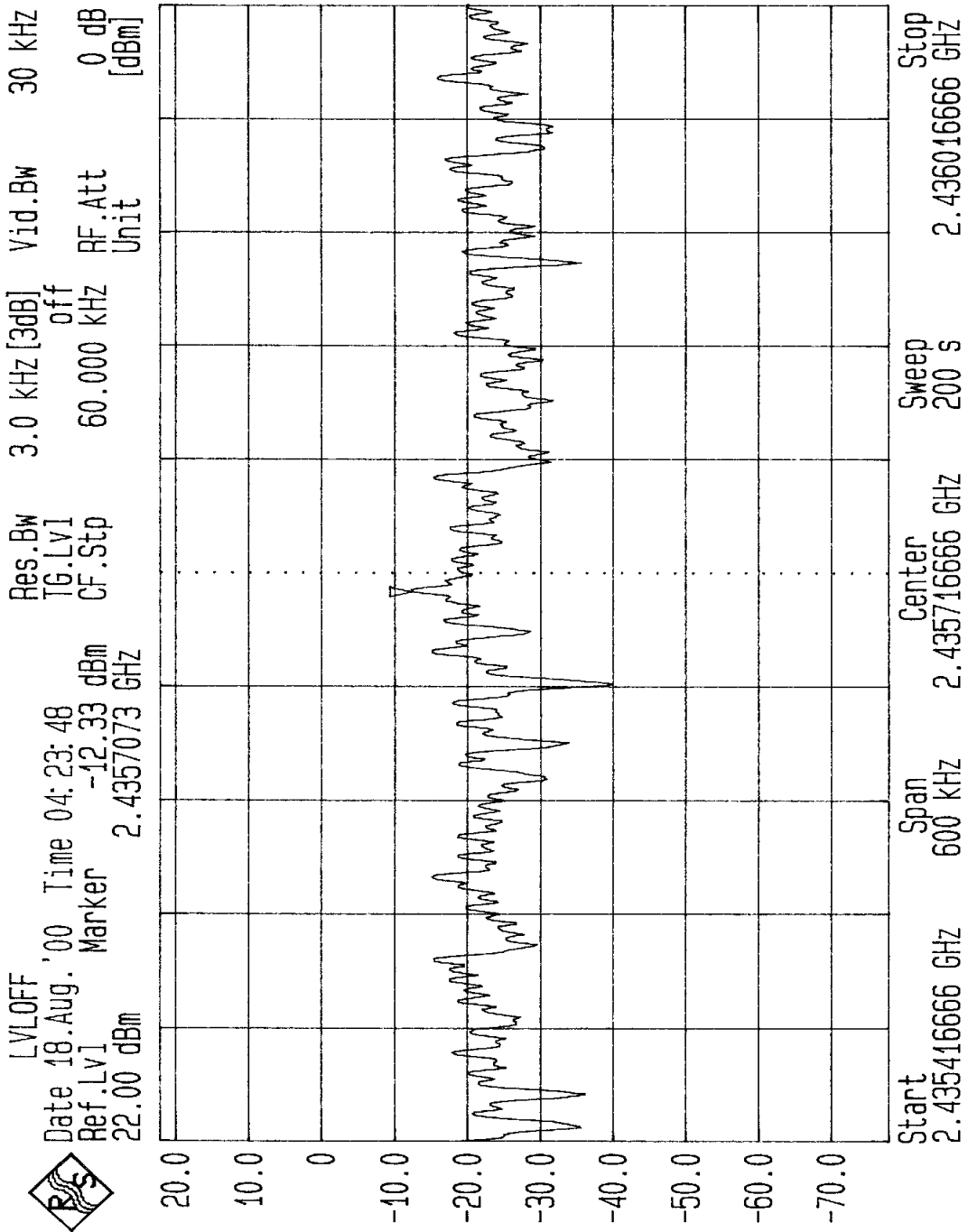



CH11

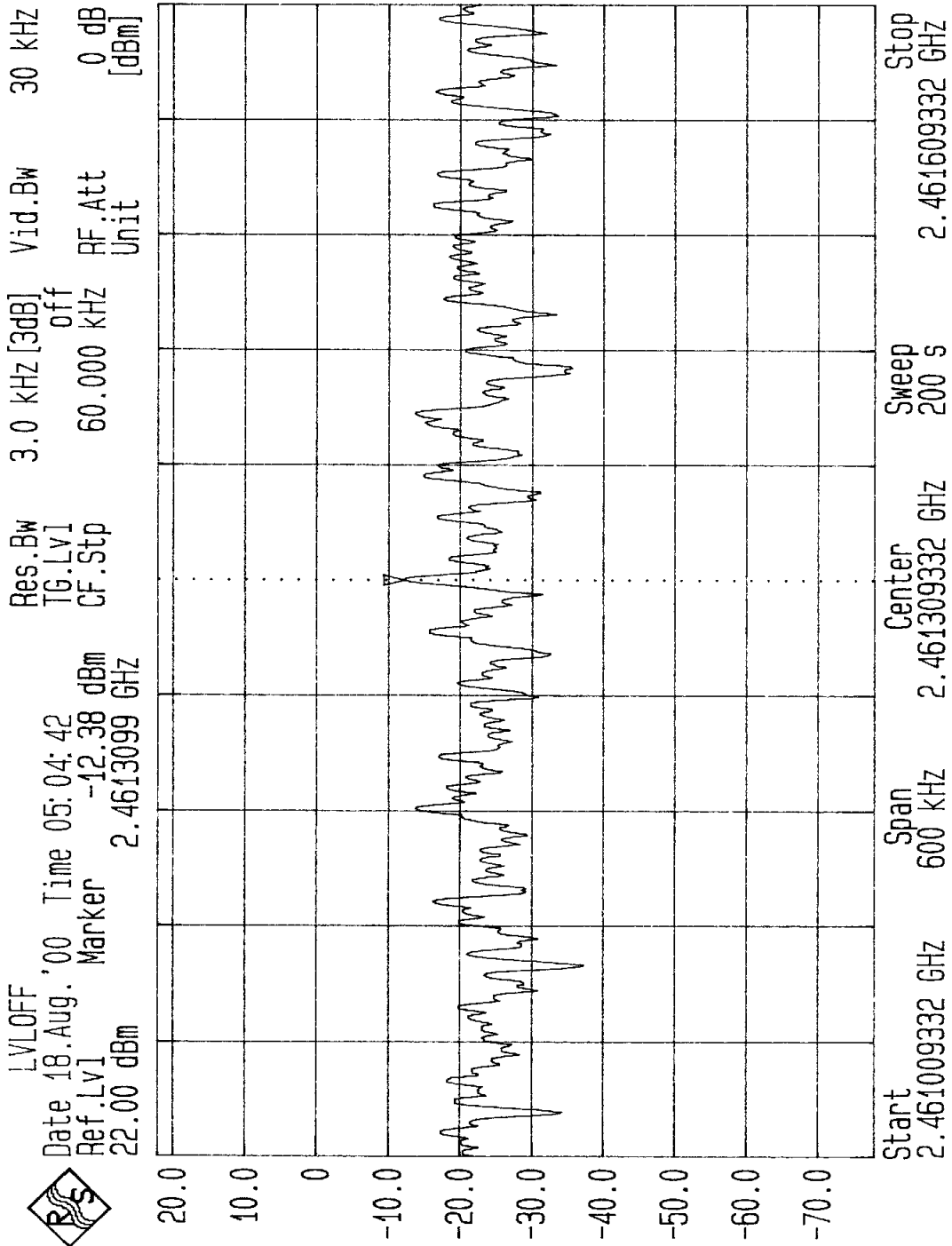



6.6 Processing Gain of a Direct Sequence Spread Spectrum Measurement

6.6.1 Test Instruments and Support Units

Description & Manufacturer	Model No.	Serial No.
Hewlett Packard Spectrum Analyzer, 9kHz to 22GHz	HP8593E	S942848
Marconi Signal Generator, 10kHz to 2.7GHz	2031	953426
Hewlett Packard Power Meter,	HP438A	S952633
Hewlett Packard Power Sensor, -20 to -70dBm	HP8481D	SCD15369
Hewlett Packard Attenuator, 6dB to 10 dB	HP8493A	NA
Hewlett Packard Step Attenuator, 1dB steps	HP8494A	NA
Hewlett Packard Step Attenuator, 10dB steps	HP8495D	NA
Hewlett Packard Power Splitter,	HP11667B	04390
Cmpaq Laptop Computer (Qty 2),	Armada 1700	NA

6.6.2 Method of Measurement

Since the product is used for data transmission, so the recommended BER is 10^{-5} . One packet contents 8 bits, so the recommended Packet Error Rate (PER) is 8%. The processing gain may be measured using the CW jamming margin method. Figure 1 shows the test configuration. The test consists of stepping a signal generator in 50 kHz increments across the passband of the system. At each point, the generator level required to produce the recommended Bit Error Rate (BER) is recorded. This level is jammer level. The output power of the transmitting unit is measured at the same point. The jammer to Signal (J/S) ratio is then calculated. Discard the worst 20% of the J/S data points. The lowest remaining J/S ratio is used when calculating the Process Gain.

The reference PER is specified as 8%. The corresponding Es/No (signal to noise ratio per symbol) is 16.4 dB. The curve is attached as below.

1.1 1000 byte PER vs. Es/No

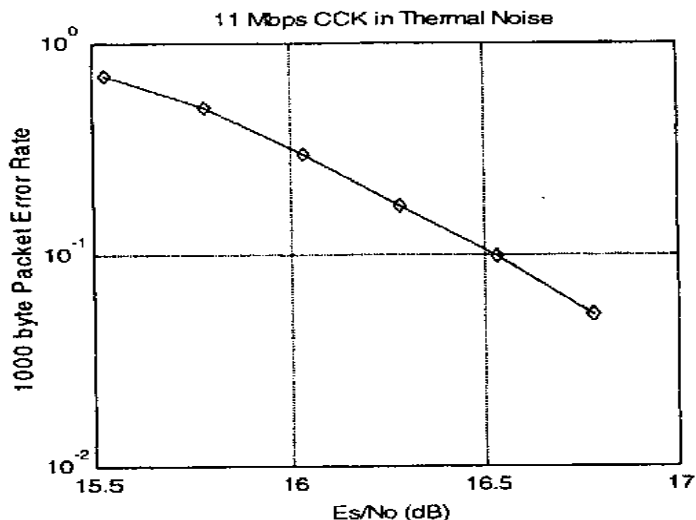

This value and the measured J/S ratio are used in the following equation to calculate the Process Gain (Gp) of the system.

$$G_p = (S/N)_o + M_j + L_{sys}$$

Where:

(S/N)_o: Signal to noise ratio for the chosen BER.

M_j : Maximum jammer to Signal Ratio recorded at the detected BER.

L_{sys} : System losses . For the purpose of this processing gain calculation, we assume L_{sys} at its minimum value of 2 dB.

Applicable Reference Documents.

1. "HFA3861A Direct Sequence Spread Spectrum Baseband Processor" Harris Corporation Semiconductor Sector Preliminary Data Sheet, Melbourne FL, July 1999.
2. "M-ary Orthogonal Keying BER Curve" .

6.6.3 Test Setup

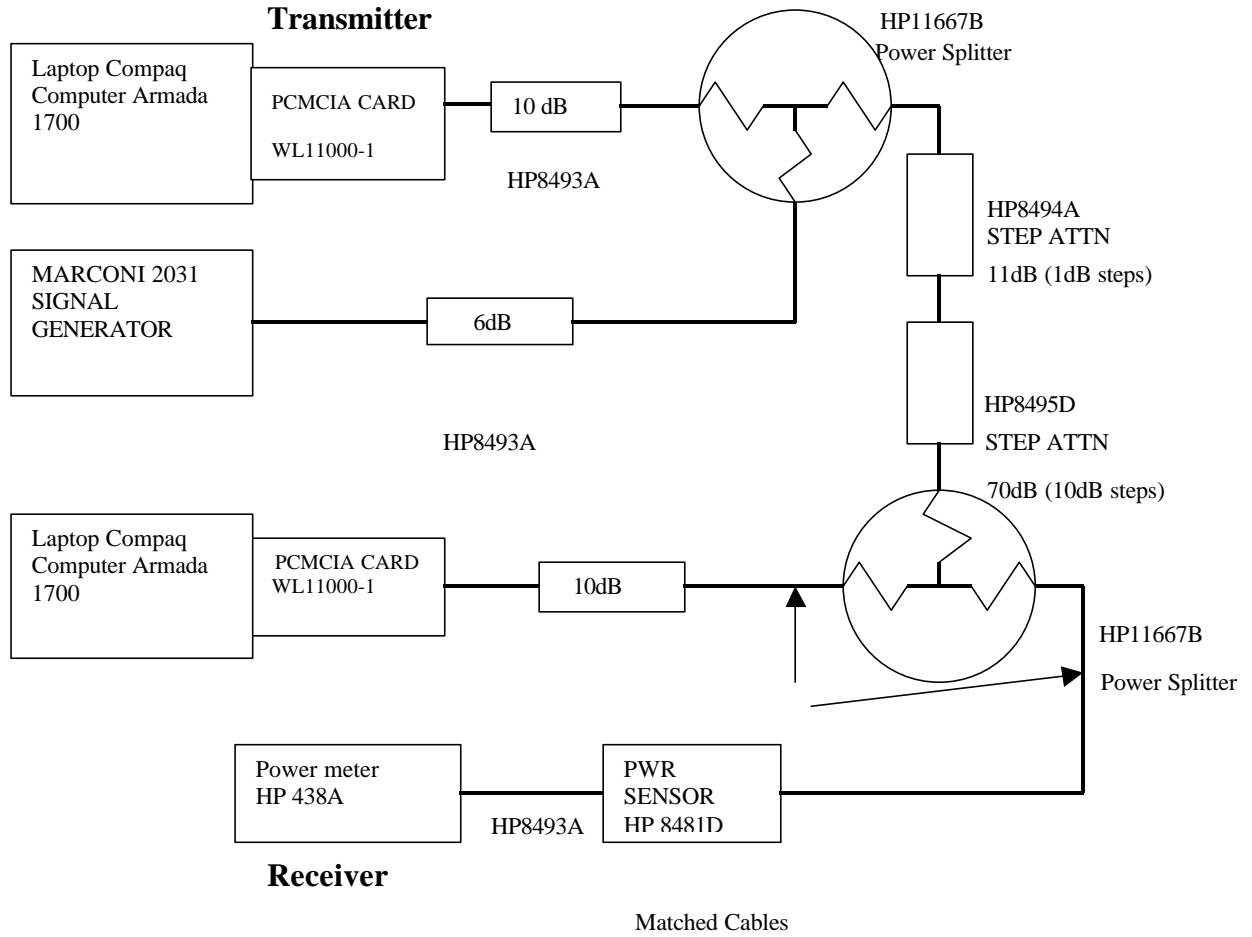



6.6.4 Test Procedure

Obtain the simplex link shown. Perform all independent instrumentation calibrations prior to this procedure. Set operating power levels using fixed and variable attenuators in system to meet the following objectives:

1. Signal Power at receiver approximately -60dBm (above thermal sensitivity such that thermal noise does not cause bit errors).
2. Signal Power at power meter between -20 and -30dBm for optimal linearity.
3. Use spectrum analyzer to monitor test.
4. Ensure that CW Jammer generator RF output is disabled and measure the power at the power meter port using the power meter. This is the relative signal power, S_r .
5. Disable Transmitter, and set CW Jammer generator RF output frequency equal to the carrier frequency and enable generator output. Set reference CW Jammer power level at power meter port 8.4dB below S_r (minimum J/S, or 10dB processing gain reference level). Note the power level setting on the generator, this is the reference CW Jammer power setting, J_r .
6. Disable CW Jammer, re-establish link. PER test should be operating essentially error-free.
7. Enable CW Jammer at the reference power level and verify that the PER test indicates a PER of less than 8%.
8. Alternatively, adjust the CW Jammer level to that which causes 8% PER and verify that the S/J is less than 8.4dB .
9. Repeat step 7 for uniform steps in frequency increments of 50 kHz across the receiver passband with the CW Jammer. In this case the receiver passband is $\pm 8.5\text{ MHz}$.

The numerical data associated with the following radio channel is tabulated and presented for :

Channel 1	:2412 MHz
Channel 6	:2437 MHz
Channel 11	:2462 MHz



6.6.5 EUT Operating condition

Software provided by client to set the EUT to transmit at lowest, middle and highest channel.

6.6.6 Climate Condition

The temperature and related humidity: 25° C and 50%



6.6.7 Test Results

Although the theoretical processing gain is lower than 10 dB, but the CCK coding provides an extra coding gain of 2.2dB.

11Mbps CHANNEL 1 Processing Gain						
Gp = (S/N) _o + Mj + Lsys						
Freq. (GHz)	Gp (dB)	(S/N) _o (dB)	Mj = J/S (dB)	Lsys (dB)	Jammer (dBm)	LVL (dBm)
2.4095	11.3	16.4	-7.1	2	-47.1	-0.7
2.40955	11.4	16.4	-7	2	-47	-0.6
2.4096	11.4	16.4	-7	2	-47	-0.6
2.40965	11.4	16.4	-7	2	-47	-0.6
2.4097	11.3	16.4	-7.1	2	-47.1	-0.7
2.40975	11.3	16.4	-7.1	2	-47.1	-0.7
2.4098	11.1	16.4	-7.3	2	-47.3	-0.9
2.40985	11.1	16.4	-7.3	2	-47.3	0.9
2.4099	11	16.4	-7.4	2	-47.4	-1
2.40995	11	16.4	-7.4	2	-47.4	-1
2.41	10.9	16.4	-7.5	2	-47.5	-1.1
2.41005	11	16.4	-7.4	2	-47.4	-1
2.4101	11	16.4	-7.4	2	-47.4	-1
2.41015	11.1	16.4	-7.3	2	-47.3	-0.9
2.4102	11.2	16.4	-7.2	2	-47.2	-0.8
2.41025	11.3	16.4	-7.1	2	-47.1	-0.7
2.4103	11.3	16.4	-7.1	2	-47.1	-0.7
2.41035	11.4	16.4	-7	2	-47	-0.6
2.4104	11.3	16.4	-7.1	2	-47.1	-0.7
2.41045	11.3	16.4	-7.1	2	-47.1	-0.7
2.4105	11.3	16.4	-7.1	2	-47.1	-0.7
2.41055	11.2	16.4	-7.2	2	-47.2	-0.8
2.4106	11.2	16.4	-7.2	2	-47.2	-0.8
2.41065	11.3	16.4	-7.1	2	-47.1	-0.7
2.4107	11.3	16.4	-7.1	2	-47.1	-0.7
2.41075	11.3	16.4	-7.1	2	-47.1	-0.7
2.4108	11.4	16.4	-7	2	-47	-0.6
2.41085	11.5	16.4	-6.9	2	-46.9	-0.5
2.4109	11.6	16.4	-6.8	2	-46.8	-0.4
2.41095	11.6	16.4	-6.8	2	-46.8	-0.4
2.411	11.6	16.4	-6.8	2	-46.8	-0.4
2.41105	11.4	16.4	-7	2	-47	-0.6
2.4111	11.5	16.4	-6.9	2	-46.9	-0.5
2.41115	11.6	16.4	-6.8	2	-46.8	-0.4



11Mbps CHANNEL 1 Processing Gain						
Gp = (S/N) _o + Mj + Lsys						
Freq. (GHz)	Gp (dB)	(S/N) _o (dB)	Mj = J/S (dB)	Lsys (dB)	Jammer (dBm)	LVL (dBm)
2.4112	11.5	16.4	-6.9	2	-46.9	-0.5
2.41125	11.5	16.4	-6.9	2	-46.9	-0.5
2.4113	11.5	16.4	-6.9	2	-46.9	-0.5
2.41135	11.4	16.4	-7	2	-47	-0.6
2.4114	11.4	16.4	-7	2	-47	-0.6
2.41145	11.4	16.4	-7	2	-47	-0.6
2.4115	11.4	16.4	-7	2	-47	-0.6
2.41155	11.4	16.4	-7	2	-47	-0.6
2.4116	11.6	16.4	-6.8	2	-46.8	-0.4
2.41165	11.6	16.4	-6.8	2	-46.8	-0.4
2.4117	11.5	16.4	-6.9	2	-46.9	-0.5
2.41175	11.4	16.4	-7	2	-47	-0.6
2.4118	11.2	16.4	-7.2	2	-47.2	-0.8
2.41185	11.1	16.4	-7.3	2	-47.3	-0.9
2.4119	11	16.4	-7.4	2	-47.4	-1
2.41195	10.8	16.4	-7.6	2	-47.6	-1.2
2.412	10.9	16.4	-7.5	2	-47.5	-1.1
2.41205	10.9	16.4	-7.5	2	-47.5	-1.1
2.4121	11.1	16.4	-7.3	2	-47.3	-0.9
2.41215	11.4	16.4	-7	2	-47	-0.6
2.4122	11.5	16.4	-6.9	2	-46.9	-0.5
2.41225	11.6	16.4	-6.8	2	-46.8	-0.4
2.4123	11.7	16.4	-6.7	2	-46.7	-0.3
2.41235	11.7	16.4	-6.7	2	-46.7	-0.3
2.4124	11.7	16.4	-6.7	2	-46.7	-0.3
2.41245	11.6	16.4	-6.8	2	-46.8	-0.4
2.4125	11.6	16.4	-6.8	2	-46.8	-0.4
2.41255	11.6	16.4	-6.8	2	-46.8	-0.4
2.4126	11.6	16.4	-6.8	2	-46.8	-0.4
2.41265	11.6	16.4	-6.8	2	-46.8	-0.4
2.4127	11.7	16.4	-6.7	2	-46.7	-0.3
2.41275	11.6	16.4	-6.8	2	-46.8	-0.4
2.4128	11.8	16.4	-6.6	2	-46.6	-0.2
2.41285	11.8	16.4	-6.6	2	-46.6	-0.2



11Mbps CHANNEL 1 Processing Gain						
Gp = (S/N) _o + Mj + Lsys						
Freq. (GHz)	Gp (dB)	(S/N) _o (dB)	Mj = J/S (dB)	Lsys (dB)	Jammer (dBm)	LVL (dBm)
2.4129	11.8	16.4	-6.6	2	-46.6	-0.2
2.41295	11.9	16.4	-6.5	2	-46.5	-0.1
2.413	11.8	16.4	-6.6	2	-46.6	-0.2
2.41305	11.8	16.4	-6.6	2	-46.6	-0.2
2.4131	11.8	16.4	-6.6	2	-46.6	-0.2
2.41315	11.7	16.4	-6.7	2	-46.7	-0.3
2.4132	11.6	16.4	-6.8	2	-46.8	-0.4
2.41325	11.7	16.4	-6.7	2	-46.7	-0.3
2.4133	11.6	16.4	-6.8	2	-46.8	-0.4
2.41335	11.6	16.4	-6.8	2	46.8	-0.4
2.4134	11.6	16.4	-6.8	2	-46.8	-0.4
2.41345	11.6	16.4	-6.8	2	-46.8	-0.4
2.4135	11.6	16.4	-6.8	2	-46.8	-0.4
2.41355	11.7	16.4	-6.8	2	-46.8	-0.4
2.4136	11.6	16.4	-6.7	2	-46.7	-0.3
2.41365	11.7	16.4	-6.7	2	-46.7	-0.3
2.4137	11.7	16.4	-6.7	2	-46.7	-0.3
2.41375	11.7	16.4	-6.7	2	-46.7	-0.3
2.4138	11.6	16.4	-6.8	2	-46.8	-0.4
2.41385	11.5	16.4	-6.9	2	-46.9	-0.5
2.4139	11.4	16.4	-7	2	-47	-0.6
2.41395	11.3	16.4	-7.1	2	-47.1	-0.7
2.414	11.2	16.4	-7.2	2	-47.2	-0.8
2.41405	11.2	16.4	-7.2	2	-47.2	-0.8
2.4141	11.2	16.4	-7.2	2	-47.2	-0.8
2.41415	11.2	16.4	-7.2	2	-47.2	-0.8
2.4142	11.3	16.4	-7.1	2	-47.1	-0.7
2.41425	11.4	16.4	-7	2	-47	-0.6
2.4143	11.5	16.4	-6.9	2	-46.9	-0.5
2.41435	11.5	16.4	-6.9	2	-46.9	-0.5
2.4144	11.5	16.4	-6.9	2	-46.9	-0.5
2.41445	11.5	16.4	-6.9	2	-46.9	-0.5
2.4145	11.4	16.4	-7	2	-47	-0.6
Processing Gain : 11.5 dB						

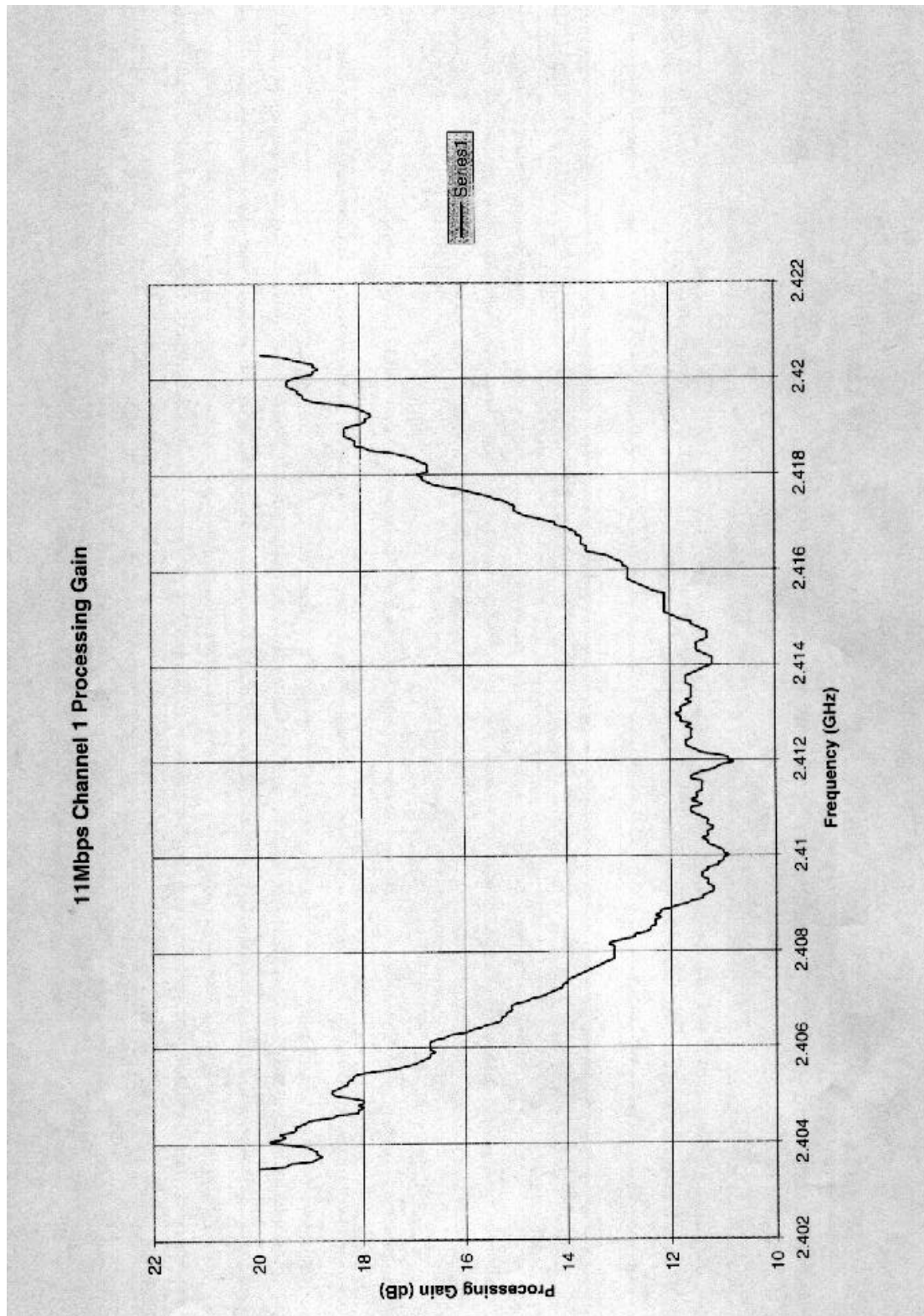



11Mbps CHANNEL 6 Processing Gain						
Gp = (S/N) _o + Mj + Lsys						
Freq. (GHz)	Gp (dB)	(S/N) _o (dB)	Mj = J/S (dB)	Lsys (dB)	Jammer (dBm)	LVL (dBm)
2.4345	11.2	16.4	-7.2	2	-47.2	-3.1
2.43455	11.2	16.4	-7.2	2	-47.2	-3.1
2.4346	11.2	16.4	-7.2	2	-47.2	-3.1
2.43465	11.3	16.4	-7.1	2	-47.1	-3
2.4347	11.3	16.4	-7.1	2	-47.1	-3
2.43475	11.2	16.4	-7.2	2	-47.2	-3.1
2.4348	11.1	16.4	-7.3	2	-47.3	-3.2
2.43485	11.1	16.4	-7.3	2	-47.3	-3.2
2.4349	11	16.4	-7.4	2	-47.4	-3.3
2.43495	11	16.4	-7.4	2	-47.4	-3.3
2.435	11	16.4	-7.4	2	-47.4	-3.3
2.43505	11.1	16.4	-7.3	2	-47.3	-3.2
2.4351	11.1	16.4	-7.3	2	-47.3	-3.2
2.43515	11.2	16.4	-7.2	2	-47.2	-3.1
2.4352	11.3	16.4	-7.1	2	-47.1	-3
2.43525	11.3	16.4	-7.1	2	-47.1	-3
2.4353	11.4	16.4	-7	2	-47	-2.9
2.43535	11.4	16.4	-7	2	-47	-2.9
2.4354	11.3	16.4	-7.1	2	-47.1	-3
2.43545	11.3	16.4	-7.1	2	-47.1	-3
2.4355	11.2	16.4	-7.2	2	-47.2	-3.1
2.43555	11.2	16.4	-7.2	2	-47.2	-3.1
2.4356	11.2	16.4	-7.2	2	-47.2	-3.1
2.43565	11.2	16.4	-7.2	2	-47.2	-3.1
2.4357	11.2	16.4	-7.2	2	-47.2	-3.1
2.43575	11.3	16.4	-7.1	2	-47.1	-3
2.4358	11.4	16.4	-7	2	-47	-2.9
2.43585	11.5	16.4	-6.9	2	-46.9	-2.8
2.4359	11.5	16.4	-6.9	2	-46.9	-2.8
2.43595	11.5	16.4	-6.9	2	-46.9	-2.8
2.436	11.5	16.4	-6.9	2	-46.9	-2.8
2.43605	11.4	16.4	-7	2	-47	-2.9
2.4361	11.5	16.4	-6.9	2	-46.9	-2.8
2.43615	11.5	16.4	-6.9	2	-46.9	-2.8



11Mbps CHANNEL 6 Processing Gain						
Gp = (S/N) _o + Mj + Lsys						
Freq. (GHz)	Gp (dB)	(S/N) _o (dB)	Mj = J/S (dB)	Lsys (dB)	Jammer (dBm)	LVL (dBm)
2.4362	11.5	16.4	-6.9	2	-46.9	-2.8
2.43625	11.5	16.4	-6.9	2	-46.9	-2.8
2.4363	11.5	16.4	-6.9	2	-46.9	-2.8
2.43635	11.4	16.4	-7	2	-47	-2.9
2.4364	11.4	16.4	-7	2	-47	-2.9
2.43645	11.4	16.4	-7	2	-47	-2.9
2.4365	11.4	16.4	-7	2	-47	-2.9
2.43655	11.4	16.4	-7	2	-47	-2.9
2.4366	11.4	16.4	-7	2	-47	-2.9
2.43665	11.5	16.4	-6.9	2	-46.9	-2.8
2.4367	11.5	16.4	-6.9	2	-46.9	-2.8
2.43675	11.4	16.4	-7	2	-47	-2.9
2.4368	11.3	16.4	-7.1	2	-47.1	-3
2.43685	11.1	16.4	-7.3	2	-47.3	-3.2
2.4369	11	16.4	-7.4	2	-47.4	-3.3
2.43695	10.9	16.4	-7.5	2	-47.5	-3.4
2.437	10.9	16.4	-7.5	2	-47.5	-3.4
2.43705	11	16.4	-7.4	2	-47.4	-3.3
2.4371	11.1	16.4	-7.3	2	-47.3	-3.2
2.43715	11.2	16.4	-7.2	2	-47.2	-3.1
2.4372	11.3	16.4	-7.1	2	-47.1	-3
2.43725	11.5	16.4	-6.9	2	-46.9	-2.8
2.4373	11.6	16.4	-6.8	2	-46.8	-2.7
2.43735	11.6	16.4	-6.8	2	-46.8	-2.7
2.4374	11.5	16.4	-6.9	2	-46.9	-2.8
2.43745	11.4	16.4	-7	2	-47	-2.9
2.4375	11.4	16.4	-7	2	-47	-2.9
2.43755	11.5	16.4	-6.9	2	-46.9	-2.8
2.4376	11.5	16.4	-6.9	2	-46.9	-2.8
2.43765	11.5	16.4	-6.9	2	-46.9	-2.8
2.4377	11.5	16.4	-6.9	2	-46.9	-2.8
2.43775	11.5	16.4	-6.9	2	-46.9	-2.8
2.4378	11.6	16.4	-6.8	2	-46.8	-2.7
2.43785	11.7	16.4	-6.7	2	-46.7	-2.6



11Mbps CHANNEL 6 Processing Gain						
Gp = (S/N) _o + Mj + Lsys						
Freq. (GHz)	Gp (dB)	(S/N) _o (dB)	Mj = J/S (dB)	Lsys (dB)	Jammer (dBm)	LVL (dBm)
2.4379	11.8	16.4	-6.6	2	-46.6	-2.5
2.43795	11.7	16.4	-6.7	2	-46.7	-2.6
2.438	11.7	16.4	-6.7	2	-46.7	-2.6
2.43805	11.6	16.4	-6.8	2	-46.8	-2.7
2.4381	11.6	16.4	-6.8	2	-46.8	-2.7
2.43815	11.5	16.4	-6.9	2	-46.9	-2.8
2.4382	11.5	16.4	-6.9	2	-46.9	-2.8
2.43825	11.4	16.4	-7	2	-47	-2.9
2.4383	11.4	16.4	-7	2	-47	-2.9
2.43835	11.3	16.4	-7.1	2	-47.1	-3
2.4384	11.3	16.4	-7.1	2	-47.1	-3
2.43845	11.3	16.4	-7.1	2	-47.1	-3
2.4385	11.3	16.4	-7.1	2	-47.1	-3
2.43855	11.4	16.4	-7	2	-47	-2.9
2.4386	11.4	16.4	-7	2	-47	-2.9
2.43865	11.4	16.4	-7	2	-47	-2.9
2.4387	11.4	16.4	-7	2	-47	-2.9
2.43875	11.4	16.4	-7	2	-47	-2.9
2.4388	11.3	16.4	-7.1	2	-47.1	-3
2.43885	11.3	16.4	-7.1	2	-47.1	-3
2.4389	11.2	16.4	-7.2	2	-47.2	-3.1
2.4895	11.1	16.4	-7.3	2	-47.3	-3.2
2.439	11.1	16.4	-7.3	2	-47.3	-3.2
2.43905	11	16.4	-7.4	2	-47.4	-3.3
2.4391	11	16.4	-7.4	2	-47.4	-3.3
2.43915	11	16.4	-7.4	2	-47.4	-3.3
2.4392	11	16.4	-7.4	2	-47.4	-3.3
2.43925	11.1	16.4	-7.3	2	-47.3	-3.2
2.4393	11.2	16.4	-7.2	2	-47.2	-3.1
2.43935	11.2	16.4	-7.2	2	-47.2	-3.1
2.4394	11.4	16.4	-7	2	-47	-2.9
2.43945	11.4	16.4	-7	2	-47	-2.9
2.4395	11.2	16.4	-7.2	2	-47.2	-3.1
Processing Gain : 11.4 dB						

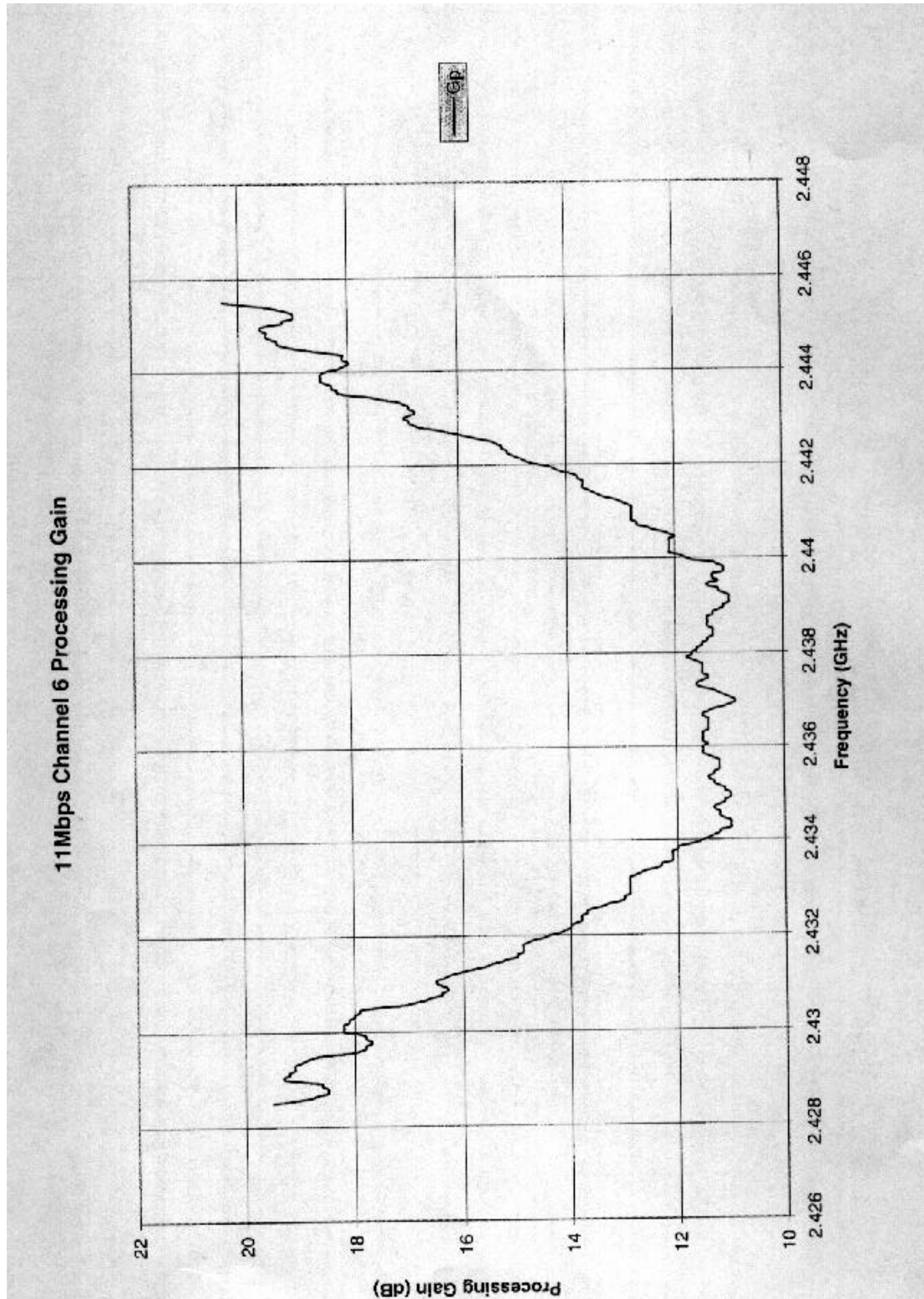



11Mbps CHANNEL 11 Processing Gain						
Gp = (S/N) _o + Mj + Lsys						
Freq. (GHz)	Gp (dB)	(S/N) _o (dB)	Mj = J/S (dB)	Lsys (dB)	Jammer (dBm)	LVL (dBm)
2.4595	11.7	16.4	-6.7	2	-46.7	-4.9
2.45955	11.8	16.4	-6.6	2	-46.6	-4.8
5.4596	11.8	16.4	-6.6	2	-46.6	-4.8
2.45965	11.7	16.4	-6.7	2	-46.7	-4.9
2.4597	11.7	16.4	-6.7	2	-46.7	-4.9
2.45975	11.6	16.4	-6.8	2	-46.8	-5
2.4598	11.5	16.4	-6.9	2	-46.9	-5.1
2.45985	11.4	16.4	-7	2	-47	-5.2
2.4599	11.4	16.4	-7	2	-47	-5.2
2.45995	11.3	16.4	-7.1	2	-47.1	-5.3
2.46	11.3	16.4	-7.1	2	-47.1	-5.3
2.46005	11.3	16.4	-7.1	2	-47.1	-5.3
2.4601	11.4	16.4	-7	2	-47	-5.2
2.46015	11.5	16.4	-6.9	2	-46.9	-5.1
2.4602	11.5	16.4	-6.9	2	-46.9	-5.1
2.46025	11.6	16.4	-6.8	2	-46.8	-5
2.4603	11.6	16.4	-6.8	2	-46.8	-5
2.46035	11.6	16.4	-6.8	2	-46.8	-5
2.4604	11.6	16.4	-6.8	2	-46.8	-5
2.46045	11.5	16.4	-6.9	2	-46.9	-5.1
2.4605	11.5	16.4	-6.9	2	-46.9	-5.1
2.46055	11.4	16.4	-7	2	-47	-5.2
2.4606	11.4	16.4	-7	2	-47	-5.2
2.46065	11.5	16.4	-6.9	2	-46.9	-5.1
2.4607	11.5	16.4	-6.9	2	-46.9	-5.1
2.46075	11.6	16.4	-6.8	2	-46.8	-5
2.4608	11.6	16.4	-6.8	2	-46.8	-5
2.46085	11.8	16.4	-6.6	2	-46.6	-4.8
2.4609	11.9	16.4	-6.5	2	-46.5	-4.7
2.46095	12	16.4	-6.4	2	-46.4	-4.6
2.461	12	16.4	-6.4	2	-46.4	-4.6
2.46105	11.9	16.4	-6.5	2	-46.5	-4.7
2.4611	12	16.4	-6.4	2	-46.4	-4.6
2.46115	12.1	16.4	-6.3	2	-46.3	-4.5



11Mbps CHANNEL 11 Processing Gain						
Gp = (S/N) _o + Mj + Lsys						
Freq. (GHz)	Gp (dB)	(S/N) _o (dB)	Mj = J/S (dB)	Lsys (dB)	Jammer (dBm)	LVL (dBm)
2.4612	12.1	16.4	-6.3	2	-46.3	-4.5
2.46125	12.1	16.4	-6.3	2	-46.3	-4.5
2.4613	12.1	16.4	-6.3	2	-46.3	-4.5
2.46135	12.1	16.4	-6.3	2	-46.3	-4.5
2.4614	12.1	16.4	-6.3	2	-46.3	-4.5
2.46145	12.1	16.4	-6.3	2	-46.3	-4.5
2.4615	12.2	16.4	-6.2	2	-46.2	-4.4
2.46155	12.2	16.4	-6.2	2	-46.2	-4.4
2.4616	12.3	16.4	-6.1	2	-46.1	-4.3
2.46165	12.3	16.4	-6.1	2	-46.1	-4.3
2.4617	12.4	16.4	-6	2	-46	-4.2
2.46175	12.3	16.4	-6.1	2	-46.1	-4.3
2.4618	12.2	16.4	-6.2	2	-46.2	-4.4
2.46185	12.1	16.4	-6.3	2	-46.3	-4.5
2.4619	12	16.4	-6.4	2	-46.4	-4.6
2.46195	12	16.4	-6.4	2	-46.4	-4.6
2.462	11.9	16.4	-6.5	2	-46.5	-4.7
2.46205	12	16.4	-6.4	2	-46.4	-4.6
2.4621	12.1	16.4	-6.3	2	-46.3	-4.5
2.46215	12.2	16.4	-6.2	2	-46.2	-4.4
2.4622	12.3	16.4	-6.1	2	-46.1	-4.3
2.46225	12.4	16.4	-6	2	-46	-4.2
2.4623	12.5	16.4	-5.9	2	-45.9	-4.1
2.46235	12.4	16.4	-6	2	-46	-4.2
2.4624	12.4	16.4	-6	2	-46	-4.2
2.46245	12.3	16.4	-6.1	2	-46.1	-4.3
2.4625	12.3	16.4	-6.1	2	-46.1	-4.3
2.46255	12.3	16.4	-6.1	2	-46.1	-4.3
2.4626	12.3	16.4	-6.1	2	-46.1	-4.3
2.46265	12.3	16.4	-6.1	2	-46.1	-4.3
2.4627	12.2	16.4	-6.2	2	-46.2	-4.4
2.46275	12.3	16.4	-6.1	2	-46.1	-4.3
2.4628	12.3	16.4	-6.1	2	-46.1	-4.3
2.46285	12.3	16.4	-6.1	2	-46.1	-4.3



11Mbps CHANNEL 11 Processing Gain						
Gp = (S/N) _o + Mj + Lsys						
Freq. (GHz)	Gp (dB)	(S/N) _o (dB)	Mj = J/S (dB)	Lsys (dB)	Jammer (dBm)	LVL (dBm)
2.4629	12.2	16.4	-6.2	2	-46.2	-4.4
2.46295	12.2	16.4	-6.2	2	-46.2	-4.4
2.463	12.2	16.4	-6.2	2	-46.2	-4.4
2.46305	12.1	16.4	-6.3	2	-46.3	-4.5
2.4631	12	16.4	-6.4	2	-46.4	-4.6
2.46315	11.9	16.4	-6.5	2	-46.5	-4.7
2.4632	11.9	16.4	-6.5	2	-46.5	-4.7
2.46325	11.8	16.4	-6.6	2	-46.6	-4.8
2.4633	11.8	16.4	-6.6	2	-46.6	-4.8
2.46335	11.7	16.4	-6.7	2	-46.7	-4.9
2.4634	11.8	16.4	-6.6	2	-46.6	-4.8
2.46345	11.8	16.4	-6.6	2	-46.6	-4.8
2.4635	11.9	16.4	-6.5	2	-46.5	-4.7
2.46355	11.9	16.4	-6.5	2	-46.5	-4.7
2.4636	12	16.4	-6.4	2	-46.4	-4.6
2.46365	12	16.4	-6.4	2	-46.4	-4.6
2.4637	12.1	16.4	-6.3	2	-46.3	-4.5
2.46375	12.1	16.4	-6.3	2	-46.3	-4.5
2.4638	12	16.4	-6.4	2	-46.4	-4.6
2.46385	12	16.4	-6.4	2	-46.4	-4.6
2.4639	11.9	16.4	-6.5	2	-46.5	-4.7
2.46395	11.8	16.4	-6.6	2	-46.6	-4.8
2.464	11.8	16.4	-6.6	2	-46.6	-4.8
2.46405	11.8	16.4	-6.6	2	-46.6	-4.8
2.4641	11.8	16.4	-6.6	2	-46.6	-4.8
2.46415	11.8	16.4	-6.6	2	-46.6	-4.8
2.4642	11.9	16.4	-6.5	2	-46.5	-4.7
2.46425	12	16.4	-6.4	2	-46.4	-4.6
2.4643	12.1	16.4	-6.3	2	-46.3	-4.5
2.46435	12.2	16.4	-6.2	2	-46.2	-4.4
4.4644	12.2	16.4	-6.2	2	-46.2	-4.4
2.46445	12.2	16.4	-6.2	2	-46.2	-4.4
2.4645	12.2	16.4	-6.2	2	-46.2	-4.4
Processing Gain : 12 dB						

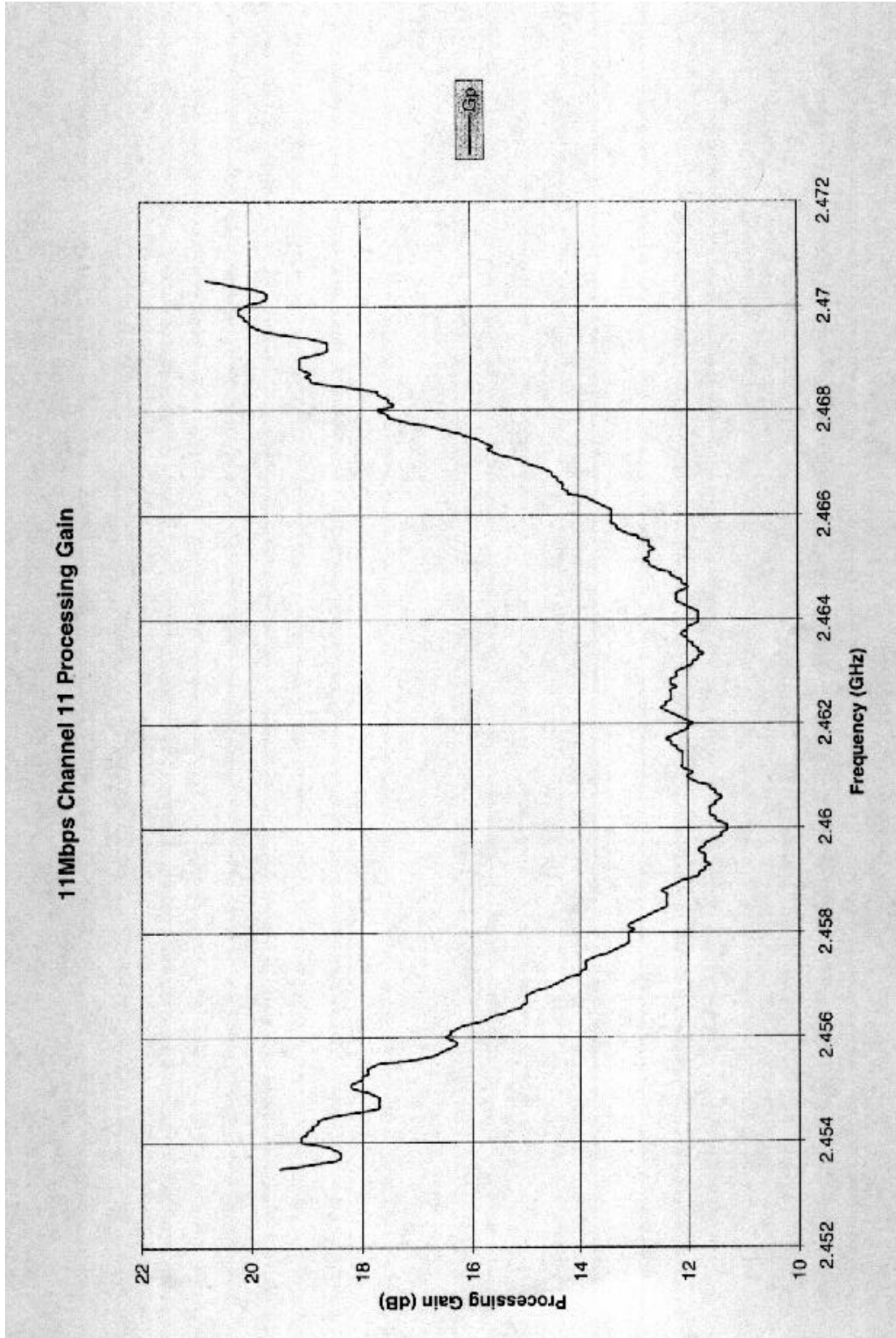



2Mbps CHANNEL 6 Processing Gain						
Gp = (S/N) _o + Mj + Lsys						
Freq. (GHz)	Gp (dB)	(S/N) _o (dB)	Mj = J/S (dB)	Lsys (dB)	Jammer (dBm)	LVL (dBm)
2.4345	12.1	13.3	-3.2	2	-43.2	0.5
2.43455	12.7	13.3	-2.6	2	-42.6	1.1
2.4346	12.9	13.3	-2.4	2	-42.4	1.3
2.43465	13	13.3	-2.3	2	-42.3	1.4
2.4347	13	13.3	-2.3	2	-42.3	1.4
2.43475	12.9	13.3	-2.4	2	-42.4	1.3
2.4348	13.1	13.3	-2.2	2	-42.2	1.5
2.43485	12.4	13.3	-2.9	2	-42.9	0.8
2.4349	12.1	13.3	-3.2	2	-43.2	0.5
2.43495	12.6	13.3	-2.7	2	-42.7	1
2.435	12.6	13.3	-2.7	2	-42.7	1
2.43505	12.5	13.3	-2.8	2	-42.8	0.9
2.4351	12.4	13.3	-2.9	2	-42.9	0.8
2.43515	12.4	13.3	-2.9	2	-42.9	0.8
2.4352	12.2	13.3	-3.1	2	-43.1	0.6
2.43525	12.2	13.3	-3.1	2	-43.7	0.6
2.4353	12.3	13.3	-3	2	-43	0.7
2.43535	11.9	13.3	-3.4	2	-43.4	0.3
2.4354	11.5	13.3	-3.8	2	-43.8	-0.1
2.43545	12.1	13.3	-3.2	2	-43.2	0.5
2.4355	11.5	13.3	-3.8	2	-43.8	-0.1
2.43555	12.4	13.3	-2.9	2	-42.9	0.8
2.4356	12.7	13.3	-2.6	2	-42.6	1.1
2.43565	12.9	13.3	-2.4	2	-42.4	1.3
2.4357	12.8	13.3	-2.5	2	-42.5	1.2
5.43575	12.8	13.3	-2.5	2	-42.5	1.2
2.4358	12.9	13.3	-2.4	2	-42.4	1.3
2.43585	12.1	13.3	-3.2	2	-43.2	0.5
2.4359	11.7	13.3	-3.6	2	-43.6	0.1
2.43595	12.4	13.3	-2.9	2	-42.9	0.8
2.436	12.5	13.3	-2.8	2	-42.8	0.9
2.43605	12.5	13.3	-2.8	2	-42.8	0.9
2.4361	12.4	13.3	-2.9	2	-42.9	0.8
2.43615	12.4	13.3	-2.9	2	-42.9	0.8



2Mbps CHANNEL 6 Processing Gain						
Gp = (S/N) _o + Mj + Lsys						
Freq. (GHz)	Gp (dB)	(S/N) _o (dB)	Mj = J/S (dB)	Lsys (dB)	Jammer (dBm)	LVL (dBm)
2.4362	12.1	13.3	-3.2	2	-43.2	0.5
2.43625	12.1	13.3	-3.2	2	-43.2	0.5
2.4363	12.1	13.3	-3.2	2	-43.2	0.5
2.43635	11.5	13.3	-3.8	2	-43.8	-0.1
2.4364	11.1	13.3	-4.2	2	-44.2	-0.5
2.43645	11.7	13.3	-3.6	2	-43.6	0.1
2.4365	11.2	13.3	-4.1	2	-44.1	-0.4
2.43655	12.6	13.3	-2.7	2	-42.7	1
2.4366	13.1	13.3	-2.2	2	-42.2	1.5
2.43665	13.7	13.3	-1.6	2	-41.6	2.1
2.4367	14.1	13.3	-1.2	2	-41.2	2.5
2.43675	15.1	13.3	-0.2	2	-40.2	3.5
2.4368	15.7	13.3	0.4	2	-39.6	4.1
2.43685	16.2	13.3	0.9	2	-39.1	4.6
2.4369	16.1	13.3	0.8	2	-39.2	4.5
2.43695	16.3	13.3	1	2	-39	4.7
2.437	16.6	13.3	1.3	2	-38.7	5
2.43705	16.3	13.3	1	2	-39	4.7
2.4371	16.3	13.3	1	2	-39	4.7
2.43715	16	13.3	0.7	2	-39.3	4.4
2.4372	15.5	13.3	0.2	2	-39.8	3.9
2.43725	14.8	13.3	-0.5	2	-40.5	3.2
2.4373	14	13.3	-1.3	2	-41.3	2.4
2.43735	13.5	13.3	-1.8	2	-41.8	1.9
2.4374	12.7	13.3	-2.6	2	-42.6	1.1
2.43745	12.6	13.3	-2.7	2	-42.7	1
2.4375	11.6	13.3	-3.7	2	-43.7	0
2.43755	12.1	13.3	-3.2	2	-43.2	0.5
2.4376	12.1	13.3	-3.2	2	-43.2	0.5
2.43765	12.1	13.3	-3.2	2	-43.2	0.5
2.4377	12	13.3	-3.3	2	-43.3	0.4
2.43775	11.7	13.3	-3.6	2	-43.6	0.1
2.4378	12	13.3	-3.3	2	43.3	0.4
2.43785	11.1	13.3	-4.2	2	-44.2	-0.5



2Mbps CHANNEL 6 Processing Gain						
Gp = (S/N) _o + Mj + Lsys						
Freq. (GHz)	Gp (dB)	(S/N) _o (dB)	Mj = J/S (dB)	Lsys (dB)	Jammer (dBm)	LVL (dBm)
2.4379	11.2	13.3	-4.1	2	-44.1	-0.4
2.43795	12.1	13.3	-3.2	2	-43.2	0.5
2.438	12.5	13.3	-2.8	2	-42.8	0.9
2.43805	12.7	13.3	-2.6	2	-42.6	1.1
2.4381	12.8	13.3	-2.5	2	-42.5	1.2
2.43815	12.9	13.3	-2.4	2	-42.4	1.3
2.4382	12.9	13.3	-2.4	2	-42.4	1.3
2.43825	12.9	13.3	-2.4	2	-42.4	1.3
2.4383	12.8	13.3	-2.5	2	-42.5	1.2
2.43835	12.6	13.3	-2.7	2	-42.7	1
2.4384	12	13.3	-3.3	2	-43.3	0.4
2.43845	12.4	13.3	-2.9	2	-42.9	0.8
2.4385	11.7	13.3	-3.6	2	-43.6	0.1
2.43855	12.3	13.3	-3	2	-43	0.7
2.4386	12.3	13.3	-3	2	-43	0.7
2.43865	12.3	13.3	-3	2	-43	0.7
2.4387	12.2	13.3	-3.1	2	-43.1	0.6
2.43875	12	13.3	-3.3	2	-43.3	0.4
2.4388	12.3	13.3	-3	2	-43	0.7
2.43885	11.6	13.3	-3.7	2	-43.7	0
2.4389	11.6	13.3	-3.7	2	-43.7	0
2.43895	12.4	13.3	-2.9	2	-42.9	0.8
2.439	12.7	13.3	-2.6	2	-42.6	1.1
2.43905	12.7	13.3	-2.6	2	-42.6	1.1
2.4391	12.8	13.3	-2.5	2	-42.5	1.2
2.43915	12.9	13.3	-2.4	2	-42.4	1.3
2.4392	12.8	13.3	-2.5	2	-42.5	1.2
2.43925	12.9	13.3	-2.4	2	-42.4	1.3
2.4393	12.8	13.3	-2.5	2	-42.5	1.2
2.43935	12.6	13.3	-2.7	2	-42.7	1
2.4394	12.3	13.3	-3	2	-43	0.7
2.43945	12.5	13.3	-2.8	2	-42.8	0.9
2.4395	12	13.3	-3.3	2	-43.3	0.4
Processing Gain : 12.5 dB						

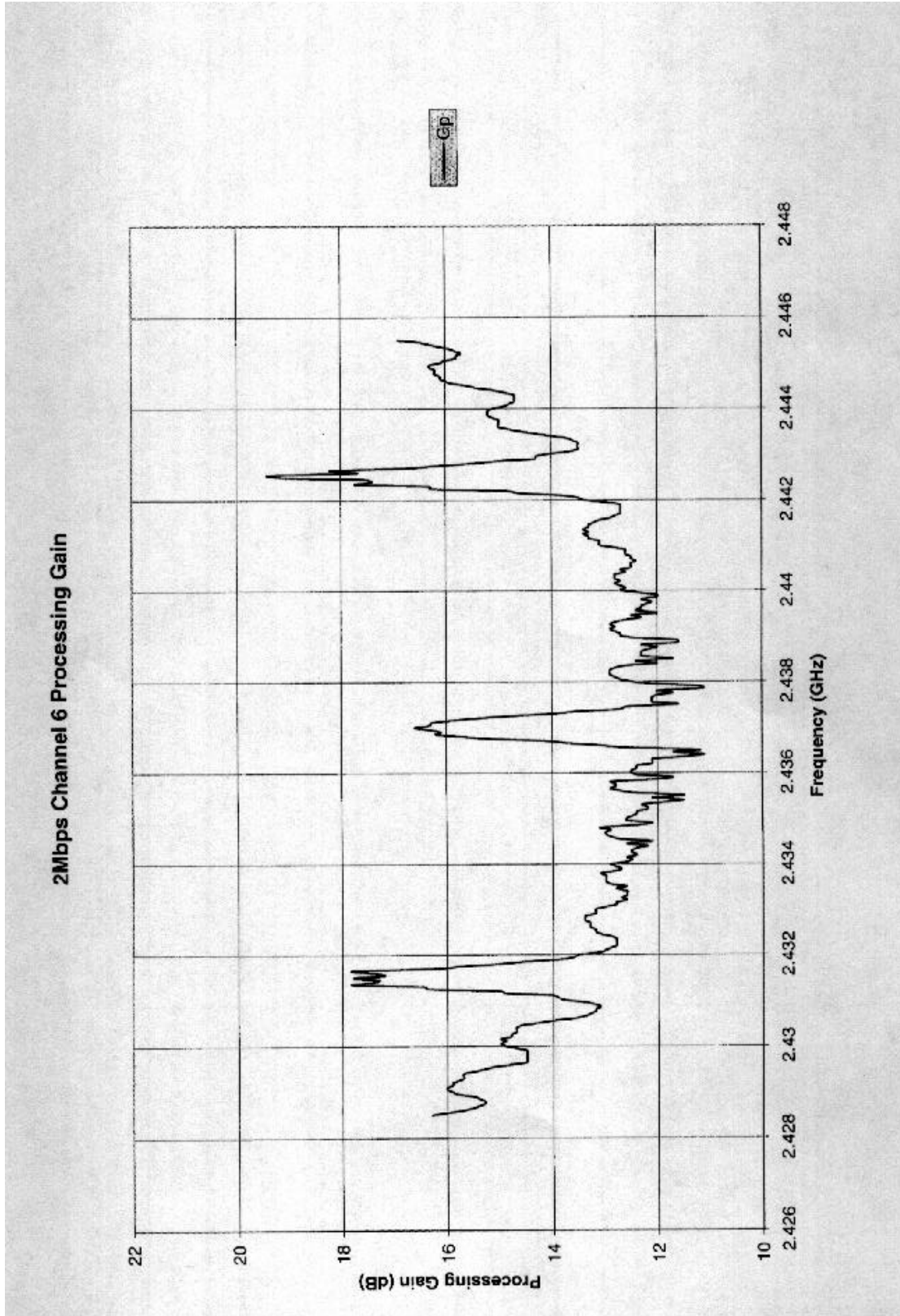



7 ANTENNA REQUIREMENT

7.1 Standard Applicable

For intentional device, according to § 15.203, an intentional radiator shall be designed to ensure that no antenna other than that furnished by the responsible party shall be used with the device.

And according to § 15.247 (b), if transmitting antennas of directional gain greater than 6 dBi are used, the power shall be reduced by the amount in dB that the directional gain of the antenna exceeds 6 dBi.

7.2 Antenna Connected Construction

The antenna used in this product is diversity monopole antenna. No antenna connector is provided in this product. And the maximum Gain of this antenna is only 1.0 dBi.

8 EUT PHOTOS



photo1



photo2



photo3

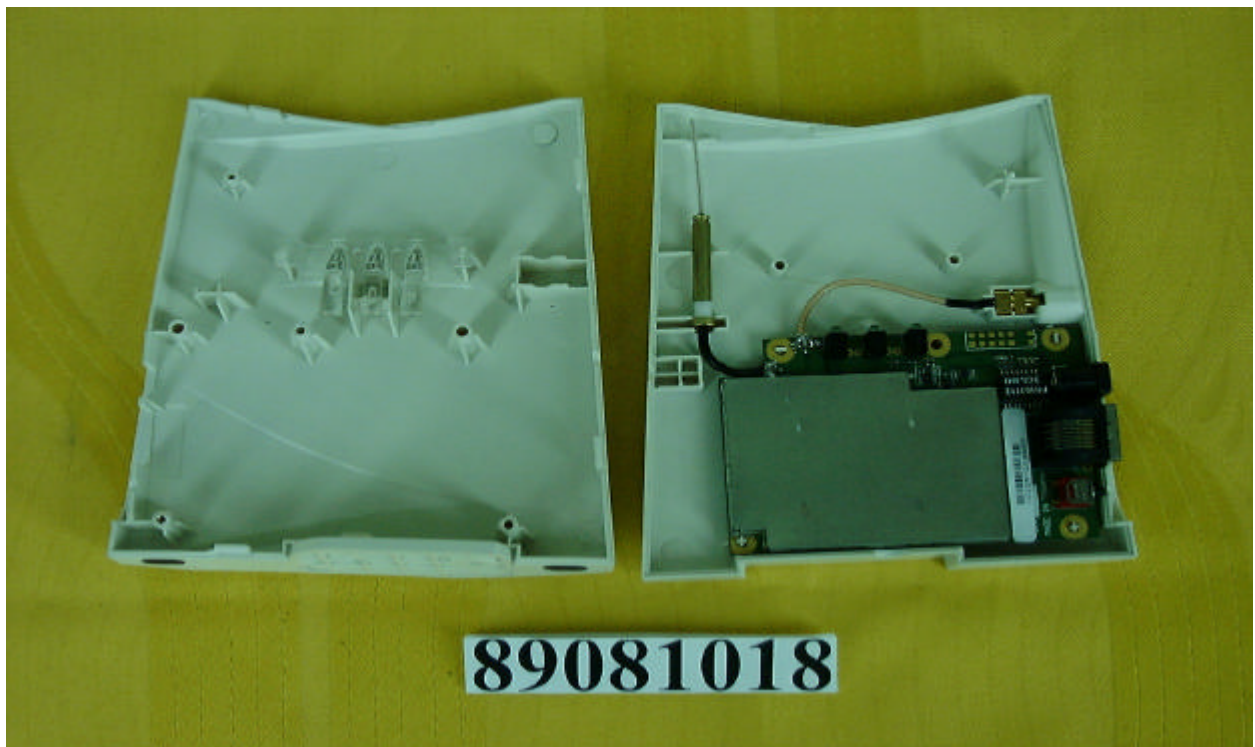

photo4



photo5

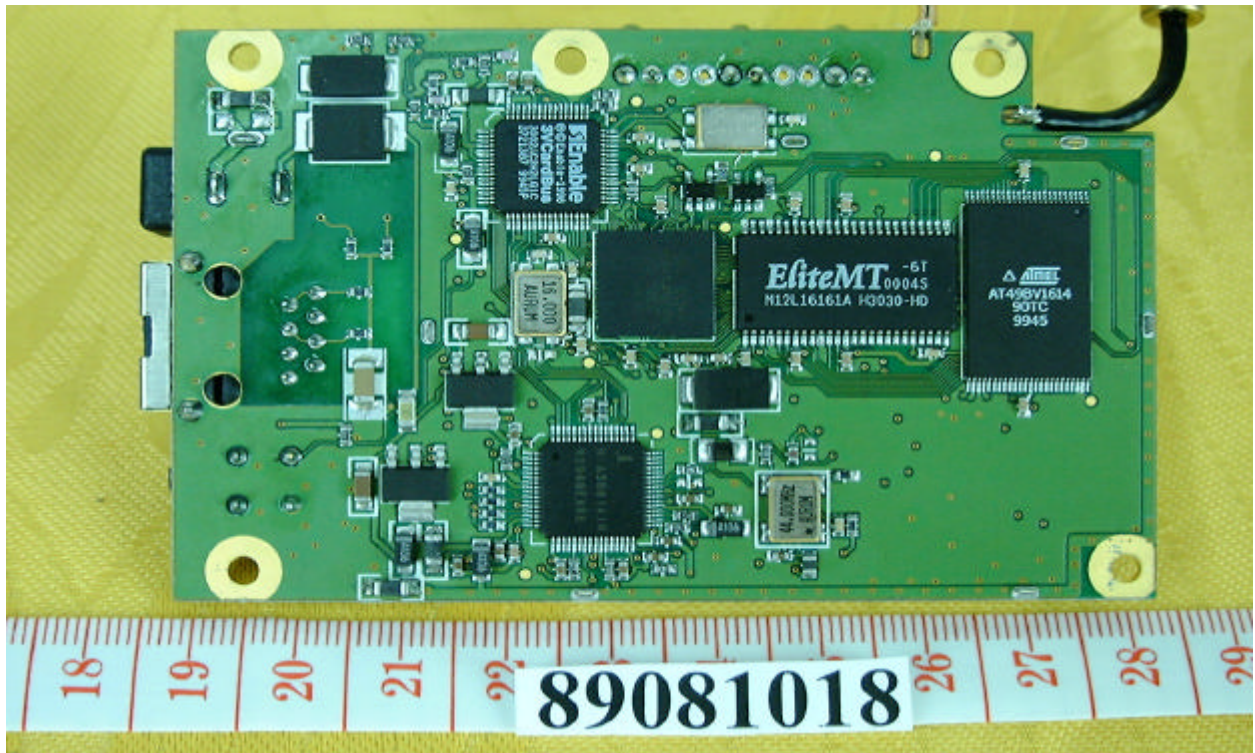

photo6

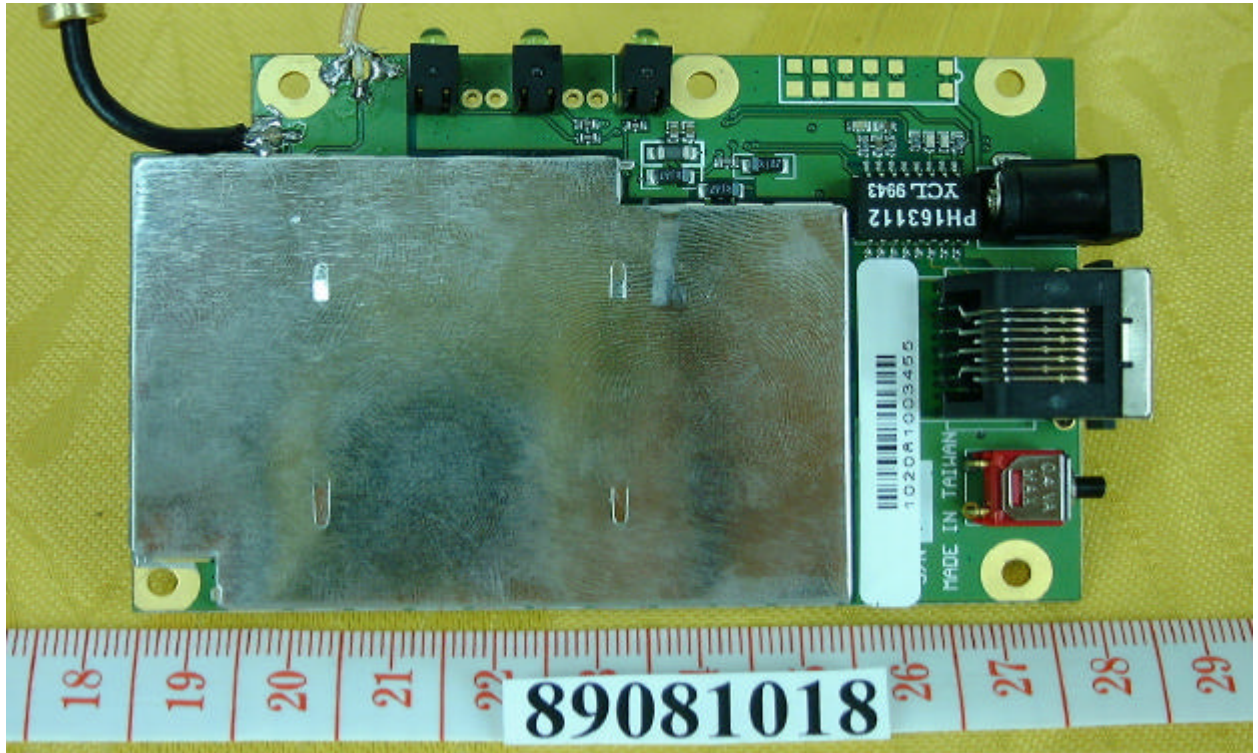

photo7

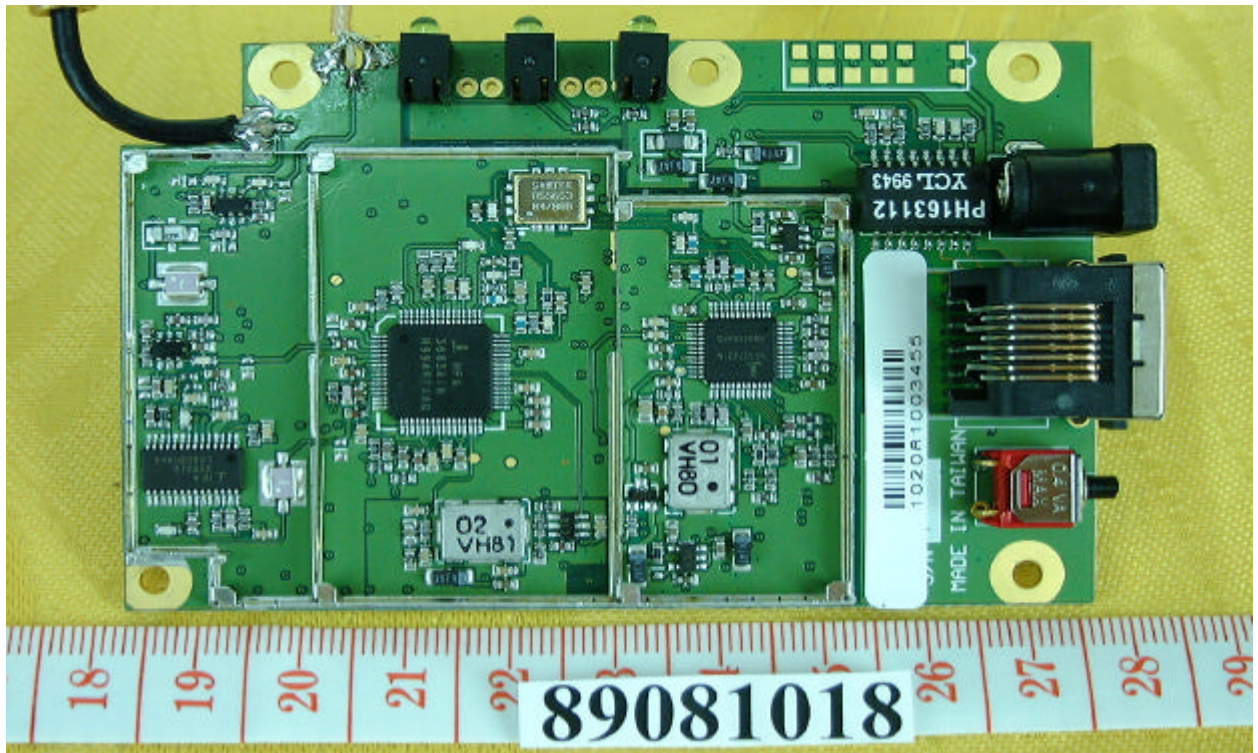

photo8



photo9



photo10



photo11



photo12