



A D T

FCC TEST REPORT

(Part 90 Subpart Z)

REPORT NO.: RF990913C11

MODEL NO.: WIXS-177 (refer to item 3.1 for more details)

FCC ID: MXFWIXS-177

RECEIVED: Sep. 13, 2010

TESTED: Sep. 01 ~ Sep. 28, 2010

ISSUED: Oct. 01, 2010

APPLICANT: Gemtek Technology Co., Ltd.

ADDRESS: No.15-1, Zhonghua Rd, Hsinchu Industrial Park ,
Hsinchu County, Taiwan,R.O.C.303

ISSUED BY: Bureau Veritas Consumer Products Services (H.K.)
Ltd., Taoyuan Branch

LAB ADDRESS: No. 47, 14th Ling, Chia Pau Tsuen, Lin Kou Hsiang,
Taipei Hsien 244, Taiwan, R.O.C.

TEST LOCATION: No. 19, Hwa Ya 2nd Rd, Wen Hwa Tsuen, Kwei
Shan Hsiang, Taoyuan Hsien 333, Taiwan, R.O.C.

This test report consists of 83 pages in total. It may be duplicated completely for legal use with the approval of the applicant. It should not be reproduced except in full, without the written approval of our laboratory. The client should not use it to claim product certification, approval, or endorsement by TAF or any government agency. The test results in the report only apply to the tested sample.





TABLE OF CONTENTS

1	CERTIFICATION	4
2	SUMMARY OF TEST RESULTS	5
2.1	MEASUREMENT UNCERTAINTY	5
3	GENERAL INFORMATION	6
3.1	GENERAL DESCRIPTION OF EUT	6
3.2	DESCRIPTION OF TEST MODES	8
3.2.1	CONFIGURATION OF SYSTEM UNDER TEST	8
3.2.2	TEST MODE APPLICABILITY AND TESTED CHANNEL DETAIL	9
3.3	GENERAL DESCRIPTION OF APPLIED STANDARDS	12
3.4	DESCRIPTION OF SUPPORT UNITS	12
4	TEST TYPES AND RESULTS	13
4.1	OUTPUT POWER AND POWER DENSITY MEASUREMENT	13
4.1.1	LIMITS OF OUTPUT POWER AND POWER DENSITY	13
4.1.2	TEST INSTRUMENTS	13
4.1.3	TEST PROCEDURES	14
4.1.4	TEST SETUP	15
4.1.5	EUT OPERATING CONDITIONS	15
4.1.6	TEST RESULTS	16
4.2	FREQUENCY STABILITY MEASUREMENT	28
4.2.1	LIMITS OF FREQUENCY STABILITY MEASUREMENT	28
4.2.2	TEST INSTRUMENTS	28
4.2.3	TEST PROCEDURE	29
4.2.4	TEST SETUP	29
4.2.5	EUT OPERATING CONDITIONS	29
4.2.6	TEST RESULTS	30
4.3	EMISSION BANDWIDTH MEASUREMENT	33
4.3.1	LIMITS OF EMISSION BANDWIDTH MEASUREMENT	33
4.3.2	TEST INSTRUMENTS	33
4.3.3	TEST PROCEDURE	33
4.3.4	TEST SETUP	33
4.3.5	EUT OPERATING CONDITIONS	33
4.3.6	TEST RESULTS	34
4.4	EMISSION MASKS	46
4.4.1	LIMITS OF EMISSION MASKS	46
4.4.2	TEST INSTRUMENTS	46
4.4.3	TEST SETUP	46
4.4.4	TEST PROCEDURES	47
4.4.5	EUT OPERATING CONDITION	47
4.4.6	TEST RESULTS	48
4.5	CONDUCTED SPURIOUS EMISSIONS	57
4.5.1	LIMITS OF CONDUCTED SPURIOUS EMISSIONS MEASUREMENT	57
4.5.2	TEST INSTRUMENTS	57
4.5.3	TEST PROCEDURE	58



A D T

4.5.4	TEST SETUP	58
4.5.5	EUT OPERATING CONDITIONS.....	58
4.5.6	TEST RESULTS	59
4.6	RADIATED EMISSION MEASUREMENT (BELOW 1GHz)	68
4.6.1	LIMITS OF RADIATED EMISSION MEASUREMENT	68
4.6.2	TEST INSTRUMENTS	69
4.6.3	TEST PROCEDURES	70
4.6.4	DEVIATION FROM TEST STANDARD	70
4.6.5	TEST SETUP	71
4.6.6	EUT OPERATING CONDITIONS.....	71
4.6.7	TEST RESULTS	72
4.7	RADIATED EMISSION MEASUREMENT (ABOVE 1GHz)	78
4.7.1	LIMITS OF RADIATED EMISSION MEASUREMENT	78
4.7.2	TEST INSTRUMENTS	78
4.7.3	TEST PROCEDURES	78
4.7.4	DEVIATION FROM TEST STANDARD	78
4.7.5	TEST SETUP	78
4.7.6	EUT OPERATING CONDITIONS.....	78
4.7.7	TEST RESULTS	79
5	PHOTOGRAPHS OF THE TEST CONFIGURATION	82
6	INFORMATION ON THE TESTING LABORATORIES	83



A D T

1 CERTIFICATION

PRODUCT: WiMAX Outdoor CPE (refer to item 3.1 for more details)

MODEL: WIXS-177 (refer to item 3.1 for more details)

BRAND: Gemtek (refer to item 3.1 for more details)

APPLICANT: Gemtek Technology Co., Ltd.

TESTED: Sep. 01 ~ Sep. 28, 2010

TEST SAMPLE: ENGINEERING SAMPLE

TEST STANDARDS: FCC Part 90, Subpart Z

The above equipment (Model no.: WIXS-177) has been tested by **Bureau Veritas Consumer Products Services (H.K.) Ltd., Taoyuan Branch**, and found compliance with the requirement of the above standards. The test record, data evaluation & Equipment Under Test (EUT) configurations represented herein are true and accurate accounts of the measurements of the sample's EMC characteristics under the conditions specified in this report.

PREPARED BY :  , **DATE:** Oct. 01, 2010
Rennie Wang / Supervisor

TECHNICAL ACCEPTANCE :  , **DATE:** Oct. 01, 2010
Responsible for RF Long Chen / Senior Engineer

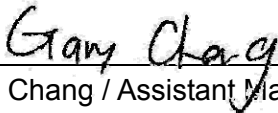
APPROVED BY :  , **DATE:** Oct. 01, 2010
Gary Chang / Assistant Manager



A D T

2 SUMMARY OF TEST RESULTS

The EUT has been tested according to the following specifications:

STANDARD SECTION	TEST TYPE AND LIMIT	RESULT	REMARK
FCC Part 2& Part 90			
2.1046 90.1321	Maximum Peak Output Power Limit: max. 25Watt / 25MHz EIRP.	PASS	Meet the requirement of limit.
2.1055 90.213	Frequency Stability Stay with the authorized bands of operation	PASS	Meet the requirement of limit.
2.1049 90.1323	Emission Bandwidth	PASS	Meet the requirement of limit.
90.210	Emission masks	PASS	Meet the requirement of limit.
2.1051 90.1323	Conducted Spurious Emissions	PASS	Meet the requirement of limit.
2.1053 90.1323	Radiated Spurious Emissions	PASS	Meet the requirement of limit. Minimum passing margin is -13.3dB at 41.66MHz.

2.1 MEASUREMENT UNCERTAINTY

Where relevant, the following measurement uncertainty levels have been estimated for tests performed on the EUT as specified in CISPR 16-4-2:

MEASUREMENT	FREQUENCY	UNCERTAINTY
Conducted emissions	150kHz~30MHz	2.44 dB
Radiated emissions	30MHz ~ 200MHz	2.93 dB
	200MHz ~1000MHz	2.95 dB
	1GHz ~ 18GHz	2.26 dB
	18GHz ~ 40GHz	1.94 dB

This uncertainty represents an expanded uncertainty expressed at approximately the 95% confidence level using a coverage factor of $k = 2$.



A D T

3 GENERAL INFORMATION

3.1 GENERAL DESCRIPTION OF EUT

PRODUCT	WiMAX Outdoor CPE (refer to NOTE for more details)	
MODEL NO.	WIXS-177 (refer to NOTE for more details)	
FCC ID	MXFWIXS-177	
POWER SUPPLY	48Vdc	
CODED TYPE/MODULATION/ CODING RATE	UL	QPSK: 1/2, 3/4
		16QAM: 1/2, 3/4
	DL	BPSK: 1/2
		QPSK: 1/2, 3/4
		16QAM: 1/2, 3/4
		64QAM: 1/2, 2/3, 3/4, 5/6
MODULATION TECHNOLOGY	OFDMA	
DUPLEX METHOD	TDD	
MULTIPLE ACCESS METHOD	TDMA	
OPERATING FREQUENCY	3652.5MHz ~ 3672.5MHz	
CHANNEL BANDWIDTH	5.0MHz, 7.0MHz, 10.0MHz	
MAX. E.I.R.P. POWER	37.55dBm	
ANTENNA TYPE	Patched antenna with 15dBi gain	
ANTENNA CONNECTOR	N-Female	
OPERATION TEMPERATURE RANGE	-40°C ~ 70°C	
DATA CABLE	1.7m shielded RJ45 cable without core	
I/O PORTS	Refer to user's manual	
ACCESSORY DEVICES	POE	

NOTE:

1. All models are electrically identical, different model names are for marketing purpose.

BRAND	MODEL	PRODUCT
Gemtek	WIXS-177	WiMAX Outdoor CPE
Alvarion	4M-CPE3000-PRO-1D-3.6	802.16e Wave 2 Outdoor CPE

2. The EUT consumes power from the following PoEs.

BRAND	PowerDsine™ 3001
MODEL	PD-3001/AC
INPUT POWER	100-250Vac, 0.5A, 50/60Hz
OUTPUT POWER	48Vdc, 0.35A
POWER LINE	1.8 m non-shielded cable without core



A D T

BRAND	PHIHONG
MODEL	POE16U-480
INPUT POWER	100-240Vac, 0.4A, 50/60Hz
OUTPUT POWER	48Vdc, 0.32A
POWER LINE	1.8 m non-shielded cable without core

3. The above EUT information was declared by the manufacturer and for more detailed features description, please refer to the manufacturer's specifications or User's Manual.

3.2 DESCRIPTION OF TEST MODES

Three channels of each channel bandwidth had been tested.

CHANNEL (MHz)	CHANNEL BANDWIDTH		
	5.0 MHz	7.0 MHz	10.0 MHz
LOW	3652.50	3653.50	3655.00
MIDDLE	3662.50	3662.50	3662.50
HIGH	3672.50	3671.50	3670.00

3.2.1 CONFIGURATION OF SYSTEM UNDER TEST

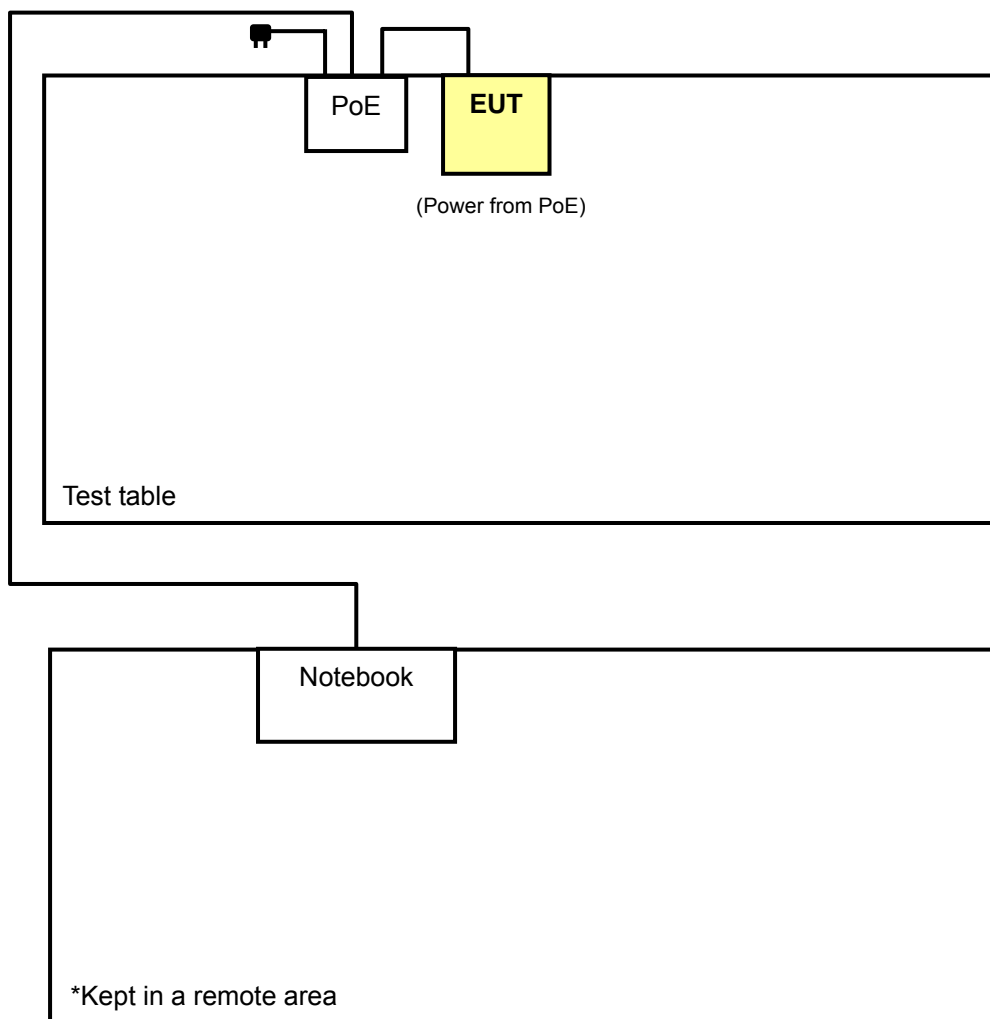

3.2.2 TEST MODE APPLICABILITY AND TESTED CHANNEL DETAIL

EUT CONFIGURE MODE	APPLICABLE TO							DESCRIPTION
	OP	FS	EB	EM	CSE	RE<1G	RE≥1G	
A	√	√	√	√	√	√	√	For POE model: PD-3001/AC
B	-	-	-	-	-	√	-	For POE model: POE16U-480

Where **OP**: Output power **FS**: Frequency stability
EB: Emission bandwidth **EM**: Emission masks
CSE: Conducted spurious emissions **RE<1G**: Radiated emission below 1GHz
RE≥1G: Radiated emission above 1GHz

NOTE: “-“ means no effect.

Worst case DL:UL 26:21 was used during all tests.

OUTPUT POWER MEASUREMENT:

- Pre-Scan has been conducted to determine the worst-case mode from all possible combinations between available modulations, coding rate and antenna ports (if EUT with antenna diversity architecture).
- Following channel(s) was (were) selected for the final test as listed below.

EUT CONFIGURE MODE	TESTED CHANNEL	MODULATION TECHNOLOGY	CHANNEL BANDWIDTH	MODULATION TYPE	CODING RATE
A	L, M, H	OFDMA	5.0MHz	QPSK	1/2
A	L, M, H	OFDMA	7.0MHz	QPSK	1/2
A	L, M, H	OFDMA	10.0MHz	QPSK	1/2

FREQUENCY STABILITY MEASUREMENT:

- Pre-Scan has been conducted to determine the worst-case mode from all possible combinations between available modulations, coding rate, and antenna ports (if EUT with antenna diversity architecture).
- Following channel(s) was (were) selected for the final test as listed below.

EUT CONFIGURE MODE	TESTED CHANNEL	MODULATION TECHNOLOGY	CHANNEL BANDWIDTH	MODULATION TYPE	CODING RATE
A	L	OFDMA	5.0MHz	QPSK	1/2
A	L	OFDMA	7.0MHz	QPSK	1/2
A	L	OFDMA	10.0MHz	QPSK	1/2



A D T

EMISSION BANDWIDTH MEASUREMENT:

- Pre-Scan has been conducted to determine the worst-case mode from all possible combinations between available modulations, coding rate, and antenna ports (if EUT with antenna diversity architecture).
- Following channel(s) was (were) selected for the final test as listed below.

EUT CONFIGURE MODE	TESTED CHANNEL	MODULATION TECHNOLOGY	CHANNEL BANDWIDTH	MODULATION TYPE	CODING RATE
A	L, M, H	OFDMA	5.0MHz	QPSK	1/2
A	L, M, H	OFDMA	7.0MHz	QPSK	1/2
A	L, M, H	OFDMA	10.0MHz	QPSK	1/2

EMISSION MASKS MEASUREMENT:

- Pre-Scan has been conducted to determine the worst-case mode from all possible combinations between available modulations, coding rate, and antenna ports (if EUT with antenna diversity architecture).
- Following channel(s) was (were) selected for the final test as listed below.

EUT CONFIGURE MODE	TESTED CHANNEL	MODULATION TECHNOLOGY	CHANNEL BANDWIDTH	MODULATION TYPE	CODING RATE
A	L, M, H	OFDMA	5.0MHz	QPSK	1/2
A	L, M, H	OFDMA	7.0MHz	QPSK	1/2
A	L, M, H	OFDMA	10.0MHz	QPSK	1/2

CONDUCTED SPURIOUS EMISSIONS MEASUREMENT:

- Pre-Scan has been conducted to determine the worst-case mode from all possible combinations between available modulations, coding rate, and antenna ports (if EUT with antenna diversity architecture).
- Following channel(s) was (were) selected for the final test as listed below.

EUT CONFIGURE MODE	TESTED CHANNEL	MODULATION TECHNOLOGY	CHANNEL BANDWIDTH	MODULATION TYPE	CODING RATE
A	L, M, H	OFDMA	5.0MHz	QPSK	1/2
A	L, M, H	OFDMA	7.0MHz	QPSK	1/2
A	L, M, H	OFDMA	10.0MHz	QPSK	1/2



A D T

RADIATED EMISSION MEASUREMENT (BELOW 1 GHz):

- Pre-Scan has been conducted to determine the worst-case mode from all possible combinations between available modulations, coding rate and antenna ports (if EUT with antenna diversity architecture).
- Following channel(s) was (were) selected for the final test as listed below.

EUT CONFIGURE MODE	TESTED CHANNEL	MODULATION TECHNOLOGY	CHANNEL BANDWIDTH	MODULATION TYPE	CODING RATE
A, B	L	OFDMA	5.0MHz	QPSK	1/2
A, B	L	OFDMA	7.0MHz	QPSK	1/2
A, B	L	OFDMA	10.0MHz	QPSK	1/2

RADIATED EMISSION MEASUREMENT (ABOVE 1 GHz):

- Pre-Scan has been conducted to determine the worst-case mode from all possible combinations between available modulations, coding rate and antenna ports (if EUT with antenna diversity architecture).
- Following channel(s) was (were) selected for the final test as listed below.

EUT CONFIGURE MODE	TESTED CHANNEL	MODULATION TECHNOLOGY	CHANNEL BANDWIDTH	MODULATION TYPE	CODING RATE
A	L, M, H	OFDMA	5.0MHz	QPSK	1/2
A	L, M, H	OFDMA	7.0MHz	QPSK	1/2
A	L, M, H	OFDMA	10.0MHz	QPSK	1/2

TEST CONDITION:

APPLICABLE TO	ENVIRONMENTAL CONDITIONS	INPUT POWER (SYSTEM)	TESTED BY
OP	25deg. C, 66%RH, 1011 hPa	120Vac, 60Hz	Brad Wu
FS	25deg. C, 66%RH, 1011 hPa	120Vac, 60Hz	Brad Wu
EB	25deg. C, 66%RH, 1011 hPa	120Vac, 60Hz	Brad Wu
EM	25deg. C, 66%RH, 1011 hPa	120Vac, 60Hz	Brad Wu
CSE	25deg. C, 66%RH, 1011 hPa	120Vac, 60Hz	Brad Wu
RE < 1G	25deg. C, 65%RH, 1010 hPa	120Vac, 60Hz	Match Tsui
RE ≥ 1G	25deg. C, 65%RH, 1010 hPa	120Vac, 60Hz	Match Tsui

3.3 GENERAL DESCRIPTION OF APPLIED STANDARDS

The EUT is a RF product. According to the specifications of the manufacturer, it must comply with the requirements of the following standards:

FCC 47 CFR Part 2

FCC 47 CFR Part 90

965270 D01 Pwr Meas Part 90 Z Equipment v01

ANSI/TIA/EIA-603-C-2004

All test items have been performed and recorded as per the above standards.

NOTE: The EUT is also considered as a kind of computer peripheral, because the connection to computer is necessary for typical use. It has been verified to comply with the requirements of FCC Part 15, Subpart B, Class B (DoC). The test report has been issued separately.

3.4 DESCRIPTION OF SUPPORT UNITS

The EUT has been tested as an independent unit together with other necessary accessories or support units. The following support units or accessories were used to form a representative test configuration during the tests.

NO.	PRODUCT	BRAND	MODEL NO.	SERIAL NO.	FCC ID
1	NOTEBOOK COMPUTER	DELL	PP05L	12130898320	E2K24CLNS

NO.	SIGNAL CABLE DESCRIPTION OF THE ABOVE SUPPORT UNITS
1	NA

NOTE: All power cords of the above support units are non shielded (1.8m).

4 TEST TYPES AND RESULTS

4.1 OUTPUT POWER AND POWER DENSITY MEASUREMENT

4.1.1 LIMITS OF OUTPUT POWER AND POWER DENSITY

PER FCC PART 90.1321

BASE AND FIXED STATIONS

Base and fixed stations are limited to 25 Watts/25 MHz equivalent isotropical radiated power (EIRP). In any event, the peak EIRP power density shall not exceed 1 Watt in any one-megahertz slice of spectrum.

MOBILE AND PORTABLE STATIONS

Mobile and portable stations are limited to 1 Watt/25 MHz EIRP. In any event, the peak EIRP density shall not exceed 40 milliWatts in any one-megahertz slice of spectrum.

4.1.2 TEST INSTRUMENTS

DESCRIPTION & MANUFACTURER	MODEL NO.	SERIAL NO.	DATE OF CALIBRATION	DUE DATE OF CALIBRATION
Spectrum Analyzer Agilent	E4446A	MY44360128	Feb. 23, 2010	Feb. 22, 2011
RF cable	SUCOFLEX 104	257029	Aug. 27, 2010	Aug. 26, 2011
DC-6GHz 20dB 50W Fixed attenuator Woken	MDC9331N-20	0724	May 15, 2010	May 14, 2011

NOTE: The calibration interval of the above test instruments is 12 months and the calibrations are traceable to NML/ROC and NIST/USA.



4.1.3 TEST PROCEDURES

OUTPUT POWER

1. Connect the DUT transmitter output to the spectrum analyzer via coaxial cable while ensuring proper impedance matching.
2. Tune the analyzer to the nominal center frequency of the emission bandwidth (EBW).
3. Set the span to twice the nominal EBW (span = 2 x EBW).
4. Set the resolution bandwidth (RBW) to approximately 1% of EBW.
5. Set the video bandwidth (VBW) to 3 x RBW.
6. Select the average power (RMS) display detector.
7. Set the number of measurement points to ≥ 1001 .
8. Use auto-coupled sweep time.
9. Perform measurement over an interval of time when the transmission is continuous and at its maximum power level.
10. Utilize trace averaging over 100 traces in the power averaging mode.
11. Use the Band/Channel Power function to determine the integrated power over the full EBW.
12. Record the band power level.
13. Adjust the recorded level by applying appropriate correction factors for the measurement set-up.
14. Determine the EIRP by adding the effective antenna gain to the adjusted power level.

POWER DENSITY

1. Connect the transmitter to the spectrum analyzer via coaxial cable while ensuring proper impedance matching.
2. Tune the analyzer to the nominal center frequency of the emission bandwidth (EBW).
3. Set the span to twice the nominal EBW (span = 2 x EBW).
4. Set the resolution bandwidth (RBW) to 1 MHz.
5. Set the video bandwidth (VBW) to 3MHz.
6. Select the average power (RMS) display detector.
7. Set the number of measurement points to ≥ 1001 .
8. Use auto-coupled sweep time.
9. Perform the measurement over an interval of time when the transmission is continuous and at its maximum power level.
10. Utilize trace averaging over 100 traces in the power averaging mode.
11. Find the maximum trace amplitude (peak search) and record.
12. Adjust the recorded level by applying appropriate correction factors for the measurement set-up.
13. Determine the EIRP by adding the effective antenna gain to the adjusted power level.

4.1.4 TEST SETUP

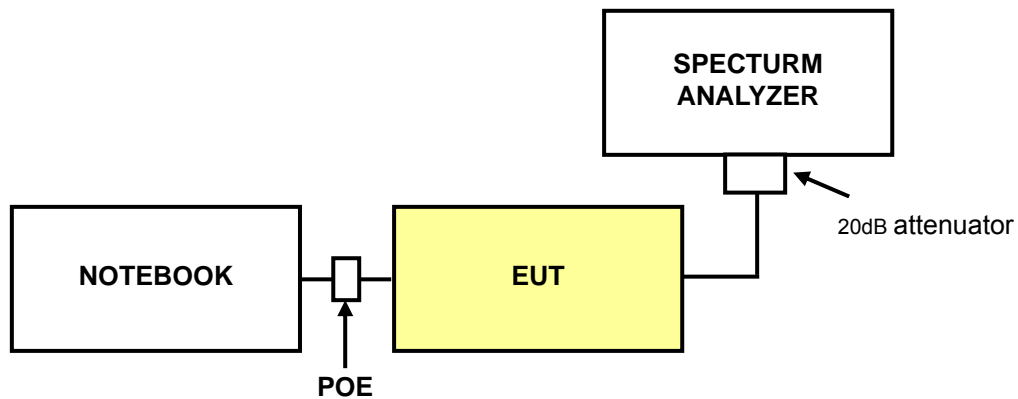

4.1.5 EUT OPERATING CONDITIONS

- a. Placed the EUT on the testing table.
- b. Prepared one notebook system outside of testing area to act as a communication partner.
- c. The communication partner connected with EUT via a RJ45 UTP cable and run a test program (provided by manufacturer) to enable EUT under transmission condition continuously at specific channel frequency.



A D T

4.1.6 TEST RESULTS

DETECTOR FUNCTION	Average	CHANNEL BANDWIDTH	5.0MHz
--------------------------	---------	--------------------------	--------

EIRP POWER						
CHANNEL	FREQUENCY (MHz)	CONDUCTED POWER (dBm)	ANTENNA GAIN (dBi)	EIRP (dBm)	EIRP (W)	Limit (W)
Low	3652.50	19.06	15.00	34.06	2.547	5.00
Middle	3662.50	18.94	15.00	33.94	2.477	5.00
High	3672.50	18.73	15.00	33.73	2.360	5.00

NOTE: EIRP = Conducted power + Antenna Gain

EIRP PEAK DENSITY						
CHANNEL	FREQUENCY (MHz)	CONDUCTED POWER DENSITY (dBm/MHz)	ANTENNA GAIN (dBi)	EIRP PEAK DENSITY (dBm/MHz)	EIRP PEAK DENSITY (W/MHz)	Limit (W/MHz)
Low	3652.50	14.585	15.00	29.59	0.909	1.00
Middle	3662.50	14.308	15.00	29.31	0.853	1.00
High	3672.50	14.447	15.00	29.45	0.880	1.00

NOTE: EIRP density = Conducted power density + Antenna Gain



A D T

OUTPUT POWER

LOW CHANNEL

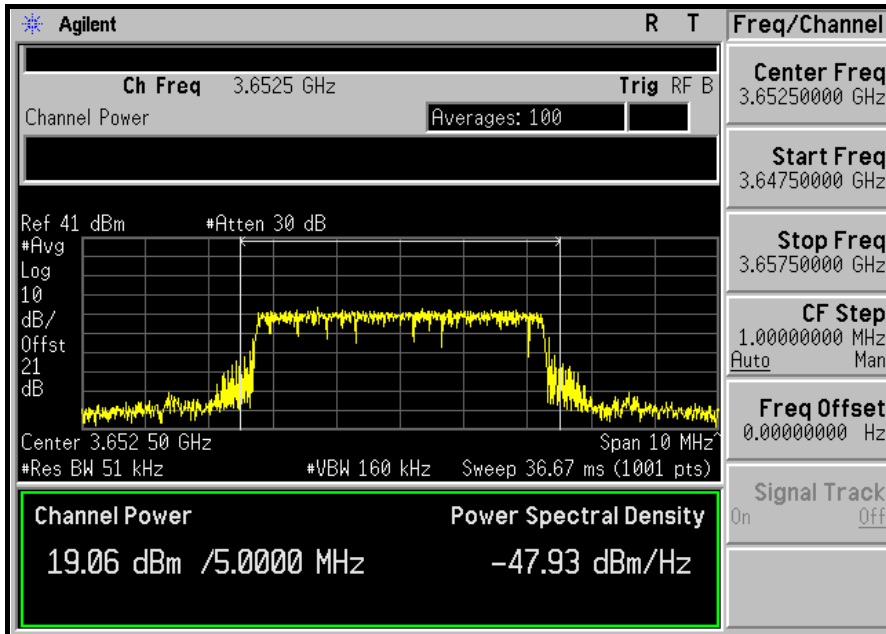

MIDDLE CHANNEL

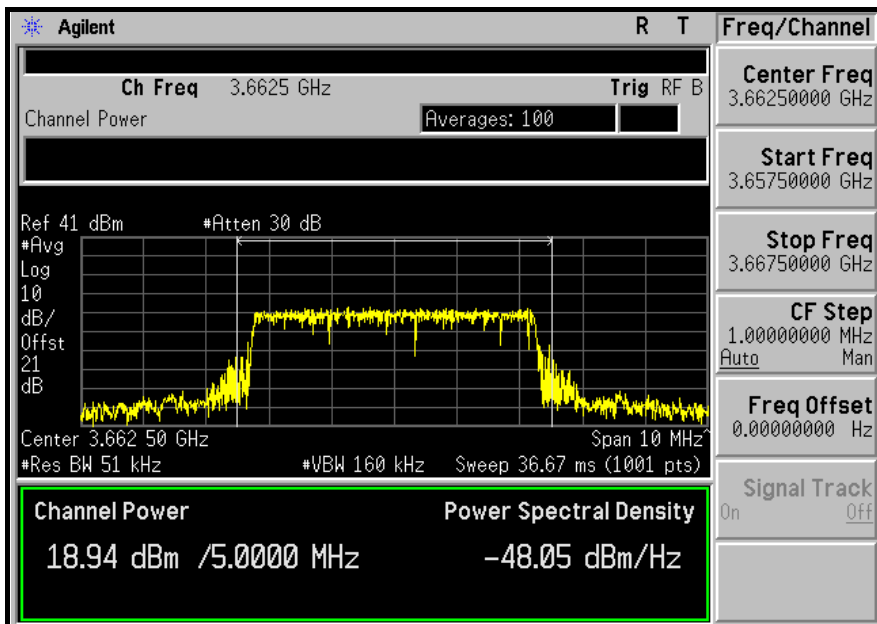



A D T

HIGH CHANNEL

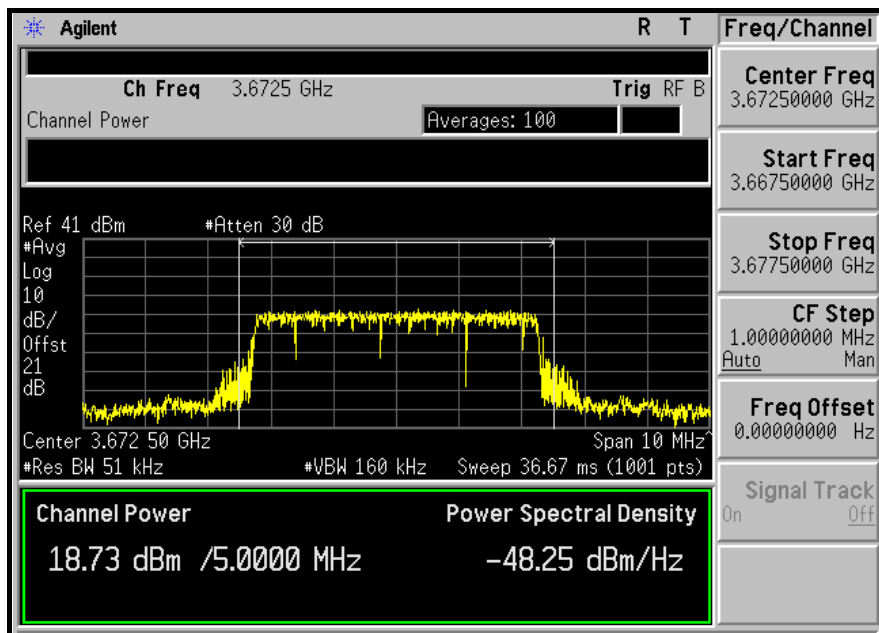

POWER DENSITY

LOW CHANNEL

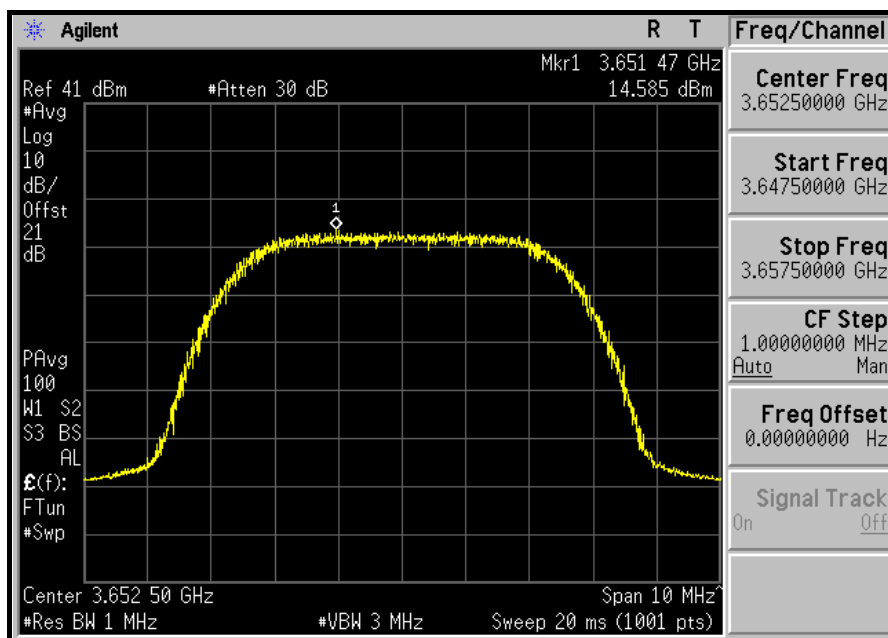



A D T

MIDDLE CHANNEL

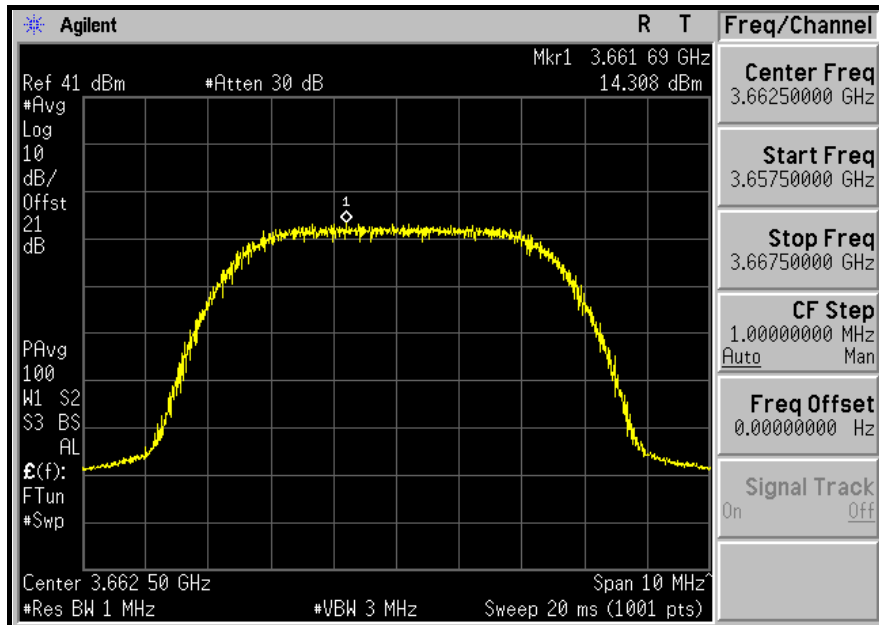

HIGH CHANNEL

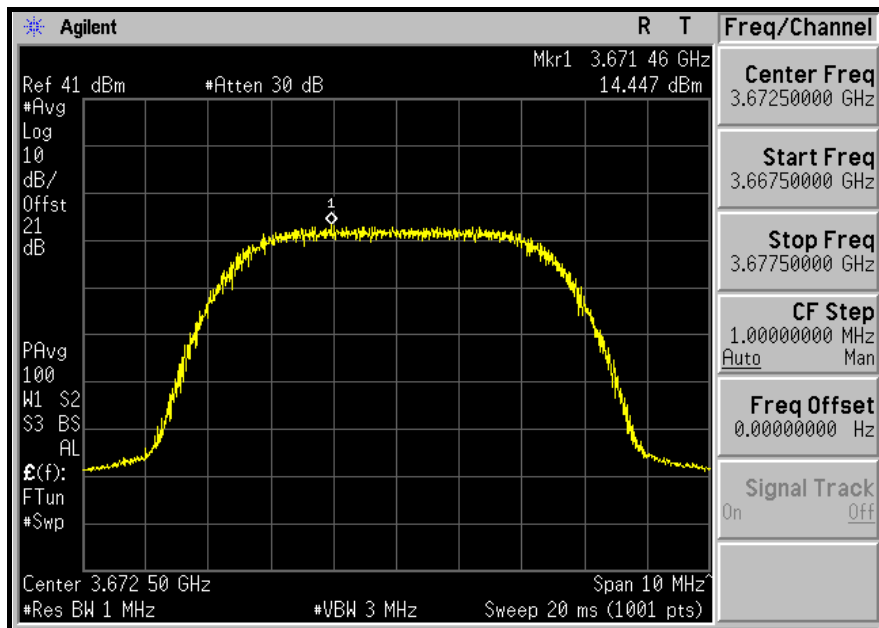



A D T

DETECTOR FUNCTION	Average	CHANNEL BANDWIDTH	7.0MHz
--------------------------	---------	--------------------------	--------

EIRP POWER						
CHANNEL	FREQUENCY (MHz)	CONDUCTED POWER (dBm)	ANTENNA GAIN (dBi)	EIRP (dBm)	EIRP (W)	Limit (W)
Low	3653.50	20.30	15.00	35.30	3.388	7.00
Middle	3662.50	19.39	15.00	34.39	2.748	7.00
High	3671.50	19.01	15.00	34.01	2.518	7.00

NOTE: EIRP = Conducted power + Antenna Gain

EIRP PEAK DENSITY						
CHANNEL	FREQUENCY (MHz)	CONDUCTED POWER DENSITY (dBm/MHz)	ANTENNA GAIN (dBi)	EIRP PEAK DENSITY (dBm/MHz)	EIRP PEAK DENSITY (W/MHz)	Limit (W/MHz)
Low	3653.50	14.748	15.00	29.75	0.944	1.00
Middle	3662.50	14.048	15.00	29.05	0.803	1.00
High	3671.50	14.372	15.00	29.37	0.865	1.00

NOTE: EIRP density = Conducted power density + Antenna Gain



A D T

OUTPUT POWER

LOW CHANNEL

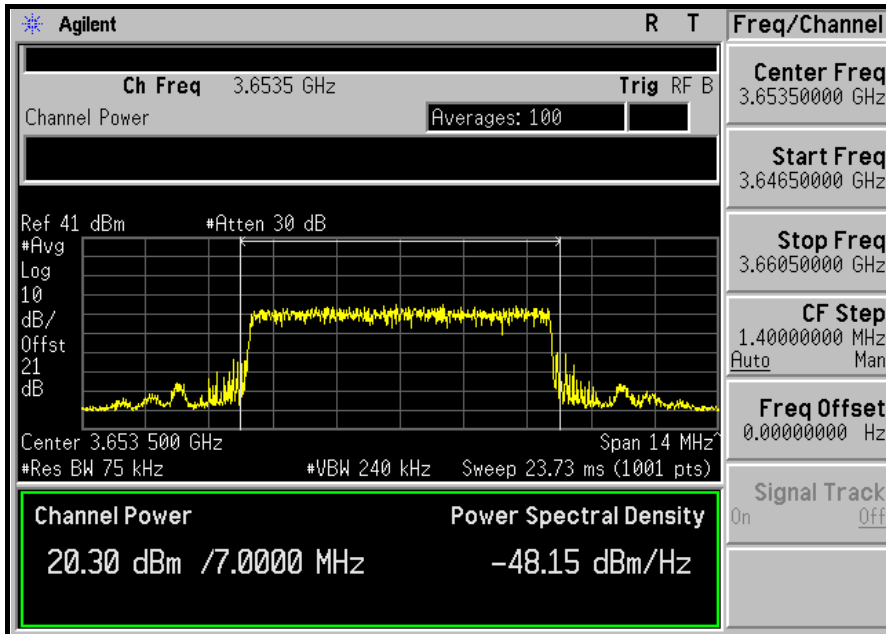

MIDDLE CHANNEL

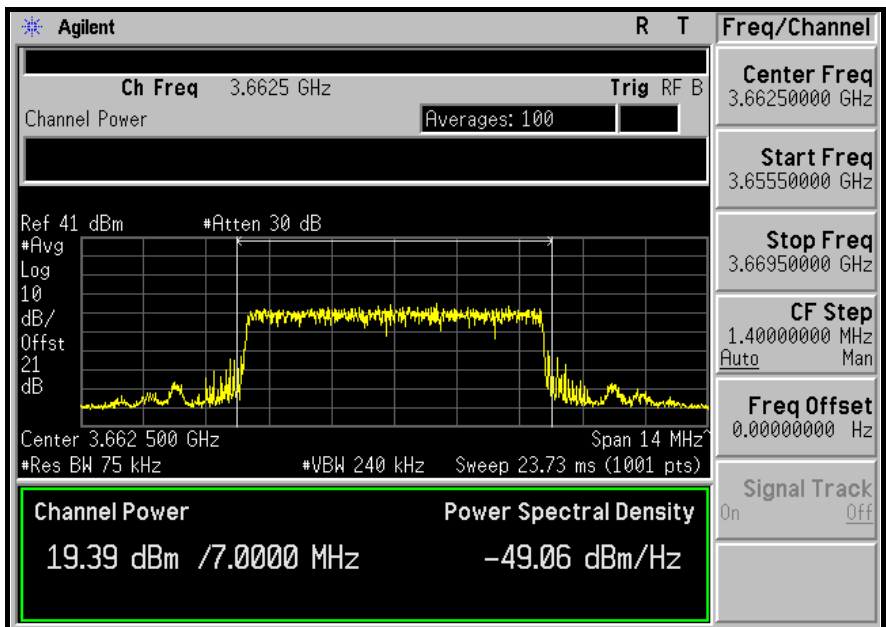



A D T

HIGH CHANNEL

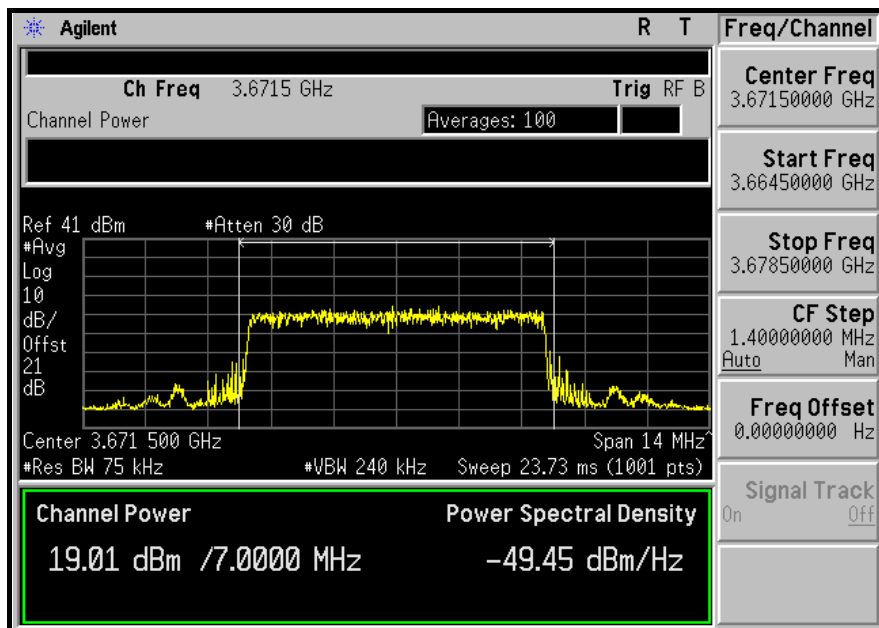

POWER DENSITY

LOW CHANNEL

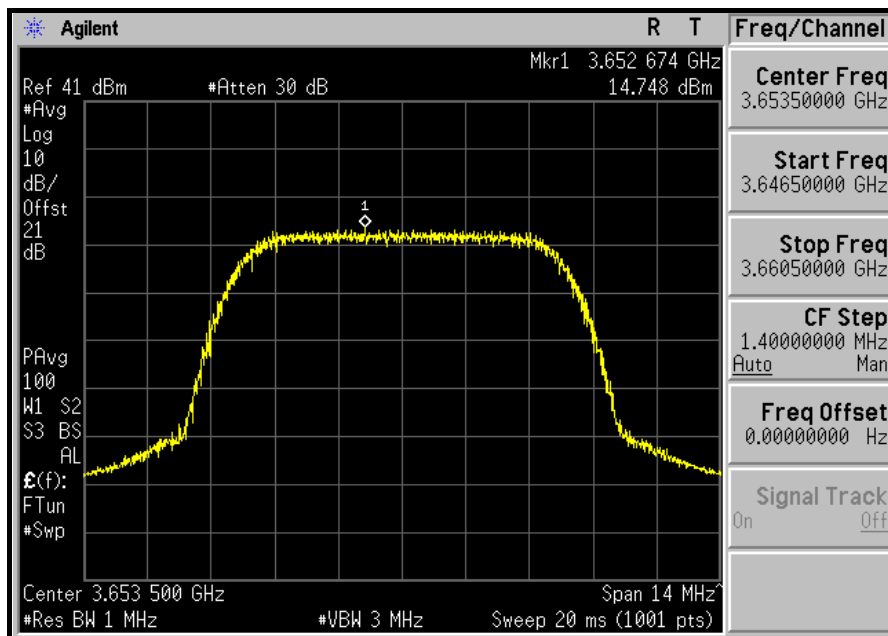



A D T

MIDDLE CHANNEL

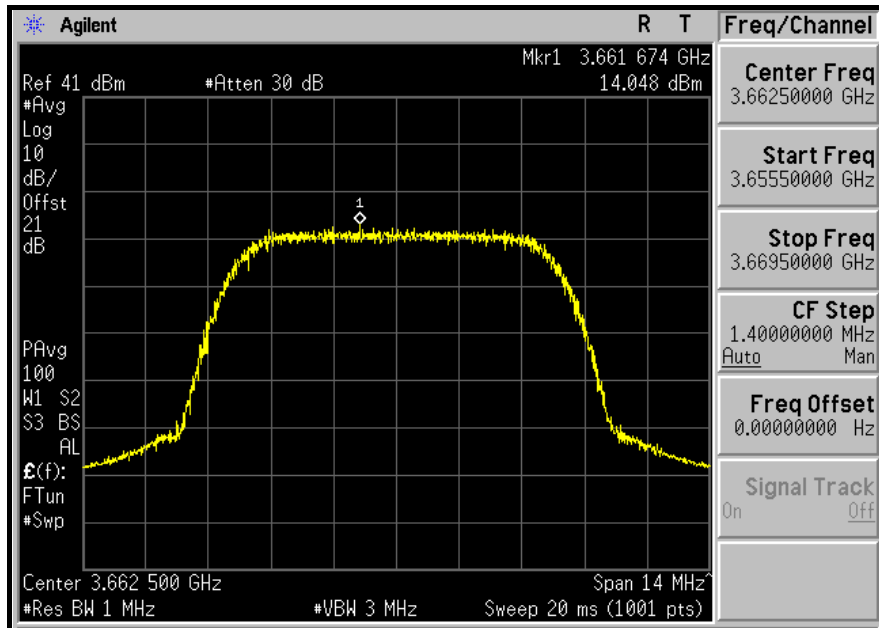

HIGH CHANNEL

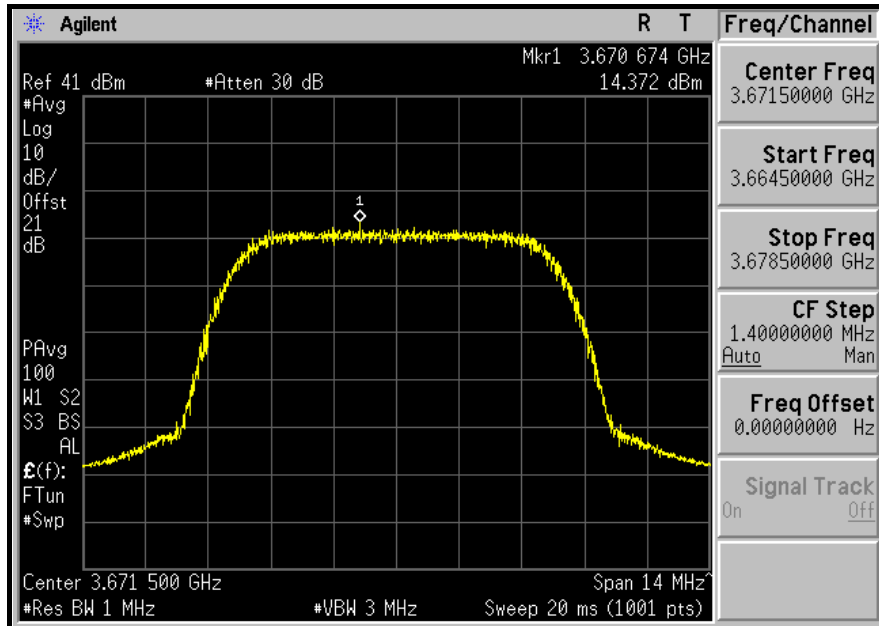



A D T

DETECTOR FUNCTION	Average	CHANNEL BANDWIDTH	10.0MHz
-------------------	---------	-------------------	---------

EIRP POWER						
CHANNEL	FREQUENCY (MHz)	CONDUCTED POWER (dBm)	ANTENNA GAIN (dBi)	EIRP (dBm)	EIRP (W)	Limit (W)
Low	3655.00	22.55	15.00	37.55	5.689	10.00
Middle	3662.50	22.50	15.00	37.50	5.623	10.00
High	3670.00	22.44	15.00	37.44	5.546	10.00

NOTE: EIRP = Conducted power + Antenna Gain

EIRP PEAK DENSITY						
CHANNEL	FREQUENCY (MHz)	CONDUCTED POWER DENSITY (dBm/MHz)	ANTENNA GAIN (dBi)	EIRP PEAK DENSITY (dBm/MHz)	EIRP PEAK DENSITY (W/MHz)	Limit (W/MHz)
Low	3655.00	14.697	15.00	29.70	0.933	1.00
Middle	3662.50	14.552	15.00	29.55	0.902	1.00
High	3670.00	14.252	15.00	29.25	0.842	1.00

NOTE: EIRP density = Conducted power density + Antenna Gain



A D T

OUTPUT POWER

LOW CHANNEL

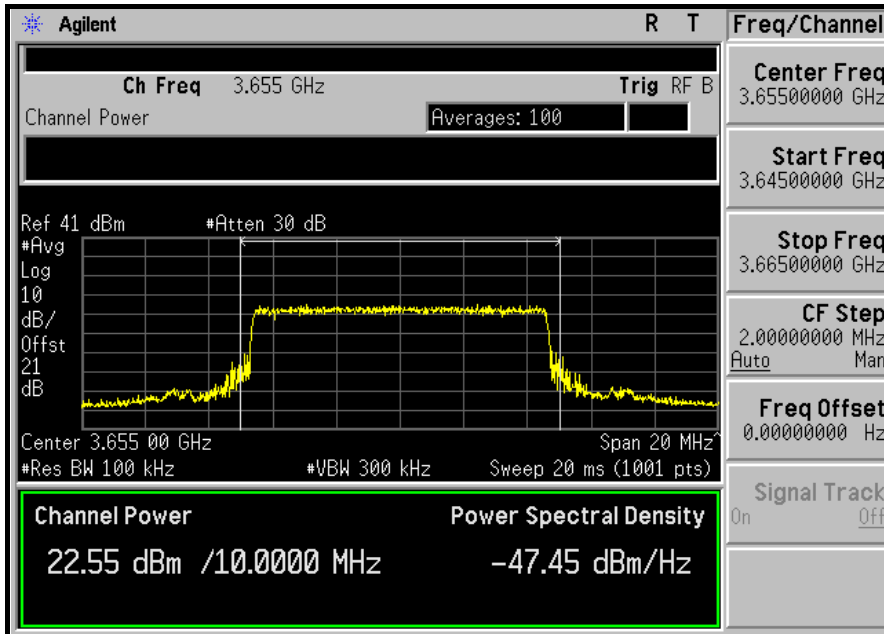

MIDDLE CHANNEL

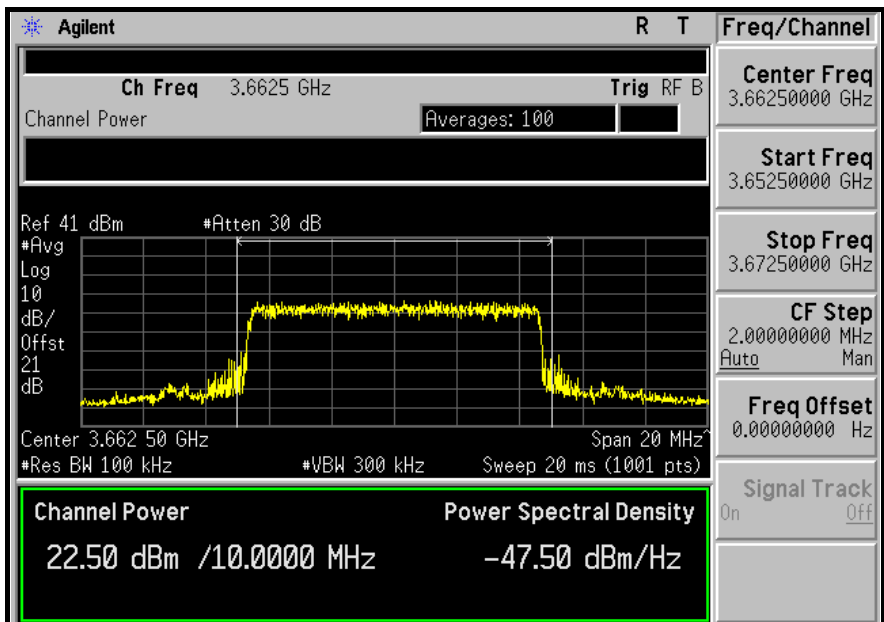



A D T

HIGH CHANNEL

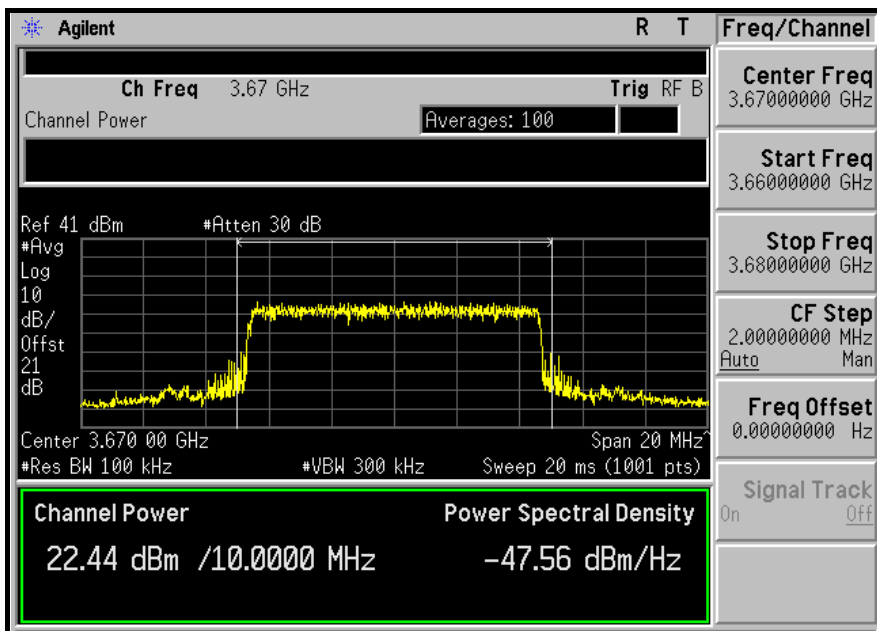

POWER DENSITY

LOW CHANNEL

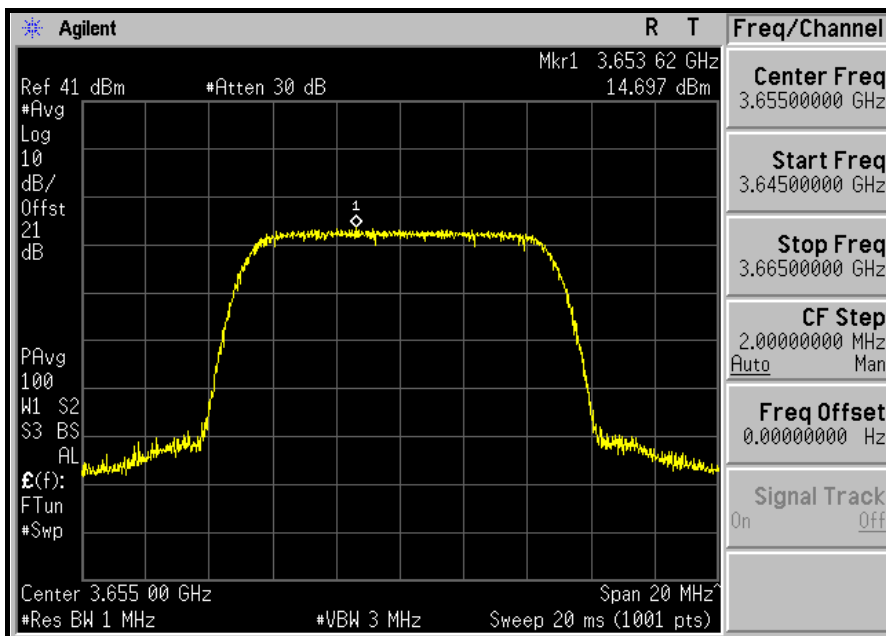



A D T

MIDDLE CHANNEL

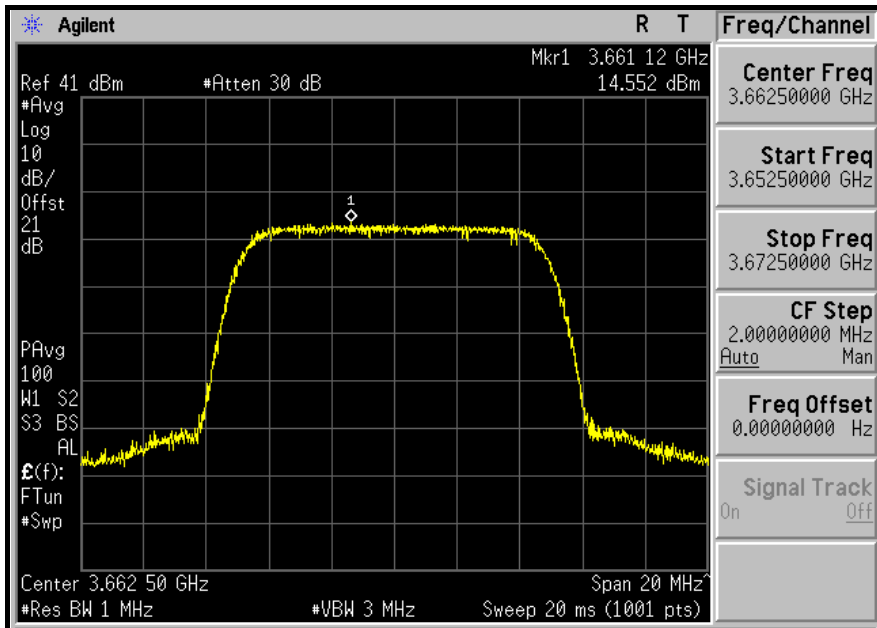

HIGH CHANNEL

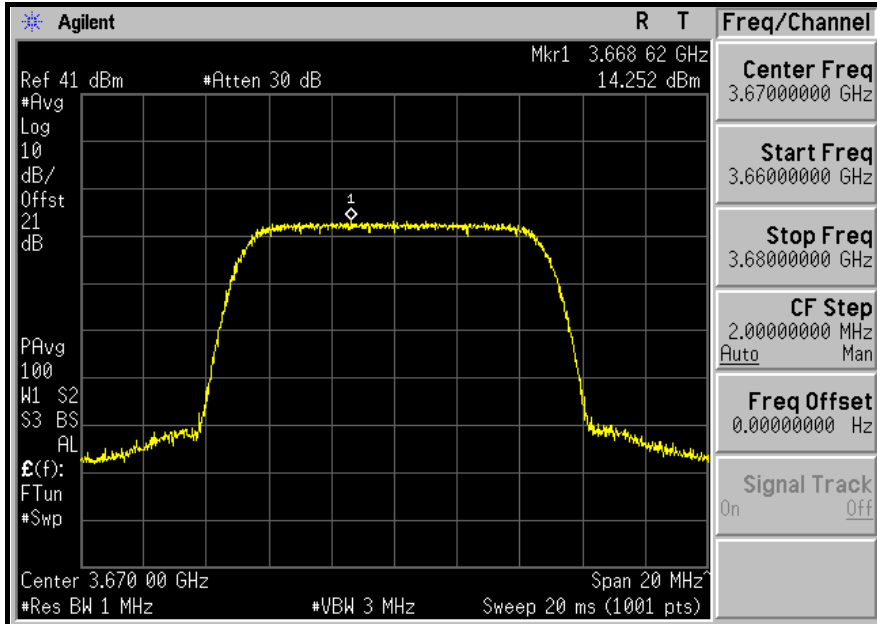



4.2 FREQUENCY STABILITY MEASUREMENT

4.2.1 LIMITS OF FREQUENCY STABILITY MEASUREMENT

According to the FCC part 2.1055 shall be tested the frequency stability. The rule is defined that "The frequency stability shall be sufficient to ensure that the fundamental emission stays within the authorized frequency block." The test extreme voltage is according to the 2.1055(d)(1) Vary primary supply voltage from 85 to 115 percent of the nominal value for other than hand carried battery equipment and the extreme temperature rule is comply with specification of EUT $-40^{\circ}\text{C} \sim 70^{\circ}\text{C}$.

4.2.2 TEST INSTRUMENTS

DESCRIPTION & MANUFACTURER	MODEL NO.	SERIAL NO.	DATE OF CALIBRATION	DUE DATE OF CALIBRATION
Spectrum Analyzer Agilent	E4446A	MY44360128	Feb. 23, 2010	Feb. 22, 2011
RF cable	SUCOFLEX 104	257029	Aug. 27, 2010	Aug. 26, 2011
WIT Standard Temperature & Humidity Chamber	TH-4S-C	W981030	Jun. 28, 2010	Jun. 27, 2011

NOTE: The calibration interval of the above test instruments is 12 months. And the calibrations are traceable to NML/ROC and NIST/USA.

4.2.3 TEST PROCEDURE

- a. Power must be removed when changing from one temperature to another or one voltage to another voltage. Power warm up is at least 15 min and power applied should perform before recording frequency error.
- b. EUT is connected the external power supply to control the AC input power. The various Volts from the minimum 93.5 Volts to 126.5 Volts. Each step shall be record the frequency error rate.
- c. The temperature range step is 10 degrees in this test items. All temperature levels shall be hold the $\pm 0.5^{\circ}\text{C}$ during the measurement testing.
- d. The each temperature step shall be at least 0.5 hours, consider the EUT could be test under the stability condition.

4.2.4 TEST SETUP

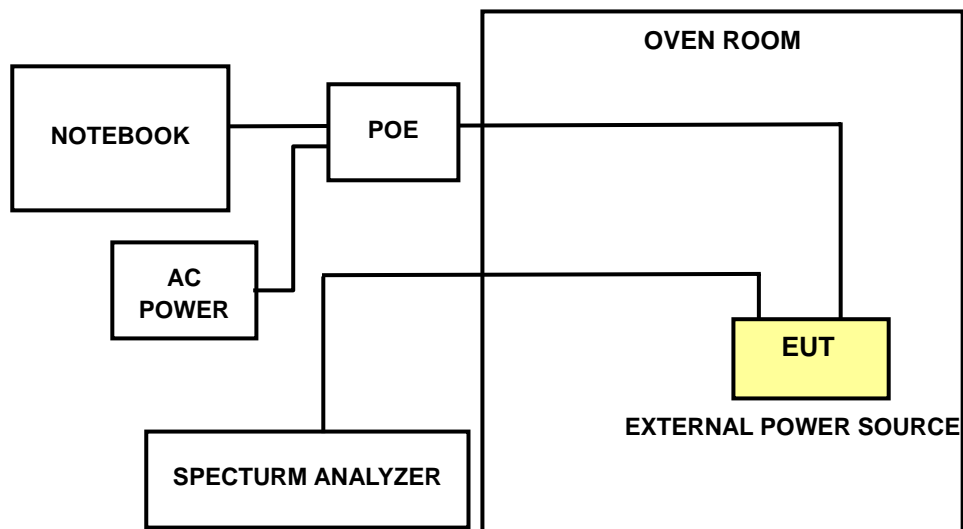

4.2.5 EUT OPERATING CONDITIONS

The EUT connected to the notebook. Use software to control the EUT channel and transmit a single tone.



A D T

4.2.6 TEST RESULTS

CHANNEL BANDWIDTH	5.0MHz
--------------------------	---------------

FREQUENCY STABILITY V.S. VOLTAGE			
TEMP. (°C)	VOL. (Volts)	FREQUENCY (MHz)	FREQUENCY ERROR (ppm)
20	93.5	3652.502361	0.646
20	110.0	3652.500824	0.226
20	126.5	3652.501942	0.532

FREQUENCY STABILITY V.S. TEMPERATURE			
TEMP. (°C)	VOL. (Volts)	FREQUENCY (MHz)	FREQUENCY ERROR (ppm)
70	110.0	3652.502164	0.592
60	110.0	3652.500607	0.166
50	110.0	3652.501870	0.512
40	110.0	3652.501082	0.296
30	110.0	3652.501428	0.391
20	110.0	3652.500824	0.226
10	110.0	3652.501960	0.537
0	110.0	3652.500774	0.212
-10	110.0	3652.500846	0.232
-20	110.0	3652.501603	0.439
-30	110.0	3652.501884	0.516
-40	110.0	3652.501340	0.367

CARRIER FREQUENCY: 3652.50MHz



A D T

CHANNEL BANDWIDTH	7.0MHz
--------------------------	--------

FREQUENCY STABILITY V.S. VOLTAGE			
---	--	--	--

TEMP. (°C)	VOL. (Volts)	FREQUENCY (MHz)	FREQUENCY ERROR (ppm)
20	93.5	3653.500774	0.212
20	110.0	3653.500736	0.201
20	126.5	3653.500496	0.136

FREQUENCY STABILITY V.S. TEMPERATURE			
---	--	--	--

TEMP. (°C)	VOL. (Volts)	FREQUENCY (MHz)	FREQUENCY ERROR (ppm)
70	110.0	3653.502417	0.662
60	110.0	3653.500880	0.241
50	110.0	3653.501961	0.537
40	110.0	3653.501077	0.295
30	110.0	3653.501831	0.501
20	110.0	3653.500736	0.201
10	110.0	3653.501836	0.503
0	110.0	3653.501104	0.302
-10	110.0	3653.500891	0.244
-20	110.0	3653.500949	0.260
-30	110.0	3653.502295	0.628
-40	110.0	3653.502238	0.613

CARRIER FREQUENCY: 3653.50MHz



A D T

CHANNEL BANDWIDTH	10.0MHz
--------------------------	----------------

FREQUENCY STABILITY V.S. VOLTAGE			
TEMP. (°C)	VOL. (Volts)	FREQUENCY (MHz)	FREQUENCY ERROR (ppm)
20	93.5	3655.002311	0.632
20	110.0	3655.001332	0.364
20	126.5	3655.001632	0.447
FREQUENCY STABILITY V.S. TEMPERATURE			
TEMP. (°C)	VOL. (Volts)	FREQUENCY (MHz)	FREQUENCY ERROR (ppm)
70	110.0	3655.002151	0.589
60	110.0	3655.000859	0.235
50	110.0	3655.001475	0.404
40	110.0	3655.000669	0.183
30	110.0	3655.001703	0.466
20	110.0	3655.001332	0.364
10	110.0	3655.002138	0.585
0	110.0	3655.000415	0.114
-10	110.0	3655.001333	0.365
-20	110.0	3655.001456	0.398
-30	110.0	3655.001658	0.454
-40	110.0	3655.001391	0.381
CARRIER FREQUENCY: 3655.00MHz			

4.3 EMISSION BANDWIDTH MEASUREMENT

4.3.1 LIMITS OF EMISSION BANDWIDTH MEASUREMENT

According to FCC 90.1323 specified that emission bandwidth is defined as the width of the signal between two points, one below the carrier center frequency and one above the carrier center frequency, outside of which all emissions are attenuated at least 26dB below the transmitter power.

4.3.2 TEST INSTRUMENTS

DESCRIPTION & MANUFACTURER	MODEL NO.	SERIAL NO.	DATE OF CALIBRATION	DUE DATE OF CALIBRATION
Spectrum Analyzer Agilent	E4446A	MY44360128	Feb. 23, 2010	Feb. 22, 2011
RF cable	SUCOFLEX 104	257029	Aug. 27, 2010	Aug. 26, 2011
DC-6GHz 20dB 50W Fixed attenuator Woken	MDC9331N-20	0724	May 15, 2010	May 14, 2011

NOTE: The calibration interval of the above test instruments is 12 months and the calibrations are traceable to NML/ROC and NIST/USA.

4.3.3 TEST PROCEDURE

The transmitter output was connected to the spectrum analyzer through an attenuator. The bandwidth of the fundamental frequency was measured by spectrum analyzer with RBW = 51kHz (5MHz bandwidth), 75kHz (7MHz bandwidth), 100kHz (10MHz bandwidth), VBW = 160kHz (5MHz bandwidth), 240kHz (7MHz bandwidth), 300kHz (10MHz bandwidth). The emission bandwidth is defined as the width of the signal between two points, one below the carrier center frequency and one above the carrier center frequency, outside of which all emissions are attenuated at least 26 dB below the transmitter power.

4.3.4 TEST SETUP

Same as 4.1.4

4.3.5 EUT OPERATING CONDITIONS

Same as 4.1.5



A D T

4.3.6 TEST RESULTS

CHANNEL BANDWIDTH	CHANNEL	-26dBc BANDWIDTH (MHz)
5.0MHz	Low	4.675
	Middle	4.625
	High	4.650



A D T

LOW CHANNEL

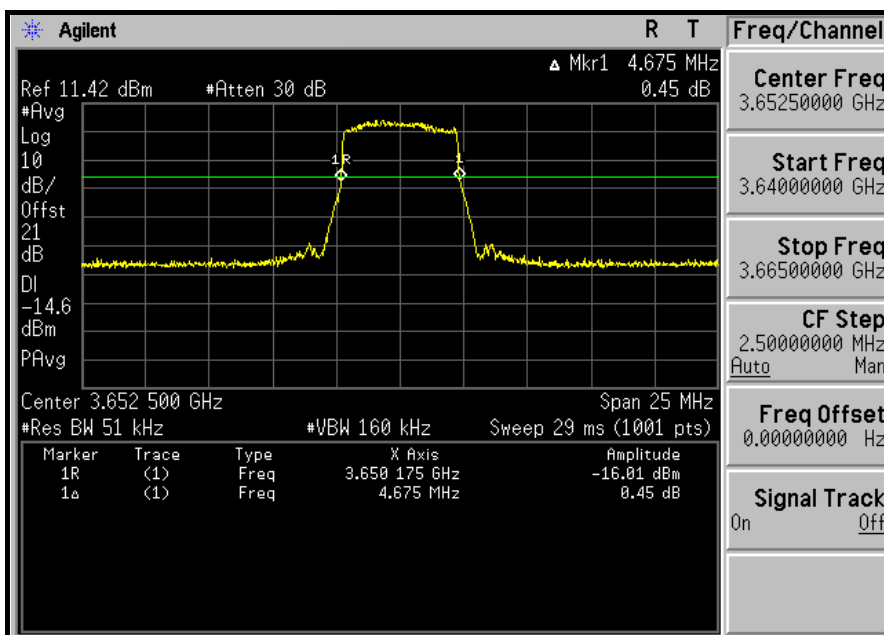
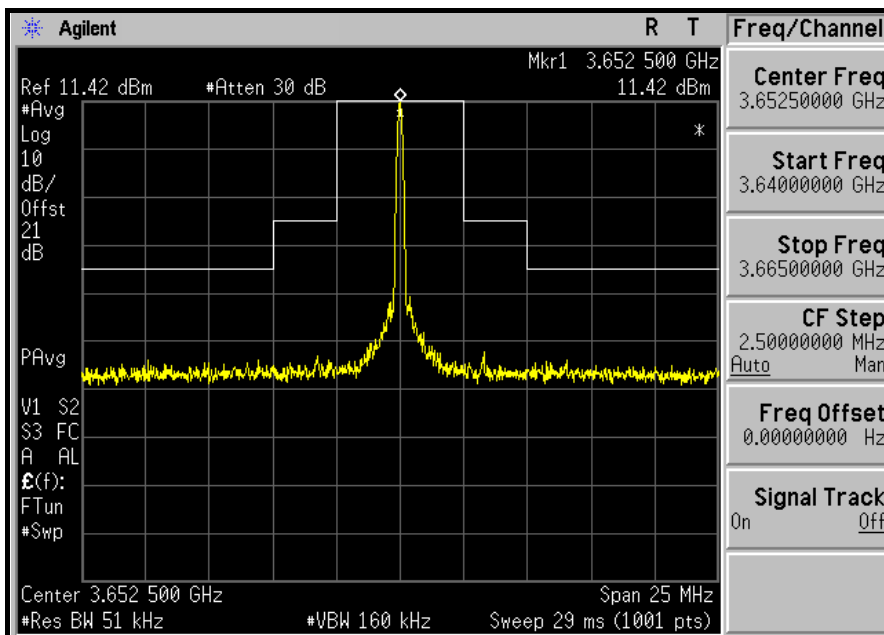



A D T

MIDDLE CHANNEL

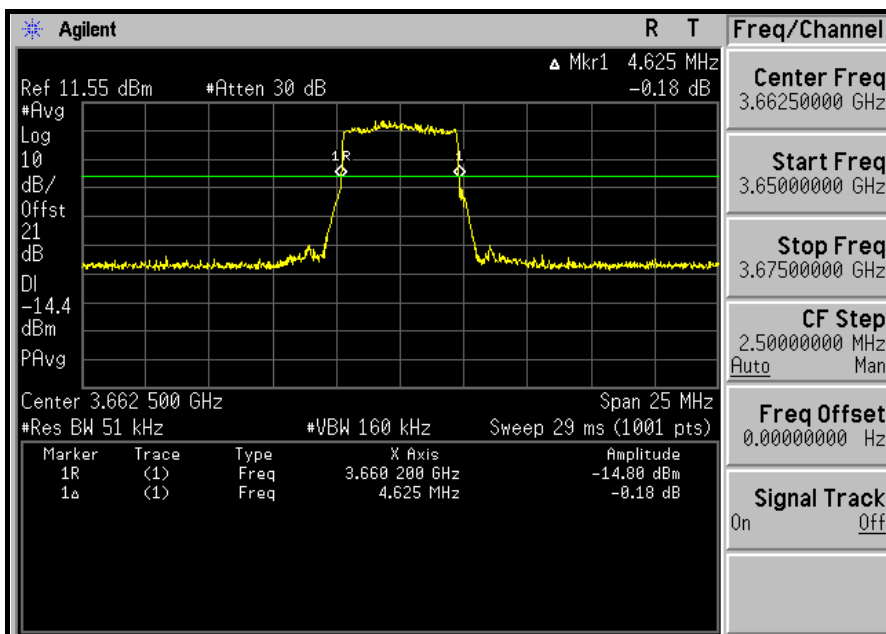
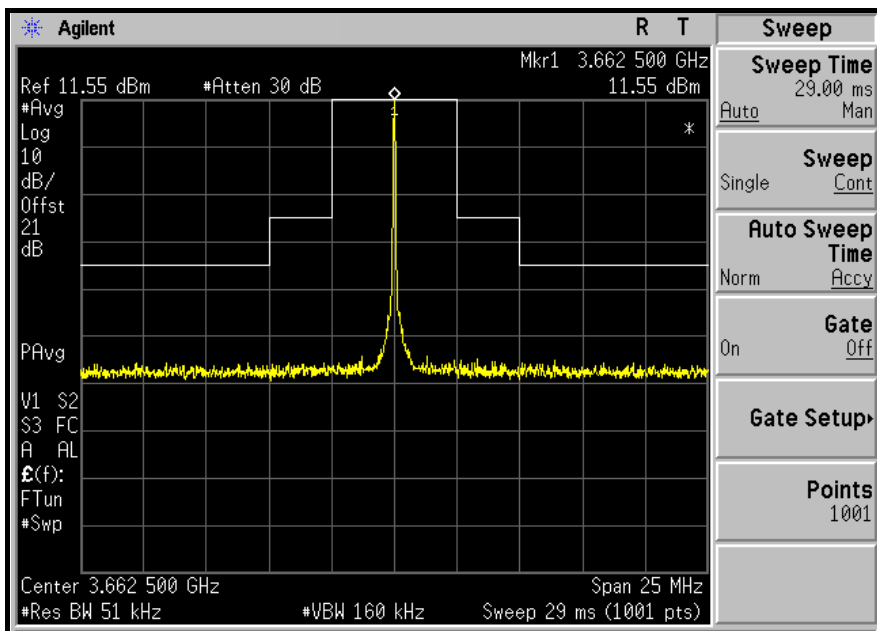



A D T

HIGH CHANNEL

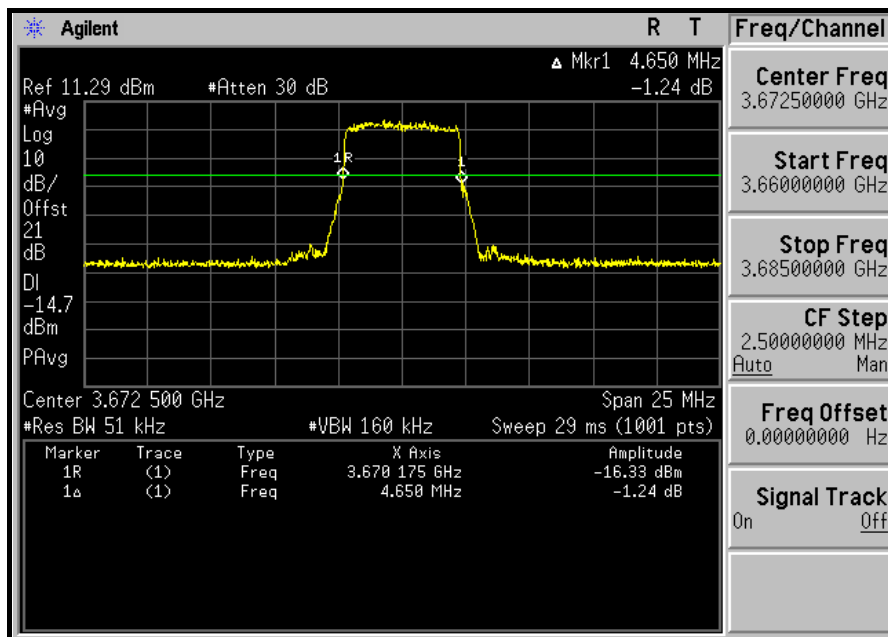
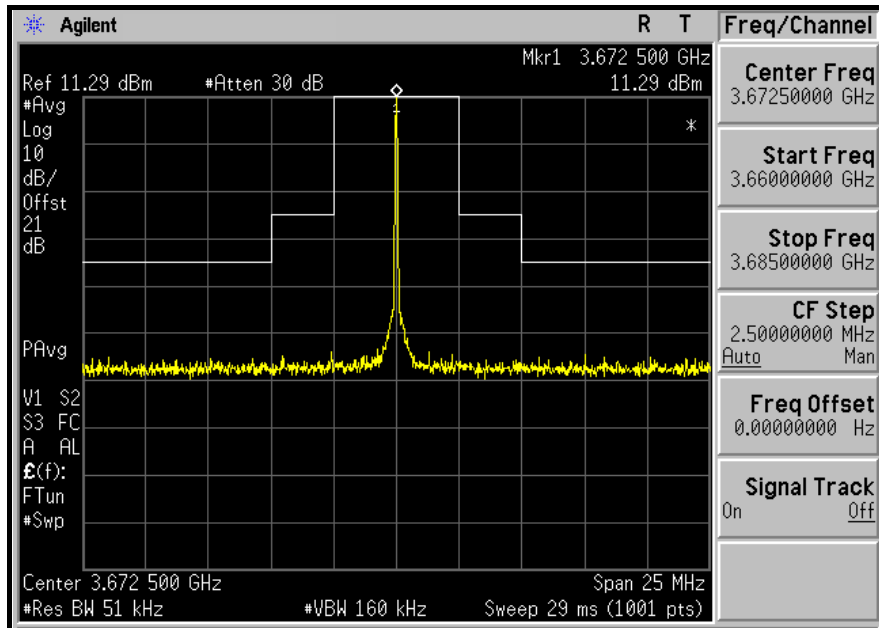



A D T

CHANNEL BANDWIDTH	CHANNEL	-26dBc BANDWIDTH (MHz)
7.0MHz	Low	6.825
	Middle	6.860
	High	6.790



A D T

LOW CHANNEL

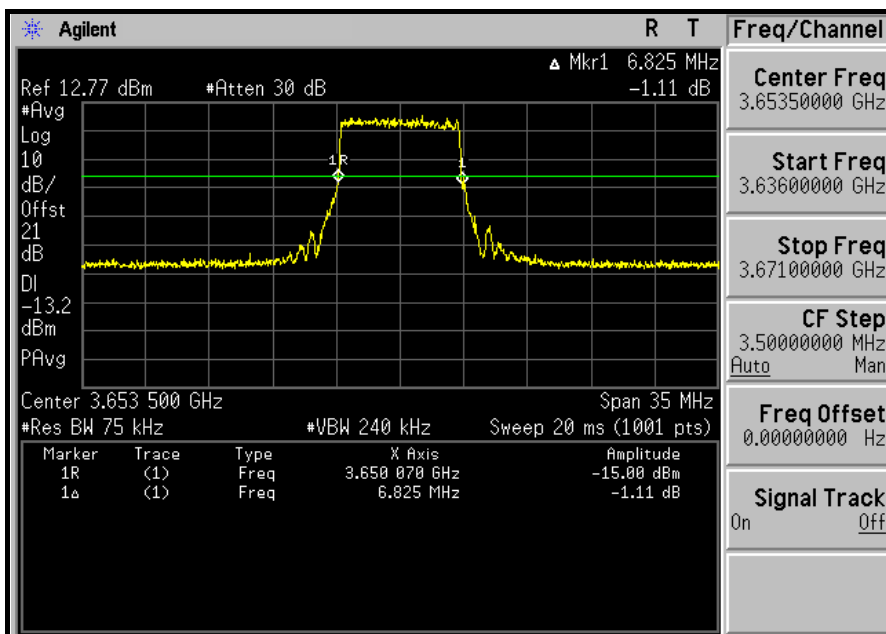
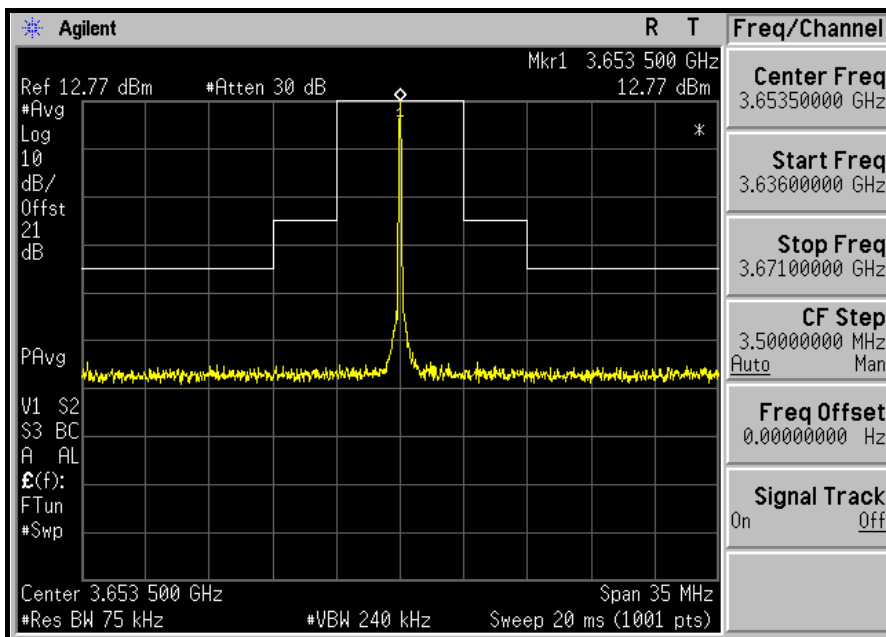



A D T

MIDDLE CHANNEL

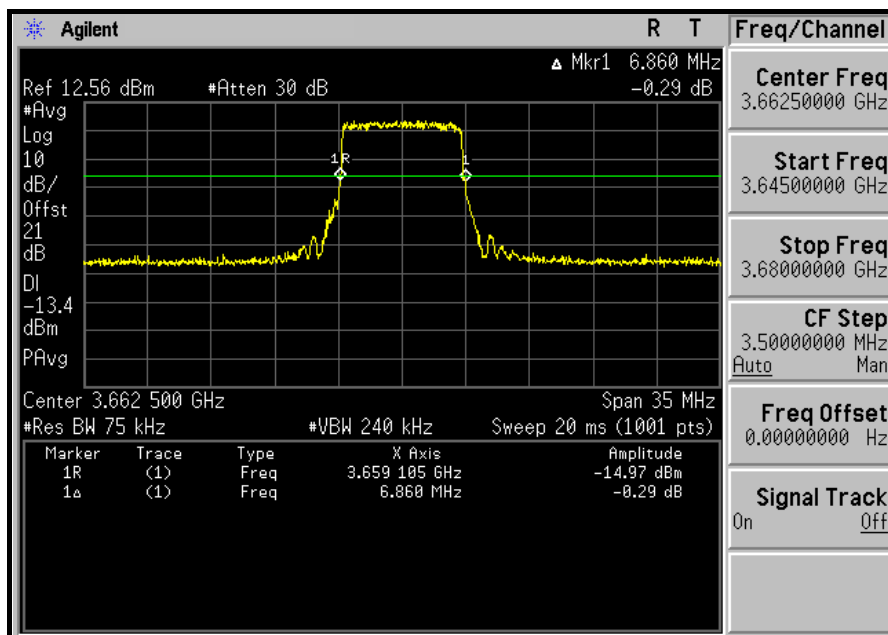
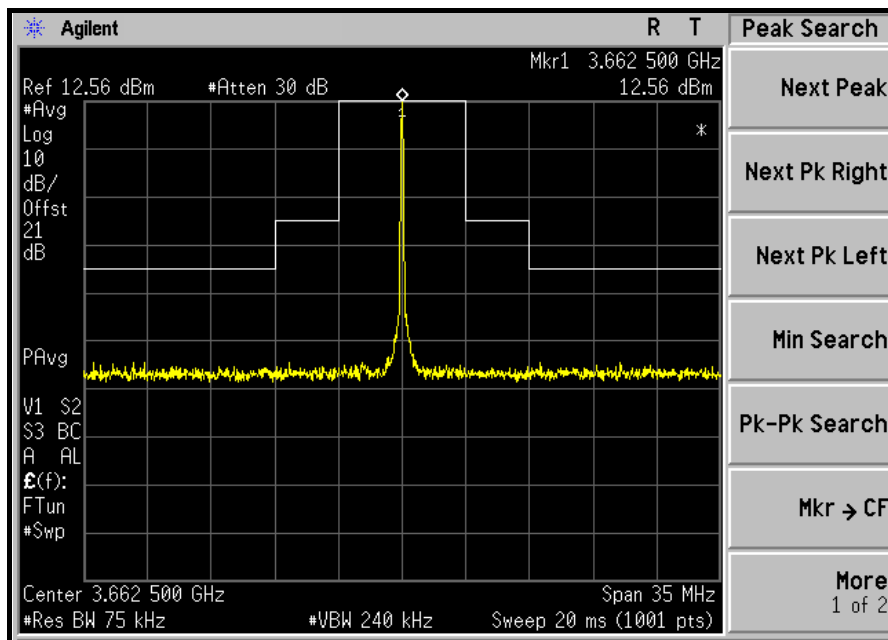



A D T

HIGH CHANNEL

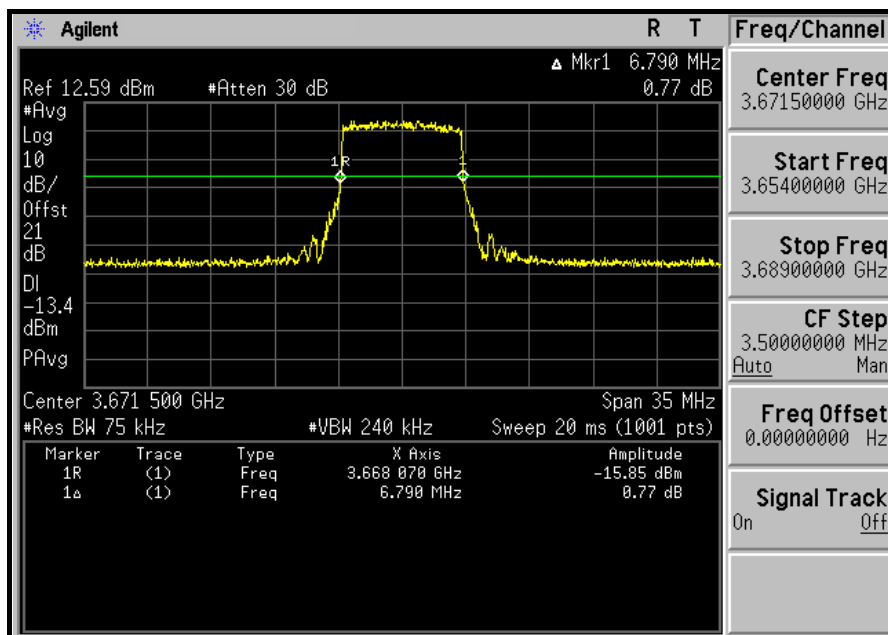
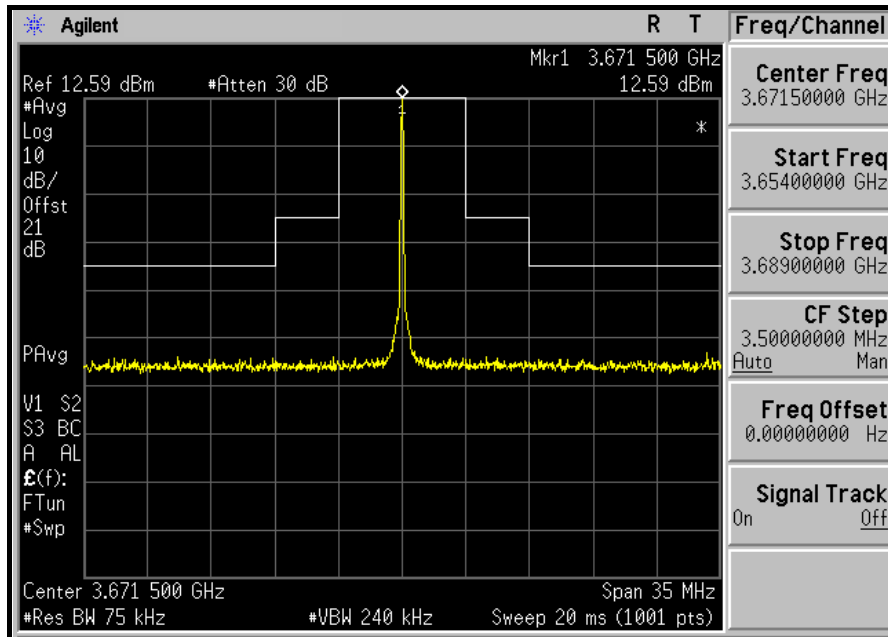



A D T

CHANNEL BANDWIDTH	CHANNEL	-26dBc BANDWIDTH (MHz)
10.0MHz	Low	9.600
	Middle	9.700
	High	9.650



A D T

LOW CHANNEL

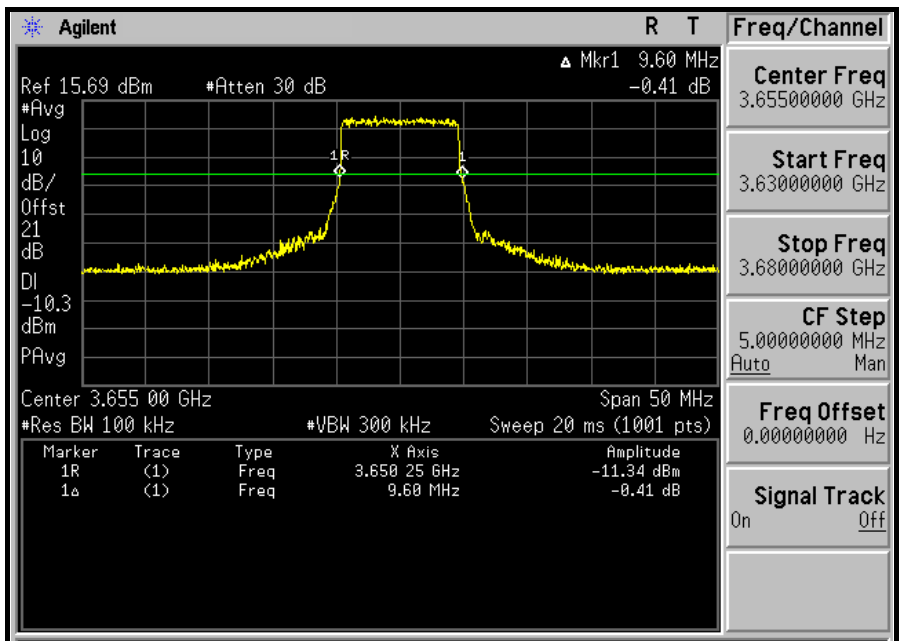
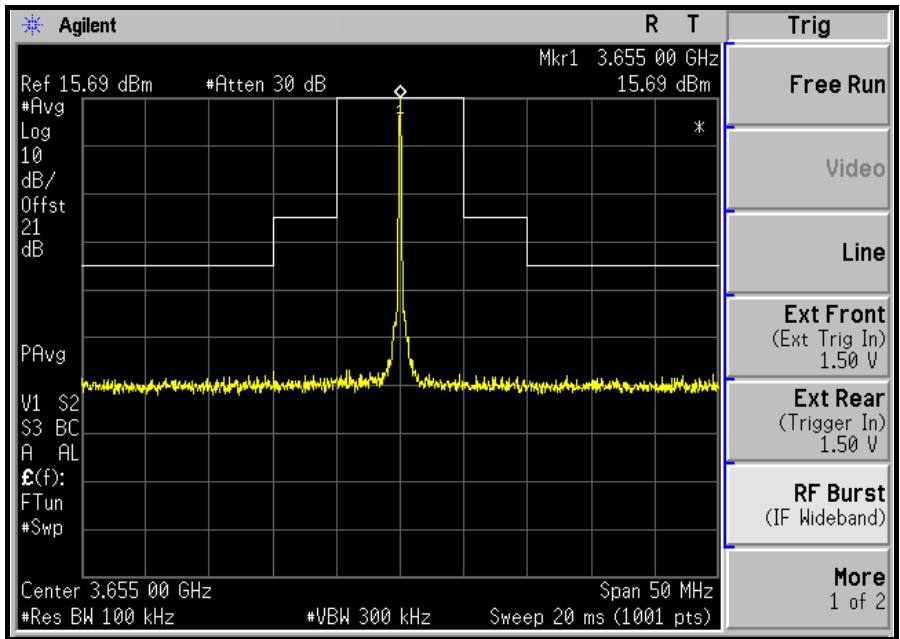



A D T

MIDDLE CHANNEL

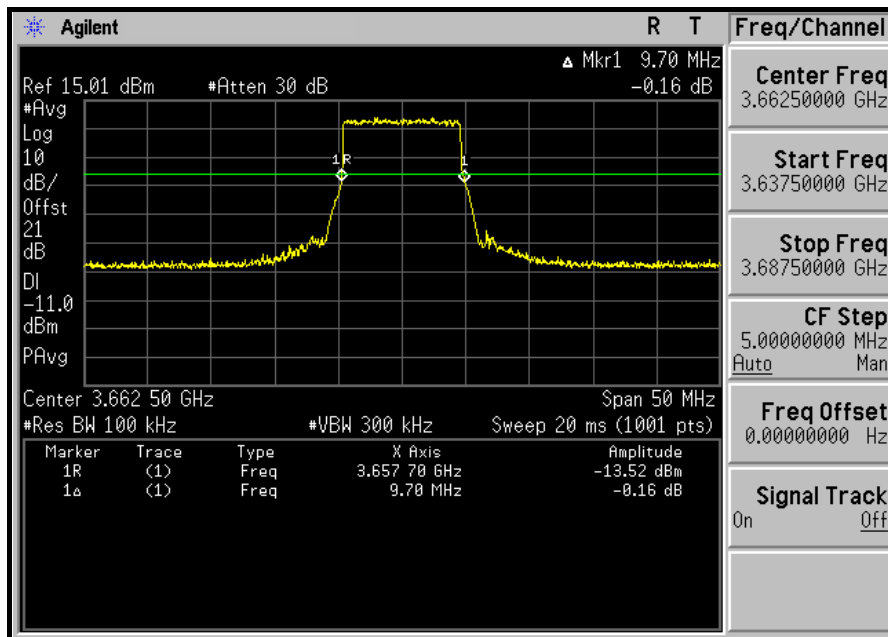
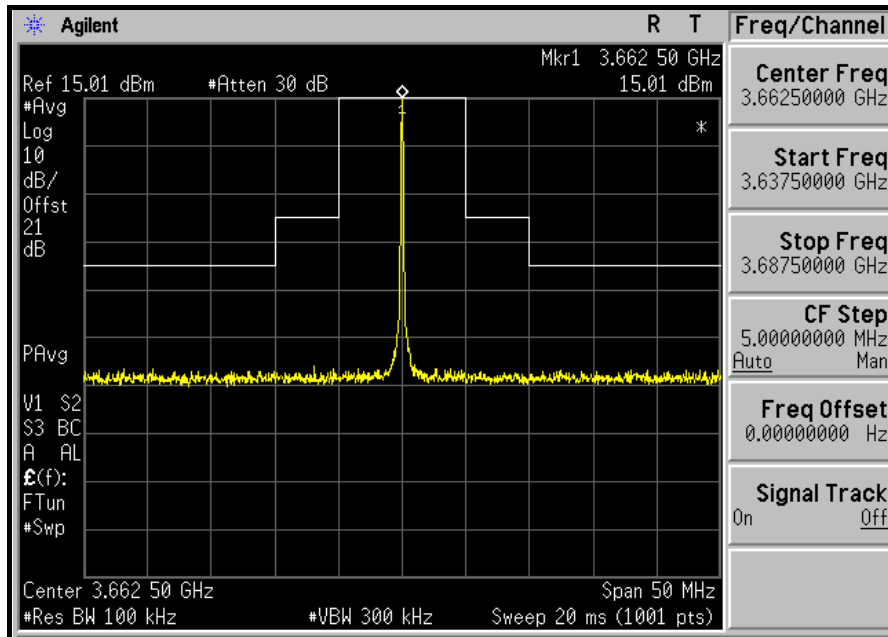



A D T

HIGH CHANNEL

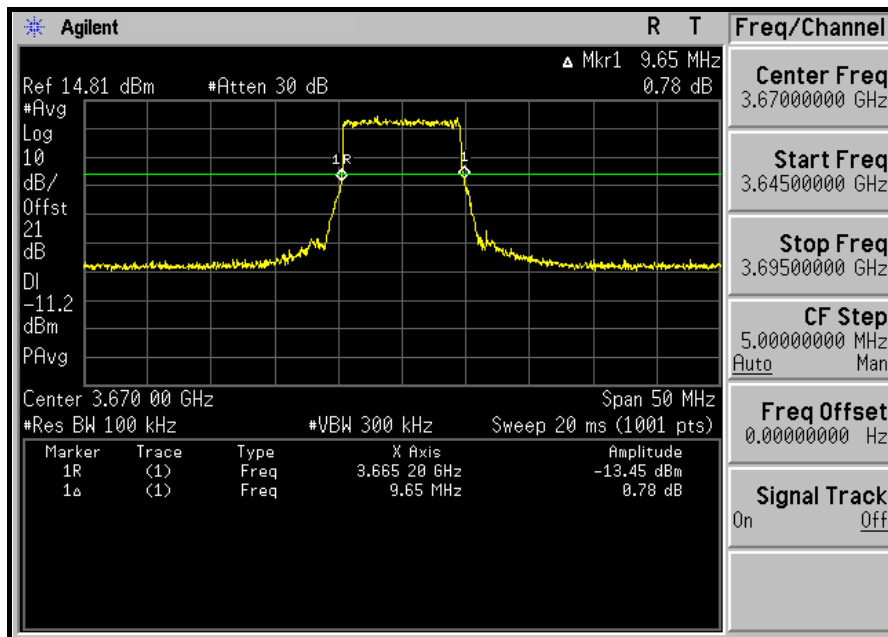
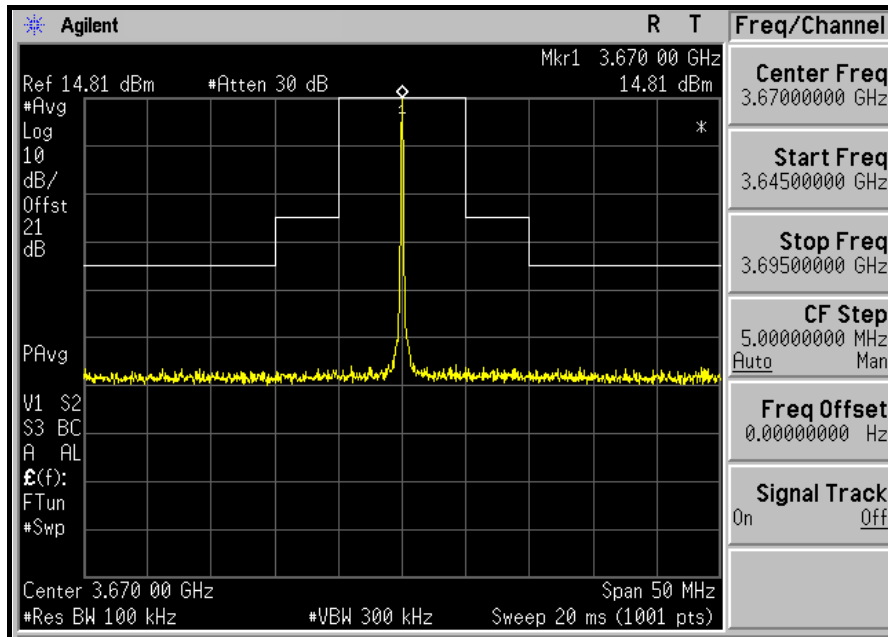

4.4 EMISSION MASKS

4.4.1 LIMITS OF EMISSION MASKS

For transmitters that are equipped with an audio low-pass filter, the power of any emission must be attenuated below the unmodulated carrier power (P) as follows:

- (1) On any frequency removed from the assigned frequency by more than 50 percent, but not more than 100 percent of the authorized bandwidth: At least 25 dB.
- (2) On any frequency removed from the assigned frequency by more than 100 percent, but not more than 250 percent of the authorized bandwidth: At least 35 dB.
- (3) On any frequency removed from the assigned frequency by more than 250 percent of the authorized bandwidth: At least $43 + 10\log(P)$ dB.

4.4.2 TEST INSTRUMENTS

DESCRIPTION & MANUFACTURER	MODEL NO.	SERIAL NO.	DATE OF CALIBRATION	DUE DATE OF CALIBRATION
Spectrum Analyzer Agilent	E4446A	MY44360128	Feb. 23, 2010	Feb. 22, 2011
RF cable	SUCOFLEX 104	257029	Aug. 27, 2010	Aug. 26, 2011
DC-6GHz 20dB 50W Fixed attenuator Woken	MDC9331N-20	0724	May 15, 2010	May 14, 2011

NOTE: The calibration interval of the above test instruments is 12 months and the calibrations are traceable to NML/ROC and NIST/USA.

4.4.3 TEST SETUP

Same as 4.1.4



A D T

4.4.4 TEST PROCEDURES

- a. The bandwidth of the fundamental frequency was measured by spectrum analyzer with RBW = 51kHz (5MHz bandwidth), 75kHz (7MHz bandwidth), 100kHz (10MHz bandwidth), VBW = 160kHz (5MHz bandwidth), 240kHz (7MHz bandwidth), 300kHz (10MHz bandwidth).
- b. Set EUT to transmit signal at un-modulation mode to get reference level, R_L .
- c. According R_L and Channel bandwidth to define Emission Mask range.
- d. Set EUT to transmit signal at modulation mode to check signal can comply with Emission Mask or not.

4.4.5 EUT OPERATING CONDITION

Same as 4.1.5



A D T

4.4.6 TEST RESULTS

CHANNEL BANDWIDTH: 5.0MHz LOW CHANNEL

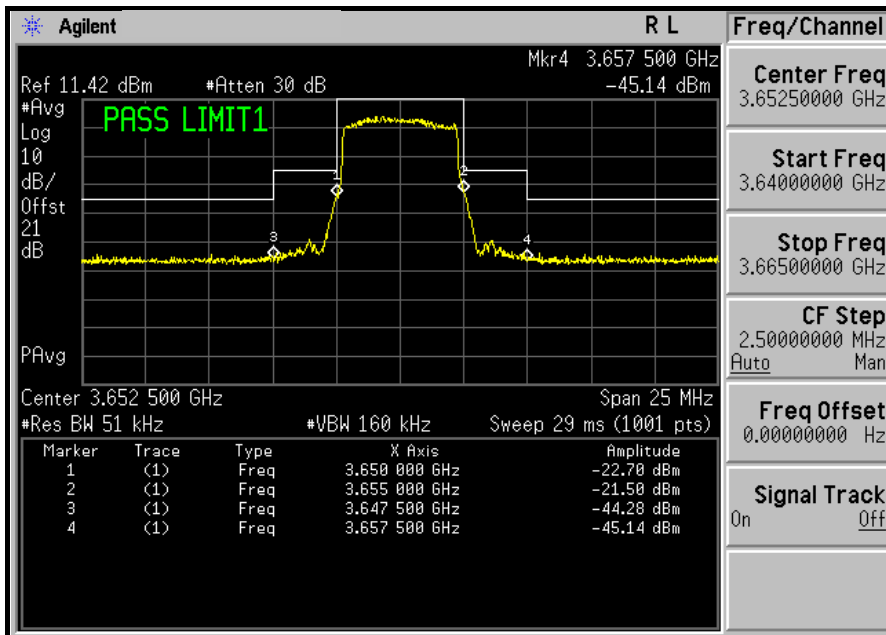
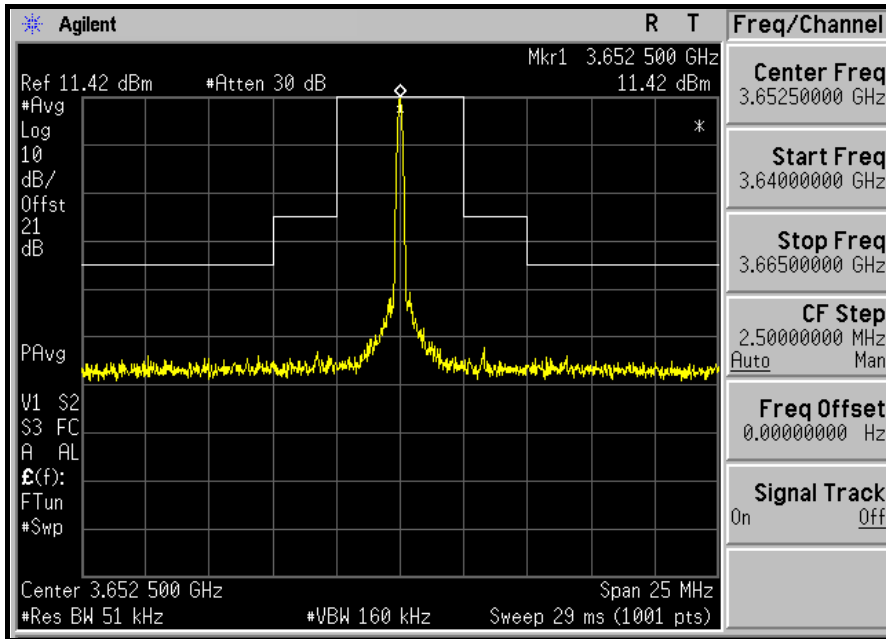



A D T

MIDDLE CHANNEL

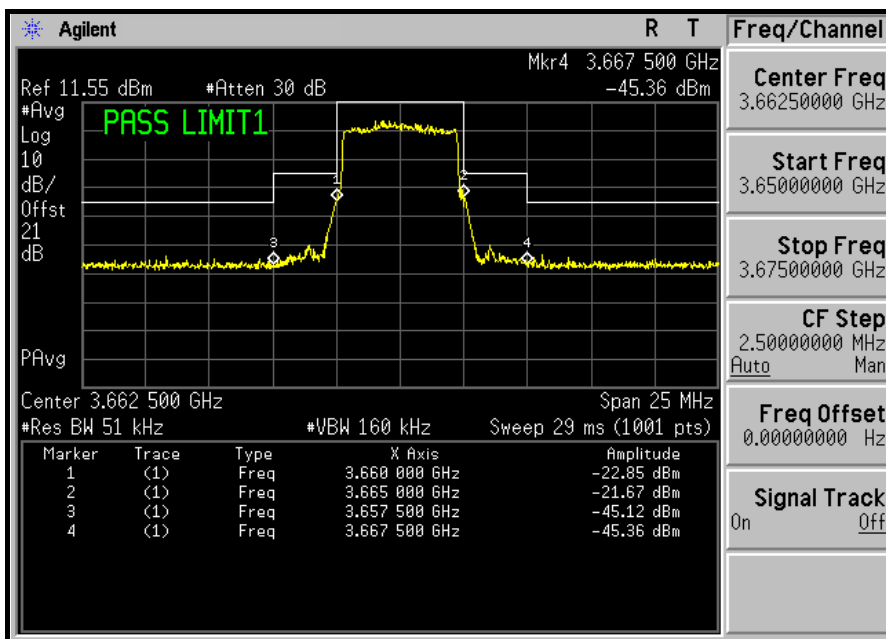
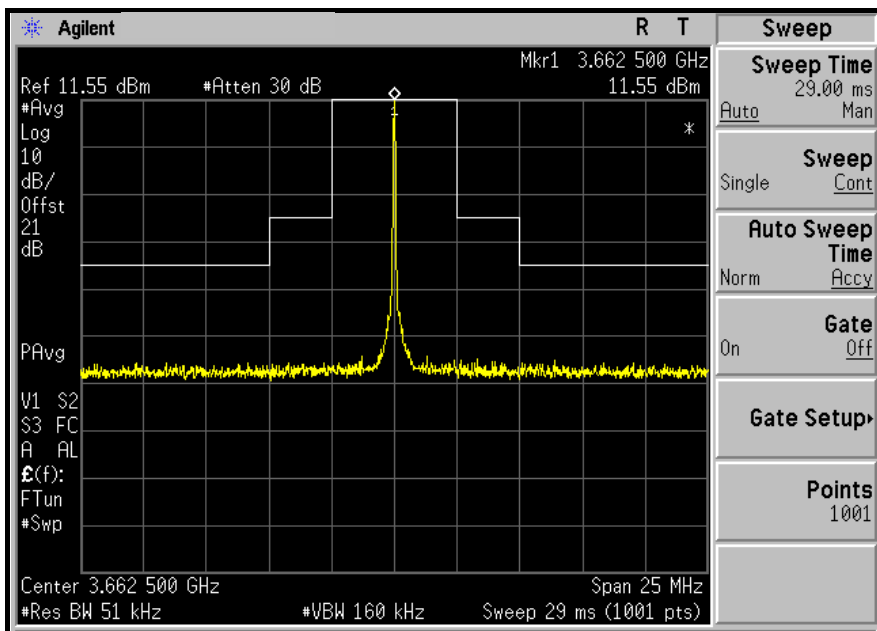



A D T

HIGH CHANNEL

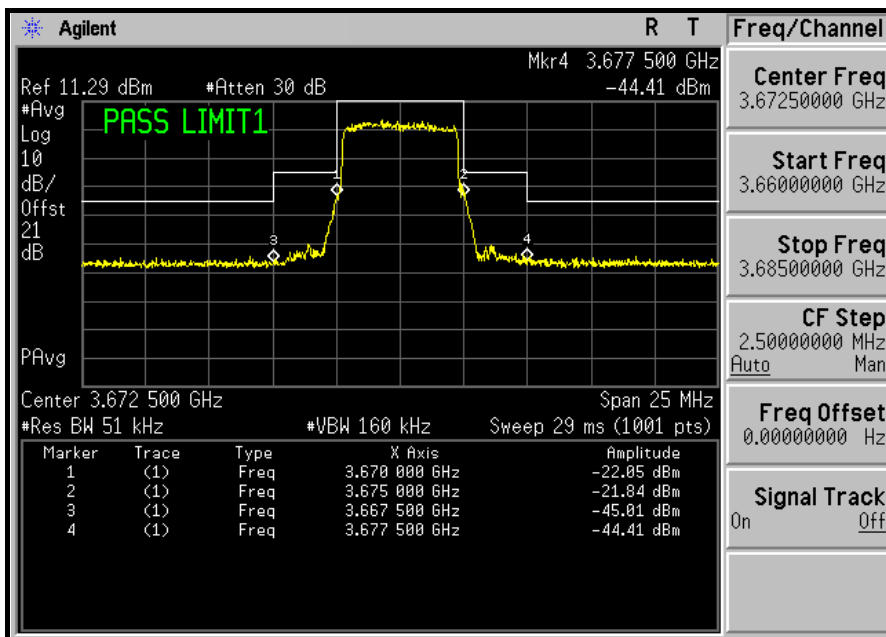
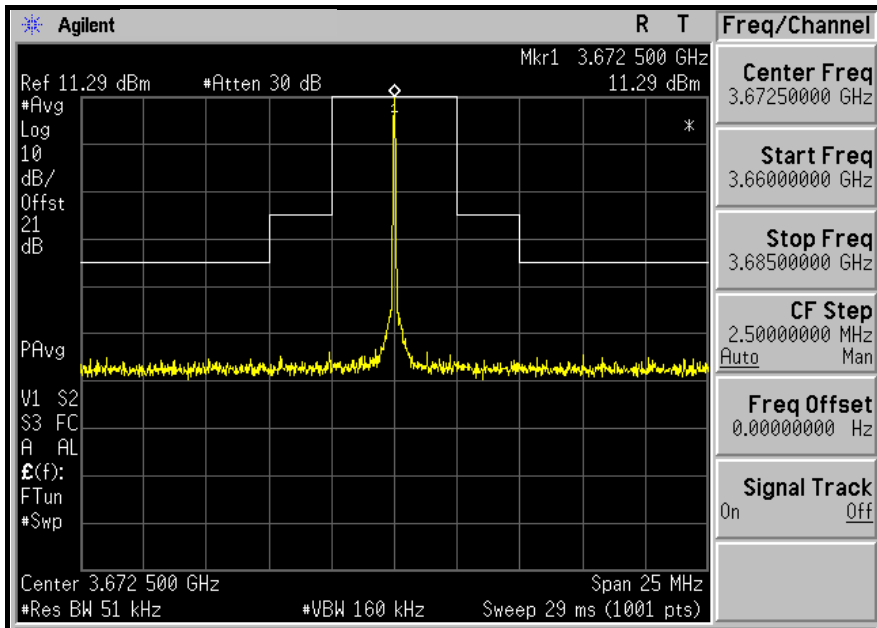



A D T

CHANNEL BANDWIDTH: 7.0MHz
LOW CHANNEL

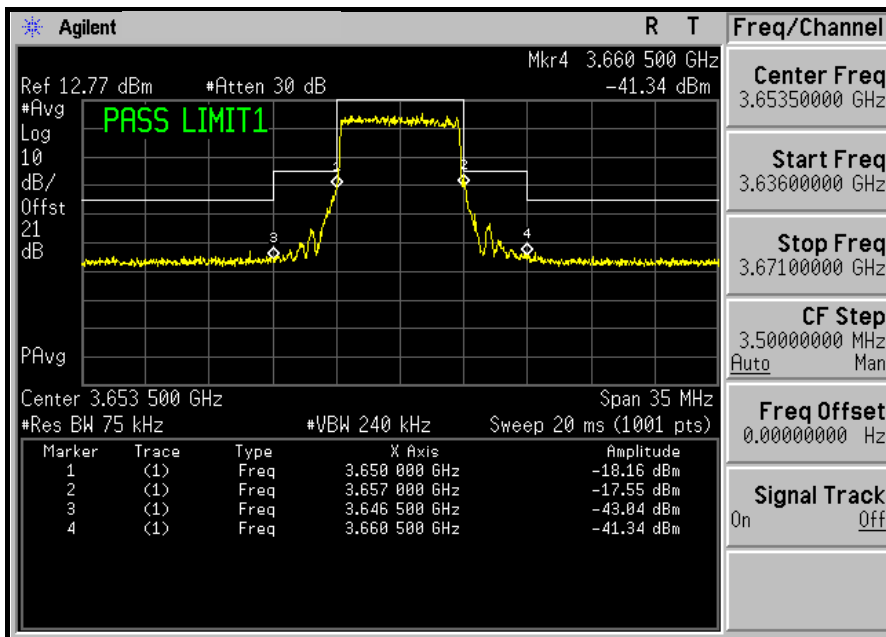
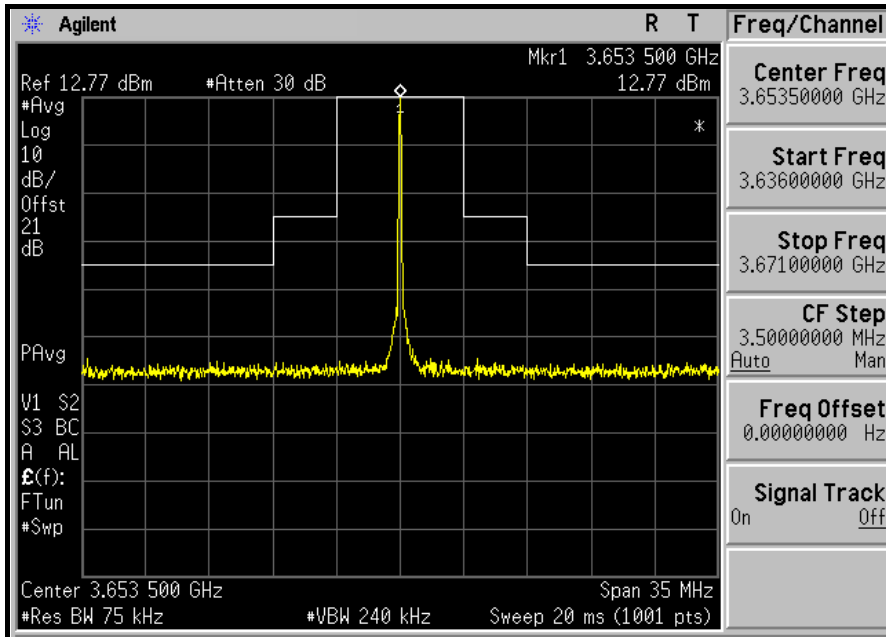



A D T

MIDDLE CHANNEL

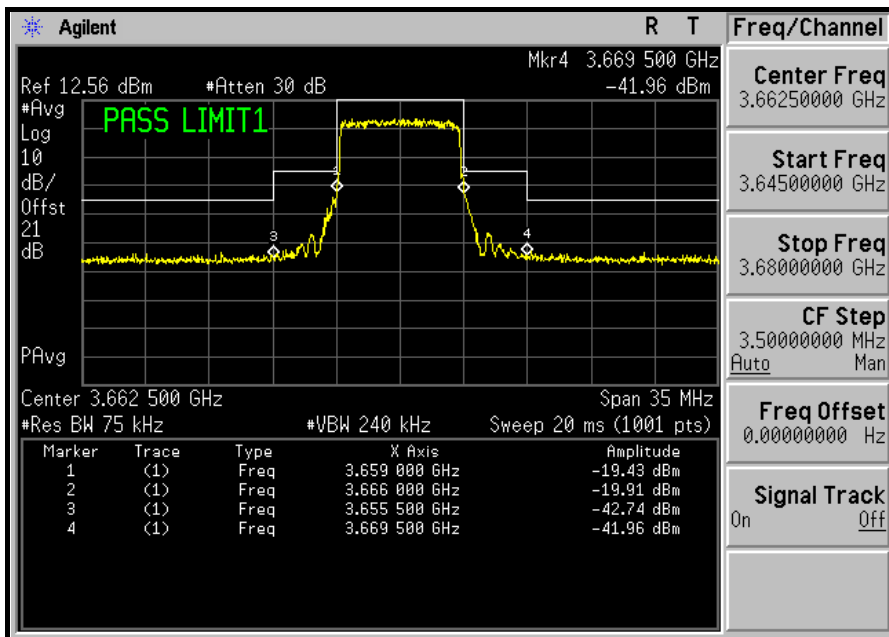
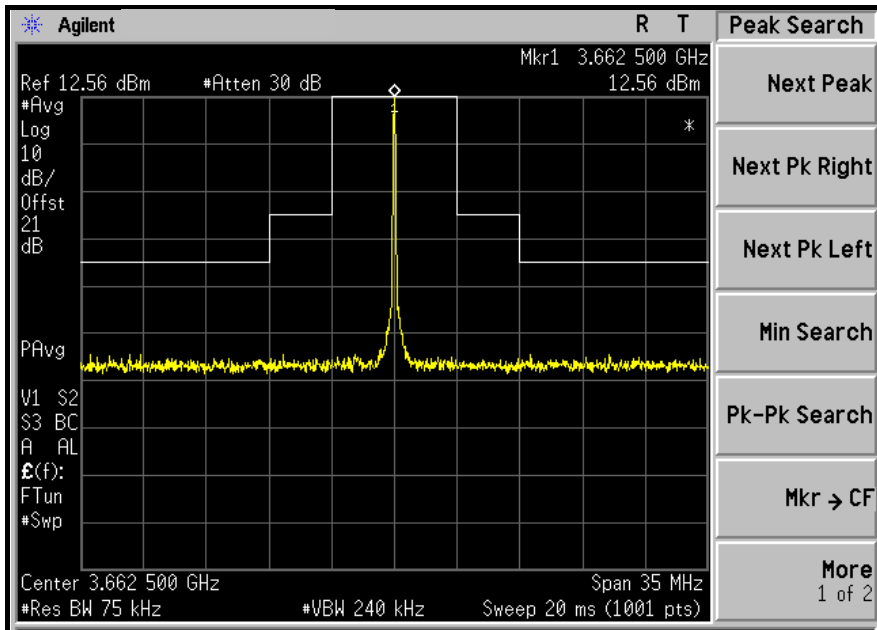



A D T

HIGH CHANNEL

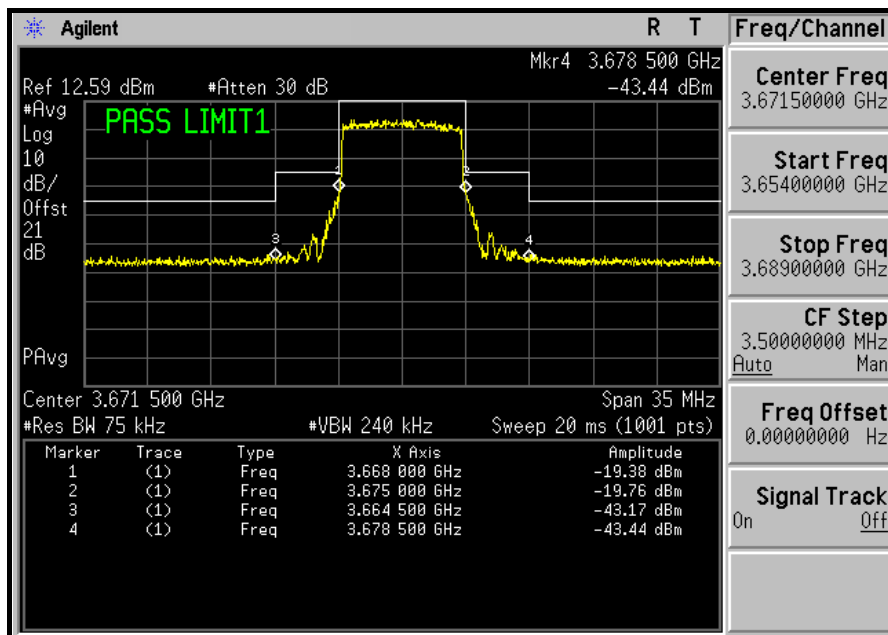
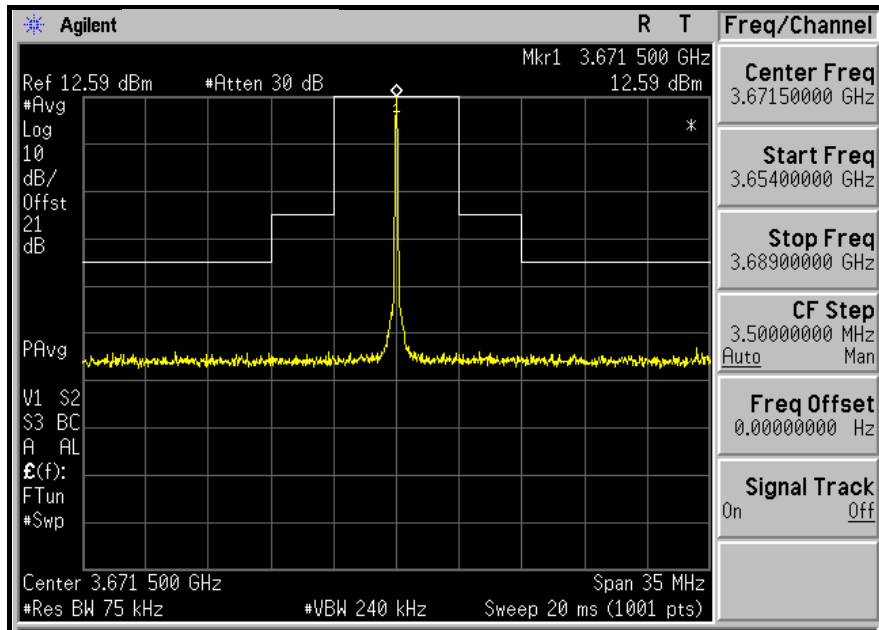



A D T

CHANNEL BANDWIDTH: 10.0MHz
LOW CHANNEL

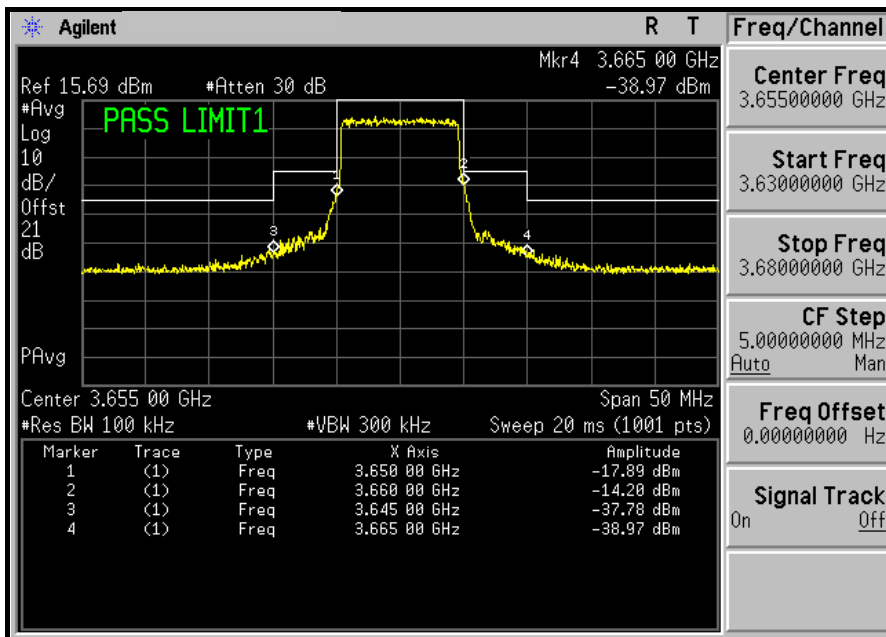
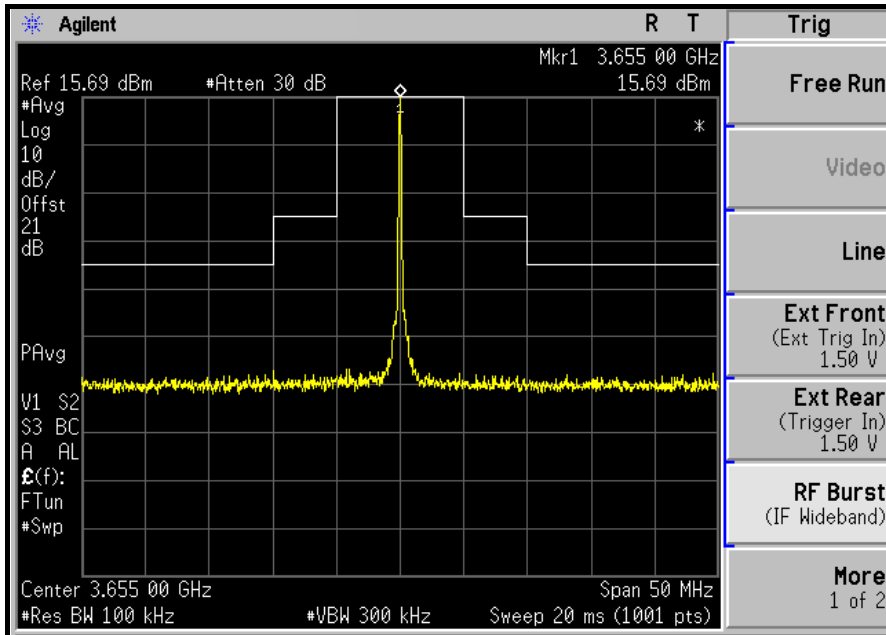



A D T

MIDDLE CHANNEL

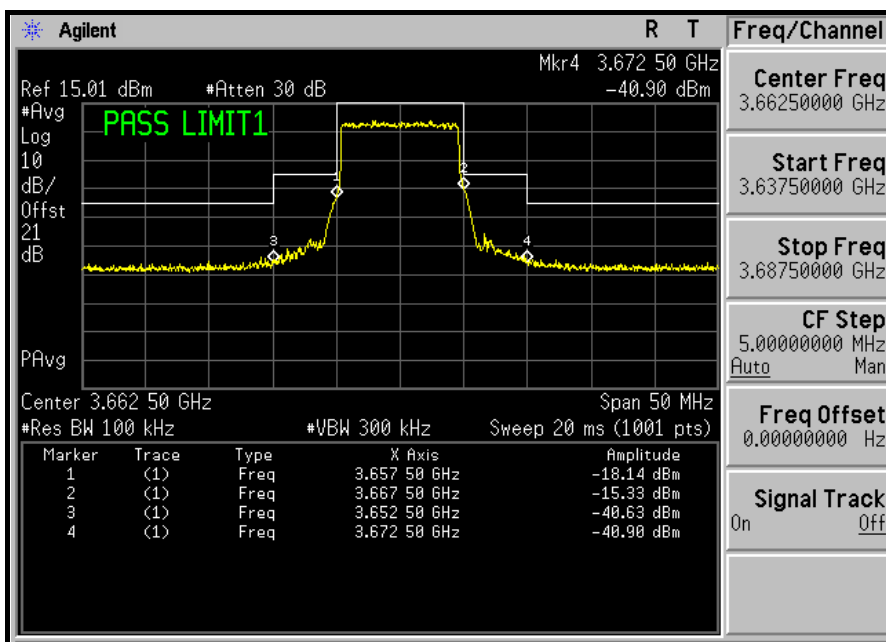
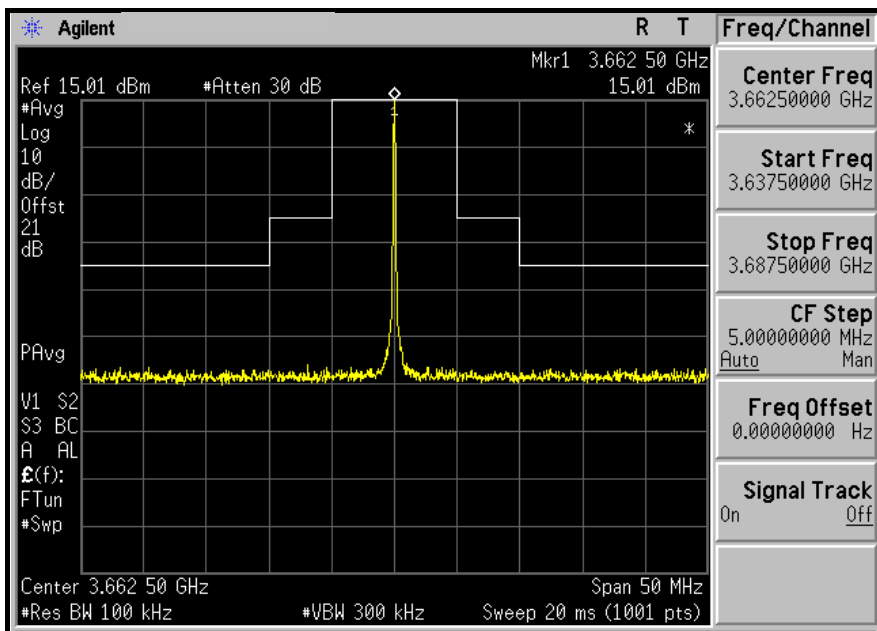



A D T

HIGH CHANNEL

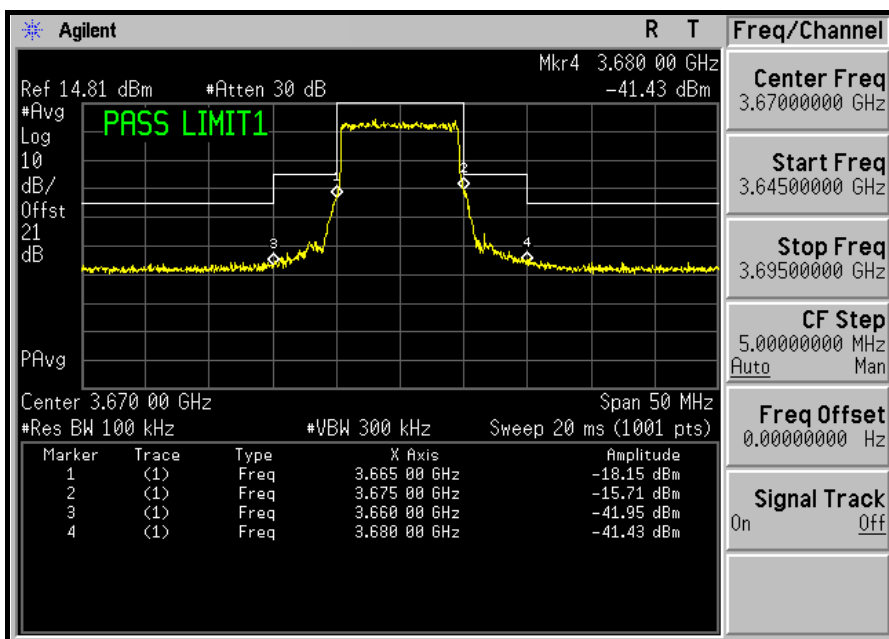
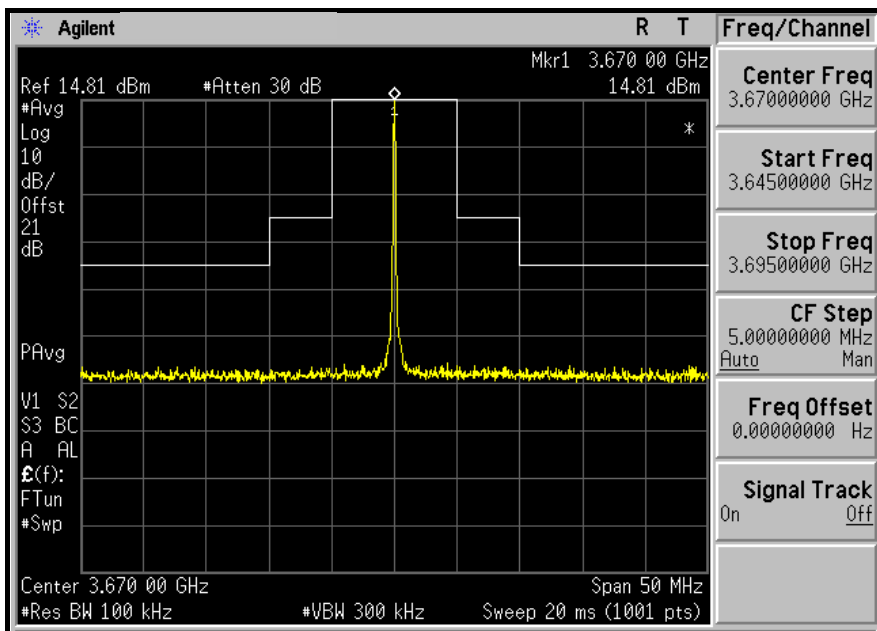

4.5 CONDUCTED SPURIOUS EMISSIONS

4.5.1 LIMITS OF CONDUCTED SPURIOUS EMISSIONS MEASUREMENT

According to FCC 90.1323 specified that the power of any emission outside a licensee's frequency band(s) of operation shall be attenuated below the transmitter power (P) within the licensed band(s) of operation, measured in Watts, by at least $43 + 10 \log (P)$ dB. The limit of emission equal to -13dBm Compliance with this provision is based on the use of measurement instrumentation employing a resolution bandwidth of 1 MHz or less, but at least one percent of the emission bandwidth of the fundamental emission of the transmitter, provided the measured energy is integrated over a 1 MHz bandwidth

4.5.2 TEST INSTRUMENTS

DESCRIPTION & MANUFACTURER	MODEL NO.	SERIAL NO.	DATE OF CALIBRATION	DUE DATE OF CALIBRATION
Spectrum Analyzer Agilent	E4446A	MY44360128	Feb. 23, 2010	Feb. 22, 2011
RF cable	SUCOFLEX 104	257029	Aug. 27, 2010	Aug. 26, 2011
DC-6GHz 20dB 50W Fixed attenuator Woken	MDC9331N-20	0724	May 15, 2010	May 14, 2011
Wainwright Instruments High Pass Filter	WHKX4.5/18G -10SS	NA	NA	NA

NOTE: The calibration interval of the above test instruments is 12 months. And the calibrations are traceable to NML/ROC and NIST/USA.

4.5.3 TEST PROCEDURE

- a. All measurements were done at 3 channels: low, middle and high operational frequency range.
- b. When the spectrum scanned from 30MHz to 4.5GHz, it shall be connected to the 20dB pad attenuated the carried frequency. The spectrum set $RB = 1\text{MHz}$, $VB = 3\text{MHz}$.
- c. When the spectrum scanned from 4.5GHz to 40GHz, it shall be connected to the high pass filter attenuated the carried frequency. The spectrum set $RB = 1\text{MHz}$, $VB = 3\text{MHz}$.

4.5.4 TEST SETUP

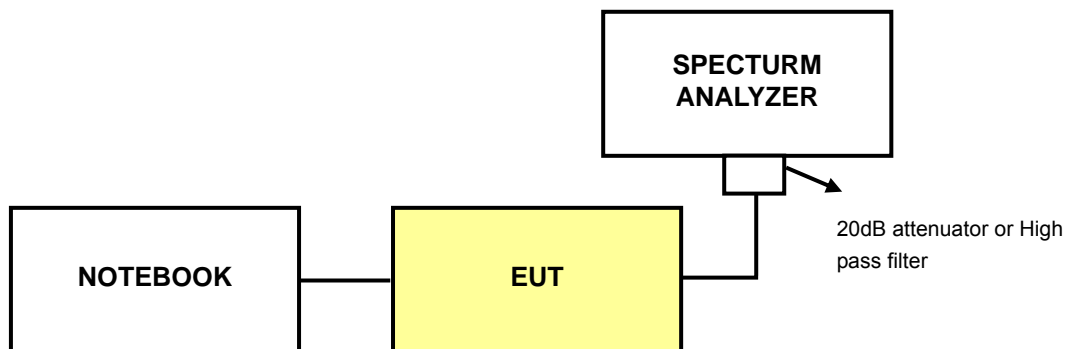

4.5.5 EUT OPERATING CONDITIONS

Same as 4.1.5



A D T

4.5.6 TEST RESULTS

CHANNEL BANDWIDTH	5.0MHz
--------------------------	---------------

LOW CHANNEL

<div style="border: 1px solid black; padding: 5px;"> <p>Agilent R L</p> <p>Ref 21 dBm *Atten 20 dB Mkr1 444.2 MHz -48.42 dBm</p> <p>#PAvg</p> <p>Log 10 dB/Offst 21 dB</p> <p>DI -13.0 dBm</p> <p>Start 30.0 MHz Stop 1.000 0 GHz</p> <p>*Res BW 1 MHz *VBW 3 MHz Sweep 20 ms (1001 pts)</p> <table border="1" style="width: 100%; font-size: small;"> <thead> <tr> <th>Marker</th> <th>Trace</th> <th>Type</th> <th>X Axis</th> <th>Amplitude</th> </tr> </thead> <tbody> <tr> <td>1</td> <td>(1)</td> <td></td> <td>444.2 MHz</td> <td>-48.42 dBm</td> </tr> </tbody> </table> </div>	Marker	Trace	Type	X Axis	Amplitude	1	(1)		444.2 MHz	-48.42 dBm	<div style="border: 1px solid black; padding: 5px;"> <p>Agilent R L</p> <p>Ref 21 dBm *Atten 20 dB Mkr1 3.572 GHz -46.78 dBm</p> <p>#PAvg</p> <p>Log 10 dB/Offst 21 dB</p> <p>DI -13.0 dBm</p> <p>Start 1.000 GHz Stop 4.500 GHz</p> <p>*Res BW 1 MHz *VBW 3 MHz Sweep 35 ms (1001 pts)</p> <table border="1" style="width: 100%; font-size: small;"> <thead> <tr> <th>Marker</th> <th>Trace</th> <th>Type</th> <th>X Axis</th> <th>Amplitude</th> </tr> </thead> <tbody> <tr> <td>1</td> <td>(1)</td> <td></td> <td>3.572 GHz</td> <td>-46.78 dBm</td> </tr> </tbody> </table> </div>	Marker	Trace	Type	X Axis	Amplitude	1	(1)		3.572 GHz	-46.78 dBm
Marker	Trace	Type	X Axis	Amplitude																	
1	(1)		444.2 MHz	-48.42 dBm																	
Marker	Trace	Type	X Axis	Amplitude																	
1	(1)		3.572 GHz	-46.78 dBm																	
<div style="border: 1px solid black; padding: 5px;"> <p>Agilent R L</p> <p>Ref 21 dBm *Atten 20 dB Mkr1 7.734 GHz -43.21 dBm</p> <p>#PAvg</p> <p>Log 10 dB/Offst 21 dB</p> <p>DI -13.0 dBm</p> <p>Start 4.500 GHz Stop 10.000 GHz</p> <p>*Res BW 1 MHz *VBW 3 MHz Sweep 55 ms (1001 pts)</p> <table border="1" style="width: 100%; font-size: small;"> <thead> <tr> <th>Marker</th> <th>Trace</th> <th>Type</th> <th>X Axis</th> <th>Amplitude</th> </tr> </thead> <tbody> <tr> <td>1</td> <td>(1)</td> <td></td> <td>7.734 GHz</td> <td>-43.21 dBm</td> </tr> </tbody> </table> </div>	Marker	Trace	Type	X Axis	Amplitude	1	(1)		7.734 GHz	-43.21 dBm	<div style="border: 1px solid black; padding: 5px;"> <p>Agilent R L</p> <p>Ref 21 dBm *Atten 20 dB Mkr1 19.92 GHz -41.79 dBm</p> <p>#PAvg</p> <p>Log 10 dB/Offst 21 dB</p> <p>DI -13.0 dBm</p> <p>Start 10.00 GHz Stop 20.00 GHz</p> <p>*Res BW 1 MHz *VBW 3 MHz Sweep 100 ms (1001 pts)</p> <table border="1" style="width: 100%; font-size: small;"> <thead> <tr> <th>Marker</th> <th>Trace</th> <th>Type</th> <th>X Axis</th> <th>Amplitude</th> </tr> </thead> <tbody> <tr> <td>1</td> <td>(1)</td> <td></td> <td>19.92 GHz</td> <td>-41.79 dBm</td> </tr> </tbody> </table> </div>	Marker	Trace	Type	X Axis	Amplitude	1	(1)		19.92 GHz	-41.79 dBm
Marker	Trace	Type	X Axis	Amplitude																	
1	(1)		7.734 GHz	-43.21 dBm																	
Marker	Trace	Type	X Axis	Amplitude																	
1	(1)		19.92 GHz	-41.79 dBm																	
<div style="border: 1px solid black; padding: 5px;"> <p>Agilent R L</p> <p>Ref 21 dBm *Atten 20 dB Mkr1 25.41 GHz -38.54 dBm</p> <p>#PAvg</p> <p>Log 10 dB/Offst 21 dB</p> <p>DI -13.0 dBm</p> <p>Start 20.00 GHz Stop 30.00 GHz</p> <p>*Res BW 1 MHz *VBW 3 MHz Sweep 100 ms (1001 pts)</p> <table border="1" style="width: 100%; font-size: small;"> <thead> <tr> <th>Marker</th> <th>Trace</th> <th>Type</th> <th>X Axis</th> <th>Amplitude</th> </tr> </thead> <tbody> <tr> <td>1</td> <td>(1)</td> <td></td> <td>25.41 GHz</td> <td>-38.54 dBm</td> </tr> </tbody> </table> </div>	Marker	Trace	Type	X Axis	Amplitude	1	(1)		25.41 GHz	-38.54 dBm	<div style="border: 1px solid black; padding: 5px;"> <p>Agilent R L</p> <p>Ref 21 dBm *Atten 20 dB Mkr1 37.13 GHz -30.51 dBm</p> <p>#PAvg</p> <p>Log 10 dB/Offst 21 dB</p> <p>DI -13.0 dBm</p> <p>Start 30.00 GHz Stop 40.00 GHz</p> <p>*Res BW 1 MHz *VBW 3 MHz Sweep 100 ms (1001 pts)</p> <table border="1" style="width: 100%; font-size: small;"> <thead> <tr> <th>Marker</th> <th>Trace</th> <th>Type</th> <th>X Axis</th> <th>Amplitude</th> </tr> </thead> <tbody> <tr> <td>1</td> <td>(1)</td> <td></td> <td>37.13 GHz</td> <td>-30.51 dBm</td> </tr> </tbody> </table> </div>	Marker	Trace	Type	X Axis	Amplitude	1	(1)		37.13 GHz	-30.51 dBm
Marker	Trace	Type	X Axis	Amplitude																	
1	(1)		25.41 GHz	-38.54 dBm																	
Marker	Trace	Type	X Axis	Amplitude																	
1	(1)		37.13 GHz	-30.51 dBm																	



A D T

CHANNEL BANDWIDTH

5.0MHz

MIDDLE CHANNEL

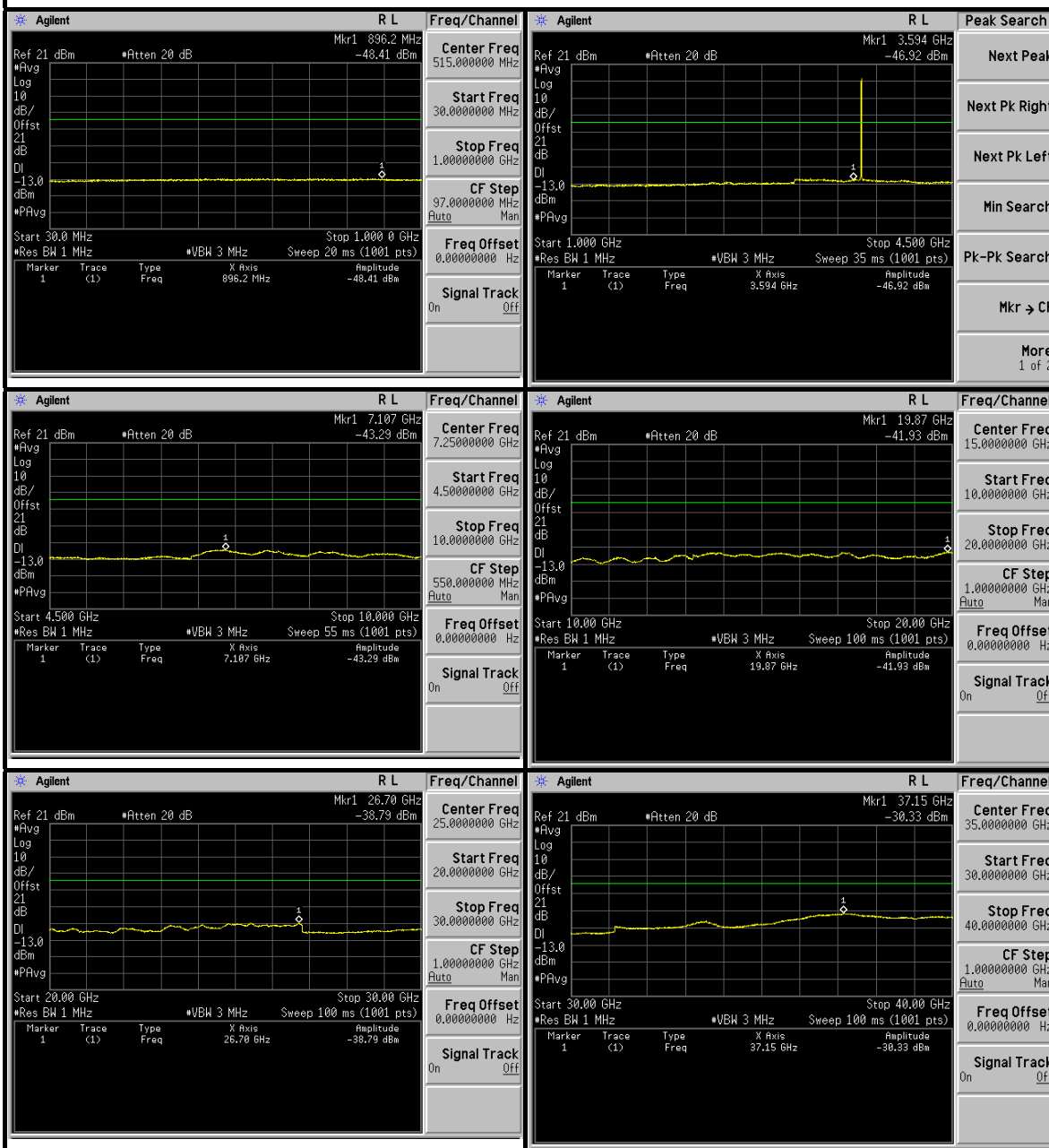



A D T

CHANNEL BANDWIDTH

5.0MHz

HIGH CHANNEL

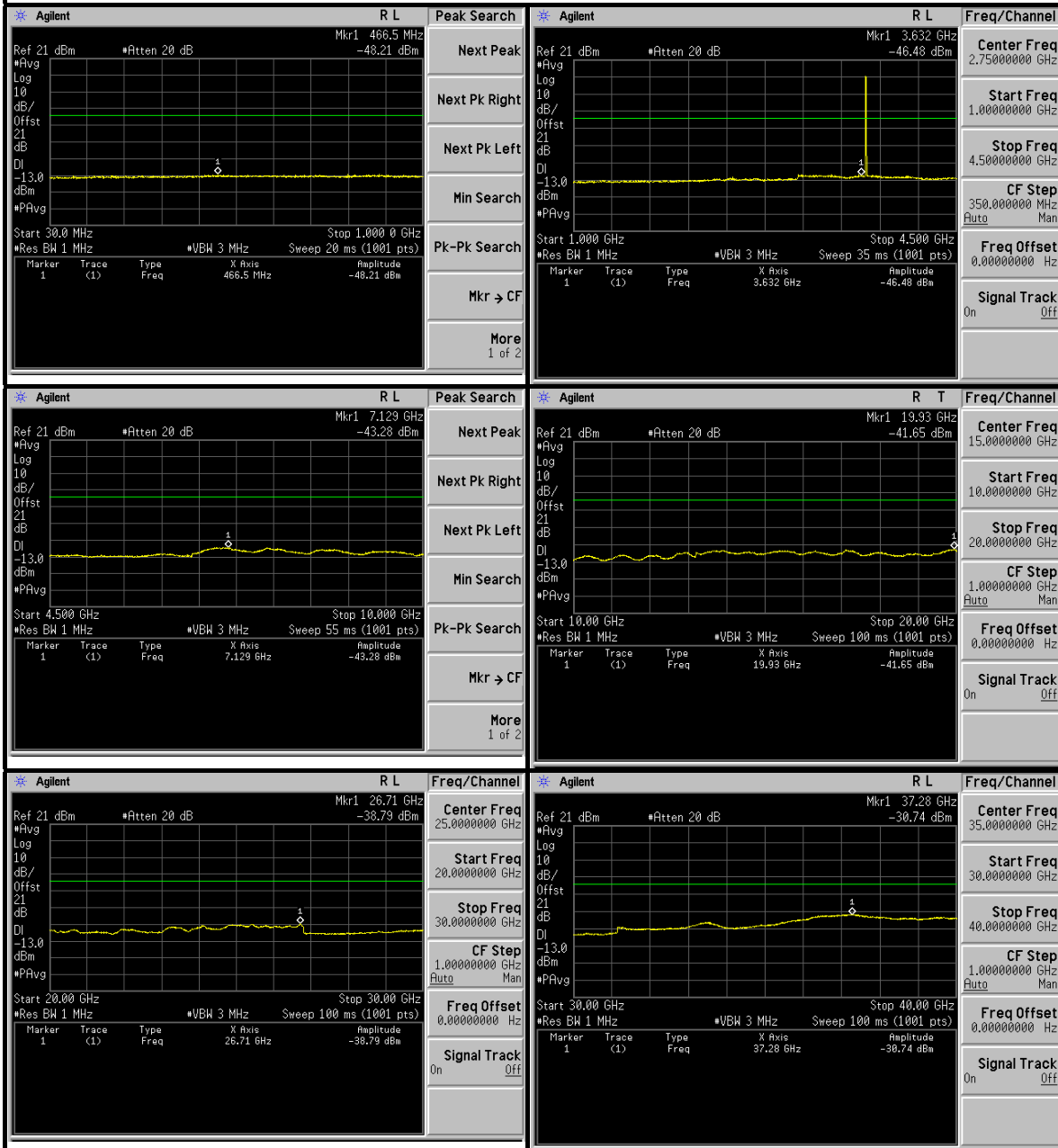



A D T

CHANNEL BANDWIDTH

7.0MHz

LOW CHANNEL

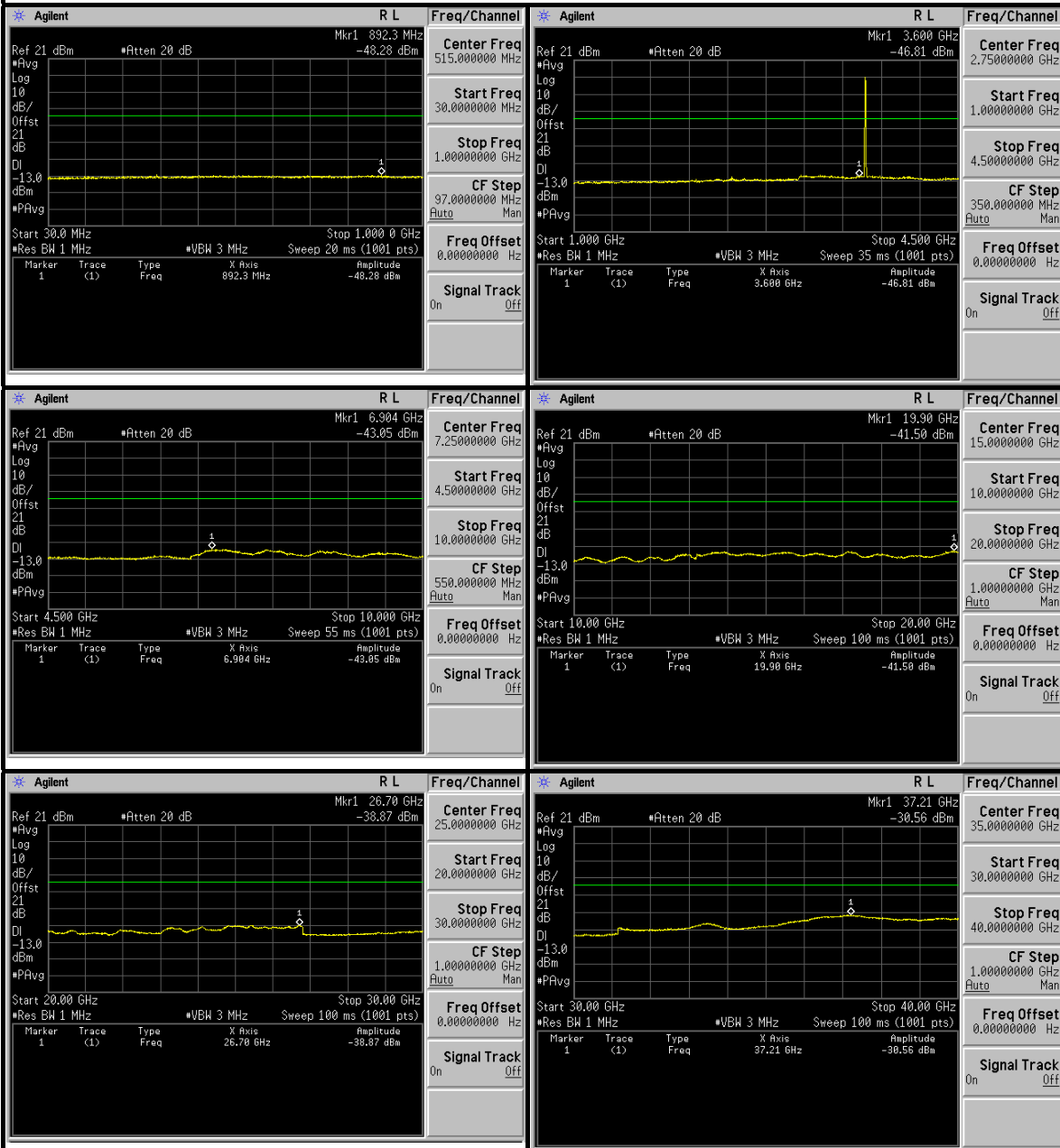



A D T

CHANNEL BANDWIDTH

7.0MHz

MIDDLE CHANNEL

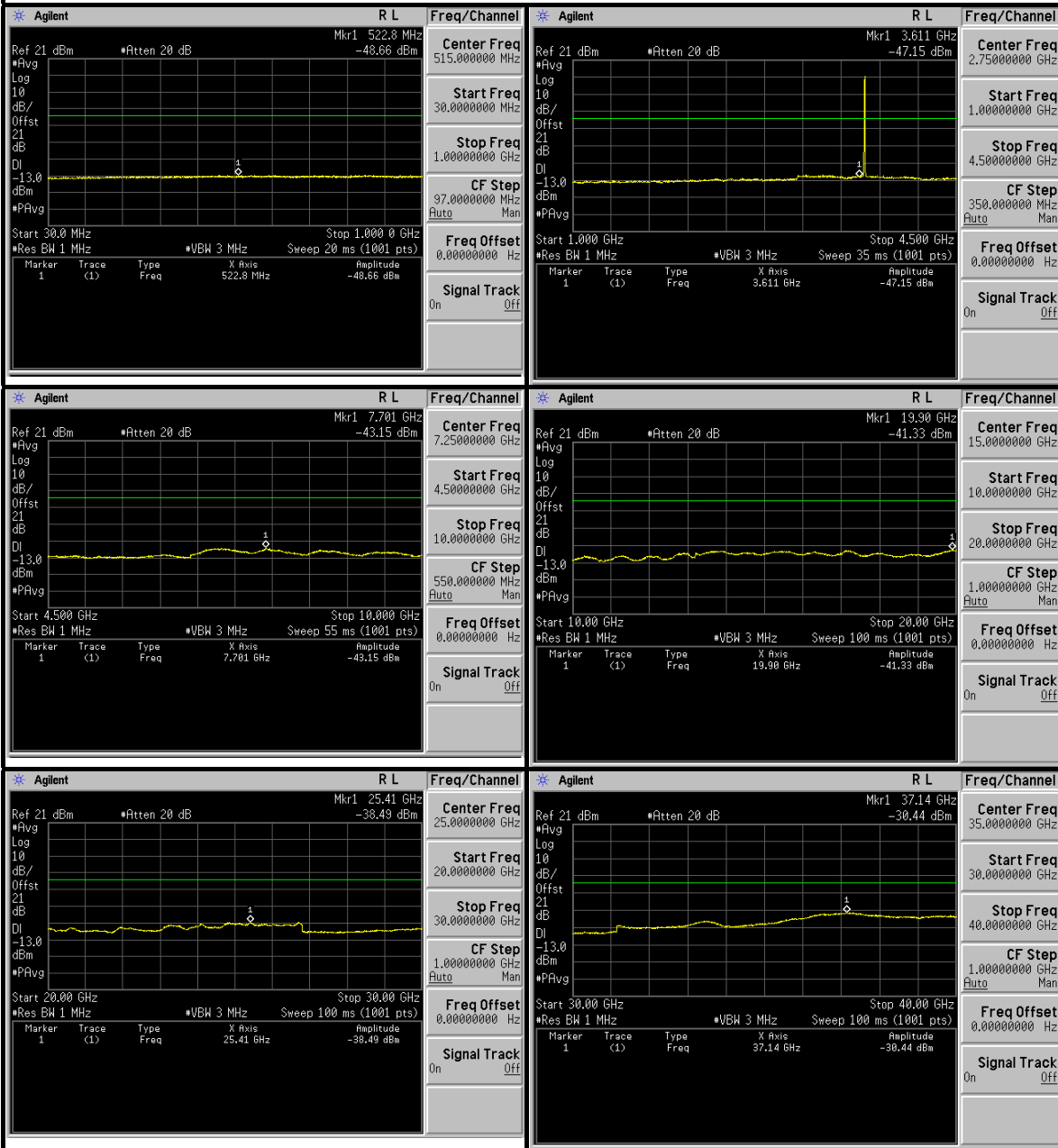



A D T

CHANNEL BANDWIDTH

7.0MHz

HIGH CHANNEL

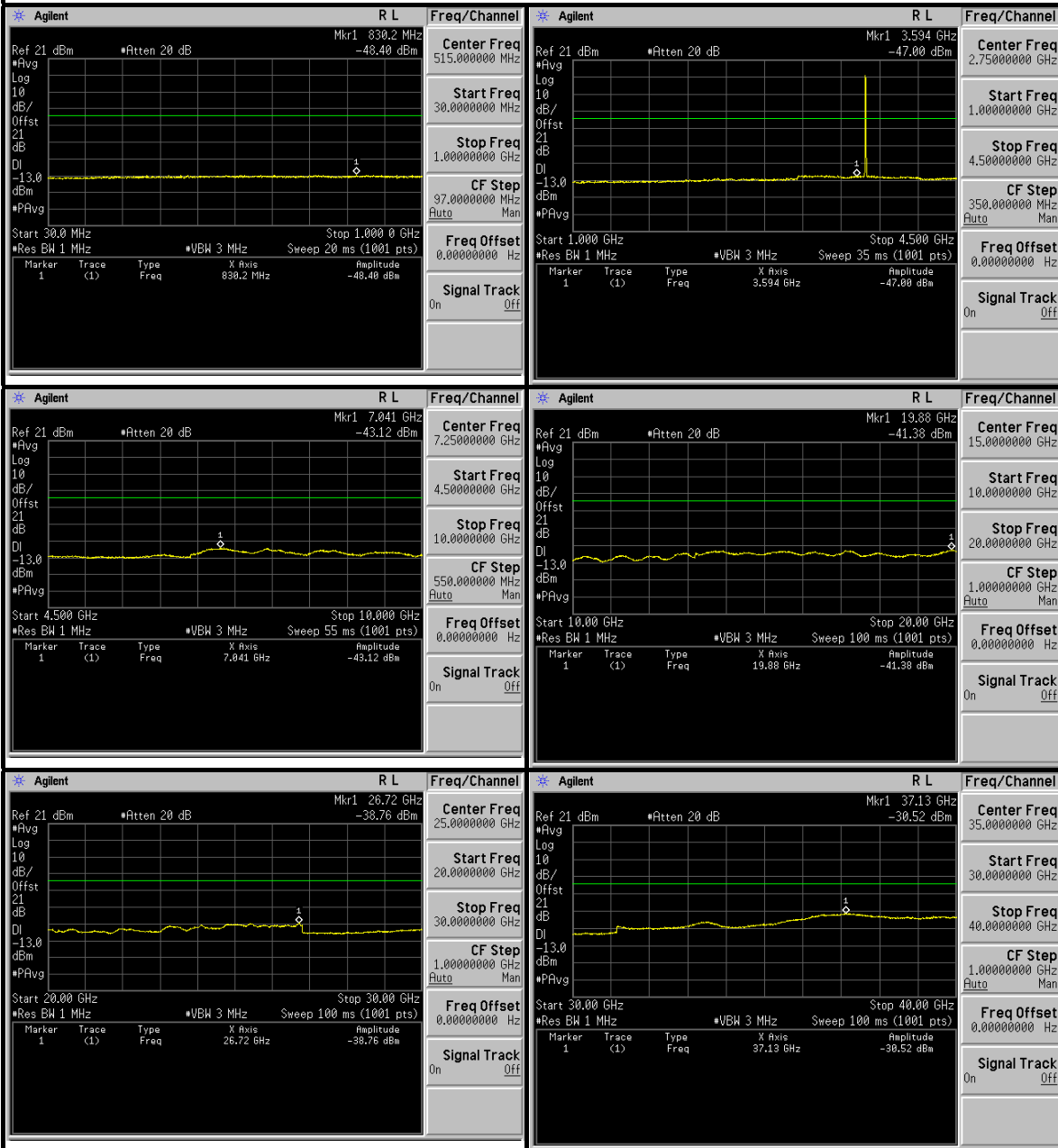



A D T

CHANNEL BANDWIDTH

10.0MHz

LOW CHANNEL

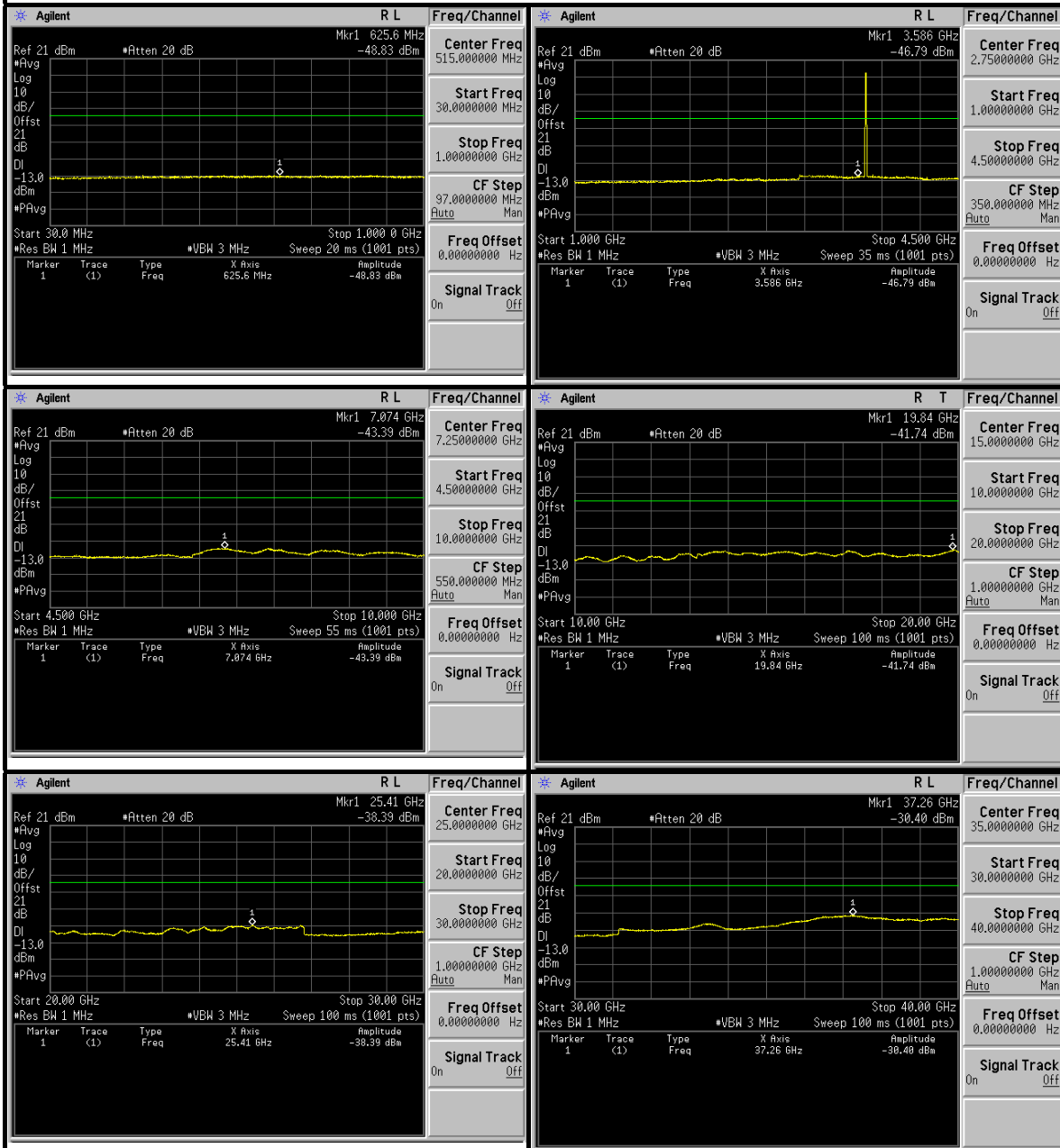



A D T

CHANNEL BANDWIDTH

10.0MHz

MIDDLE CHANNEL

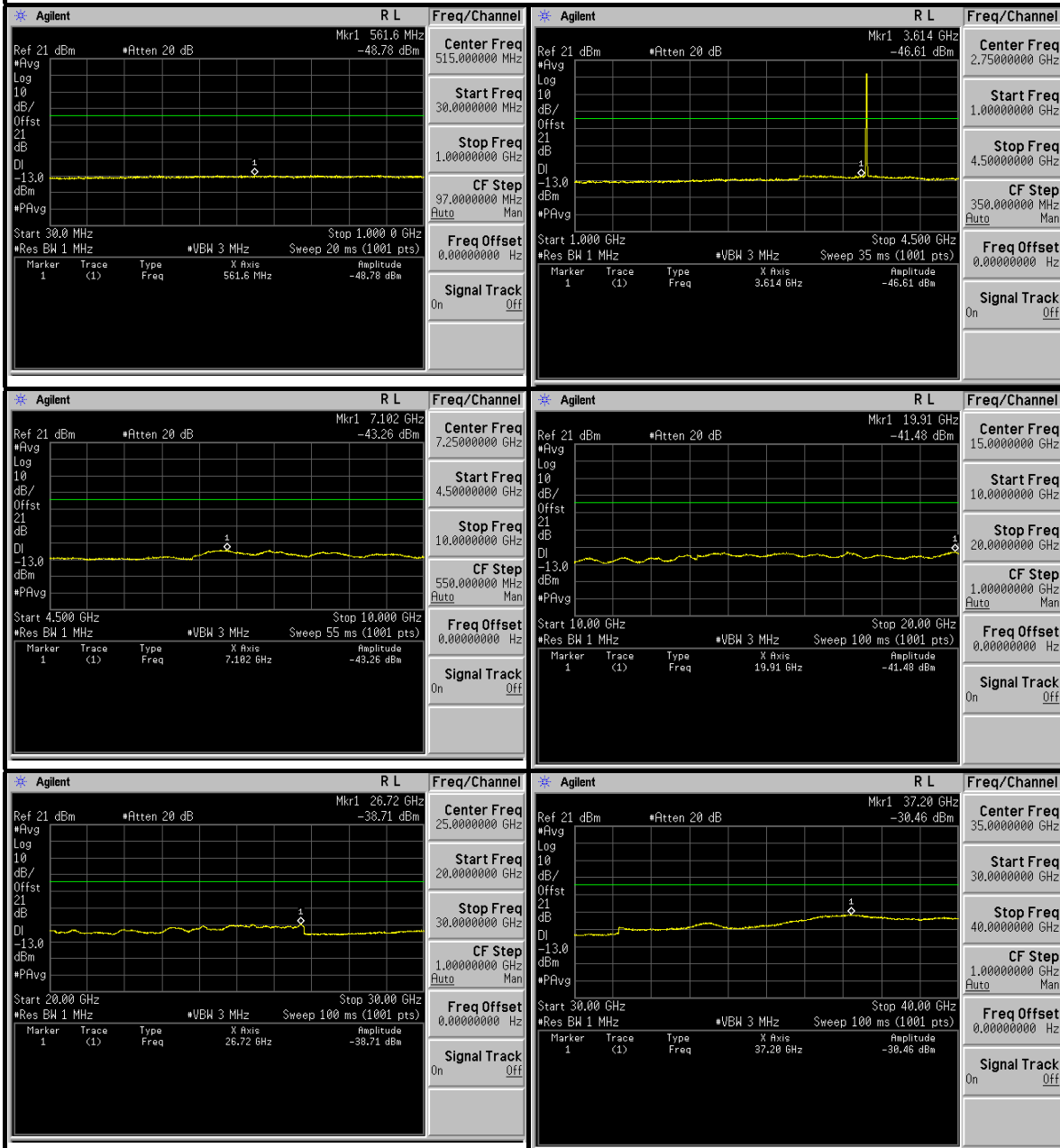



A D T

CHANNEL BANDWIDTH

10.0MHz

HIGH CHANNEL

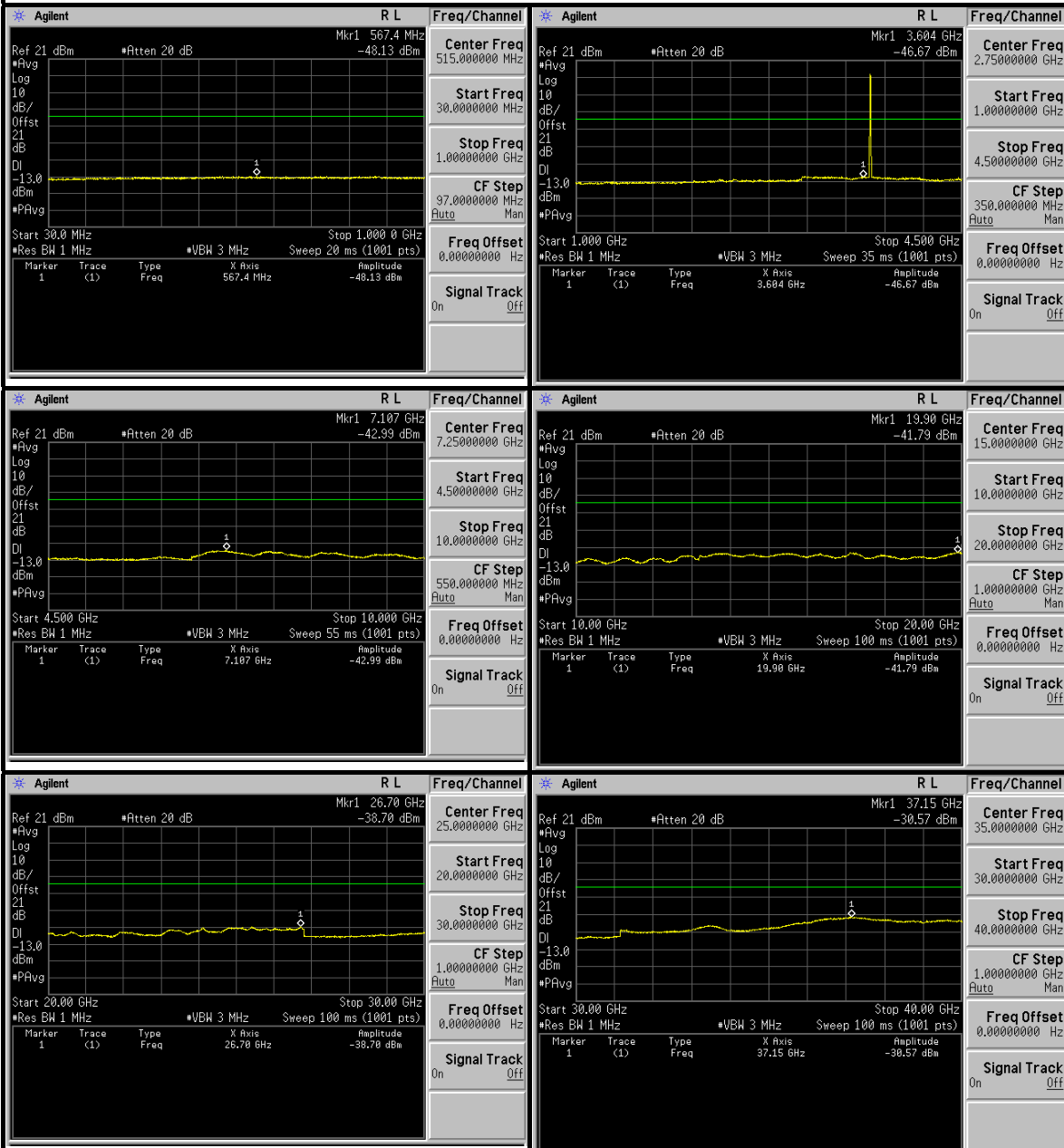

4.6 RADIATED EMISSION MEASUREMENT (BELOW 1GHz)

4.6.1 LIMITS OF RADIATED EMISSION MEASUREMENT

According to FCC 90.1323 specified that the power of any emission outside a licensee's frequency band(s) of operation shall be attenuated below the transmitter power (P) within the licensed band(s) of operation, measured in Watts, by at least $43 + 10 \log (P)$ dB. The limit of emission equal to -13dBm Compliance with this provision is based on the use of measurement instrumentation employing a resolution bandwidth of 1 MHz or less, but at least one percent of the emission bandwidth of the fundamental emission of the transmitter, provided the measured energy is integrated over a 1 MHz bandwidth.

4.6.2 TEST INSTRUMENTS

DESCRIPTION & MANUFACTURER	MODEL NO.	SERIAL NO.	DATE OF CALIBRATION	DUE DATE OF CALIBRATION
Test Receiver ROHDE & SCHWARZ	ESIB7	100188	Dec. 21, 2009	Dec. 20, 2010
Spectrum Analyzer ROHDE & SCHWARZ	FSP40	100041	Jul. 09, 2010	Jul. 08, 2011
BILOG Antenna SCHWARZBECK	VULB9168	9168-156	Apr. 30, 2010	Apr. 29, 2011
HORN Antenna SCHWARZBECK	BBHA 9120 D	9120D-209	Aug. 02, 2010	Aug. 01, 2011
HORN Antenna SCHWARZBECK	BBHA 9170	BBHA9170242	Dec. 25, 2009	Dec. 24, 2010
Preamplifier Agilent	8449B	3008A01910	Sep. 09, 2010	Sep. 08, 2011
Preamplifier Agilent	8447D	2944A10638	Dec. 21, 2009	Dec. 20, 2010
RF signal cable HUBER+SUHNNER	SUCOFLEX 104	218190/4 231241/4	May 14, 2010	May 13, 2011
RF signal cable Worken	8D-FB	Cable-HYCH9-01	Aug. 20, 2010	Aug. 19, 2011
Software	ADT_Radiated_ V7.6.15.9.2	NA	NA	NA
Antenna Tower EMCO	2070/2080	512.835.4684	NA	NA
Turn Table EMCO	2087-2.03	NA	NA	NA
Antenna Tower & Turn Table Controller EMCO	2090	NA	NA	NA

- NOTE:**
1. The calibration interval of the above test instruments is 12 months and the calibrations are traceable to NML/ROC and NIST/USA.
 2. The test was performed in HwaYa Chamber 9.
 3. The horn antenna and HP preamplifier (model: 8449B) are used only for the measurement of emission frequency above 1GHz if tested.
 4. The FCC Site Registration No. is 460141.
 5. The IC Site Registration No. is IC 7450F-4.

4.6.3 TEST PROCEDURES

- a. Substitution method is used for E.I.R.P measurement. In the semi-anechoic chamber, EUT placed on the 0.8m height of Turn Table, rotated the table around 360 degrees to search the maximum radiation power and receiver antenna shall be rotated vertical and horizontal polarization and moved height from 1m to 4m to find the maximum polar radiated power. The “Read Value” is the spectrum reading the maximum power value.
- b. The substitution antenna is substituted for EUT at the same position and signals generator export the CW signal to the substitution antenna via a tx cable . Rotated the Turn Table and moved receiving antenna to find the maximum radiation power. Adjust output power level of S.G to get a Value of spectrum reading equal to “Read Value “ of step a. Record the power level of S.G

EIRP = Output power level of S.G – TX cable loss + Antenna gain of Substitution antenna

NOTE: The resolution bandwidth of spectrum analyzer is 1 MHz and the video bandwidth is 3 MHz.

4.6.4 DEVIATION FROM TEST STANDARD

No deviation

4.6.5 TEST SETUP

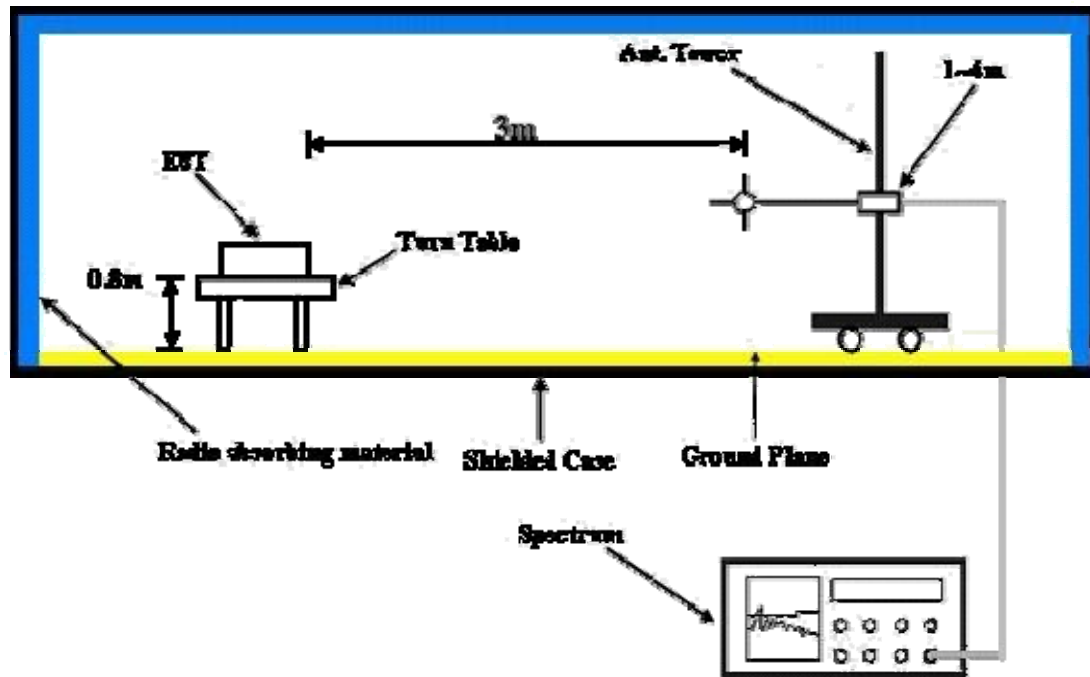

For the actual test configuration, please refer to the related item – Photographs of the Test Configuration.

4.6.6 EUT OPERATING CONDITIONS

Same as 4.1.5.



A D T

4.6.7 TEST RESULTS

BELOW 1GHz WORST-CASE DATA

MODE	Low channel	CHANNEL BANDWIDTH	5.0MHz
TEST MODE	A		

ANTENNA POLARITY & TEST DISTANCE: HORIZONTAL AT 3m						
NO.	FREQ. (MHz)	EMISSION LEVEL (dBuV)	LIMIT (dBm)	S.G POWER VALUE (dBm)	CORRECTION FACTOR (dB)	POWER VALUE (dBm)
1	43.61	54.4	-13.0	-32.1	-7.7	-39.8
2	92.20	56.3	-13.0	-30.5	-7.7	-38.2
3	158.30	54.3	-13.0	-32.8	-7.7	-40.5
4	234.11	56.4	-13.0	-29.7	-7.7	-37.4
5	292.42	48.4	-13.0	-38.5	-7.7	-46.2
6	475.15	47.2	-13.0	-39.4	-7.8	-47.2

ANTENNA POLARITY & TEST DISTANCE: VERTICAL AT 3m						
NO.	FREQ. (MHz)	EMISSION LEVEL (dBuV/m)	LIMIT (dBm)	S.G POWER VALUE (dBm)	CORRECTION FACTOR (dB)	POWER VALUE (dBm)
1	43.61	67.1	-13.0	-19.6	-7.7	-27.3
2	142.75	51.7	-13.0	-35.0	-7.7	-42.7
3	195.23	51.5	-13.0	-35.1	-7.7	-42.8
4	304.09	57.0	-13.0	-29.2	-7.8	-37.0
5	500.42	42.7	-13.0	-43.6	-7.8	-51.4
6	585.95	44.7	-13.0	-41.9	-7.8	-49.7

NOTE: Power Value (dBum) = S.G Power Value (dBm) + Correction Factor (dB).



A D T

MODE	Low channel	CHANNEL BANDWIDTH	5.0MHz
TEST MODE	B		

ANTENNA POLARITY & TEST DISTANCE: HORIZONTAL AT 3m

NO.	FREQ. (MHz)	EMISSION LEVEL (dBuV)	LIMIT (dBm)	S.G POWER VALUE (dBm)	CORRECTION FACTOR (dB)	POWER VALUE (dBm)
1	101.92	51.0	-13.0	-36.1	-7.7	-43.8
2	185.51	48.7	-13.0	-38.3	-7.7	-46.0
3	243.83	46.5	-13.0	-39.7	-7.7	-47.4
4	306.03	46.7	-13.0	-40.0	-7.8	-47.8
5	409.06	48.2	-13.0	-37.9	-7.8	-45.7
6	677.31	44.0	-13.0	-42.6	-7.8	-50.4

ANTENNA POLARITY & TEST DISTANCE: VERTICAL AT 3m

NO.	FREQ. (MHz)	EMISSION LEVEL (dBuV/m)	LIMIT (dBm)	S.G POWER VALUE (dBm)	CORRECTION FACTOR (dB)	POWER VALUE (dBm)
1	39.72	61.6	-13.0	-25.0	-7.7	-32.7
2	101.92	56.0	-13.0	-30.3	-7.7	-38.0
3	168.02	54.7	-13.0	-32.0	-7.7	-39.7
4	302.14	45.3	-13.0	-41.0	-7.8	-48.8
5	442.10	46.3	-13.0	-40.3	-7.8	-48.1
6	677.31	42.1	-13.0	-44.1	-7.8	-51.9

NOTE: Power Value (dBum) = S.G Power Value (dBm) + Correction Factor (dB).



A D T

MODE	Low channel	CHANNEL BANDWIDTH	7.0MHz
TEST MODE	A		

ANTENNA POLARITY & TEST DISTANCE: HORIZONTAL AT 3m

NO.	FREQ. (MHz)	EMISSION LEVEL (dBuV)	LIMIT (dBm)	S.G POWER VALUE (dBm)	CORRECTION FACTOR (dB)	POWER VALUE (dBm)
1	43.61	53.7	-13.0	-33.4	-7.7	-41.1
2	90.26	55.3	-13.0	-31.7	-7.7	-39.4
3	154.41	53.7	-13.0	-32.6	-7.7	-40.3
4	191.34	52.6	-13.0	-34.5	-7.7	-42.2
5	292.42	48.5	-13.0	-38.2	-7.7	-45.9
6	424.61	43.4	-13.0	-43.2	-7.8	-51.0

ANTENNA POLARITY & TEST DISTANCE: VERTICAL AT 3m

NO.	FREQ. (MHz)	EMISSION LEVEL (dBuV/m)	LIMIT (dBm)	S.G POWER VALUE (dBm)	CORRECTION FACTOR (dB)	POWER VALUE (dBm)
1	41.66	67.4	-13.0	-19.6	-7.7	-27.3
2	146.63	51.8	-13.0	-34.9	-7.7	-42.6
3	191.34	53.5	-13.0	-33.9	-7.7	-41.6
4	290.48	46.3	-13.0	-40.6	-7.7	-48.3
5	401.28	41.2	-13.0	-45.4	-7.8	-53.2
6	636.49	40.0	-13.0	-46.8	-7.8	-54.6

NOTE: Power Value (dBum) = S.G Power Value (dBm) + Correction Factor (dB).



A D T

MODE	Low channel	CHANNEL BANDWIDTH	7.0MHz
TEST MODE	B		

ANTENNA POLARITY & TEST DISTANCE: HORIZONTAL AT 3m

NO.	FREQ. (MHz)	EMISSION LEVEL (dBuV)	LIMIT (dBm)	S.G POWER VALUE (dBm)	CORRECTION FACTOR (dB)	POWER VALUE (dBm)
1	101.92	51.0	-13.0	-35.8	-7.7	-43.5
2	156.35	49.4	-13.0	-37.7	-7.7	-45.4
3	239.94	48.3	-13.0	-38.6	-7.7	-46.3
4	399.34	40.3	-13.0	-45.9	-7.8	-53.7
5	688.98	44.2	-13.0	-42.1	-7.8	-49.9
6	836.71	42.7	-13.0	-44.1	-7.9	-52.0

ANTENNA POLARITY & TEST DISTANCE: VERTICAL AT 3m

NO.	FREQ. (MHz)	EMISSION LEVEL (dBuV/m)	LIMIT (dBm)	S.G POWER VALUE (dBm)	CORRECTION FACTOR (dB)	POWER VALUE (dBm)
1	39.72	61.8	-13.0	-24.9	-7.7	-32.6
2	101.92	56.4	-13.0	-30.6	-7.7	-38.3
3	181.62	50.6	-13.0	-35.8	-7.7	-43.5
4	304.09	44.7	-13.0	-41.7	-7.8	-49.5
5	675.37	42.5	-13.0	-44.4	-7.8	-52.2
6	834.77	44.2	-13.0	-42.2	-7.9	-50.1

NOTE: Power Value (dBum) = S.G Power Value (dBm) + Correction Factor (dB).



A D T

MODE	Low channel	CHANNEL BANDWIDTH	10.0MHz
TEST MODE	A		

ANTENNA POLARITY & TEST DISTANCE: HORIZONTAL AT 3m

NO.	FREQ. (MHz)	EMISSION LEVEL (dBuV)	LIMIT (dBm)	S.G POWER VALUE (dBm)	CORRECTION FACTOR (dB)	POWER VALUE (dBm)
1	90.26	55.8	-13.0	-30.6	-7.7	-38.3
2	158.30	54.1	-13.0	-32.5	-7.7	-40.2
3	191.34	52.4	-13.0	-33.9	-7.7	-41.6
4	290.48	48.1	-13.0	-38.7	-7.7	-46.4
5	426.55	44.6	-13.0	-42.2	-7.8	-50.0
6	906.69	52.1	-13.0	-34.1	-7.9	-42.0

ANTENNA POLARITY & TEST DISTANCE: VERTICAL AT 3m

NO.	FREQ. (MHz)	EMISSION LEVEL (dBuV/m)	LIMIT (dBm)	S.G POWER VALUE (dBm)	CORRECTION FACTOR (dB)	POWER VALUE (dBm)
1	41.66	68.4	-13.0	-18.6	-7.7	-26.3
2	144.69	51.5	-13.0	-35.3	-7.7	-43.0
3	193.29	50.0	-13.0	-37.0	-7.7	-44.7
4	292.42	46.4	-13.0	-40.6	-7.7	-48.3
5	426.55	41.0	-13.0	-46.0	-7.8	-53.8
6	500.42	43.4	-13.0	-43.6	-7.8	-51.4

NOTE: Power Value (dBum) = S.G Power Value (dBm) + Correction Factor (dB).



A D T

MODE	Low channel	CHANNEL BANDWIDTH	10.0MHz
TEST MODE	B		

ANTENNA POLARITY & TEST DISTANCE: HORIZONTAL AT 3m						
NO.	FREQ. (MHz)	EMISSION LEVEL (dBuV)	LIMIT (dBm)	S.G POWER VALUE (dBm)	CORRECTION FACTOR (dB)	POWER VALUE (dBm)
1	72.77	45.1	-13.0	-41.5	-7.7	-49.2
2	101.92	50.5	-13.0	-36.0	-7.7	-43.7
3	185.51	48.6	-13.0	-37.7	-7.7	-45.4
4	238.00	48.6	-13.0	-37.6	-7.7	-45.3
5	304.09	44.9	-13.0	-41.7	-7.8	-49.5
6	685.09	44.7	-13.0	-41.6	-7.8	-49.4
ANTENNA POLARITY & TEST DISTANCE: VERTICAL AT 3m						
NO.	FREQ. (MHz)	EMISSION LEVEL (dBuV/m)	LIMIT (dBm)	S.G POWER VALUE (dBm)	CORRECTION FACTOR (dB)	POWER VALUE (dBm)
1	39.72	61.4	-13.0	-25.5	-7.7	-33.2
2	101.92	56.0	-13.0	-30.3	-7.7	-38.0
3	181.62	50.2	-13.0	-36.3	-7.7	-44.0
4	444.05	51.7	-13.0	-34.6	-7.8	-42.4
5	533.47	48.7	-13.0	-37.9	-7.8	-45.7
6	675.37	43.0	-13.0	-44.0	-7.8	-51.8

NOTE: Power Value (dBum) = S.G Power Value (dBm) + Correction Factor (dB).



A D T

4.7 RADIATED EMISSION MEASUREMENT (ABOVE 1GHz)

4.7.1 LIMITS OF RADIATED EMISSION MEASUREMENT

According to FCC 90.1323 specified that the power of any emission outside a licensee's frequency band(s) of operation shall be attenuated below the transmitter power (P) within the licensed band(s) of operation, measured in Watts, by at least $43 + 10 \log (P)$ dB. The limit of emission equal to -13dBm Compliance with this provision is based on the use of measurement instrumentation employing a resolution bandwidth of 1 MHz or less, but at least one percent of the emission bandwidth of the fundamental emission of the transmitter, provided the measured energy is integrated over a 1 MHz bandwidth.

4.7.2 TEST INSTRUMENTS

Same as 4.6.2.

4.7.3 TEST PROCEDURES

Same as 4.6.3.

4.7.4 DEVIATION FROM TEST STANDARD

No deviation

4.7.5 TEST SETUP

Same as 4.6.5.

4.7.6 EUT OPERATING CONDITIONS

Same as 4.1.5



A D T

4.7.7 TEST RESULTS

CHANNEL	Low, Middle, High channel	CHANNEL BANDWIDTH	5.0MHz
----------------	---------------------------	--------------------------	--------

LOW CHANNEL						
ANTENNA POLARITY & TEST DISTANCE: HORIZONTAL AT 3 m						
NO.	FREQ. (MHz)	EMISSION LEVEL (dBuV)	LIMIT (dBm)	S.G POWER VALUE (dBm)	CORRECTION FACTOR (dB)	POWER VALUE (dBm)
1	7305.00	59.0	-13.0	-44.4	9.5	-34.9
2	10957.50	58.9	-13.0	-43.4	7.8	-35.6
ANTENNA POLARITY & TEST DISTANCE: VERTICAL AT 3 m						
NO.	FREQ. (MHz)	EMISSION LEVEL (dBuV)	LIMIT (dBm)	S.G POWER VALUE (dBm)	CORRECTION FACTOR (dB)	POWER VALUE (dBm)
1	7305.00	60.3	-13.0	-43.3	9.5	-33.8
2	10957.50	58.3	-13.0	-44.0	7.8	-36.2
MIDDLE CHANNEL						
ANTENNA POLARITY & TEST DISTANCE: HORIZONTAL AT 3 m						
NO.	FREQ. (MHz)	EMISSION LEVEL (dBuV)	LIMIT (dBm)	S.G POWER VALUE (dBm)	CORRECTION FACTOR (dB)	POWER VALUE (dBm)
1	7325.00	58.2	-13.0	-45.8	9.7	-36.1
2	10987.50	57.6	-13.0	-44.3	7.8	-36.5
ANTENNA POLARITY & TEST DISTANCE: VERTICAL AT 3 m						
NO.	FREQ. (MHz)	EMISSION LEVEL (dBuV)	LIMIT (dBm)	S.G POWER VALUE (dBm)	CORRECTION FACTOR (dB)	POWER VALUE (dBm)
1	7325.00	59.2	-13.0	-44.8	9.7	-35.1
2	10987.50	59.7	-13.0	-42.6	7.8	-34.8
HIGH CHANNEL						
ANTENNA POLARITY & TEST DISTANCE: HORIZONTAL AT 3 m						
NO.	FREQ. (MHz)	EMISSION LEVEL (dBuV)	LIMIT (dBm)	S.G POWER VALUE (dBm)	CORRECTION FACTOR (dB)	POWER VALUE (dBm)
1	7345.00	59.2	-13.0	-44.7	9.7	-35.0
2	11017.50	58.7	-13.0	-43.2	7.8	-35.4
ANTENNA POLARITY & TEST DISTANCE: VERTICAL AT 3 m						
NO.	FREQ. (MHz)	EMISSION LEVEL (dBuV)	LIMIT (dBm)	S.G POWER VALUE (dBm)	CORRECTION FACTOR (dB)	POWER VALUE (dBm)
1	7345.00	59.0	-13.0	-45.2	9.7	-35.5
2	11017.50	56.5	-13.0	-45.9	7.8	-38.1

NOTE: Power Value (dBum) = S.G Power Value (dBm) + Correction Factor (dB).



A D T

CHANNEL	Low, Middle, High channel	CHANNEL BANDWIDTH	7.0MHz
----------------	---------------------------	--------------------------	--------

LOW CHANNEL						
ANTENNA POLARITY & TEST DISTANCE: HORIZONTAL AT 3 m						
NO.	FREQ. (MHz)	EMISSION LEVEL (dBuV)	LIMIT (dBm)	S.G POWER VALUE (dBm)	CORRECTION FACTOR (dB)	POWER VALUE (dBm)
1	7307.00	55.3	-13.0	-48.2	9.5	-38.7
2	10960.50	57.6	-13.0	-44.7	7.8	-36.9
ANTENNA POLARITY & TEST DISTANCE: VERTICAL AT 3 m						
NO.	FREQ. (MHz)	EMISSION LEVEL (dBuV)	LIMIT (dBm)	S.G POWER VALUE (dBm)	CORRECTION FACTOR (dB)	POWER VALUE (dBm)
1	7307.00	58.0	-13.0	-45.7	9.5	-36.2
2	10960.50	56.8	-13.0	-45.0	7.8	-37.2
MIDDLE CHANNEL						
ANTENNA POLARITY & TEST DISTANCE: HORIZONTAL AT 3 m						
NO.	FREQ. (MHz)	EMISSION LEVEL (dBuV)	LIMIT (dBm)	S.G POWER VALUE (dBm)	CORRECTION FACTOR (dB)	POWER VALUE (dBm)
1	7325.00	55.1	-13.0	-48.7	9.7	-39.0
2	10987.50	58.7	-13.0	-43.4	7.8	-35.6
ANTENNA POLARITY & TEST DISTANCE: VERTICAL AT 3 m						
NO.	FREQ. (MHz)	EMISSION LEVEL (dBuV)	LIMIT (dBm)	S.G POWER VALUE (dBm)	CORRECTION FACTOR (dB)	POWER VALUE (dBm)
1	7325.00	57.9	-13.0	-46.0	9.7	-36.3
2	10987.50	57.7	-13.0	-44.6	7.8	-36.8
HIGH CHANNEL						
ANTENNA POLARITY & TEST DISTANCE: HORIZONTAL AT 3 m						
NO.	FREQ. (MHz)	EMISSION LEVEL (dBuV)	LIMIT (dBm)	S.G POWER VALUE (dBm)	CORRECTION FACTOR (dB)	POWER VALUE (dBm)
1	7343.00	55.3	-13.0	-48.8	9.7	-39.1
2	11014.50	58.2	-13.0	-44.1	7.8	-36.3
ANTENNA POLARITY & TEST DISTANCE: VERTICAL AT 3 m						
NO.	FREQ. (MHz)	EMISSION LEVEL (dBuV)	LIMIT (dBm)	S.G POWER VALUE (dBm)	CORRECTION FACTOR (dB)	POWER VALUE (dBm)
1	7343.00	58.2	-13.0	-45.5	9.7	-35.8
2	11014.50	57.2	-13.0	-44.8	7.8	-37.0

NOTE: Power Value (dBum) = S.G Power Value (dBm) + Correction Factor (dB).



A D T

CHANNEL	Low, Middle, High channel	CHANNEL BANDWIDTH	10.0MHz
----------------	---------------------------	--------------------------	---------

LOW CHANNEL						
ANTENNA POLARITY & TEST DISTANCE: HORIZONTAL AT 3 m						
NO.	FREQ. (MHz)	EMISSION LEVEL (dBuV)	LIMIT (dBm)	S.G POWER VALUE (dBm)	CORRECTION FACTOR (dB)	POWER VALUE (dBm)
1	7310.00	54.9	-13.0	-48.9	9.5	-39.4
2	10965.00	56.7	-13.0	-45.2	7.8	-37.4
ANTENNA POLARITY & TEST DISTANCE: VERTICAL AT 3 m						
NO.	FREQ. (MHz)	EMISSION LEVEL (dBuV)	LIMIT (dBm)	S.G POWER VALUE (dBm)	CORRECTION FACTOR (dB)	POWER VALUE (dBm)
1	7310.00	56.0	-13.0	-47.5	9.5	-38.0
2	10965.00	55.7	-13.0	-46.1	7.8	-38.3
MIDDLE CHANNEL						
ANTENNA POLARITY & TEST DISTANCE: HORIZONTAL AT 3 m						
NO.	FREQ. (MHz)	EMISSION LEVEL (dBuV)	LIMIT (dBm)	S.G POWER VALUE (dBm)	CORRECTION FACTOR (dB)	POWER VALUE (dBm)
1	7325.00	55.2	-13.0	-48.6	9.7	-38.9
2	10987.50	55.3	-13.0	-46.8	7.8	-39.0
ANTENNA POLARITY & TEST DISTANCE: VERTICAL AT 3 m						
NO.	FREQ. (MHz)	EMISSION LEVEL (dBuV)	LIMIT (dBm)	S.G POWER VALUE (dBm)	CORRECTION FACTOR (dB)	POWER VALUE (dBm)
1	7325.00	56.3	-13.0	-47.5	9.7	-37.8
2	10987.50	56.0	-13.0	-46.1	7.8	-38.3
HIGH CHANNEL						
ANTENNA POLARITY & TEST DISTANCE: HORIZONTAL AT 3 m						
NO.	FREQ. (MHz)	EMISSION LEVEL (dBuV)	LIMIT (dBm)	S.G POWER VALUE (dBm)	CORRECTION FACTOR (dB)	POWER VALUE (dBm)
1	7340.00	55.2	-13.0	-48.4	9.7	-38.7
2	11010.00	56.0	-13.0	-46.1	7.8	-38.3
ANTENNA POLARITY & TEST DISTANCE: VERTICAL AT 3 m						
NO.	FREQ. (MHz)	EMISSION LEVEL (dBuV)	LIMIT (dBm)	S.G POWER VALUE (dBm)	CORRECTION FACTOR (dB)	POWER VALUE (dBm)
1	7340.00	55.9	-13.0	-48.4	9.7	-38.7
2	11010.00	55.3	-13.0	-47.5	7.8	-39.7

NOTE: Power Value (dBum) = S.G Power Value (dBm) + Correction Factor (dB).



A D T

5 PHOTOGRAPHS OF THE TEST CONFIGURATION

Please refer to the attached file (Test Setup Photo).



A D T

6 INFORMATION ON THE TESTING LABORATORIES

We, Bureau Veritas Consumer Products Services (H.K.) Ltd., Taoyuan Branch, were founded in 1988 to provide our best service in EMC, Radio, Telecom and Safety consultation. Our laboratories are accredited and approved according to ISO/IEC 17025.

Copies of accreditation certificates of our laboratories obtained from approval agencies can be downloaded from our web site:

www.adt.com.tw/index.5/phtml. If you have any comments, please feel free to contact us at the following:

Linko EMC/RF Lab:

Tel: 886-2-26052180

Fax: 886-2-26051924

Hsin Chu EMC/RF Lab:

Tel: 886-3-5935343

Fax: 886-3-5935342

Hwa Ya EMC/RF/Safety/Telecom Lab: Web Site: www.adt.com.tw

Tel: 886-3-3183232

Fax: 886-3-3185050

The address and road map of all our labs can be found in our web site also.

---END---