



FCC TEST REPORT

REPORT NO.: RF930815L01

MODEL NO.: WUBR-132G

RECEIVED: Aug. 05, 2004

TESTED: Aug. 05~ Aug. 10, 2004

APPLICANT: Gemtek Technology Co., Ltd.

ADDRESS: No.1, Jen Ai Road, Hsinchu Industrial Park,
Hukou Hsinchu, Taiwan, R.O.C. 303

ISSUED BY: Advance Data Technology Corporation

LAB LOCATION: No. 19, Hwa Ya 2nd Rd., Kueishan, Taoyuan,
Taiwan, R.O.C.

This test report consists of 68 pages in total. It may be duplicated completely for legal use with the approval of the applicant. It should not be reproduced except in full, without the written approval of our laboratory. The client should not use it to claim product endorsement by CNLA, or any government agencies. The test results in the report only apply to the tested sample.



0528
ILAC MRA



Table of Contents

1	CERTIFICATION	4
2	SUMMARY OF TEST RESULTS.....	5
2.1	MEASUREMENT UNCERTAINTY	5
3	GENERAL INFORMATION.....	7
3.1	GENERAL DESCRIPTION OF EUT	7
3.2	DESCRIPTION OF TEST MODES	8
3.3	GENERAL DESCRIPTION OF APPLIED STANDARDS	8
3.4	DESCRIPTION OF SUPPORT UNITS.....	9
3.5	CONFIGURATION OF SYSTEM UNDER TEST.....	9
4	TEST TYPES AND RESULTS.....	10
4.1	CONDUCTED EMISSION MEASUREMENT.....	10
4.1.1	LIMITS OF CONDUCTED EMISSION MEASUREMENT	10
4.1.2	TEST INSTRUMENTS	10
4.1.3	TEST PROCEDURES.....	11
4.1.4	DEVIATION FROM TEST STANDARD	11
4.1.5	TEST SETUP.....	12
4.1.6	EUT OPERATING CONDITIONS	12
4.1.7	TEST RESULTS	13
4.2	RADIATED EMISSION MEASUREMENT	19
4.2.1	LIMITS OF RADIATED EMISSION MEASUREMENT	19
4.2.2	TEST INSTRUMENTS	20
4.2.3	TEST PROCEDURES.....	21
4.2.4	DEVIATION FROM TEST STANDARD	21
4.2.5	TEST SETUP.....	22
4.2.6	EUT OPERATING CONDITIONS	22
4.2.7	TEST RESULTS	23
4.3	6dB BANDWIDTH MEASUREMENT.....	31
4.3.1	LIMITS OF 6dB BANDWIDTH MEASUREMENT	31
4.3.2	TEST INSTRUMENTS	31
4.3.3	TEST PROCEDURE	32
4.3.4	DEVIATION FROM TEST STANDARD	32
4.3.5	TEST SETUP.....	32
4.3.6	EUT OPERATING CONDITIONS	32
4.3.7	TEST RESULTS	33
4.4	MAXIMUM PEAK OUTPUT POWER	41
4.4.1	LIMITS OF MAXIMUM PEAK OUTPUT POWER MEASUREMENT.....	41



4.4.2	TEST INSTRUMENTS	41
4.4.3	TEST PROCEDURES.....	42
4.4.4	DEVIATION FROM TEST STANDARD	42
4.4.5	TEST SETUP	42
4.4.6	EUT OPERATING CONDITIONS	42
4.4.7	TEST RESULTS	43
4.5	POWER SPECTRAL DENSITY MEASUREMENT.....	44
4.5.1	LIMITS OF POWER SPECTRAL DENSITY MEASUREMENT	44
4.5.2	TEST INSTRUMENTS	44
4.5.3	TEST PROCEDURE	45
4.5.4	DEVIATION FROM TEST STANDARD	45
4.5.5	TEST SETUP	45
4.5.6	EUT OPERATING CONDITIONS	45
4.5.7	TEST RESULTS	46
4.6	BAND EDGES MEASUREMENT.....	54
4.6.1	LIMITS OF BAND EDGES MEASUREMENT	54
4.6.2	TEST INSTRUMENTS	54
4.6.3	TEST PROCEDURE	54
4.6.4	DEVIATION FROM TEST STANDARD	54
4.6.5	EUT OPERATING CONDITION.....	54
4.6.6	TEST RESULTS	55
4.7	ANTENNA REQUIREMENT.....	64
4.7.1	STANDARD APPLICABLE.....	64
4.7.2	ANTENNA CONNECTED CONSTRUCTION	64
5	PHOTOGRAPHS OF THE TEST CONFIGURATION	65
6	INFORMATION ON THE TESTING LABORATORIES.....	69



1 CERTIFICATION

PRODUCT : 802.11g Wireless USB module
BRAND NAME : Gemtek
MODEL NO. : WUBR-132G
APPLICANT : Gemtek Technology Co., Ltd.
TESTED : Aug. 05~ Aug. 10, 2004
TEST ITEM : ENGINEERING SAMPLE
STANDARDS : FCC Part 15, Subpart C (Section 15.247),
ANSI C63.4-2001

The above equipment has been tested by **Advance Data Technology Corporation**, and found compliance with the requirement of the above standards. The test record, data evaluation & Equipment Under Test (EUT) configurations represented herein are true and accurate accounts of the measurements of the sample's EMC characteristics under the conditions specified in this report.

PREPARED BY : Windy Chou , **DATE:** Aug. 17, 2004
(Windy Chou)

TECHNICAL
ACCEPTANCE : Gary Chang , **DATE:** Aug. 17, 2004
Responsible for RF (Gary Chang)

APPROVED BY : Cody Chang , **DATE:** Aug. 17, 2004
(Cody Chang, Supervisor)



2 SUMMARY OF TEST RESULTS

The EUT has been tested according to the following specifications:

APPLIED STANDARD: FCC Part 15, Subpart C			
Standard Section	Test Type and Limit	Result	REMARK
15.207	AC Power Conducted Emission	PASS	Meet the requirement of limit. Minimum passing margin is -25.07dB at 0.154MHz
15.247(a)(2)	Spectrum Bandwidth of a Direct Sequence Spread Spectrum System Limit: min. 500kHz	PASS	Meet the requirement of limit.
15.247(b)	Maximum Peak Output Power Limit: max. 30dBm	PASS	Meet the requirement of limit.
15.247(c)	Transmitter Radiated Emissions Limit: Table 15.209	PASS	Meet the requirement of limit. Minimum passing margin is -1.77dB at 2486.00MHz
15.247(d)	Power Spectral Density Limit: max. 8dBm	PASS	Meet the requirement of limit.
15.247(c)	Band Edge Measurement Limit: 20 dB less than the peak value of fundamental frequency	PASS	Meet the requirement of limit.

2.1 MEASUREMENT UNCERTAINTY

Where relevant, the following measurement uncertainty levels have been estimated for tests performed on the EUT as specified in CISPR 16-4:

Measurement	Frequency	Uncertainty
Conducted emissions	9k~30MHz	2.44 dB
Radiated emissions	30MHz ~ 200MHz	3.73 dB
	200MHz ~1000MHz	3.74 dB
	1GHz ~ 18GHz	2.20 dB



	18GHz ~ 40GHz	1.88 dB
--	---------------	---------



3 GENERAL INFORMATION

3.1 GENERAL DESCRIPTION OF EUT

PRODUCT	802.11g Wireless USB module
MODEL NO.	WUBR-132G
POWER SUPPLY	5.0Vdc from host equipment
MODULATION TYPE	BPSK, QPSK, CCK, 16QAM, 64QAM
RADIO TECHNOLOGY	DSSS, OFDM
TRANSFER RATE	802.11b: 11/5.5/2/1Mbps 802.11g: 54/48/36/24/18/12/9/6Mbps
FREQUENCY RANGE	2412MHz ~ 2462MHz
NUMBER OF CHANNEL	11
OUTPUT POWER	16.04dBm
ANTENNA TYPE	Inverted F antenna (P/N: 29-001718-00) with 2.68dBi Inverted F antenna (P/N: 29-001720-00) with -1.818dBi
DATA CABLE	NA
I/O PORTS	USB
ASSOCIATED DEVICES	NA

NOTE:

1. The EUT operates in the 2.4GHz frequency spectrum with throughput of up to 54Mbps.
2. The EUT complies with IEEE 802.11g standards and backwards compatible with IEEE 802.11b products.
3. There are two antenna provided to this EUT. the information for the antennas as below table:

Antenna	P/N	Difference
Inverted F (2.68 dBi antenna gain)	29-001718-00	Bracket
Inverted F (-1.81 dBi antenna gain)	29-001720-00	

Note: The P/N: 29-001718-00 was chosen for testing in this report.

4. This EUT was tested with a notebook which model: DRW-E01 and brand name: Twinhead and therefore only its test data was recorded in this report. The notebook was powered with the following adapter.

BRAND	LI SHIN INTERNATIONAL ENTERPRISE CORP.
MODEL	LSE0202A2090
INPUT	100-240Vac, 50/60Hz, 1.5A
OUTPUT	20Vdc, 4.5 A, 90W MAX

5. The above EUT information was declared by manufacturer and for more detailed features description, please refer to the manufacturer's specifications or User's Manual.



3.2 DESCRIPTION OF TEST MODES

Eleven channels are provided to this EUT.

Channel	Frequency	Channel	Frequency
1	2412 MHz	7	2442 MHz
2	2417 MHz	8	2447 MHz
3	2422 MHz	9	2452 MHz
4	2427 MHz	10	2457 MHz
5	2432 MHz	11	2462 MHz
6	2437 MHz		

NOTE:

1. Below 1GHz, the channel 1, 6, and 11 were pre-tested in chamber. The channel 11, the worst case, was chosen for final test.
2. Above 1GHz, the channel 1, 6, and 11 were tested individually.
3. From our experience and technical viewpoint, we have chosen data rates 11Mbps for CCK technique and 6Mbps for OFDM technique, as the worst cases for the test among other data rates.
4. Two test modes were presented in the following sections, one is CCK technique, and another is for OFDM technique.

3.3 GENERAL DESCRIPTION OF APPLIED STANDARDS

The EUT is a 802.11g Wireless USB module. According to the specifications of the manufacturer, it must comply with the requirements of the following standards:

FCC Part 15, Subpart C. (15.247)

ANSI C63.4:2001

All test items have been performed and recorded as per the above standards.

NOTE: The EUT is also considered as a kind of computer peripheral, because the connection to computer is necessary for typical use. It has been verified to comply with the requirements of FCC Part 15, Subpart B, Class B (DoC). The test report has been issued separately.



3.4 DESCRIPTION OF SUPPORT UNITS

The EUT has been tested as an independent unit together with other necessary accessories or support units. The following support units or accessories were used to form a representative test configuration during the tests.

NO.	PRODUCT	BRAND	MODEL NO.	SERIAL NO.	FCC ID
1	NOTEBOOK	Twinhead	P14S	SY3091003158	FCC DoC Approved
2	600O LOAD	NA	NA	NA	NA

NO.	SIGNAL CABLE DESCRIPTION OF THE ABOVE SUPPORT UNITS
1	NA
2	NA

NOTE: All power cords of the above support units are non shielded (1.8m).

3.5 CONFIGURATION OF SYSTEM UNDER TEST

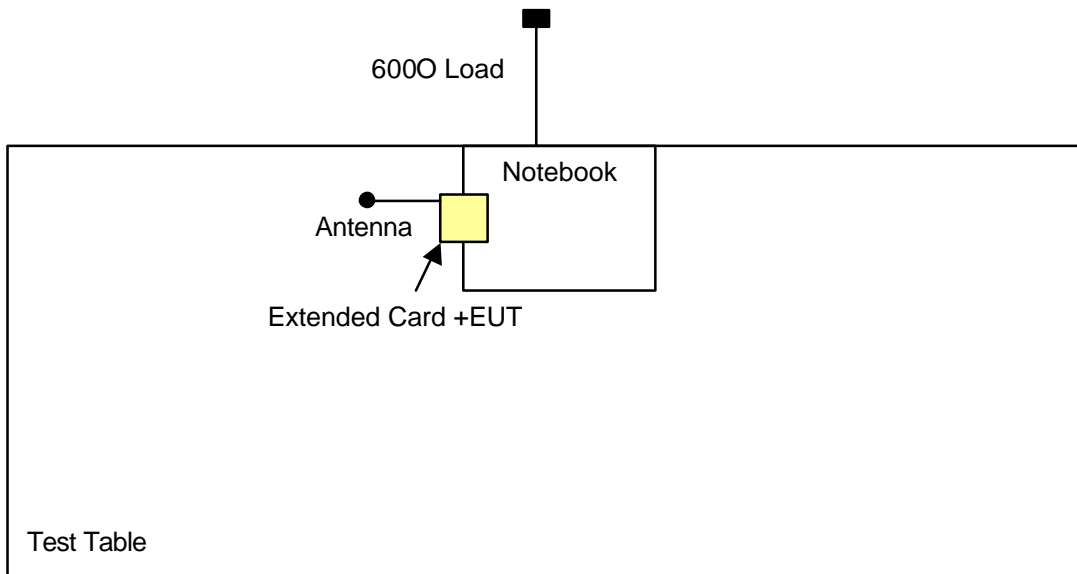



4 TEST TYPES AND RESULTS

4.1 CONDUCTED EMISSION MEASUREMENT

4.1.1 LIMITS OF CONDUCTED EMISSION MEASUREMENT

FREQUENCY OF EMISSION (MHz)	CONDUCTED LIMIT (dB μ V)	
	Quasi-peak	Average
0.15-0.5	66 to 56	56 to 46
0.5-5	56	46
5-30	60	50

- NOTE:**
1. The lower limit shall apply at the transition frequencies.
 2. The limit decreases in line with the logarithm of the frequency in the range of 0.15 to 0.50 MHz.
 3. All emanations from a class A/B digital device or system, including any network of conductors and apparatus connected thereto, shall not exceed the level of field strengths specified above.

4.1.2 TEST INSTRUMENTS

DESCRIPTION & MANUFACTURER	MODEL NO.	SERIAL NO.	CALIBRATED UNTIL
Test Receiver ROHDE & SCHWARZ	ESCS30	100288	Dec. 11, 2004
RF signal cable Woken	5D-FB	Cable-HyC02-01	Mar. 07, 2005
LISN ROHDE & SCHWARZ	ESH2-Z5	100100	Mar. 10, 2005
LISN ROHDE & SCHWARZ	ESH3-Z5	100311	Mar. 04, 2005
Software ADT	ADT_Cond_V3	NA	NA

- NOTE:**
1. The calibration interval of the above test instruments is 12 months and the calibrations are traceable to NML/ROC and NIST/USA.
 2. The test was performed in HwaYa Shielded Room 2.
 3. The VCCI Site Registration No. is C-2047.



4.1.3 TEST PROCEDURES

- a. The EUT was placed 0.4 meters from the conducting wall of the shielded room with EUT being connected to the power mains through a line impedance stabilization network (LISN). Other support units were connected to the power mains through another LISN. The two LISNs provide 50 ohm/ 50uH of coupling impedance for the measuring instrument.
- b. Both lines of the power mains connected to the EUT were checked for maximum conducted interference.
- c. The frequency range from 150 kHz to 30 MHz was searched. Emission levels (Limit -20dB) was not recorded.

4.1.4 DEVIATION FROM TEST STANDARD

No deviation

4.1.5 TEST SETUP

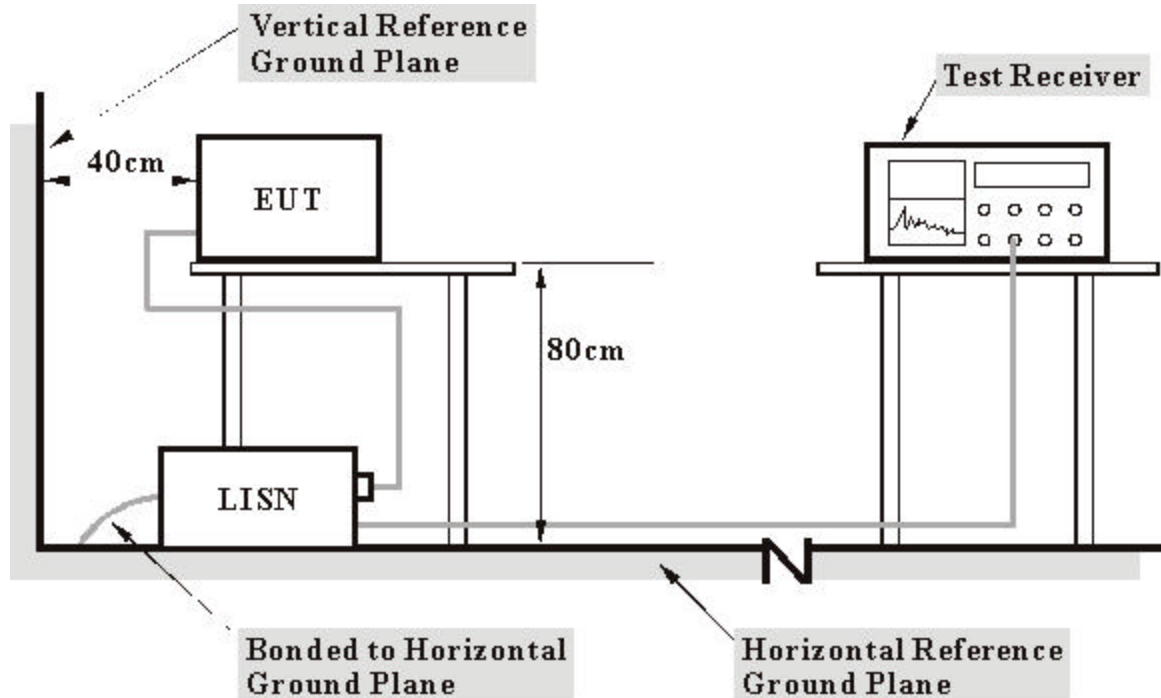

- Note:**
1. Support units were connected to second LISN.
 2. Both of LISNs (AMN) 80 cm from EUT and at the least 80 cm from other units and other metal planes support units.

For the actual test configuration, please refer to the related item – Photographs of the Test Configuration.

4.1.6 EUT OPERATING CONDITIONS

- a. Plugged the EUT to a notebook system placed on a testing table.
- b. The notebook system ran a test program (provided by manufacturer) to enable EUT under transmission/receiving condition continuously at specific channel frequency.
- c. The notebook system sent "H" messages to its screen.
- d. Steps c were repeated.



4.1.7 TEST RESULTS

EUT	802.11g Wireless USB module	MODEL	WUBR-132G
CHANNEL	1	6dB BANDWIDTH	9 kHz
INPUT POWER (SYSTEM)	120 Vac, 60 Hz	PHASE	Line (L)
ENVIRONMENTAL CONDITIONS	24 deg. C, 64% RH, 991 hPa	TESTED BY: Leo Hung	

No	Freq. [MHz]	Corr. Factor (dB)	Reading Value [dB (uV)]		Emission Level [dB (uV)]		Limit [dB (uV)]		Margin (dB)	
			Q.P.	AV.	Q.P.	AV.	Q.P.	AV.	Q.P.	AV.
			1	0.158	0.10	38.18	-	38.28	-	65.58
2	0.318	0.11	23.36	-	23.47	-	59.76	49.76	-36.29	-
3	0.673	0.17	23.05	-	23.22	-	56.00	46.00	-32.78	-
4	1.473	0.25	12.29	-	12.54	-	56.00	46.00	-43.46	-
5	4.995	0.36	29.31	-	29.67	-	56.00	46.00	-26.33	-
6	15.617	0.73	27.12	-	27.85	-	60.00	50.00	-32.15	-

- REMARKS:**
1. Q.P. and AV. are abbreviations of quasi-peak and average individually.
 2. "-": The Quasi-peak reading value also meets average limit and measurement with the average detector is unnecessary.
 3. The emission levels of other frequencies were very low against the limit.
 4. Margin value = Emission level - Limit value
 5. Correction factor = Insertion loss + Cable loss
 6. Emission Level = Correction Factor + Reading Value.

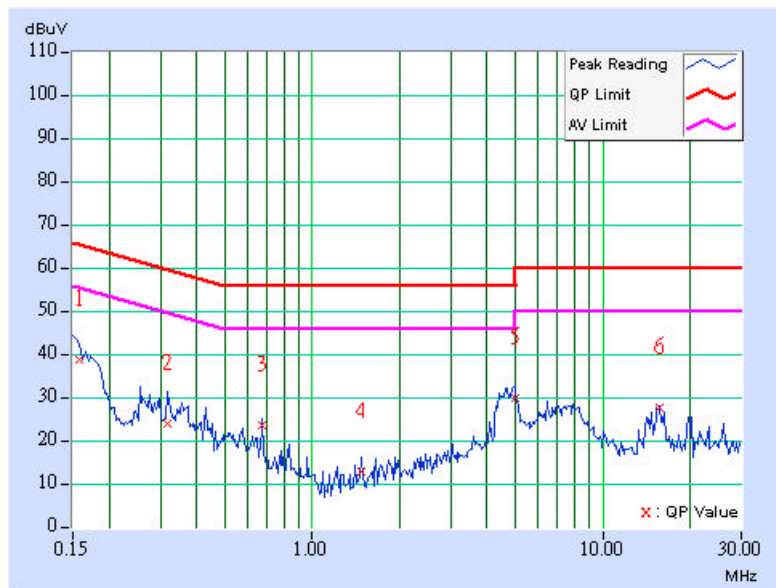



EUT	802.11g Wireless USB module	MODEL	WUBR-132G
CHANNEL	1	6dB BANDWIDTH	9 kHz
INPUT POWER (SYSTEM)	120 Vac, 60 Hz	PHASE	Neutral (N)
ENVIRONMENTAL CONDITIONS	24 deg. C, 64% RH, 991 hPa	TESTED BY: Leo Hung	

No	Freq. [MHz]	Corr. Factor [dB]	Reading Value [dB (uV)]		Emission Level [dB (uV)]		Limit [dB (uV)]		Margin (dB)	
			Q.P.	AV.	Q.P.	AV.	Q.P.	AV.	Q.P.	AV.
			1	0.267	0.10	25.44	-	25.54	-	61.20
2	0.673	0.17	23.29	-	23.46	-	56.00	46.00	-32.54	-
3	2.762	0.27	10.94	-	11.21	-	56.00	46.00	-44.79	-
4	4.738	0.34	29.17	-	29.51	-	56.00	46.00	-26.49	-
5	7.035	0.42	22.81	-	23.23	-	60.00	50.00	-36.77	-
6	16.164	0.58	25.27	-	25.85	-	60.00	50.00	-34.15	-

- REMARKS:**
1. Q.P. and AV. are abbreviations of quasi-peak and average individually.
 2. "-": The Quasi-peak reading value also meets average limit and measurement with the average detector is unnecessary.
 3. The emission levels of other frequencies were very low against the limit.
 4. Margin value = Emission level - Limit value
 5. Correction factor = Insertion loss + Cable loss
 6. Emission Level = Correction Factor + Reading Value.

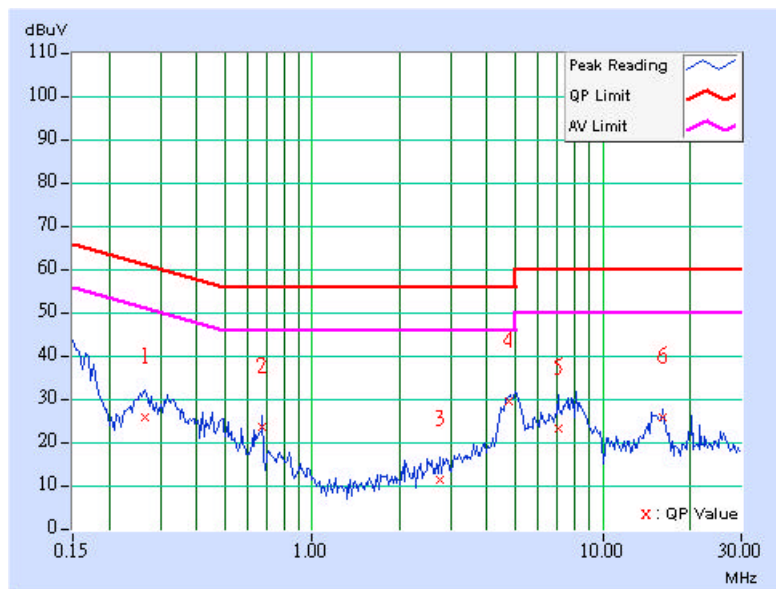



EUT	802.11g Wireless USB module	MODEL	WUBR-132G
CHANNEL	6	6dB BANDWIDTH	9 kHz
INPUT POWER (SYSTEM)	120 Vac, 60 Hz	PHASE	Line (L)
ENVIRONMENTAL CONDITIONS	24 deg. C, 64% RH, 991 hPa	TESTED BY: Leo Hung	

No	Freq. [MHz]	Corr. Factor [dB]	Reading Value [dB (uV)]		Emission Level [dB (uV)]		Limit [dB (uV)]		Margin (dB)	
			Q.P.	AV.	Q.P.	AV.	Q.P.	AV.	Q.P.	AV.
			1	0.252	0.10	26.82	-	26.92	-	61.71
2	0.673	0.17	23.03	-	23.20	-	56.00	46.00	-32.80	-
3	1.409	0.25	10.84	-	11.09	-	56.00	46.00	-44.91	-
4	4.801	0.35	30.03	-	30.38	-	56.00	46.00	-25.62	-
5	7.293	0.45	24.01	-	24.46	-	60.00	50.00	-35.54	-
6	15.332	0.71	21.96	-	22.67	-	60.00	50.00	-37.33	-

- REMARKS:**
1. Q.P. and AV. are abbreviations of quasi-peak and average individually.
 2. "-": The Quasi-peak reading value also meets average limit and measurement with the average detector is unnecessary.
 3. The emission levels of other frequencies were very low against the limit.
 4. Margin value = Emission level - Limit value
 5. Correction factor = Insertion loss + Cable loss
 6. Emission Level = Correction Factor + Reading Value.

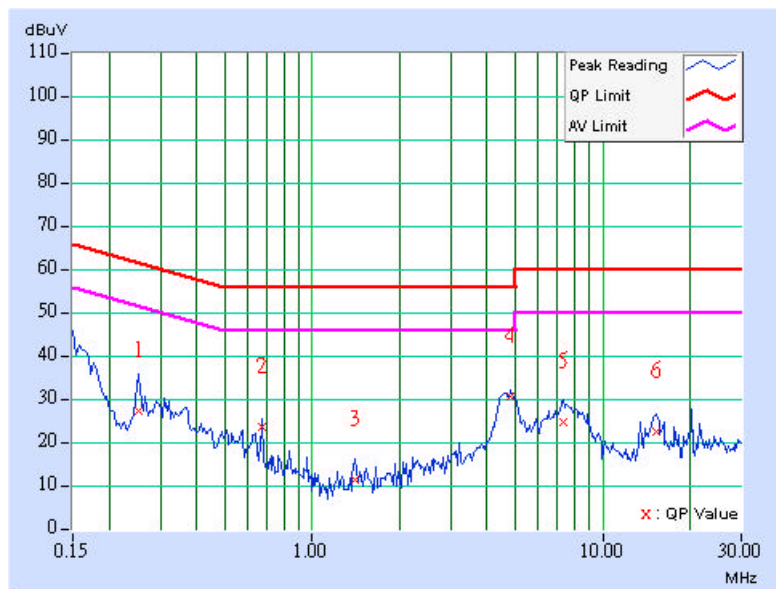



EUT	802.11g Wireless USB module	MODEL	WUBR-132G
CHANNEL	6	6dB BANDWIDTH	9 kHz
INPUT POWER (SYSTEM)	120 Vac, 60 Hz	PHASE	Neutral (N)
ENVIRONMENTAL CONDITIONS	24 deg. C, 64% RH, 991 hPa	TESTED BY: Leo Hung	

No	Freq. [MHz]	Corr. Factor [dB]	Reading Value [dB (uV)]		Emission Level [dB (uV)]		Limit [dB (uV)]		Margin (dB)	
			Q.P.	AV.	Q.P.	AV.	Q.P.	AV.	Q.P.	AV.
			1	0.154	0.10	40.62	-	40.72	-	65.79
2	0.322	0.11	25.36	-	25.47	-	59.66	49.66	-34.19	-
3	0.673	0.17	23.20	-	23.37	-	56.00	46.00	-32.63	-
4	5.117	0.35	26.94	-	27.29	-	60.00	50.00	-32.71	-
5	7.684	0.44	25.46	-	25.90	-	60.00	50.00	-34.10	-
6	15.617	0.57	26.96	-	27.53	-	60.00	50.00	-32.47	-

- REMARKS:**
1. Q.P. and AV. are abbreviations of quasi-peak and average individually.
 2. "-": The Quasi-peak reading value also meets average limit and measurement with the average detector is unnecessary.
 3. The emission levels of other frequencies were very low against the limit.
 4. Margin value = Emission level - Limit value
 5. Correction factor = Insertion loss + Cable loss
 6. Emission Level = Correction Factor + Reading Value.

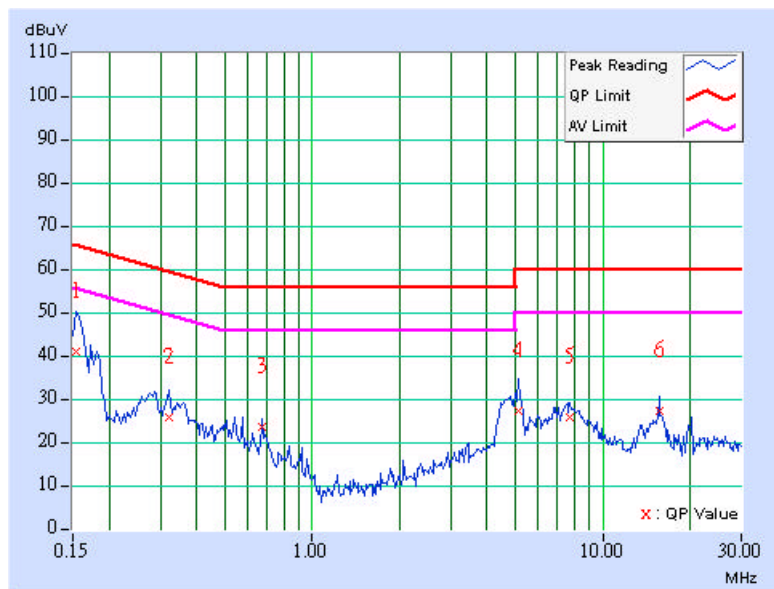



EUT	802.11g Wireless USB module	MODEL	WUBR-132G
CHANNEL	11	6dB BANDWIDTH	9 kHz
INPUT POWER (SYSTEM)	120 Vac, 60 Hz	PHASE	Line (L)
ENVIRONMENTAL CONDITIONS	24 deg. C, 64% RH, 991 hPa	TESTED BY: Leo Hung	

No	Freq. [MHz]	Corr. Factor (dB)	Reading Value [dB (uV)]		Emission Level [dB (uV)]		Limit [dB (uV)]		Margin (dB)	
			Q.P.	AV.	Q.P.	AV.	Q.P.	AV.	Q.P.	AV.
			1	0.193	0.10	30.71	-	30.81	-	63.89
2	0.673	0.17	23.19	-	23.36	-	56.00	46.00	-32.64	-
3	2.023	0.26	8.93	-	9.19	-	56.00	46.00	-46.81	-
4	4.543	0.34	29.79	-	30.13	-	56.00	46.00	-25.87	-
5	7.805	0.46	24.40	-	24.86	-	60.00	50.00	-35.14	-
6	20.258	0.93	25.46	-	26.39	-	60.00	50.00	-33.61	-

- REMARKS:**
1. Q.P. and AV. are abbreviations of quasi-peak and average individually.
 2. "-": The Quasi-peak reading value also meets average limit and measurement with the average detector is unnecessary.
 3. The emission levels of other frequencies were very low against the limit.
 4. Margin value = Emission level - Limit value
 5. Correction factor = Insertion loss + Cable loss
 6. Emission Level = Correction Factor + Reading Value.

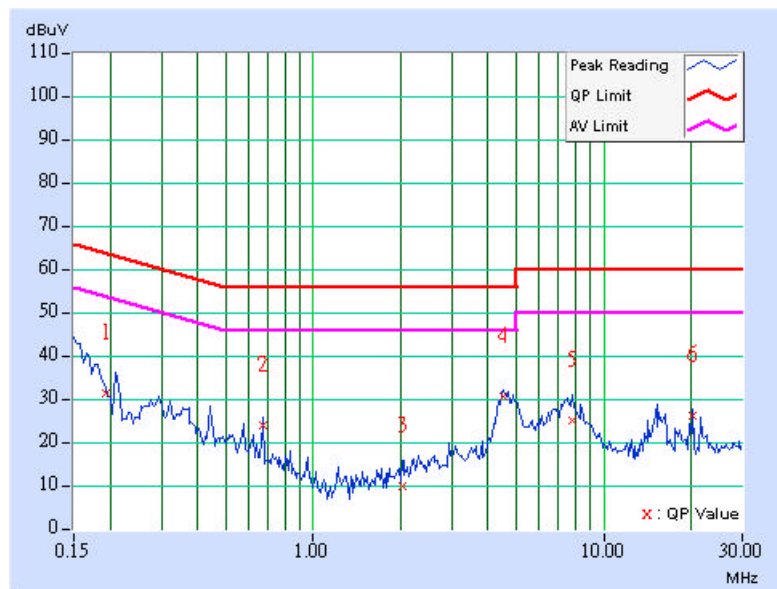



EUT	802.11g Wireless USB module	MODEL	WUBR-132G
CHANNEL	11	6dB BANDWIDTH	9 kHz
INPUT POWER (SYSTEM)	120 Vac, 60 Hz	PHASE	Netural (N)
ENVIRONMENTAL CONDITIONS	24 deg. C, 64% RH, 991 hPa	TESTED BY: Leo Hung	

No	Freq. [MHz]	Corr. Factor (dB)	Reading Value		Emission Level		Limit		Margin	
			[dB (uV)]		[dB (uV)]		[dB (uV)]		(dB)	
			Q.P.	AV.	Q.P.	AV.	Q.P.	AV.	Q.P.	AV.
1	0.154	0.10	40.22	-	40.32	-	65.79	55.79	-25.47	-
2	0.439	0.12	18.28	-	18.40	-	57.08	47.08	-38.68	-
3	0.673	0.17	23.70	-	23.87	-	56.00	46.00	-32.13	-
4	4.418	0.32	27.84	-	28.16	-	56.00	46.00	-27.84	-
5	7.617	0.43	25.47	-	25.90	-	60.00	50.00	-34.10	-
6	16.227	0.58	27.38	-	27.96	-	60.00	50.00	-32.04	-

- REMARKS:**
1. Q.P. and AV. are abbreviations of quasi-peak and average individually.
 2. "-": The Quasi-peak reading value also meets average limit and measurement with the average detector is unnecessary.
 3. The emission levels of other frequencies were very low against the limit.
 4. Margin value = Emission level - Limit value
 5. Correction factor = Insertion loss + Cable loss
 6. Emission Level = Correction Factor + Reading Value.

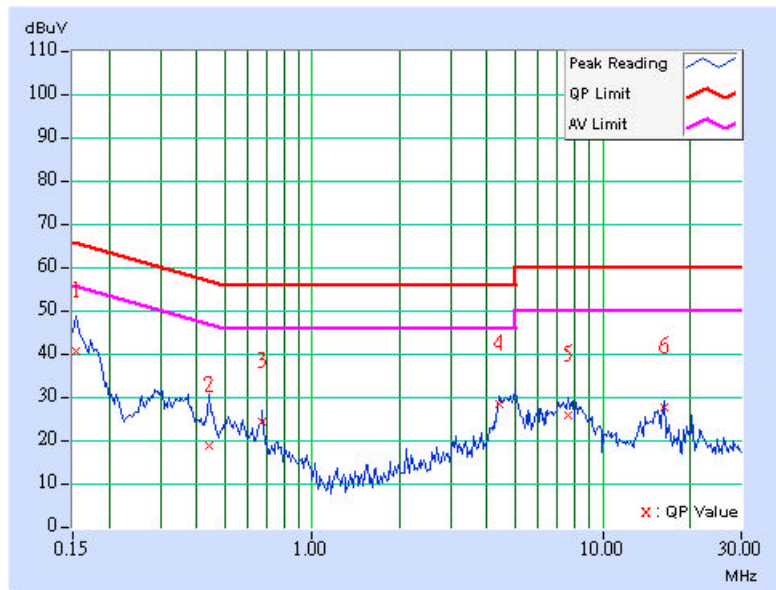



4.2 RADIATED EMISSION MEASUREMENT

4.2.1 LIMITS OF RADIATED EMISSION MEASUREMENT

Emissions radiated outside of the specified bands, shall be according to the general radiated limits in 15.209 as following:

Frequencies (MHz)	Field strength (microvolts/meter)	Measurement distance (meters)
0.009-0.490	2400/F(kHz)	300
0.490-1.705	24000/F(kHz)	30
1.705-30.0	30	30
30-88	100	3
88-216	150	3
216-960	200	3
Above 960	500	3

NOTE:

1. The lower limit shall apply at the transition frequencies.
2. Emission level (dBuV/m) = 20 log Emission level (uV/m).
3. As shown in 15.35(b), for frequencies above 1000MHz, the field strength limits are based on average detector, however, the peak field strength of any emission shall not exceed the maximum permitted average limits, specified above by more than 20dB under any condition of modulation.



4.2.2 TEST INSTRUMENTS

DESCRIPTION & MANUFACTURER	MODEL NO.	SERIAL NO.	CALIBRATED UNTIL
Test Receiver ROHDE & SCHWARZ	ESIB7	100188	Jan. 13, 2005
Spectrum Analyzer ROHDE & SCHWARZ	FSP40	100039	Dec. 15, 2004
BILOG Antenna SCHWARZBECK	VULB9168	9168-157	Feb. 03, 2005
HORN Antenna SCHWARZBECK	BBHA 9120 D	9120D-407	Feb. 03, 2005
HORN Antenna SCHWARZBECK	BBHA 9170	BBHA 9170241	Feb. 23, 2005
Preamplifier Agilent	8449B	3008A01961	Jan. 22, 2005
Preamplifier Agilent	8447D	2944A10629	Jan. 14, 2005
RF signal cable HUBER+SUHNER	SUCOFLEX 104	218182/4	Mar. 04, 2005
RF signal cable HUBER+SUHNER	SUCOFLEX 104	218194/4	Mar. 04, 2005
Software ADT.	ADT_Radiated_V5.14	NA	NA
Antenna Tower ADT.	AT100	AT93021702	NA
Turn Table ADT.	TT100.	TT93021702	NA
Controller ADT.	SC100.	SC93021702	NA

- NOTE:**
1. The calibration interval of the above test instruments is 12 months and the calibrations are traceable to NML/ROC and NIST/USA.
 2. The test was performed in HwaYa Chamber 1.
 3. The horn antenna and HP preamplifier (model: 8449B) are used only for the measurement of emission frequency above 1GHz if tested.
 4. The IC Site Registration No. is IC4924-2.



4.2.3 TEST PROCEDURES

- a. The EUT was placed on the top of a rotating table 0.8 meters above the ground at a 3 meter semi-anechoic chamber. The table was rotated 360 degrees to determine the position of the highest radiation.
- b. The EUT was set 3 meters away from the interference-receiving antenna, which was mounted on the top of a variable-height antenna tower.
- c. The antenna is a broadband antenna, and its height is varied from one meter to four meters above the ground to determine the maximum value of the field strength. Both horizontal and vertical polarizations of the antenna are set to make the measurement.
- d. For each suspected emission, the EUT was arranged to its worst case and then the antenna was tuned to heights from 1 meter to 4 meters and the rotatable table was turned from 0 degrees to 360 degrees to find the maximum reading.
- e. The test-receiver system was set to Peak Detect Function and Specified Bandwidth with Maximum Hold Mode.
- f. If the emission level of the EUT in peak mode was 10 dB lower than the limit specified, then testing could be stopped and the peak values of the EUT would be reported. Otherwise the emissions that did not have 10 dB margin would be re-tested one by one using peak, quasi-peak or average method as specified and then reported in a data sheet.

NOTE:

1. The resolution bandwidth and video bandwidth of test receiver/spectrum analyzer is 120kHz for Peak detection (PK) and Quasi-peak detection (QP) at frequency below 1GHz.
2. The resolution bandwidth and video bandwidth of test receiver/spectrum analyzer is 1 MHz for Peak detection at frequency above 1GHz.
3. The resolution bandwidth of test receiver/spectrum analyzer is 1 MHz and the video bandwidth is 10 Hz for Average detection (AV) at frequency above 1GHz.

4.2.4 DEVIATION FROM TEST STANDARD

No deviation

4.2.5 TEST SETUP

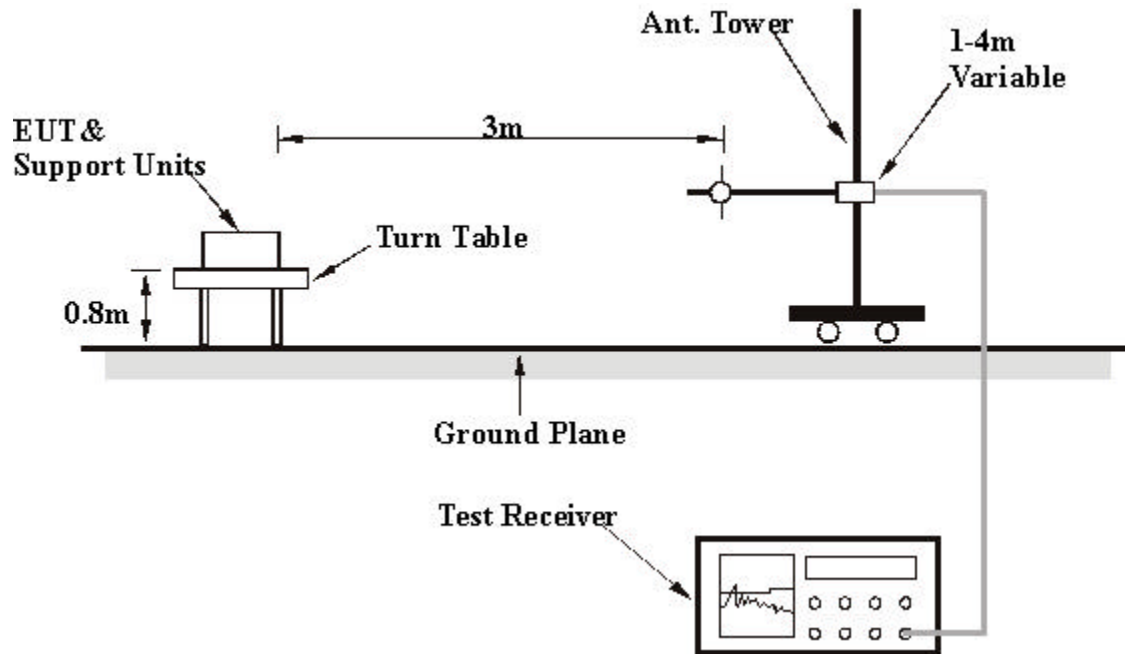

For the actual test configuration, please refer to the related item – Photographs of the Test Configuration.

4.2.6 EUT OPERATING CONDITIONS

Same as 4.1.6



4.2.7 TEST RESULTS

EUT	802.11g Wireless USB module	MODEL	WUBR-132G
CHANNEL	11	FREQUENCY RANGE	Below 1000 MHz
INPUT POWER (SYSTEM)	120 Vac, 60Hz	DETECTOR FUNCTION	Quasi-Peak
ENVIRONMENTAL CONDITIONS	25 deg. C, 70% RH, 991 hPa	TESTED BY: Steven Lu	

ANTENNA POLARITY & TEST DISTANCE: HORIZONTAL AT 3 M								
No.	Freq. (MHz)	Emission Level (dBuV/m)	Limit (dBuV/m)	Margin (dB)	Antenna Height (m)	Table Angle (Degree)	Raw Value (dBuV)	Correction Factor (dB/m)
1	120.00	40.66 QP	43.50	-2.84	1.75 H	168	28.28	12.38
2	240.00	27.82 QP	46.00	-18.18	1.53 H	131	15.23	12.59
3	330.00	35.67 QP	46.00	-10.33	1.21 H	56	19.90	15.77
4	420.00	29.83 QP	46.00	-16.17	1.15 H	56	11.70	18.13
5	480.00	36.97 QP	46.00	-9.03	1.75 H	205	17.79	19.18
6	540.62	29.37 QP	46.00	-16.63	1.70 H	19	8.82	20.55
7	579.88	38.34 QP	46.00	-7.66	1.39 H	236	17.08	21.26
8	600.00	35.39 QP	46.00	-10.61	1.54 H	359	13.76	21.63
9	773.16	37.07 QP	46.00	-8.93	1.06 H	43	11.97	25.10
10	835.52	32.79 QP	46.00	-13.21	1.23 H	202	8.22	24.57

- REMARKS:**
1. Emission level(dBuV/m)=Raw Value(dBuV) + Correction Factor(dB/m)
 2. Correction Factor(dB/m) = Antenna Factor (dB/m) + Cable Factor (dB)
 3. The other emission levels were very low against the limit.
 4. Margin value = Emission level – Limit value.



EUT	802.11g Wireless USB module	MODEL	WUBR-132G
CHANNEL	11	FREQUENCY RANGE	Below 1000 MHz
INPUT POWER (SYSTEM)	120 Vac, 60Hz	DETECTOR FUNCTION	Quasi-Peak
ENVIRONMENTAL CONDITIONS	25 deg. C, 70% RH, 991 hPa	TESTED BY: Steven Lu	

ANTENNA POLARITY & TEST DISTANCE: VERTICAL AT 3 M

No.	Freq. (MHz)	Emission Level (dBuV/m)	Limit (dBuV/m)	Margin (dB)	Antenna Height (m)	Table Angle (Degree)	Raw Value (dBuV)	Correction Factor (dB/m)
1	120.00	39.88 QP	43.50	-3.62	1.37 V	0	27.50	12.38
2	150.00	34.53 QP	43.50	-8.97	1.00 V	117	23.65	10.88
3	240.00	29.43 QP	46.00	-16.57	1.07 V	193	16.84	12.59
4	330.00	32.24 QP	46.00	-13.76	1.53 V	272	16.47	15.77
5	480.00	39.25 QP	46.00	-6.75	1.07 V	279	20.07	19.18
6	540.64	36.34 QP	46.00	-9.66	1.00 V	196	15.79	20.55
7	579.88	41.08 QP	46.00	-4.92	1.17 V	9	19.82	21.26
8	600.00	34.82 QP	46.00	-11.18	1.00 V	59	13.19	21.63
9	773.18	36.14 QP	46.00	-9.86	1.30 V	218	11.04	25.10
10	835.58	34.22 QP	46.00	-11.78	1.53 V	94	9.65	24.57

- REMARKS:**
1. Emission level(dBuV/m)=Raw Value(dBuV) + Correction Factor(dB/m)
 2. Correction Factor(dB/m) = Antenna Factor (dB/m) + Cable Factor (dB)
 3. The other emission levels were very low against the limit.
 4. Margin value = Emission level – Limit value.



EUT	802.11g Wireless USB module	MODEL	WL MP2454 1A3
CHANNEL	1	MODE	CCK
INPUT POWER (SYSTEM)	120 Vac, 60 Hz	FREQUENCY RANGE	1~25 GHz
ENVIRONMENTAL CONDITIONS	25 deg. C, 58% RH, 991 hPa	DETECTOR FUNCTION	Peak (PK) Average (AV)
TESTED BY	Match Tsui		

ANTENNA POLARITY & TEST DISTANCE: HORIZONTAL AT 3 M

No.	Freq. (MHz)	Emission Level (dBuV/m)	Limit (dBuV/m)	Margin (dB)	Antenna Height (m)	Table Angle (Degree)	Raw Value (dBuV)	Correction Factor (dB/m)
1	1600.00	42.35 PK	74.00	-31.65	1.28 H	302	13.72	28.63
2	2240.00	48.55 PK	74.00	-25.45	1.31 H	358	17.30	31.25
3	2386.00	58.51 PK	74.00	-15.49	1.29 H	330	26.72	31.79
3	2386.00	50.92 AV	54.00	-3.08	1.29 H	330	19.13	31.79
4	*2412.00	109.91 PK			1.29 H	330	78.04	31.87
4	*2412.00	102.32 AV			1.29 H	330	70.45	31.87
5	2786.00	54.17 PK	74.00	-19.83	1.29 H	148	20.86	33.31
5	2786.00	51.67 AV	54.00	-2.33	1.29 H	148	18.36	33.31
6	3200.00	49.73 PK	74.00	-24.27	1.28 H	37	14.76	34.97
7	7236.00	55.09 PK	74.00	-18.91	1.07 H	34	12.04	43.05
7	7236.00	42.70 AV	54.00	-11.30	1.07 H	34	-0.35	43.05

ANTENNA POLARITY & TEST DISTANCE: VERTICAL AT 3 M

No.	Freq. (MHz)	Emission Level (dBuV/m)	Limit (dBuV/m)	Margin (dB)	Antenna Height (m)	Table Angle (Degree)	Raw Value (dBuV)	Correction Factor (dB/m)
1	1280.00	51.22 PK	74.00	-22.78	1.07 V	154	23.94	27.28
1	1280.00	48.89 AV	54.00	-5.11	1.07 V	154	21.61	27.28
2	1600.00	49.31 PK	74.00	-24.69	1.15 V	215	20.68	28.63
3	2240.00	48.27 PK	74.00	-25.73	1.15 V	40	17.02	31.25
4	2386.00	56.38 PK	74.00	-17.62	1.17 V	330	24.59	31.79
4	2386.00	48.61 AV	54.00	-5.39	1.17 V	330	16.82	31.79
5	*2412.00	107.78 PK			1.17 V	330	75.91	31.87
5	*2412.00	100.01 AV			1.17 V	330	68.14	31.87
6	2786.00	52.20 PK	74.00	-21.80	1.17 V	346	18.89	33.31
6	2786.00	48.82 AV	54.00	-5.18	1.17 V	346	15.51	33.31
7	4824.00	52.46 PK	74.00	-21.54	1.06 V	31	14.35	38.11
7	4824.00	39.54 AV	54.00	-14.46	1.06 V	31	1.43	38.11
8	7236.00	55.69 PK	74.00	-18.31	1.06 V	16	12.64	43.05
8	7236.00	44.36 AV	54.00	-9.64	1.06 V	16	1.31	43.05

REMARKS:

1. Emission level(dBuV/m)=Raw Value(dBuV) + Correction Factor(dB)
2. Correction Factor(dB/m) = Antenna Factor (dB/m) + Cable Factor (dB)
3. The other emission levels were very low against the limit.
4. Margin value = Emission level – Limit value.
5. " * " : Fundamental frequency



EUT	802.11g Wireless USB module	MODEL	WUBR-132G
CHANNEL	6	MODE	CCK
INPUT POWER (SYSTEM)	120 Vac, 60 Hz	FREQUENCY RANGE	1~25 GHz
ENVIRONMENTAL CONDITIONS	25 deg. C, 58% RH, 991 hPa	DETECTOR FUNCTION	Peak(PK) Average (AV)
TESTED BY	Match Tsui		

ANTENNA POLARITY & TEST DISTANCE: HORIZONTAL AT 3 M								
No.	Freq. (MHz)	Emission Level (dBuV/m)	Limit (dBuV/m)	Margin (dB)	Antenna Height (m)	Table Angle (Degree)	Raw Value (dBuV)	Correction Factor (dB/m)
1	1440.00	45.99 PK	74.00	-28.01	1.11 H	146	18.12	27.87
2	1632.00	44.73 PK	74.00	-29.27	1.05 H	340	15.93	28.80
3	*2437.00	110.09 PK			1.10 H	331	78.14	31.95
3	*2437.00	102.64 AV			1.10 H	331	70.69	31.95
4	2811.00	52.81 PK	74.00	-21.19	1.09 H	311	19.40	33.41
4	2811.00	50.00 AV	54.00	-4.00	1.09 H	311	16.59	33.41
5	3188.00	55.08 PK	74.00	-18.92	1.28 H	208	20.16	34.92
5	3188.00	45.65 AV	54.00	-8.35	1.28 H	208	10.73	34.92
6	7311.00	56.12 PK	74.00	-17.88	1.11 H	34	13.15	42.97
6	7311.00	43.30 AV	54.00	-10.70	1.11 H	34	0.33	42.97

ANTENNA POLARITY & TEST DISTANCE: VERTICAL AT 3 M								
No.	Freq. (MHz)	Emission Level (dBuV/m)	Limit (dBuV/m)	Margin (dB)	Antenna Height (m)	Table Angle (Degree)	Raw Value (dBuV)	Correction Factor (dB/m)
1	1440.00	43.74 PK	74.00	-30.26	1.06 V	333	15.87	27.87
2	1632.00	42.30 PK	74.00	-31.70	1.08 V	161	13.50	28.80
3	*2437.00	107.55 PK			1.04 V	265	75.60	31.95
3	*2437.00	99.96 AV			1.04 V	265	68.01	31.95
4	2811.00	52.79 PK	74.00	-21.21	1.11 V	336	19.38	33.41
4	2811.00	49.76 AV	54.00	-4.24	1.11 V	336	16.35	33.41
5	3188.00	57.30 PK	74.00	-16.70	1.08 V	279	22.38	34.92
5	3188.00	48.04 AV	54.00	-5.96	1.08 V	279	13.12	34.92
6	4874.00	52.10 PK	74.00	-21.90	1.07 V	293	13.82	38.28
6	4874.00	38.87 AV	54.00	-15.13	1.07 V	293	0.59	38.28
7	7311.00	56.65 PK	74.00	-17.35	1.06 V	313	13.68	42.97
7	7311.00	46.11 AV	54.00	-7.89	1.06 V	313	3.14	42.97

REMARKS:

1. Emission level(dBuV/m)=Raw Value(dBuV) + Correction Factor(dB)
2. Correction Factor(dB/m) = Antenna Factor (dB/m) + Cable Factor (dB)
3. The other emission levels were very low against the limit.
4. Margin value = Emission level – Limit value.
5. “ * “ : Fundamental frequency



EUT	802.11g Wireless USB module	MODEL	WUBR-132G
CHANNEL	11	MODE	CCK
INPUT POWER (SYSTEM)	120 Vac, 60 Hz	FREQUENCY RANGE	1~25 GHz
ENVIRONMENTAL CONDITIONS	25 deg. C, 58% RH, 991 hPa	DETECTOR FUNCTION	Peak(PK) Average (AV)
TESTED BY	Match Tsui		

ANTENNA POLARITY & TEST DISTANCE: HORIZONTAL AT 3 M

No.	Freq. (MHz)	Emission Level (dBuV/m)	Limit (dBuV/m)	Margin (dB)	Antenna Height (m)	Table Angle (Degree)	Raw Value (dBuV)	Correction Factor (dB/m)
1	1174.00	43.21 PK	74.00	-30.79	1.00 H	257	16.28	26.93
2	1632.00	44.35 PK	74.00	-29.65	1.00 H	31	15.55	28.80
3	*2462.00	111.81 PK			1.00 H	292	79.79	32.02
3	*2462.00	104.20 AV			1.00 H	292	72.18	32.02
4	2836.00	52.45 PK	74.00	-21.55	1.00 H	319	18.95	33.50
4	2836.00	49.06 AV	54.00	-4.94	1.00 H	319	15.56	33.50
5	3213.00	53.12 PK	74.00	-20.88	1.00 H	222	18.14	34.98
5	3213.00	43.37 AV	54.00	-10.63	1.00 H	222	8.39	34.98
6	4924.00	52.36 PK	74.00	-21.64	1.00 H	33	13.87	38.49
6	4924.00	39.20 AV	54.00	-14.80	1.00 H	33	0.71	38.49
7	7386.00	56.64 PK	74.00	-17.36	1.00 H	10	14.10	42.55
7	7386.00	45.30 AV	54.00	-8.70	1.00 H	10	2.76	42.55

ANTENNA POLARITY & TEST DISTANCE: VERTICAL AT 3 M

No.	Freq. (MHz)	Emission Level (dBuV/m)	Limit (dBuV/m)	Margin (dB)	Antenna Height (m)	Table Angle (Degree)	Raw Value (dBuV)	Correction Factor (dB/m)
1	1280.00	48.50 PK	74.00	-25.50	1.30 V	139	21.22	27.28
2	1600.00	46.31 PK	74.00	-27.69	1.30 V	300	17.68	28.63
3	2240.00	48.87 PK	74.00	-25.13	1.26 V	1	17.62	31.25
4	*2462.00	110.64 PK			1.32 V	334	78.62	32.02
4	*2462.00	102.60 AV			1.32 V	334	70.58	32.02
5	2486.00	60.27 PK	74.00	-13.73	1.57 V	331	28.18	32.09
5	2486.00	52.23 AV	54.00	-1.77	1.57 V	331	20.14	32.09
6	2836.00	52.86 PK	74.00	-21.14	1.05 V	346	19.36	33.50
6	2836.00	49.90 AV	54.00	-4.10	1.05 V	346	16.40	33.50
7	3200.00	50.64 PK	74.00	-23.36	1.11 V	96	15.67	34.97
7	3200.00	42.36 AV	54.00	-11.64	1.11 V	96	7.39	34.97
8	7386.00	54.25 PK	74.00	-19.75	1.06 V	30	11.71	42.55
8	7386.00	41.12 AV	54.00	-12.88	1.06 V	30	-1.42	42.55

REMARKS:

1. Emission level(dBuV/m)=Raw Value(dBuV) + Correction Factor(dB)
2. Correction Factor(dB/m) = Antenna Factor (dB/m) + Cable Factor (dB)
3. The other emission levels were very low against the limit.
4. Margin value = Emission level – Limit value.
5. “ * “ : Fundamental frequency



EUT	802.11g Wireless USB module	MODEL	WUBR-132G
CHANNEL	1	MODE	OFDM
INPUT POWER (SYSTEM)	120 Vac, 60 Hz	FREQUENCY RANGE	1~25 GHz
ENVIRONMENTAL CONDITIONS	25 deg. C, 58% RH, 991 hPa	DETECTOR FUNCTION	Peak(PK) Average (AV)
TESTED BY	Match Tsui		

ANTENNA POLARITY & TEST DISTANCE: HORIZONTAL AT 3 M

No.	Freq. (MHz)	Emission Level (dBuV/m)	Limit (dBuV/m)	Margin (dB)	Antenna Height (m)	Table Angle (Degree)	Raw Value (dBuV)	Correction Factor (dB/m)
1	1280.00	48.32 PK	74.00	-25.68	1.25 H	226	21.04	27.28
2	1632.00	47.48 PK	74.00	-26.52	1.62 H	139	18.68	28.80
3	2390.00	56.72 PK	74.00	-17.28	1.29 H	326	24.92	31.80
3	2390.00	47.31 AV	54.00	-6.69	1.29 H	326	15.51	31.80
4	*2412.00	105.56 PK			1.29 H	326	73.69	31.87
4	*2412.00	96.15 AV			1.29 H	326	64.28	31.87
5	2786.00	54.58 PK	74.00	-19.42	1.29 H	149	21.27	33.31
5	2786.00	52.18 AV	54.00	-1.82	1.29 H	149	18.87	33.31
6	3200.00	49.31 PK	74.00	-24.69	1.27 H	91	14.34	34.97
7	9648.00	51.77 PK	74.00	-22.23	1.05 H	336	9.49	42.28
7	9648.00	39.64 AV	54.00	-14.36	1.05 H	336	-2.64	42.28

ANTENNA POLARITY & TEST DISTANCE: VERTICAL AT 3 M

No.	Freq. (MHz)	Emission Level (dBuV/m)	Limit (dBuV/m)	Margin (dB)	Antenna Height (m)	Table Angle (Degree)	Raw Value (dBuV)	Correction Factor (dB/m)
1	1280.00	50.23 PK	74.00	-23.77	1.16 V	360	22.95	27.28
1	1280.00	47.67 AV	54.00	-6.33	1.16 V	360	20.39	27.28
2	1632.00	46.45 PK	74.00	-27.55	1.17 V	357	17.65	28.80
3	2390.00	56.19 PK	74.00	-17.81	1.06 V	219	24.39	31.80
3	2390.00	46.90 AV	54.00	-7.10	1.06 V	219	15.10	31.80
4	*2412.00	105.03 PK			1.06 V	219	73.16	31.87
4	*2412.00	95.74 AV			1.06 V	219	63.87	31.87
5	2786.00	52.65 PK	74.00	-21.35	1.17 V	336	19.34	33.31
5	2786.00	49.31 AV	54.00	-4.69	1.17 V	336	16.00	33.31
6	3200.00	53.39 PK	74.00	-20.61	1.13 V	172	18.42	34.97
6	3200.00	47.58 AV	54.00	-6.42	1.13 V	172	12.61	34.97
7	4824.00	44.93 PK	74.00	-29.07	1.26 V	220	6.82	38.11

REMARKS:

1. Emission level(dBuV/m)=Raw Value(dBuV) + Correction Factor(dB)
2. Correction Factor(dB/m) = Antenna Factor (dB/m) + Cable Factor (dB)
3. The other emission levels were very low against the limit.
4. Margin value = Emission level – Limit value.
5. “ * “ : Fundamental frequency



EUT	802.11g Wireless USB module	MODEL	WUBR-132G
CHANNEL	6	MODE	OFDM
INPUT POWER (SYSTEM)	120 Vac, 60 Hz	FREQUENCY RANGE	1~25 GHz
ENVIRONMENTAL CONDITIONS	25 deg. C, 58% RH, 991 hPa	DETECTOR FUNCTION	Peak(PK) Average (AV)
TESTED BY	Match Tsui		

ANTENNA POLARITY & TEST DISTANCE: HORIZONTAL AT 3 M

No.	Freq. (MHz)	Emission Level (dBuV/m)	Limit (dBuV/m)	Margin (dB)	Antenna Height (m)	Table Angle (Degree)	Raw Value (dBuV)	Correction Factor (dB/m)
1	1280.00	45.37 PK	74.00	-28.63	1.19 H	360	18.09	27.28
2	1600.00	47.21 PK	74.00	-26.79	1.54 H	32	18.58	28.63
3	2240.00	47.03 PK	74.00	-26.97	1.52 H	318	15.78	31.25
4	*2437.00	107.13 PK			1.28 H	331	75.18	31.95
4	*2437.00	97.68 AV			1.28 H	331	65.73	31.95
5	2811.00	51.71 PK	74.00	-22.29	1.24 H	360	18.30	33.41
5	2811.00	48.79 AV	54.00	-5.21	1.24 H	360	15.38	33.41
6	3200.00	47.01 PK	74.00	-26.99	1.27 H	3	12.04	34.97

ANTENNA POLARITY & TEST DISTANCE: VERTICAL AT 3 M

No.	Freq. (MHz)	Emission Level (dBuV/m)	Limit (dBuV/m)	Margin (dB)	Antenna Height (m)	Table Angle (Degree)	Raw Value (dBuV)	Correction Factor (dB/m)
1	1280.00	50.83 PK	74.00	-23.17	1.18 V	360	23.55	27.28
1	1280.00	48.61 AV	54.00	-5.39	1.18 V	360	21.33	27.28
2	1600.00	48.80 PK	74.00	-25.20	1.11 V	218	20.17	28.63
3	2240.00	49.48 PK	74.00	-24.52	1.36 V	211	18.23	31.25
4	*2437.00	103.71 PK			1.15 V	324	71.76	31.95
4	*2437.00	94.53 AV			1.15 V	324	62.58	31.95
5	2811.00	54.12 PK	74.00	-19.88	1.30 V	64	20.71	33.41
5	2811.00	51.59 AV	54.00	-2.41	1.30 V	64	18.18	33.41
6	3200.00	53.75 PK	74.00	-20.25	1.24 V	310	18.78	34.97
6	3200.00	48.58 AV	54.00	-5.42	1.24 V	310	13.61	34.97
7	9748.00	49.00 PK	74.00	-25.00	1.00 V	10	10.49	38.51

REMARKS:

1. Emission level(dBuV/m)=Raw Value(dBuV) + Correction Factor(dB)
2. Correction Factor(dB/m) = Antenna Factor (dB/m) + Cable Factor (dB)
3. The other emission levels were very low against the limit.
4. Margin value = Emission level – Limit value.
5. “ * “ : Fundamental frequency



EUT	802.11g Wireless USB module	MODEL	WUBR-132G
CHANNEL	11	MODE	OFDM
INPUT POWER (SYSTEM)	120 Vac, 60 Hz	FREQUENCY RANGE	1~25 GHz
ENVIRONMENTAL CONDITIONS	25 deg. C, 58% RH, 991 hPa	DETECTOR FUNCTION	Peak(PK) Average (AV)
TESTED BY	Match Tsui		

ANTENNA POLARITY & TEST DISTANCE: HORIZONTAL AT 3 M								
No.	Freq. (MHz)	Emission Level (dBuV/m)	Limit (dBuV/m)	Margin (dB)	Antenna Height (m)	Table Angle (Degree)	Raw Value (dBuV)	Correction Factor (dB/m)
1	1280.00	51.25 PK	74.00	-22.75	1.08 H	154	23.97	27.28
1	1280.00	49.37 AV	54.00	-4.63	1.08 H	154	22.09	27.28
2	1632.00	46.29 PK	74.00	-27.71	1.19 H	355	17.49	28.80
3	2240.00	49.69 PK	74.00	-24.31	1.03 H	174	18.44	31.25
4	*2462.00	105.68 PK			1.04 H	220	73.66	32.02
4	*2462.00	96.25 AV			1.04 H	220	64.23	32.02
5	2483.50	54.48 PK	74.00	-19.52	1.04 H	220	22.39	32.09
5	2483.50	45.05 AV	54.00	-8.95	1.04 H	220	12.96	32.09
6	2836.00	53.77 PK	74.00	-20.23	1.27 H	62	20.27	33.50
6	2836.00	50.76 AV	54.00	-3.24	1.27 H	62	17.26	33.50
7	9848.00	47.00 PK	74.00	-27.00	1.05 H	286	11.67	35.33

ANTENNA POLARITY & TEST DISTANCE: VERTICAL AT 3 M								
No.	Freq. (MHz)	Emission Level (dBuV/m)	Limit (dBuV/m)	Margin (dB)	Antenna Height (m)	Table Angle (Degree)	Raw Value (dBuV)	Correction Factor (dB/m)
1	1280.00	47.59 PK	74.00	-26.41	1.00 V	336	20.31	27.28
2	1632.00	45.68 PK	74.00	-28.32	1.02 V	344	16.88	28.80
3	2240.00	48.63 PK	74.00	-25.37	1.05 V	1	17.38	31.25
4	*2462.00	108.66 PK			1.26 V	329	76.64	32.02
4	*2462.00	99.26 AV			1.26 V	329	67.24	32.02
5	2483.50	57.46 PK	74.00	-16.54	1.26 V	329	25.37	32.09
5	2483.50	48.06 AV	54.00	-5.94	1.26 V	329	15.97	32.09
6	2836.00	52.98 PK	74.00	-21.02	1.06 V	346	19.48	33.50
6	2836.00	49.44 AV	54.00	-4.56	1.06 V	346	15.94	33.50
7	9848.00	45.82 PK	74.00	-28.18	1.07 V	63	10.49	35.33

REMARKS:

1. Emission level(dBuV/m)=Raw Value(dBuV) + Correction Factor(dB)
2. Correction Factor(dB/m) = Antenna Factor (dB/m) + Cable Factor (dB)
3. The other emission levels were very low against the limit.
4. Margin value = Emission level – Limit value.
5. " * " : Fundamental frequency



4.3 6dB BANDWIDTH MEASUREMENT

4.3.1 LIMITS OF 6dB BANDWIDTH MEASUREMENT

The minimum of 6dB Bandwidth Measurement is 0.5MHz.

4.3.2 TEST INSTRUMENTS

Description & Manufacturer	Model No.	Serial No.	Calibrated Until
SPECTRUM ANALYZER	FSEK30	100049	Aug. 12, 2005

NOTE:

The calibration interval of the above test instruments is 12 months and the calibrations are traceable to NML/ROC and NIST/USA.

4.3.3 TEST PROCEDURE

The transmitter output was connected to the spectrum analyzer through an attenuator. The bandwidth of the fundamental frequency was measured by spectrum analyzer with 100kHz RBW and 100kHz VBW. The 6dB bandwidth is defined as the total spectrum the power of which is higher than peak power minus 6dB.

4.3.4 DEVIATION FROM TEST STANDARD

No deviation

4.3.5 TEST SETUP

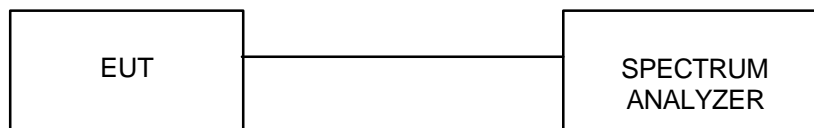

For the actual test configuration, please refer to the related Item – Photographs of the Test Configuration.

4.3.6 EUT OPERATING CONDITIONS

The software provided by client to enable the EUT under transmission condition continuously at lowest, middle and highest channel frequencies individually.



4.3.7 TEST RESULTS

EUT	802.11g Wireless USB module	MODEL	WUBR-132G
INPUT POWER (SYSTEM)	120 Vac, 60 Hz	MODE	CCK
ENVIRONMENTAL CONDITIONS	25 deg. C, 65% RH, 991 hPa	TESTED BY	Rush Kao

CHANNEL	CHANNEL FREQUENCY (MHz)	6dB BANDWIDTH (MHz)	MINIMUM LIMIT (MHz)	PASS/FAIL
1	2412	11.16	0.5	PASS
6	2437	11.60	0.5	PASS
11	2462	11.68	0.5	PASS



CH1

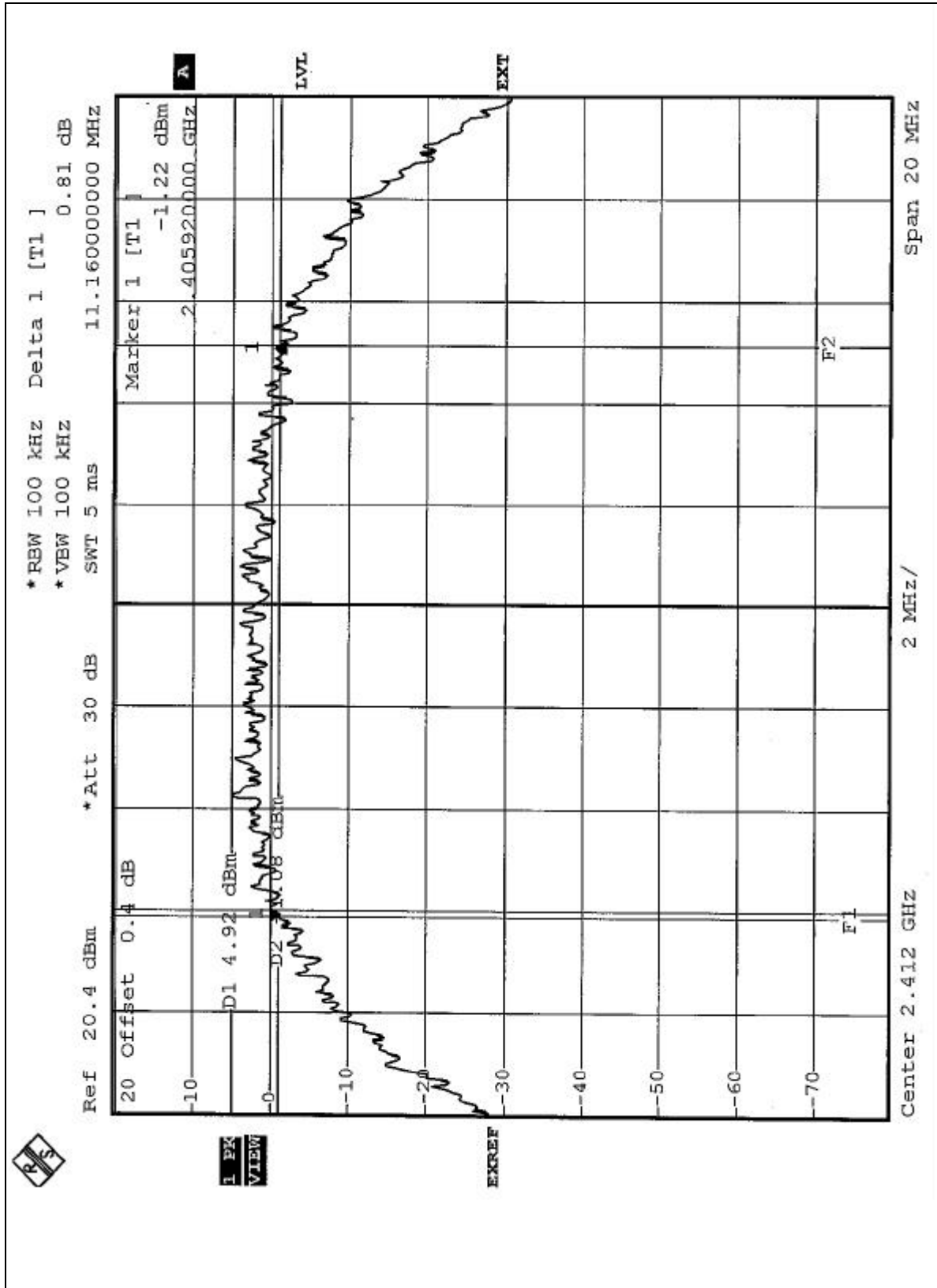



CH6

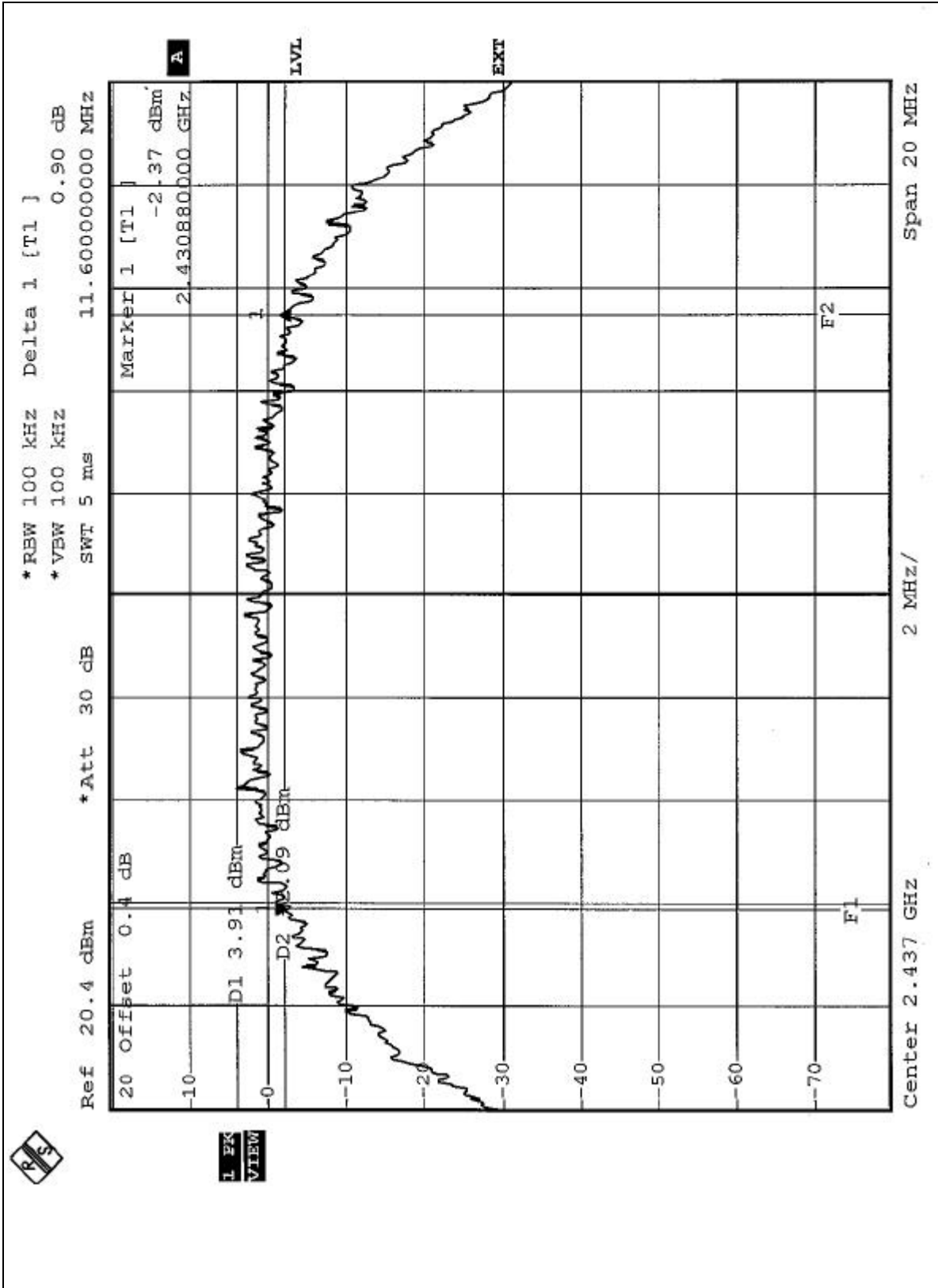



CH11

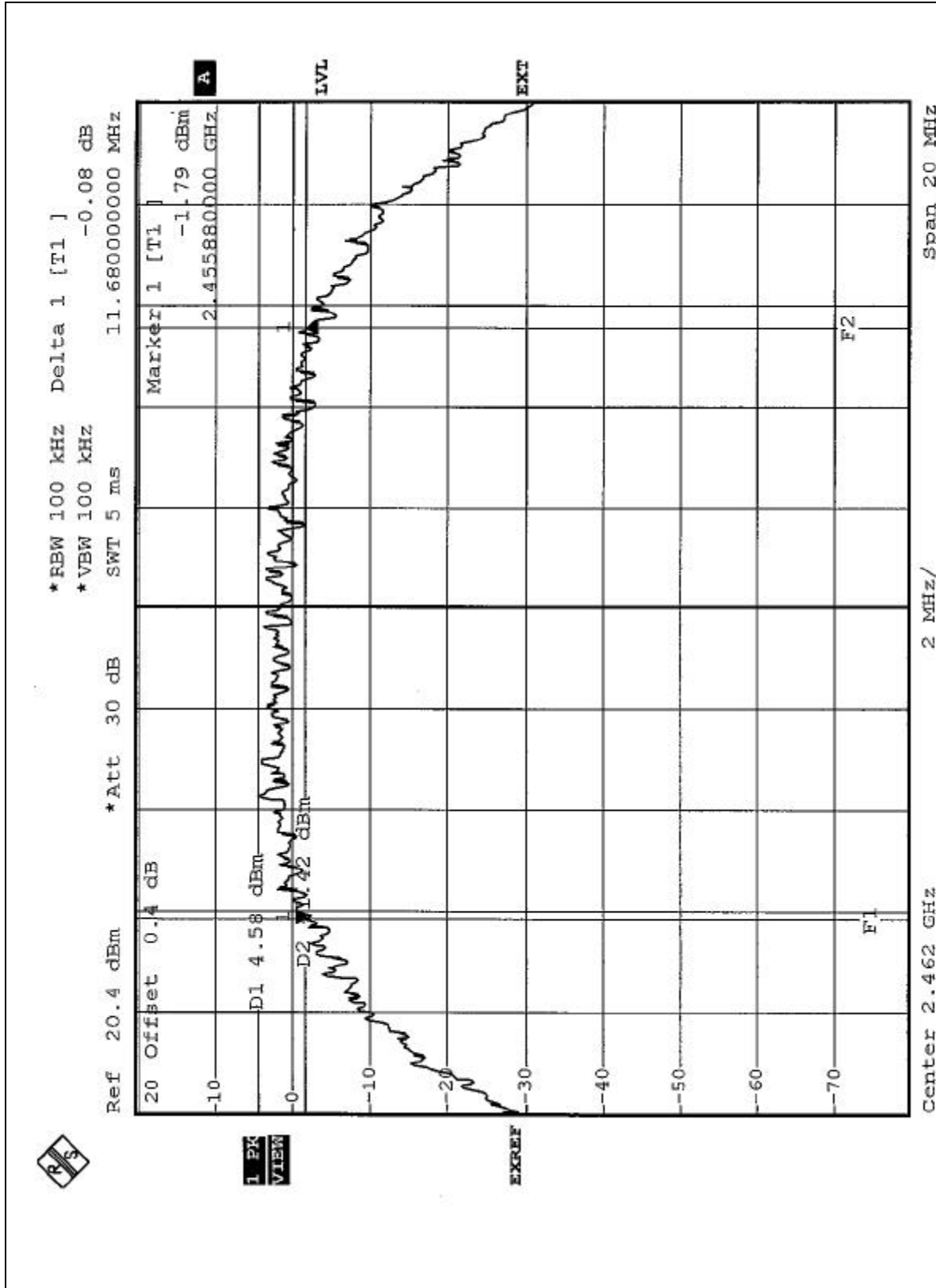



EUT	802.11g Wireless USB module	MODEL	WUBR-132G
INPUT POWER (SYSTEM)	120 Vac, 60 Hz	MODE	OFDM
ENVIRONMENTAL CONDITIONS	25 deg. C, 65% RH, 991 hPa	TESTED BY	Rush Kao

CHANNEL	CHANNEL FREQUENCY (MHz)	6 dB BANDWIDTH (MHz)	MINIMUM LIMIT (MHz)	PASS/FAIL
1	2412	16.48	0.5	PASS
6	2437	16.52	0.5	PASS
11	2462	16.52	0.5	PASS



CH1

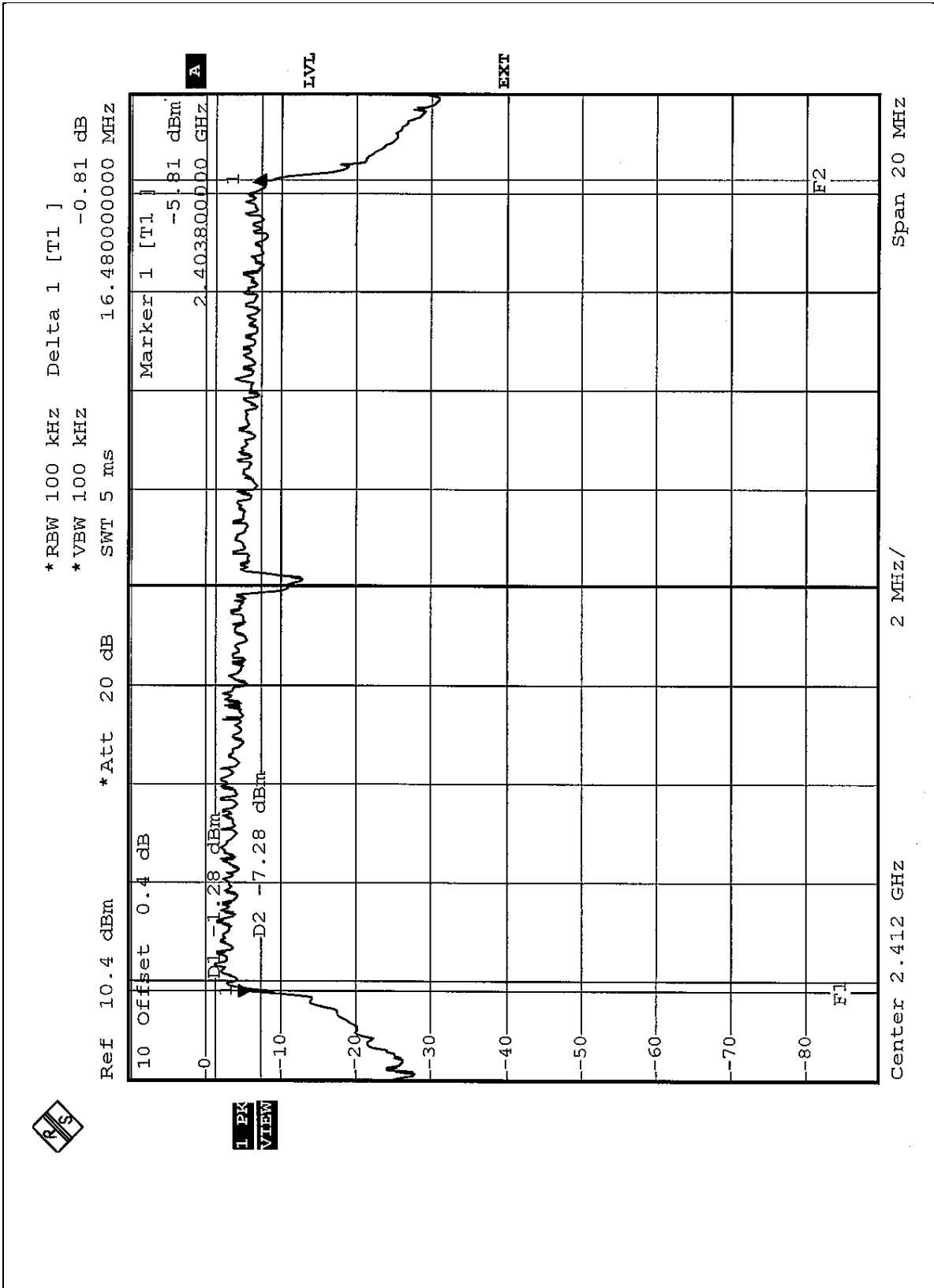



CH6

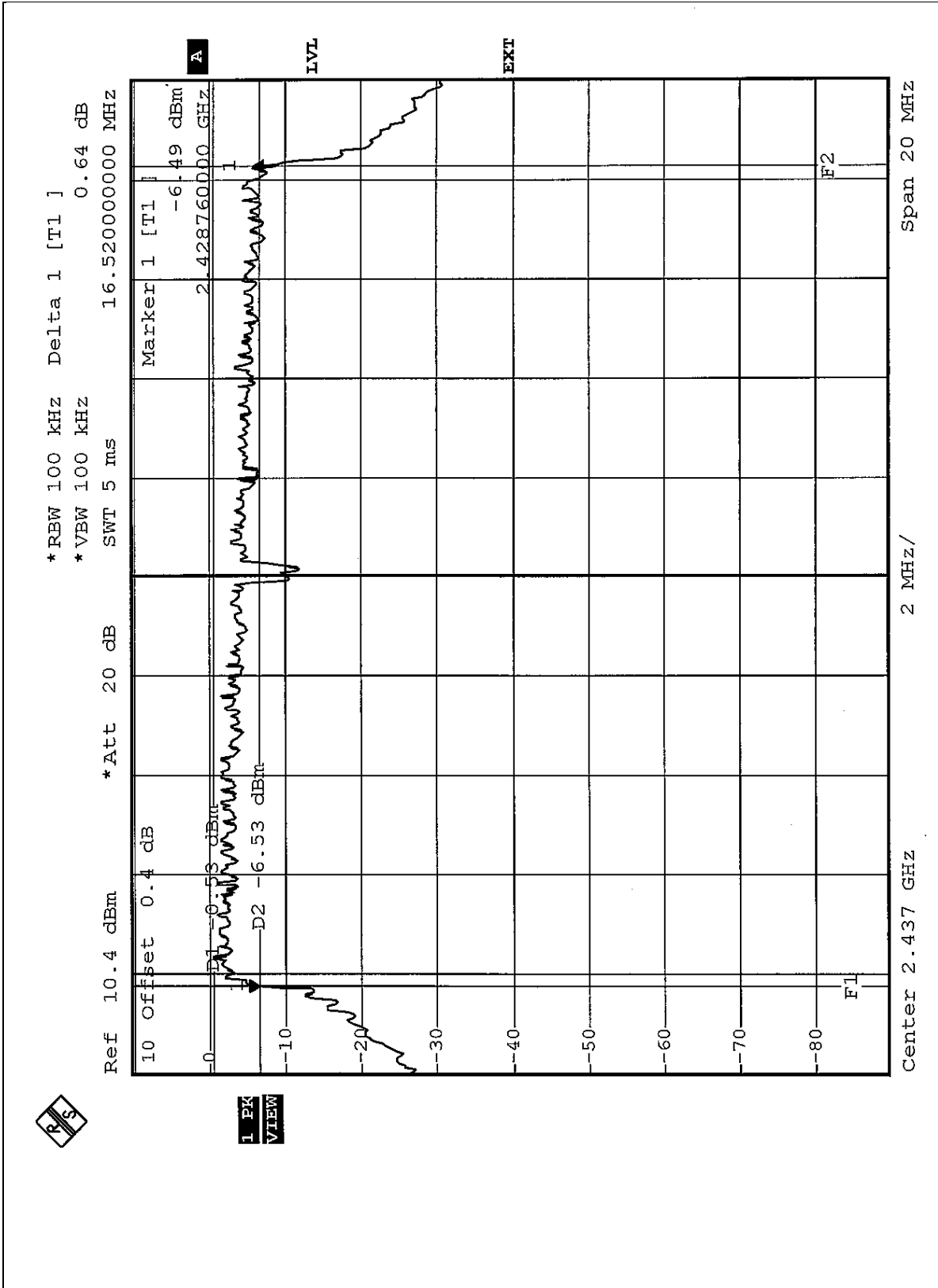

1 PK VIEW



CH11

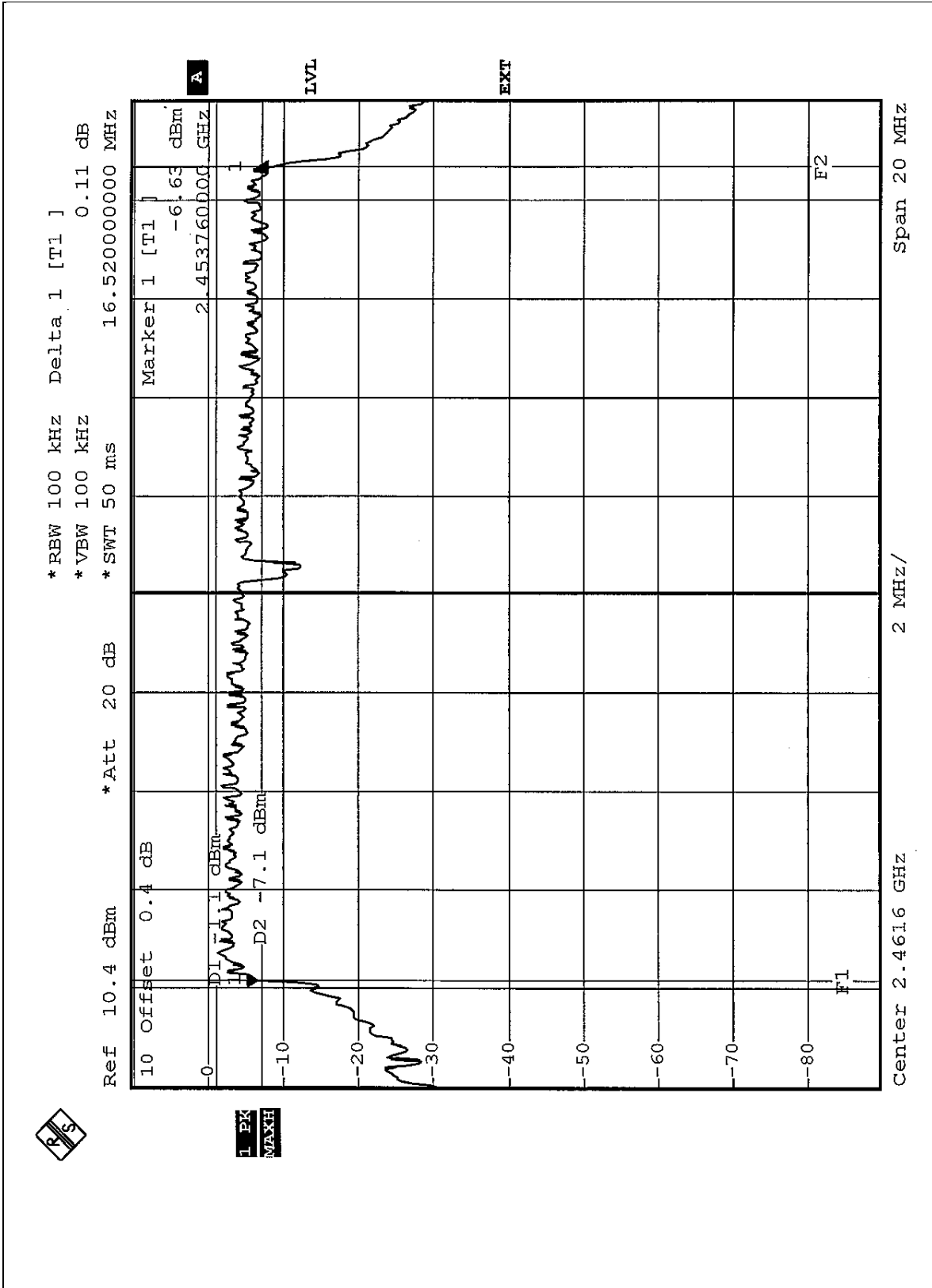



4.4 MAXIMUM PEAK OUTPUT POWER

4.4.1 LIMITS OF MAXIMUM PEAK OUTPUT POWER MEASUREMENT

The Maximum Peak Output Power Measurement is 30dBm.

4.4.2 TEST INSTRUMENTS

Description & Manufacturer	Model No.	Serial No.	Calibrated Until
R&S SPECTRUM ANALYZER	FSEK30	100049	Aug. 12, 2005
AGILENT SIGNAL GENERATOR	E8257C	MY43320668	Dec. 31, 2004
TEKTRONIX OSCILLOSCOPE	TDS 220	C019167	Feb. 1, 2005
NARDA DETECTOR	4503A	FSCM99899	NA

NOTE:

The calibration interval of the above test instruments is 12 months and the calibrations are traceable to NML/ROC and NIST/USA.



4.4.3 TEST PROCEDURES

1. A detector was used on the output port of the EUT. An oscilloscope was used to read the response of the detector.
2. Replaced the EUT by the signal generator. The center frequency of the S.G. was adjusted to the center frequency of the measured channel.
3. Adjusted the power to have the same reading on oscilloscope. Record the power level.

4.4.4 DEVIATION FROM TEST STANDARD

No deviation

4.4.5 TEST SETUP

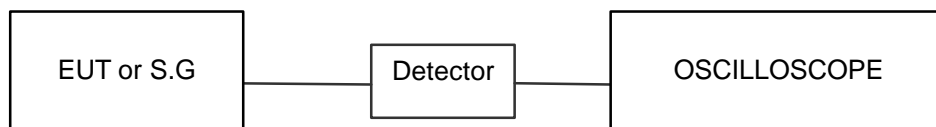

4.4.6 EUT OPERATING CONDITIONS

Same as Item 4.3.6



4.4.7 TEST RESULTS

EUT	802.11g Wireless USB module	MODEL	WUBR-132G
INPUT POWER (SYSTEM)	120 Vac, 60 Hz	MODE	CCK
ENVIRONMENTAL CONDITIONS	25 deg. C, 65% RH, 991 hPa	TESTED BY	Rush Kao

CHANNEL	CHANNEL FREQUENCY (MHz)	PEAK POWER OUTPUT (dBm)	PEAK POWER LIMIT (dBm)	PASS/FAIL
1	2412	16.03	30	PASS
6	2437	16.04	30	PASS
11	2462	16.02	30	PASS

EUT	802.11g Wireless USB module	MODEL	WUBR-132G
INPUT POWER (SYSTEM)	120 Vac, 60 Hz	MODE	OFDM
ENVIRONMENTAL CONDITIONS	25 deg. C, 65% RH, 991 hPa	TESTED BY	Rush Kao

CHANNEL	CHANNEL FREQUENCY (MHz)	PEAK POWER OUTPUT (dBm)	PEAK POWER LIMIT (dBm)	PASS/FAIL
1	2412	14.01	30	PASS
6	2437	14.00	30	PASS
11	2462	14.03	30	PASS



4.5 POWER SPECTRAL DENSITY MEASUREMENT

4.5.1 LIMITS OF POWER SPECTRAL DENSITY MEASUREMENT

The Maximum of Power Spectral Density Measurement is 8dBm.

4.5.2 TEST INSTRUMENTS

Description & Manufacturer	Model No.	Serial No.	Calibrated Until
SPECTRUM ANALYZER	FSEK30	100049	Aug. 12, 2005

NOTE:

The calibration interval of the above test instruments is 12 months and the calibrations are traceable to NML/ROC and NIST/USA.

4.5.3 TEST PROCEDURE

The transmitter output was connected to the spectrum analyzer through an attenuator, the bandwidth of the fundamental frequency was measured with the spectrum analyzer using 3 kHz RBW and 30 kHz VBW, set sweep time=span/3kHz. The power spectral density was measured and recorded. The sweep time is allowed to be longer than span/3kHz for a full response of the mixer in the spectrum analyzer.

4.5.4 DEVIATION FROM TEST STANDARD

No deviation

4.5.5 TEST SETUP

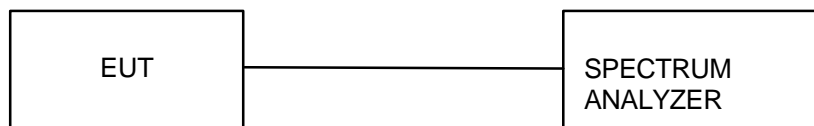

4.5.6 EUT OPERATING CONDITIONS

Same as 4.3.6



4.5.7 TEST RESULTS

EUT	802.11g Wireless USB module	MODEL	WUBR-132G
INPUT POWER (SYSTEM)	120 Vac, 60 Hz	MODE	CCK
ENVIRONMENTAL CONDITIONS	25 deg. C, 65% RH, 991 hPa	TESTED BY	Rush Kao

CHANNEL NUMBER	CHANNEL FREQUENCY (MHz)	RF POWER LEVEL IN 3KHz BW (dBm)	MAXIMUM LIMIT (dBm)	PASS/FAIL
1	2412	-9.36	8	PASS
6	2437	-9.93	8	PASS
11	2462	-8.56	8	PASS



CH1

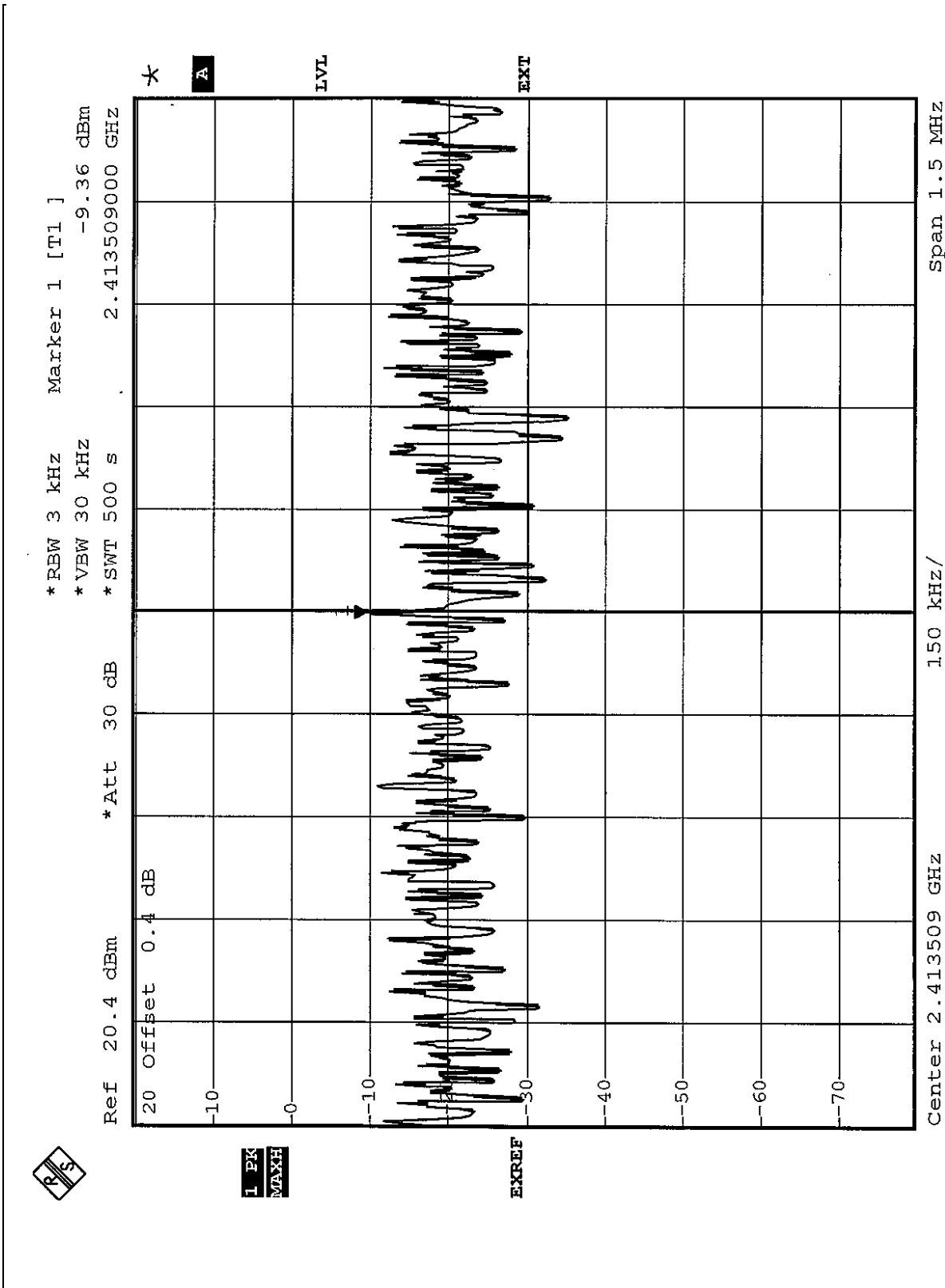



CH6

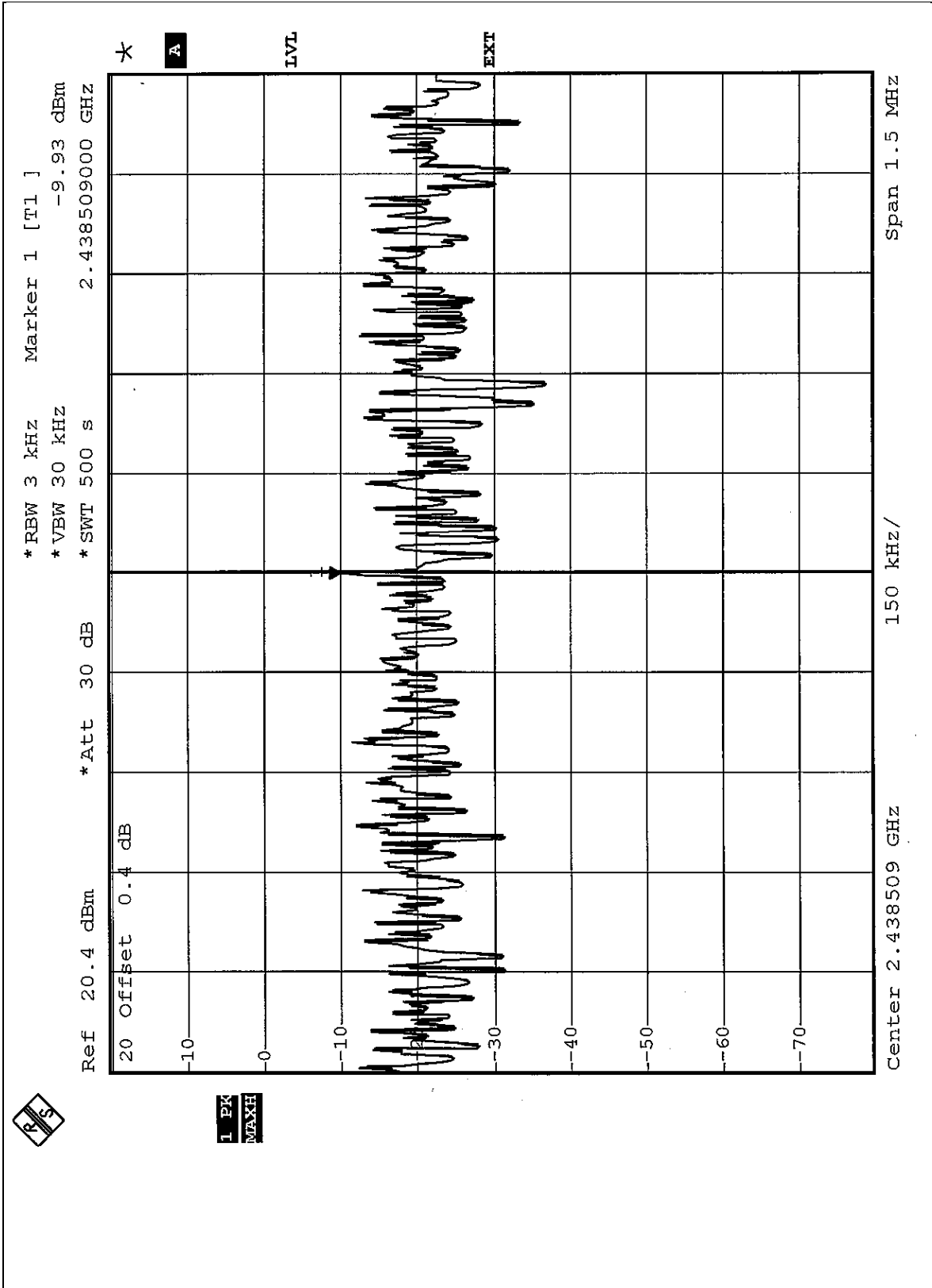



CH11

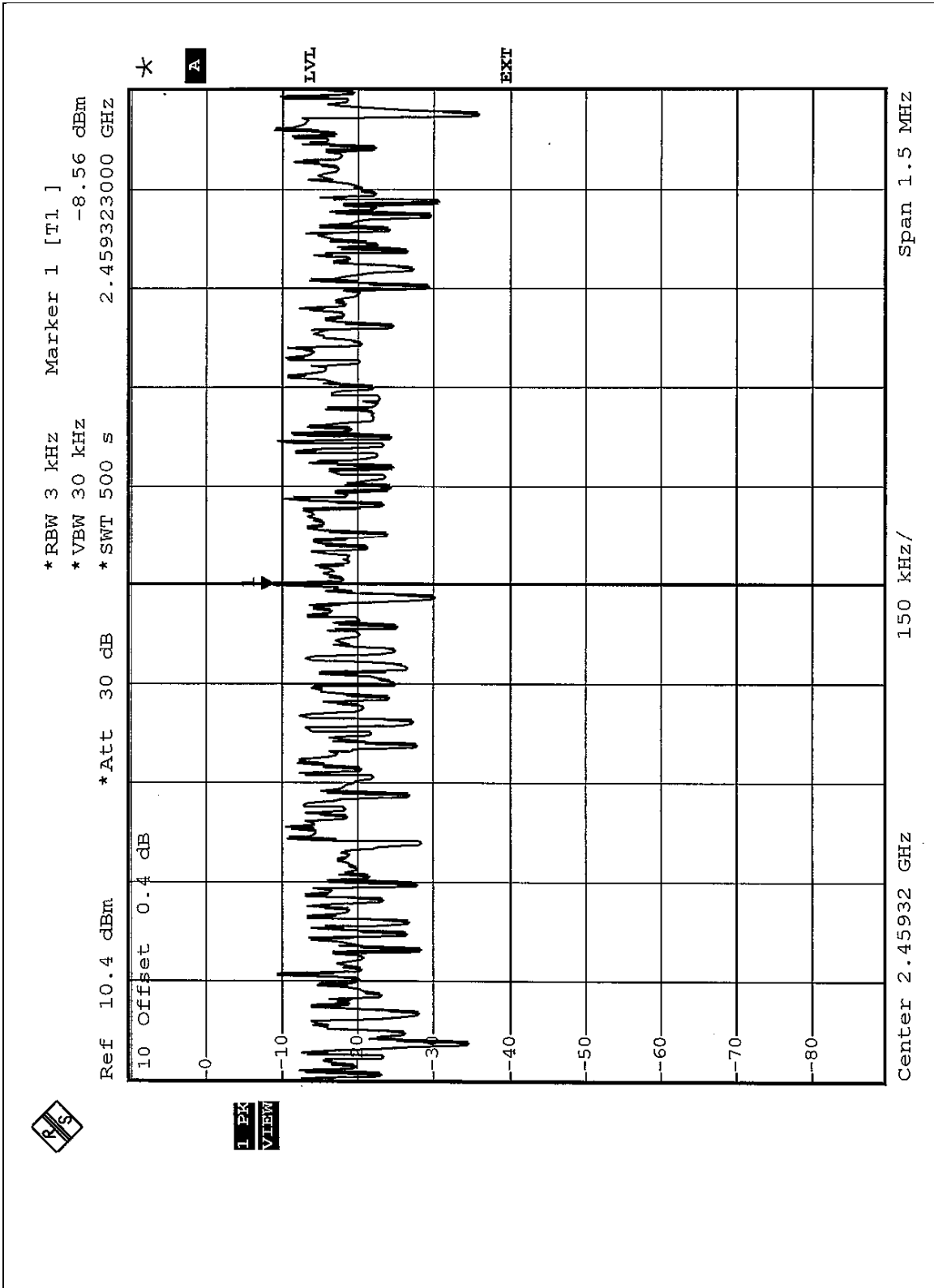



EUT	802.11g Wireless USB module	MODEL	WUBR-132G
INPUT POWER (SYSTEM)	120 Vac, 60 Hz	MODE	OFDM
ENVIRONMENTAL CONDITIONS	25 deg. C, 65% RH, 991 hPa	TESTED BY	Rush Kao

CHANNEL NUMBER	CHANNEL FREQUENCY (MHz)	RF POWER LEVEL IN 3KHz BW (dBm)	MAXIMUM LIMIT (dBm)	PASS/FAIL
1	2412	-14.49	8	PASS
6	2437	-14.12	8	PASS
11	2462	-15.44	8	PASS



CH1

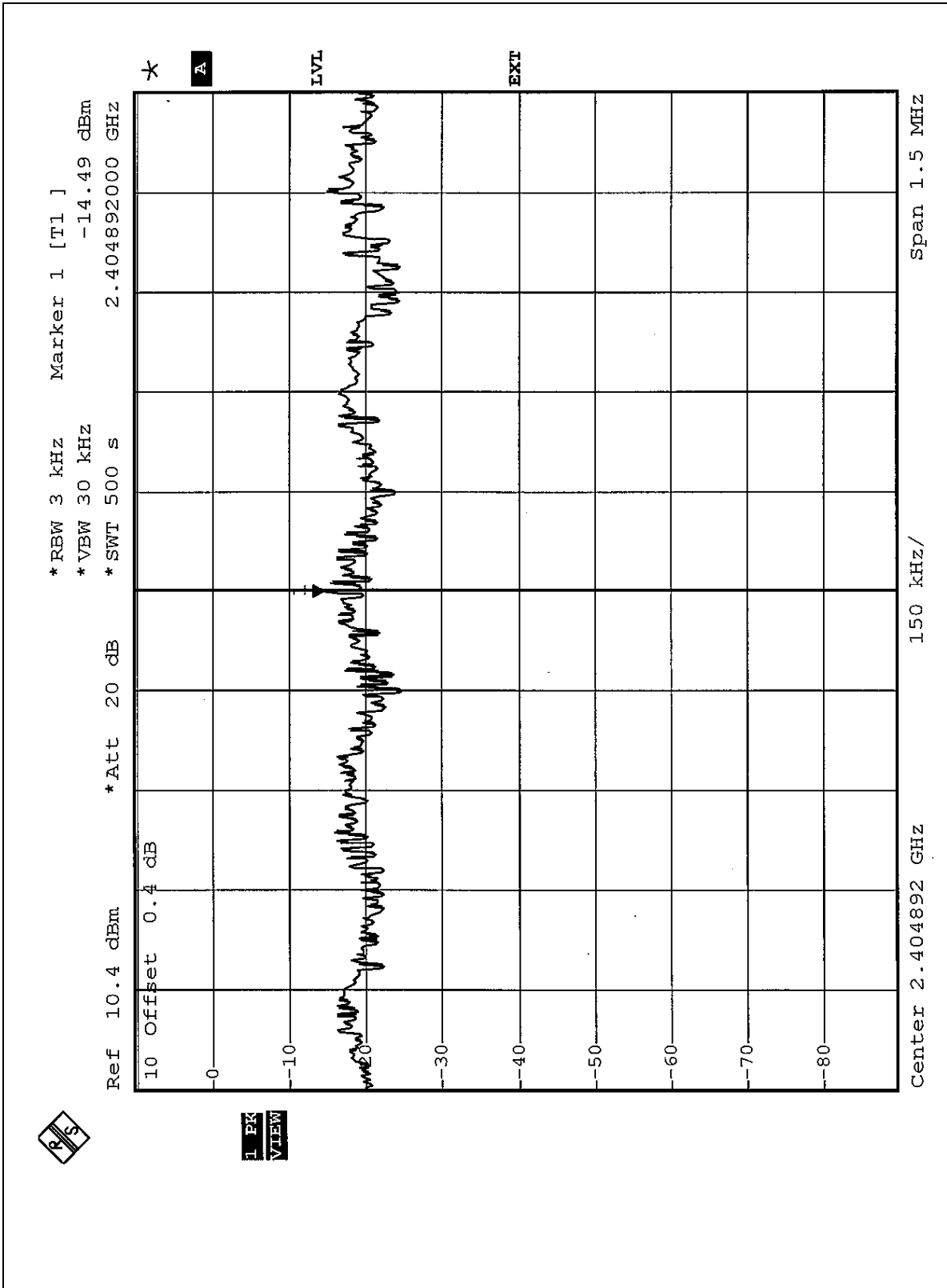



CH6

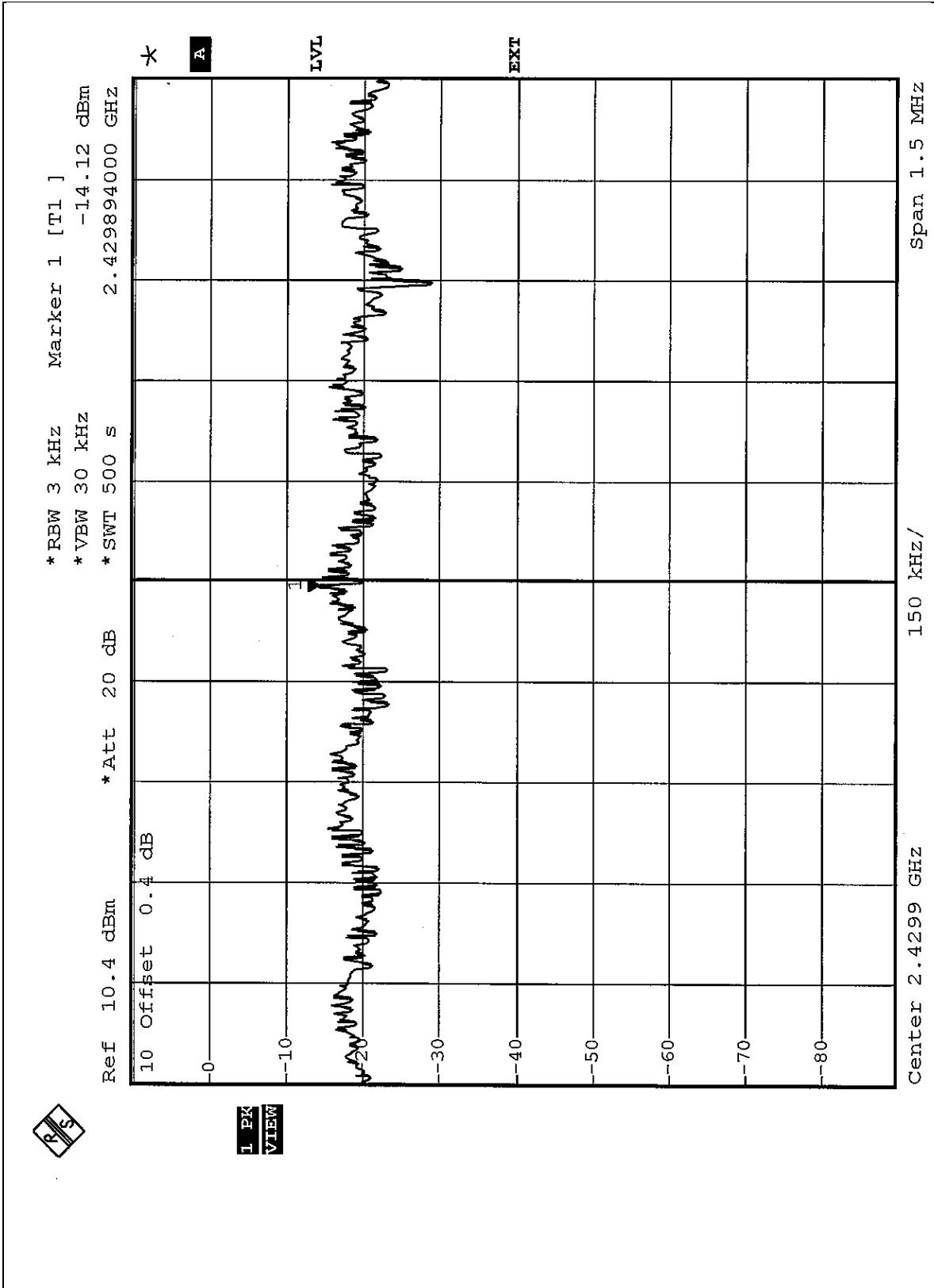



CH11

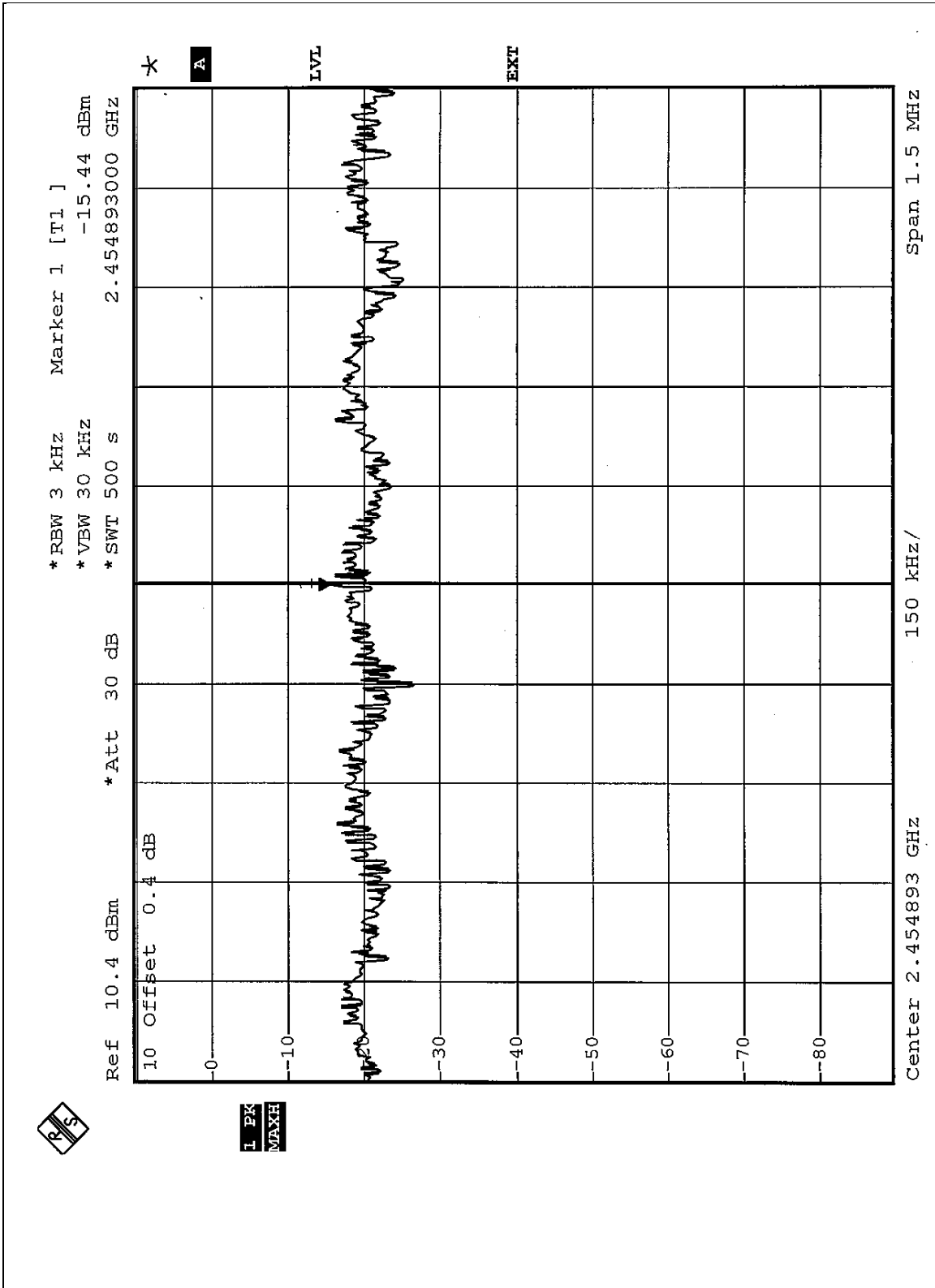



4.6 BAND EDGES MEASUREMENT

4.6.1 LIMITS OF BAND EDGES MEASUREMENT

Below -20dB of the highest emission level of operating band (in 100kHz Resolution Bandwidth).

4.6.2 TEST INSTRUMENTS

Description & Manufacturer	Model No.	Serial No.	Calibrated Until
SPECTRUM ANALYZER	FSEK30	100049	Aug. 12, 2005

NOTE:

The calibration interval of the above test instruments is 12 months and the calibrations are traceable to NML/ROC and NIST/USA.

4.6.3 TEST PROCEDURE

The transmitter output was connected to the spectrum analyzer via a low lose cable. Set both RBW and VBW of spectrum analyzer to 1MHz and 10Hz with suitable frequency span including 100MHz bandwidth from band edge. The band edges was measured and recorded.

4.6.4 DEVIATION FROM TEST STANDARD

No deviation

4.6.5 EUT OPERATING CONDITION

Same as Item 4.3.6



4.6.6 TEST RESULTS

The spectrum plots are attached on the following 8 pages. D2 line indicates the highest level, D1 line indicates the 20dB offset below D2. It shows compliance with the requirement in part 15.247(C).

NOTE (CCK):

The band edge emission plot on the following 1 ~ 2 pages show 52.36dB delta between carrier maximum power and local maximum emission in restrict band (2.3862GHz). The emission of carrier strength list in the test result of channel 1 at the item 4.2.7 is 102.32dBuV/m, so the maximum field strength in restrict band is $102.32-52.36=49.96$ dBuV/m which is under 54dBuV/m limit.

The band edge emission plot on the following 3 ~ 4 pages show 50.91dB delta between carrier maximum power and local maximum emission in restrict band (2.4868GHz). The emission of carrier strength list in the test result of channel 11 at the item 4.2.7 is 104.20dBuV/m, so the maximum field strength in restrict band is $104.20-50.91=53.29$ dBuV/m which is under 54dBuV/m limit.

NOTE (OFDM):

The band edge emission plot on the following 5 ~ 6 pages show 48.75dB delta between carrier maximum power and local maximum emission in restrict band (2.3900GHz). The emission of carrier strength list in the test result of channel 1 at the item 4.2.7 is 96.15dBuV/m, so the maximum field strength in restrict band is $96.15-48.75=47.40$ dBuV/m which is under 54dBuV/m limit.

The band edge emission plot on the following 7 ~ 8 pages show 48.70dB delta between carrier maximum power and local maximum emission in restrict band (2.4835GHz). The emission of carrier strength list in the test result of channel 11 at the item 4.2.7 is 99.26dBuV/m, so the maximum field strength in restrict band is $99.26-48.70=50.56$ dBuV/m which is under 54dBuV/m limit.

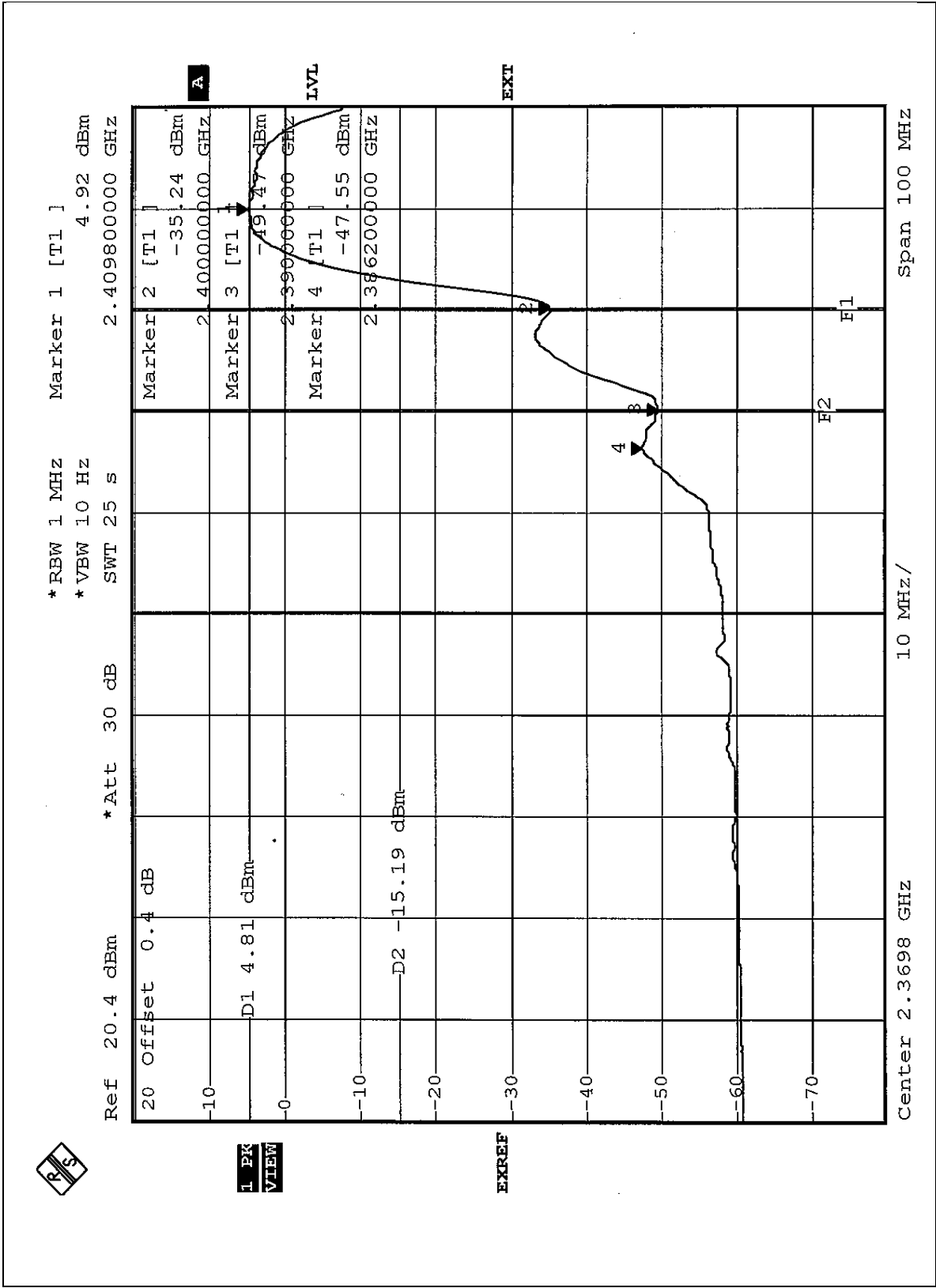

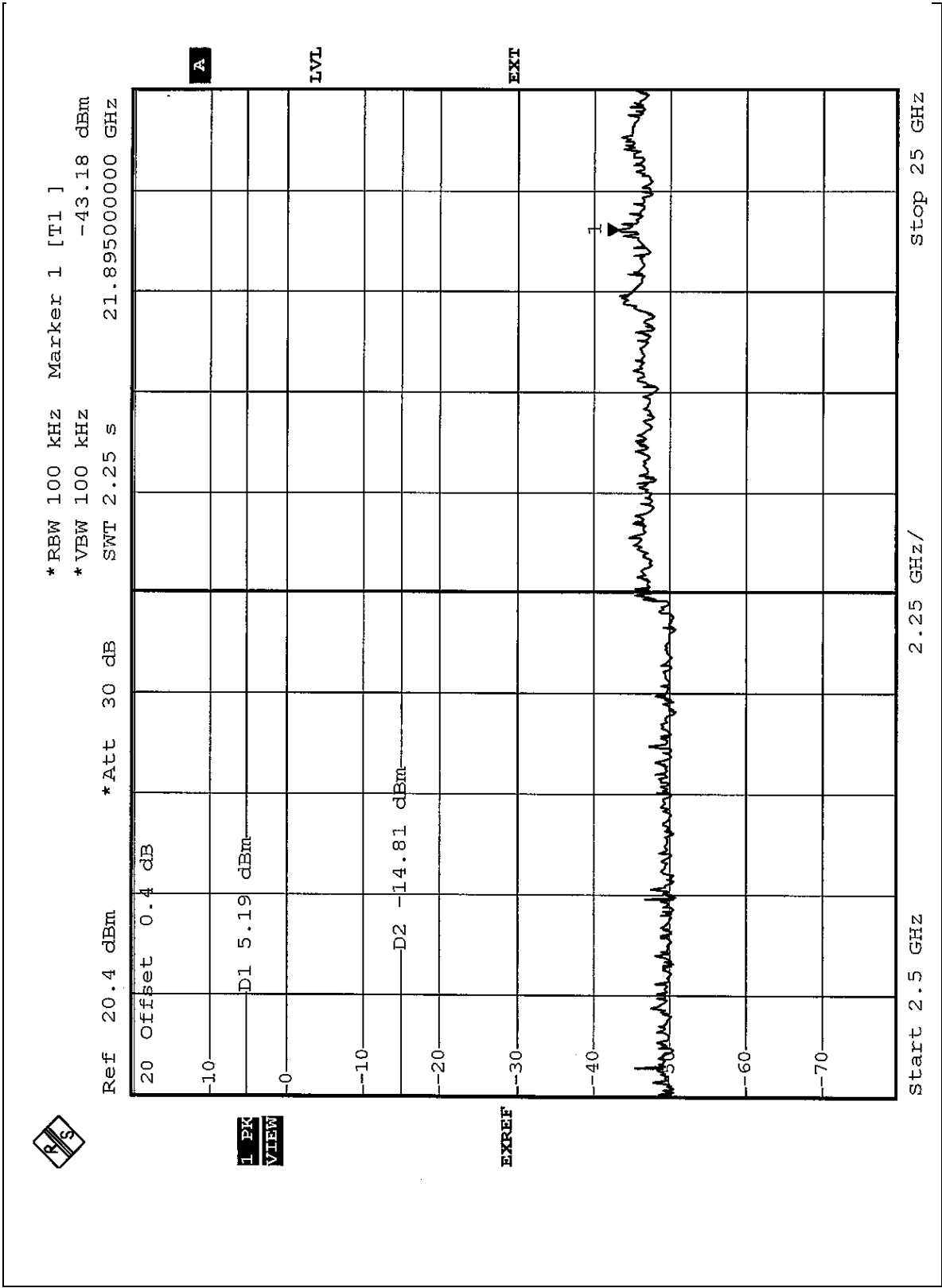

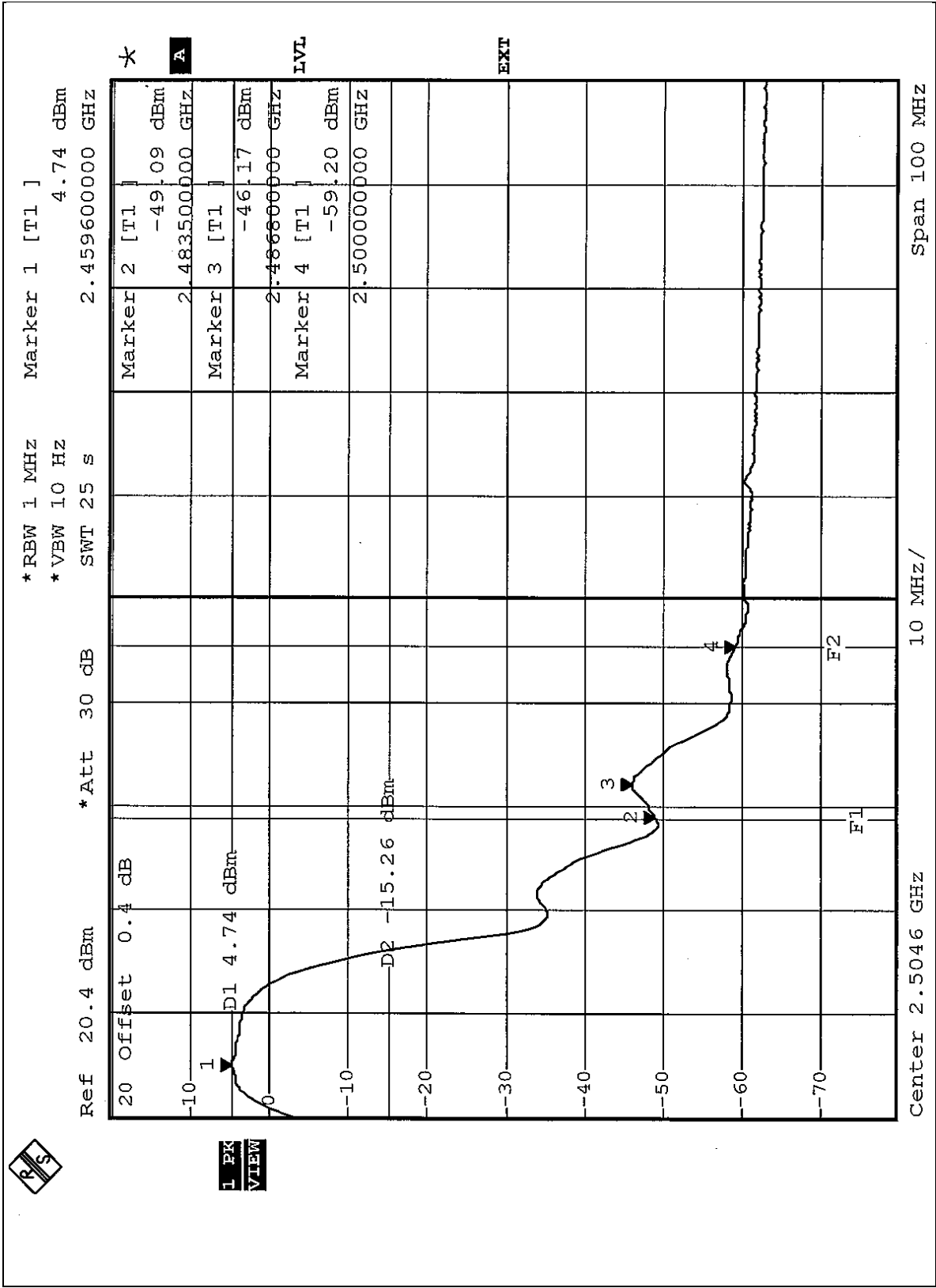

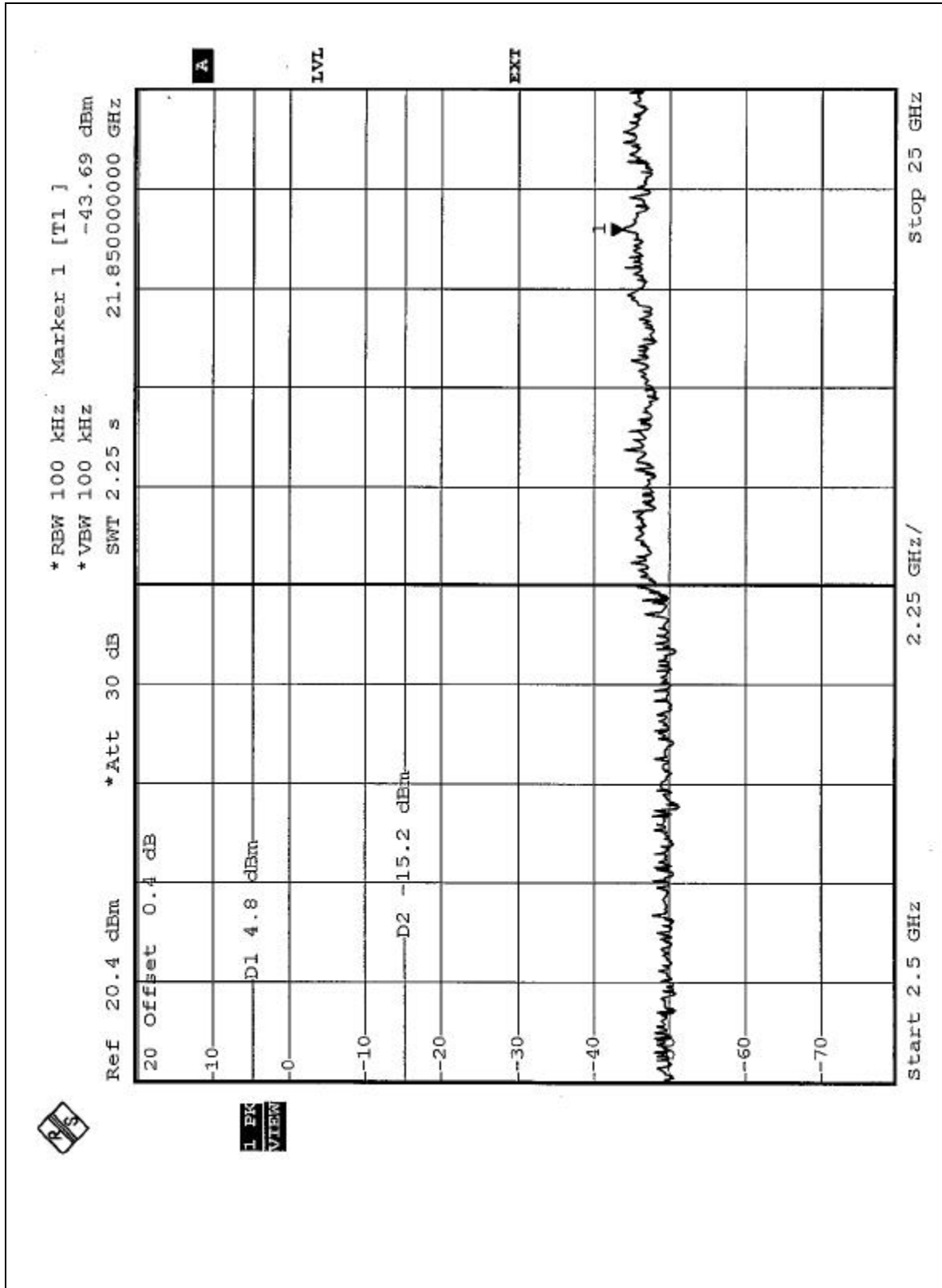

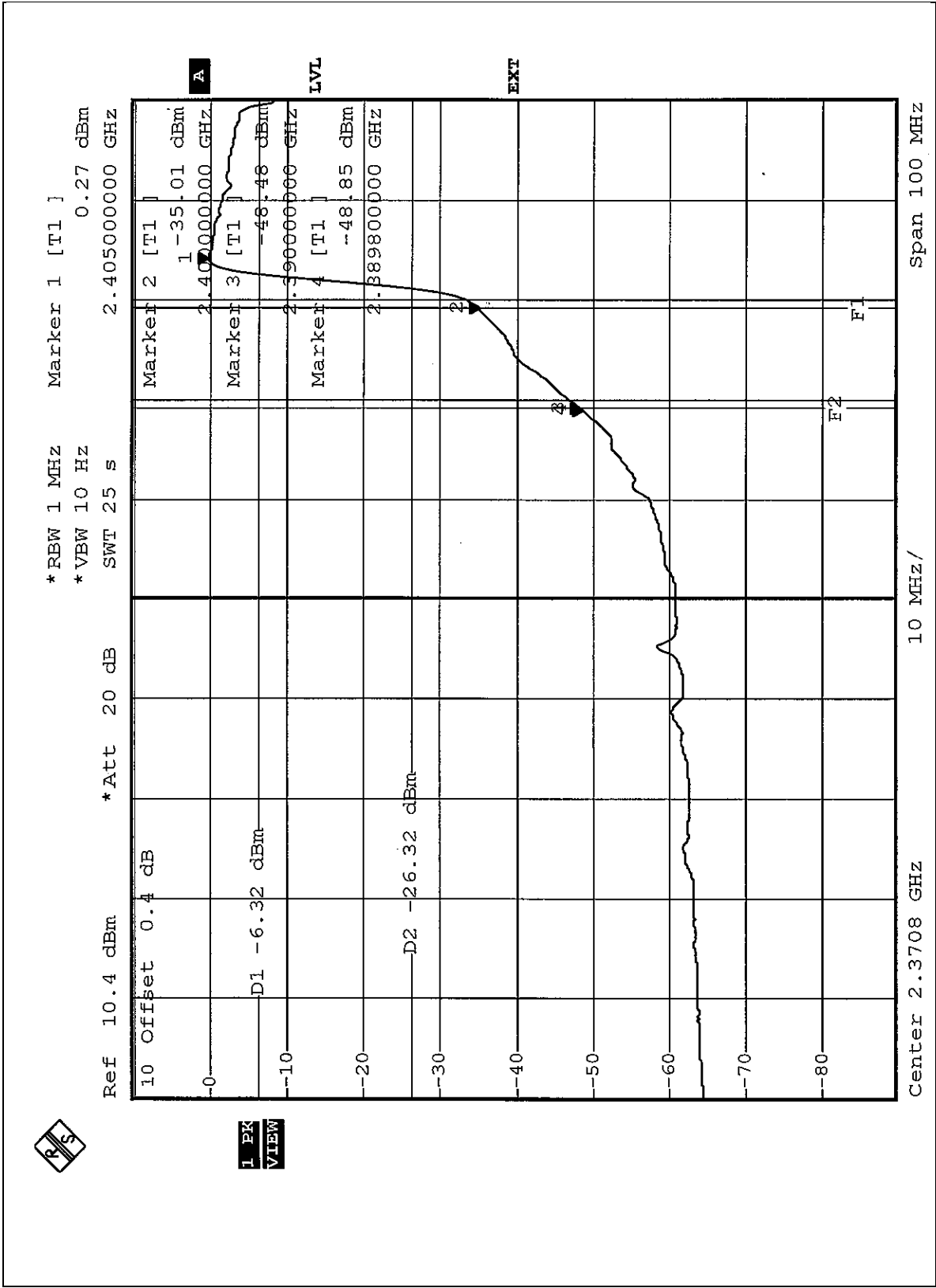

1 PK VIEW

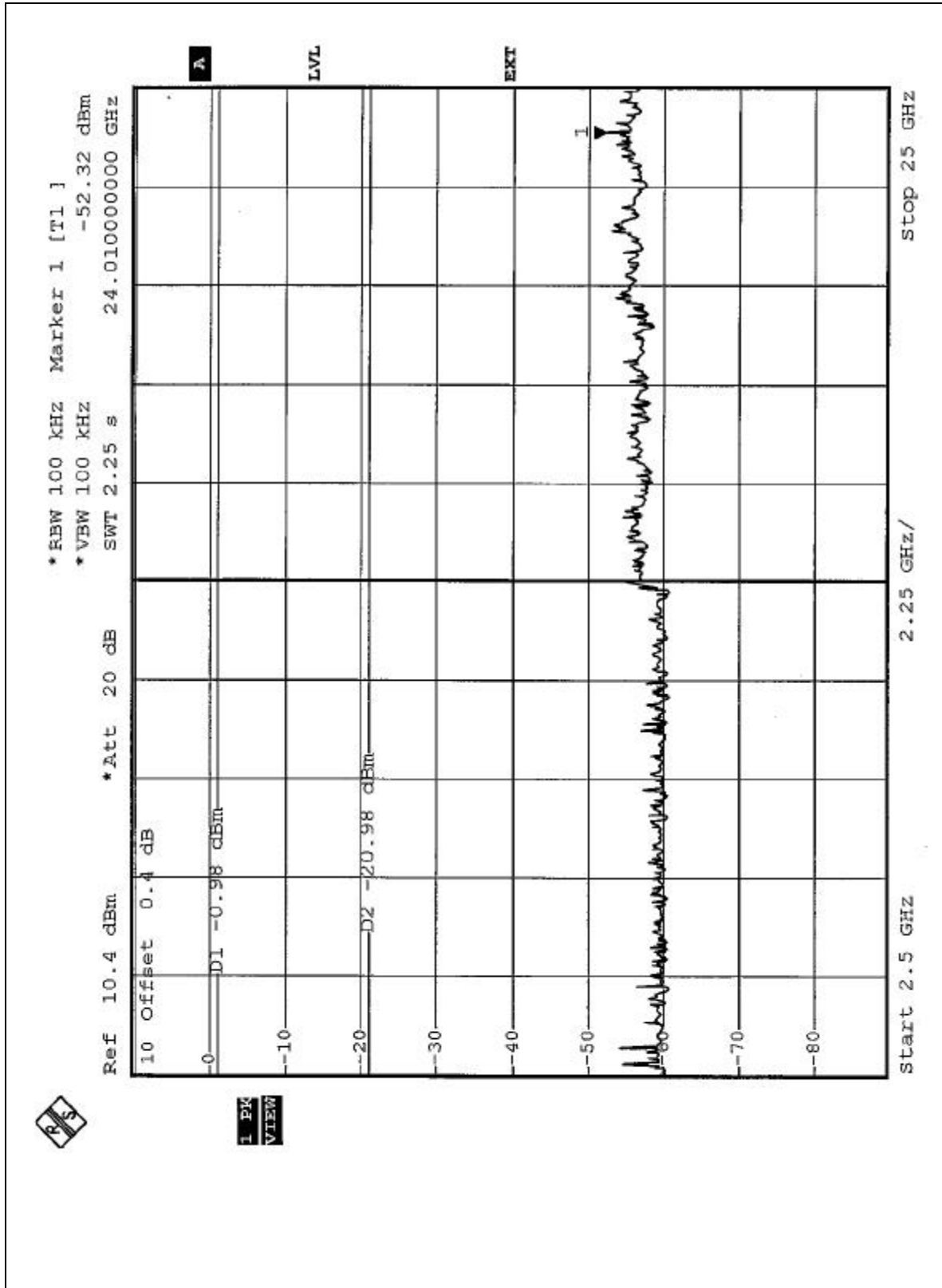

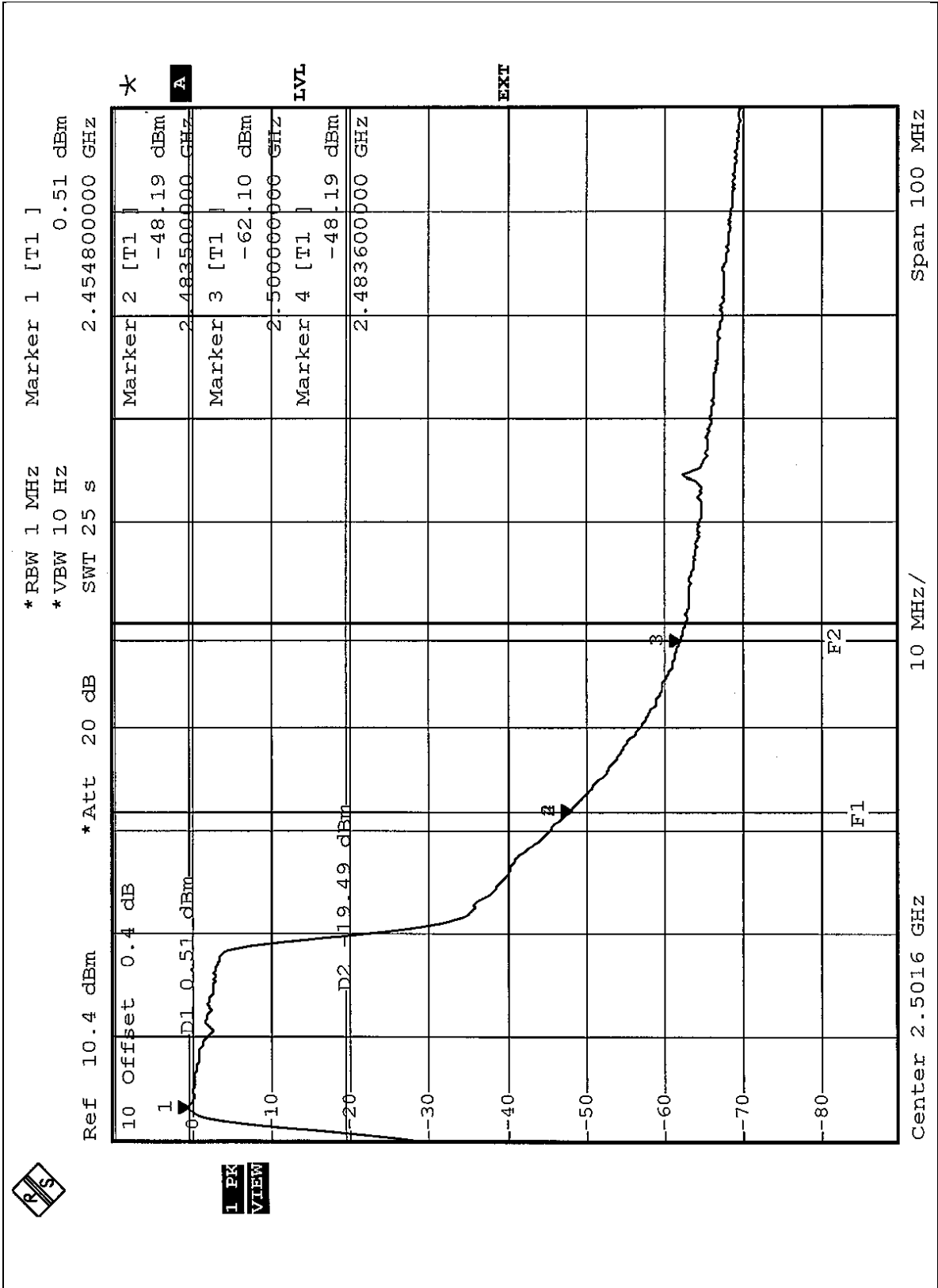

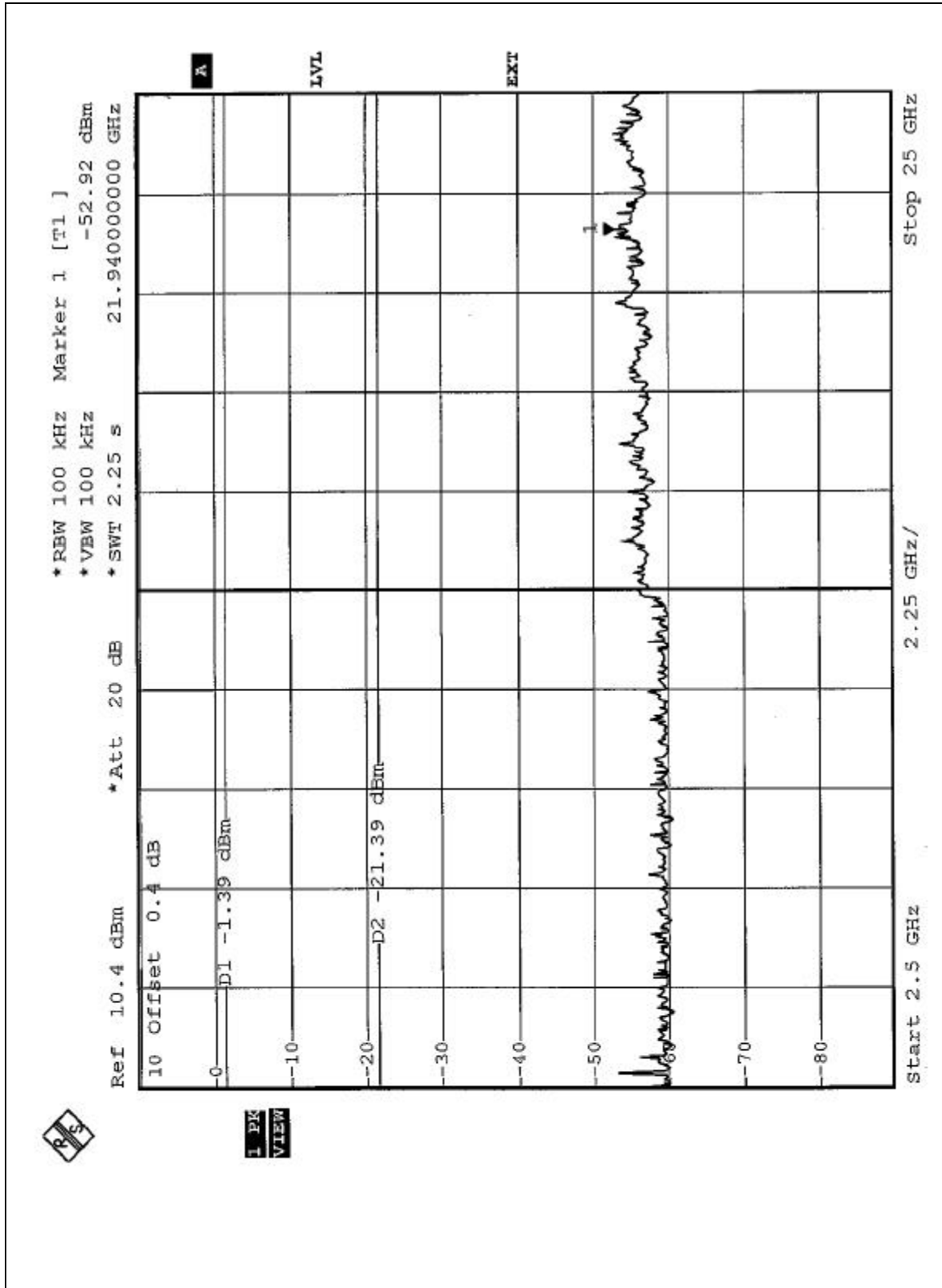



4.7 ANTENNA REQUIREMENT

4.7.1 STANDARD APPLICABLE

For intentional device, according to FCC 47 CFR Section 15.203, an intentional radiator shall be designed to ensure that no antenna other than that furnished by the responsible party shall be used with the device.

And according to FCC 47 CFR Section 15.247 (b), if transmitting antennas of directional gain greater than 6dBi are used, the power shall be reduced by the amount in dB that the directional gain of the antenna exceeds 6dBi.

4.7.2 ANTENNA CONNECTED CONSTRUCTION

The antenna used in this product is PIFA antenna with UFL connector. And the maximum Gain of this antenna is 2.68dBi.

5 PHOTOGRAPHS OF THE TEST CONFIGURATION CONDUCTED EMISSION TEST

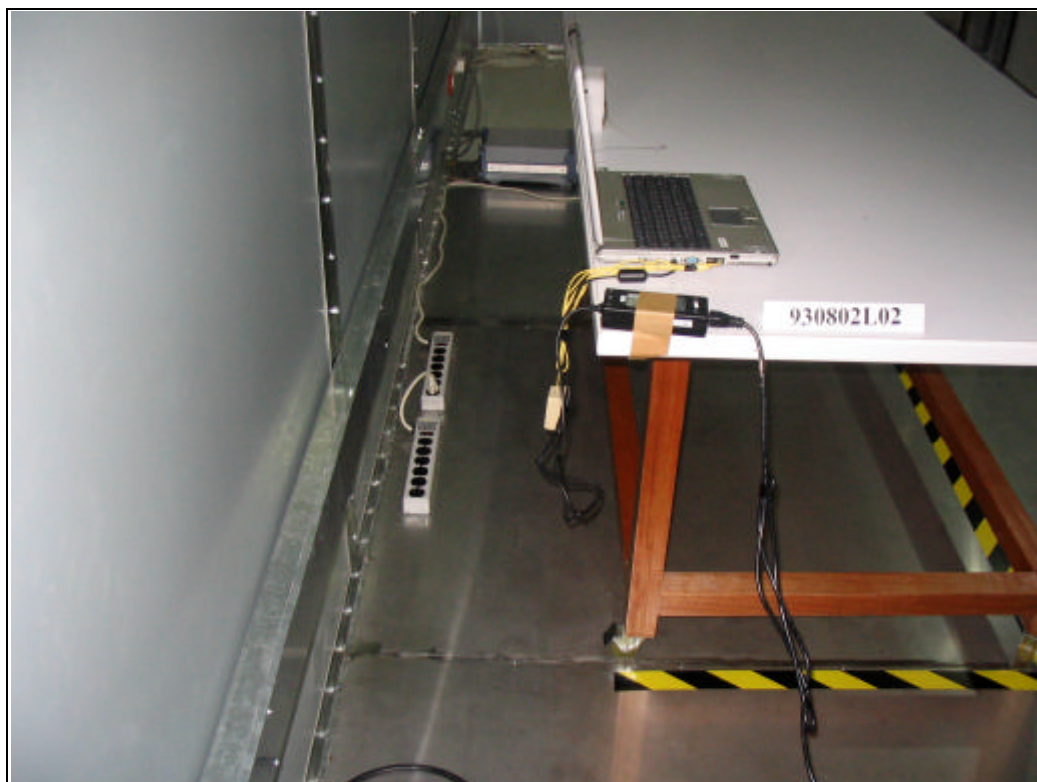



RADIATED EMISSION TEST

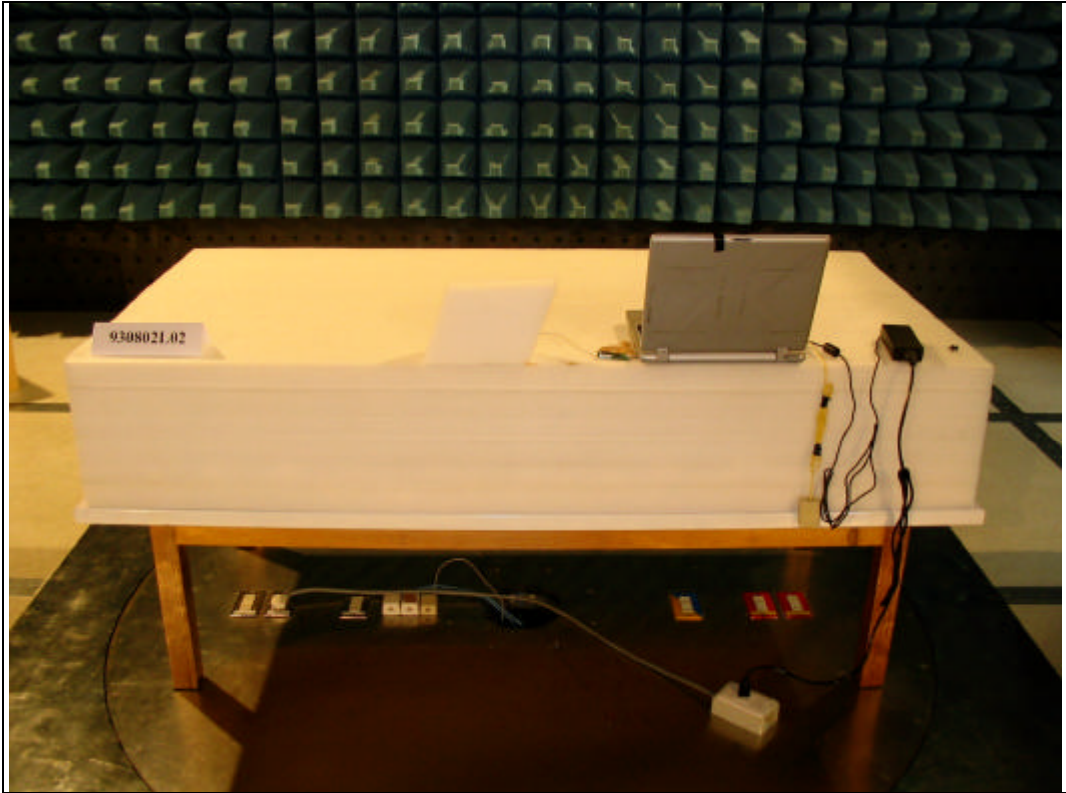
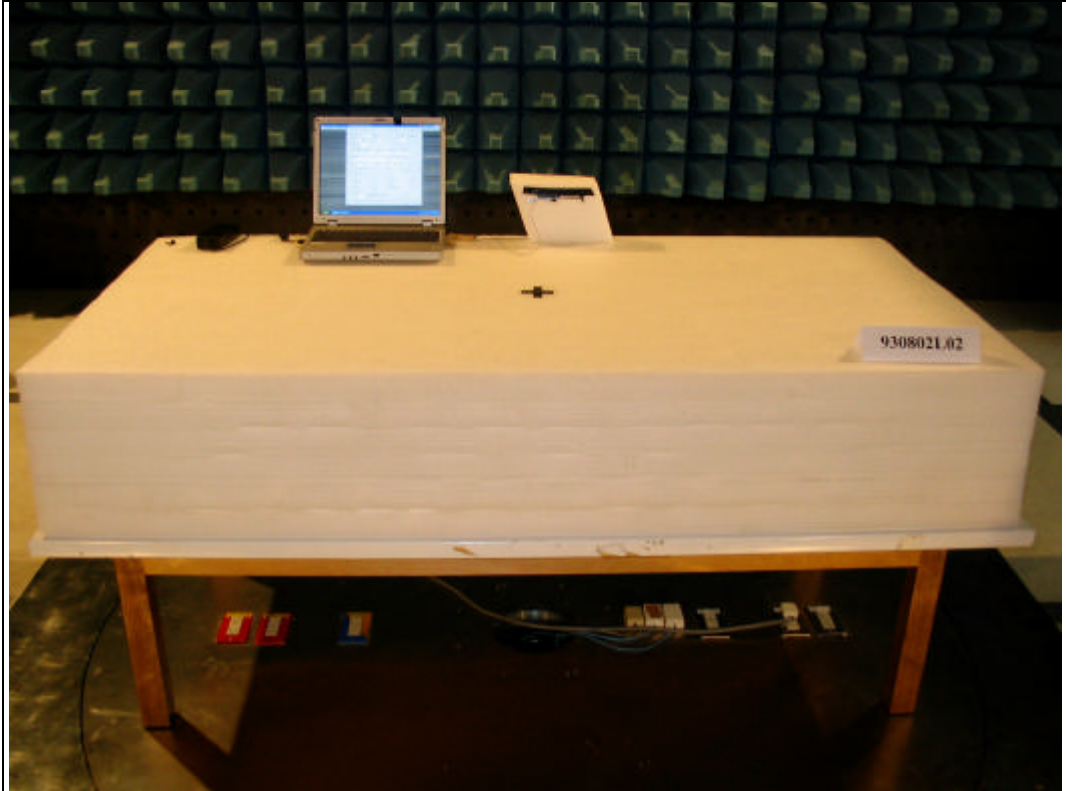

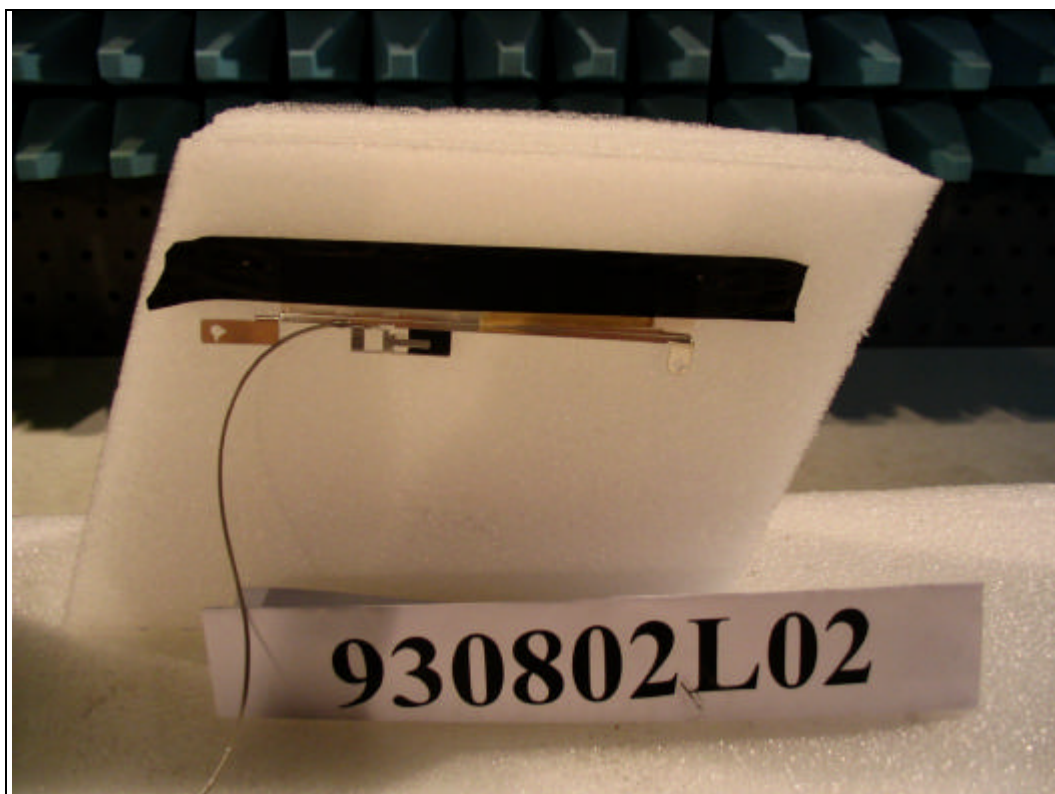



6 INFORMATION ON THE TESTING LABORATORIES

We, ADT Corp., were founded in 1988 to provide our best service in EMC, Radio, Telecom and Safety consultation. Our laboratories are accredited and approved by the following approval agencies according to ISO/IEC 17025, Guide 25 or EN 45001:

USA	FCC, NVLAP, UL
Germany	TUV Rheinland
Japan	VCCI
Norway	NEMKO
Canada	INDUSTRY CANADA , CSA
R.O.C.	CNLA, BSMI, DGT
Netherlands	Telefication
Singapore	PSB , GOST-ASIA(MOU)
Russia	CERTIS(MOU)

Copies of accreditation certificates of our laboratories obtained from approval agencies can be downloaded from our web site:

www.adt.com.tw/index.5/phtml. If you have any comments, please feel free to contact us at the following:

Linko EMC/RF Lab:

Tel: 886-2-26052180

Fax: 886-2-26052943

Hsin Chu EMC/RF Lab:

Tel: 886-3-5935343

Fax: 886-3-5935342

Hwa Ya EMC/RF/Safety/Telecom Lab:

Tel: 886-3-3183232

Fax: 886-3-3185050

Linko RF Lab.

Tel: 886-3-3270910

Fax: 886-3-3270892

Email: service@mail.adt.com.tw

Web Site: www.adt.com.tw

The address and road map of all our labs can be found in our web site also.

Report Format Version 1.2