



FCC TEST REPORT

REPORT NO.: RF930821L03
MODEL NO.: 3CRXJK10075
RECEIVED: Jul. 22, 2004
TESTED: Jul. 22 ~ Aug. 28, 2004

APPLICANT: Gemtek Technology Co., Ltd.

ADDRESS: No.1, Jen Ai Road, Hsinchu Industrial Park,
Hukou Hsinchu, Taiwan, R.O.C. 303

ISSUED BY: Advance Data Technology Corporation

LAB LOCATION: No. 19, Hwa Ya 2nd Rd., Kueishan, Taoyuan,
Taiwan, R.O.C.

This test report consists of 86 pages in total. It may be duplicated completely for legal use with the approval of the applicant. It should not be reproduced except in full, without the written approval of our laboratory. The client should not use it to claim product endorsement by CNLA, A2LA or any government agencies. The test results in the report only apply to the tested sample.



0528
ILAC MRA



No. 2177-01



Table of Contents

1	CERTIFICATION	4
2	SUMMARY OF TEST RESULTS	5
2.1	GENERAL DESCRIPTION OF EUT	6
3	GENERAL INFORMATION	7
3.1	GENERAL DESCRIPTION OF EUT	7
3.2	DESCRIPTION OF TEST MODES	8
3.3	GENERAL DESCRIPTION OF APPLIED STANDARDS	8
3.4	DESCRIPTION OF SUPPORT UNITS	9
3.5	CONFIGURATION OF SYSTEM UNDER TEST	10
4	TEST TYPES AND RESULTS	11
4.1	CONDUCTED EMISSION MEASUREMENT	11
4.1.1	LIMITS OF CONDUCTED EMISSION MEASUREMENT	11
4.1.2	TEST INSTRUMENTS	11
4.1.3	TEST PROCEDURES	12
4.1.4	DEVIATION FROM TEST STANDARD	12
4.1.5	TEST SETUP	13
4.1.6	EUT OPERATING CONDITIONS	14
4.1.7	TEST RESULTS	15
4.2	RADIATED EMISSION MEASUREMENT	21
4.2.1	LIMITS OF RADIATED EMISSION MEASUREMENT	21
4.2.2	TEST INSTRUMENTS	22
4.2.3	TEST PROCEDURES	23
4.2.4	DEVIATION FROM TEST STANDARD	23
4.2.5	TEST SETUP	24
4.2.6	EUT OPERATING CONDITIONS	24
4.2.7	TEST RESULTS	25
4.3	6dB BANDWIDTH MEASUREMENT	41
4.3.1	LIMITS OF 6DB BANDWIDTH MEASUREMENT	41
4.3.2	TEST INSTRUMENTS	41
4.3.3	TEST PROCEDURE	42
4.3.4	DEVIATION FROM TEST STANDARD	42
4.3.5	TEST SETUP	42
4.3.6	EUT OPERATING CONDITIONS	42
4.3.7	TEST RESULTS	43
4.4	MAXIMUM PEAK OUTPUT POWER	53
4.4.1	LIMITS OF MAXIMUM PEAK OUTPUT POWER MEASUREMENT	53
4.4.2	TEST INSTRUMENTS	53
4.4.3	TEST PROCEDURES	54
4.4.4	DEVIATION FROM TEST STANDARD	54



4.4.5	TEST SETUP.....	54
4.4.6	EUT OPERATING CONDITIONS	54
4.4.7	TEST RESULTS	55
4.5	POWER SPECTRAL DENSITY MEASUREMENT.....	56
4.5.1	LIMITS OF POWER SPECTRAL DENSITY MEASUREMENT	56
4.5.2	TEST INSTRUMENTS.....	56
4.5.3	TEST PROCEDURE.....	57
4.5.4	DEVIATION FROM TEST STANDARD	57
4.5.5	TEST SETUP.....	57
4.5.6	EUT OPERATING CONDITIONS	57
4.5.7	TEST RESULTS	58
4.6	BAND EDGES MEASUREMENT	68
4.6.1	LIMITS OF BAND EDGES MEASUREMENT.....	68
4.6.2	TEST INSTRUMENTS.....	68
4.6.3	TEST PROCEDURE.....	68
4.6.4	DEVIATION FROM TEST STANDARD	68
4.6.5	EUT OPERATING CONDITION	68
4.6.6	TEST RESULTS	69
4.7	ANTENNA REQUIREMENT	83
4.7.1	STANDARD APPLICABLE	83
4.7.2	ANTENNA CONNECTED CONSTRUCTION.....	83
5	PHOTOGRAPHS OF THE TEST CONFIGURATION.....	84
6	INFORMATION ON THE TESTING LABORATORIES	86



1 CERTIFICATION

PRODUCT : 3Com OfficeConnect Wireless 108Mbps 11g
XJACK PC Card

MODEL NO. : 3CRXJK10075

BRAND NAME : 3COM

APPLICANT : Gemtek Technology Co., Ltd.

TESTED : Jul. 22 ~ Aug. 28, 2004

TEST ITEM : Engineering Sample

STANDARDS : FCC Part 15, Subpart C (Section 15.247),
ANSI C63.4-2001

The above equipment has been tested by **Advance Data Technology Corporation**, and found compliance with the requirement of the above standards. The test record, data evaluation & Equipment Under Test (EUT) configurations represented herein are true and accurate accounts of the measurements of the sample's EMC characteristics under the conditions specified in this report.

PREPARED BY : Wendy Liao , **DATE:** Aug. 30, 2004
(Wendy Liao)

TECHNICAL
ACCEPTANCE : Gary Chang , **DATE:** Aug. 30, 2004
Responsible for RF (Gary Chang)

APPROVED BY : Cody Chang , **DATE:** Aug. 30, 2004
(Cody Chang, Deputy
Manager)



2 SUMMARY OF TEST RESULTS

The EUT has been tested according to the following specifications:

APPLIED STANDARD: FCC Part 15, Subpart C			
Standard Section	Test Type and Limit	Result	REMARK
15.207	AC Power Conducted Emission	PASS	Meet the requirement of limit. Minimum passing margin is -18.04dB at 0.220MHz
15.247(a)(2)	Spectrum Bandwidth of a Direct Sequence Spread Spectrum System Limit: min. 500kHz	PASS	Meet the requirement of limit.
15.247(b)	Maximum Peak Output Power Limit: max. 30dBm	PASS	Meet the requirement of limit.
15.247(c)	Transmitter Radiated Emissions Limit: Table 15.209	PASS	Meet the requirement of limit. Minimum passing margin is -1.13dB at 2360.00MHz
15.247(d)	Power Spectral Density Limit: max. 8dBm	PASS	Meet the requirement of limit.
15.247(c)	Band Edge Measurement Limit: 20 dB less than the peak value of fundamental frequency	PASS	Meet the requirement of limit.



2.1 GENERAL DESCRIPTION OF EUT

Where relevant, the following measurement uncertainty levels have been estimated for tests performed on the EUT as specified in CISPR 16-4:

Measurement	Frequency	Uncertainty
Conducted emissions	9k~30MHz	2.44 dB
Radiated emissions	30MHz ~ 200MHz	3.73 dB
	200MHz ~1000MHz	3.74 dB
	1GHz ~ 18GHz	2.20 dB
	18GHz ~ 40GHz	1.88 dB



3 GENERAL INFORMATION

3.1 GENERAL DESCRIPTION OF EUT

PRODUCT	3Com OfficeConnect Wireless 108Mbps 11g XJACK PC Card
MODEL NO.	3CRXJK10075
POWER SUPPLY	3.3Vdc from host equipment
MODULATION TYPE	BPSK, QPSK, CCK, 16QAM, 64QAM
RADIO TECHNOLOGY	DSSS, OFDM
TRANSFER RATE	802.11b: 11/5.5/2/1Mbps 802.11g: 54/48/36/24/18/12/9/6Mbps *(Turbo mode : up to108Mbps)
FREQUENCY RANGE	2412MHz ~ 2462MHz for normal mode 2437MHz for turbo mode
NUMBER OF CHANNEL	11
OUTPUT POWER	17.50dBm
ANTENNA TYPE	monopole antenna with 1.5dBi gain
DATA CABLE	NA
I/O PORTS	NA
ASSOCIATED DEVICES	NA

NOTE:

1. The EUT operates in the 2.4GHz frequency spectrum with throughput of up to 54Mbps.
2. The EUT complies with IEEE 802.11g standards and backwards compatible with IEEE 802.11b products.
3. The above EUT information was declared by manufacturer and for more detailed features description, please refer to the manufacturer's specifications or User's Manual.



3.2 DESCRIPTION OF TEST MODES

Eleven channels are provided to this EUT.

Channel	Frequency	Channel	Frequency
1	2412 MHz	7	2442 MHz
2	2417 MHz	8	2447 MHz
3	2422 MHz	9	2452 MHz
4	2427 MHz	10	2457 MHz
5	2432 MHz	11	2462 MHz
6	2437 MHz		

NOTE:

1. Below 1GHz, the channel 1, 6, and 11 were pre-tested in chamber. The channel 11, the worst case, was chosen for final test.
2. Above 1GHz, the channel 1, 6, and 11 were tested individually.
3. From our experience and technical viewpoint, we have chosen data rates 11Mbps for CCK technique and 6Mbps for OFDM technique, as the worst cases for the test among other data rates.
4. One turbo mode at frequency 2437MHz.
5. Test result A is for CCK technique, test result B is for OFDM technique and test result C is for OFDM technique in Turbo mode.

3.3 GENERAL DESCRIPTION OF APPLIED STANDARDS

The EUT is a 3Com OfficeConnect Wireless 108Mbps 11g XJACK PC Card. According to the specifications of the manufacturer, it must comply with the requirements of the following standards:

FCC Part 15, Subpart C. (15.247)

ANSI C63.4: 2001

All test items have been performed and recorded as per the above standards.

NOTE: The EUT is also considered as a kind of computer peripheral, because the connection to computer is necessary for typical use. It has been verified to comply with the requirements of FCC Part 15, Subpart B, Class B (DoC). The test report has been issued separately.



3.4 DESCRIPTION OF SUPPORT UNITS

The EUT has been tested as an independent unit together with other necessary accessories or support units. The following support units or accessories were used to form a representative test configuration during the tests.

NO.	PRODUCT	BRAND	MODEL NO.	SERIAL NO.	FCC ID
1	NOTEBOOK COMPUTER	DELL	PP05L	16484462992	E2K24CLNS
2	PRINTER	EPSON	LQ-300+	DCGY054147	FCC DoC Approved
3	MODEM	ACEEX	1414V/3	0401008269	IFAXDM1414

NO.	SIGNAL CABLE DESCRIPTION OF THE ABOVE SUPPORT UNITS
1	NA
2	1.2m shielded cable without core
3	1.2m shielded cable without core

NOTE: All power cords of the above support units are non shielded (1.8m).

3.5 CONFIGURATION OF SYSTEM UNDER TEST

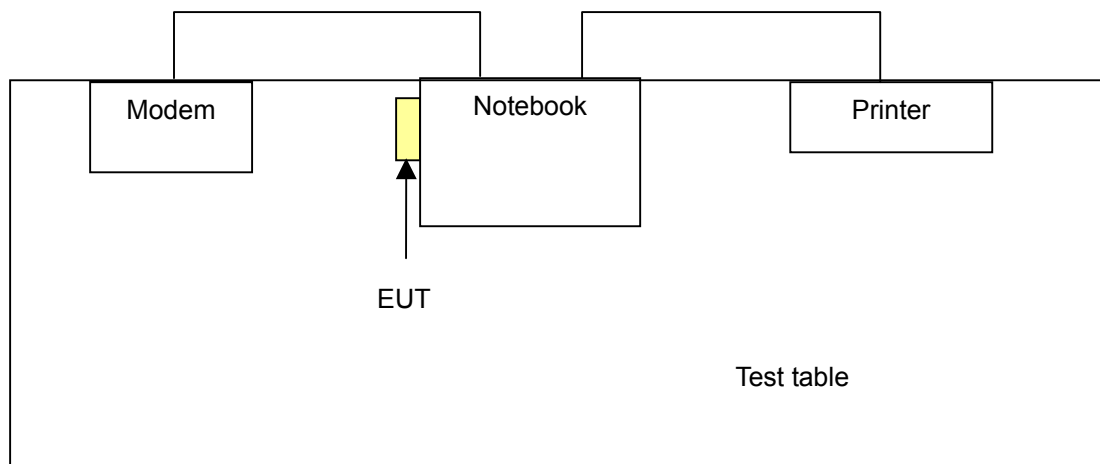



4 TEST TYPES AND RESULTS

4.1 CONDUCTED EMISSION MEASUREMENT

4.1.1 LIMITS OF CONDUCTED EMISSION MEASUREMENT

FREQUENCY OF EMISSION (MHz)	CONDUCTED LIMIT (dB μ V)	
	Quasi-peak	Average
0.15-0.5	66 to 56	56 to 46
0.5-5	56	46
5-30	60	50

- NOTE:**
1. The lower limit shall apply at the transition frequencies.
 2. The limit decreases in line with the logarithm of the frequency in the range of 0.15 to 0.50 MHz.
 3. All emanations from a class A/B digital device or system, including any network of conductors and apparatus connected thereto, shall not exceed the level of field strengths specified above.

4.1.2 TEST INSTRUMENTS

DESCRIPTION & MANUFACTURER	MODEL NO.	SERIAL NO.	CALIBRATED UNTIL
Test Receiver ROHDE & SCHWARZ	ESCS30	100288	Dec. 11, 2004
RF signal cable Woken	5D-FB	Cable-HyC02-01	Mar. 07, 2005
LISN ROHDE & SCHWARZ	ESH2-Z5	100100	Mar. 10, 2005
LISN ROHDE & SCHWARZ	ESH3-Z5	100311	Mar. 04, 2005
Software ADT	ADT_Cond_V3	NA	NA

- NOTE:**
1. The calibration interval of the above test instruments is 12 months and the calibrations are traceable to NML/ROC and NIST/USA.
 2. The test was performed in HwaYa Shielded Room 2.
 3. The VCCI Site Registration No. is C-2047.



4.1.3 TEST PROCEDURES

- a. The EUT was placed 0.4 meters from the conducting wall of the shielded room with EUT being connected to the power mains through a line impedance stabilization network (LISN). Other support units were connected to the power mains through another LISN. The two LISNs provide 50 ohm/ 50uH of coupling impedance for the measuring instrument.
- b. Both lines of the power mains connected to the EUT were checked for maximum conducted interference.
- c. The frequency range from 150 kHz to 30 MHz was searched. Emission levels (Limit -20dB) was not recorded.

4.1.4 DEVIATION FROM TEST STANDARD

No deviation

4.1.5 TEST SETUP

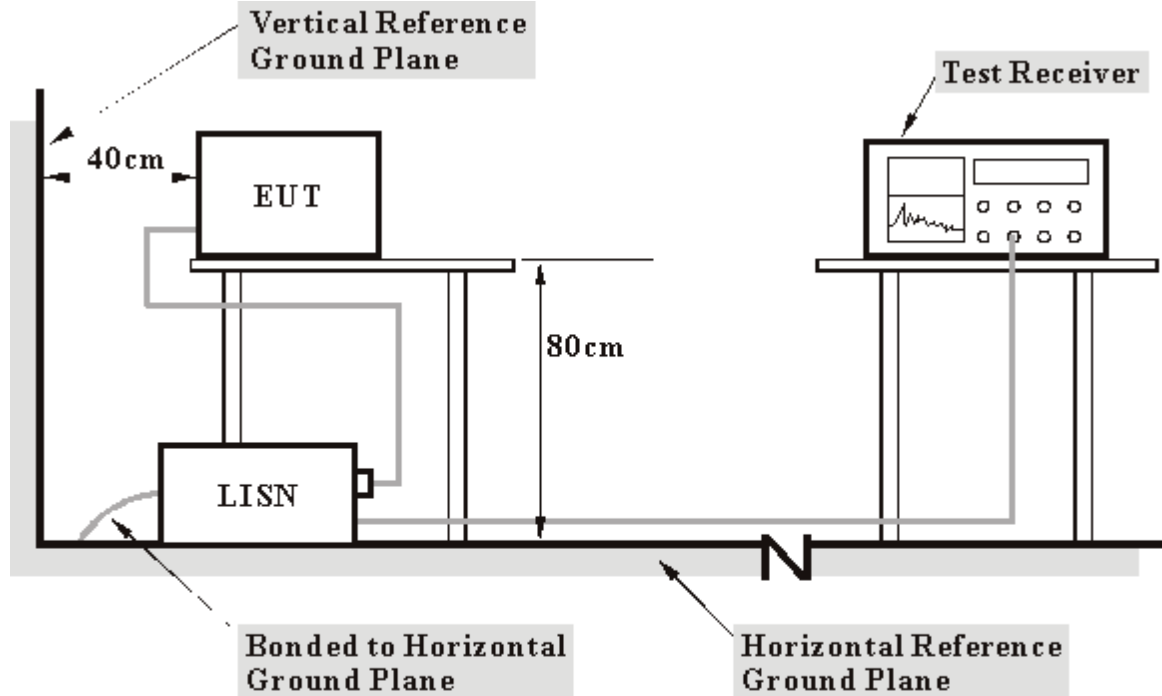

- Note:**
1. Support units were connected to second LISN.
 2. Both of LISNs (AMN) 80 cm from EUT and at the least 80 cm from other units and other metal planes support units.

For the actual test configuration, please refer to the related item – Photographs of the Test Configuration.



4.1.6 EUT OPERATING CONDITIONS

- a. Plug the EUT to a notebook system placed on a testing table.
- b. The notebook system ran a test program (provided by manufacturer) to enable EUT under transmission/receiving condition continuously at specific channel frequency.
- c. The notebook system sent "H" messages to its screen.
- d. The notebook system sent "H" messages to modem.
- e. The notebook system sent "H" messages to printer, and the printer printed them on paper.
- f. Steps c ~ e were repeated.



4.1.7 TEST RESULTS

EUT	3Com OfficeConnect Wireless 108Mbps 11g XJACK PC Card	MODEL	3CRXJK10075
CHANNEL	1	6dB BANDWIDTH	9 kHz
INPUT POWER (SYSTEM)	120 Vac, 60 Hz	PHASE	Line (L)
ENVIRONMENTAL CONDITIONS	25 deg. C, 65% RH, 991 hPa	TESTED BY: Rush Kao	

No	Freq. [MHz]	Corr. Factor (dB)	Reading Value [dB (uV)]		Emission Level [dB (uV)]		Limit [dB (uV)]		Margin (dB)	
			Q.P.	AV.	Q.P.	AV.	Q.P.	AV.	Q.P.	AV.
			1	0.220	0.10	43.72	-	43.82	-	62.80
2	0.341	0.11	28.46	-	28.57	-	59.17	49.17	-30.60	-
3	0.654	0.17	18.95	-	19.12	-	56.00	46.00	-36.88	-
4	1.238	0.25	19.74	-	19.99	-	56.00	46.00	-36.01	-
5	15.355	0.72	20.95	-	21.67	-	60.00	50.00	-38.33	-
6	21.664	1.00	23.06	-	24.06	-	60.00	50.00	-35.94	-

- REMARKS:**
1. Q.P. and AV. are abbreviations of quasi-peak and average individually.
 2. "-": The Quasi-peak reading value also meets average limit and measurement with the average detector is unnecessary.
 3. The emission levels of other frequencies were very low against the limit.
 4. Margin value = Emission level - Limit value
 5. Correction factor = Insertion loss + Cable loss
 6. Emission Level = Correction Factor + Reading Value.

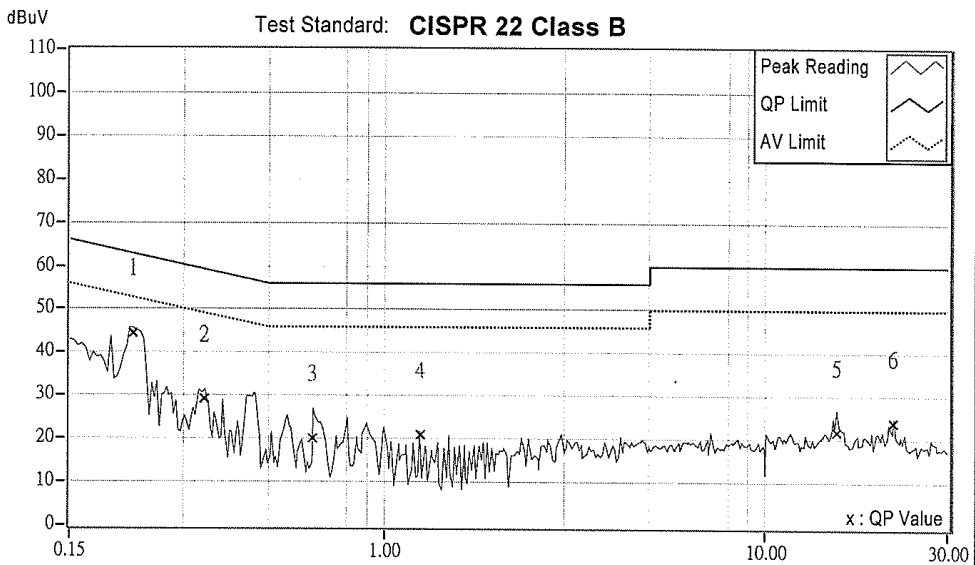



EUT	3Com OfficeConnect Wireless 108Mbps 11g XJACK PC Card	MODEL	3CRXJK10075
CHANNEL	1	6dB BANDWIDTH	9 kHz
INPUT POWER (SYSTEM)	120 Vac, 60 Hz	PHASE	Neutral (N)
ENVIRONMENTAL CONDITIONS	25 deg. C, 65% RH, 991 hPa	TESTED BY: Rush Kao	

No	Freq. [MHz]	Corr. Factor (dB)	Reading Value		Emission Level		Limit		Margin	
			[dB (uV)]		[dB (uV)]		[dB (uV)]		(dB)	
			Q.P.	AV.	Q.P.	AV.	Q.P.	AV.	Q.P.	AV.
1	0.170	0.10	33.91	-	34.01	-	64.98	54.98	-30.98	-
2	0.220	0.10	44.29	-	44.39	-	62.81	52.81	-18.42	-
3	0.798	0.19	19.89	-	20.08	-	56.00	46.00	-35.92	-
4	3.863	0.30	17.48	-	17.78	-	56.00	46.00	-38.22	-
5	12.695	0.53	16.92	-	17.45	-	60.00	50.00	-42.55	-
6	15.152	0.56	20.65	-	21.21	-	60.00	50.00	-38.79	-

- REMARKS:**
1. Q.P. and AV. are abbreviations of quasi-peak and average individually.
 2. "-": The Quasi-peak reading value also meets average limit and measurement with the average detector is unnecessary.
 3. The emission levels of other frequencies were very low against the limit.
 4. Margin value = Emission level - Limit value
 5. Correction factor = Insertion loss + Cable loss
 6. Emission Level = Correction Factor + Reading Value.

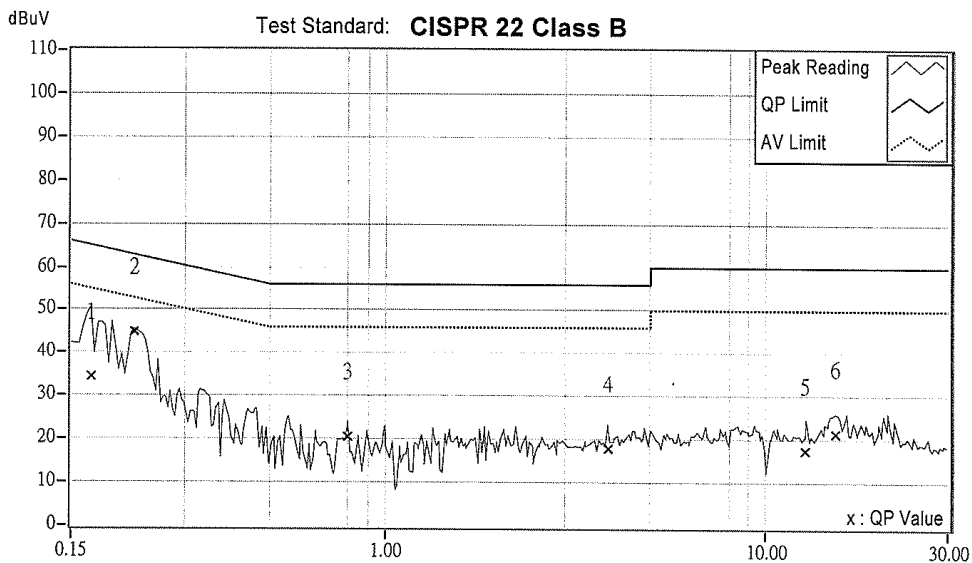



EUT	3Com OfficeConnect Wireless 108Mbps 11g XJACK PC Card	MODEL	3CRXJK10075
CHANNEL	6	6dB BANDWIDTH	9 kHz
INPUT POWER (SYSTEM)	120 Vac, 60 Hz	PHASE	Line (L)
ENVIRONMENTAL CONDITIONS	25 deg. C, 65% RH, 991 hPa	TESTED BY: Rush Kao	

No	Freq. [MHz]	Corr. Factor (dB)	Reading Value [dB (uV)]		Emission Level [dB (uV)]		Limit [dB (uV)]		Margin (dB)	
			Q.P.	AV.	Q.P.	AV.	Q.P.	AV.	Q.P.	AV.
			1	0.193	0.10	38.13	-	38.23	-	63.91
2	0.341	0.11	27.64	-	27.75	-	59.17	49.17	-31.42	-
3	0.658	0.17	22.26	-	22.43	-	56.00	46.00	-33.57	-
4	0.896	0.23	21.06	-	21.29	-	56.00	46.00	-34.71	-
5	15.008	0.70	22.25	-	22.95	-	60.00	50.00	-37.05	-
6	20.810	0.96	22.87	-	23.83	-	60.00	50.00	-36.17	-

- REMARKS:**
1. Q.P. and AV. are abbreviations of quasi-peak and average individually.
 2. "-": The Quasi-peak reading value also meets average limit and measurement with the average detector is unnecessary.
 3. The emission levels of other frequencies were very low against the limit.
 4. Margin value = Emission level - Limit value
 5. Correction factor = Insertion loss + Cable loss
 6. Emission Level = Correction Factor + Reading Value.

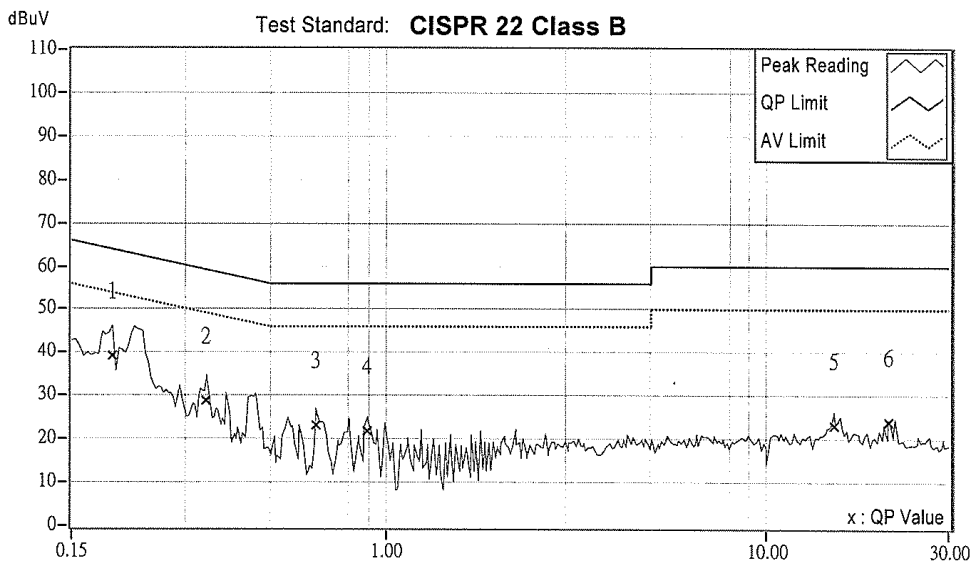



EUT	3Com OfficeConnect Wireless 108Mbps 11g XJACK PC Card	MODEL	3CRXJK10075
CHANNEL	6	6dB BANDWIDTH	9 kHz
INPUT POWER (SYSTEM)	120 Vac, 60 Hz	PHASE	Neutral (N)
ENVIRONMENTAL CONDITIONS	25 deg. C, 65% RH, 991 hPa	TESTED BY: Rush Kao	

No	Freq. [MHz]	Corr. Factor (dB)	Reading Value [dB (uV)]		Emission Level [dB (uV)]		Limit [dB (uV)]		Margin (dB)	
			Q.P.	AV.	Q.P.	AV.	Q.P.	AV.	Q.P.	AV.
			1	0.170	0.10	35.68	-	35.78	-	64.98
2	0.220	0.10	44.67	-	44.77	-	62.81	52.81	-18.04	-
3	0.802	0.19	20.52	-	20.71	-	56.00	46.00	-35.29	-
4	1.871	0.25	20.50	-	20.75	-	56.00	46.00	-35.25	-
5	15.246	0.56	20.92	-	21.48	-	60.00	50.00	-38.52	-
6	20.258	0.65	24.41	-	25.06	-	60.00	50.00	-34.94	-

- REMARKS:**
1. Q.P. and AV. are abbreviations of quasi-peak and average individually.
 2. "-": The Quasi-peak reading value also meets average limit and measurement with the average detector is unnecessary.
 3. The emission levels of other frequencies were very low against the limit.
 4. Margin value = Emission level - Limit value
 5. Correction factor = Insertion loss + Cable loss
 6. Emission Level = Correction Factor + Reading Value.

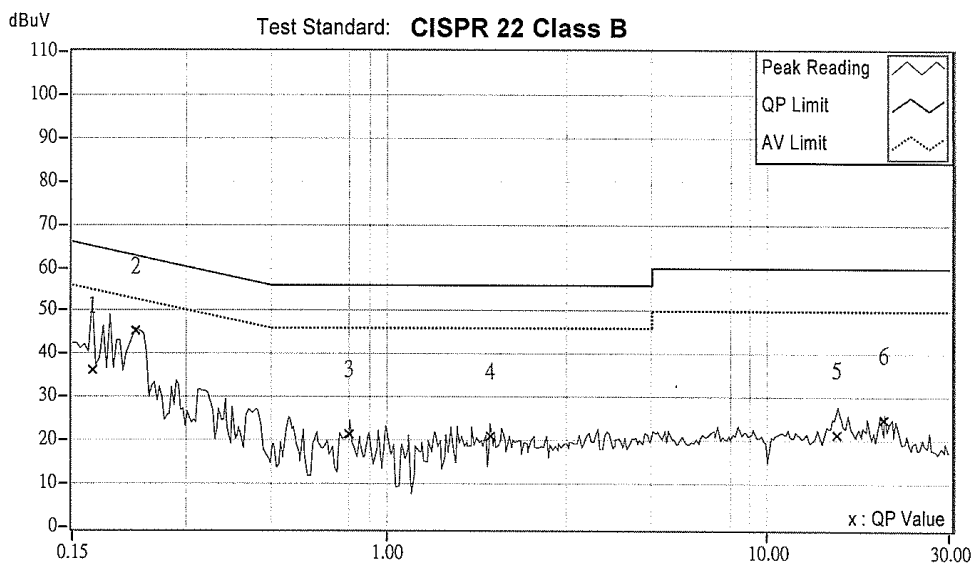



EUT	3Com OfficeConnect Wireless 108Mbps 11g XJACK PC Card	MODEL	3CRXJK10075
CHANNEL	11	6dB BANDWIDTH	9 kHz
INPUT POWER (SYSTEM)	120 Vac, 60 Hz	PHASE	Line (L)
ENVIRONMENTAL CONDITIONS	25 deg. C, 65% RH, 991 hPa	TESTED BY: Rush Kao	

No	Freq. [MHz]	Corr. Factor (dB)	Reading Value [dB (uV)]		Emission Level [dB (uV)]		Limit [dB (uV)]		Margin (dB)	
			Q.P.	AV.	Q.P.	AV.	Q.P.	AV.	Q.P.	AV.
			1	0.177	0.10	35.53	-	35.63	-	64.61
2	0.459	0.13	25.94	-	26.07	-	56.72	46.72	-30.65	-
3	0.658	0.17	22.16	-	22.33	-	56.00	46.00	-33.67	-
4	2.840	0.28	18.96	-	19.24	-	56.00	46.00	-36.76	-
5	15.367	0.72	20.73	-	21.45	-	60.00	50.00	-38.55	-
6	20.809	0.96	22.90	-	23.86	-	60.00	50.00	-36.14	-

- REMARKS:**
1. Q.P. and AV. are abbreviations of quasi-peak and average individually.
 2. "-": The Quasi-peak reading value also meets average limit and measurement with the average detector is unnecessary.
 3. The emission levels of other frequencies were very low against the limit.
 4. Margin value = Emission level - Limit value
 5. Correction factor = Insertion loss + Cable loss
 6. Emission Level = Correction Factor + Reading Value.

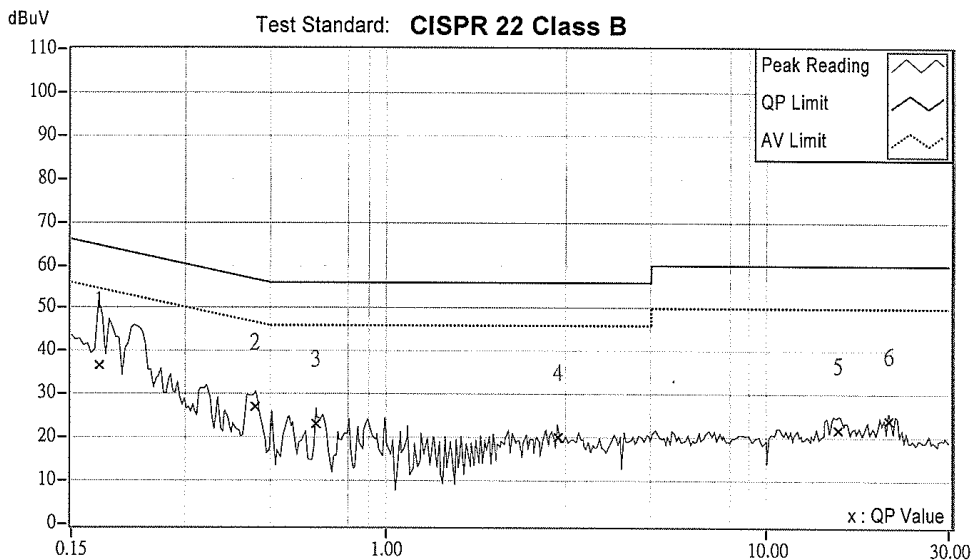



EUT	3Com OfficeConnect Wireless 108Mbps 11g XJACK PC Card	MODEL	3CRXJK10075
CHANNEL	11	6dB BANDWIDTH	9 kHz
INPUT POWER (SYSTEM)	120 Vac, 60 Hz	PHASE	Netural (N)
ENVIRONMENTAL CONDITIONS	25 deg. C, 65% RH, 991 hPa	TESTED BY: Rush Kao	

No	Freq. [MHz]	Corr. Factor (dB)	Reading Value [dB (uV)]		Emission Level [dB (uV)]		Limit [dB (uV)]		Margin (dB)	
			Q.P.	AV.	Q.P.	AV.	Q.P.	AV.	Q.P.	AV.
			1	0.168	0.10	40.74	-	40.84	-	65.05
2	0.220	0.10	44.65	-	44.75	-	62.81	52.81	-18.06	-
3	0.560	0.15	20.48	-	20.63	-	56.00	46.00	-35.37	-
4	1.918	0.25	20.88	-	21.13	-	56.00	46.00	-34.87	-
5	15.020	0.56	20.67	-	21.23	-	60.00	50.00	-38.77	-
6	20.258	0.65	24.35	-	25.00	-	60.00	50.00	-35.00	-

- REMARKS:**
1. Q.P. and AV. are abbreviations of quasi-peak and average individually.
 2. "-": The Quasi-peak reading value also meets average limit and measurement with the average detector is unnecessary.
 3. The emission levels of other frequencies were very low against the limit.
 4. Margin value = Emission level - Limit value
 5. Correction factor = Insertion loss + Cable loss
 6. Emission Level = Correction Factor + Reading Value.

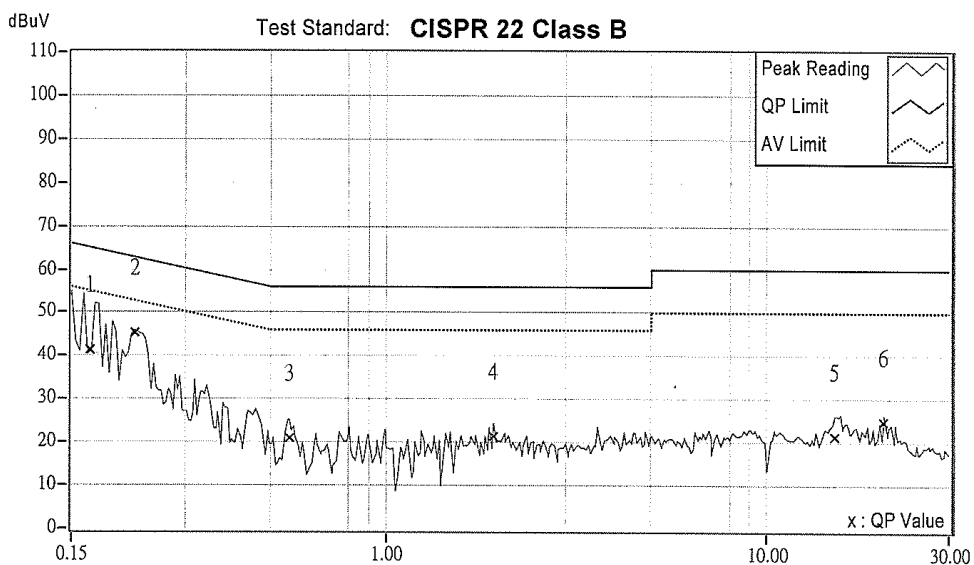



4.2 RADIATED EMISSION MEASUREMENT

4.2.1 LIMITS OF RADIATED EMISSION MEASUREMENT

Emissions radiated outside of the specified bands, shall be according to the general radiated limits in 15.209 as following:

Frequencies (MHz)	Field strength (microvolts/meter)	Measurement distance (meters)
0.009-0.490	2400/F(kHz)	300
0.490-1.705	24000/F(kHz)	30
1.705-30.0	30	30
30-88	100	3
88-216	150	3
216-960	200	3
Above 960	500	3

NOTE:

1. The lower limit shall apply at the transition frequencies.
2. Emission level (dBuV/m) = 20 log Emission level (uV/m).
3. As shown in 15.35(b), for frequencies above 1000MHz, the field strength limits are based on average detector, however, the peak field strength of any emission shall not exceed the maximum permitted average limits, specified above by more than 20dB under any condition of modulation.



4.2.2 TEST INSTRUMENTS

DESCRIPTION & MANUFACTURER	MODEL NO.	SERIAL NO.	CALIBRATED UNTIL
Test Receiver ROHDE & SCHWARZ	ESIB7	100188	Jan. 13, 2005
Spectrum Analyzer ROHDE & SCHWARZ	FSP40	100039	Dec. 15, 2004
BILOG Antenna SCHWARZBECK	VULB9168	9168-157	Feb. 03, 2005
HORN Antenna SCHWARZBECK	BBHA 9120 D	9120D-407	Feb. 03, 2005
HORN Antenna SCHWARZBECK	BBHA 9170	BBHA 9170241	Feb. 23, 2005
Preamplifier Agilent	8449B	3008A01961	Jan. 22, 2005
Preamplifier Agilent	8447D	2944A10629	Jan. 14, 2005
RF signal cable HUBER+SUHNER	SUCOFLEX 104	218182/4	Mar. 04, 2005
RF signal cable HUBER+SUHNER	SUCOFLEX 104	218194/4	Mar. 04, 2005
Software ADT.	ADT_Radiated_V5.1 4	NA	NA
Antenna Tower ADT.	AT100	AT93021702	NA
Turn Table ADT.	TT100.	TT93021702	NA
Controller ADT.	SC100.	SC93021702	NA

- NOTE:**
1. The calibration interval of the above test instruments is 12 months and the calibrations are traceable to NML/ROC and NIST/USA.
 2. The test was performed in HwaYa Chamber 1.
 3. The horn antenna and HP preamplifier (model: 8449B) are used only for the measurement of emission frequency above 1GHz if tested.
 4. The IC Site Registration No. is IC4924-2.



4.2.3 TEST PROCEDURES

- a. The EUT was placed on the top of a rotating table 0.8 meters above the ground at a 3 meter semi-anechoic chamber. The table was rotated 360 degrees to determine the position of the highest radiation.
- b. The EUT was set 3 meters away from the interference-receiving antenna, which was mounted on the top of a variable-height antenna tower.
- c. The antenna is a broadband antenna, and its height is varied from one meter to four meters above the ground to determine the maximum value of the field strength. Both horizontal and vertical polarizations of the antenna are set to make the measurement.
- d. For each suspected emission, the EUT was arranged to its worst case and then the antenna was tuned to heights from 1 meter to 4 meters and the rotatable table was turned from 0 degrees to 360 degrees to find the maximum reading.
- e. The test-receiver system was set to Peak Detect Function and Specified Bandwidth with Maximum Hold Mode.
- f. If the emission level of the EUT in peak mode was 10 dB lower than the limit specified, then testing could be stopped and the peak values of the EUT would be reported. Otherwise the emissions that did not have 10 dB margin would be re-tested one by one using peak, quasi-peak or average method as specified and then reported in a data sheet.

NOTE:

1. The resolution bandwidth and video bandwidth of test receiver/spectrum analyzer is 120kHz for Peak detection (PK) and Quasi-peak detection (QP) at frequency below 1GHz.
2. The resolution bandwidth and video bandwidth of test receiver/spectrum analyzer is 1 MHz for Peak detection at frequency above 1GHz.
3. The resolution bandwidth of test receiver/spectrum analyzer is 1 MHz and the video bandwidth is 10 Hz for Average detection (AV) at frequency above 1GHz.

4.2.4 DEVIATION FROM TEST STANDARD

No deviation

4.2.5 TEST SETUP

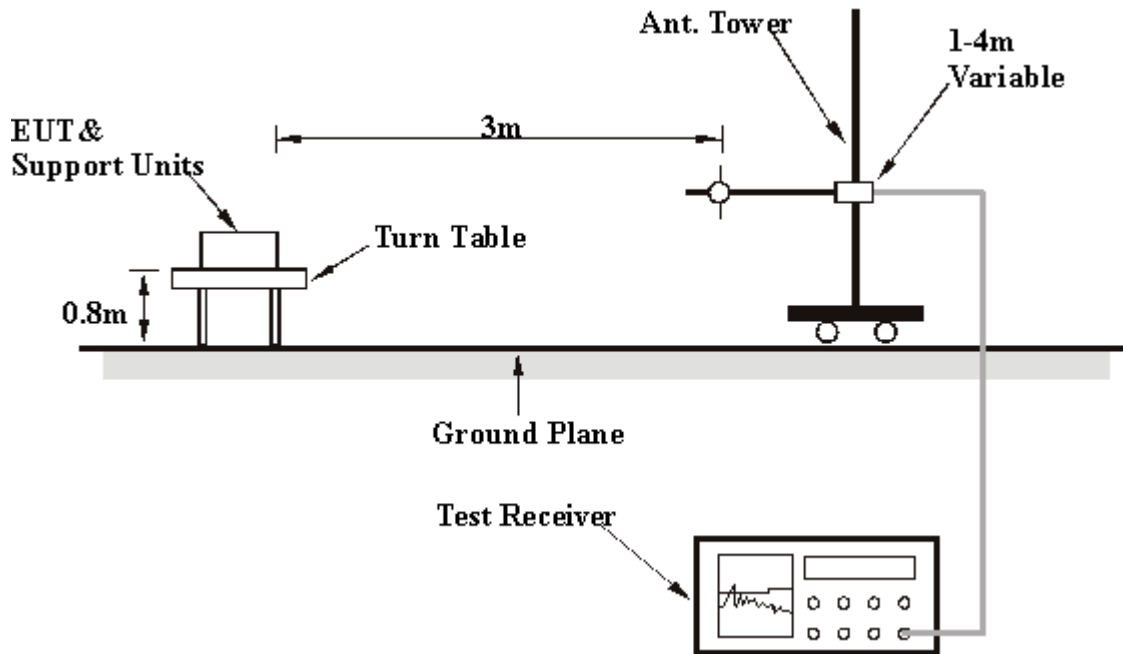

For the actual test configuration, please refer to the related item – Photographs of the Test Configuration.

4.2.6 EUT OPERATING CONDITIONS

Same as 4.1.6



4.2.7 TEST RESULTS

EUT	3Com OfficeConnect Wireless 108Mbps 11g XJACK PC Card	MODEL	3CRXJK10075
CHANNEL	11	FREQUENCY RANGE	Below 1000 MHz
INPUT POWER (SYSTEM)	120 Vac, 60Hz	DETECTOR FUNCTION	Quasi-Peak
ENVIRONMENTAL CONDITIONS	25 deg. C, 56% RH, 991 hPa	TESTED BY: Match Tsui	

ANTENNA POLARITY & TEST DISTANCE: HORIZONTAL AT 3 M

No.	Freq. (MHz)	Emission Level (dBuV/m)	Limit (dBuV/m)	Margin (dB)	Antenna Height (m)	Table Angle (Degree)	Raw Value (dBuV)	Correction Factor (dB/m)
1	111.64	35.62 QP	43.50	-7.88	1.50 H	214	23.44	12.17
2	166.07	38.01 QP	43.50	-5.49	1.50 H	139	23.71	14.30
3	232.16	38.58 QP	46.00	-7.42	1.50 H	232	25.99	12.59
4	298.26	41.24 QP	46.00	-4.76	1.50 H	307	26.77	14.47
5	366.29	36.41 QP	46.00	-9.59	1.00 H	319	20.40	16.01
6	432.38	33.49 QP	46.00	-12.51	1.75 H	253	15.89	17.60
7	465.43	37.22 QP	46.00	-8.78	1.75 H	190	18.94	18.27
8	500.42	34.89 QP	46.00	-11.11	1.75 H	184	16.15	18.74
9	599.56	34.88 QP	46.00	-11.12	1.25 H	184	13.88	21.00
10	700.64	35.57 QP	46.00	-10.43	1.00 H	217	13.25	22.32
11	720.08	39.34 QP	46.00	-6.66	1.00 H	208	16.54	22.79
12	731.74	34.91 QP	46.00	-11.09	1.00 H	220	11.82	23.08
13	760.90	36.57 QP	46.00	-9.43	1.00 H	181	12.98	23.59
14	799.78	41.97 QP	46.00	-4.03	1.00 H	121	18.15	23.82
15	832.83	37.16 QP	46.00	-8.84	1.00 H	82	13.10	24.06
16	887.25	33.75 QP	46.00	-12.25	1.75 H	142	8.87	24.88

- REMARKS:**
1. Emission level(dBuV/m)=Raw Value(dBuV) + Correction Factor(dB)
 2. Correction Factor(dB/m) = Antenna Factor (dB/m) + Cable Factor (dB)
 3. The other emission levels were very low against the limit.
 4. Margin value = Emission level – Limit value.



EUT	3Com OfficeConnect Wireless 108Mbps 11g XJACK PC Card	MODEL	3CRXJK10075
CHANNEL	11	FREQUENCY RANGE	Below 1000 MHz
INPUT POWER (SYSTEM)	120 Vac, 60Hz	DETECTOR FUNCTION	Quasi-Peak
ENVIRONMENTAL CONDITIONS	25 deg. C, 56% RH, 991 hPa	TESTED BY: Match Tsui	

ANTENNA POLARITY & TEST DISTANCE: VERTICAL AT 3 M

No.	Freq. (MHz)	Emission Level (dBuV/m)	Limit (dBuV/m)	Margin (dB)	Antenna Height (m)	Table Angle (Degree)	Raw Value (dBuV)	Correction Factor (dB/m)
1	35.83	26.65 QP	40.00	-13.35	1.50 V	67	12.08	14.57
2	66.93	29.18 QP	40.00	-10.82	1.00 V	208	16.25	12.93
3	109.70	32.95 QP	43.50	-10.55	1.00 V	229	20.98	11.97
4	127.19	32.83 QP	43.50	-10.67	1.00 V	184	19.30	13.53
5	164.13	28.12 QP	43.50	-15.38	2.00 V	58	13.62	14.49
6	232.16	31.90 QP	46.00	-14.10	2.00 V	52	19.31	12.59
7	298.26	35.38 QP	46.00	-10.62	1.50 V	358	20.90	14.47
8	432.38	29.70 QP	46.00	-16.30	1.00 V	304	12.09	17.60
9	465.43	34.03 QP	46.00	-11.97	1.00 V	298	15.75	18.27
10	498.48	31.53 QP	46.00	-14.47	1.50 V	313	12.82	18.71
11	599.56	29.22 QP	46.00	-16.78	1.00 V	16	8.22	21.00
12	700.64	31.44 QP	46.00	-14.56	2.00 V	238	9.13	22.32
13	720.08	32.57 QP	46.00	-13.43	2.00 V	154	9.78	22.79
14	733.69	34.29 QP	46.00	-11.71	2.00 V	244	11.17	23.13
15	799.78	36.95 QP	46.00	-9.05	2.00 V	235	13.13	23.82
16	832.83	32.61 QP	46.00	-13.39	1.50 V	271	8.55	24.06

- REMARKS:**
1. Emission level(dBuV/m)=Raw Value(dBuV) + Correction Factor(dB)
 2. Correction Factor(dB/m) = Antenna Factor (dB/m) + Cable Factor (dB)
 3. The other emission levels were very low against the limit.
 4. Margin value = Emission level – Limit value.



EUT	3Com OfficeConnect Wireless 108Mbps 11g XJACK PC Card	MODEL	3CRXJK10075
CHANNEL	1	FREQUENCY RANGE	1~25 GHz
INPUT POWER (SYSTEM)	120 Vac, 60 Hz	DETECTOR FUNCTION	Peak (PK) Average (AV)
ENVIRONMENTAL CONDITIONS	25 deg. C, 65% RH, 991 hPa	TEST MODE	A
TESTED BY	Match Tsui		

ANTENNA POLARITY & TEST DISTANCE: HORIZONTAL AT 3 M								
No.	Freq. (MHz)	Emission Level (dBuV/m)	Limit (dBuV/m)	Margin (dB)	Antenna Height (m)	Table Angle (Degree)	Raw Value (dBuV)	Correction Factor (dB/m)
1	1608.00	48.54 PK	74.00	-25.46	1.00 H	160	19.04	29.50
1	1608.00	43.06 AV	54.00	-10.94	1.00 H	160	13.56	29.50
2	2360.00	54.93 PK	74.00	-19.07	1.06 H	6	22.36	32.57
2	2360.00	45.43 AV	54.00	-8.57	1.06 H	6	12.86	32.57
3	2387.00	61.10 PK	74.00	-12.90	1.00 H	342	28.49	32.61
3	2387.00	52.83 AV	54.00	-1.17	1.00 H	342	20.22	32.61
4	*2412.00	112.59 PK			1.00 H	342	79.90	32.69
4	*2412.00	104.31 AV			1.00 H	342	71.63	32.69
5	2520.00	55.86 PK	74.00	-18.14	1.00 H	358	22.64	33.22
5	2520.00	45.18 AV	54.00	-8.82	1.00 H	358	11.96	33.22
6	4824.00	53.73 PK	74.00	-20.27	1.14 H	24	22.64	39.24
6	4824.00	40.23 AV	54.00	-13.77	1.14 H	24	11.96	39.24
7	9648.00	52.14 PK	74.00	-21.86	1.13 H	270	5.25	46.86
7	9648.00	40.84 AV	54.00	-13.16	1.13 H	270	-6.05	46.86

REMARKS:

1. Emission level(dBuV/m)=Raw Value(dBuV) + Correction Factor(dB)
2. Correction Factor(dB/m) = Antenna Factor (dB/m) + Cable Factor (dB)
3. The other emission levels were very low against the limit.
4. Margin value = Emission level – Limit value.
5. “ * ” : Fundamental frequency



EUT	3Com OfficeConnect Wireless 108Mbps 11g XJACK PC Card	MODEL	3CRXJK10075
CHANNEL	1	FREQUENCY RANGE	1~25 GHz
INPUT POWER (SYSTEM)	120 Vac, 60 Hz	DETECTOR FUNCTION	Peak (PK) Average (AV)
ENVIRONMENTAL CONDITIONS	25 deg. C, 65% RH, 991 hPa	TEST MODE	A
TESTED BY	Match Tsui		

ANTENNA POLARITY & TEST DISTANCE: VERTICAL AT 3 M								
No.	Freq. (MHz)	Emission Level (dBuV/m)	Limit (dBuV/m)	Margin (dB)	Antenna Height (m)	Table Angle (Degree)	Raw Value (dBuV)	Correction Factor (dB/m)
1	1608.00	44.70 PK	74.00	-29.30	1.03 V	177	15.20	29.50
1	1608.00	37.30 AV	54.00	-16.70	1.03 V	177	7.80	29.50
2	2360.00	50.04 PK	74.00	-23.96	1.02 V	239	17.47	32.57
2	2360.00	39.99 AV	54.00	-14.01	1.02 V	239	7.42	32.57
3	2387.00	54.99 PK	74.00	-19.01	1.03 V	177	22.38	32.61
3	2387.00	46.75 AV	54.00	-7.25	1.03 V	177	14.14	32.61
4	*2412.00	106.58 PK			1.00 V	245	73.89	32.69
4	*2412.00	98.34 AV			1.00 V	245	65.65	32.69
5	3216.00	49.60 PK	74.00	-24.40	1.06 V	50	13.71	35.89
5	3216.00	40.80 AV	54.00	-13.20	1.06 V	50	4.91	35.89
6	4824.00	55.87 PK	74.00	-18.13	1.00 V	162	16.63	39.24
6	4824.00	42.35 AV	54.00	-11.65	1.00 V	162	3.11	39.24
7	9648.00	54.06 PK	74.00	-19.94	1.00 V	1	7.17	46.89
7	9648.00	41.89 AV	54.00	-12.11	1.00 V	1	-5.00	46.89

REMARKS:

1. ssion level(dBuV/m)=Raw Value(dBuV) + Correction Factor(dB)
2. Correction Factor(dB/m) = Antenna Factor (dB/m) + Cable Factor (dB)
3. The other emission levels were very low against the limit.
4. Margin value = Emission level – Limit value.
5. “ * “ : Fundamental frequency



EUT	3Com OfficeConnect Wireless 108Mbps 11g XJACK PC Card	MODEL	3CRXJK10075
CHANNEL	6	FREQUENCY RANGE	1~25 GHz
INPUT POWER (SYSTEM)	120 Vac, 60 Hz	DETECTOR FUNCTION	Peak (PK) Average (AV)
ENVIRONMENTAL CONDITIONS	25 deg. C, 65% RH, 991 hPa	TEST MODE	A
TESTED BY	Match Tsui		

ANTENNA POLARITY & TEST DISTANCE: HORIZONTAL AT 3 M

No.	Freq. (MHz)	Emission Level (dBuV/m)	Limit (dBuV/m)	Margin (dB)	Antenna Height (m)	Table Angle (Degree)	Raw Value (dBuV)	Correction Factor (dB/m)
1	1624.00	48.25 PK	74.00	-25.75	1.00 H	161	18.68	29.57
1	1624.00	43.39 AV	54.00	-10.61	1.00 H	161	13.82	29.57
2	2360.00	59.05 PK	74.00	-14.95	1.04 H	357	26.48	32.57
2	2360.00	50.40 AV	54.00	-3.60	1.04 H	357	17.83	32.57
3	*2437.00	114.91 PK			1.01 H	1	82.09	32.82
3	*2437.00	106.34 AV			1.01 H	1	73.53	32.82
4	2520.00	60.17 PK	74.00	-13.83	1.00 H	353	26.95	33.22
4	2520.00	48.85 AV	54.00	-5.15	1.00 H	353	15.63	33.22
5	3248.00	51.81 PK	74.00	-22.19	1.10 H	350	15.81	36.00
5	3248.00	42.76 AV	54.00	-11.24	1.10 H	350	6.76	36.00
6	4874.00	61.76 PK	74.00	-12.24	1.00 H	23	22.43	39.33
6	4874.00	48.76 AV	54.00	-5.24	1.00 H	23	9.43	39.33
7	9748.00	52.14 PK	74.00	-21.86	1.23 H	19	5.28	46.86
7	9748.00	45.50 AV	54.00	-8.50	1.23 H	19	-1.36	46.86

REMARKS:

1. Emission level(dBuV/m)=Raw Value(dBuV) + Correction Factor(dB)
2. Correction Factor(dB/m) = Antenna Factor (dB/m) + Cable Factor (dB)
3. The other emission levels were very low against the limit.
4. Margin value = Emission level – Limit value.
5. “ * “ : Fundamental frequency



EUT	3Com OfficeConnect Wireless 108Mbps 11g XJACK PC Card	MODEL	3CRXJK10075
CHANNEL	6	FREQUENCY RANGE	1~25 GHz
INPUT POWER (SYSTEM)	120 Vac, 60 Hz	DETECTOR FUNCTION	Peak (PK) Average (AV)
ENVIRONMENTAL CONDITIONS	25 deg. C, 65% RH, 991 hPa	TEST MODE	A
TESTED BY	Match Tsui		

ANTENNA POLARITY & TEST DISTANCE: VERTICAL AT 3 M

No.	Freq. (MHz)	Emission Level (dBuV/m)	Limit (dBuV/m)	Margin (dB)	Antenna Height (m)	Table Angle (Degree)	Raw Value (dBuV)	Correction Factor (dB/m)
1	1624.00	44.90 PK	74.00	-29.10	1.17 V	115	15.33	29.57
1	1624.00	36.63 AV	54.00	-17.37	1.17 V	115	7.06	29.57
2	1900.00	46.23 PK	74.00	-27.77	1.14 V	1	15.58	30.65
2	1900.00	45.11 AV	54.00	-8.89	1.14 V	1	14.46	30.65
3	2360.00	52.55 PK	74.00	-21.45	1.00 V	287	19.98	32.57
3	2360.00	42.71 AV	54.00	-11.29	1.00 V	287	10.14	32.57
4	*2437.00	106.70 PK			1.18 V	301	73.88	32.82
4	*2437.00	98.43 AV			1.18 V	301	65.62	32.82
5	3248.00	50.34 PK	74.00	-23.66	1.00 V	214	14.34	36.00
5	3248.00	39.90 AV	54.00	-14.10	1.00 V	214	3.90	36.00
6	4874.00	60.16 PK	74.00	-13.84	1.00 V	161	20.83	39.33
6	4874.00	46.74 AV	54.00	-7.26	1.00 V	161	7.41	39.33
7	9748.00	59.18 PK	74.00	-14.82	1.20 V	24	12.32	46.86
7	9748.00	54.95 AV	54.00	0.95	1.20 V	24	8.09	46.86

REMARKS:

1. ssion level(dBuV/m)=Raw Value(dBuV) + Correction Factor(dB)
2. Correction Factor(dB/m) = Antenna Factor (dB/m) + Cable Factor (dB)
3. The other emission levels were very low against the limit.
4. Margin value = Emission level – Limit value.
5. “ * “ : Fundamental frequency



EUT	3Com OfficeConnect Wireless 108Mbps 11g XJACK PC Card	MODEL	3CRXJK10075
CHANNEL	11	FREQUENCY RANGE	1~25 GHz
INPUT POWER (SYSTEM)	120 Vac, 60 Hz	DETECTOR FUNCTION	Peak (PK) Average (AV)
ENVIRONMENTAL CONDITIONS	25 deg. C, 65% RH, 991 hPa	TEST MODE	A
TESTED BY	Match Tsui		

ANTENNA POLARITY & TEST DISTANCE: HORIZONTAL AT 3 M

No.	Freq. (MHz)	Emission Level (dBuV/m)	Limit (dBuV/m)	Margin (dB)	Antenna Height (m)	Table Angle (Degree)	Raw Value (dBuV)	Correction Factor (dB/m)
1	1641.00	46.64 PK	74.00	-27.36	1.00 H	120	17.00	29.64
1	1641.00	42.15 AV	54.00	-11.85	1.00 H	120	12.51	29.64
2	2360.00	57.06 PK	74.00	-16.94	1.32 H	349	24.49	32.57
2	2360.00	47.19 AV	54.00	-6.81	1.32 H	349	14.62	32.57
3	*2462.00	113.90 PK			1.00 H	1	80.96	32.94
3	*2462.00	105.36 AV			1.00 H	1	72.42	32.94
4	2487.00	56.98 PK	74.00	-17.02	1.00 H	1	23.91	33.07
4	2487.00	48.44 AV	54.00	-5.56	1.00 H	1	15.37	33.07
5	2520.00	58.82 PK	74.00	-15.18	1.00 H	1	25.60	33.22
5	2520.00	46.34 AV	54.00	-7.66	1.00 H	1	13.12	33.22
6	4924.00	59.34 PK	74.00	-14.66	1.01 H	360	19.91	39.43
6	4924.00	45.52 AV	54.00	-8.48	1.01 H	360	6.09	39.43
7	9848.00	48.20 PK	74.00	-25.80	1.01 H	22	1.20	47.00
7	9848.00	40.70 AV	54.00	-13.30	1.01 H	22	-6.30	47.00

REMARKS:

1. Emission level(dBuV/m)=Raw Value(dBuV) + Correction Factor(dB)
2. Correction Factor(dB/m) = Antenna Factor (dB/m) + Cable Factor (dB)
3. The other emission levels were very low against the limit.
4. Margin value = Emission level – Limit value.
5. “ * “ : Fundamental frequency



EUT	3Com OfficeConnect Wireless 108Mbps 11g XJACK PC Card	MODEL	3CRXJK10075
CHANNEL	11	FREQUENCY RANGE	1~25 GHz
INPUT POWER (SYSTEM)	120 Vac, 60 Hz	DETECTOR FUNCTION	Peak (PK) Average (AV)
ENVIRONMENTAL CONDITIONS	25 deg. C, 65% RH, 991 hPa	TEST MODE	A
TESTED BY	Match Tsui		

ANTENNA POLARITY & TEST DISTANCE: VERTICAL AT 3 M

No.	Freq. (MHz)	Emission Level (dBuV/m)	Limit (dBuV/m)	Margin (dB)	Antenna Height (m)	Table Angle (Degree)	Raw Value (dBuV)	Correction Factor (dB/m)
1	1641.00	42.88 PK	74.00	-31.12	1.14 V	176	13.24	29.64
1	1641.00	35.62 AV	54.00	-18.38	1.14 V	176	5.98	29.64
2	2360.00	52.20 PK	74.00	-21.80	1.22 V	302	19.63	32.57
2	2360.00	42.29 AV	54.00	-11.71	1.22 V	302	9.72	32.57
3	*2462.00	110.66 PK			1.00 V	245	77.72	32.94
3	*2462.00	102.23 AV			1.00 V	245	69.29	32.94
4	2487.00	53.74 PK	74.00	-20.26	1.00 V	245	20.67	33.07
4	2487.00	45.31 AV	54.00	-8.69	1.00 V	245	12.24	33.07
5	3282.00	49.69 PK	74.00	-24.31	1.01 V	49	13.57	36.12
5	3282.00	40.95 AV	54.00	-13.05	1.01 V	49	4.83	36.12
6	4924.00	61.22 PK	74.00	-12.78	1.35 V	209	21.79	39.43
6	4924.00	47.65 AV	54.00	-6.35	1.35 V	209	8.22	39.43
7	9848.00	51.12 PK	74.00	-22.88	1.00 V	35	4.12	47.00
7	9848.00	44.98 AV	54.00	-9.02	1.00 V	35	-2.02	47.00

REMARKS:

1. Mission level(dBuV/m)=Raw Value(dBuV) + Correction Factor(dB)
2. Correction Factor(dB/m) = Antenna Factor (dB/m) + Cable Factor (dB)
3. The other emission levels were very low against the limit.
4. Margin value = Emission level – Limit value.
5. “ * “ : Fundamental frequency



EUT	3Com OfficeConnect Wireless 108Mbps 11g XJACK PC Card	MODEL	3CRXJK10075
CHANNEL	1	FREQUENCY RANGE	1~25 GHz
INPUT POWER (SYSTEM)	120 Vac, 60 Hz	DETECTOR FUNCTION	Peak (PK) Average (AV)
ENVIRONMENTAL CONDITIONS	25 deg. C, 65% RH, 991 hPa	TEST MODE	B
TESTED BY	Match Tsui		

ANTENNA POLARITY & TEST DISTANCE: HORIZONTAL AT 3 M

No.	Freq. (MHz)	Emission Level (dBuV/m)	Limit (dBuV/m)	Margin (dB)	Antenna Height (m)	Table Angle (Degree)	Raw Value (dBuV)	Correction Factor (dB/m)
1	1608.00	51.60 PK	74.00	-22.40	1.00 H	161	22.10	29.50
1	1608.00	48.82 AV	54.00	-5.18	1.00 H	161	19.32	29.50
2	2360.00	64.86 PK	74.00	-9.14	1.02 H	348	32.29	32.57
2	2360.00	52.87 AV	54.00	-1.13	1.02 H	348	20.30	32.57
3	2390.00	63.05 PK	74.00	-10.95	1.03 H	1	30.43	32.62
3	2390.00	51.06 AV	54.00	-2.94	1.03 H	1	18.44	32.62
4	*2412.00	112.20 PK			1.03 H	1	79.51	32.69
4	*2412.00	100.21 AV			1.03 H	1	67.52	32.69
5	2520.00	58.73 PK	74.00	-15.27	1.00 H	1	25.51	33.22
5	2520.00	48.02 AV	54.00	-5.98	1.00 H	1	14.80	33.22
6	3216.00	49.45 PK	74.00	-24.55	1.00 H	360	13.56	35.89
6	3216.00	40.61 AV	54.00	-13.39	1.00 H	360	4.72	35.89
7	4824.00	50.56 PK	74.00	-23.44	1.03 H	330	11.32	39.24
7	4824.00	36.71 AV	54.00	-17.29	1.03 H	330	-2.53	39.24

REMARKS:

1. Emission level(dBuV/m)=Raw Value(dBuV) + Correction Factor(dB)
2. Correction Factor(dB/m) = Antenna Factor (dB/m) + Cable Factor (dB)
3. The other emission levels were very low against the limit.
4. Margin value = Emission level – Limit value.
5. " * " : Fundamental frequency



EUT	3Com OfficeConnect Wireless 108Mbps 11g XJACK PC Card	MODEL	3CRXJK10075
CHANNEL	1	FREQUENCY RANGE	1~25 GHz
INPUT POWER (SYSTEM)	120 Vac, 60 Hz	DETECTOR FUNCTION	Peak (PK) Average (AV)
ENVIRONMENTAL CONDITIONS	25 deg. C, 65% RH, 991 hPa	TEST MODE	B
TESTED BY	Match Tsui		

ANTENNA POLARITY & TEST DISTANCE: VERTICAL AT 3 M

No.	Freq. (MHz)	Emission Level (dBuV/m)	Limit (dBuV/m)	Margin (dB)	Antenna Height (m)	Table Angle (Degree)	Raw Value (dBuV)	Correction Factor (dB/m)
1	1608.00	47.88 PK	74.00	-26.12	1.41 V	179	18.38	29.50
1	1608.00	43.62 AV	54.00	-10.38	1.41 V	179	14.12	29.50
2	2360.00	56.98 PK	74.00	-17.02	1.16 V	184	24.41	32.57
2	2360.00	44.83 AV	54.00	-9.17	1.16 V	184	12.26	32.57
3	2390.00	55.17 PK	74.00	-18.83	1.15 V	142	22.55	32.62
3	2390.00	43.02 AV	54.00	-10.98	1.15 V	142	10.40	32.62
4	*2412.00	104.32 PK			1.15 V	142	71.63	32.69
4	*2412.00	92.17 AV			1.15 V	142	59.48	32.69
5	2520.00	55.73 PK	74.00	-18.27	1.00 V	219	22.51	33.22
5	2520.00	44.58 AV	54.00	-9.42	1.00 V	219	11.36	33.22
6	3216.00	48.91 PK	74.00	-25.09	1.01 V	220	13.02	35.89
6	3216.00	39.29 AV	54.00	-14.71	1.01 V	220	3.40	35.89
7	4824.00	50.80 PK	74.00	-23.20	1.16 V	294	11.56	39.24
7	4824.00	37.66 AV	54.00	-16.34	1.16 V	294	-1.58	39.24

REMARKS:

1. Emission level(dBuV/m)=Raw Value(dBuV) + Correction Factor(dB)
2. Correction Factor(dB/m) = Antenna Factor (dB/m) + Cable Factor (dB)
3. The other emission levels were very low against the limit.
4. Margin value = Emission level – Limit value.
5. “ * “ : Fundamental frequency



EUT	3Com OfficeConnect Wireless 108Mbps 11g XJACK PC Card	MODEL	3CRXJK10075
CHANNEL	6	FREQUENCY RANGE	1~25 GHz
INPUT POWER (SYSTEM)	120 Vac, 60 Hz	DETECTOR FUNCTION	Peak (PK) Average (AV)
ENVIRONMENTAL CONDITIONS	25 deg. C, 65% RH, 991 hPa	TEST MODE	B
TESTED BY	Match Tsui		

ANTENNA POLARITY & TEST DISTANCE: HORIZONTAL AT 3 M

No.	Freq. (MHz)	Emission Level (dBuV/m)	Limit (dBuV/m)	Margin (dB)	Antenna Height (m)	Table Angle (Degree)	Raw Value (dBuV)	Correction Factor (dB/m)
1	1624.00	43.44 PK	74.00	-30.56	1.21 H	216	13.87	29.57
1	1624.00	35.60 AV	54.00	-18.38	1.21 H	216	6.05	29.57
2	2160.00	47.04 PK	74.00	-26.96	1.00 H	120	15.17	31.87
2	2160.00	36.59 AV	54.00	-17.41	1.00 H	120	4.72	31.87
3	2360.00	57.15 PK	74.00	-16.85	1.03 H	349	24.58	32.57
3	2360.00	46.47 AV	54.00	-7.53	1.03 H	349	13.90	32.57
4	*2437.00	112.40 PK			1.28 H	353	79.59	32.82
4	*2437.00	101.49 AV			1.28 H	353	68.67	32.82
5	2520.00	57.67 PK	74.00	-16.33	1.00 H	1	24.45	33.22
5	2520.00	45.62 AV	54.00	-8.38	1.00 H	1	12.40	33.22
6	4874.00	61.51 PK	74.00	-12.49	1.23 H	94	22.18	39.33
6	4874.00	47.24 AV	54.00	-6.76	1.23 H	94	7.91	39.33
7	7311.00	59.73 PK	74.00	-14.27	1.23 H	30	15.72	44.01
7	7311.00	45.27 AV	54.00	-8.73	1.23 H	30	1.26	44.01

REMARKS:

1. Emission level(dBuV/m)=Raw Value(dBuV) + Correction Factor(dB)
2. Correction Factor(dB/m) = Antenna Factor (dB/m) + Cable Factor (dB)
3. The other emission levels were very low against the limit.
4. Margin value = Emission level – Limit value.
5. “ * “ : Fundamental frequency



EUT	3Com OfficeConnect Wireless 108Mbps 11g XJACK PC Card	MODEL	3CRXJK10075
CHANNEL	6	FREQUENCY RANGE	1~25 GHz
INPUT POWER (SYSTEM)	120 Vac, 60 Hz	DETECTOR FUNCTION	Peak (PK) Average (AV)
ENVIRONMENTAL CONDITIONS	25 deg. C, 65% RH, 991 hPa	TEST MODE	B
TESTED BY	Match Tsui		

ANTENNA POLARITY & TEST DISTANCE: VERTICAL AT 3 M

No.	Freq. (MHz)	Emission Level (dBuV/m)	Limit (dBuV/m)	Margin (dB)	Antenna Height (m)	Table Angle (Degree)	Raw Value (dBuV)	Correction Factor (dB/m)
1	2360.00	53.07 PK	74.00	-20.93	1.20 V	318	20.50	32.57
1	2360.00	42.26 AV	54.00	-11.74	1.20 V	318	9.69	32.57
2	*2437.00	107.30 PK			1.17 V	321	74.48	32.82
2	*2437.00	96.70 AV			1.17 V	321	63.88	32.82
3	2520.00	54.20 PK	74.00	-19.80	1.00 V	214	20.98	33.22
3	2520.00	42.48 AV	54.00	-11.52	1.00 V	214	9.26	33.22
4	4874.00	56.81 PK	74.00	-17.19	1.00 V	205	17.48	39.33
4	4874.00	44.43 AV	54.00	-9.57	1.00 V	205	5.10	39.33
5	7311.00	58.65 PK	74.00	-15.35	1.07 V	234	14.64	44.01
5	7311.00	43.43 AV	54.00	-10.57	1.07 V	234	-0.58	44.01

REMARKS:

1. Emission level(dBuV/m)=Raw Value(dBuV) + Correction Factor(dB)
2. Correction Factor(dB/m) = Antenna Factor (dB/m) + Cable Factor (dB)
3. The other emission levels were very low against the limit.
4. Margin value = Emission level – Limit value.
5. “ * “ : Fundamental frequency



EUT	3Com OfficeConnect Wireless 108Mbps 11g XJACK PC Card	MODEL	3CRXJK10075
CHANNEL	11	FREQUENCY RANGE	1~25 GHz
INPUT POWER (SYSTEM)	120 Vac, 60 Hz	DETECTOR FUNCTION	Peak (PK) Average (AV)
ENVIRONMENTAL CONDITIONS	25 deg. C, 65% RH, 991 hPa	TEST MODE	B
TESTED BY	Match Tsui		

ANTENNA POLARITY & TEST DISTANCE: HORIZONTAL AT 3 M

No.	Freq. (MHz)	Emission Level (dBuV/m)	Limit (dBuV/m)	Margin (dB)	Antenna Height (m)	Table Angle (Degree)	Raw Value (dBuV)	Correction Factor (dB/m)
1	1641.00	49.04 PK	74.00	-24.96	1.00 H	136	19.40	29.64
1	1641.00	45.34 AV	54.00	-8.66	1.00 H	136	15.70	29.64
2	2320.00	56.99 PK	74.00	-17.01	1.04 H	351	24.47	32.52
2	2320.00	47.16 AV	54.00	-6.84	1.04 H	351	14.64	32.52
3	2360.00	59.94 PK	74.00	-14.06	1.03 H	350	27.37	32.57
3	2360.00	49.07 AV	54.00	-4.93	1.03 H	350	16.50	32.57
4	*2462.00	111.54 PK			1.01 H	356	78.60	32.94
4	*2462.00	100.01 AV			1.01 H	356	67.07	32.94
5	2483.50	64.32 PK	74.00	-9.68	1.01 H	356	31.27	33.05
5	2483.50	52.79 AV	54.00	-1.21	1.01 H	356	19.74	33.05
6	2520.00	56.09 PK	74.00	-17.91	1.21 H	3	22.87	33.22
6	2520.00	45.51 AV	54.00	-8.49	1.21 H	3	12.29	33.22
7	4924.00	56.67 PK	74.00	-17.33	1.00 H	19	17.24	39.43
7	4924.00	40.71 AV	54.00	-13.29	1.00 H	19	1.28	39.43

REMARKS:

1. Emission level(dBuV/m)=Raw Value(dBuV) + Correction Factor(dB)
2. Correction Factor(dB/m) = Antenna Factor (dB/m) + Cable Factor (dB)
3. The other emission levels were very low against the limit.
4. Margin value = Emission level – Limit value.
5. “ * “ : Fundamental frequency



EUT	3Com OfficeConnect Wireless 108Mbps 11g XJACK PC Card	MODEL	3CRXJK10075
CHANNEL	11	FREQUENCY RANGE	1~25 GHz
INPUT POWER (SYSTEM)	120 Vac, 60 Hz	DETECTOR FUNCTION	Peak (PK) Average (AV)
ENVIRONMENTAL CONDITIONS	25 deg. C, 65% RH, 991 hPa	TEST MODE	B
TESTED BY	Match Tsui		

ANTENNA POLARITY & TEST DISTANCE: VERTICAL AT 3 M

No.	Freq. (MHz)	Emission Level (dBuV/m)	Limit (dBuV/m)	Margin (dB)	Antenna Height (m)	Table Angle (Degree)	Raw Value (dBuV)	Correction Factor (dB/m)
1	1642.00	43.40 PK	74.00	-30.60	1.16 V	174	13.75	29.65
1	1642.00	35.55 AV	54.00	-18.45	1.16 V	174	5.90	29.65
2	2360.00	46.28 PK	74.00	-27.72	1.20 V	312	13.71	32.57
2	2360.00	42.38 AV	54.00	-11.62	1.20 V	312	9.81	32.57
3	*2462.00	106.16 PK			1.43 V	325	73.22	32.94
3	*2462.00	94.68 AV			1.43 V	325	61.74	32.94
4	2483.50	58.94 PK	74.00	-15.06	1.43 V	325	25.89	33.05
4	2483.50	47.46 AV	54.00	-6.54	1.43 V	325	14.41	33.05
5	2520.00	54.39 PK	74.00	-19.61	1.00 V	215	21.17	33.22
5	2520.00	42.64 AV	54.00	-11.36	1.00 V	215	9.42	33.22
6	3282.00	48.84 PK	74.00	-25.16	1.03 V	38	12.72	36.12
6	3282.00	39.45 AV	54.00	-14.55	1.03 V	38	3.33	36.12
7	4924.00	52.36 PK	74.00	-21.64	1.44 V	82	12.93	39.43
7	4924.00	38.53 AV	54.00	-15.47	1.44 V	82	-0.90	39.43
8	9848.00	46.49 PK	74.00	-27.51	1.27 V	360	-0.51	47.00
8	9848.00	33.73 AV	54.00	-20.27	1.27 V	360	-13.27	47.00

REMARKS:

1. Emission level(dBuV/m)=Raw Value(dBuV) + Correction Factor(dB)
2. Correction Factor(dB/m) = Antenna Factor (dB/m) + Cable Factor (dB)
3. The other emission levels were very low against the limit.
4. Margin value = Emission level – Limit value.
5. “ * “ : Fundamental frequency



EUT	3Com OfficeConnect Wireless 108Mbps 11g XJACK PC Card	MODEL	3CRXJK10075
CHANNEL	6	FREQUENCY RANGE	1~25 GHz
INPUT POWER (SYSTEM)	120 Vac, 60 Hz	DETECTOR FUNCTION	Peak (PK) Average (AV)
ENVIRONMENTAL CONDITIONS	25 deg. C, 65% RH, 991 hPa	TEST MODE	C
TESTED BY	Match Tsui		

ANTENNA POLARITY & TEST DISTANCE: HORIZONTAL AT 3 M

No.	Freq. (MHz)	Emission Level (dBuV/m)	Limit (dBuV/m)	Margin (dB)	Antenna Height (m)	Table Angle (Degree)	Raw Value (dBuV)	Correction Factor (dB/m)
1	1624.00	46.84 PK	74.00	-27.16	1.00 H	221	17.27	29.57
1	1624.00	42.46 AV	54.00	-11.54	1.00 H	221	12.89	29.57
2	2360.00	62.48 PK	74.00	-11.52	1.07 H	6	29.91	32.57
2	2360.00	52.73 AV	54.00	-1.27	1.07 H	6	20.16	32.57
3	2390.00	58.36 PK	74.00	-15.64	1.00 H	7	25.74	32.62
3	2390.00	48.61 AV	54.00	-5.39	1.00 H	7	15.99	32.62
4	*2437.00	107.48 PK			1.00 H	7	74.66	32.82
4	*2437.00	97.93 AV			1.00 H	7	65.12	32.82
5	2483.50	58.67 PK	74.00	-15.33	1.00 H	7	25.62	33.05
5	2483.50	48.92 AV	54.00	-5.08	1.00 H	7	15.87	33.05
6	3248.00	49.08 PK	74.00	-24.92	1.03 H	190	13.08	36.00
6	3248.00	37.23 AV	54.00	-16.77	1.03 H	190	1.23	36.00
7	4874.00	50.61 PK	74.00	-23.39	1.13 H	343	11.28	39.33
7	4874.00	37.43 AV	54.00	-16.57	1.13 H	343	-1.90	39.33

REMARKS:

1. Emission level(dBuV/m)=Raw Value(dBuV) + Correction Factor(dB)
2. Correction Factor(dB/m) = Antenna Factor (dB/m) + Cable Factor (dB)
3. The other emission levels were very low against the limit.
4. Margin value = Emission level – Limit value.
5. “ * “ : Fundamental frequency



EUT	3Com OfficeConnect Wireless 108Mbps 11g XJACK PC Card	MODEL	3CRXJK10075
CHANNEL	6	FREQUENCY RANGE	1~25 GHz
INPUT POWER (SYSTEM)	120 Vac, 60 Hz	DETECTOR FUNCTION	Peak (PK) Average (AV)
ENVIRONMENTAL CONDITIONS	25 deg. C, 65% RH, 991 hPa	TEST MODE	C
TESTED BY	Match Tsui		

ANTENNA POLARITY & TEST DISTANCE: VERTICAL AT 3 M

No.	Freq. (MHz)	Emission Level (dBuV/m)	Limit (dBuV/m)	Margin (dB)	Antenna Height (m)	Table Angle (Degree)	Raw Value (dBuV)	Correction Factor (dB/m)
1	1624.00	45.50 PK	74.00	-28.50	1.07 V	306	15.93	29.65
1	1624.00	40.71 AV	54.00	-13.29	1.07 V	306	11.14	29.65
2	2360.00	57.00 PK	74.00	-17.00	1.00 V	12	24.43	32.57
2	2360.00	47.24 AV	54.00	-6.76	1.00 V	12	14.67	32.57
3	2390.00	51.88 PK	74.00	-22.12	1.00 V	10	19.26	32.94
3	2390.00	42.12 AV	54.00	-11.88	1.00 V	10	9.50	32.94
4	*2437.00	102.00 PK			1.00 V	10	69.19	32.94
4	*2437.00	92.24 AV			1.00 V	10	59.42	32.94
5	2483.50	53.19 PK	74.00	-20.81	1.00 V	10	20.14	33.05
5	2483.50	43.43 AV	54.00	-10.57	1.00 V	10	10.38	33.05
6	3248.00	51.46 PK	74.00	-22.54	1.00 V	225	15.46	36.12
6	3248.00	37.85 AV	54.00	-16.15	1.00 V	225	1.85	36.12
7	4874.00	52.92 PK	74.00	-21.08	1.34 V	241	13.59	39.43
7	4874.00	38.51 AV	54.00	-15.49	1.34 V	241	-0.82	39.43

REMARKS:

1. Emission level(dBuV/m)=Raw Value(dBuV) + Correction Factor(dB)
2. Correction Factor(dB/m) = Antenna Factor (dB/m) + Cable Factor (dB)
3. The other emission levels were very low against the limit.
4. Margin value = Emission level – Limit value.
5. “ * “ : Fundamental frequency



4.3 6dB BANDWIDTH MEASUREMENT

4.3.1 LIMITS OF 6dB BANDWIDTH MEASUREMENT

The minimum of 6dB Bandwidth Measurement is 0.5MHz.

4.3.2 TEST INSTRUMENTS

Description & Manufacturer	Model No.	Serial No.	Calibrated Until
SPECTRUM ANALYZER	FSEK30	100049	Aug. 11, 2005

NOTE:

The calibration interval of the above test instruments is 12 months and the calibrations are traceable to NML/ROC and NIST/USA.

4.3.3 TEST PROCEDURE

The transmitter output was connected to the spectrum analyzer through an attenuator. The bandwidth of the fundamental frequency was measured by spectrum analyzer with 100kHz RBW and 100kHz VBW. The 6dB bandwidth is defined as the total spectrum the power of which is higher than peak power minus 6dB.

4.3.4 DEVIATION FROM TEST STANDARD

No deviation

4.3.5 TEST SETUP

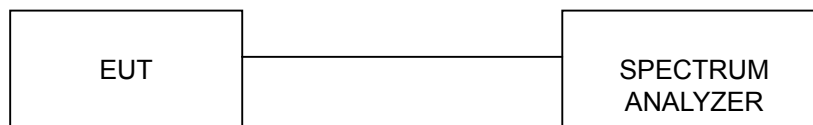

For the actual test configuration, please refer to the related Item – Photographs of the Test Configuration.

4.3.6 EUT OPERATING CONDITIONS

The software provided by client to enable the EUT under transmission condition continuously at lowest, middle and highest channel frequencies individually.



4.3.7 TEST RESULTS

EUT	3Com OfficeConnect Wireless 108Mbps 11g XJACK PC Card	MODEL	3CRXJK10075
INPUT POWER (SYSTEM)	120 Vac, 60 Hz	ENVIRONMENTAL CONDITIONS	25 deg. C, 60% RH, 991 hPa
TEST MODE	A	TESTED BY	Match Tsui

CHANNEL	CHANNEL FREQUENCY (MHz)	6dB BANDWIDTH (MHz)	MINIMUM LIMIT (MHz)	PASS/FAIL
1	2412	11.44	0.5	PASS
6	2437	11.00	0.5	PASS
11	2462	12.04	0.5	PASS



CH1

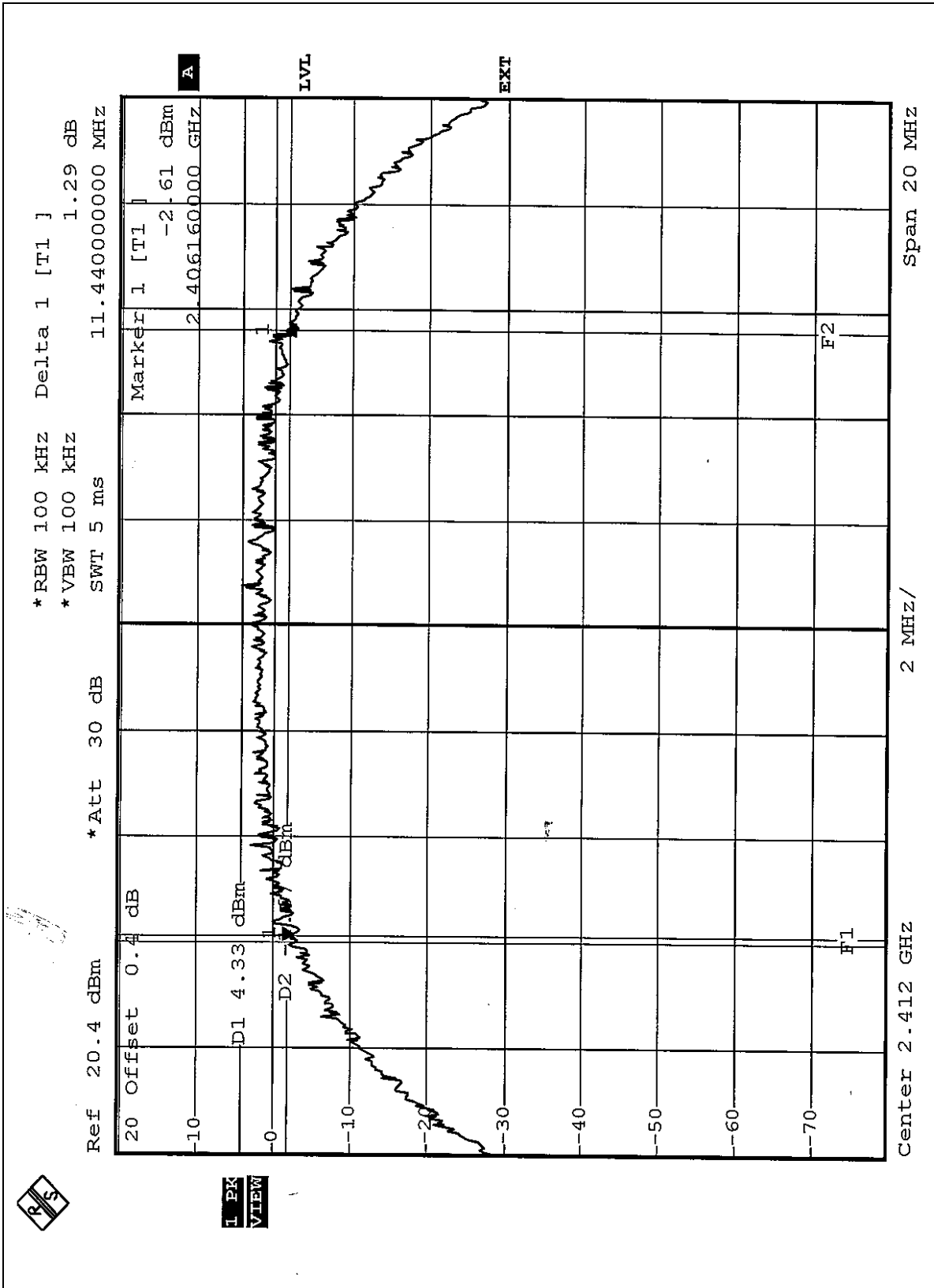



CH6

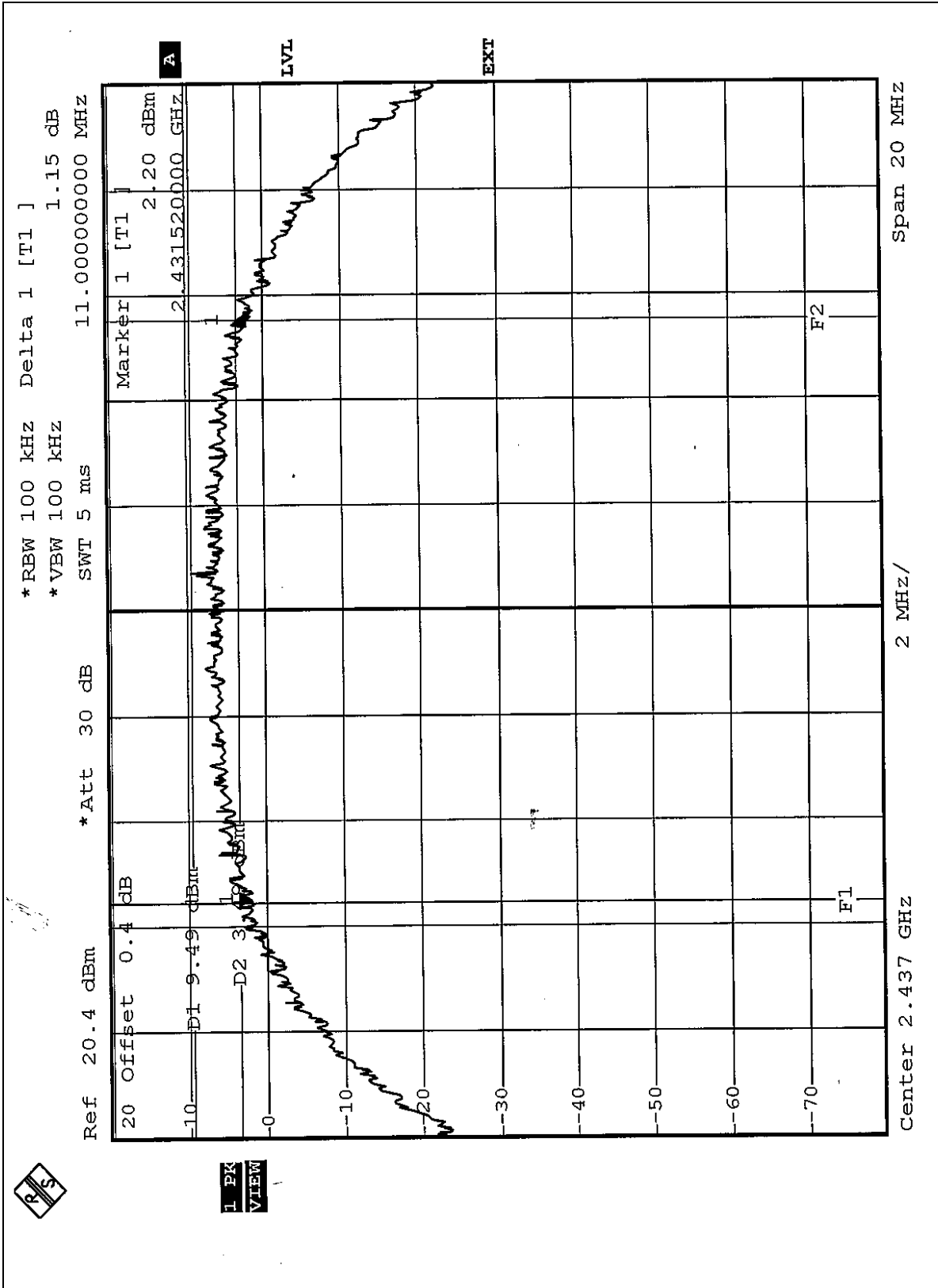



CH11

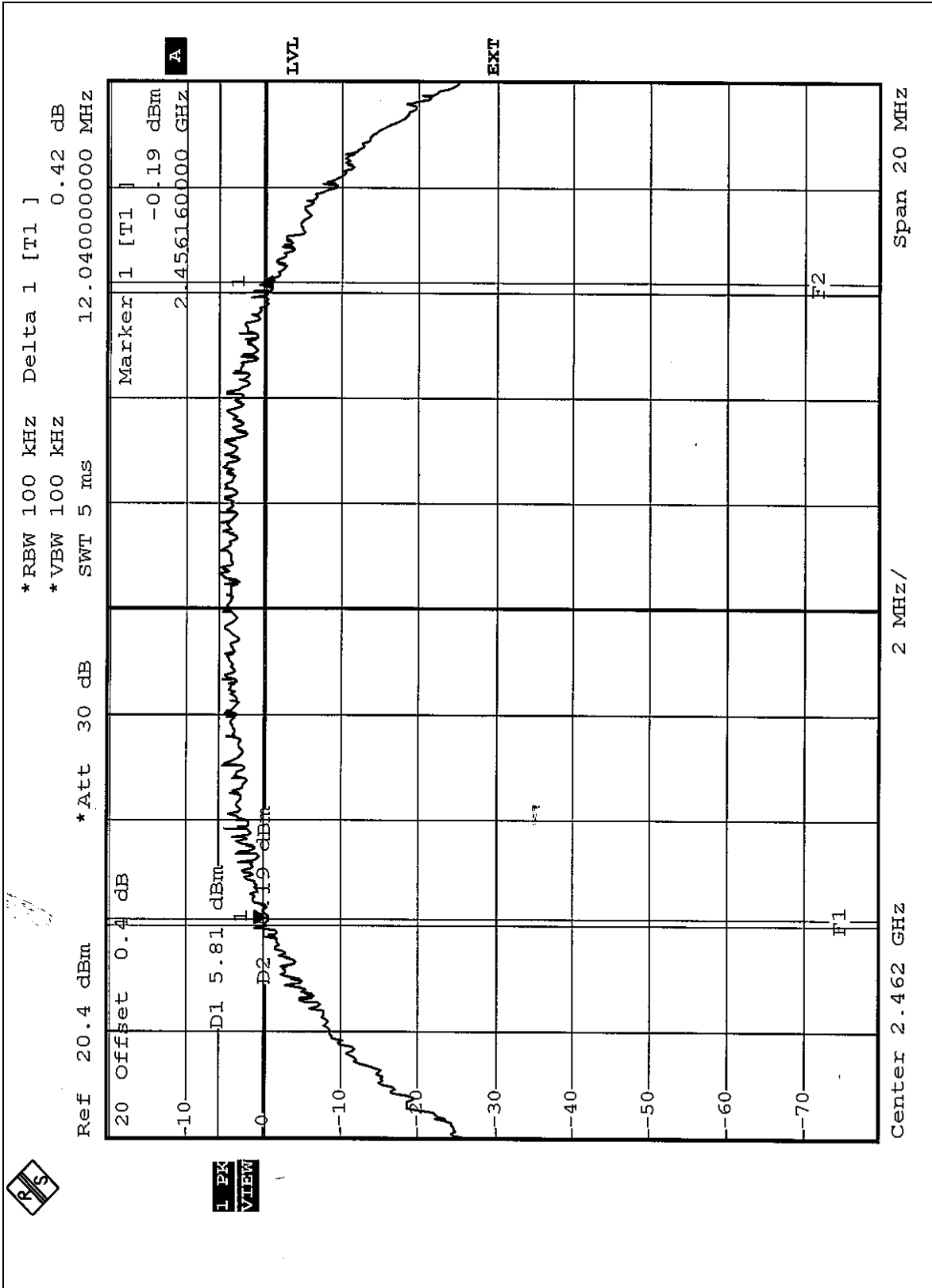



EUT	3Com OfficeConnect Wireless 108Mbps 11g XJACK PC Card	MODEL	3CRXJK10075
INPUT POWER (SYSTEM)	120 Vac, 60 Hz	ENVIRONMENTAL CONDITIONS	25 deg. C, 60% RH, 991 hPa
TEST MODE	B	TESTED BY	Match Tsui

CHANNEL	CHANNEL FREQUENCY (MHz)	6 dB BANDWIDTH (MHz)	MINIMUM LIMIT (MHz)	PASS/FAIL
1	2412	16.56	0.5	PASS
6	2437	16.52	0.5	PASS
11	2462	16.56	0.5	PASS



CH1

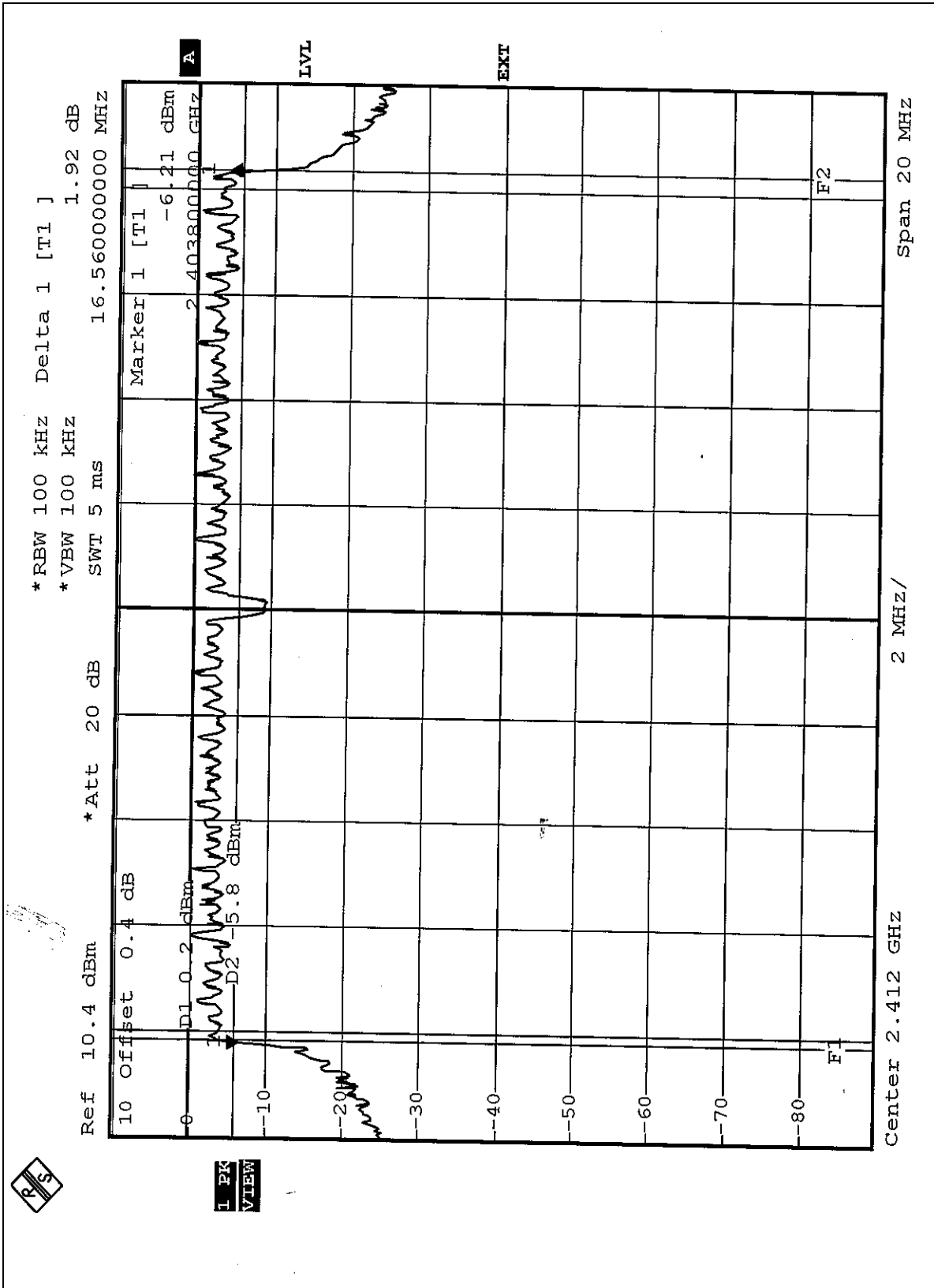



CH6

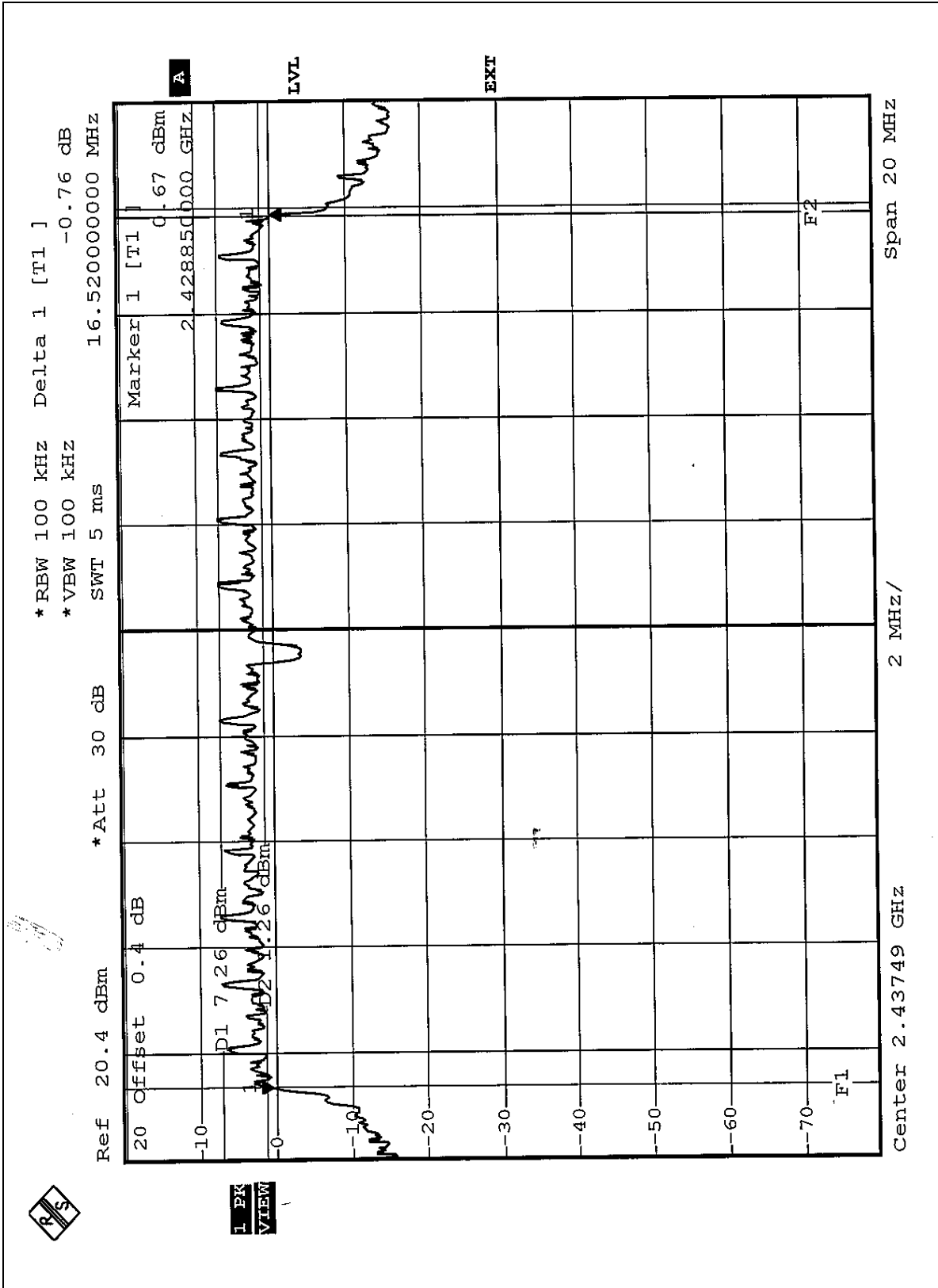



CH11

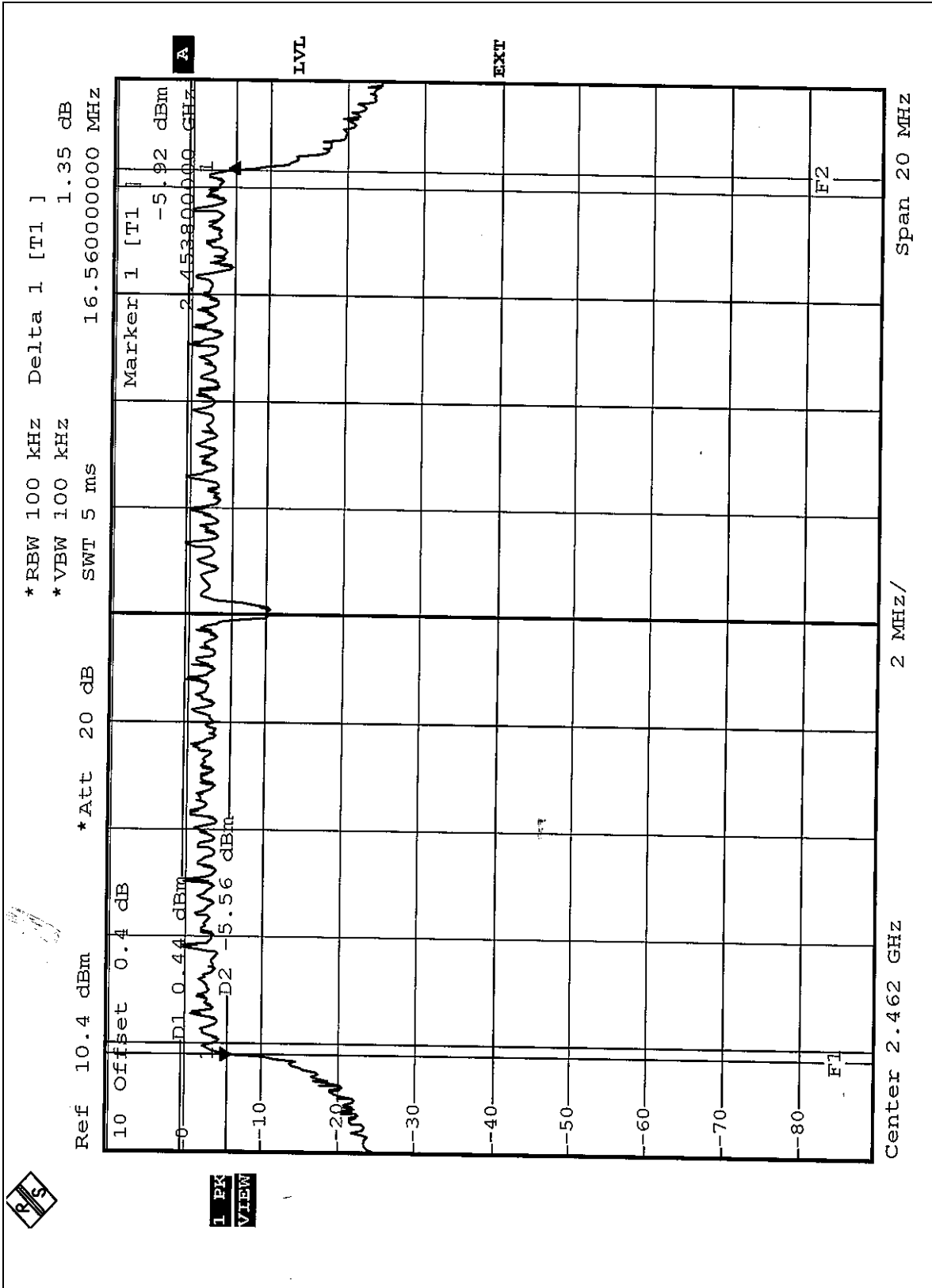



EUT	3Com OfficeConnect Wireless 108Mbps 11g XJACK PC Card	MODEL	3CRXJK10075
INPUT POWER (SYSTEM)	120 Vac, 60 Hz	ENVIRONMENTAL CONDITIONS	24 deg. C, 65% RH, 991 hPa
TEST MODE	C	TESTED BY	Match Tsui

CHANNEL	CHANNEL FREQUENCY (MHz)	6 dB BANDWIDTH (MHz)	MINIMUM LIMIT (MHz)	PASS/FAIL
6	2437	33.12	0.5	PASS



CH6

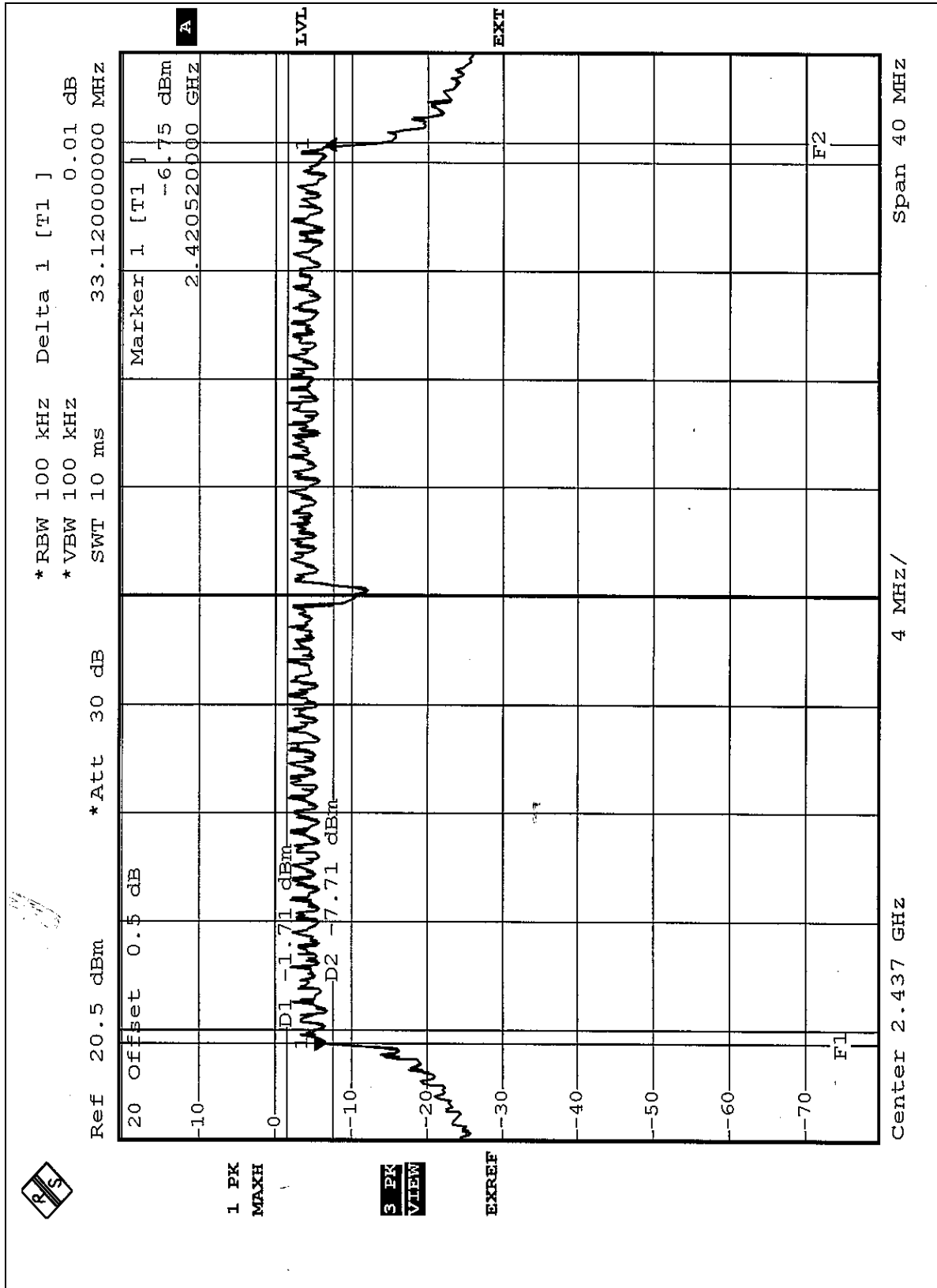



4.4 MAXIMUM PEAK OUTPUT POWER

4.4.1 LIMITS OF MAXIMUM PEAK OUTPUT POWER MEASUREMENT

The Maximum Peak Output Power Measurement is 30dBm.

4.4.2 TEST INSTRUMENTS

Description & Manufacturer	Model No.	Serial No.	Calibrated Until
R&S SPECTRUM ANALYZER	FSEK30	100049	Aug. 11, 2005
AGILENT SIGNAL GENERATOR	E8257C	MY43320668	Dec. 31, 2004
TEKTRONIX OSCILLOSCOPE	TDS 220	C019167	Feb. 1, 2005
NARDA DETECTOR	4503A	FSCM99899	NA

NOTE:

The calibration interval of the above test instruments is 12 months and the calibrations are traceable to NML/ROC and NIST/USA.

4.4.3 TEST PROCEDURES

1. A detector was used on the output port of the EUT. An oscilloscope was used to read the response of the detector.
2. Replaced the EUT by the signal generator. The center frequency of the S.G. was adjusted to the center frequency of the measured channel.
3. Adjusted the power to have the same reading on oscilloscope. Record the power level.

4.4.4 DEVIATION FROM TEST STANDARD

No deviation

4.4.5 TEST SETUP

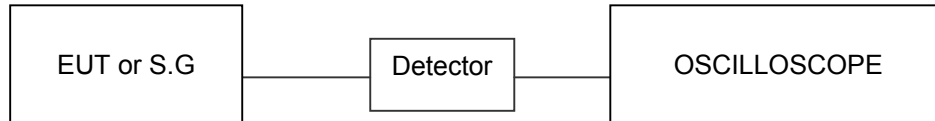

4.4.6 EUT OPERATING CONDITIONS

Same as Item 4.3.6



4.4.7 TEST RESULTS

EUT	3Com OfficeConnect Wireless 108Mbps 11g XJACK PC Card	MODEL	3CRXJK10075
INPUT POWER (SYSTEM)	120 Vac, 60 Hz	ENVIRONMENTAL CONDITIONS	24 deg. C, 65% RH, 991 hPa
TEST MODE	A	TESTED BY	Match Tsui

CHANNEL	CHANNEL FREQUENCY (MHz)	PEAK POWER OUTPUT (dBm)	PEAK POWER LIMIT (dBm)	PASS/FAIL
1	2412	15.50	30	PASS
6	2437	17.50	30	PASS
11	2462	17.50	30	PASS

EUT	3Com OfficeConnect Wireless 108Mbps 11g XJACK PC Card	MODEL	3CRXJK10075
INPUT POWER (SYSTEM)	120 Vac, 60 Hz	ENVIRONMENTAL CONDITIONS	24 deg. C, 65% RH, 991 hPa
TEST MODE	B	TESTED BY	Match Tsui

CHANNEL	CHANNEL FREQUENCY (MHz)	PEAK POWER OUTPUT (dBm)	PEAK POWER LIMIT (dBm)	PASS/FAIL
1	2412	17.00	30	PASS
6	2437	17.03	30	PASS
11	2462	17.01	30	PASS

EUT	3Com OfficeConnect Wireless 108Mbps 11g XJACK PC Card	MODEL	3CRXJK10075
INPUT POWER (SYSTEM)	120 Vac, 60 Hz	ENVIRONMENTAL CONDITIONS	24 deg. C, 65% RH, 991 hPa
TEST MODE	C	TESTED BY	Match Tsui

CHANNEL	CHANNEL FREQUENCY (MHz)	PEAK POWER OUTPUT (dBm)	PEAK POWER LIMIT (dBm)	PASS/FAIL
6	2437	15.01	30	PASS



4.5 POWER SPECTRAL DENSITY MEASUREMENT

4.5.1 LIMITS OF POWER SPECTRAL DENSITY MEASUREMENT

The Maximum of Power Spectral Density Measurement is 8dBm.

4.5.2 TEST INSTRUMENTS

Description & Manufacturer	Model No.	Serial No.	Calibrated Until
SPECTRUM ANALYZER	FSEK30	100049	Aug. 11, 2005

NOTE:

The calibration interval of the above test instruments is 12 months and the calibrations are traceable to NML/ROC and NIST/USA.

4.5.3 TEST PROCEDURE

The transmitter output was connected to the spectrum analyzer through an attenuator, the bandwidth of the fundamental frequency was measured with the spectrum analyzer using 3 kHz RBW and 30 kHz VBW, set sweep time=span/3kHz. The power spectral density was measured and recorded. The sweep time is allowed to be longer than span/3kHz for a full response of the mixer in the spectrum analyzer.

4.5.4 DEVIATION FROM TEST STANDARD

No deviation

4.5.5 TEST SETUP

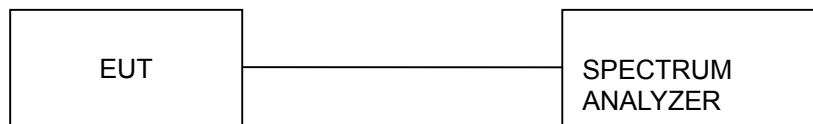

4.5.6 EUT OPERATING CONDITIONS

Same as 4.3.6



4.5.7 TEST RESULTS

EUT	3Com OfficeConnect Wireless 108Mbps 11g XJACK PC Card	MODEL	3CRXJK10075
INPUT POWER (SYSTEM)	120 Vac, 60 Hz	ENVIRONMENTAL CONDITIONS	24 deg. C, 65% RH, 991 hPa
TEST MODE	A	TESTED BY	Match Tsui

CHANNEL NUMBER	CHANNEL FREQUENCY (MHz)	RF POWER LEVEL IN 3kHz BW (dBm)	MAXIMUM LIMIT (dBm)	PASS/FAIL
1	2412	-9.59	8	PASS
6	2437	-10.33	8	PASS
11	2462	-10.15	8	PASS



CH1

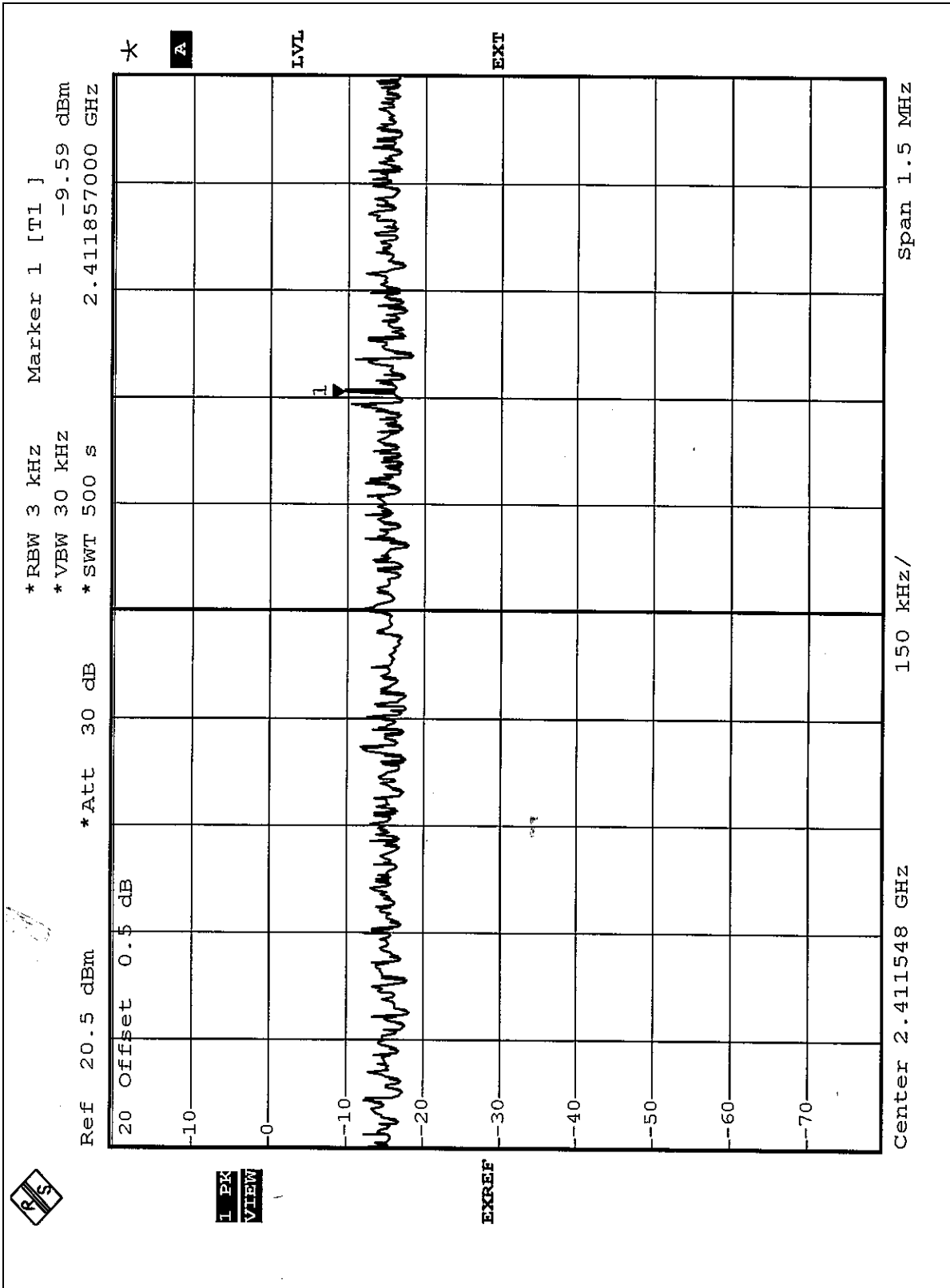



CH6

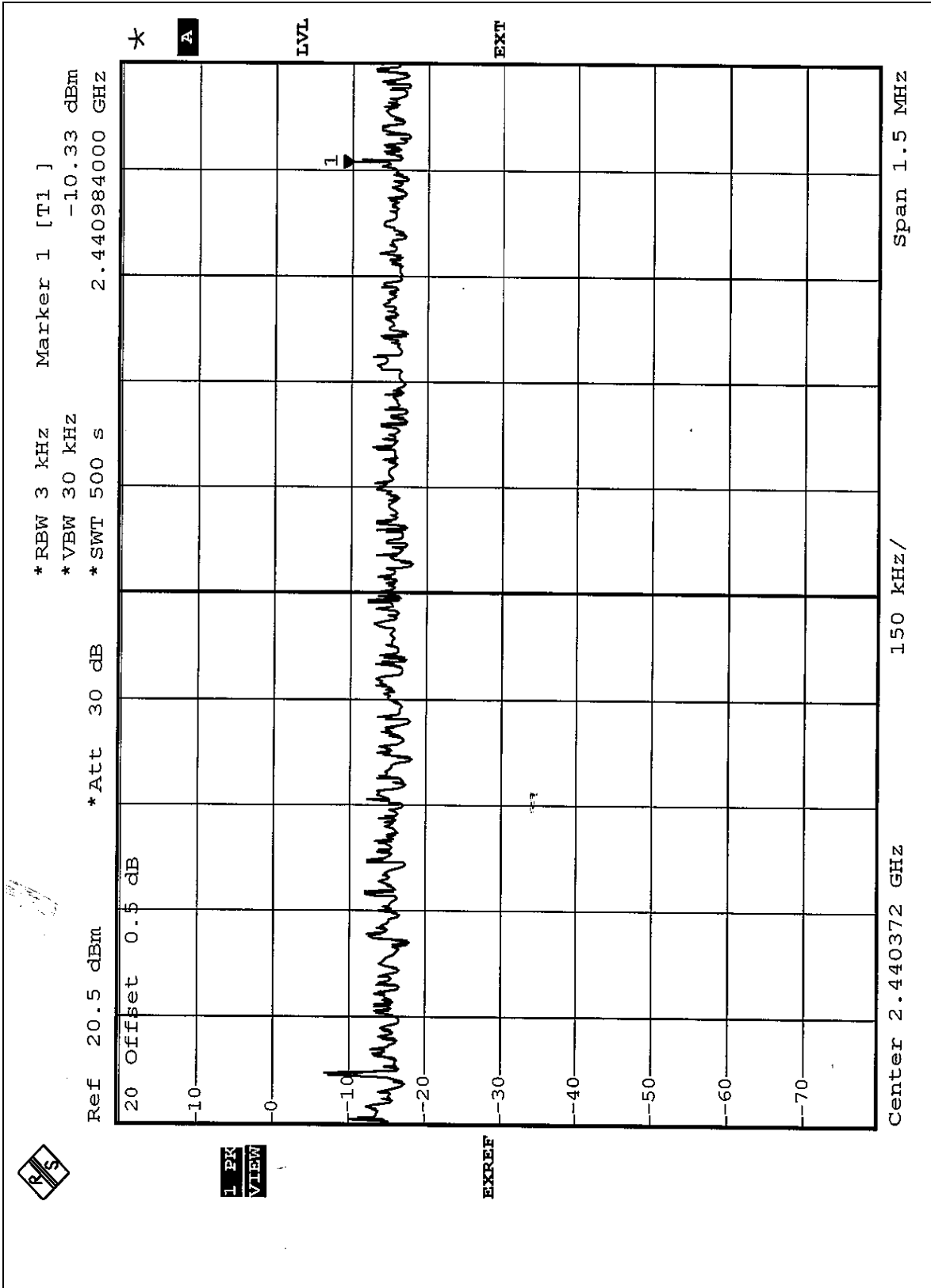



CH11

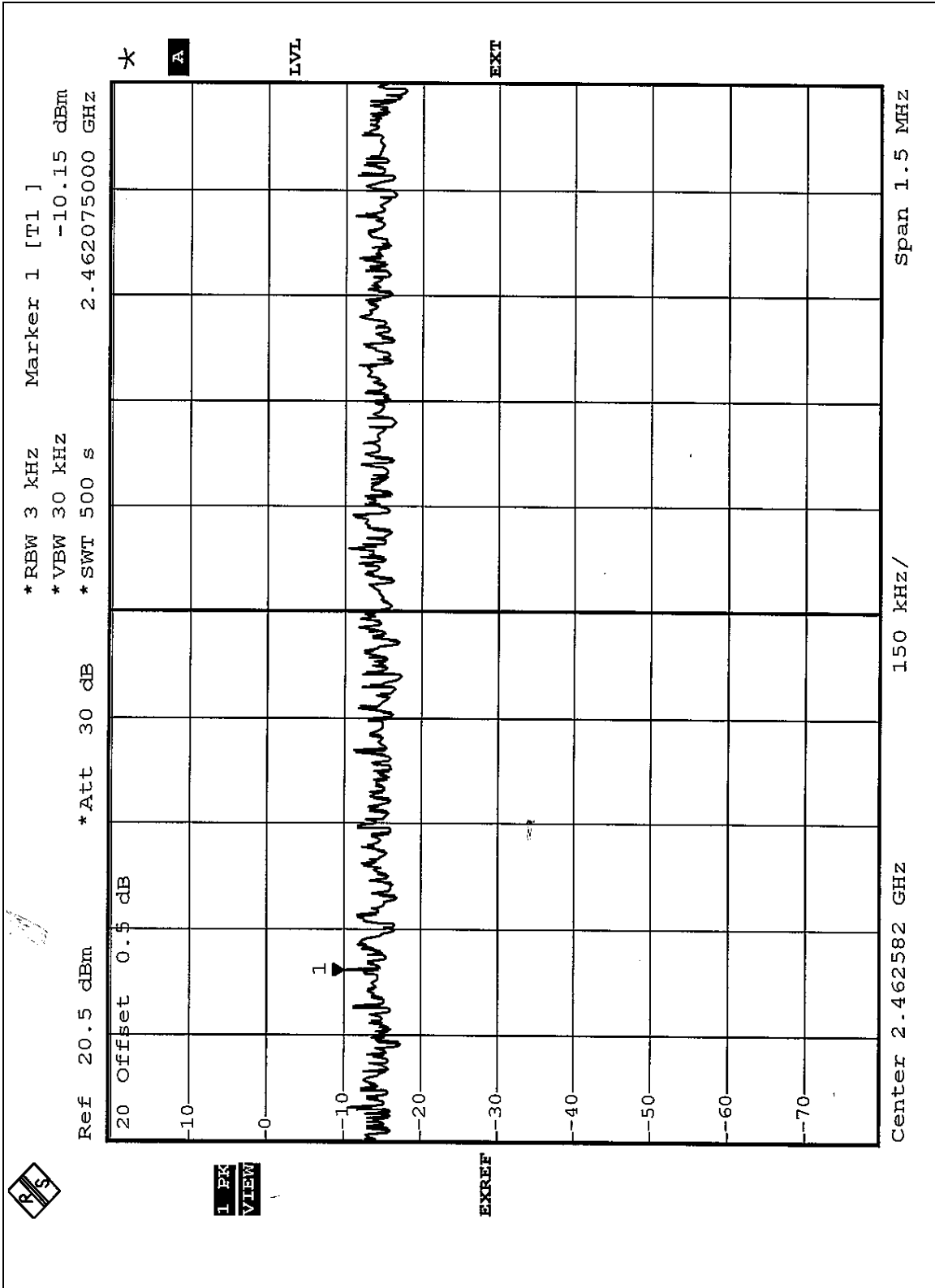



EUT	3Com OfficeConnect Wireless 108Mbps 11g XJACK PC Card	MODEL	3CRXJK10075
INPUT POWER (SYSTEM)	120 Vac, 60 Hz	ENVIRONMENTAL CONDITIONS	24 deg. C, 65% RH, 991 hPa
TEST MODE	B	TESTED BY	Match Tsui

CHANNEL NUMBER	CHANNEL FREQUENCY (MHz)	RF POWER LEVEL IN 3KHz BW (dBm)	MAXIMUM LIMIT (dBm)	PASS/FAIL
1	2412	-11.39	8	PASS
6	2437	-11.31	8	PASS
11	2462	-11.79	8	PASS



CH1

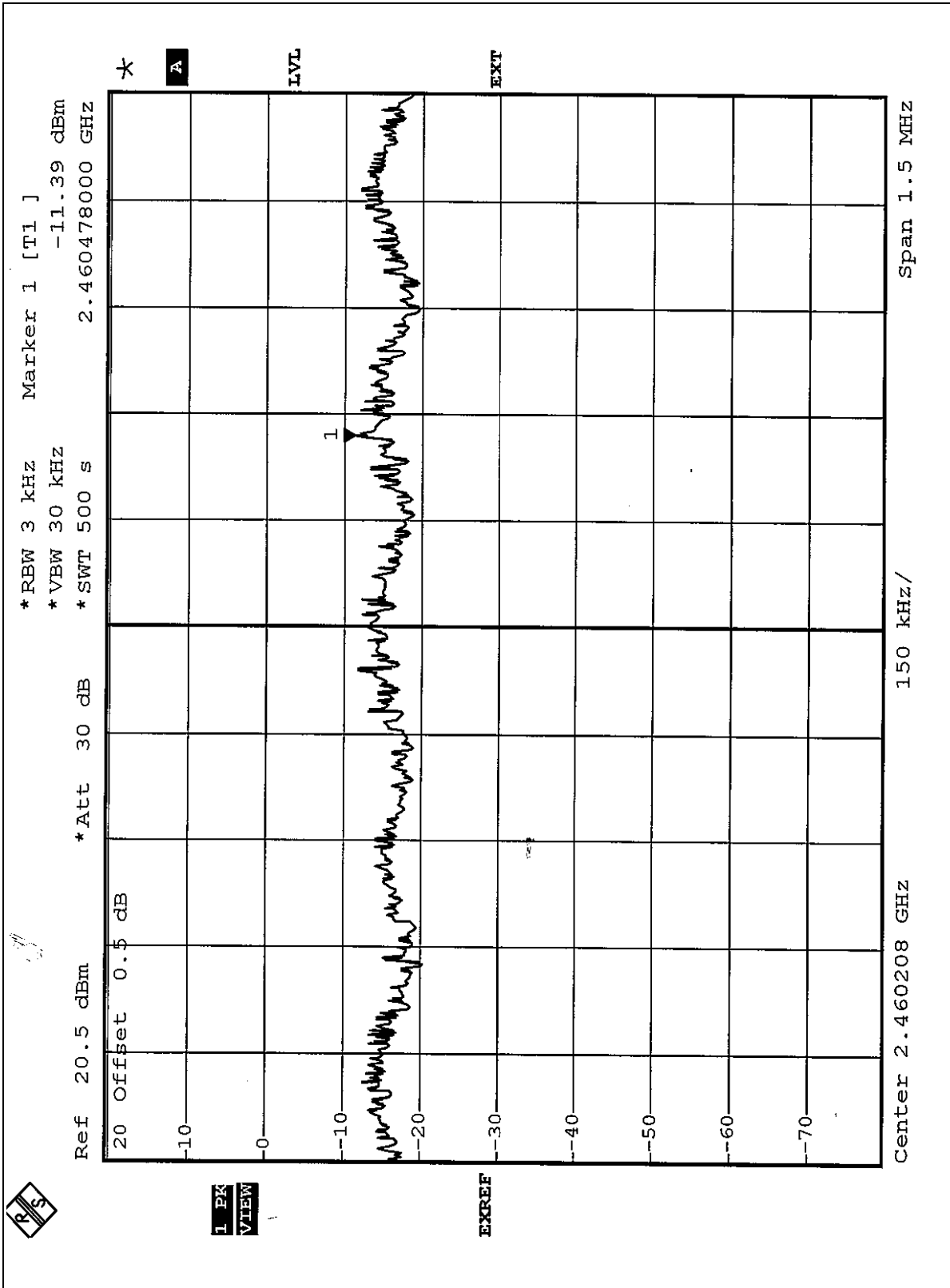



CH6

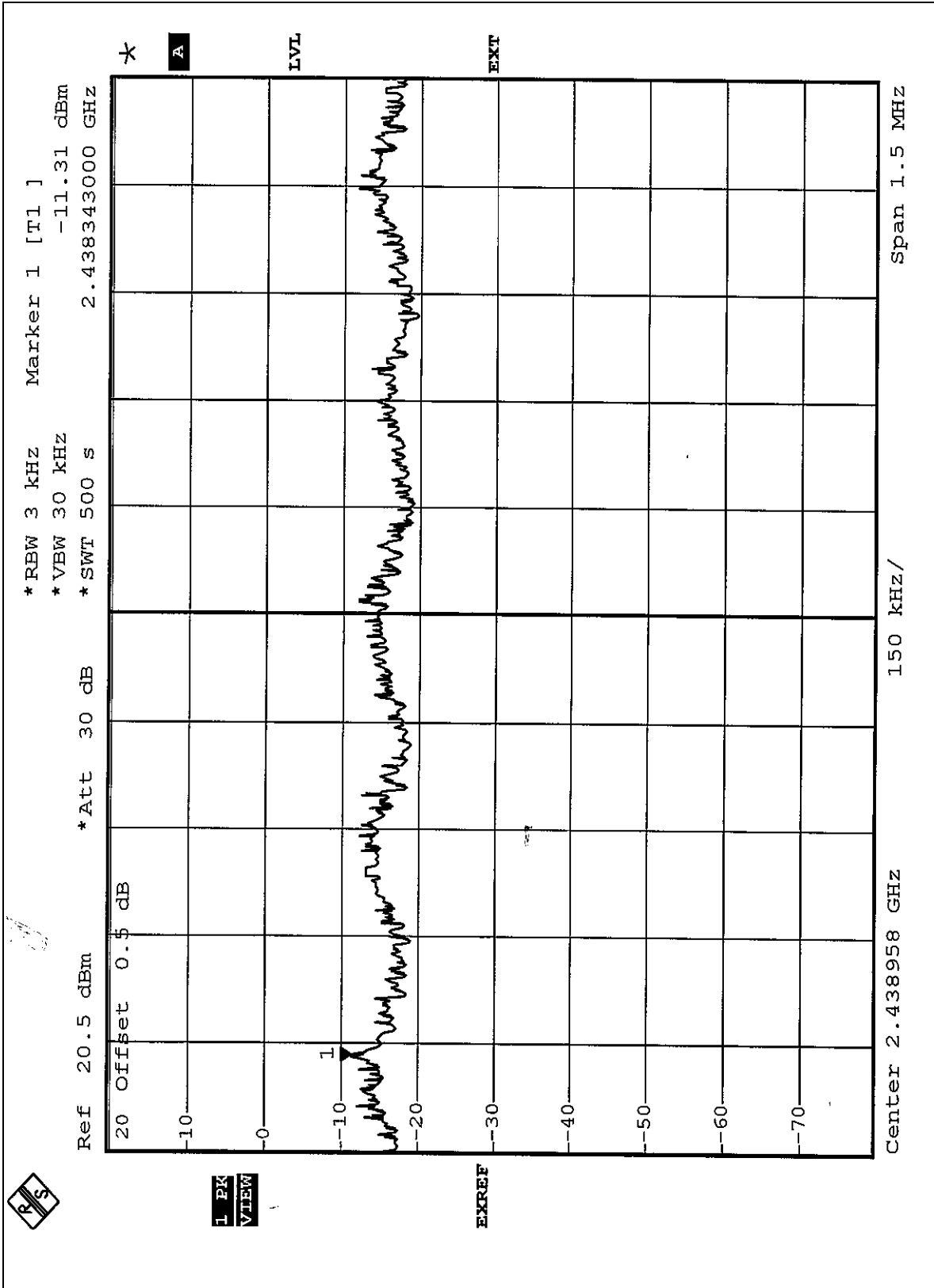



CH11

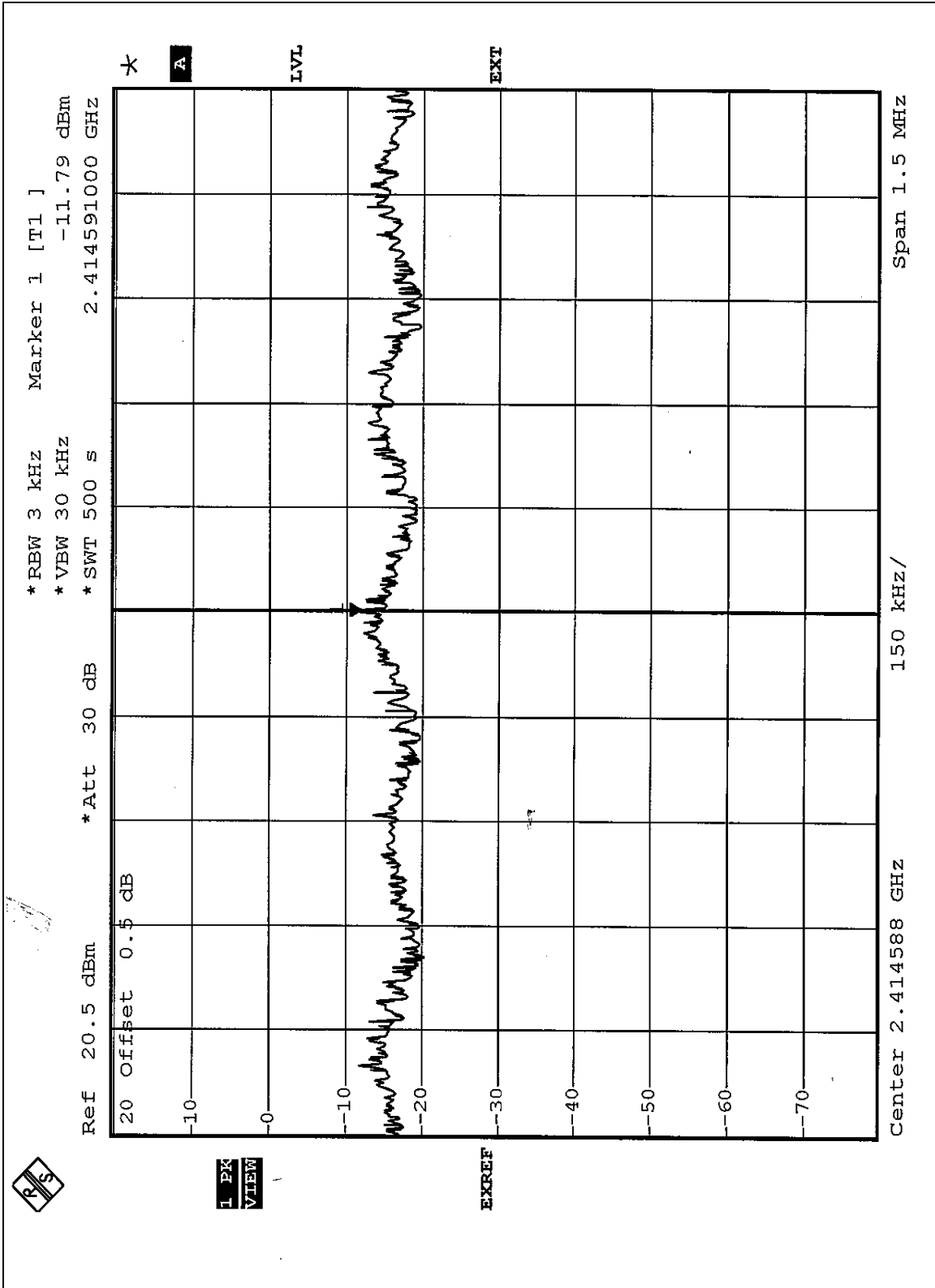



EUT	3Com OfficeConnect Wireless 108Mbps 11g XJACK PC Card	MODEL	3CRXJK10075
INPUT POWER (SYSTEM)	120 Vac, 60 Hz	ENVIRONMENTAL CONDITIONS	24 deg. C, 65% RH, 991 hPa
TEST MODE	C	TESTED BY	Match Tsui

CHANNEL NUMBER	CHANNEL FREQUENCY (MHz)	RF POWER LEVEL IN 3KHz BW (dBm)	MAXIMUM LIMIT (dBm)	PASS/FAIL
6	2437	-14.36	8	PASS



CH6

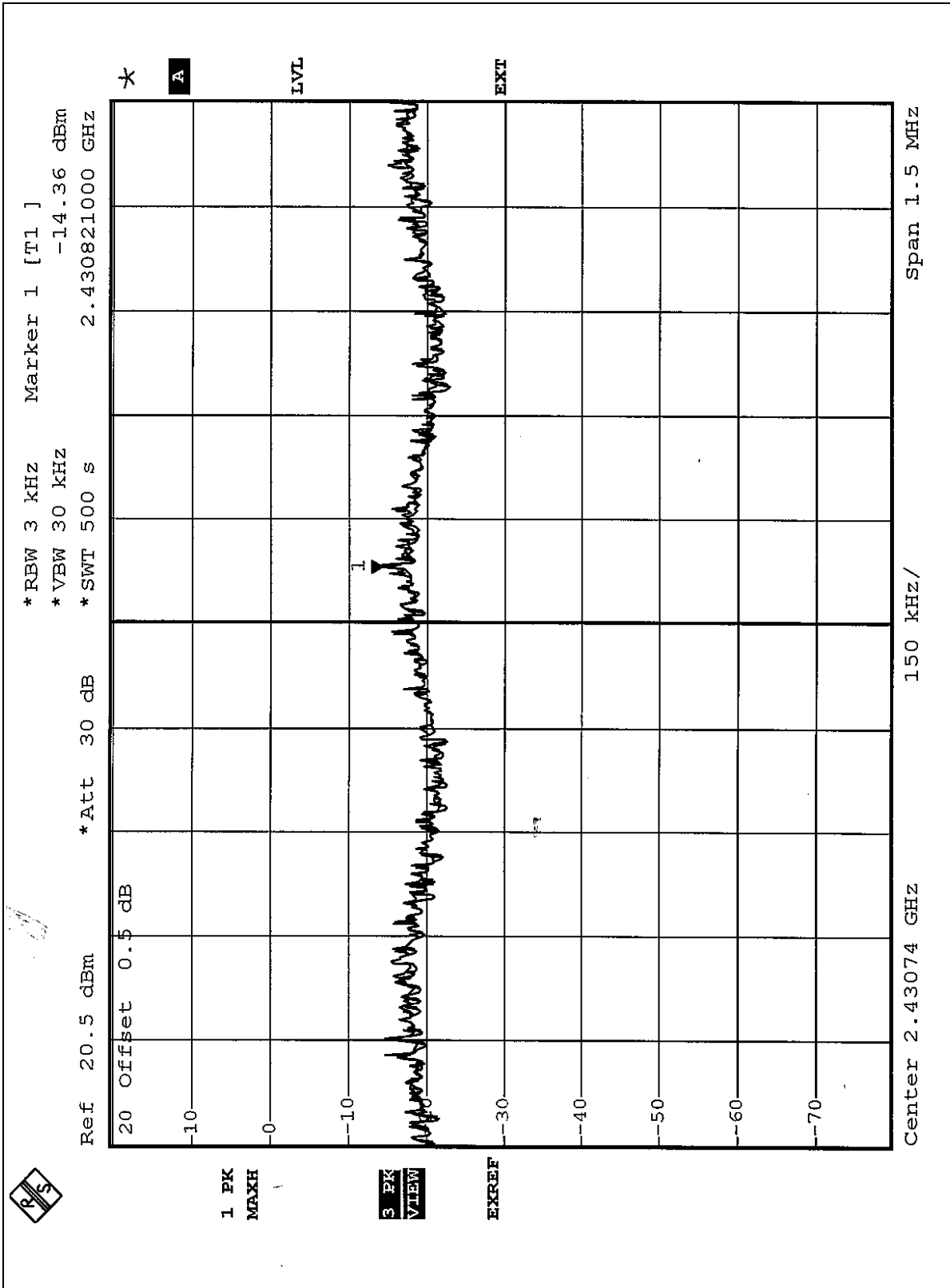



4.6 BAND EDGES MEASUREMENT

4.6.1 LIMITS OF BAND EDGES MEASUREMENT

Below -20dB of the highest emission level of operating band (in 100kHz Resolution Bandwidth).

4.6.2 TEST INSTRUMENTS

Description & Manufacturer	Model No.	Serial No.	Calibrated Until
SPECTRUM ANALYZER	FSEK30	100049	Aug. 11, 2005

NOTE:

The calibration interval of the above test instruments is 12 months and the calibrations are traceable to NML/ROC and NIST/USA.

4.6.3 TEST PROCEDURE

The transmitter output was connected to the spectrum analyzer via a low lose cable. Set both RBW and VBW of spectrum analyzer to 1MHz and 10Hz with suitable frequency span including 100MHz bandwidth from band edge. The band edges was measured and recorded.

4.6.4 DEVIATION FROM TEST STANDARD

No deviation

4.6.5 EUT OPERATING CONDITION

Same as Item 4.3.6



4.6.6 TEST RESULTS

The spectrum plots are attached on the following 12 pages. D2 line indicates the highest level, D1 line indicates the 20dB offset below D2. It shows compliance with the requirement in part 15.247(C).

For test mode A

NOTE:

The band edge emission plot of CCK technique on the following 1~2 pages show 55.43dB delta between carrier maximum power and local maximum emission in restrict band (2.3600GHz). The emission of carrier strength list in the test result of channel 1 at the item 4.2.7 is 104.32dBuV/m, so the maximum field strength in restrict band is $104.32 - 55.43 = 48.89$ dBuV/m which is under 54dBuV/m limit.

The band edge emission plot of CCK technique on the following 3~4 pages show 58.72dB delta between carrier maximum power and local maximum emission in restrict band (2.4876GHz). The emission of carrier strength list in the test result of channel 11 at the item 4.2.7 is 105.36dBuV/m, so the maximum field strength in restrict band is $105.36 - 58.72 = 46.64$ dBuV/m which is under 54dBuV/m limit.

For test mode B

NOTE:

The band edge emission plot of OFDM technique on the following 5~6 pages show 47.34dB delta between carrier maximum power and local maximum emission in restrict band (2.3600GHz). The emission of carrier strength list in the test result of channel 1 at the item 4.2.7 is 100.21dBuV/m, so the maximum field strength in restrict band is $100.21 - 47.51 = 52.87$ dBuV/m which is under 54dBuV/m limit.

The band edge emission plot of OFDM technique on the following 7~8 pages show 47.22dB delta between carrier maximum power and local maximum emission in restrict band (2.4835GHz). The emission of carrier strength list in the test result of channel 11 at the item 4.2.7 is 100.01dBuV/m, so the maximum field strength in restrict band is $100.01 - 47.22 = 52.79$ dBuV/m which is under 54dBuV/m limit.



For test mode C

NOTE:

The band edge emission plot of OFDM technique on the following 9~10 pages show 45.00dB delta between carrier maximum power and local maximum emission in restrict band (2.3600GHz). The emission of carrier strength list in the test result of channel 1 at the item 4.2.7 is 97.93dBuV/m, so the maximum field strength in restrict band is $97.93-45.00=52.93$ dBuV/m which is under 54dBuV/m limit.

The band edge emission plot of OFDM technique on the following 11~12 pages show 48.81dB delta between carrier maximum power and local maximum emission in restrict band (2.4835GHz). The emission of carrier strength list in the test result of channel 11 at the item 4.2.7 is 97.93dBuV/m, so the maximum field strength in restrict band is $97.93-48.81=49.12$ dBuV/m which is under 54dBuV/m limit.



(For test mode A)

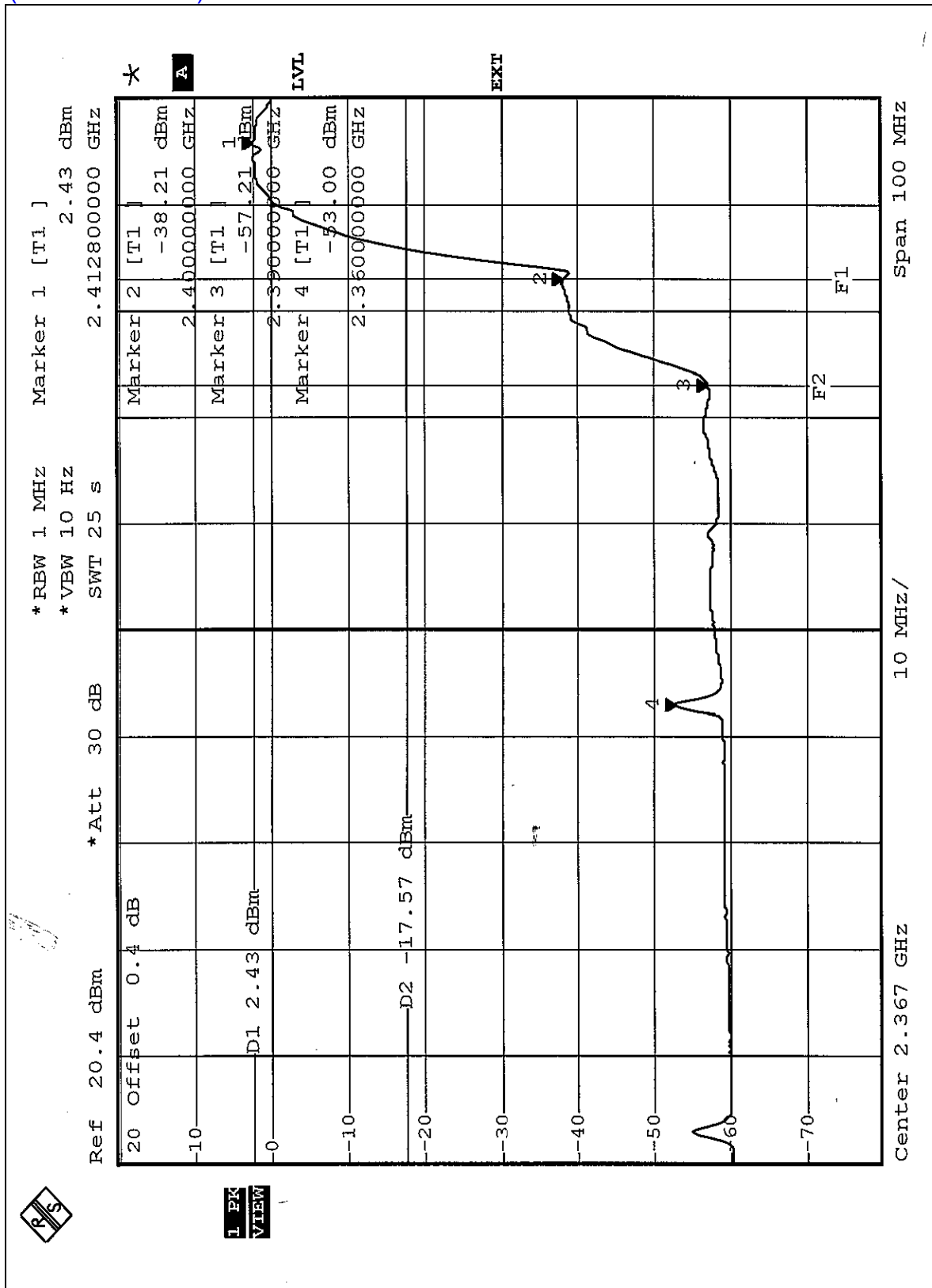

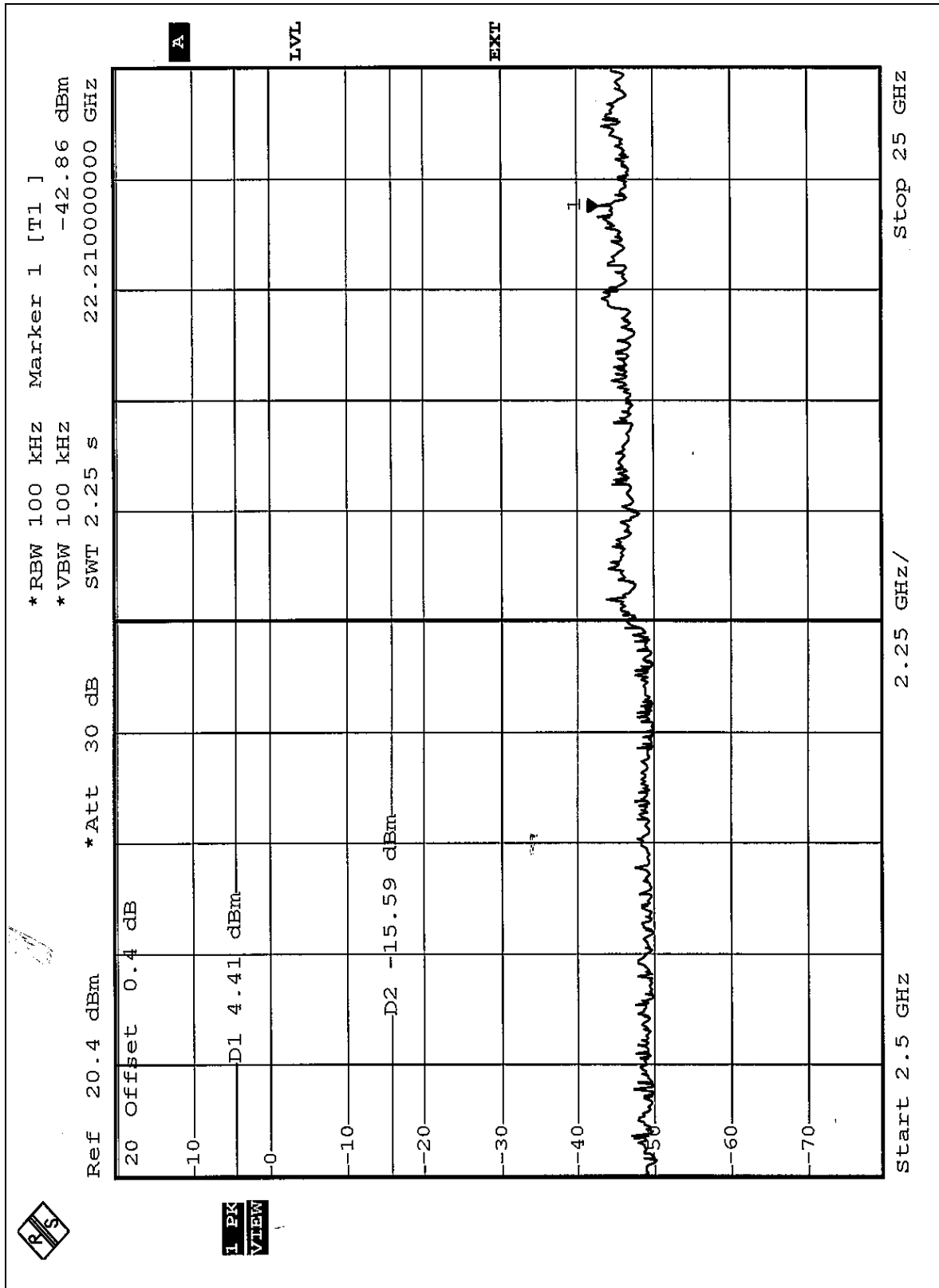

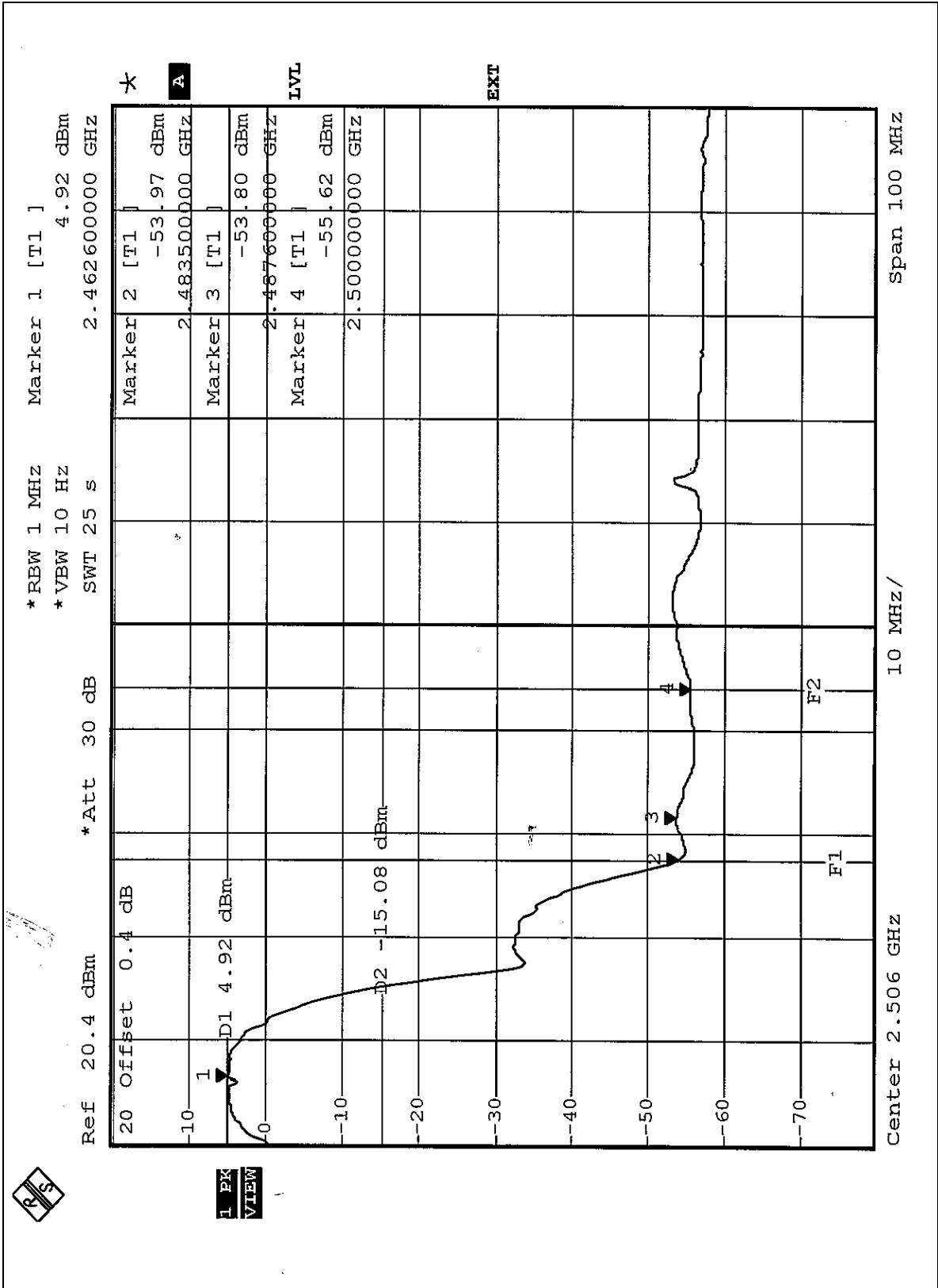

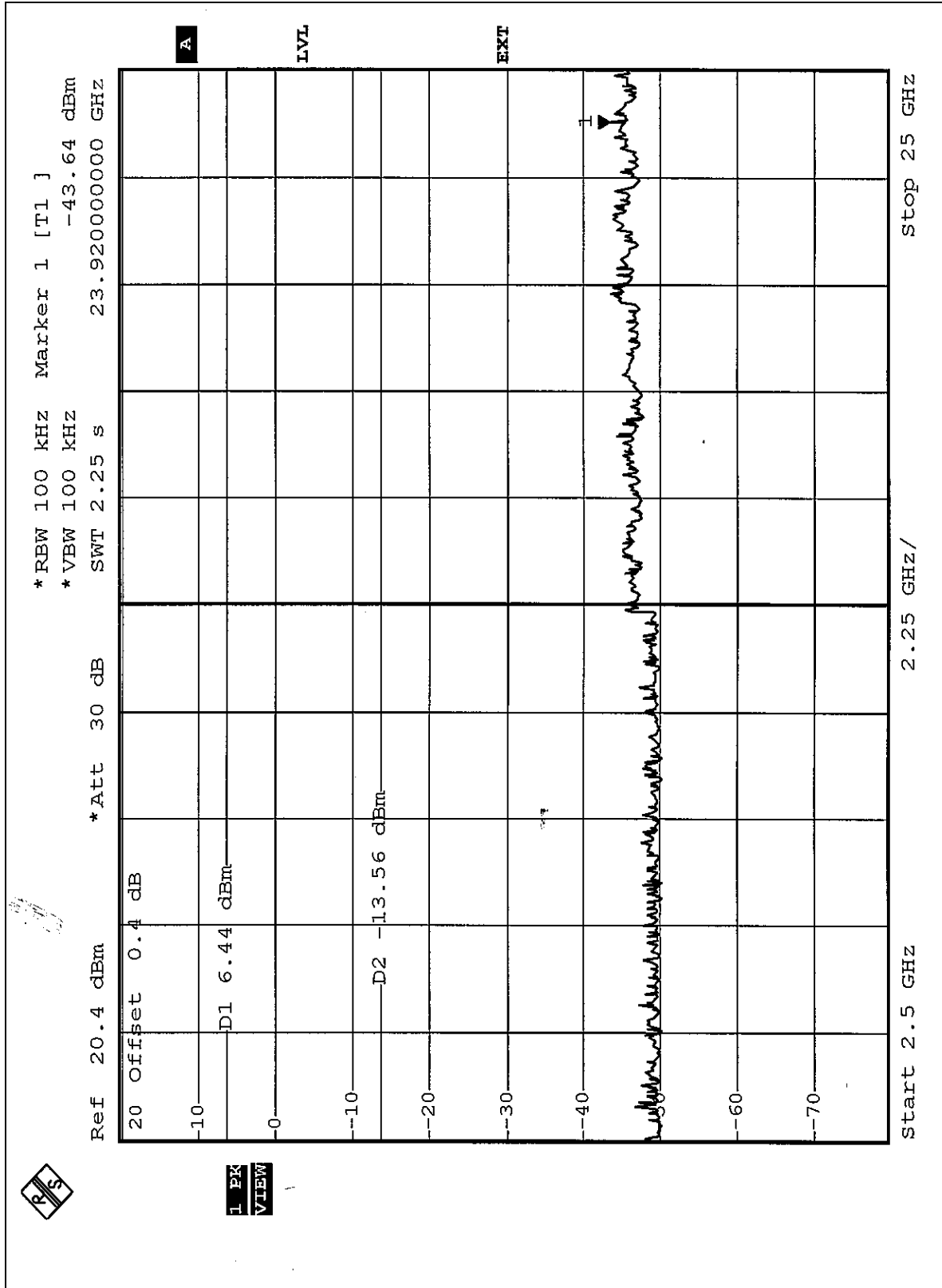



(For test mode B)

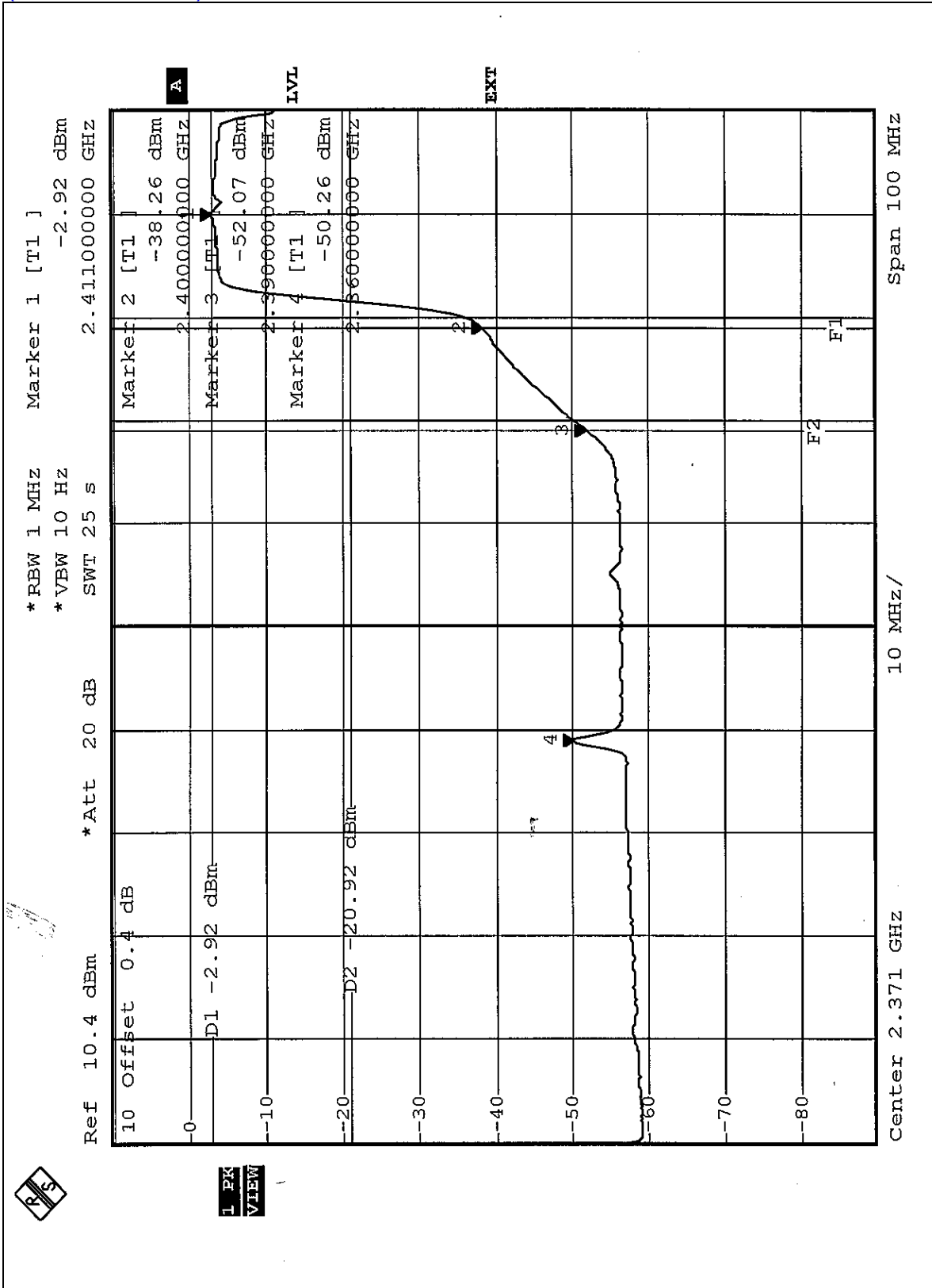

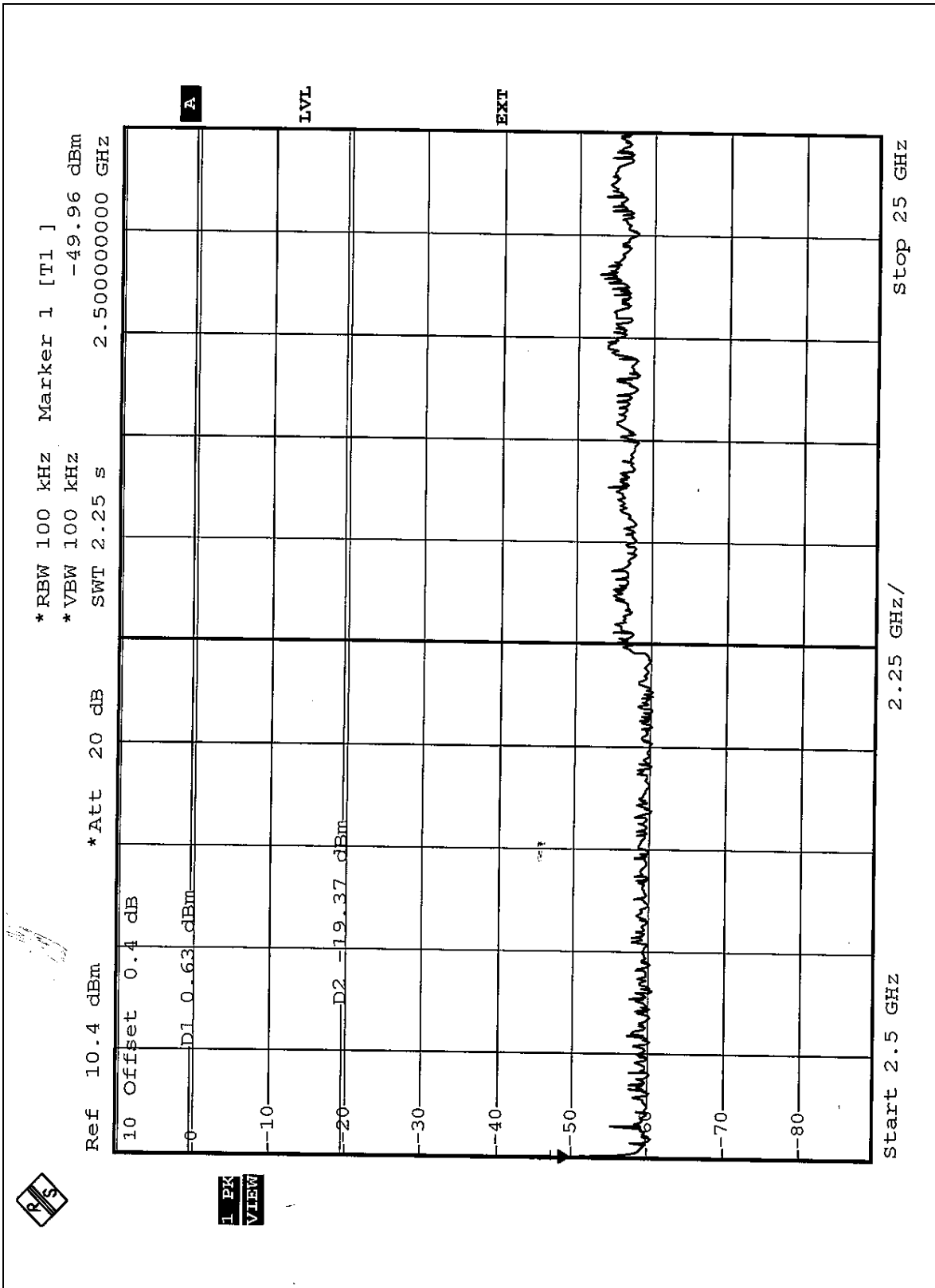

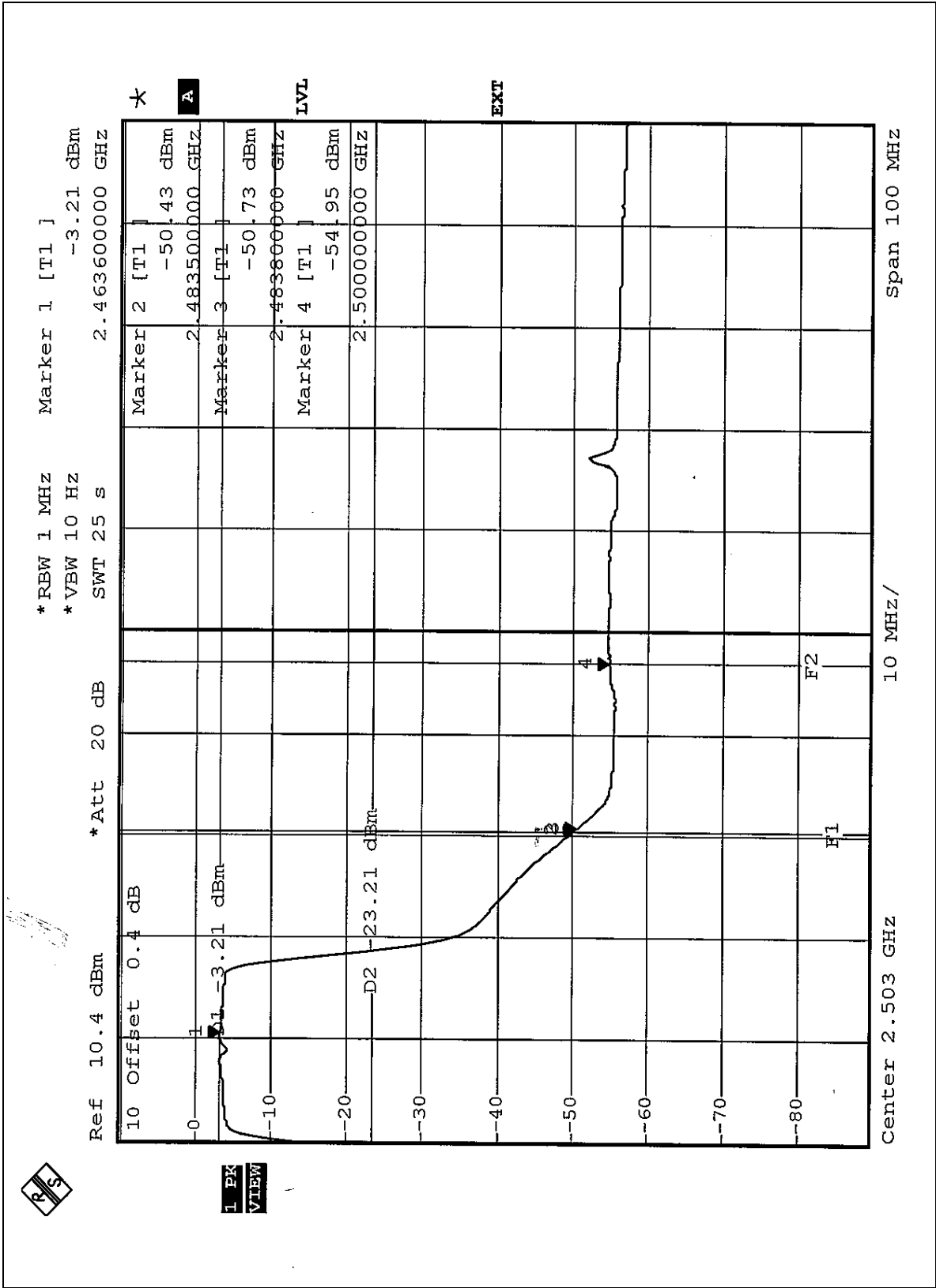

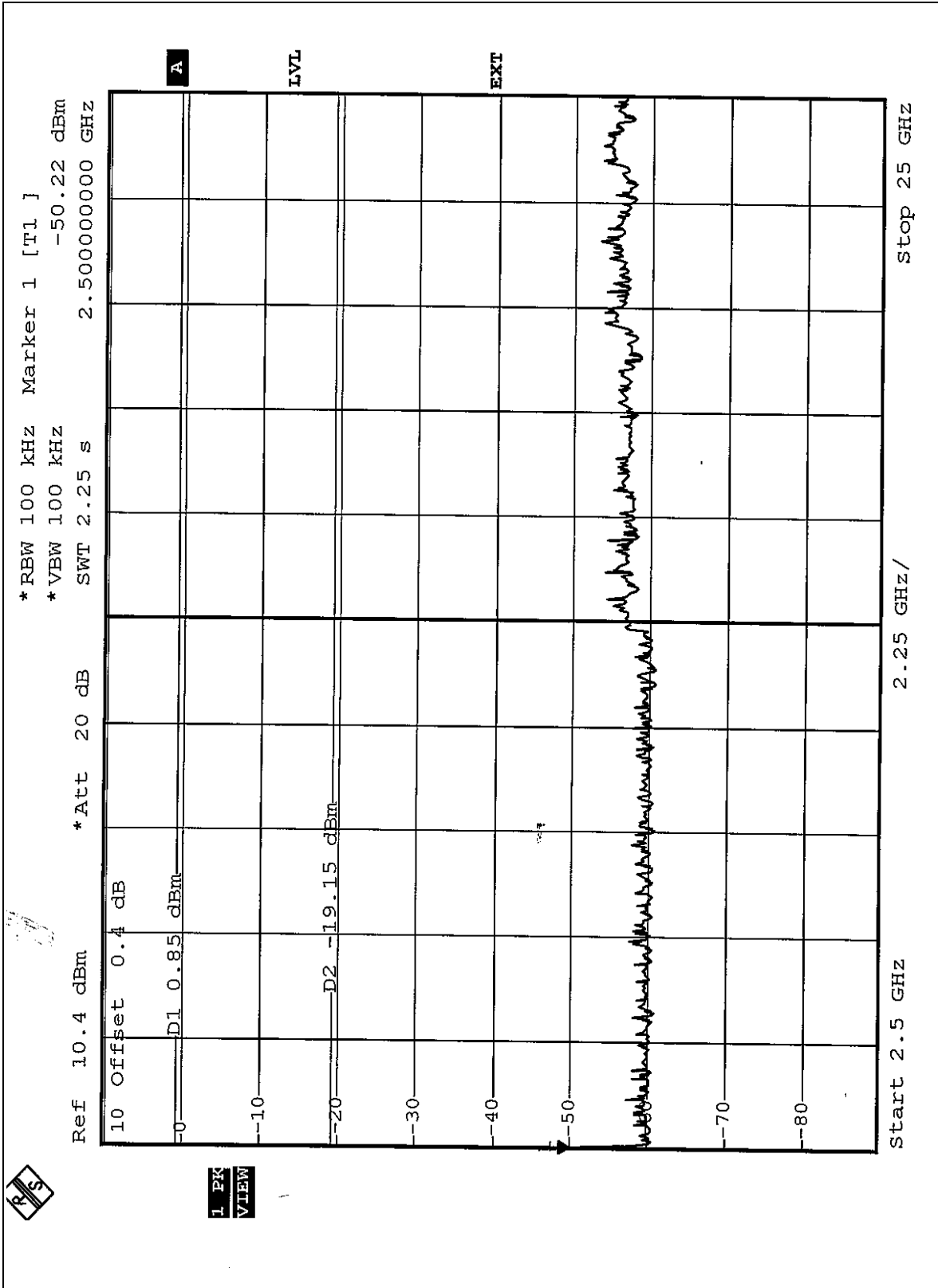



(For test mode C)

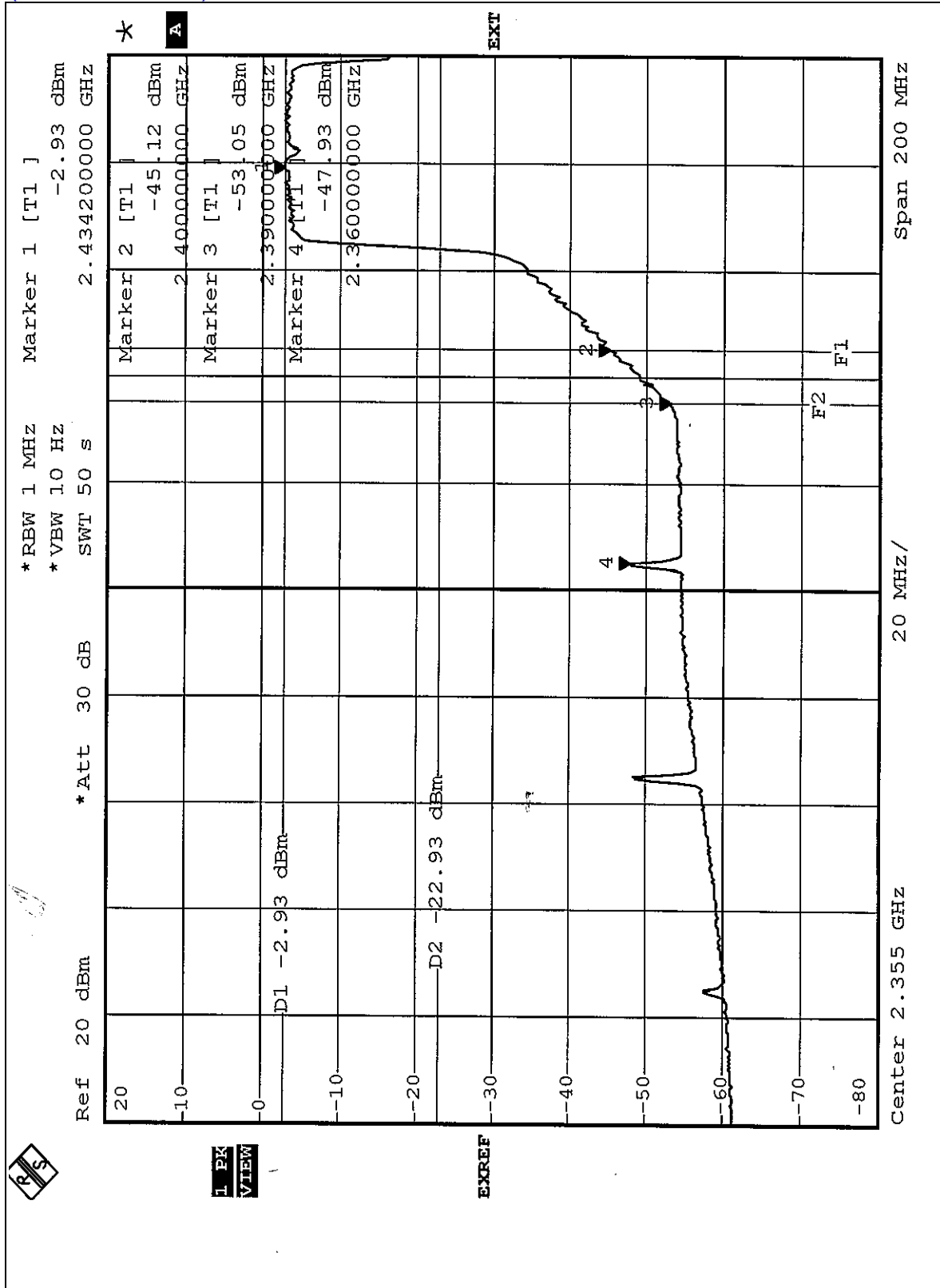

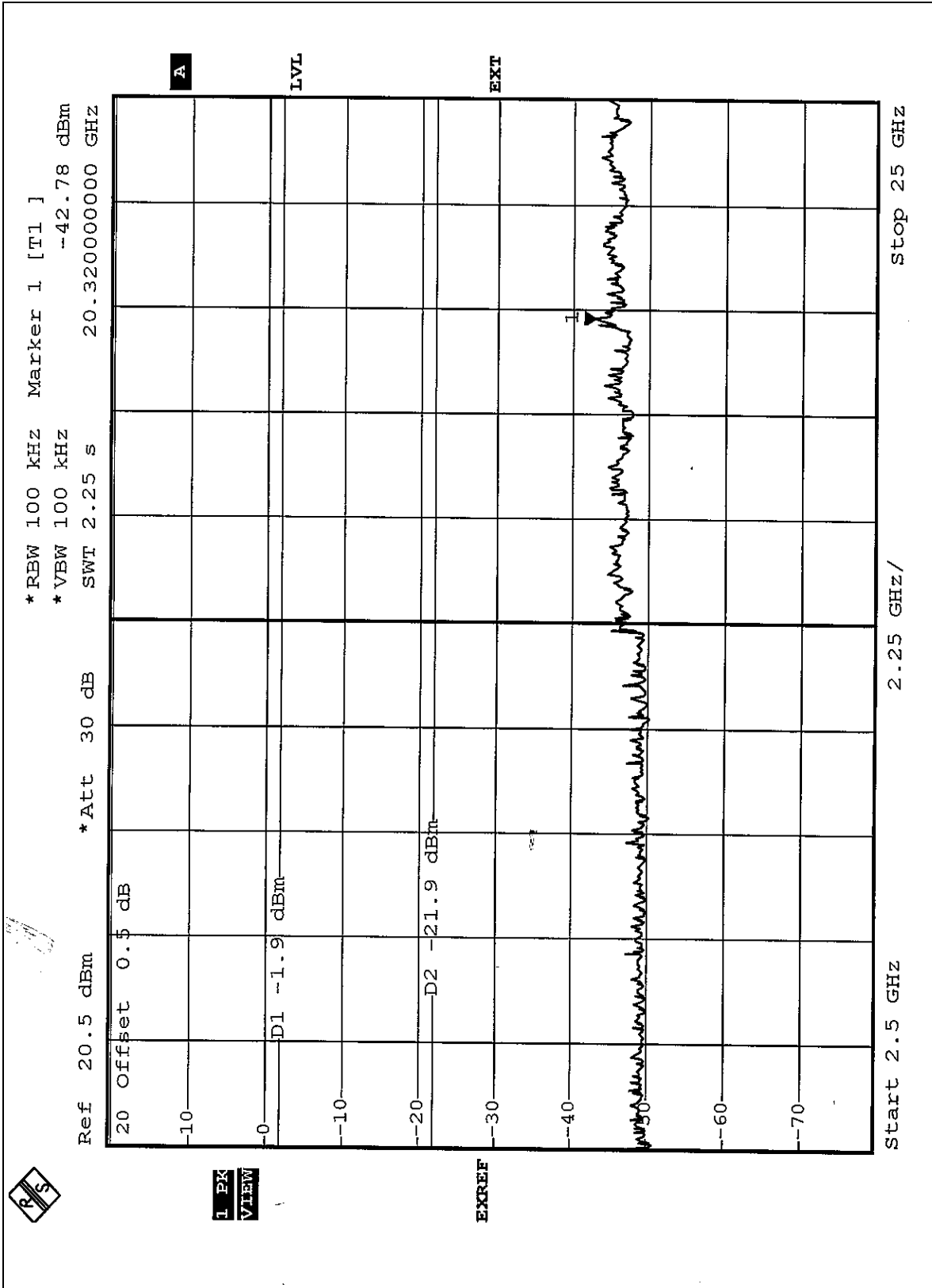

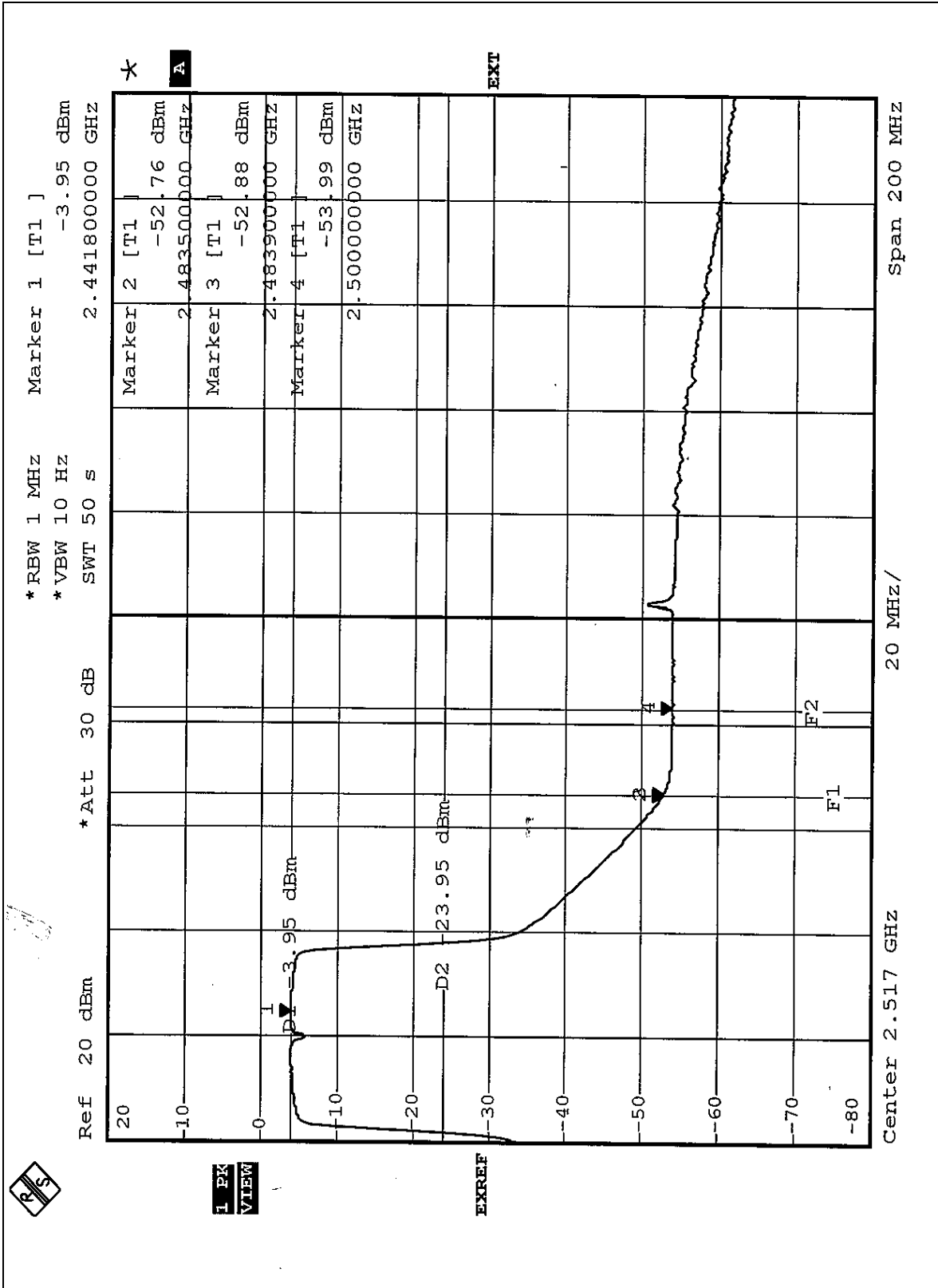

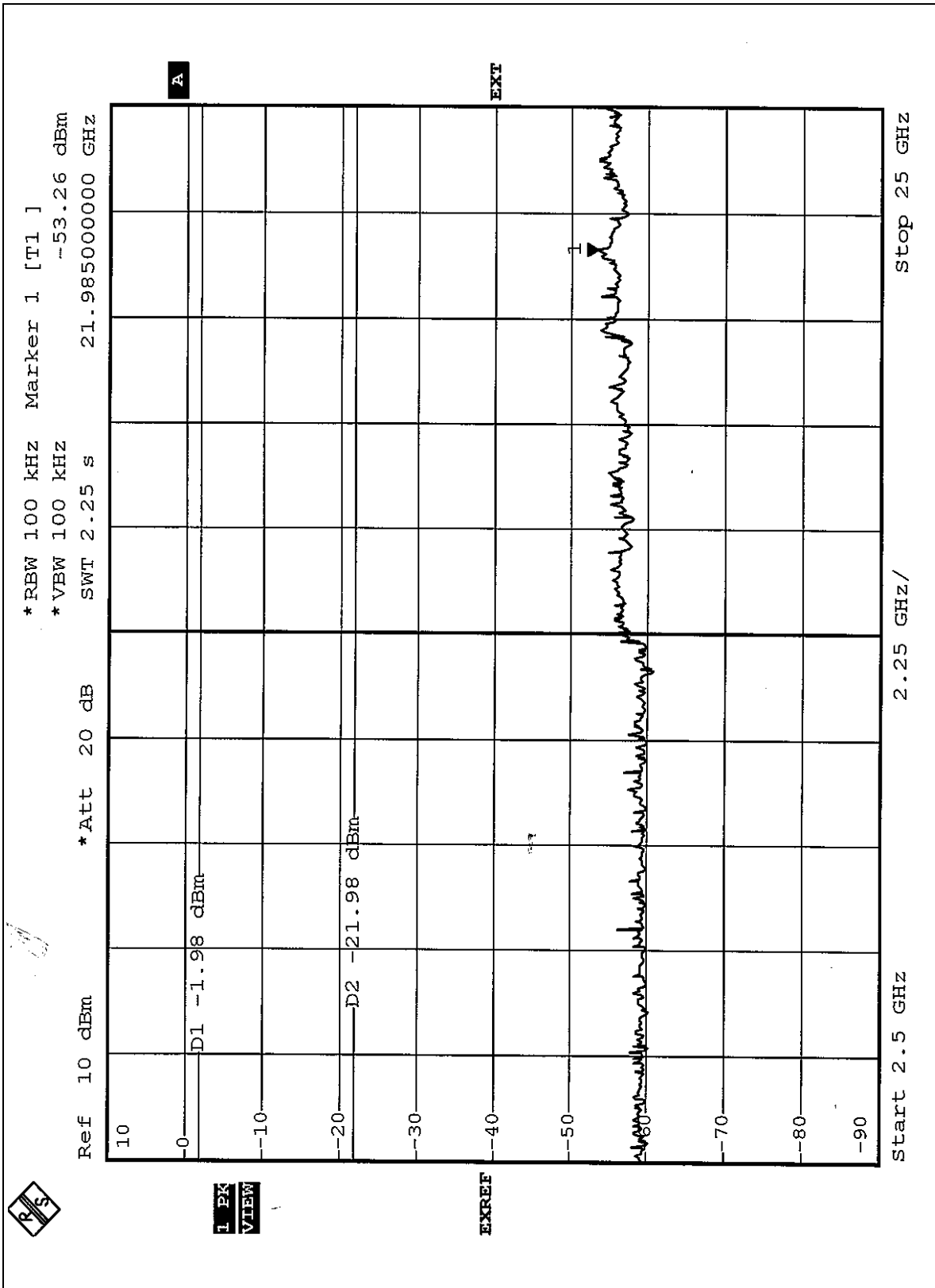



4.7 ANTENNA REQUIREMENT

4.7.1 STANDARD APPLICABLE

For intentional device, according to FCC 47 CFR Section 15.203, an intentional radiator shall be designed to ensure that no antenna other than that furnished by the responsible party shall be used with the device.

And according to FCC 47 CFR Section 15.247 (b), if transmitting antennas of directional gain greater than 6dBi are used, the power shall be reduced by the amount in dB that the directional gain of the antenna exceeds 6dBi.

4.7.2 ANTENNA CONNECTED CONSTRUCTION

The antenna used in this product is monopole antenna without connector. And the maximum Gain of this antenna is 1.5dBi.

5 PHOTOGRAPHS OF THE TEST CONFIGURATION CONDUCTED EMISSION TEST



RADIATED EMISSION TEST





6 INFORMATION ON THE TESTING LABORATORIES

We, ADT Corp., were founded in 1988 to provide our best service in EMC, Radio, Telecom and Safety consultation. Our laboratories are accredited and approved by the following approval agencies according to ISO/IEC 17025, Guide 25 or EN 45001:

USA	FCC, NVLAP, UL
Germany	TUV Rheinland
Japan	VCCI
Norway	NEMKO
Canada	INDUSTRY CANADA , CSA
R.O.C.	CNLA, BSMI, DGT
Netherlands	Telefication
Singapore	PSB , GOST-ASIA(MOU)
Russia	CERTIS(MOU)

Copies of accreditation certificates of our laboratories obtained from approval agencies can be downloaded from our web site:

www.adt.com.tw/index.5/phtml. If you have any comments, please feel free to contact us at the following:

Linko EMC/RF Lab:

Tel: 886-2-26052180
Fax: 886-2-26052943

Hsin Chu EMC/RF Lab:

Tel: 886-3-5935343
Fax: 886-3-5935342

Hwa Ya EMC/RF/Safety/Telecom Lab:

Tel: 886-3-3183232
Fax: 886-3-3185050

Linko RF Lab.

Tel: 886-3-3270910
Fax: 886-3-3270892

Email: service@mail.adt.com.tw

Web Site: www.adt.com.tw

The address and road map of all our labs can be found in our web site also.

Report Format Version 1.3