

FCC Test Report

FCC ID : MXF-WRTD303NMU736
Equipment : HSPA+ Module
Model No. : MU736
Brand Name : Gemtek
Applicant : Gemtek Technology Co., Ltd.
Address : No.15-1 Zhonghua Road, Hsinchu Industrial
Park, Hukou, Hsinchu, Taiwan, 30352
Standard : 47 CFR FCC Part 22 Subpart H
Received Date : Oct. 23, 2014
Tested Date : Oct. 28 ~ Nov. 19, 2014

We, International Certification Corp., would like to declare that the tested sample has been evaluated and in compliance with the requirement of the above standards. The test results contained in this report refer exclusively to the product. It may be duplicated completely for legal use with the approval of the applicant. It shall not be reproduced except in full without the written approval of our laboratory.

Approved & Reviewed by:

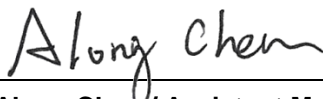

Along Chen / Assistant Manager



Table of Contents

1	GENERAL DESCRIPTION	5
1.1	Information.....	5
1.2	Local Support Equipment List	7
1.3	Test Setup Chart	7
1.4	The Equipment List	8
1.5	Test Standards	9
1.6	Measurement Uncertainty	9
2	TEST CONFIGURATION	10
2.1	Testing Condition and Location Information.....	10
2.2	The Worst Test Modes and Channel Details	10
3	TEST RESULTS.....	11
3.1	Effective Radiated Power	11
3.2	Radiated Emissions.....	13
3.3	Conducted Emissions.....	17
3.4	Band Edge.....	19
3.5	Occupied and 26 dB Bandwidth	21
3.6	Peak to Average Ratio	23
3.7	Frequency Stability.....	25
4	TEST LABORATORY INFORMATION	27

Release Record

Report No.	Version	Description	Issued Date
FG4O2301P22	Rev. 01	Initial issue	Dec. 12, 2014

Summary of Test Results

FCC Rules	Test Items	Measured	Result
2.1046 / 22.913(a)(2)	Effective Radiated Power	Power[dBm] :23.28	Pass
2.1053 / 22.917(a)	Radiated Emissions	Meet the requirement of limit	Pass
2.1051 / 22.917(a)	Conducted Emissions	Meet the requirement of limit	Pass
2.1051 / 22.917(a)	Band Edge	Meet the requirement of limit	Pass
2.1049 / 22.917(a)	Occupied Bandwidth	Meet the requirement of limit	Pass
-	Peak to average ratio	Meet the requirement of limit	Pass
2.1055 / 22.355	Frequency Stability	Meet the requirement of limit	Pass

1 General Description

1.1 Information

1.1.1 Specification of the Equipment under Test (EUT)

Operating band (MHz)	WCDMA Band V: 826.4~846.6
Modulation	WCDMA / HSDPA / HSUPA Uplink: QPSK Downlink: QPSK , 16QAM , 64QAM
3GPP Release Version	R7
H/W Version	V03
S/W Version	1.1.0

Note: The module is certified as limited module that is limited to specific host (refer to section 1.1.2).

1.1.2 Specific platform Information

Brand Name	Model Name	Product Name	FCC ID
Gemtek	WRD-303N	Easy Connect	MXF-WRDT303N

Accessories for Platform		
No.	Equipment	Description
1	AC Adapter 1	Brand Name: AOEM Model Name: ADS0248-W 120200 Power Rating: I/P: 100-240Vac, 50-60Hz, 0.6A O/P: 12Vdc, 2A Power Line: 120cm non-shielded cable with one core
2	AC Adapter 2	Brand Name: APD Model Name: WA-24Q12FU Power Rating: I/P: 100-240Vac, 50-60Hz, 0.6A O/P: 12Vdc, 2A Power Line: 1.8m non-shielded cable with one core
3	AC Adapter 3	Brand Name: MOSO Model Name: MSP-C2000IC12.0-24W-US Power Rating: I/P: 100-240Vac, 50-60Hz, 0.8A O/P: 12Vdc, 2A Power Line: 1.4m non-shielded cable with one core
4	WTE Battery	Model: 303N Rating: 7.4Vdc, 4050mAh (29.97Wh)
5	MAXELL Battery	button cell battery Model: ML2032 Rating: 3Vdc
6	built-in HDD	Brand: TOSHIBA Model: MQ01ABF050 Capacity: 500GB

1.1.3 Maximum ERP, Frequency Tolerance and Emission Designator

System	Modulation	Maximum ERP(W)	Frequency Tolerance (ppm)	Emission Designator
WCDMA 850	QPSK	0.213	0.087	4M08F9W

1.1.4 Antenna Details

Ant. No.	Type	Gain (dBi)	Connector	Remark
1	PIFA	1.25	IPEX	---

1.1.5 EUT and Host Operational Condition

EUT

Supply Voltage	3.3 Vdc from host		
Operational Climatic	<input checked="" type="checkbox"/> Tnom (20°C)	<input checked="" type="checkbox"/> Tmax (50°C)	<input checked="" type="checkbox"/> Tmin (-30°C)

Host

Operational Voltage	<input checked="" type="checkbox"/> Vnom (7.4 Vdc)	<input checked="" type="checkbox"/> Vmax (8.36 Vdc)	<input checked="" type="checkbox"/> Vmin (6.84 Vdc)
----------------------------	--	---	---

1.1.6 Operating Channel List

WCDMA BAND V		
Channel Location	Channel	Frequency (MHz)
Low	4132	826.4
Middle	4182	836.4
High	4233	846.6

1.2 Local Support Equipment List

Support Equipment List						
No.	Equipment	Brand	Model	S/N	FCC ID	Signal cable / Length (m)
1	Notebook	DELL	Latitude E6430	J5GB4X1	DoC	RJ45, 8m non-shielded.
2	USB Flash	Kingston	DTSE9	WX9Q6	---	---

1.3 Test Setup Chart

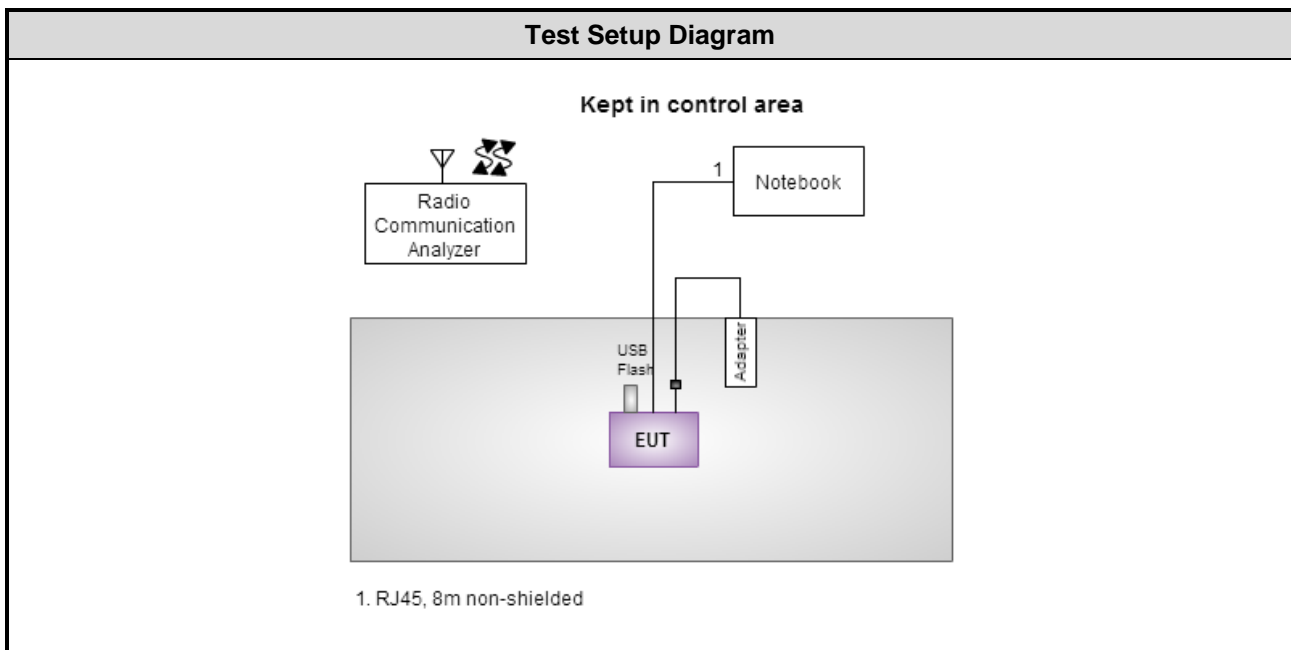

Note: The module is certified as limited module that is limited to specific host (refer to section 1.1.2). Thus, test configuration is combined with host not stand-alone.

1.4 The Equipment List

Test Item	RF Conducted				
Test Site	(TH01-WS)				
Instrument	Manufacturer	Model No.	Serial No.	Calibration Date	Calibration Until
Spectrum Analyzer	R&S	FSV40	101063	Feb. 17, 2014	Feb. 16, 2015
TEMP&HUMIDITY CHAMBER	GIANT FORCE	GCT-225-40-SP-SD	MAF1212-002	Dec. 11, 2013	Dec. 10, 2014
Power Meter	Anritsu	ML2495A	1241002	Sep. 29, 2014	Sep. 28, 2015
Power Sensor	Anritsu	MA2411B	1207366	Sep. 29, 2014	Sep. 28, 2015
Radio Communication Analyzer	Anritsu	MT8820C	6201240341	Mar. 18, 2014	Mar. 17, 2015
Measurement Software	Sporton	Sporton_1	1.3.30	NA	NA

Note: Calibration Interval of instruments listed above is one year.

Test Item	Radiated Emission				
Test Site	966 chamber1 / (03CH01-WS)				
Instrument	Manufacturer	Model No.	Serial No.	Calibration Date	Calibration Until
Spectrum Analyzer	R&S	FSV40	101498	Jan. 25, 2014	Jan. 24, 2015
Receiver	R&S	ESR3	101657	Jan. 18, 2014	Jan. 17, 2015
Bilog Antenna	SCHWARZBECK	VULB9168	VULB9168-522	Sep. 05, 2014	Sep. 04, 2015
Horn Antenna 1G-18G	SCHWARZBECK	BBHA 9120 D	BBHA 9120 D 1096	Feb. 13, 2014	Feb. 12, 2015
Horn Antenna 18G-40G	SCHWARZBECK	BBHA 9170	BBHA9170154	Jan. 10, 2014	Jan. 09, 2015
Preamplifier	Burgeon	BPA-530	SN:100219	Sep. 09, 2014	Sep. 08, 2015
Preamplifier	Agilent	83017A	MY39501308	Oct. 09, 2014	Oct. 08, 2015
Preamplifier	EMC	EMC184045B	980192	Aug. 26, 2014	Aug. 25, 2015
RF Cable	HUBER+SUHNER	SUCOFLEX104	MY16014/4	Dec. 16, 2013	Dec. 15, 2014
RF Cable	HUBER+SUHNER	SUCOFLEX104	MY16019/4	Dec. 16, 2013	Dec. 15, 2014
RF Cable	HUBER+SUHNER	SUCOFLEX104	MY16139/4	Dec. 16, 2013	Dec. 15, 2014
LF cable 3M	Woken	CFD400NL-LW	CFD400NL-001	Dec. 16, 2013	Dec. 15, 2014
Radio Communication Analyzer	Anritsu	MT8820C	6201240341	Mar. 18, 2014	Mar. 17, 2015
LF cable 10M	Woken	CFD400NL-LW	CFD400NL-002	Dec. 16, 2013	Dec. 15, 2014
Measurement Software	AUDIX	e3	6.120210g	NA	NA

Note: Calibration Interval of instruments listed above is one year.

Loop Antenna	TESEQ	HLA 6120	31244	Dec. 02, 2012	Dec. 01, 2014
--------------	-------	----------	-------	---------------	---------------

Note: Calibration Interval of instruments listed above is two year.

1.5 Test Standards

According to the specification of EUT, the EUT must comply with following standards.

47 CFR FCC Part 22 Subpart H

ANSI C63.4-2003

ANSI / TIA / EIA-603-C -2004

FCC KDB 971168 D01 Power Meas License Digital Systems v02r02

FCC KDB 412172 D01 Determining ERP and EIRP v01

1.6 Measurement Uncertainty

ISO/IEC 17025 requires that an estimate of the measurement uncertainties associated with the emissions test results be included in the report. The measurement uncertainties given below are based on a 95% confidence level (based on a coverage factor (k=2)).

Measurement Uncertainty	
Parameters	Uncertainty
Bandwidth	±34.134 Hz
Conducted power	±0.808 dB
Frequency error	±34.134 Hz
Temperature	±0.6 °C
Conducted emission	±2.670 dB
AC conducted emission	±2.92 dB
Radiated emission ≤ 1GHz	±3.26 dB
Radiated emission > 1GHz	±4.94 dB

2 Test Configuration

2.1 Testing Condition and Location Information

Test Item	Test Site	Ambient Condition	Tested By
RF conducted	TH01-WS	23°C / 61%	Felix Sung
Radiated Emissions	03CH01-WS	22°C / 69%	Anderson Hung

➤ FCC site registration No.: 657002

➤ IC site registration No.: 10807A-1

2.2 The Worst Test Modes and Channel Details

Test item	Mode	Test channel
Effective Radiated Power	WCDMA Band V	4132, 4182, 4233
Radiated Emissions ≤ 1GHz	WCDMA Band V	4132
Radiated Emissions > 1GHz	WCDMA Band V	4132, 4182, 4233
Conducted Emissions	WCDMA Band V	4132, 4182, 4233
Band Edge	WCDMA Band V	4132, 4233
Occupied Bandwidth	WCDMA Band V	4132, 4182, 4233
Peak to average ratio	WCDMA Band V	4132, 4182, 4233
Frequency Stability	WCDMA Band V	4182

Note:

1. The EUT was pretested with 3 orientations placed on the table for the radiated emission measurement – X, Y, and Z-plane. The **X-plane** results were found as the worst case and were shown in this report.
2. Adapter 1, Adapter 2 and Adapter 3 had been pretested and found that **Adapter 1** was the worst case and was selected for final testing (Adapter 1: AOEM adapter; Adapter 2: APD adapter; Adapter 3: MOSO adapter).

3 Test Results

3.1 Effective Radiated Power

3.1.1 Limit of Effective Radiated Power

The ERP of mobile transmitters and auxiliary test transmitters must not exceed 7 Watts.

3.1.2 Test Procedures

For Conducted power measurement

1. The EUT links up with simulator and is set to maximum output power level at low / middle / high channel.
2. Measure the output power of low / middle / high channel of the EUT

For ERP measurement

EPR can be calculated by below formula from KDB 412172 D01

1. $ERP = EIRP - 2.15 \text{ dB}$.

2. $EIRP = P_T + G_T - L_C$

P_T = transmitter output power, in dBm

G_T = gain of the transmitting antenna, in dBi (EIRP)

L_C = signal attenuation in the connecting cable between the transmitter and antenna, in dB.

3.1.3 Test Setup

Conducted Power Measurement

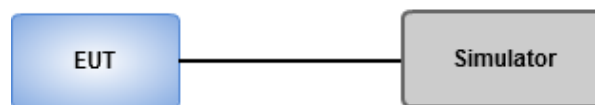

3.1.4 Test Result of Conducted Output Power (dBm)

Band	WCDMA BAND V		
Channel	4132	4182	4233
Frequency (MHz)	826.4	836.4	846.6
RMC 12.2K	24.18	23.83	23.62
HSDPA Subtest-1	23.21	22.70	21.74
HSDPA Subtest-2	22.22	21.64	20.77
HSDPA Subtest-3	21.98	21.39	20.52
HSDPA Subtest-4	21.73	21.15	20.27
HSUPA Subtest-1	22.28	21.70	20.80
HSUPA Subtest-2	20.26	19.73	18.79
HSUPA Subtest-3	20.98	20.45	19.55
HSUPA Subtest-4	20.41	19.91	19.02
HSUPA Subtest-5	22.47	21.41	20.51

3.1.5 Test Result of Effective Radiated Power (dBm)

Mode	WCDMA Band V						
Channel	Frequency (MHz)	Conducted Output Power (dBm)	Max Antenna Gain (dBi)	EIRP (dBm)	ERP (dBm)	ERP (W)	Limit (W)
4132	826.4	24.18	1.25	25.43	23.28	0.213	7
4182	836.4	23.83	1.25	25.08	22.93	0.196	7
4233	846.6	23.62	1.25	24.87	22.72	0.187	7

3.2 Radiated Emissions

3.2.1 Limit of Radiated Emissions

The power of any emission outside of the authorized operating frequency ranges must be attenuated below the transmitting power (P) by a factor of at least $43 + 10 \log(P)$ dB equal to -13dBm.

3.2.2 Test Procedures

1. Measurement is made at a semi-anechoic chamber that incorporates a turntable allowing a EUT rotation of 360°. A continuously-rotating, remotely-controlled turntable is installed at the test site to support the EUT and facilitate determination of the direction of maximum radiation for each EUT emission frequency. The EUT is placed at a height of 0.8 m test table above the ground plane.
2. Measurement is made with the antenna positioned in both the horizontal and vertical planes of polarization. The measurement antenna is varied in height (1m ~ 4m) above the reference ground plane to obtain the maximum signal strength. Distance between EUT and antenna is 3 m.
3. This investigation is performed with the EUT rotated 360°, the antenna height scanned between 1 m and 4 m, and the antenna rotated to repeat the measurements for both the horizontal and vertical antenna polarizations.
4. After finding the max radiated emission, substitution method will be used for getting effective radiated power. EUT will be removed and substitution antenna will be placed at same position. Signal generator will output CW signal to substitution antenna through a RF cable. Rotate turntable and move antenna to find maximum radiated emission. Adjust output power of signal generator to let the maximum radiated emission is same as step 3. Record the output power level.
5. E.I.R.P = output power of step 4 + gain of substitution antenna – cable loss of RF cable. ERP can be calculated by below formula:
$$E.R.P = E.I.R.P - 2.15dB$$

3.2.3 Test Setup

Radiated Emissions below 1 GHz

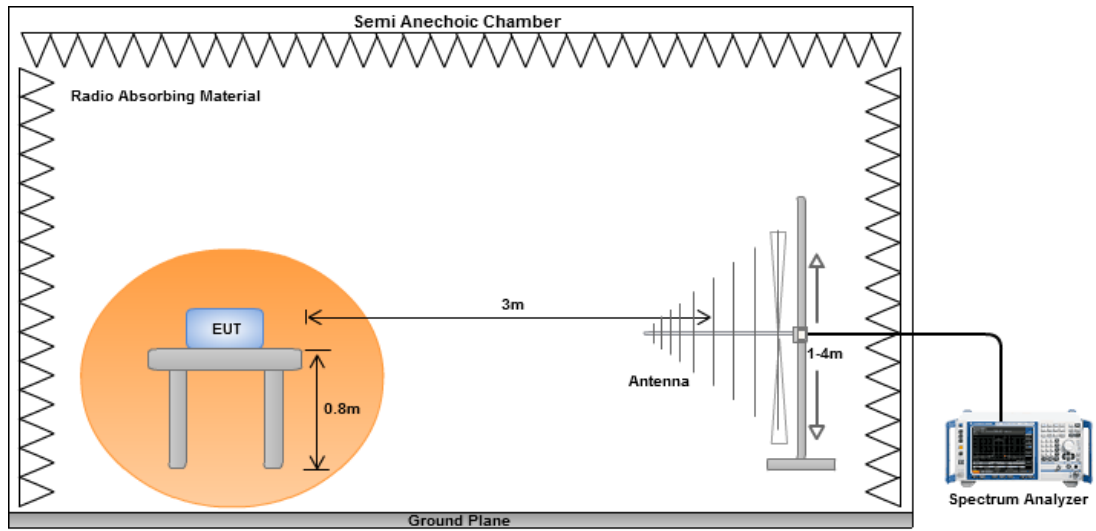

Radiated Emissions above 1 GHz

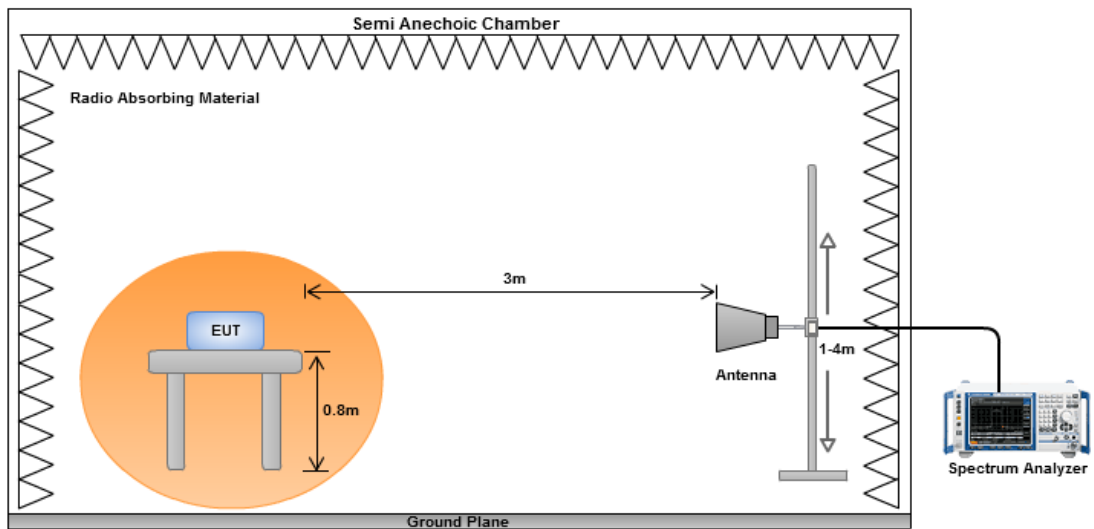

3.2.4 Test Result of Radiated Emissions below 1GHz

Mode	WCDMA Band V, Channel: 4132						
Frequency (MHz)	Antenna Polarity	E.R.P (dBm)	Limit (dBm)	Margin (dB)	S.A Reading (dBm)	S.G Power Vaule (dBm)	Correction Factor (dB)
30.00	H	-79.53	-13	-66.53	-75.24	-65.03	-12.35
90.14	H	-81.32	-13	-68.32	-65.73	-79.55	0.38
182.29	H	-82.30	-13	-69.30	-70.79	-84.10	3.95
265.71	H	-80.75	-13	-67.75	-69.97	-84.19	5.59
499.48	H	-76.47	-13	-63.47	-70.23	-79.50	5.18
958.29	H	-63.37	-13	-50.37	-63.58	-66.28	5.06
30.00	V	-74.39	-13	-61.39	-62.57	-59.89	-12.35
114.39	V	-76.80	-13	-63.80	-67.74	-74.85	0.20
139.61	V	-74.90	-13	-61.90	-68.96	-72.78	0.03
189.08	V	-69.20	-13	-56.20	-61.65	-71.76	4.71
630.43	V	-65.73	-13	-52.73	-63.33	-67.89	4.31
817.64	V	-64.27	-13	-51.27	-63.87	-65.99	3.87

NOTE: ERP = S.G power value + correction factor - 2.15

3.2.5 Test Result of Radiated Emissions above 1GHz

Mode		WCDMA Band V, Channel: 4132					
Frequency (MHz)	Antenna Polarity	E.R.P (dBm)	Limit (dBm)	Margin (dB)	S.A Reading (dBm)	S.G Power Vaule (dBm)	Correction Factor (dB)
1652.80	H	-37.23	-13.00	-24.23	-38.59	-40.12	5.04
2479.20	H	-50.26	-13.00	-37.26	-56.45	-54.18	6.07
3305.60	H	-53.58	-13.00	-40.58	-62.42	-57.84	6.41
1652.80	V	-46.32	-13.00	-33.32	-47.06	-49.21	5.04
2479.20	V	-51.24	-13.00	-38.24	-58.17	-55.16	6.07
3305.60	V	-52.89	-13.00	-39.89	-61.36	-57.15	6.41

Mode		WCDMA Band V, Channel: 4182					
Frequency (MHz)	Antenna Polarity	E.R.P (dBm)	Limit (dBm)	Margin (dB)	S.A Reading (dBm)	S.G Power Vaule (dBm)	Correction Factor (dB)
1672.80	H	-37.70	-13.00	-24.70	-39.16	-40.66	5.11
2509.20	H	-52.16	-13.00	-39.16	-58.42	-56.07	6.06
3345.60	H	-54.00	-13.00	-41.00	-62.63	-58.31	6.46
1672.80	V	-49.19	-13.00	-36.19	-50.00	-52.15	5.11
2509.20	V	-54.43	-13.00	-41.43	-61.41	-58.34	6.06
3345.60	V	-53.23	-13.00	-40.23	-61.68	-57.54	6.46

Mode		WCDMA Band V, Channel: 4233					
Frequency (MHz)	Antenna Polarity.	E.R.P (dBm)	Limit (dBm)	Margin (dB)	S.A Reading (dBm)	S.G Power Vaule (dBm)	Correction Factor (dB)
1693.20	H	-39.21	-13.00	-26.21	-40.78	-42.23	5.17
2539.80	H	-45.54	-13.00	-32.54	-51.87	-49.44	6.05
3386.40	H	-54.34	-13.00	-41.34	-62.76	-58.71	6.52
1693.20	V	-49.41	-13.00	-36.41	-50.29	-52.43	5.17
2539.80	V	-54.10	-13.00	-41.10	-61.12	-58.00	6.05
3386.40	V	-52.91	-13.00	-39.91	-61.33	-57.28	6.52

NOTE: ERP = S.G power value + correction factor - 2.15

3.3 Conducted Emissions

3.3.1 Limit of Conducted Emissions

The power of any emission outside of the authorized operating frequency ranges must be attenuated below the transmitting power (P) by a factor of at least $43 + 10 \log(P)$ dB equal to -13dBm.

3.3.2 Test Procedures

1. Lowest, middle and highest operating channels are tested for this item.
2. Scan frequency range is from 30MHz~9GHz.
3. Set RBW = 1MHz, VBW = 3MHz, detector = RMS, sweep time = auto.
4. Record the max trace value and capture the test plot of each sub frequency band.

3.3.3 Test Setup

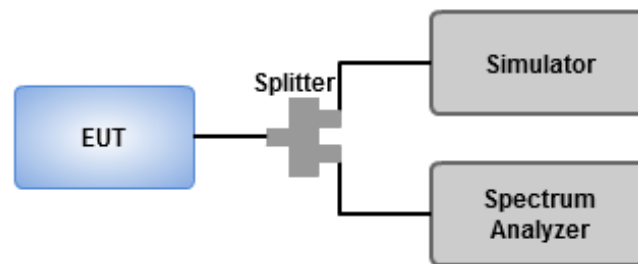

3.3.4 Test Result of Conducted Emissions

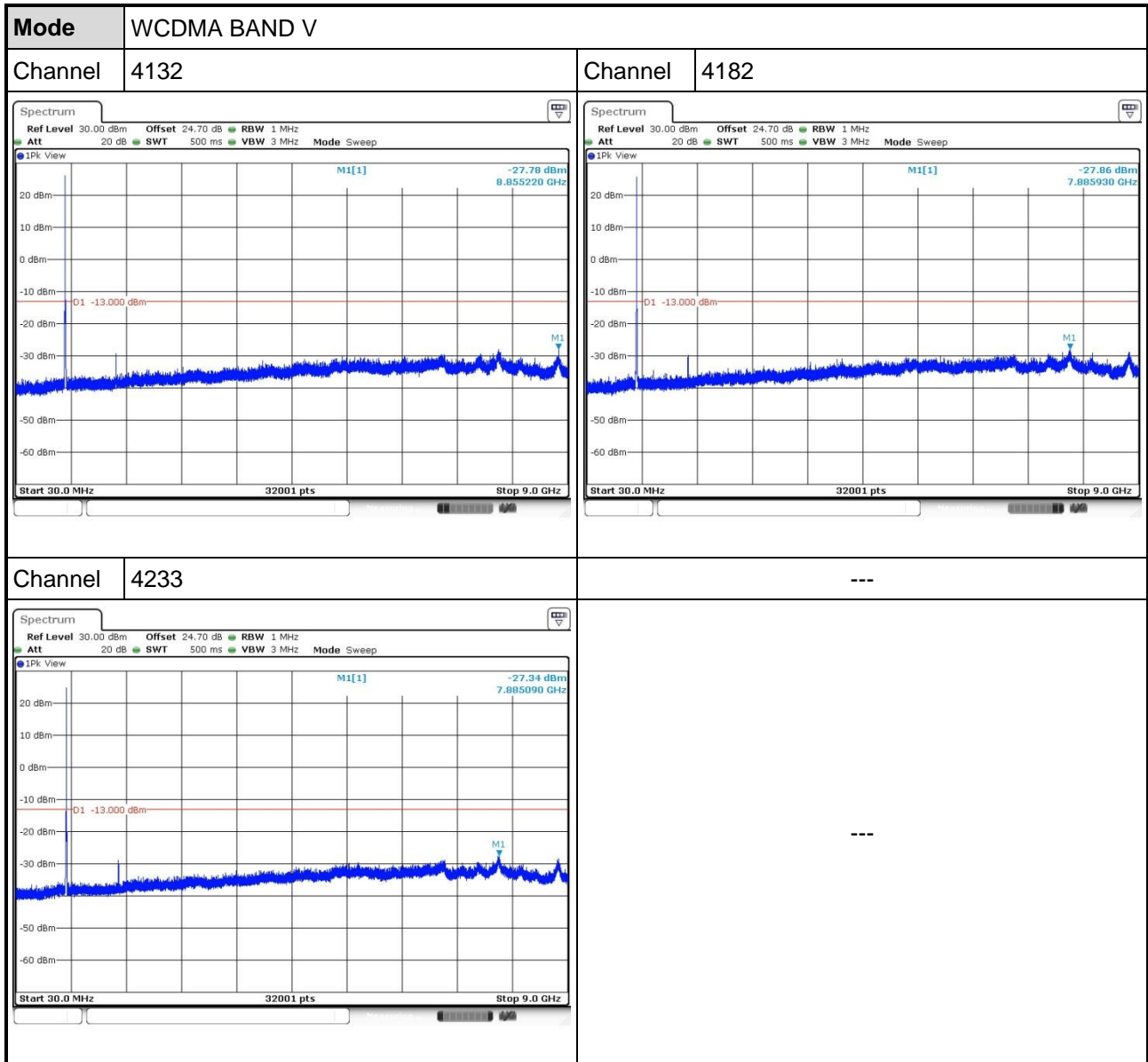

3.4 Band Edge

3.4.1 Limit of Band Edge

The power of any emission outside of the authorized operating frequency ranges must be attenuated below the transmitting power (P) by a factor of at least $43 + 10 \log(P)$ dB equal to -13dBm.

3.4.2 Test Procedures

1. Lowest and highest operating channels are tested for this item.
2. The center frequency of spectrum analyzer will be set to 824 and 849 MHz.
3. Set RBW = VBW = 100kHz, span = 5 MHz, detector = RMS, sweep time = auto
4. Record the max trace value and capture the test plot.

3.4.3 Test Setup

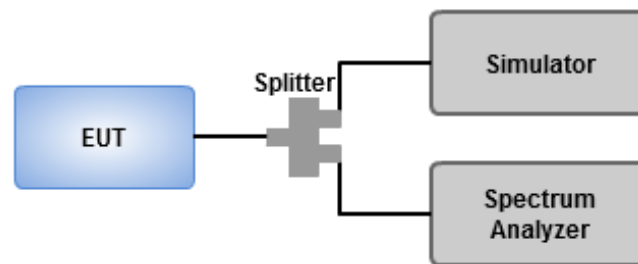

3.4.4 Test Result of Band Edge

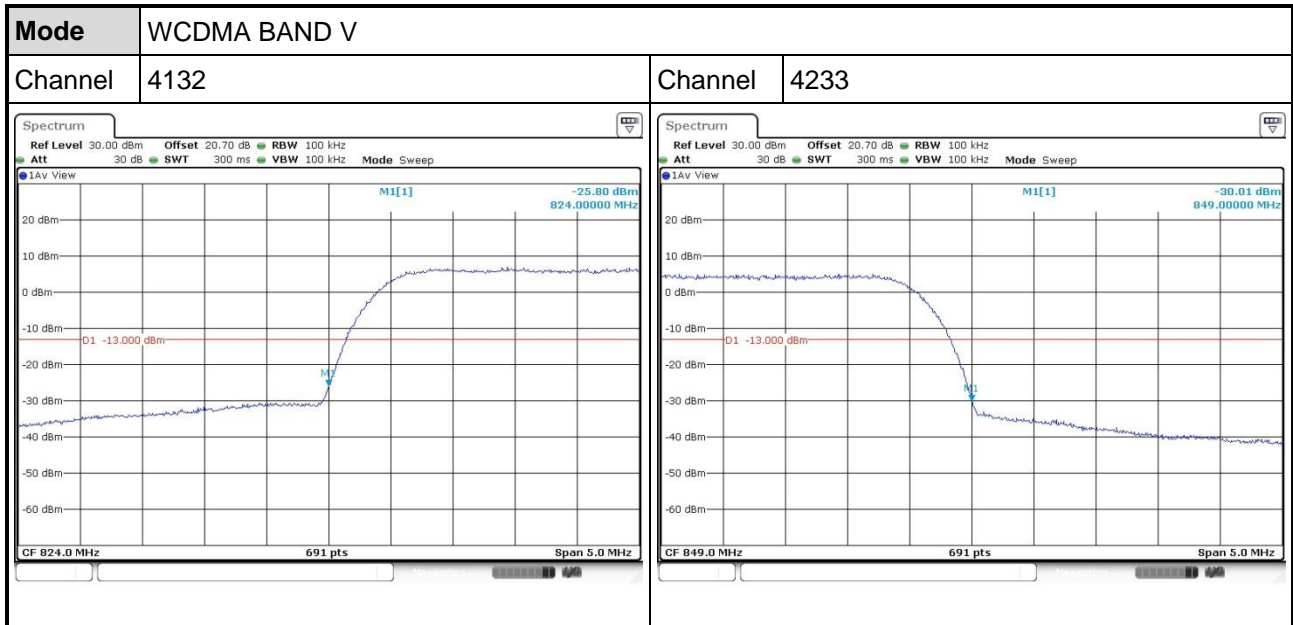

3.5 Occupied and 26 dB Bandwidth

3.5.1 Test Procedures

1. Set resolution bandwidth (RBW) = 100 kHz, Video bandwidth = 300 kHz
2. Detector = Peak, Trace mode = max hold.
3. Sweep = auto couple, Allow the trace to stabilize.
4. Using occupied bandwidth measurement function of spectrum analyzer to measure occupied bandwidth
5. Measure the maximum width of the emission that is constrained by the frequencies associated with the two outermost amplitude points (upper and lower) that are attenuated by 26dB relative to the maximum level measured in the fundamental emission.

3.5.2 Test Setup

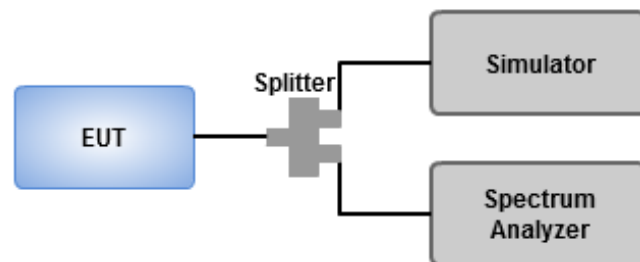

3.5.3 Test Result of Occupied Bandwidth

MODE	Channel	Frequency (MHz)	OBW (MHz)	26dB BW (MHz)
WCDMA BAND V	4132	826.4	4.07	4.6087
WCDMA BAND V	4182	836.4	4.07	4.6377
WCDMA BAND V	4133	846.6	4.08	4.5942



3.6 Peak to Average Ratio

3.6.1 Limit of Peak to Average Ratio

Peak-to-average ratio (PAR) of the transmission may not exceed 13 dB

3.6.2 Test Procedures

1. Enable CCDF function of spectrum analyzer and set RBW=10MHz
2. Set the number of counts to a value that stabilizes the measured CCDF curve
3. Record the maximum PAPR level associated with a probability of 0.1%.

3.6.3 Test Setup

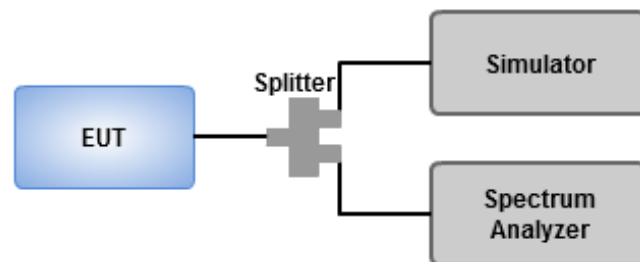

3.6.4 Test Result of Peak to Average Ratio

MODE	Channel	Frequency (MHz)	Peak to Average ratio (dB)
WCDMA BAND V	4132	826.4	2.78
WCDMA BAND V	4182	836.4	2.99
WCDMA BAND V	4133	846.6	2.93

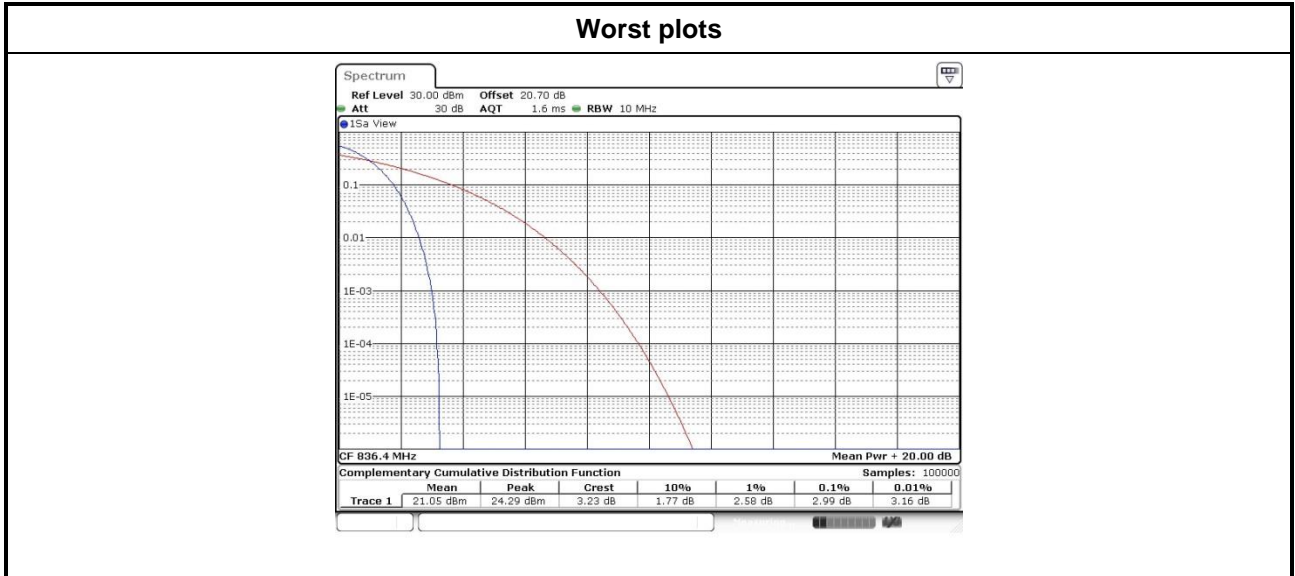

3.7 Frequency Stability

3.7.1 Limit of Frequency Stability

The frequency stability shall be less +/- 2.5ppm.

3.7.2 Test Procedures

1. EUT was placed at temperature chamber and connected to an external power supply.
2. Temperature and voltage condition shall be tested to confirm frequency stability.
3. Temperature range is from -30~50°C and voltage range is from lowest to highest working voltage.
4. Link up EUT and simulator. Confirm frequency drift value of simulator and record it.

3.7.3 Test Setup

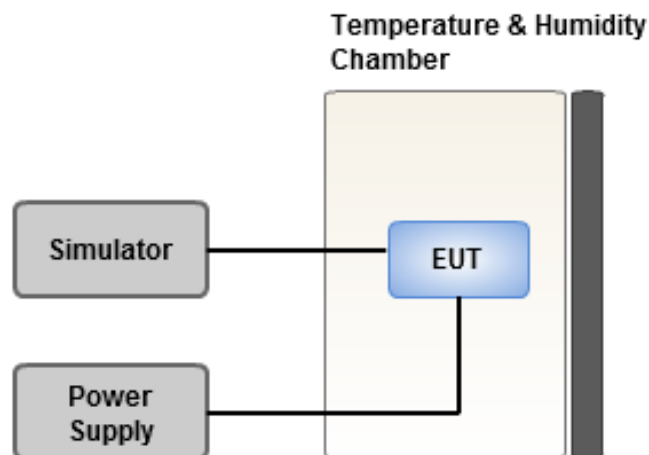

3.7.4 Test Result of Frequency Stability

Temperature (°C)	Voltage (ac)	Frequency Drift (ppm)	Limit (ppm)
50	7.40	0.087	2.5
40	7.40	0.085	2.5
30	7.40	0.081	2.5
20	7.40	0.065	2.5
10	7.40	0.071	2.5
0	7.40	0.074	2.5
-10	7.40	0.082	2.5
-20	7.40	0.068	2.5
-30	7.40	0.063	2.5
20	8.36	0.078	2.5
20	6.84	0.068	2.5

4 Test laboratory information

Established in 2012, ICC provides foremost EMC & RF Testing and advisory consultation services by our skilled engineers and technicians. Our services employ a wide variety of advanced edge test equipment and one of the widest certification extents in the business.

International Certification Corp, it is our definitive objective is to institute long term, trust-based associations with our clients. The expectation we set up with our clients is based on outstanding service, practical expertise and devotion to a certified value structure. Our passion is to grant our clients with best EMC / RF services by oriented knowledgeable and accommodating staff.

Our Test sites are located at Linkou District and Kwei Shan Hsiang. Location map can be found on our website <http://www.icertifi.com.tw>.

Linkou

Tel: 886-2-2601-1640

No. 30-2, Ding Fwu Tsuen, Lin Kou
District, New Taipei City, Taiwan,
R.O.C.

Kwei Shan

Tel: 886-3-271-8666

No. 3-1, Lane 6, Wen San 3rd
St., Kwei Shan Hsiang, Tao
Yuan Hsien 333, Taiwan, R.O.C.

Kwei Shan Site II

Tel: 886-3-271-8640

No. 14-1, Lane 19, Wen San 3rd
St., Kwei Shan Hsiang, Tao
Yuan Hsien 333, Taiwan, R.O.C.

If you have any suggestion, please feel free to contact us as below information

Tel: 886-3-271-8666

Fax: 886-3-318-0155

Email: ICC_Service@icertifi.com.tw

==END==