



FCC TEST REPORT (WLAN)

REPORT NO.: RF111121C23

MODEL NO.: WIXHSM-100

FCC ID: MXF- WIXHSM-100

RECEIVED: Nov. 21, 2011

TESTED: Dec. 14 ~ Dec. 17, 2011

ISSUED: Dec. 20, 2011

APPLICANT: Gemtek Technology Co., Ltd.

ADDRESS: No. 15-1, Zhonghua Rd, Hsinchu Industrial Park,
Hsinchu County, Taiwan, R.O.C. 303

ISSUED BY: Bureau Veritas Consumer Products Services (H.K.)
Ltd., Taoyuan Branch

LAB ADDRESS: No. 47, 14th Ling, Chia Pau Vil., Lin Kou Dist., New
Taipei City, Taiwan (R.O.C)

TEST LOCATION: No. 19, Hwa Ya 2nd Rd, Wen Hwa Tsuen, Kwei
Shan Hsiang, Taoyuan Hsien 333, Taiwan, R.O.C.

This test report consists of 53 pages in total. It may be duplicated completely for legal use with the approval of the applicant. It should not be reproduced except in full, without the written approval of our laboratory. The client should not use it to claim product certification, approval or endorsement by TAF or any government agency. The test results in the report only apply to the tested sample.





TABLE OF CONTENTS

| | |
|--|----|
| RELEASE CONTROL RECORD..... | 4 |
| 1. CERTIFICATION | 5 |
| 2. SUMMARY OF TEST RESULTS | 6 |
| 2.1 MEASUREMENT UNCERTAINTY..... | 6 |
| 3. GENERAL INFORMATION..... | 7 |
| 3.1 GENERAL DESCRIPTION OF EUT | 7 |
| 3.2 DESCRIPTION OF TEST MODES | 9 |
| 3.2.1 CONFIGURATION OF SYSTEM UNDER TEST | 10 |
| 3.2.2 DESCRIPTION OF SUPPORT UNITS | 10 |
| 3.2.3 TEST MODE APPLICABILITY AND TESTED CHANNEL DETAIL | 11 |
| 3.3 GENERAL DESCRIPTION OF APPLIED STANDARDS | 13 |
| 4. TEST TYPES AND RESULTS | 14 |
| 4.1 RADIATED EMISSION AND BANDEDGE MEASUREMENT..... | 14 |
| 4.1.1 LIMITS OF RADIATED AND BANDEDGE EMISSION MEASUREMENT | 14 |
| 4.1.2 TEST INSTRUMENTS..... | 15 |
| 4.1.3 TEST PROCEDURES | 16 |
| 4.1.4 DEVIATION FROM TEST STANDARD | 16 |
| 4.1.5 TEST SETUP..... | 17 |
| 4.1.6 EUT OPERATING CONDITIONS | 17 |
| 4.1.7 TEST RESULTS | 18 |
| 4.2 CONDUCTED EMISSION MEASUREMENT | 32 |
| 4.2.1 LIMITS OF CONDUCTED EMISSION MEASUREMENT..... | 32 |
| 4.2.2 TEST INSTRUMENTS..... | 32 |
| 4.2.3 TEST PROCEDURES | 33 |
| 4.2.4 DEVIATION FROM TEST STANDARD | 33 |
| 4.2.5 TEST SETUP..... | 34 |
| 4.2.6 EUT OPERATING CONDITIONS | 34 |
| 4.2.7 TEST RESULTS | 35 |
| 4.3 6dB BANDWIDTH MEASUREMENT..... | 39 |
| 4.3.1 LIMITS OF 6dB BANDWIDTH MEASUREMENT | 39 |
| 4.3.2 TEST SETUP..... | 39 |
| 4.3.3 TEST INSTRUMENTS..... | 39 |
| 4.3.4 TEST PROCEDURE..... | 39 |
| 4.3.5 DEVIATION FROM TEST STANDARD | 39 |



A D T

| | | |
|-------|---|----|
| 4.3.6 | EUT OPERATING CONDITIONS | 39 |
| 4.3.7 | TEST RESULTS | 40 |
| 4.4 | CONDUCTED OUTPUT POWER | 41 |
| 4.4.1 | LIMITS OF CONDUCTED OUTPUT POWER MEASUREMENT | 41 |
| 4.4.2 | TEST SETUP..... | 41 |
| 4.4.3 | TEST INSTRUMENTS..... | 41 |
| 4.4.4 | TEST PROCEDURES | 41 |
| 4.4.5 | DEVIATION FROM TEST STANDARD | 41 |
| 4.4.6 | EUT OPERATING CONDITIONS | 41 |
| 4.4.7 | TEST RESULTS | 42 |
| 4.5 | POWER SPECTRAL DENSITY MEASUREMENT..... | 43 |
| 4.5.1 | LIMITS OF POWER SPECTRAL DENSITY MEASUREMENT | 43 |
| 4.5.2 | TEST SETUP..... | 43 |
| 4.5.3 | TEST INSTRUMENTS..... | 43 |
| 4.5.4 | TEST PROCEDURE..... | 43 |
| 4.5.5 | DEVIATION FROM TEST STANDARD | 43 |
| 4.5.6 | EUT OPERATING CONDITION | 43 |
| 4.5.7 | TEST RESULTS | 44 |
| 4.6 | CONDUCTED EMISSION MEASUREMENT | 45 |
| 4.6.1 | LIMITS OF BAND EDGES MEASUREMENT..... | 45 |
| 4.6.2 | TEST SETUP..... | 45 |
| 4.6.3 | TEST INSTRUMENTS..... | 45 |
| 4.6.4 | TEST PROCEDURE..... | 45 |
| 4.6.5 | DEVIATION FROM TEST STANDARD | 46 |
| 4.6.6 | EUT OPERATING CONDITION | 46 |
| 4.6.7 | TEST RESULTS | 46 |
| 5. | PHOTOGRAPHS OF THE TEST CONFIGURATION..... | 51 |
| 6. | INFORMATION ON THE TESTING LABORATORIES | 52 |
| 7. | APPENDIX A - MODIFICATIONS RECORDERS FOR ENGINEERING CHANGES TO THE EUT BY THE LAB..... | 53 |



A D T

RELEASE CONTROL RECORD

| ISSUE NO. | REASON FOR CHANGE | DATE ISSUED |
|------------------|-------------------|---------------|
| Original release | NA | Dec. 20, 2011 |

1. CERTIFICATION

PRODUCT: WiMAX Smart Phone
MODEL: WIXHSM-100
BRAND: Gemtek
APPLICANT: Gemtek Technology Co., Ltd.
TESTED: Dec. 14 ~ Dec. 17, 2011
TEST SAMPLE: ENGINEERING SAMPLE
STANDARDS: **FCC Part 15, Subpart C (Section 15.247)**
ANSI C63.4-2003
ANSI C63.10-2009

The above equipment (model: WIXHSM-100) have been tested by **Bureau Veritas Consumer Products Services (H.K.) Ltd., Taoyuan Branch**, and found compliance with the requirement of the above standards. The test record, data evaluation & Equipment Under Test (EUT) configurations represented herein are true and accurate accounts of the measurements of the sample's EMC characteristics under the conditions specified in this report.

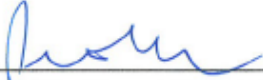
PREPARED BY :  , DATE: Dec. 20, 2011
Pettie Chen / Specialist

APPROVED BY :  , DATE: Dec. 20, 2011
Gary Chang / Technical Manager

2. SUMMARY OF TEST RESULTS

The EUT has been tested according to the following specifications:

| APPLIED STANDARD: FCC PART 15, SUBPART C (SECTION 15.247) | | | |
|---|-----------------------------|--------|--|
| STANDARD SECTION | TEST TYPE | RESULT | REMARK |
| 15.207 | AC Power Conducted Emission | PASS | Meet the requirement of limit. Minimum passing margin is -11.11dB at 0.154MHz. |
| 15.247(d) 15.209 | Radiated Emissions | PASS | Meet the requirement of limit. Minimum passing margin is -1.0dB at 2390.00MHz. |
| 15.247(d) | Band Edge Measurement | PASS | Meet the requirement of limit. |
| 15.247(a)(2) | 6dB bandwidth | PASS | Meet the requirement of limit. |
| 15.247(b) | Conducted power | PASS | Meet the requirement of limit. |
| 15.247(e) | Power Spectral Density | PASS | Meet the requirement of limit. |
| 15.203 | Antenna Requirement | PASS | No antenna connector is used. |

2.1 MEASUREMENT UNCERTAINTY

Where relevant, the following measurement uncertainty levels have been estimated for tests performed on the EUT as specified in CISPR 16-4-2:

| MEASUREMENT | FREQUENCY | UNCERTAINTY |
|---------------------|-----------------|-------------|
| Conducted emissions | 150kHz~30MHz | 2.44 dB |
| Radiated emissions | 30MHz ~ 200MHz | 3.34 dB |
| | 200MHz ~1000MHz | 3.35 dB |
| | 1GHz ~ 18GHz | 2.26 dB |
| | 18GHz ~ 40GHz | 1.94 dB |

This uncertainty represents an expanded uncertainty expressed at approximately the 95% confidence level using a coverage factor of $k = 2$.



3. GENERAL INFORMATION

3.1 GENERAL DESCRIPTION OF EUT

| | |
|------------------------------|--|
| EUT | WiMAX Smart Phone |
| MODEL NO. | WIXHSM-100 |
| FCC ID | MXF-WIXHSM-100 |
| POWER SUPPLY | 5.0Vdc (adapter or host equipment) 3.7Vdc (battery) |
| MODULATION TYPE | CCK, DQPSK, DBPSK for DSSS 64QAM, 16QAM, QPSK, BPSK for OFDM |
| MODULATION TECHNOLOGY | DSSS, OFDM |
| TRANSFER RATE | 802.11b:11.0/ 5.5/ 2.0/ 1.0Mbps 802.11g: 54.0/ 48.0/ 36.0/ 24.0/ 18.0/ 12.0/ 9.0/ 6.0Mbps 802.11n: up to 150.0Mbps |
| OPERATING FREQUENCY | 2412 ~ 2462MHz |
| NUMBER OF CHANNEL | 11 for 802.11b, 802.11g, 802.11n (20MHz) 7 for 802.11n (40MHz) |
| OUTPUT POWER | 338.8mW |
| ANTENNA TYPE | Printed antenna with 0dBi gain |
| ANTENNA CONNECTOR | NA |
| DATA CABLE | 1.2 m shielded USB cable without core |
| I/O PORTS | Refer to user's manual |
| ACCESSORY DEVICES | Battery, Adapter, Earphone (1.3m non-shielded w/o core) |

NOTE:

1. The EUT provides one completed transmitter and one receiver.

| MODULATION MODE | TX FUNCTION |
|------------------------|--------------------|
| 802.11b | 1TX |
| 802.11g | 1TX |
| 802.11n (20MHz) | 1TX |
| 802.11n (40MHz) | 1TX |



2. The EUT was powered by the following adapters and battery:

| ADAPTER 1 | |
|----------------|--|
| BRAND: | DVE |
| MODEL: | DSC-5PFC-05 FUS 050100 DSC-5PFC-05 FUS 052100 (For Marketing different) |
| INPUT: | 100-240Vac, 50-60Hz, 0.2A |
| OUTPUT: | 5Vdc, 1A |

| ADAPTER 2 | |
|----------------|---------------------|
| BRAND: | SPPS Travel Charger |
| MODEL: | LFS0501000D-A8S |
| INPUT: | 100-240Vac, 50-60Hz |
| OUTPUT: | 5Vdc, 1000mA |

*After pre-testing, adapter 1 was the worst for final test.

| BATTERY | |
|----------------|------------------|
| BRAND: | Skypower |
| MODEL: | GT-1920 |
| RATING: | 3.7Vdc, 1920 mAh |

3. The above EUT information is declared by manufacturer and for more detailed features description, please refer to the manufacturer's specifications or user's manual.



3.2 DESCRIPTION OF TEST MODES

11 channels are provided for 802.11b, 802.11g and 802.11n (20MHz):

| CHANNEL | FREQUENCY | CHANNEL | FREQUENCY |
|---------|-----------|---------|-----------|
| 1 | 2412MHz | 7 | 2442MHz |
| 2 | 2417MHz | 8 | 2447MHz |
| 3 | 2422MHz | 9 | 2452MHz |
| 4 | 2427MHz | 10 | 2457MHz |
| 5 | 2432MHz | 11 | 2462MHz |
| 6 | 2437MHz | | |

7 channels are provided for 802.11n (40MHz):

| CHANNEL | FREQUENCY | CHANNEL | FREQUENCY |
|---------|-----------|---------|-----------|
| 1 | 2422MHz | 5 | 2442MHz |
| 2 | 2427MHz | 6 | 2447MHz |
| 3 | 2432MHz | 7 | 2452MHz |
| 4 | 2437MHz | | |

3.2.1 CONFIGURATION OF SYSTEM UNDER TEST

Test Mode A

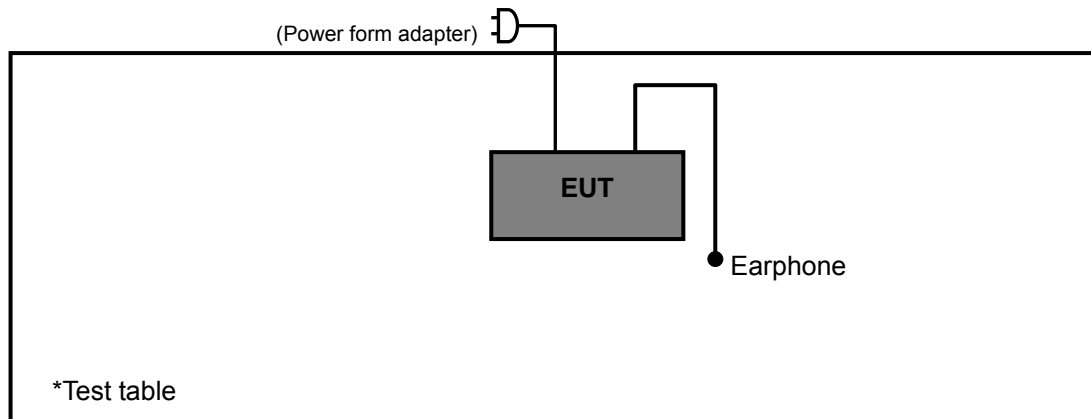

Test Mode B

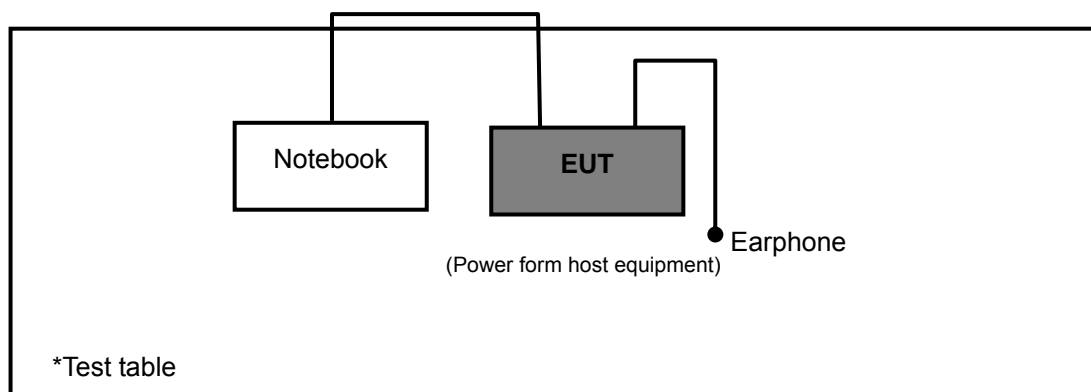

3.2.2 DESCRIPTION OF SUPPORT UNITS

The EUT has been tested as an independent unit together with other necessary accessories or support units. The following support units or accessories were used to form a representative test configuration during the tests.

| NO. | PRODUCT | BRAND | MODEL NO. | SERIAL NO. | FCC ID |
|-----|----------|-------|----------------|------------|------------------|
| 1 | NOTEBOOK | DELL | Latitude E5520 | NA | FCC DoC Approved |

| NO. | SIGNAL CABLE DESCRIPTION OF THE ABOVE SUPPORT UNITS |
|-----|---|
| 1 | NA |

NOTE: All power cords of the above support units are non shielded (1.8m).

3.2.3 TEST MODE APPLICABILITY AND TESTED CHANNEL DETAIL

| EUT CONFIGURE MODE | APPLICABLE TO | | | | DESCRIPTION |
|--------------------|---------------|-------|-----|------|---------------------------|
| | RE \geq 1G | RE<1G | PLC | APCM | |
| A | √ | √ | √ | √ | Power from adapter |
| B | - | √ | √ | - | Power from host equipment |

Where **RE \geq 1G**: Radiated Emission above 1GHz **RE<1G**: Radiated Emission below 1GHz
PLC: Power Line Conducted Emission **APCM**: Antenna Port Conducted Measurement

NOTE: “-”: Means no effect.

RADIATED EMISSION TEST (ABOVE 1GHz):

- Pre-Scan has been conducted to determine the worst-case mode from all possible combinations between available modulations, data rates, XYZ axis and antenna ports (if EUT with antenna diversity architecture).
- Following channel(s) was (were) selected for the final test as listed below.

| EUT CONFIGURE MODE | MODE | AVAILABLE CHANNEL | TESTED CHANNEL | MODULATION TECHNOLOGY | MODULATION TYPE | DATA RATE (Mbps) | AXIS |
|--------------------|-----------------|-------------------|----------------|-----------------------|-----------------|------------------|------|
| A | 802.11b | 1 to 11 | 1, 6, 11 | DSSS | DBPSK | 1.0 | Y |
| A | 802.11g | 1 to 11 | 1, 6, 11 | OFDM | BPSK | 6.0 | Y |
| A | 802.11n (20MHz) | 1 to 11 | 1, 6, 11 | OFDM | BPSK | 7.2 | Y |
| A | 802.11n (40MHz) | 1 to 7 | 1, 4, 7 | OFDM | BPSK | 13.5 | Y |

RADIATED EMISSION TEST (BELOW 1GHz):

- Pre-Scan has been conducted to determine the worst-case mode from all possible combinations between available modulations, data rates, XYZ axis and antenna ports (if EUT with antenna diversity architecture).
- Following channel(s) was (were) selected for the final test as listed below.

| EUT CONFIGURE MODE | MODE | AVAILABLE CHANNEL | TESTED CHANNEL | MODULATION TECHNOLOGY | MODULATION TYPE | DATA RATE (Mbps) | AXIS |
|--------------------|---------|-------------------|----------------|-----------------------|-----------------|------------------|------|
| A, B | 802.11g | 1 to 11 | 11 | OFDM | BPSK | 6.0 | Y |

POWER LINE CONDUCTED EMISSION TEST:

- Pre-Scan has been conducted to determine the worst-case mode from all possible combinations between available modulations, data rates and antenna ports (if EUT with antenna diversity architecture).
- Following channel(s) was (were) selected for the final test as listed below.

| EUT CONFIGURE MODE | MODE | AVAILABLE CHANNEL | TESTED CHANNEL | MODULATION TECHNOLOGY | MODULATION TYPE | DATA RATE (Mbps) |
|--------------------|---------|-------------------|----------------|-----------------------|-----------------|------------------|
| A, B | 802.11g | 1 to 11 | 11 | OFDM | BPSK | 6.0 |



BANDEDGE MEASUREMENT:

- Pre-Scan has been conducted to determine the worst-case mode from all possible combinations between available modulations, data rates and antenna ports (if EUT with antenna diversity architecture).
- Following channel(s) was (were) selected for the final test as listed below.

| EUT CONFIGURE MODE | MODE | AVAILABLE CHANNEL | TESTED CHANNEL | MODULATION TECHNOLOGY | MODULATION TYPE | DATA RATE (Mbps) |
|--------------------|-----------------|-------------------|----------------|-----------------------|-----------------|------------------|
| A | 802.11b | 1 to 11 | 1, 11 | DSSS | DBPSK | 1.0 |
| A | 802.11g | 1 to 11 | 1, 11 | OFDM | BPSK | 6.0 |
| A | 802.11n (20MHz) | 1 to 11 | 1, 11 | OFDM | BPSK | 7.2 |
| A | 802.11n (40MHz) | 1 to 7 | 1, 7 | OFDM | BPSK | 13.5 |

ANTENNA PORT CONDUCTED MEASUREMENT:

- This item includes all test value of each mode, but only includes spectrum plot of worst value of each mode.
- Pre-Scan has been conducted to determine the worst-case mode from all possible combinations between available modulations, data rates and antenna ports (if EUT with antenna diversity architecture).
- Following channel(s) was (were) selected for the final test as listed below.

| EUT CONFIGURE MODE | MODE | AVAILABLE CHANNEL | TESTED CHANNEL | MODULATION TECHNOLOGY | MODULATION TYPE | DATA RATE (Mbps) |
|--------------------|-----------------|-------------------|----------------|-----------------------|-----------------|------------------|
| A | 802.11b | 1 to 11 | 1, 6, 11 | DSSS | DBPSK | 1.0 |
| A | 802.11g | 1 to 11 | 1, 6, 11 | OFDM | BPSK | 6.0 |
| A | 802.11n (20MHz) | 1 to 11 | 1, 6, 11 | OFDM | BPSK | 7.2 |
| A | 802.11n (40MHz) | 1 to 7 | 1, 4, 7 | OFDM | BPSK | 13.5 |

TEST CONDITION:

| APPLICABLE TO | ENVIRONMENTAL CONDITIONS | INPUT POWER | TESTED BY |
|---------------|--------------------------|--------------|------------|
| RE≥1G | 25deg. C, 65%RH | 120Vac, 60Hz | Antony Lee |
| RE<1G | 25deg. C, 65%RH | 120Vac, 60Hz | Kay Wu |
| PLC | 22deg. C, 61%RH | 120Vac, 60Hz | Antony Lee |
| APCM | 25deg. C, 68%RH | 120Vac, 60Hz | Brad Wu |

3.3 GENERAL DESCRIPTION OF APPLIED STANDARDS

The EUT is a RF Product. According to the specifications of the manufacturer, it must comply with the requirements of the following standards:

FCC Part 15, Subpart C (15.247)

ANSI C63.4-2003

ANSI C63.10-2009

All test items have been performed and recorded as per the above standards.

NOTE: The EUT is also considered as a kind of computer peripheral, because the connection to computer is necessary for typical use. It has been verified to comply with the requirements of FCC Part 15, Subpart B, Class B (DoC). The test report has been issued separately.

4. TEST TYPES AND RESULTS

4.1 RADIATED EMISSION AND BANDEDGE MEASUREMENT

4.1.1 LIMITS OF RADIATED AND BANDEDGE EMISSION MEASUREMENT

Radiated emissions which fall in the restricted bands, as defined in Section 15.205(a), must also comply with the radiated emission limits specified in Section 15.209(a). Other emissions shall be at least 20dB below the highest level of the desired power:

| FREQUENCIES (MHz) | FIELD STRENGTH (microvolts/meter) | MEASUREMENT DISTANCE (meters) |
|-------------------|-----------------------------------|-------------------------------|
| 0.009 ~ 0.490 | 2400/F(kHz) | 300 |
| 0.490 ~ 1.705 | 24000/F(kHz) | 30 |
| 1.705 ~ 30.0 | 30 | 30 |
| 30 ~ 88 | 100 | 3 |
| 88 ~ 216 | 150 | 3 |
| 216 ~ 960 | 200 | 3 |
| Above 960 | 500 | 3 |

NOTE:

1. The lower limit shall apply at the transition frequencies.
2. Emission level (dBuV/m) = 20 log Emission level (uV/m).
3. As shown in 15.35(b), for frequencies above 1000MHz, the field strength limits are based on average detector, however, the peak field strength of any emission shall not exceed the maximum permitted average limits, specified above by more than 20dB under any condition of modulation.



4.1.2 TEST INSTRUMENTS

| DESCRIPTION & MANUFACTURER | MODEL NO. | SERIAL NO. | DATE OF CALIBRATION | DUE DATE OF CALIBRATION |
|---|------------------------------|-------------|---------------------|-------------------------|
| Test Receiver ROHDE & SCHWARZ | ESIB7 | 100212 | Aug. 02, 2011 | Aug. 01, 2012 |
| Spectrum Analyzer ROHDE & SCHWARZ | FSP 40 | 100041 | Jul. 21, 2011 | Jul. 20, 2012 |
| BILOG Antenna SCHWARZBECK | VULB9168 | 9168-160 | Apr. 13, 2011 | Apr. 12, 2012 |
| HORN Antenna SCHWARZBECK | 9120D | 209 | Aug. 25, 2011 | Aug. 24, 2012 |
| HORN Antenna SCHWARZBECK | BBHA 9170 | BBHA9170243 | Dec. 27, 2010 | Dec. 26, 2011 |
| Preamplifier Agilent | 8447D | 2944A10633 | Oct. 29, 2011 | Oct. 28, 2012 |
| Preamplifier Agilent | 8449B | 3008A01964 | Oct. 29, 2011 | Oct. 28, 2012 |
| RF signal cable HUBER+SUHNNER | SUCOFLEX 104 | 295014/4 | Aug. 19, 2011 | Aug. 18, 2012 |
| RF signal cable HUBER+SUHNNER | SUCOFLEX 104 | 12738/6 | Aug. 19, 2011 | Aug. 18, 2012 |
| Software ADT. | ADT_Radiated_ V7.6.15.9.2 | NA | NA | NA |
| Antenna Tower inn-co GmbH | MA 4000 | 013303 | NA | NA |
| Antenna Tower Controller inn-co GmbH | CO2000 | 017303 | NA | NA |
| Turn Table ADT. | TT100. | TT93021703 | NA | NA |
| Turn Table Controller ADT. | SC100. | SC93021703 | NA | NA |
| High Speed Peak Power Meter | ML2495A | 0842014 | Apr. 26, 2011 | Apr. 25, 2012 |
| Power Sensor | MA2411B | 0738404 | Apr. 26, 2011 | Apr. 25, 2012 |

- NOTE:**
1. The calibration interval of the above test instruments is 12 months and the calibrations are traceable to NML/ROC and NIST/USA.
 2. The test was performed in HwaYa Chamber 3.
 3. The horn antenna and HP preamplifier (model: 8449B) are used only for the measurement of emission frequency above 1GHz if tested.
 4. The FCC Site Registration No. is 988962.
 5. The IC Site Registration No. is IC 7450F-3.

4.1.3 TEST PROCEDURES

- a. The EUT was placed on the top of a rotating table 0.8 meters above the ground at a 3 meters semi-anechoic chamber. The table was rotated 360 degrees to determine the position of the highest radiation.
- b. The EUT was set 3 meters away from the interference-receiving antenna, which was mounted on the top of a variable-height antenna tower.
- c. Height of receiving antenna is varied from one meter to four meters above the ground to determine the maximum value of the field strength. Both horizontal and vertical polarizations of the antenna are set to make the measurement.
- d. For each suspected emission, the EUT was arranged to its worst case and then the antenna was tuned to heights from 1 meter to 4 meters and the rotatable table was turned from 0 degrees to 360 degrees to find the maximum reading.
- e. The test-receiver system was set to Peak Detect Function and Specified Bandwidth with Maximum Hold Mode.
- f. If the emission level of the EUT in peak mode was lower than the limit specified, then testing could be stopped and the peak values of the EUT would be reported. Otherwise the emissions would be re-tested one by one using peak, quasi-peak or average method as specified and then reported in a data sheet.

NOTE:

1. The resolution bandwidth and video bandwidth of test receiver/spectrum analyzer is 120kHz for Quasi-peak detection at frequency below 1GHz.
2. The resolution bandwidth of test receiver/spectrum analyzer is 1MHz and video bandwidth is 3MHz for Peak detection at frequency above 1GHz.
3. The resolution bandwidth of test receiver/spectrum analyzer is 1MHz and the video bandwidth is 10Hz for Average detection (AV) at frequency above 1GHz.
4. All modes of operation were investigated and the worst-case emissions are reported.

4.1.4 DEVIATION FROM TEST STANDARD

No deviation.

4.1.5 TEST SETUP

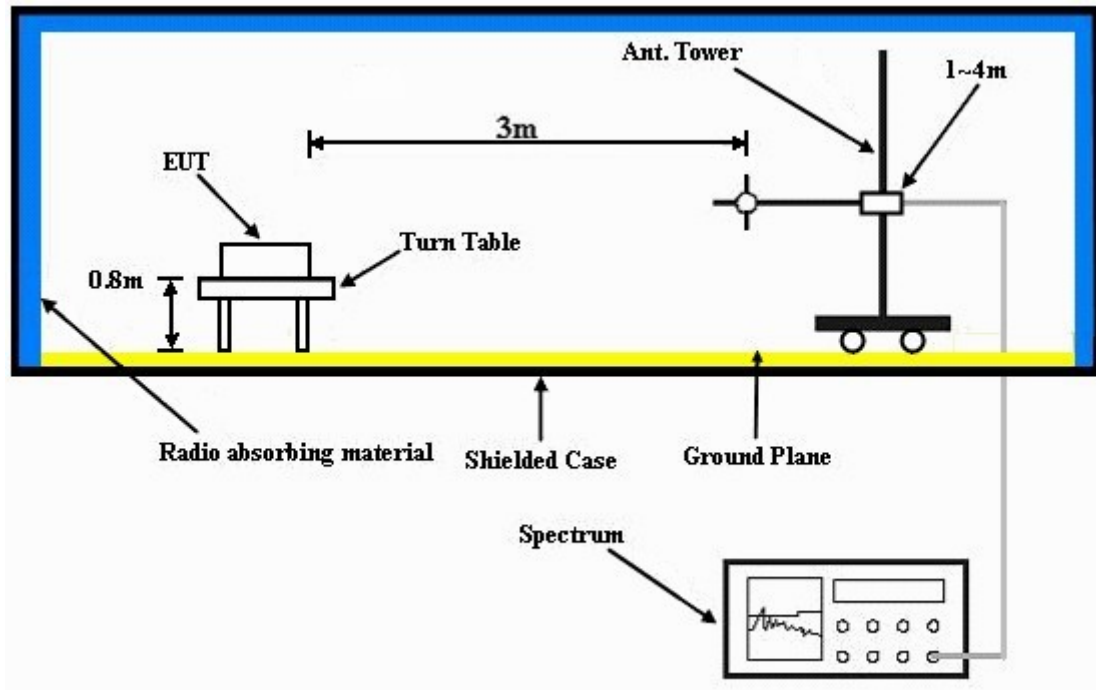

For the actual test configuration, please refer to the attached file (Test Setup Photo).

4.1.6 EUT OPERATING CONDITIONS

TEST MODE A

- a. Placed the EUT on a testing table.
- b. Use the software to control the EUT under transmission condition continuously at specific channel frequency.

TEST MODE B

- a. Connected the EUT to notebook and placed on a testing table.
- b. Use the software to control the EUT under transmission condition continuously at specific channel frequency.
- c. The necessary accessories enable the system in full functions.

4.1.7 TEST RESULTS

802.11b

| EUT TEST CONDITION | | MEASUREMENT DETAIL | |
|--------------------------|-----------------|--------------------|---------------------------|
| CHANNEL | Channel 1 | FREQUENCY RANGE | 1 ~ 25GHz |
| INPUT POWER (SYSTEM) | 120Vac, 60 Hz | DETECTOR FUNCTION | Peak (PK) Average (AV) |
| ENVIRONMENTAL CONDITIONS | 25deg. C, 65%RH | TESTED BY | Antony Lee |

| ANTENNA POLARITY & TEST DISTANCE: HORIZONTAL AT 3 M | | | | | | | | |
|---|-------------|-------------------------|----------------|-------------|--------------------|----------------------|------------------|--------------------------|
| NO. | FREQ. (MHz) | EMISSION LEVEL (dBuV/m) | LIMIT (dBuV/m) | MARGIN (dB) | ANTENNA HEIGHT (m) | TABLE ANGLE (Degree) | RAW VALUE (dBuV) | CORRECTION FACTOR (dB/m) |
| 1 | 2390.00 | 56.1 PK | 74.0 | -17.9 | 1.45 H | 266 | 23.70 | 32.40 |
| 2 | 2390.00 | 45.1 AV | 54.0 | -8.9 | 1.45 H | 266 | 12.70 | 32.40 |
| 3 | *2412.00 | 101.8 PK | | | 1.75 H | 265 | 69.40 | 32.40 |
| 4 | *2412.00 | 97.1 AV | | | 1.75 H | 265 | 64.70 | 32.40 |
| 5 | 4824.00 | 55.4 PK | 74.0 | -18.6 | 1.05 H | 214 | 16.70 | 38.70 |
| 6 | 4824.00 | 52.5 AV | 54.0 | -1.5 | 1.05 H | 214 | 13.80 | 38.70 |
| ANTENNA POLARITY & TEST DISTANCE: VERTICAL AT 3 M | | | | | | | | |
| NO. | FREQ. (MHz) | EMISSION LEVEL (dBuV/m) | LIMIT (dBuV/m) | MARGIN (dB) | ANTENNA HEIGHT (m) | TABLE ANGLE (Degree) | RAW VALUE (dBuV) | CORRECTION FACTOR (dB/m) |
| 1 | 2390.00 | 54.9 PK | 74.0 | -19.1 | 1.33 V | 2 | 22.50 | 32.40 |
| 2 | 2390.00 | 42.5 AV | 54.0 | -11.5 | 1.33 V | 2 | 10.10 | 32.40 |
| 3 | *2412.00 | 92.7 PK | | | 1.33 V | 0 | 60.30 | 32.40 |
| 4 | *2412.00 | 88.8 AV | | | 1.33 V | 0 | 56.40 | 32.40 |
| 5 | 4824.00 | 55.9 PK | 74.0 | -18.1 | 1.60 V | 220 | 17.20 | 38.70 |
| 6 | 4824.00 | 52.7 AV | 54.0 | -1.3 | 1.60 V | 220 | 14.00 | 38.70 |

- REMARKS:**
1. Emission level (dBuV/m) = Raw Value (dBuV) + Correction Factor (dB/m).
 2. Correction Factor (dB/m) = Antenna Factor (dB/m) + Cable Factor (dB).
 3. The other emission levels were very low against the limit.
 4. Margin value = Emission level – Limit value.
 5. “ * “: Fundamental frequency.



A D T

| EUT TEST CONDITION | | MEASUREMENT DETAIL | |
|--------------------------|-----------------|--------------------|---------------------------|
| CHANNEL | Channel 6 | FREQUENCY RANGE | 1 ~ 25GHz |
| INPUT POWER (SYSTEM) | 120Vac, 60 Hz | DETECTOR FUNCTION | Peak (PK) Average (AV) |
| ENVIRONMENTAL CONDITIONS | 25deg. C, 65%RH | TESTED BY | Antony Lee |

| ANTENNA POLARITY & TEST DISTANCE: HORIZONTAL AT 3 M | | | | | | | | |
|---|-------------|-------------------------|----------------|-------------|--------------------|----------------------|------------------|--------------------------|
| NO. | FREQ. (MHz) | EMISSION LEVEL (dBuV/m) | LIMIT (dBuV/m) | MARGIN (dB) | ANTENNA HEIGHT (m) | TABLE ANGLE (Degree) | RAW VALUE (dBuV) | CORRECTION FACTOR (dB/m) |
| 1 | *2437.00 | 101.3 PK | | | 1.74 H | 263 | 68.80 | 32.50 |
| 2 | *2437.00 | 97.5 AV | | | 1.74 H | 263 | 65.00 | 32.50 |
| 3 | #3249.00 | 42.3 PK | 81.3 | -39.0 | 1.00 H | 56 | 7.50 | 34.80 |
| 4 | #3249.00 | 29.8 AV | 77.5 | -47.7 | 1.00 H | 56 | -5.00 | 34.80 |
| 5 | 4874.00 | 55.4 PK | 74.0 | -18.6 | 1.03 H | 214 | 16.60 | 38.80 |
| 6 | 4874.00 | 52.7 AV | 54.0 | -1.3 | 1.03 H | 214 | 13.90 | 38.80 |

| ANTENNA POLARITY & TEST DISTANCE: VERTICAL AT 3 M | | | | | | | | |
|---|-------------|-------------------------|----------------|-------------|--------------------|----------------------|------------------|--------------------------|
| NO. | FREQ. (MHz) | EMISSION LEVEL (dBuV/m) | LIMIT (dBuV/m) | MARGIN (dB) | ANTENNA HEIGHT (m) | TABLE ANGLE (Degree) | RAW VALUE (dBuV) | CORRECTION FACTOR (dB/m) |
| 1 | *2437.00 | 91.6 PK | | | 1.34 V | 0 | 59.10 | 32.50 |
| 2 | *2437.00 | 87.7 AV | | | 1.34 V | 0 | 55.20 | 32.50 |
| 3 | #3249.00 | 44.5 PK | 71.6 | -27.1 | 1.16 V | 7 | 9.70 | 34.80 |
| 4 | #3249.00 | 30.3 AV | 67.7 | -37.4 | 1.16 V | 7 | -4.50 | 34.80 |
| 5 | 4874.00 | 57.3 PK | 74.0 | -16.7 | 1.27 V | 260 | 18.50 | 38.80 |
| 6 | 4874.00 | 52.6 AV | 54.0 | -1.4 | 1.27 V | 260 | 13.80 | 38.80 |

- REMARKS:**
1. Emission level (dBuV/m) = Raw Value (dBuV) + Correction Factor (dB/m).
 2. Correction Factor (dB/m) = Antenna Factor (dB/m) + Cable Factor (dB).
 3. The other emission levels were very low against the limit.
 4. Margin value = Emission level – Limit value.
 5. “ * “: Fundamental frequency.
 6. “#”: The radiated frequency is out the restricted band.



A D T

| EUT TEST CONDITION | | MEASUREMENT DETAIL | |
|--------------------------|-----------------|--------------------|---------------------------|
| CHANNEL | Channel 11 | FREQUENCY RANGE | 1 ~ 25GHz |
| INPUT POWER (SYSTEM) | 120Vac, 60 Hz | DETECTOR FUNCTION | Peak (PK) Average (AV) |
| ENVIRONMENTAL CONDITIONS | 25deg. C, 65%RH | TESTED BY | Antony Lee |

| ANTENNA POLARITY & TEST DISTANCE: HORIZONTAL AT 3 M | | | | | | | | |
|---|-------------|-------------------------|----------------|-------------|--------------------|----------------------|------------------|--------------------------|
| NO. | FREQ. (MHz) | EMISSION LEVEL (dBuV/m) | LIMIT (dBuV/m) | MARGIN (dB) | ANTENNA HEIGHT (m) | TABLE ANGLE (Degree) | RAW VALUE (dBuV) | CORRECTION FACTOR (dB/m) |
| 1 | *2462.00 | 101.6 PK | | | 1.67 H | 267 | 69.00 | 32.60 |
| 2 | *2462.00 | 97.7 AV | | | 1.67 H | 267 | 65.10 | 32.60 |
| 3 | 2483.50 | 55.3 PK | 74.0 | -18.7 | 1.67 H | 268 | 22.60 | 32.70 |
| 4 | 2483.50 | 44.9 AV | 54.0 | -9.1 | 1.67 H | 268 | 12.20 | 32.70 |
| 5 | 4924.00 | 55.2 PK | 74.0 | -18.8 | 1.04 H | 218 | 16.20 | 39.00 |
| 6 | 4924.00 | 52.8 AV | 54.0 | -1.2 | 1.04 H | 218 | 13.80 | 39.00 |
| ANTENNA POLARITY & TEST DISTANCE: VERTICAL AT 3 M | | | | | | | | |
| NO. | FREQ. (MHz) | EMISSION LEVEL (dBuV/m) | LIMIT (dBuV/m) | MARGIN (dB) | ANTENNA HEIGHT (m) | TABLE ANGLE (Degree) | RAW VALUE (dBuV) | CORRECTION FACTOR (dB/m) |
| 1 | *2462.00 | 93.4 PK | | | 1.54 V | 64 | 60.80 | 32.60 |
| 2 | *2462.00 | 89.4 AV | | | 1.54 V | 64 | 56.80 | 32.60 |
| 3 | 2483.50 | 54.8 PK | 74.0 | -19.2 | 1.54 V | 64 | 22.10 | 32.70 |
| 4 | 2483.50 | 43.0 AV | 54.0 | -11.0 | 1.54 V | 64 | 10.30 | 32.70 |
| 5 | 4924.00 | 55.9 PK | 74.0 | -18.1 | 1.07 V | 338 | 16.90 | 39.00 |
| 6 | 4924.00 | 52.6 AV | 54.0 | -1.4 | 1.07 V | 338 | 13.60 | 39.00 |

- REMARKS:**
1. Emission level (dBuV/m) = Raw Value (dBuV) + Correction Factor (dB/m).
 2. Correction Factor (dB/m) = Antenna Factor (dB/m) + Cable Factor (dB).
 3. The other emission levels were very low against the limit.
 4. Margin value = Emission level – Limit value.
 5. “ * “: Fundamental frequency.



A D T

802.11g

| EUT TEST CONDITION | | MEASUREMENT DETAIL | |
|--------------------------|-----------------|--------------------|---------------------------|
| CHANNEL | Channel 1 | FREQUENCY RANGE | 1 ~ 25GHz |
| INPUT POWER (SYSTEM) | 120Vac, 60 Hz | DETECTOR FUNCTION | Peak (PK) Average (AV) |
| ENVIRONMENTAL CONDITIONS | 25deg. C, 65%RH | TESTED BY | Antony Lee |

ANTENNA POLARITY & TEST DISTANCE: HORIZONTAL AT 3 M

| NO. | FREQ. (MHz) | EMISSION LEVEL (dBuV/m) | LIMIT (dBuV/m) | MARGIN (dB) | ANTENNA HEIGHT (m) | TABLE ANGLE (Degree) | RAW VALUE (dBuV) | CORRECTION FACTOR (dB/m) |
|-----|-------------|-------------------------|----------------|-------------|--------------------|----------------------|------------------|--------------------------|
| 1 | 2390.00 | 65.9 PK | 74.0 | -8.1 | 1.76 H | 259 | 33.50 | 32.40 |
| 2 | 2390.00 | 53.0 AV | 54.0 | -1.0 | 1.76 H | 259 | 20.60 | 32.40 |
| 3 | *2412.00 | 106.2 PK | | | 1.75 H | 261 | 73.80 | 32.40 |
| 4 | *2412.00 | 97.4 AV | | | 1.75 H | 261 | 65.00 | 32.40 |
| 5 | 4824.00 | 58.9 PK | 74.0 | -15.1 | 1.00 H | 227 | 20.20 | 38.70 |
| 6 | 4824.00 | 45.0 AV | 54.0 | -9.0 | 1.00 H | 227 | 6.30 | 38.70 |

ANTENNA POLARITY & TEST DISTANCE: VERTICAL AT 3 M

| NO. | FREQ. (MHz) | EMISSION LEVEL (dBuV/m) | LIMIT (dBuV/m) | MARGIN (dB) | ANTENNA HEIGHT (m) | TABLE ANGLE (Degree) | RAW VALUE (dBuV) | CORRECTION FACTOR (dB/m) |
|-----|-------------|-------------------------|----------------|-------------|--------------------|----------------------|------------------|--------------------------|
| 1 | 2390.00 | 57.2 PK | 74.0 | -16.8 | 1.29 V | 13 | 24.80 | 32.40 |
| 2 | 2390.00 | 47.6 AV | 54.0 | -6.4 | 1.29 V | 13 | 15.20 | 32.40 |
| 3 | *2412.00 | 98.3 PK | | | 1.29 V | 12 | 65.90 | 32.40 |
| 4 | *2412.00 | 89.5 AV | | | 1.29 V | 12 | 57.10 | 32.40 |
| 5 | 4824.00 | 58.5 PK | 74.0 | -15.5 | 1.58 V | 254 | 19.80 | 38.70 |
| 6 | 4824.00 | 44.9 AV | 54.0 | -9.1 | 1.58 V | 254 | 6.20 | 38.70 |

- REMARKS:**
1. Emission level (dBuV/m) = Raw Value (dBuV) + Correction Factor (dB/m).
 2. Correction Factor (dB/m) = Antenna Factor (dB/m) + Cable Factor (dB).
 3. The other emission levels were very low against the limit.
 4. Margin value = Emission level – Limit value.
 5. “ * “: Fundamental frequency.



A D T

| EUT TEST CONDITION | | MEASUREMENT DETAIL | |
|--------------------------|-----------------|--------------------|---------------------------|
| CHANNEL | Channel 6 | FREQUENCY RANGE | 1 ~ 25GHz |
| INPUT POWER (SYSTEM) | 120Vac, 60 Hz | DETECTOR FUNCTION | Peak (PK) Average (AV) |
| ENVIRONMENTAL CONDITIONS | 25deg. C, 65%RH | TESTED BY | Antony Lee |

ANTENNA POLARITY & TEST DISTANCE: HORIZONTAL AT 3 M

| NO. | FREQ. (MHz) | EMISSION LEVEL (dBuV/m) | LIMIT (dBuV/m) | MARGIN (dB) | ANTENNA HEIGHT (m) | TABLE ANGLE (Degree) | RAW VALUE (dBuV) | CORRECTION FACTOR (dB/m) |
|-----|-------------|-------------------------|----------------|-------------|--------------------|----------------------|------------------|--------------------------|
| 1 | *2437.00 | 106.4 PK | | | 1.70 H | 264 | 73.90 | 32.50 |
| 2 | *2437.00 | 96.6 AV | | | 1.70 H | 264 | 64.10 | 32.50 |
| 3 | 2483.50 | 55.0 PK | 74.0 | -19.0 | 1.69 H | 265 | 22.30 | 32.70 |
| 4 | 2483.50 | 45.9 AV | 54.0 | -8.1 | 1.69 H | 265 | 13.20 | 32.70 |
| 5 | 4874.00 | 56.2 PK | 74.0 | -17.8 | 1.00 H | 30 | 17.40 | 38.80 |
| 6 | 4874.00 | 42.9 AV | 54.0 | -11.1 | 1.00 H | 30 | 4.10 | 38.80 |

ANTENNA POLARITY & TEST DISTANCE: VERTICAL AT 3 M

| NO. | FREQ. (MHz) | EMISSION LEVEL (dBuV/m) | LIMIT (dBuV/m) | MARGIN (dB) | ANTENNA HEIGHT (m) | TABLE ANGLE (Degree) | RAW VALUE (dBuV) | CORRECTION FACTOR (dB/m) |
|-----|-------------|-------------------------|----------------|-------------|--------------------|----------------------|------------------|--------------------------|
| 1 | *2437.00 | 97.8 PK | | | 1.03 V | 50 | 65.30 | 32.50 |
| 2 | *2437.00 | 87.8 AV | | | 1.03 V | 50 | 55.30 | 32.50 |
| 3 | 2483.50 | 56.4 PK | 74.0 | -17.6 | 1.02 V | 66 | 23.70 | 32.70 |
| 4 | 2483.50 | 42.9 AV | 54.0 | -11.1 | 1.02 V | 66 | 10.20 | 32.70 |
| 5 | 4874.00 | 55.7 PK | 74.0 | -18.3 | 1.60 V | 222 | 16.90 | 38.80 |
| 6 | 4874.00 | 41.7 AV | 54.0 | -12.3 | 1.60 V | 222 | 2.90 | 38.80 |

- REMARKS:**
1. Emission level (dBuV/m) = Raw Value (dBuV) + Correction Factor (dB/m).
 2. Correction Factor (dB/m) = Antenna Factor (dB/m) + Cable Factor (dB).
 3. The other emission levels were very low against the limit.
 4. Margin value = Emission level – Limit value.
 5. “ * “: Fundamental frequency.



| EUT TEST CONDITION | | MEASUREMENT DETAIL | |
|--------------------------|-----------------|--------------------|---------------------------|
| CHANNEL | Channel 11 | FREQUENCY RANGE | 1 ~ 25GHz |
| INPUT POWER (SYSTEM) | 120Vac, 60 Hz | DETECTOR FUNCTION | Peak (PK) Average (AV) |
| ENVIRONMENTAL CONDITIONS | 25deg. C, 65%RH | TESTED BY | Antony Lee |

ANTENNA POLARITY & TEST DISTANCE: HORIZONTAL AT 3 M

| NO. | FREQ. (MHz) | EMISSION LEVEL (dBuV/m) | LIMIT (dBuV/m) | MARGIN (dB) | ANTENNA HEIGHT (m) | TABLE ANGLE (Degree) | RAW VALUE (dBuV) | CORRECTION FACTOR (dB/m) |
|-----|-------------|-------------------------|----------------|-------------|--------------------|----------------------|------------------|--------------------------|
| 1 | *2462.00 | 105.1 PK | | | 1.75 H | 262 | 72.50 | 32.60 |
| 2 | *2462.00 | 95.3 AV | | | 1.75 H | 262 | 62.70 | 32.60 |
| 3 | 2483.50 | 64.9 PK | 74.0 | -9.1 | 1.75 H | 263 | 32.20 | 32.70 |
| 4 | 2483.50 | 52.5 AV | 54.0 | -1.5 | 1.75 H | 263 | 19.80 | 32.70 |
| 5 | 4924.00 | 53.2 PK | 74.0 | -20.8 | 1.00 H | 236 | 14.20 | 39.00 |
| 6 | 4924.00 | 40.1 AV | 54.0 | -13.9 | 1.00 H | 236 | 1.10 | 39.00 |

ANTENNA POLARITY & TEST DISTANCE: VERTICAL AT 3 M

| NO. | FREQ. (MHz) | EMISSION LEVEL (dBuV/m) | LIMIT (dBuV/m) | MARGIN (dB) | ANTENNA HEIGHT (m) | TABLE ANGLE (Degree) | RAW VALUE (dBuV) | CORRECTION FACTOR (dB/m) |
|-----|-------------|-------------------------|----------------|-------------|--------------------|----------------------|------------------|--------------------------|
| 1 | *2462.00 | 99.6 PK | | | 1.08 V | 336 | 67.00 | 32.60 |
| 2 | *2462.00 | 89.9 AV | | | 1.08 V | 336 | 57.30 | 32.60 |
| 3 | 2483.50 | 60.4 PK | 74.0 | -13.6 | 1.08 V | 335 | 27.70 | 32.70 |
| 4 | 2483.50 | 46.6 AV | 54.0 | -7.4 | 1.08 V | 335 | 13.90 | 32.70 |
| 5 | 4924.00 | 52.5 PK | 74.0 | -21.5 | 1.22 V | 206 | 13.50 | 39.00 |
| 6 | 4924.00 | 39.6 AV | 54.0 | -14.4 | 1.22 V | 206 | 0.60 | 39.00 |

- REMARKS:**
1. Emission level (dBuV/m) = Raw Value (dBuV) + Correction Factor (dB/m).
 2. Correction Factor (dB/m) = Antenna Factor (dB/m) + Cable Factor (dB).
 3. The other emission levels were very low against the limit.
 4. Margin value = Emission level – Limit value.
 5. “ * “: Fundamental frequency.



A D T

802.11n (20MHz)

| EUT TEST CONDITION | | MEASUREMENT DETAIL | |
|--------------------------|-----------------|--------------------|---------------------------|
| CHANNEL | Channel 1 | FREQUENCY RANGE | 1 ~ 25GHz |
| INPUT POWER (SYSTEM) | 120Vac, 60 Hz | DETECTOR FUNCTION | Peak (PK) Average (AV) |
| ENVIRONMENTAL CONDITIONS | 25deg. C, 65%RH | TESTED BY | Antony Lee |

ANTENNA POLARITY & TEST DISTANCE: HORIZONTAL AT 3 M

| NO. | FREQ. (MHz) | EMISSION LEVEL (dBuV/m) | LIMIT (dBuV/m) | MARGIN (dB) | ANTENNA HEIGHT (m) | TABLE ANGLE (Degree) | RAW VALUE (dBuV) | CORRECTION FACTOR (dB/m) |
|-----|-------------|-------------------------|----------------|-------------|--------------------|----------------------|------------------|--------------------------|
| 1 | 2390.00 | 66.8 PK | 74.0 | -7.2 | 1.74 H | 256 | 34.40 | 32.40 |
| 2 | 2390.00 | 51.6 AV | 54.0 | -2.4 | 1.74 H | 256 | 19.20 | 32.40 |
| 3 | *2412.00 | 103.2 PK | | | 1.74 H | 256 | 70.80 | 32.40 |
| 4 | *2412.00 | 93.3 AV | | | 1.74 H | 256 | 60.90 | 32.40 |
| 5 | 4824.00 | 57.3 PK | 74.0 | -16.7 | 1.14 H | 231 | 18.60 | 38.70 |
| 6 | 4824.00 | 43.9 AV | 54.0 | -10.1 | 1.14 H | 231 | 5.20 | 38.70 |

ANTENNA POLARITY & TEST DISTANCE: VERTICAL AT 3 M

| NO. | FREQ. (MHz) | EMISSION LEVEL (dBuV/m) | LIMIT (dBuV/m) | MARGIN (dB) | ANTENNA HEIGHT (m) | TABLE ANGLE (Degree) | RAW VALUE (dBuV) | CORRECTION FACTOR (dB/m) |
|-----|-------------|-------------------------|----------------|-------------|--------------------|----------------------|------------------|--------------------------|
| 1 | 2390.00 | 57.2 PK | 74.0 | -16.8 | 1.29 V | 324 | 24.80 | 32.40 |
| 2 | 2390.00 | 44.6 AV | 54.0 | -9.4 | 1.29 V | 324 | 12.20 | 32.40 |
| 3 | *2412.00 | 98.7 PK | | | 1.29 V | 324 | 66.30 | 32.40 |
| 4 | *2412.00 | 88.9 AV | | | 1.29 V | 324 | 56.50 | 32.40 |
| 5 | 4824.00 | 55.1 PK | 74.0 | -18.9 | 1.48 V | 209 | 16.40 | 38.70 |
| 6 | 4824.00 | 41.7 AV | 54.0 | -12.3 | 1.48 V | 209 | 3.00 | 38.70 |

- REMARKS:**
1. Emission level (dBuV/m) = Raw Value (dBuV) + Correction Factor (dB/m).
 2. Correction Factor (dB/m) = Antenna Factor (dB/m) + Cable Factor (dB).
 3. The other emission levels were very low against the limit.
 4. Margin value = Emission level – Limit value.
 5. “ * “: Fundamental frequency.



A D T

| EUT TEST CONDITION | | MEASUREMENT DETAIL | |
|--------------------------|-----------------|--------------------|---------------------------|
| CHANNEL | Channel 6 | FREQUENCY RANGE | 1 ~ 25GHz |
| INPUT POWER (SYSTEM) | 120Vac, 60 Hz | DETECTOR FUNCTION | Peak (PK) Average (AV) |
| ENVIRONMENTAL CONDITIONS | 25deg. C, 65%RH | TESTED BY | Antony Lee |

ANTENNA POLARITY & TEST DISTANCE: HORIZONTAL AT 3 M

| NO. | FREQ. (MHz) | EMISSION LEVEL (dBuV/m) | LIMIT (dBuV/m) | MARGIN (dB) | ANTENNA HEIGHT (m) | TABLE ANGLE (Degree) | RAW VALUE (dBuV) | CORRECTION FACTOR (dB/m) |
|-----|-------------|-------------------------|----------------|-------------|--------------------|----------------------|------------------|--------------------------|
| 1 | *2437.00 | 103.3 PK | | | 1.74 H | 248 | 70.80 | 32.50 |
| 2 | *2437.00 | 93.6 AV | | | 1.74 H | 248 | 61.10 | 32.50 |
| 3 | 2483.50 | 55.1 PK | 74.0 | -18.9 | 1.74 H | 248 | 22.40 | 32.70 |
| 4 | 2483.50 | 43.8 AV | 54.0 | -10.2 | 1.74 H | 248 | 11.10 | 32.70 |
| 5 | 4874.00 | 55.3 PK | 74.0 | -18.7 | 1.16 H | 321 | 16.50 | 38.80 |
| 6 | 4874.00 | 40.9 AV | 54.0 | -13.1 | 1.16 H | 321 | 2.10 | 38.80 |

ANTENNA POLARITY & TEST DISTANCE: VERTICAL AT 3 M

| NO. | FREQ. (MHz) | EMISSION LEVEL (dBuV/m) | LIMIT (dBuV/m) | MARGIN (dB) | ANTENNA HEIGHT (m) | TABLE ANGLE (Degree) | RAW VALUE (dBuV) | CORRECTION FACTOR (dB/m) |
|-----|-------------|-------------------------|----------------|-------------|--------------------|----------------------|------------------|--------------------------|
| 1 | *2437.00 | 100.0 PK | | | 1.07 V | 339 | 67.50 | 32.50 |
| 2 | *2437.00 | 90.4 AV | | | 1.07 V | 339 | 57.90 | 32.50 |
| 3 | 2483.50 | 54.2 PK | 74.0 | -19.8 | 1.07 V | 339 | 21.50 | 32.70 |
| 4 | 2483.50 | 42.8 AV | 54.0 | -11.2 | 1.07 V | 339 | 10.10 | 32.70 |
| 5 | 4874.00 | 53.4 PK | 74.0 | -20.6 | 1.00 V | 304 | 14.60 | 38.80 |
| 6 | 4874.00 | 40.7 AV | 54.0 | -13.3 | 1.00 V | 304 | 1.90 | 38.80 |

- REMARKS:**
1. Emission level (dBuV/m) = Raw Value (dBuV) + Correction Factor (dB/m).
 2. Correction Factor (dB/m) = Antenna Factor (dB/m) + Cable Factor (dB).
 3. The other emission levels were very low against the limit.
 4. Margin value = Emission level – Limit value.
 5. “ * “: Fundamental frequency.



A D T

| EUT TEST CONDITION | | MEASUREMENT DETAIL | |
|--------------------------|-----------------|--------------------|---------------------------|
| CHANNEL | Channel 11 | FREQUENCY RANGE | 1 ~ 25GHz |
| INPUT POWER (SYSTEM) | 120Vac, 60 Hz | DETECTOR FUNCTION | Peak (PK) Average (AV) |
| ENVIRONMENTAL CONDITIONS | 25deg. C, 65%RH | TESTED BY | Antony Lee |

ANTENNA POLARITY & TEST DISTANCE: HORIZONTAL AT 3 M

| NO. | FREQ. (MHz) | EMISSION LEVEL (dBuV/m) | LIMIT (dBuV/m) | MARGIN (dB) | ANTENNA HEIGHT (m) | TABLE ANGLE (Degree) | RAW VALUE (dBuV) | CORRECTION FACTOR (dB/m) |
|-----|-------------|-------------------------|----------------|-------------|--------------------|----------------------|------------------|--------------------------|
| 1 | *2462.00 | 103.3 PK | | | 1.75 H | 261 | 70.70 | 32.60 |
| 2 | *2462.00 | 93.4 AV | | | 1.75 H | 261 | 60.80 | 32.60 |
| 3 | 2483.50 | 63.8 PK | 74.0 | -10.2 | 1.75 H | 263 | 31.10 | 32.70 |
| 4 | 2483.50 | 51.7 AV | 54.0 | -2.3 | 1.75 H | 263 | 19.00 | 32.70 |
| 5 | 4924.00 | 55.0 PK | 74.0 | -19.0 | 1.00 H | 234 | 16.00 | 39.00 |
| 6 | 4924.00 | 42.3 AV | 54.0 | -11.7 | 1.00 H | 234 | 3.30 | 39.00 |

ANTENNA POLARITY & TEST DISTANCE: VERTICAL AT 3 M

| NO. | FREQ. (MHz) | EMISSION LEVEL (dBuV/m) | LIMIT (dBuV/m) | MARGIN (dB) | ANTENNA HEIGHT (m) | TABLE ANGLE (Degree) | RAW VALUE (dBuV) | CORRECTION FACTOR (dB/m) |
|-----|-------------|-------------------------|----------------|-------------|--------------------|----------------------|------------------|--------------------------|
| 1 | *2462.00 | 101.6 PK | | | 1.02 V | 318 | 69.00 | 32.60 |
| 2 | *2462.00 | 92.1 AV | | | 1.02 V | 318 | 59.50 | 32.60 |
| 3 | 2483.50 | 66.4 PK | 74.0 | -7.6 | 1.02 V | 317 | 33.70 | 32.70 |
| 4 | 2483.50 | 50.0 AV | 54.0 | -4.0 | 1.02 V | 317 | 17.30 | 32.70 |
| 5 | 4924.00 | 53.9 PK | 74.0 | -20.1 | 1.31 V | 209 | 14.90 | 39.00 |
| 6 | 4924.00 | 39.1 AV | 54.0 | -14.9 | 1.31 V | 209 | 0.10 | 39.00 |

- REMARKS:**
1. Emission level (dBuV/m) = Raw Value (dBuV) + Correction Factor (dB/m).
 2. Correction Factor (dB/m) = Antenna Factor (dB/m) + Cable Factor (dB).
 3. The other emission levels were very low against the limit.
 4. Margin value = Emission level – Limit value.
 5. “ * “: Fundamental frequency.



A D T

802.11n (40MHz)

| EUT TEST CONDITION | | MEASUREMENT DETAIL | |
|--------------------------|-----------------|--------------------|---------------------------|
| CHANNEL | Channel 1 | FREQUENCY RANGE | 1 ~ 25GHz |
| INPUT POWER (SYSTEM) | 120Vac, 60 Hz | DETECTOR FUNCTION | Peak (PK) Average (AV) |
| ENVIRONMENTAL CONDITIONS | 25deg. C, 65%RH | TESTED BY | Antony Lee |

ANTENNA POLARITY & TEST DISTANCE: HORIZONTAL AT 3 M

| NO. | FREQ. (MHz) | EMISSION LEVEL (dBuV/m) | LIMIT (dBuV/m) | MARGIN (dB) | ANTENNA HEIGHT (m) | TABLE ANGLE (Degree) | RAW VALUE (dBuV) | CORRECTION FACTOR (dB/m) |
|-----|-------------|-------------------------|----------------|-------------|--------------------|----------------------|------------------|--------------------------|
| 1 | 2390.00 | 59.1 PK | 74.0 | -14.9 | 1.47 H | 319 | 26.70 | 32.40 |
| 2 | 2390.00 | 47.3 AV | 54.0 | -6.7 | 1.47 H | 319 | 14.90 | 32.40 |
| 3 | *2422.00 | 99.9 PK | | | 1.47 H | 323 | 67.40 | 32.50 |
| 4 | *2422.00 | 90.2 AV | | | 1.47 H | 323 | 57.70 | 32.50 |
| 5 | 4844.00 | 55.2 PK | 74.0 | -18.8 | 1.06 H | 336 | 16.40 | 38.80 |
| 6 | 4844.00 | 41.6 AV | 54.0 | -12.4 | 1.06 H | 336 | 2.80 | 38.80 |

ANTENNA POLARITY & TEST DISTANCE: VERTICAL AT 3 M

| NO. | FREQ. (MHz) | EMISSION LEVEL (dBuV/m) | LIMIT (dBuV/m) | MARGIN (dB) | ANTENNA HEIGHT (m) | TABLE ANGLE (Degree) | RAW VALUE (dBuV) | CORRECTION FACTOR (dB/m) |
|-----|-------------|-------------------------|----------------|-------------|--------------------|----------------------|------------------|--------------------------|
| 1 | 2390.00 | 57.4 PK | 74.0 | -16.6 | 1.12 V | 18 | 25.00 | 32.40 |
| 2 | 2390.00 | 45.8 AV | 54.0 | -8.2 | 1.12 V | 18 | 13.40 | 32.40 |
| 3 | *2422.00 | 98.4 PK | | | 1.10 V | 17 | 65.90 | 32.50 |
| 4 | *2422.00 | 88.2 AV | | | 1.10 V | 17 | 55.70 | 32.50 |
| 5 | 4844.00 | 52.4 PK | 74.0 | -21.6 | 1.03 V | 249 | 13.60 | 38.80 |
| 6 | 4844.00 | 38.4 AV | 54.0 | -15.6 | 1.03 V | 249 | -0.40 | 38.80 |

- REMARKS:**
1. Emission level (dBuV/m) = Raw Value (dBuV) + Correction Factor (dB/m).
 2. Correction Factor (dB/m) = Antenna Factor (dB/m) + Cable Factor (dB).
 3. The other emission levels were very low against the limit.
 4. Margin value = Emission level – Limit value.
 5. “ * “: Fundamental frequency.



A D T

| EUT TEST CONDITION | | MEASUREMENT DETAIL | |
|--------------------------|-----------------|--------------------|---------------------------|
| CHANNEL | Channel 4 | FREQUENCY RANGE | 1 ~ 25GHz |
| INPUT POWER (SYSTEM) | 120Vac, 60 Hz | DETECTOR FUNCTION | Peak (PK) Average (AV) |
| ENVIRONMENTAL CONDITIONS | 25deg. C, 65%RH | TESTED BY | Antony Lee |

ANTENNA POLARITY & TEST DISTANCE: HORIZONTAL AT 3 M

| NO. | FREQ. (MHz) | EMISSION LEVEL (dBuV/m) | LIMIT (dBuV/m) | MARGIN (dB) | ANTENNA HEIGHT (m) | TABLE ANGLE (Degree) | RAW VALUE (dBuV) | CORRECTION FACTOR (dB/m) |
|-----|-------------|-------------------------|----------------|-------------|--------------------|----------------------|------------------|--------------------------|
| 1 | *2437.00 | 99.3 PK | | | 1.46 H | 247 | 66.80 | 32.50 |
| 2 | *2437.00 | 90.0 AV | | | 1.46 H | 247 | 57.50 | 32.50 |
| 3 | 2483.50 | 57.4 PK | 74.0 | -16.6 | 1.46 H | 247 | 24.70 | 32.70 |
| 4 | 2483.50 | 43.6 AV | 54.0 | -10.4 | 1.46 H | 247 | 10.90 | 32.70 |
| 5 | 4874.00 | 52.2 PK | 74.0 | -21.8 | 1.15 H | 320 | 13.40 | 38.80 |
| 6 | 4874.00 | 38.9 AV | 54.0 | -15.1 | 1.15 H | 320 | 0.10 | 38.80 |

ANTENNA POLARITY & TEST DISTANCE: VERTICAL AT 3 M

| NO. | FREQ. (MHz) | EMISSION LEVEL (dBuV/m) | LIMIT (dBuV/m) | MARGIN (dB) | ANTENNA HEIGHT (m) | TABLE ANGLE (Degree) | RAW VALUE (dBuV) | CORRECTION FACTOR (dB/m) |
|-----|-------------|-------------------------|----------------|-------------|--------------------|----------------------|------------------|--------------------------|
| 1 | *2437.00 | 97.8 PK | | | 1.05 V | 316 | 65.30 | 32.50 |
| 2 | *2437.00 | 88.2 AV | | | 1.05 V | 316 | 55.70 | 32.50 |
| 3 | 2483.50 | 58.7 PK | 74.0 | -15.3 | 1.05 V | 316 | 26.00 | 32.70 |
| 4 | 2483.50 | 44.9 AV | 54.0 | -9.1 | 1.05 V | 316 | 12.20 | 32.70 |
| 5 | 4874.00 | 50.5 PK | 74.0 | -23.5 | 1.08 V | 332 | 11.70 | 38.80 |
| 6 | 4874.00 | 37.8 AV | 54.0 | -16.2 | 1.08 V | 332 | -1.00 | 38.80 |

- REMARKS:**
1. Emission level (dBuV/m) = Raw Value (dBuV) + Correction Factor (dB/m).
 2. Correction Factor (dB/m) = Antenna Factor (dB/m) + Cable Factor (dB).
 3. The other emission levels were very low against the limit.
 4. Margin value = Emission level – Limit value.
 5. “ * “: Fundamental frequency.



A D T

| EUT TEST CONDITION | | MEASUREMENT DETAIL | |
|--------------------------|-----------------|--------------------|---------------------------|
| CHANNEL | Channel 7 | FREQUENCY RANGE | 1 ~ 25GHz |
| INPUT POWER (SYSTEM) | 120Vac, 60 Hz | DETECTOR FUNCTION | Peak (PK) Average (AV) |
| ENVIRONMENTAL CONDITIONS | 25deg. C, 65%RH | TESTED BY | Antony Lee |

ANTENNA POLARITY & TEST DISTANCE: HORIZONTAL AT 3 M

| NO. | FREQ. (MHz) | EMISSION LEVEL (dBuV/m) | LIMIT (dBuV/m) | MARGIN (dB) | ANTENNA HEIGHT (m) | TABLE ANGLE (Degree) | RAW VALUE (dBuV) | CORRECTION FACTOR (dB/m) |
|-----|-------------|-------------------------|----------------|-------------|--------------------|----------------------|------------------|--------------------------|
| 1 | *2452.00 | 101.9 PK | | | 1.16 H | 311 | 69.30 | 32.60 |
| 2 | *2452.00 | 91.3 AV | | | 1.16 H | 311 | 58.70 | 32.60 |
| 3 | 2483.50 | 64.7 PK | 74.0 | -9.3 | 1.65 H | 302 | 32.00 | 32.70 |
| 4 | 2483.50 | 48.8 AV | 54.0 | -5.2 | 1.65 H | 302 | 16.10 | 32.70 |
| 5 | 4904.00 | 50.8 PK | 74.0 | -23.2 | 1.16 H | 321 | 11.90 | 38.90 |
| 6 | 4904.00 | 37.9 AV | 54.0 | -16.1 | 1.16 H | 321 | -1.00 | 38.90 |

ANTENNA POLARITY & TEST DISTANCE: VERTICAL AT 3 M

| NO. | FREQ. (MHz) | EMISSION LEVEL (dBuV/m) | LIMIT (dBuV/m) | MARGIN (dB) | ANTENNA HEIGHT (m) | TABLE ANGLE (Degree) | RAW VALUE (dBuV) | CORRECTION FACTOR (dB/m) |
|-----|-------------|-------------------------|----------------|-------------|--------------------|----------------------|------------------|--------------------------|
| 1 | *2452.00 | 95.3 PK | | | 1.05 V | 316 | 62.70 | 32.60 |
| 2 | *2452.00 | 85.3 AV | | | 1.05 V | 316 | 52.70 | 32.60 |
| 3 | 2483.50 | 59.0 PK | 74.0 | -15.0 | 1.05 V | 316 | 26.30 | 32.70 |
| 4 | 2483.50 | 46.4 AV | 54.0 | -7.6 | 1.05 V | 316 | 13.70 | 32.70 |
| 5 | 4904.00 | 48.8 PK | 74.0 | -25.2 | 1.20 V | 209 | 9.90 | 38.90 |
| 6 | 4904.00 | 37.2 AV | 54.0 | -16.8 | 1.20 V | 209 | -1.70 | 38.90 |

- REMARKS:**
1. Emission level (dBuV/m) = Raw Value (dBuV) + Correction Factor (dB/m).
 2. Correction Factor (dB/m) = Antenna Factor (dB/m) + Cable Factor (dB).
 3. The other emission levels were very low against the limit.
 4. Margin value = Emission level – Limit value.
 5. “ * “: Fundamental frequency.



A D T

BELOW 1GHz WORST-CASE DATA : 802.11g

| EUT TEST CONDITION | | MEASUREMENT DETAIL | |
|--------------------------|-----------------|--------------------|---------------|
| CHANNEL | Channel 11 | FREQUENCY RANGE | Below 1000MHz |
| INPUT POWER (SYSTEM) | 120Vac, 60 Hz | DETECTOR FUNCTION | Quasi-Peak |
| ENVIRONMENTAL CONDITIONS | 25deg. C, 65%RH | TESTED BY | Kay Wu |
| TEST MODE | A | | |

| ANTENNA POLARITY & TEST DISTANCE: HORIZONTAL AT 3 M | | | | | | | | |
|---|-------------|-------------------------|----------------|-------------|--------------------|----------------------|------------------|--------------------------|
| NO. | FREQ. (MHz) | EMISSION LEVEL (dBuV/m) | LIMIT (dBuV/m) | MARGIN (dB) | ANTENNA HEIGHT (m) | TABLE ANGLE (Degree) | RAW VALUE (dBuV) | CORRECTION FACTOR (dB/m) |
| 1 | 138.78 | 34.2 QP | 43.5 | -9.3 | 2.00 H | 277 | 20.20 | 14.00 |
| 2 | 195.16 | 35.3 QP | 43.5 | -8.2 | 1.50 H | 85 | 24.40 | 10.90 |
| 3 | 251.55 | 36.0 QP | 46.0 | -10.0 | 1.00 H | 67 | 22.90 | 13.10 |
| 4 | 307.93 | 32.1 QP | 46.0 | -13.9 | 1.00 H | 67 | 16.90 | 15.20 |
| 5 | 461.53 | 22.6 QP | 46.0 | -23.4 | 2.00 H | 37 | 3.20 | 19.40 |
| 6 | 547.08 | 27.3 QP | 46.0 | -18.7 | 2.50 H | 178 | 5.70 | 21.60 |
| ANTENNA POLARITY & TEST DISTANCE: VERTICAL AT 3 M | | | | | | | | |
| NO. | FREQ. (MHz) | EMISSION LEVEL (dBuV/m) | LIMIT (dBuV/m) | MARGIN (dB) | ANTENNA HEIGHT (m) | TABLE ANGLE (Degree) | RAW VALUE (dBuV) | CORRECTION FACTOR (dB/m) |
| 1 | 138.78 | 30.0 QP | 43.5 | -13.5 | 1.00 V | 241 | 16.00 | 14.00 |
| 2 | 195.16 | 28.7 QP | 43.5 | -14.8 | 1.50 V | 343 | 17.80 | 10.90 |
| 3 | 251.55 | 26.4 QP | 46.0 | -19.6 | 1.00 V | 325 | 13.30 | 13.10 |
| 4 | 307.93 | 27.6 QP | 46.0 | -18.4 | 1.50 V | 322 | 12.40 | 15.20 |
| 5 | 545.14 | 30.3 QP | 46.0 | -15.7 | 1.50 V | 301 | 8.70 | 21.60 |
| 6 | 675.40 | 30.3 QP | 46.0 | -15.7 | 1.50 V | 307 | 6.00 | 24.30 |

- REMARKS:**
1. Emission level (dBuV/m) = Raw Value (dBuV) + Correction Factor (dB/m).
 2. Correction Factor (dB/m) = Antenna Factor (dB/m) + Cable Factor (dB).
 3. The other emission levels were very low against the limit.
 4. Margin value = Emission level – Limit value.



A D T

| EUT TEST CONDITION | | MEASUREMENT DETAIL | |
|--------------------------|-----------------|--------------------|---------------|
| CHANNEL | Channel 11 | FREQUENCY RANGE | Below 1000MHz |
| INPUT POWER (SYSTEM) | 120Vac, 60 Hz | DETECTOR FUNCTION | Quasi-Peak |
| ENVIRONMENTAL CONDITIONS | 25deg. C, 65%RH | TESTED BY | Kay Wu |
| TEST MODE | B | | |

ANTENNA POLARITY & TEST DISTANCE: HORIZONTAL AT 3 M

| NO. | FREQ. (MHz) | EMISSION LEVEL (dBuV/m) | LIMIT (dBuV/m) | MARGIN (dB) | ANTENNA HEIGHT (m) | TABLE ANGLE (Degree) | RAW VALUE (dBuV) | CORRECTION FACTOR (dB/m) |
|-----|-------------|-------------------------|----------------|-------------|--------------------|----------------------|------------------|--------------------------|
| 1 | 41.57 | 30.6 QP | 40.0 | -9.4 | 3.00 H | 148 | 16.20 | 14.40 |
| 2 | 138.78 | 38.8 QP | 43.5 | -4.7 | 2.00 H | 55 | 24.80 | 14.00 |
| 3 | 251.55 | 37.8 QP | 46.0 | -8.2 | 1.00 H | 163 | 24.70 | 13.10 |
| 4 | 432.37 | 31.6 QP | 46.0 | -14.4 | 2.00 H | 85 | 13.00 | 18.60 |
| 5 | 667.63 | 32.9 QP | 46.0 | -13.1 | 1.50 H | 232 | 8.80 | 24.10 |
| 6 | 908.72 | 42.6 QP | 46.0 | -3.4 | 3.00 H | 10 | 14.80 | 27.80 |

ANTENNA POLARITY & TEST DISTANCE: VERTICAL AT 3 M

| NO. | FREQ. (MHz) | EMISSION LEVEL (dBuV/m) | LIMIT (dBuV/m) | MARGIN (dB) | ANTENNA HEIGHT (m) | TABLE ANGLE (Degree) | RAW VALUE (dBuV) | CORRECTION FACTOR (dB/m) |
|-----|-------------|-------------------------|----------------|-------------|--------------------|----------------------|------------------|--------------------------|
| 1 | 39.62 | 29.5 QP | 40.0 | -10.5 | 2.50 V | 61 | 15.20 | 14.30 |
| 2 | 239.88 | 28.5 QP | 46.0 | -17.5 | 1.50 V | 118 | 16.00 | 12.50 |
| 3 | 366.26 | 26.7 QP | 46.0 | -19.3 | 2.00 V | 40 | 9.90 | 16.80 |
| 4 | 432.37 | 28.3 QP | 46.0 | -17.7 | 1.50 V | 328 | 9.70 | 18.60 |
| 5 | 480.97 | 31.8 QP | 46.0 | -14.2 | 2.00 V | 184 | 11.80 | 20.00 |
| 6 | 959.27 | 36.2 QP | 46.0 | -9.8 | 1.50 V | 262 | 7.90 | 28.30 |

- REMARKS:**
1. Emission level (dBuV/m) = Raw Value (dBuV) + Correction Factor (dB/m).
 2. Correction Factor (dB/m) = Antenna Factor (dB/m) + Cable Factor (dB).
 3. The other emission levels were very low against the limit.
 4. Margin value = Emission level – Limit value.

4.2 CONDUCTED EMISSION MEASUREMENT

4.2.1 LIMITS OF CONDUCTED EMISSION MEASUREMENT

| FREQUENCY OF EMISSION (MHz) | CONDUCTED LIMIT (dB μ V) | |
|-----------------------------|------------------------------|----------|
| | Quasi-peak | Average |
| 0.15 ~ 0.5 | 66 to 56 | 56 to 46 |
| 0.5 ~ 5 | 56 | 46 |
| 5 ~ 30 | 60 | 50 |

- NOTE:**
1. The lower limit shall apply at the transition frequencies.
 2. The limit decreases in line with the logarithm of the frequency in the range of 0.15 to 0.50MHz.
 3. All emanations from a class A/B digital device or system, including any network of conductors and apparatus connected thereto, shall not exceed the level of field strengths specified above.

4.2.2 TEST INSTRUMENTS

| DESCRIPTION & MANUFACTURER | MODEL NO. | SERIAL NO. | DATE OF CALIBRATION | DUE DATE OF CALIBRATION |
|----------------------------------|---------------------|----------------|---------------------|-------------------------|
| Test Receiver ROHDE & SCHWARZ | ESCS30 | 100291 | Nov. 23, 2011 | Nov. 22, 2012 |
| RF signal cable Woken | 5D-FB | Cable-HYC01-01 | Dec. 30, 2010 | Dec. 29, 2011 |
| LISN ROHDE & SCHWARZ | ESH3-Z5 | 100312 | Jul. 07, 2011 | Jul. 06, 2012 |
| LISN ROHDE & SCHWARZ | ESH2-Z5 | 100100 | Jan. 06, 2011 | Jan. 05, 2012 |
| LISN ROHDE & SCHWARZ | ESH3-Z5 | 835239/001 | Feb. 22, 2011 | Feb. 21, 2012 |
| V-LISN SCHWARZBECK | NNBL 8226-2 | 8226-142 | Jun. 30, 2011 | Jun. 29, 2012 |
| LISN ROHDE & SCHWARZ | ENV216 | 100072 | Jun. 10, 2011 | Jun. 09, 2012 |
| Software ADT | ADT_Cond_ V7.3.7 | NA | NA | NA |

- NOTE:**
1. The calibration interval of the above test instruments is 12 months and the calibrations are traceable to NML/ROC and NIST/USA.
 2. The test was performed in HwaYa Shielded Room 1.
 3. The VCCI Site Registration No. is C-2040.

4.2.3 TEST PROCEDURES

- a. The EUT was placed 0.4 meters from the conducting wall of the shielded room with EUT being connected to the power mains through a line impedance stabilization network (LISN). Other support units were connected to the power mains through another LISN. The two LISNs provide 50 ohm/ 50uH of coupling impedance for the measuring instrument.
- b. Both lines of the power mains connected to the EUT were checked for maximum conducted interference.
- c. The frequency range from 150kHz to 30MHz was searched. Emission levels under (Limit - 20dB) was not recorded.

NOTE: All modes of operation were investigated and the worst-case emissions are reported.

4.2.4 DEVIATION FROM TEST STANDARD

No deviation.

4.2.5 TEST SETUP

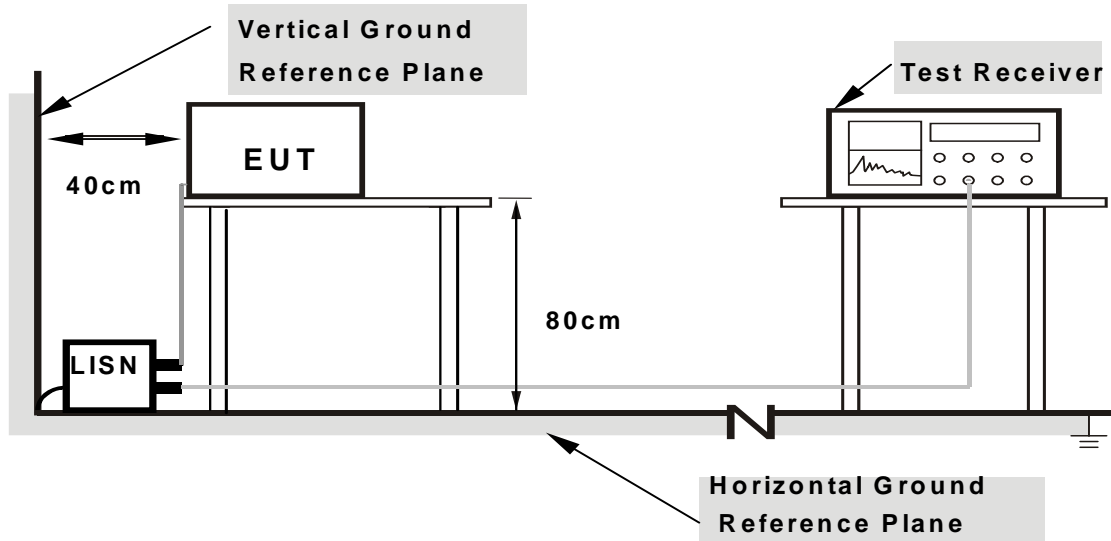

- Note:**
1. Support units were connected to second LISN.
 2. Both of LISNs (AMN) are 80 cm from EUT and at least 80 from other units and other metal planes

For the actual test configuration, please refer to the attached file (Test Setup Photo).

4.2.6 EUT OPERATING CONDITIONS

Same as 4.1.6.

4.2.7 TEST RESULTS

CONDUCTED WORST-CASE DATA : 802.11g

| | | | |
|-----------|--------|---------------|------|
| PHASE | Line 1 | 6dB BANDWIDTH | 9kHz |
| TEST MODE | A | | |

| No | Freq. [MHz] | Corr. Factor (dB) | Reading Value | | Emission Level | | Limit | | Margin | |
|----|----------------|----------------------|---------------|-------|----------------|-------|-----------|-------|--------|--------|
| | | | [dB (uV)] | | [dB (uV)] | | [dB (uV)] | | (dB) | |
| | | | Q.P. | AV. | Q.P. | AV. | Q.P. | AV. | Q.P. | AV. |
| 1 | 0.365 | 0.23 | 41.89 | 31.19 | 42.12 | 31.42 | 58.62 | 48.62 | -16.50 | -17.20 |
| 2 | 0.447 | 0.25 | 36.21 | 24.80 | 36.46 | 25.05 | 56.93 | 46.93 | -20.48 | -21.89 |
| 3 | 0.990 | 0.20 | 31.20 | 19.55 | 31.40 | 19.75 | 56.00 | 46.00 | -24.60 | -26.25 |
| 4 | 1.875 | 0.24 | 29.99 | 18.72 | 30.23 | 18.96 | 56.00 | 46.00 | -25.77 | -27.04 |
| 5 | 6.000 | 0.50 | 29.53 | 17.67 | 30.03 | 18.17 | 60.00 | 50.00 | -29.97 | -31.83 |
| 6 | 22.773 | 1.37 | 28.13 | 17.16 | 29.50 | 18.53 | 60.00 | 50.00 | -30.50 | -31.47 |

- REMARKS:**
1. Q.P. and AV. are abbreviations of quasi-peak and average individually.
 2. "-": The Quasi-peak reading value also meets average limit and measurement with the average detector is unnecessary.
 3. The emission levels of other frequencies were very low against the limit.
 4. Margin value = Emission level - Limit value
 5. Correction factor = Insertion loss + Cable loss
 6. Emission Level = Correction Factor + Reading Value.

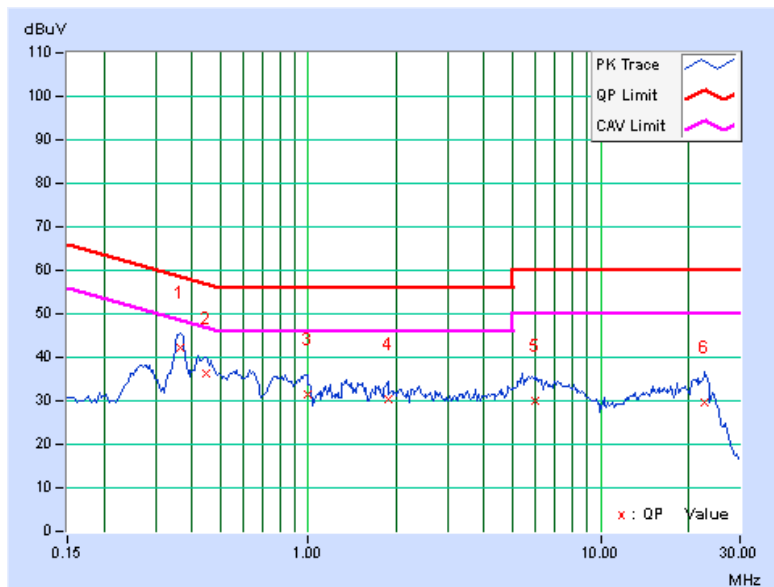

| | | | |
|-----------|--------|---------------|------|
| PHASE | Line 2 | 6dB BANDWIDTH | 9kHz |
| TEST MODE | A | | |

| No | Freq. [MHz] | Corr. Factor (dB) | Reading Value | | Emission Level | | Limit | | Margin | |
|----|----------------|----------------------|---------------|-------|----------------|-------|-----------|-------|--------|--------|
| | | | [dB (uV)] | | [dB (uV)] | | [dB (uV)] | | (dB) | |
| | | | Q.P. | AV. | Q.P. | AV. | Q.P. | AV. | Q.P. | AV. |
| 1 | 0.365 | 0.23 | 41.89 | 31.23 | 42.12 | 31.46 | 58.62 | 48.62 | -16.50 | -17.16 |
| 2 | 0.439 | 0.23 | 36.30 | 25.43 | 36.53 | 25.66 | 57.08 | 47.08 | -20.55 | -21.42 |
| 3 | 0.966 | 0.27 | 31.00 | 18.89 | 31.27 | 19.16 | 56.00 | 46.00 | -24.73 | -26.84 |
| 4 | 1.883 | 0.30 | 30.09 | 18.70 | 30.39 | 19.00 | 56.00 | 46.00 | -25.61 | -27.00 |
| 5 | 5.965 | 0.52 | 30.74 | 21.78 | 31.26 | 22.30 | 60.00 | 50.00 | -28.74 | -27.70 |
| 6 | 23.172 | 1.16 | 25.74 | 16.94 | 26.90 | 18.10 | 60.00 | 50.00 | -33.10 | -31.90 |

- REMARKS:**
1. Q.P. and AV. are abbreviations of quasi-peak and average individually.
 2. "-": The Quasi-peak reading value also meets average limit and measurement with the average detector is unnecessary.
 3. The emission levels of other frequencies were very low against the limit.
 4. Margin value = Emission level - Limit value
 5. Correction factor = Insertion loss + Cable loss
 6. Emission Level = Correction Factor + Reading Value.

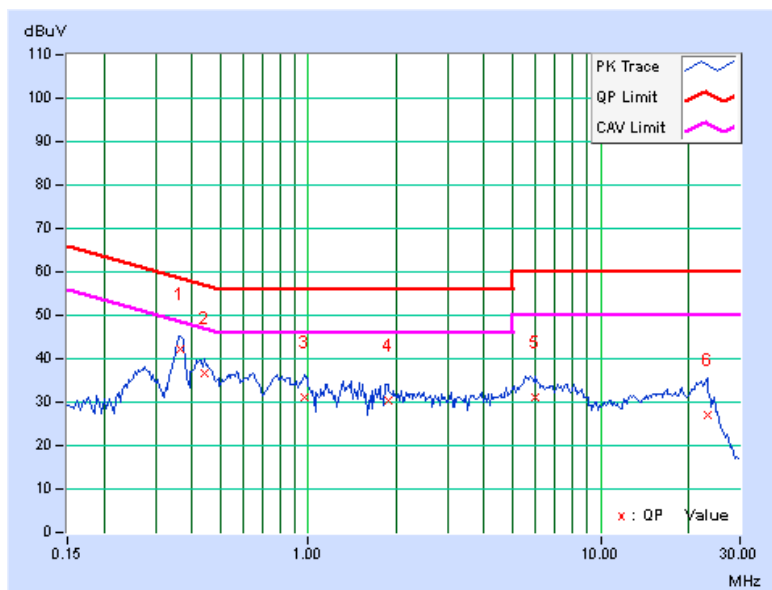

| | | | |
|------------------|--------|----------------------|------|
| PHASE | Line 1 | 6dB BANDWIDTH | 9kHz |
| TEST MODE | B | | |

| No | Freq. [MHz] | Corr. Factor (dB) | Reading Value | | Emission Level | | Limit | | Margin | |
|----|----------------|----------------------|---------------|-------|----------------|-------|-----------|-------|--------|--------|
| | | | [dB (uV)] | | [dB (uV)] | | [dB (uV)] | | (dB) | |
| | | | Q.P. | AV. | Q.P. | AV. | Q.P. | AV. | Q.P. | AV. |
| 1 | 0.166 | 0.16 | 52.32 | 27.84 | 52.48 | 28.00 | 65.18 | 55.18 | -12.70 | -27.18 |
| 2 | 0.216 | 0.15 | 44.45 | 20.44 | 44.60 | 20.59 | 62.96 | 52.96 | -18.36 | -32.37 |
| 3 | 0.357 | 0.23 | 29.30 | 11.96 | 29.53 | 12.19 | 58.80 | 48.80 | -29.27 | -36.61 |
| 4 | 1.879 | 0.24 | 29.52 | 19.40 | 29.76 | 19.64 | 56.00 | 46.00 | -26.24 | -26.36 |
| 5 | 3.820 | 0.38 | 23.94 | 16.54 | 24.32 | 16.92 | 56.00 | 46.00 | -31.68 | -29.08 |
| 6 | 10.926 | 0.75 | 28.30 | 23.28 | 29.05 | 24.03 | 60.00 | 50.00 | -30.95 | -25.97 |

- REMARKS:**
1. Q.P. and AV. are abbreviations of quasi-peak and average individually.
 2. "-": The Quasi-peak reading value also meets average limit and measurement with the average detector is unnecessary.
 3. The emission levels of other frequencies were very low against the limit.
 4. Margin value = Emission level - Limit value
 5. Correction factor = Insertion loss + Cable loss
 6. Emission Level = Correction Factor + Reading Value.

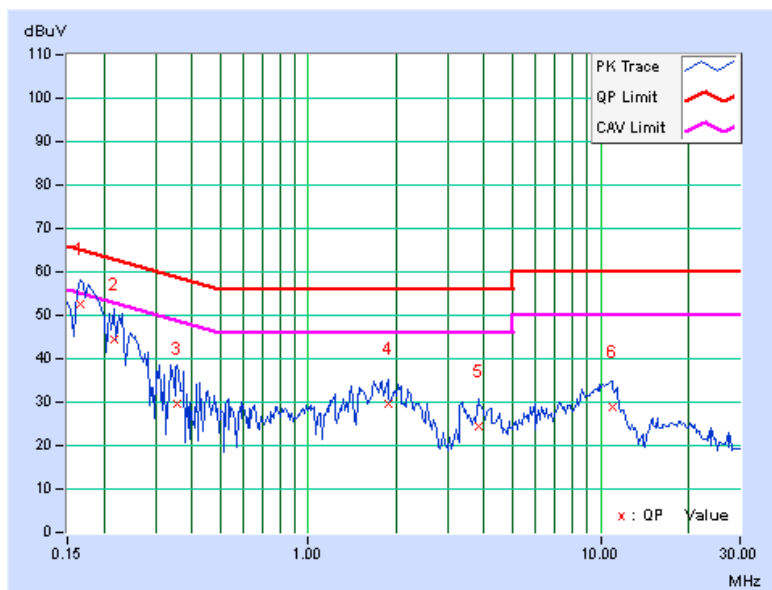

| | | | |
|-----------|--------|---------------|------|
| PHASE | Line 2 | 6dB BANDWIDTH | 9kHz |
| TEST MODE | B | | |

| No | Freq. [MHz] | Corr. Factor (dB) | Reading Value | | Emission Level | | Limit | | Margin | |
|----|----------------|----------------------|---------------|-------|----------------|-------|-----------|-------|--------|--------|
| | | | [dB (uV)] | | [dB (uV)] | | [dB (uV)] | | (dB) | |
| | | | Q.P. | AV. | Q.P. | AV. | Q.P. | AV. | Q.P. | AV. |
| 1 | 0.154 | 0.22 | 54.45 | 28.88 | 54.67 | 29.10 | 65.79 | 55.79 | -11.11 | -26.68 |
| 2 | 0.205 | 0.21 | 45.64 | 24.99 | 45.85 | 25.20 | 63.42 | 53.42 | -17.57 | -28.22 |
| 3 | 0.287 | 0.22 | 32.19 | 10.92 | 32.41 | 11.14 | 60.62 | 50.62 | -28.21 | -39.48 |
| 4 | 0.408 | 0.23 | 25.41 | 5.44 | 25.64 | 5.67 | 57.69 | 47.69 | -32.05 | -42.02 |
| 5 | 1.695 | 0.29 | 28.23 | 15.18 | 28.52 | 15.47 | 56.00 | 46.00 | -27.48 | -30.53 |
| 6 | 10.625 | 0.71 | 28.47 | 23.15 | 29.18 | 23.86 | 60.00 | 50.00 | -30.82 | -26.14 |

- REMARKS:**
1. Q.P. and AV. are abbreviations of quasi-peak and average individually.
 2. "-": The Quasi-peak reading value also meets average limit and measurement with the average detector is unnecessary.
 3. The emission levels of other frequencies were very low against the limit.
 4. Margin value = Emission level - Limit value
 5. Correction factor = Insertion loss + Cable loss
 6. Emission Level = Correction Factor + Reading Value.

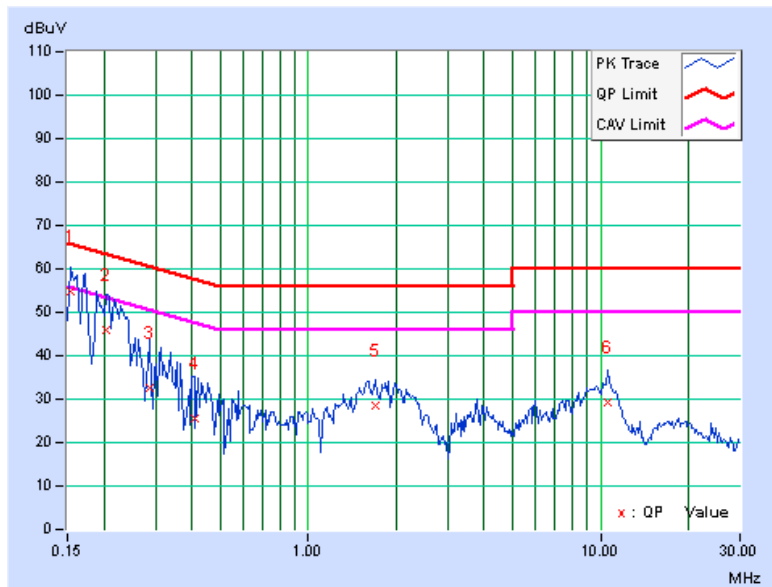

4.3 6dB BANDWIDTH MEASUREMENT

4.3.1 LIMITS OF 6dB BANDWIDTH MEASUREMENT

The minimum of 6dB Bandwidth Measurement is 0.5 MHz.

4.3.2 TEST SETUP

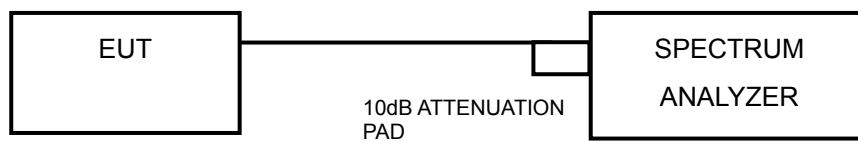

4.3.3 TEST INSTRUMENTS

Refer to section 4.1.2 to get information of above instrument.

4.3.4 TEST PROCEDURE

1. Set resolution bandwidth (RBW) = approximately 1% of the emission bandwidth
2. Set the video bandwidth (VBW) $\geq 3 \times$ RBW, Detector = Peak.
3. Trace mode = max hold.
4. Sweep = auto couple.
5. Measure the maximum width of the emission that is constrained by the frequencies associated with the two amplitude points (upper and lower) that are attenuated by 6 dB relative to the maximum level measured in the fundamental emission

4.3.5 DEVIATION FROM TEST STANDARD

No deviation.

4.3.6 EUT OPERATING CONDITIONS

The software provided by client to enable the EUT under transmission condition continuously at lowest, middle and highest channel frequencies individually.

4.3.7 TEST RESULTS

802.11b

| CHANNEL | FREQUENCY (MHz) | 6dB BANDWIDTH (MHz) | MINIMUM LIMIT (MHz) | PASS / FAIL |
|---------|-----------------|---------------------|---------------------|-------------|
| 1 | 2412 | 10.27 | 0.5 | PASS |
| 6 | 2437 | 10.27 | 0.5 | PASS |
| 11 | 2462 | 9.66 | 0.5 | PASS |

802.11g

| CHANNEL | FREQUENCY (MHz) | 6dB BANDWIDTH (MHz) | MINIMUM LIMIT (MHz) | PASS / FAIL |
|---------|-----------------|---------------------|---------------------|-------------|
| 1 | 2412 | 16.93 | 0.5 | PASS |
| 6 | 2437 | 16.74 | 0.5 | PASS |
| 11 | 2462 | 16.85 | 0.5 | PASS |

802.11n (20MHz)

| CHANNEL | FREQUENCY (MHz) | 6dB BANDWIDTH (MHz) | MINIMUM LIMIT (MHz) | PASS / FAIL |
|---------|-----------------|---------------------|---------------------|-------------|
| 1 | 2412 | 17.91 | 0.5 | PASS |
| 6 | 2437 | 17.83 | 0.5 | PASS |
| 11 | 2462 | 17.85 | 0.5 | PASS |

802.11n (40MHz)

| CHANNEL | FREQUENCY (MHz) | 6dB BANDWIDTH (MHz) | MINIMUM LIMIT (MHz) | PASS / FAIL |
|---------|-----------------|---------------------|---------------------|-------------|
| 1 | 2422 | 36.69 | 0.5 | PASS |
| 4 | 2437 | 36.67 | 0.5 | PASS |
| 7 | 2452 | 36.61 | 0.5 | PASS |

4.4 CONDUCTED OUTPUT POWER

4.4.1 LIMITS OF CONDUCTED OUTPUT POWER MEASUREMENT

For systems using digital modulation in the 2400–2483.5 MHz: 1 Watt (30dBm)

4.4.2 TEST SETUP

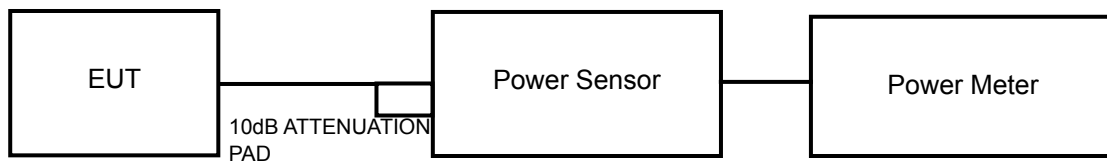

4.4.3 TEST INSTRUMENTS

Refer to section 4.1.2 to get information of above instrument.

4.4.4 TEST PROCEDURES

A power sensor was used on the output port of the EUT. A power meter was used to read the response of the power sensor. Record the power level.

4.4.5 DEVIATION FROM TEST STANDARD

No deviation.

4.4.6 EUT OPERATING CONDITIONS

Same as Item 4.3.6.



4.4.7 TEST RESULTS

802.11b

| CHANNEL | FREQUENCY (MHz) | PEAK POWER (mW) | PEAK POWER (dBm) | LIMIT (dBm) | PASS/FAIL |
|---------|-----------------|-----------------|------------------|-------------|-----------|
| 1 | 2412 | 15.2 | 11.82 | 30 | PASS |
| 6 | 2437 | 18.4 | 12.64 | 30 | PASS |
| 11 | 2462 | 21.1 | 13.24 | 30 | PASS |

802.11g

| CHANNEL | FREQUENCY (MHz) | PEAK POWER (mW) | PEAK POWER (dBm) | LIMIT (dBm) | PASS/FAIL |
|---------|-----------------|-----------------|------------------|-------------|-----------|
| 1 | 2412 | 318.4 | 25.03 | 30 | PASS |
| 6 | 2437 | 332.7 | 25.22 | 30 | PASS |
| 11 | 2462 | 338.8 | 25.30 | 30 | PASS |

802.11n (20MHz)

| CHANNEL | FREQUENCY (MHz) | PEAK POWER (mW) | PEAK POWER (dBm) | LIMIT (dBm) | PASS/FAIL |
|---------|-----------------|-----------------|------------------|-------------|-----------|
| 1 | 2412 | 325.1 | 25.12 | 30 | PASS |
| 6 | 2437 | 258.8 | 24.13 | 30 | PASS |
| 11 | 2462 | 326.6 | 25.14 | 30 | PASS |

802.11n (40MHz)

| CHANNEL | FREQUENCY (MHz) | PEAK POWER (mW) | PEAK POWER (dBm) | LIMIT (dBm) | PASS/FAIL |
|---------|-----------------|-----------------|------------------|-------------|-----------|
| 1 | 2422 | 175.4 | 22.44 | 30 | PASS |
| 4 | 2437 | 163.3 | 22.13 | 30 | PASS |
| 7 | 2452 | 155.6 | 21.92 | 30 | PASS |

4.5 POWER SPECTRAL DENSITY MEASUREMENT

4.5.1 LIMITS OF POWER SPECTRAL DENSITY MEASUREMENT

The Maximum of Power Spectral Density Measurement is 8dBm.

4.5.2 TEST SETUP

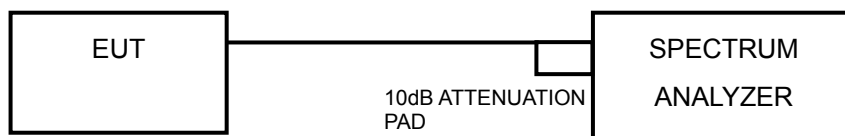

4.5.3 TEST INSTRUMENTS

Refer to section 4.1.2 to get information of above instrument.

4.5.4 TEST PROCEDURE

1. Set the RBW = 100 kHz, VBW =300 kHz, Detector = peak.
2. Sweep time = auto couple, Trace mode = max hold, allow trace to fully stabilize.
3. Use the peak marker function to determine the maximum power level in any 100 kHz band segment within the fundamental EBW.
4. Scale the observed power level to an equivalent value in 3 kHz by adjusting (reducing) the measured power by a bandwidth correction factor (BWCF) where $BWCF = 10\log(3 \text{ kHz}/100\text{kHz})$

4.5.5 DEVIATION FROM TEST STANDARD

No deviation.

4.5.6 EUT OPERATING CONDITION

Same as Item 4.3.6



4.5.7 TEST RESULTS

802.11b

| Channel | FREQ. (MHz) | PSD (dBm/100kHz) | PSD (dBm/3kHz) | Limit (dBm/3kHz) | PASS /FAIL |
|---------|-------------|------------------|----------------|------------------|------------|
| 1 | 2412 | -0.20 | -15.43 | 8 | PASS |
| 6 | 2437 | 0.73 | -14.50 | 8 | PASS |
| 11 | 2462 | 1.30 | -13.93 | 8 | PASS |

802.11g

| Channel | FREQ. (MHz) | PSD (dBm/100kHz) | PSD (dBm/3kHz) | Limit (dBm/3kHz) | PASS /FAIL |
|---------|-------------|------------------|----------------|------------------|------------|
| 1 | 2412 | 0.71 | -14.52 | 8 | PASS |
| 6 | 2437 | 0.83 | -14.40 | 8 | PASS |
| 11 | 2462 | 0.93 | -14.30 | 8 | PASS |

802.11n (20MHz)

| Channel | FREQ. (MHz) | PSD (dBm/100kHz) | PSD (dBm/3kHz) | Limit (dBm/3kHz) | PASS /FAIL |
|---------|-------------|------------------|----------------|------------------|------------|
| 1 | 2412 | 1.97 | -13.26 | 8 | PASS |
| 6 | 2437 | 0.95 | -14.28 | 8 | PASS |
| 11 | 2462 | 1.91 | -13.32 | 8 | PASS |

802.11n (40MHz)

| Channel | FREQ. (MHz) | PSD (dBm/100kHz) | PSD (dBm/3kHz) | Limit (dBm/3kHz) | PASS /FAIL |
|---------|-------------|------------------|----------------|------------------|------------|
| 1 | 2422 | -3.04 | -18.27 | 8 | PASS |
| 4 | 2437 | -3.31 | -18.54 | 8 | PASS |
| 7 | 2452 | -3.65 | -18.88 | 8 | PASS |

4.6 CONDUCTED EMISSION MEASUREMENT

4.6.1 LIMITS OF BAND EDGES MEASUREMENT

Below -20dB of the highest emission level of operating band (in 100kHz Resolution Bandwidth).

4.6.2 TEST SETUP

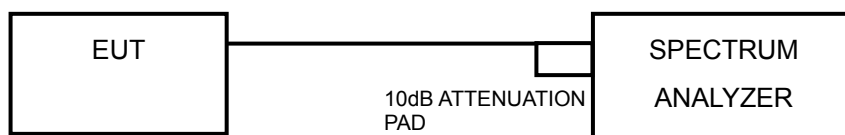

4.6.3 TEST INSTRUMENTS

Refer to section 4.1.2 to get information of above instrument.

4.6.4 TEST PROCEDURE

MEASUREMENT PROCEDURE REF

1. Set the RBW = 100 kHz.
2. Set the VBW \geq 300 kHz.
3. Detector = peak.
4. Sweep time = auto couple.
5. Trace mode = max hold.
6. Allow trace to fully stabilize.
7. Use the peak marker function to determine the maximum power level in any 100 kHz band segment within the fundamental EBW.

MEASUREMENT PROCEDURE OOB

1. Set RBW = 100 kHz.
2. Set VBW \geq 300 kHz.
3. Set span to encompass the spectrum to be examined.
4. Detector = peak.
5. Trace Mode = max hold.
6. Sweep = auto couple.

4.6.5 DEVIATION FROM TEST STANDARD

No deviation.

4.6.6 EUT OPERATING CONDITION

Same as Item 4.3.6

4.6.7 TEST RESULTS

The spectrum plots are attached on the following pages. D1 line indicates the highest level, and D2 line indicates the 20dB offset below D1. It shows compliance with the requirement in part 15.247(d).

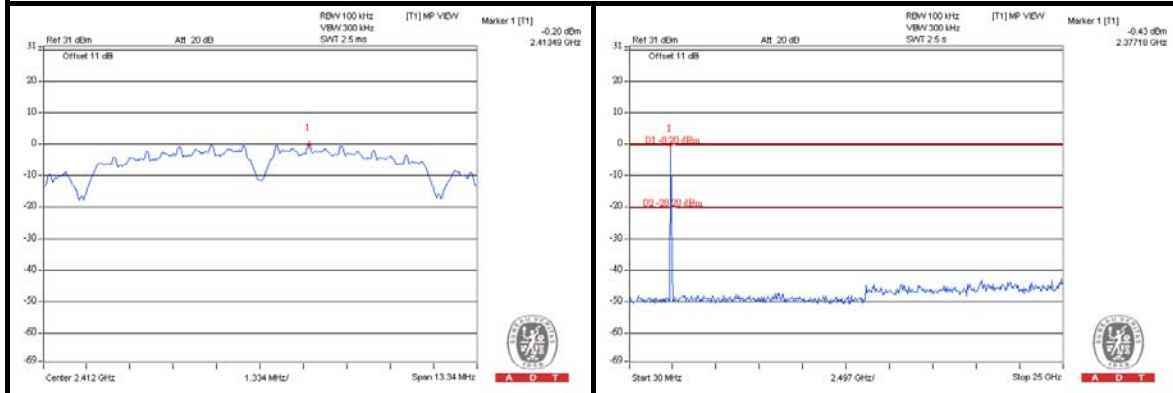
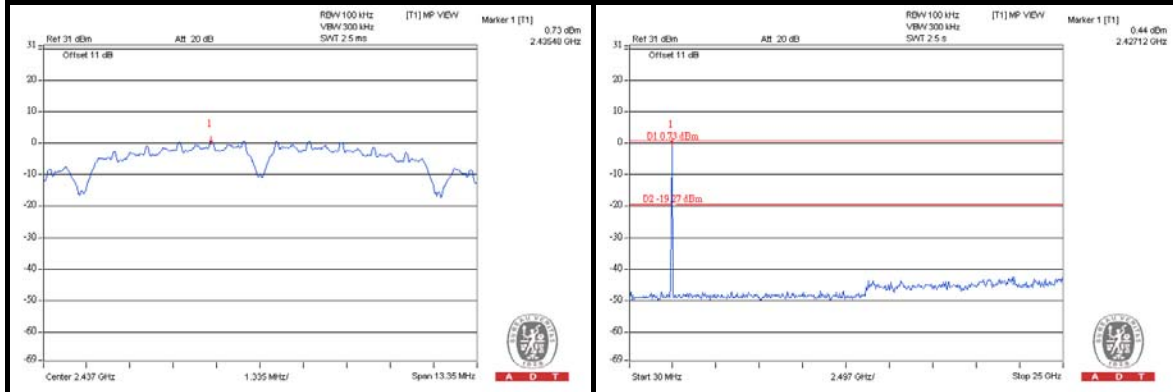
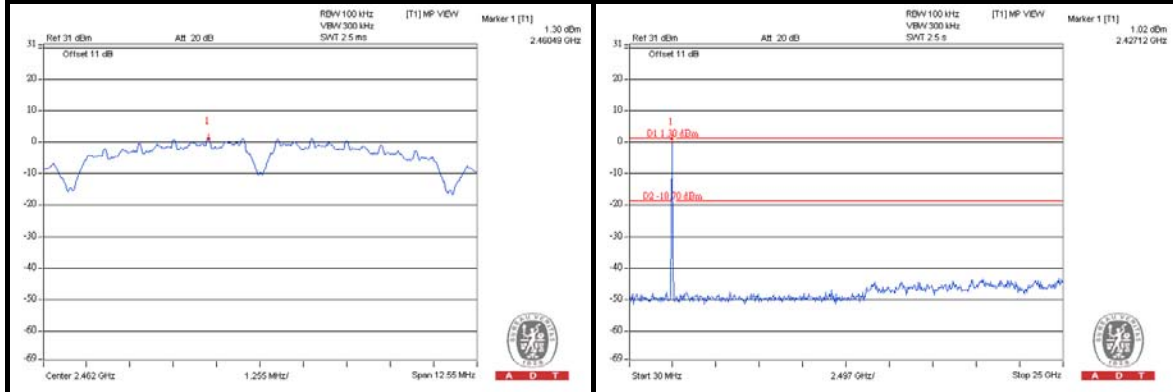
802.11b**CH 1****CH 6****CH 11**

802.11g

CH 1

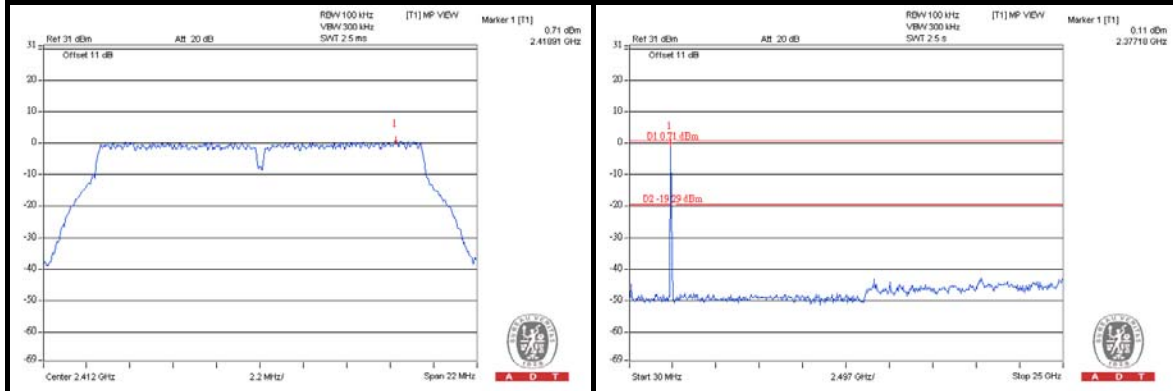

CH 6

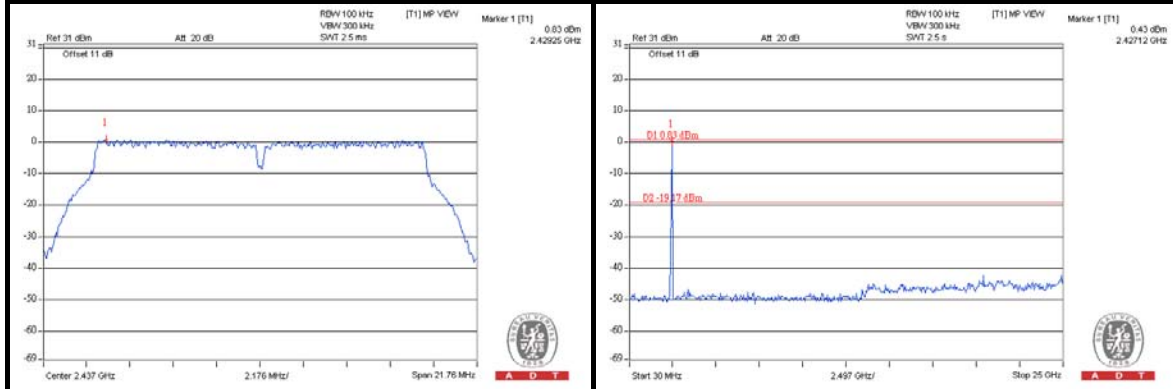

CH 11

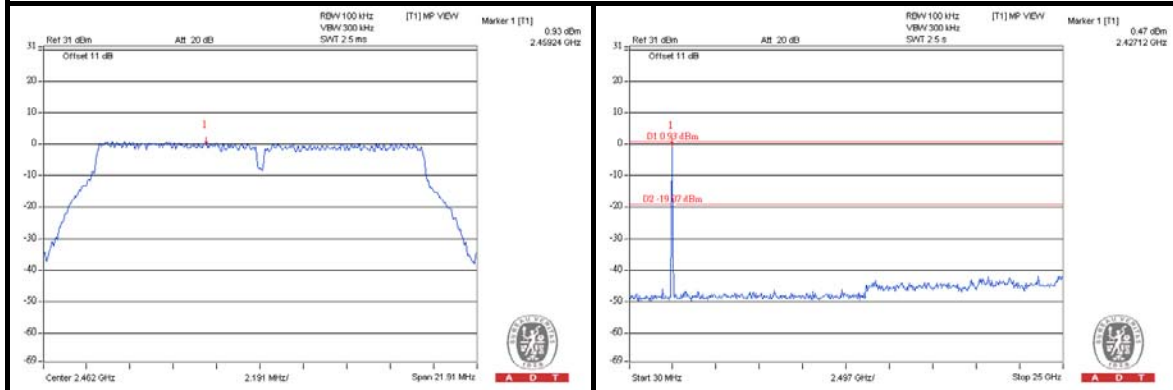

802.11n (20MHz)

CH 1

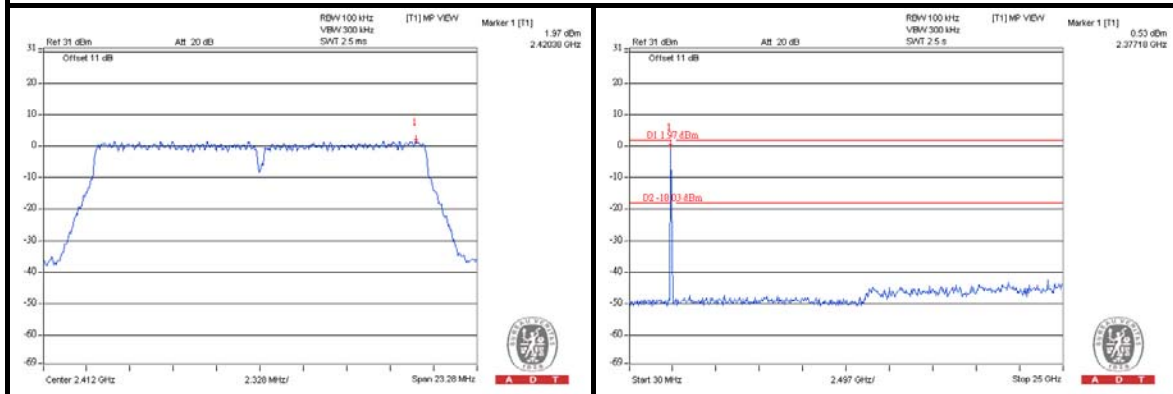

CH 6

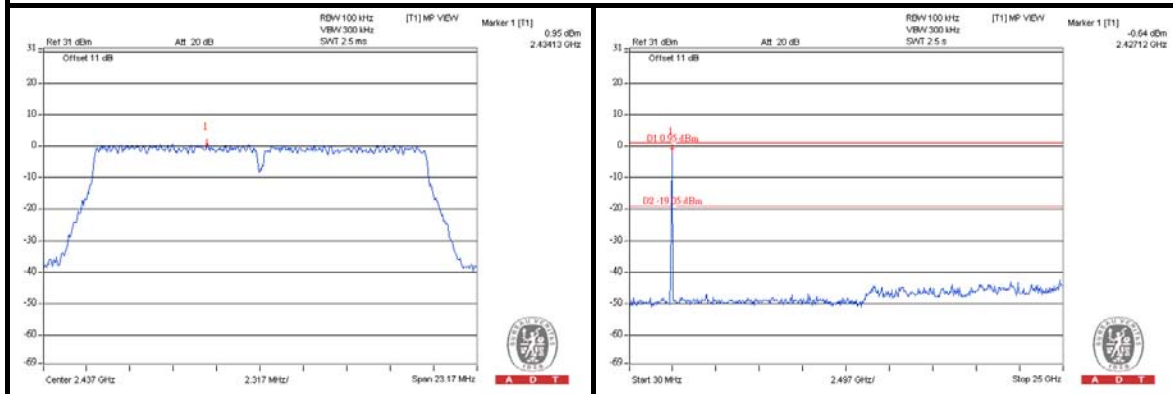

CH 11

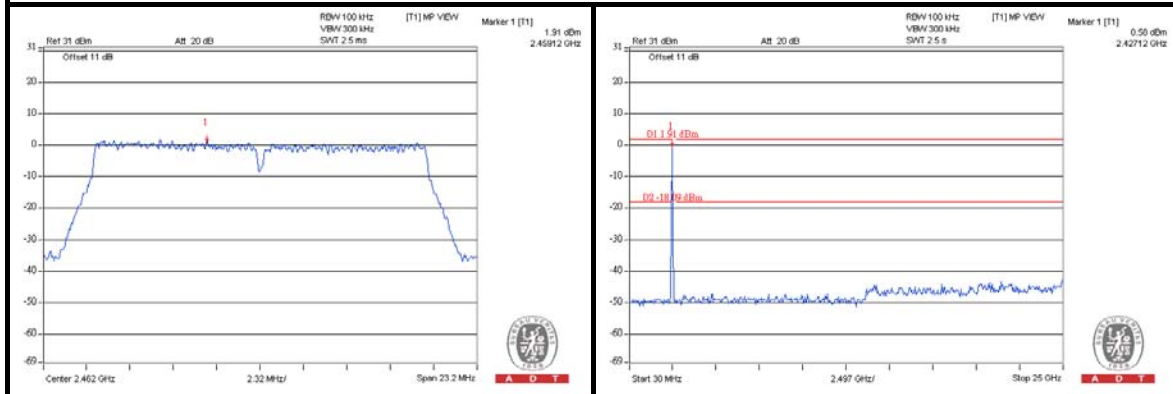

802.11n (40MHz)

CH 1

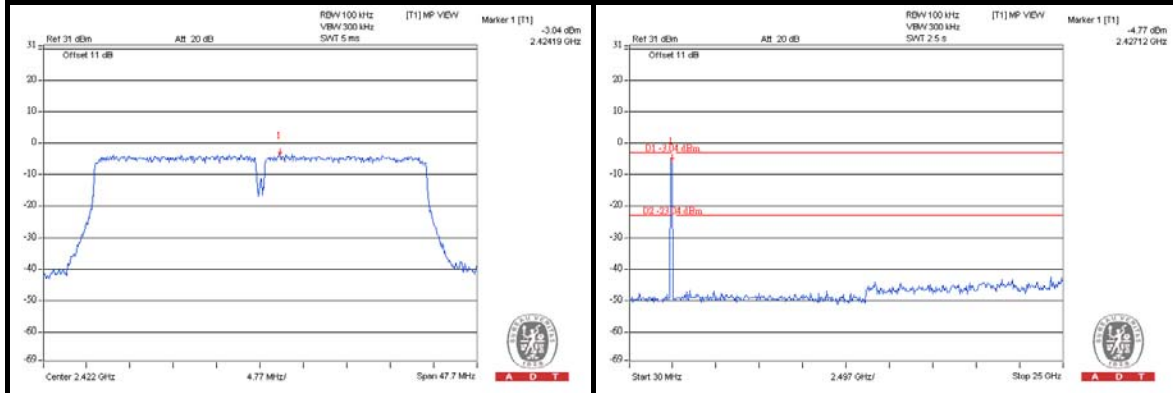

CH 4

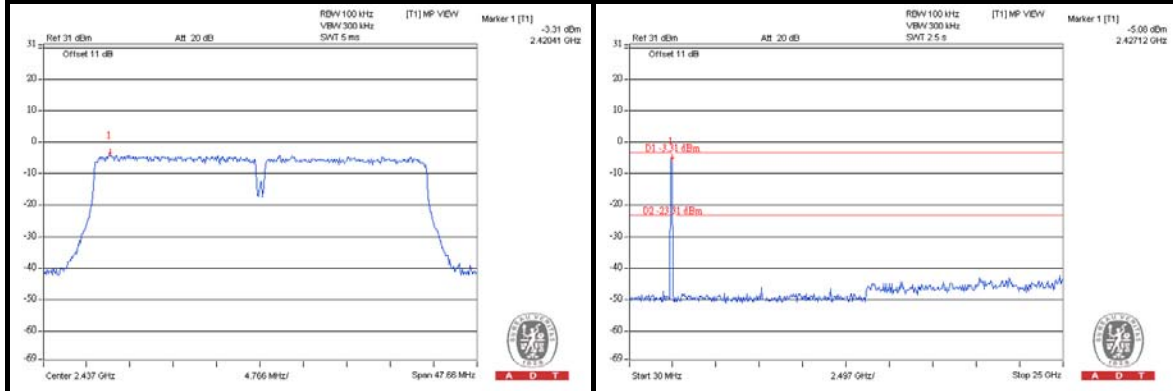

CH 7

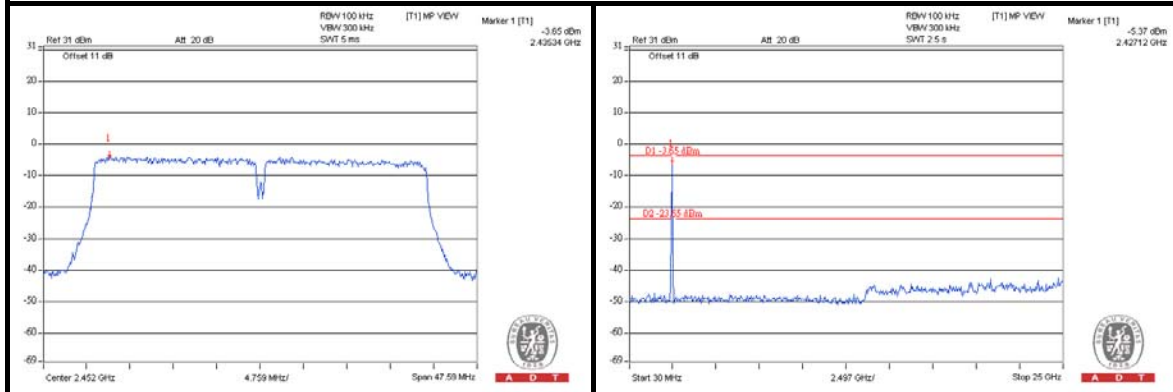

5. PHOTOGRAPHS OF THE TEST CONFIGURATION

Please refer to the attached file (Test Setup Photo).



6. INFORMATION ON THE TESTING LABORATORIES

We, Bureau Veritas Consumer Products Services (H.K.) Ltd., Taoyuan Branch, were founded in 1988 to provide our best service in EMC, Radio, Telecom and Safety consultation. Our laboratories are accredited and approved according to ISO/IEC 17025.

Copies of accreditation and authorization certificates of our laboratories obtained from approval agencies can be downloaded from our web site: www.adt.com.tw/index.5.phtml. If you have any comments, please feel free to contact us at the following:

Linko EMC/RF Lab

Tel: 886-2-26052180

Fax: 886-2-26051924

Hsin Chu EMC/RF Lab

Tel: 886-3-5935343

Fax: 886-3-5935342

Hwa Ya EMC/RF/Safety/Telecom Lab

Tel: 886-3-3183232

Fax: 886-3-3185050

Email: service.adt@tw.bureauveritas.com

Web Site: www.adt.com.tw

The address and road map of all our labs can be found in our web site also.

7. APPENDIX A - MODIFICATIONS RECORDERS FOR ENGINEERING CHANGES TO THE EUT BY THE LAB

No modifications were made to the EUT by the lab during the test.

---END---