



FCC TEST REPORT (Bluetooth)

REPORT NO.: RF111121C23-1

MODEL NO.: WIXHSM-100

FCC ID: MXF- WIXHSM-100

RECEIVED: Nov. 21, 2011

TESTED: Dec. 15 ~ Dec. 17, 2011

ISSUED: Dec. 20, 2011

APPLICANT: Gemtek Technology Co., Ltd.

ADDRESS: No. 15-1, Zhonghua Rd, Hsinchu Industrial Park,
Hsinchu County, Taiwan, R.O.C. 303

ISSUED BY: Bureau Veritas Consumer Products Services (H.K.)
Ltd., Taoyuan Branch

LAB ADDRESS: No. 47, 14th Ling, Chia Pau Vil., Lin Kou Dist., New
Taipei City, Taiwan (R.O.C)

TEST LOCATION: No. 19, Hwa Ya 2nd Rd, Wen Hwa Tsuen, Kwei
Shan Hsiang, Taoyuan Hsien 333, Taiwan, R.O.C.

This test report consists of 63 pages in total. It may be duplicated completely for legal use with the approval of the applicant. It should not be reproduced except in full, without the written approval of our laboratory. The client should not use it to claim product certification, approval or endorsement by TAF or any government agency. The test results in the report only apply to the tested sample.





TABLE OF CONTENTS

RELEASE CONTROL RECORD.....	4
1. CERTIFICATION	5
2. SUMMARY OF TEST RESULTS	6
2.1 MEASUREMENT UNCERTAINTY.....	6
3. GENERAL INFORMATION.....	7
3.1 GENERAL DESCRIPTION OF EUT	7
3.2 DESCRIPTION OF TEST MODES.....	8
3.2.1 CONFIGURATION OF SYSTEM UNDER TEST	9
3.2.2 TEST MODE APPLICABILITY AND TESTED CHANNEL DETAIL	10
3.3 GENERAL DESCRIPTION OF APPLIED STANDARDS	11
3.4 DESCRIPTION OF SUPPORT UNITS	12
4. TEST TYPES AND RESULTS	13
4.1 RADIATED EMISSION MEASUREMENT	13
4.1.1 LIMITS OF RADIATED EMISSION MEASUREMENT	13
4.1.2 TEST INSTRUMENTS.....	14
4.1.3 TEST PROCEDURES	15
4.1.4 DEVIATION FROM TEST STANDARD	15
4.1.5 TEST SETUP.....	16
4.1.6 EUT OPERATING CONDITIONS	16
4.1.7 TEST RESULTS	17
4.2 CONDUCTED EMISSION MEASUREMENT	27
4.2.1 LIMITS OF CONDUCTED EMISSION MEASUREMENT.....	27
4.2.2 TEST INSTRUMENTS.....	27
4.2.3 TEST PROCEDURES	28
4.2.4 DEVIATION FROM TEST STANDARD	28
4.2.5 TEST SETUP.....	29
4.2.6 EUT OPERATING CONDITIONS	29
4.2.7 TEST RESULTS	30
4.3 NUMBER OF HOPPING FREQUENCY USED	34
4.3.1 LIMIT OF HOPPING FREQUENCY USED.....	34
4.3.2 TEST SETUP.....	34
4.3.3 TEST INSTRUMENTS.....	34
4.3.4 TEST PROCEDURES	34
4.3.5 DEVIATION FROM TEST STANDARD	34
4.3.6 TEST RESULTS	34
4.4 DWELL TIME ON EACH CHANNEL	37
4.4.1 LIMIT OF DWELL TIME USED.....	37
4.4.2 TEST SETUP.....	37
4.4.3 TEST INSTRUMENTS.....	37
4.4.4 TEST PROCEDURES	37
4.4.5 DEVIATION FROM TEST STANDARD	37
4.4.6 TEST RESULTS	38
4.5 CHANNEL BANDWIDTH.....	46
4.5.1 LIMITS OF CHANNEL BANDWIDTH	46
4.5.2 TEST SETUP.....	46
4.5.3 TEST INSTRUMENTS.....	46
4.5.4 TEST PROCEDURE.....	46
4.5.5 DEVIATION FROM TEST STANDARD	46
4.5.6 EUT OPERATING CONDITION	46



A D T

4.5.7	TEST RESULTS	47
4.6	HOPPING CHANNEL SEPARATION	49
4.6.1	LIMIT OF HOPPING CHANNEL SEPARATION	49
4.6.2	TEST SETUP.....	49
4.6.3	TEST INSTRUMENTS.....	49
4.6.4	TEST PROCEDURES	49
4.6.5	DEVIATION FROM TEST STANDARD	49
4.6.6	TEST RESULTS	50
4.7	MAXIMUM OUTPUT POWER.....	51
4.7.1	LIMITS OF MAXIMUM OUTPUT POWER MEASUREMENT	51
4.7.2	TEST SETUP.....	51
4.7.3	TEST INSTRUMENTS.....	51
4.7.4	TEST PROCEDURES	51
4.7.5	DEVIATION FROM TEST STANDARD	51
4.7.6	EUT OPERATING CONDITION	51
4.7.7	TEST RESULTS	52
4.8	BAND EDGES MEASUREMENT	54
4.8.1	LIMITS OF BAND EDGES MEASUREMENT.....	54
4.8.2	TEST INSTRUMENTS.....	54
4.8.3	TEST PROCEDURE.....	54
4.8.4	DEVIATION FROM TEST STANDARD	54
4.8.5	EUT OPERATING CONDITION	54
4.8.6	TEST RESULTS	55
5.	PHOTOGRAPHS OF THE TEST CONFIGURATION.....	61
6.	INFORMATION ON THE TESTING LABORATORIES	62
7.	APPENDIX A - MODIFICATIONS RECORDERS FOR ENGINEERING CHANGES TO THE EUT BY THE LAB.....	63



A D T

RELEASE CONTROL RECORD

ISSUE NO.	REASON FOR CHANGE	DATE ISSUED
Original release	NA	Dec. 20, 2011

1. CERTIFICATION

PRODUCT: WiMAX Smart Phone

MODEL: WIXHSM-100

BRAND: Gemtek

APPLICANT: Gemtek Technology Co., Ltd.

TESTED: Dec. 15 ~ Dec. 17, 2011

TEST SAMPLE: ENGINEERING SAMPLE

STANDARDS: **FCC Part 15, Subpart C (Section 15.247)**

ANSI C63.4-2003

ANSI C63.10-2009

The above equipment (model: WIXHSM-100) have been tested by **Bureau Veritas Consumer Products Services (H.K.) Ltd., Taoyuan Branch**, and found compliance with the requirement of the above standards. The test record, data evaluation & Equipment Under Test (EUT) configurations represented herein are true and accurate accounts of the measurements of the sample's EMC characteristics under the conditions specified in this report.

PREPARED BY :  , DATE: Dec. 20, 2011
Pettie Chen / Specialist

APPROVED BY :  , DATE: Dec. 20, 2011
Gary Chang / Technical Manager

2. SUMMARY OF TEST RESULTS

The EUT has been tested according to the following specifications:

APPLIED STANDARD: FCC Part 15, Subpart C			
STANDARD SECTION	TEST TYPE AND LIMIT	RESULT	REMARK
15.207	AC Power Conducted Emission	PASS	Meet the requirement of limit. Minimum passing margin is -16.23dB at 0.369MHz.
15.247(a)(1)(iii)	Number of Hopping Frequency Used	PASS	Meet the requirement of limit.
15.247(a)(1)(iii)	Dwell Time on Each Channel	PASS	Meet the requirement of limit.
15.247(a)(1)	1. Hopping Channel Separation 2. Spectrum Bandwidth of a Frequency Hopping Sequence Spread Spectrum System	PASS	Meet the requirement of limit.
15.247(b)	Maximum Peak Output Power	PASS	Meet the requirement of limit.
15.247(d)	Transmitter Radiated Emissions	PASS	Meet the requirement of limit. Minimum passing margin is -3.8dB at 138.78MHz.
15.247(d)	Band Edge Measurement	PASS	Meet the requirement of limit.
15.203	Antenna Requirement	PASS	No antenna connector is used.

NOTE: If The Frequency Hopping System operating in 2400-2483.5MHz band and the output power less than 125mW. The hopping channel carrier frequencies separated by a minimum of 25kHz or two-thirds of the 20dB bandwidth of hopping channel whichever is greater.

2.1 MEASUREMENT UNCERTAINTY

Where relevant, the following measurement uncertainty levels have been estimated for tests performed on the EUT as specified in CISPR 16-4-2:

MEASUREMENT	FREQUENCY	UNCERTAINTY
Conducted emissions	150kHz~30MHz	2.44 dB
Radiated emissions	30MHz ~ 200MHz	3.19 dB
	200MHz ~1000MHz	3.21 dB
	1GHz ~ 18GHz	2.26 dB
	18GHz ~ 40GHz	1.94 dB

This uncertainty represents an expanded uncertainty expressed at approximately the 95% confidence level using a coverage factor of $k = 2$.

3. GENERAL INFORMATION

3.1 GENERAL DESCRIPTION OF EUT

EUT	WiMAX Smart Phone
MODEL NO.	WIXHSM-100
FCC ID	MXF-WIXHSM-100
POWER SUPPLY	5.0Vdc (adapter or host equipment) 3.7Vdc (battery)
MODULATION TYPE	GFSK, $\pi/4$ -DQPSK, 8DPSK
MODULATION TECHNOLOGY	FHSS
TRANSFER RATE	1/2/3Mbps
FREQUENCY RANGE	2402 ~ 2480MHz
NUMBER OF CHANNEL	79
MAX. OUTPUT POWER	8.017mW
ANTENNA TYPE	Printed antenna with 0dBi gain
ANTENNA CONNECTOR	NA
DATA CABLE	1.2 m shielded USB cable without core
I/O PORTS	Refer to user's manual
ACCESSORY DEVICES	Battery, Adapter, Earphone (1.3m non-shielded w/o core)

NOTE:

- The EUT was powered by the following adapters and battery:

ADAPTER 1	
BRAND:	DVE
MODEL:	DSC-5PFC-05 FUS 050100 DSC-5PFC-05 FUS 052100 (For Marketing different)
INPUT:	100-240Vac, 50-60Hz, 0.2A
OUTPUT:	5Vdc, 1A

ADAPTER 2	
BRAND:	SPPS Travel Charger
MODEL:	LFS0501000D-A8S
INPUT:	100-240Vac, 50-60Hz
OUTPUT:	5Vdc, 1000mA

*After pre-testing, adapter 1 was the worst for final test.

BATTERY	
BRAND:	Skypower
MODEL:	GT-1920
RATING:	3.7Vdc, 1920 mAh

- The above EUT information is declared by manufacturer and for more detailed features description, please refer to the manufacturer's specifications or user's manual.

3.2 DESCRIPTION OF TEST MODES

79 channels are provided to this EUT:

CHANNEL	FREQ. (MHz)	CHANNEL	FREQ. (MHz)	CHANNEL	FREQ. (MHz)	CHANNEL	FREQ. (MHz)
0	2402	20	2422	40	2442	60	2462
1	2403	21	2423	41	2443	61	2463
2	2404	22	2424	42	2444	62	2464
3	2405	23	2425	43	2445	63	2465
4	2406	24	2426	44	2446	64	2466
5	2407	25	2427	45	2447	65	2467
6	2408	26	2428	46	2448	66	2468
7	2409	27	2429	47	2449	67	2469
8	2410	28	2430	48	2450	68	2470
9	2411	29	2431	49	2451	69	2471
10	2412	30	2432	50	2452	70	2472
11	2413	31	2433	51	2453	71	2473
12	2414	32	2434	52	2454	72	2474
13	2415	33	2435	53	2455	73	2475
14	2416	34	2436	54	2456	74	2476
15	2417	35	2437	55	2457	75	2477
16	2418	36	2438	56	2458	76	2478
17	2419	37	2439	57	2459	77	2479
18	2420	38	2440	58	2460	78	2480
19	2421	39	2441	59	2461		

3.2.1 CONFIGURATION OF SYSTEM UNDER TEST

Test Mode A

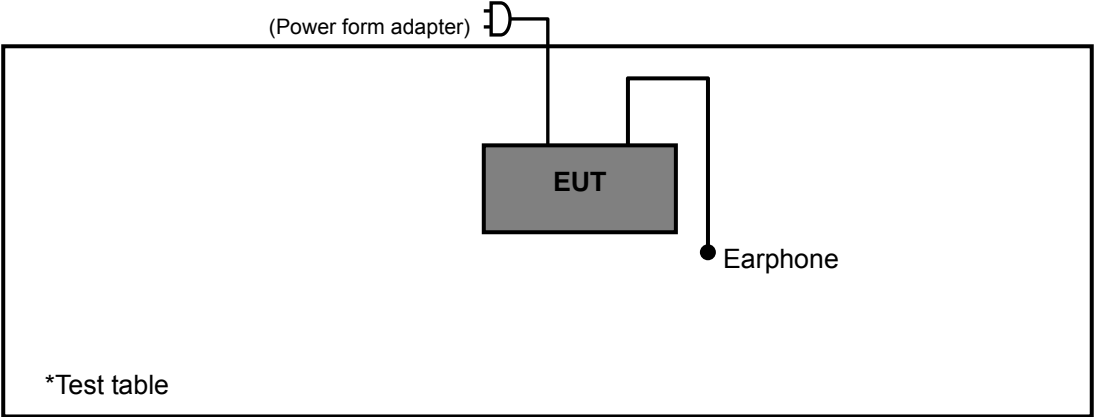

Test Mode B

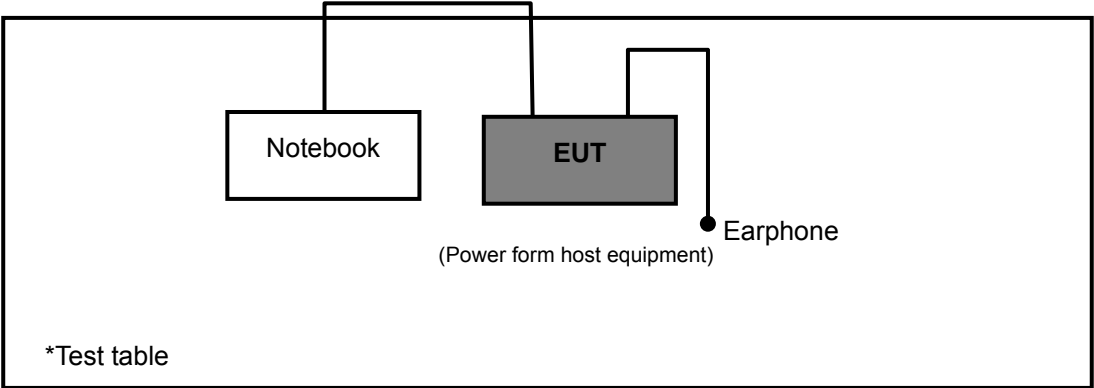

3.2.2 TEST MODE APPLICABILITY AND TESTED CHANNEL DETAIL

EUT CONFIGURE MODE	APPLICABLE TO				DESCRIPTION
	RE \geq 1G	RE $<$ 1G	PLC	APCM	
A	√	√	√	√	Power from adapter
B	-	√	√	-	Power from host equipment

Where **RE \geq 1G**: Radiated Emission above 1GHz

RE $<$ 1G: Radiated Emission below 1GHz

PLC: Power Line Conducted Emission

APCM: Antenna Port Conducted Measurement

NOTE: "-": Means no effect.

RADIATED EMISSION TEST (ABOVE 1 GHz):

- Pre-Scan has been conducted to determine the worst-case mode from all possible combinations between available modulations, XYZ axis, antenna ports (if EUT with antenna diversity architecture) and packet type.
- Following channel(s) was (were) selected for the final test as listed below.

EUT CONFIGURE MODE	AVAILABLE CHANNEL	TESTED CHANNEL	MODULATION TECHNOLOGY	MODULATION TYPE	PACKET TYPE	AXIS
A	0 to 78	0, 39, 78	FHSS	GFSK	DH5	Y
A	0 to 78	0, 39, 78	FHSS	8DPSK	DH5	Y

RADIATED EMISSION TEST (BELOW 1 GHz):

- Pre-Scan has been conducted to determine the worst-case mode from all possible combinations between available modulations, XYZ axis, antenna ports (if EUT with antenna diversity architecture) and packet type.
- Following channel(s) was (were) selected for the final test as listed below.

EUT CONFIGURE MODE	AVAILABLE CHANNEL	TESTED CHANNEL	MODULATION TECHNOLOGY	MODULATION TYPE	PACKET TYPE	AXIS
A, B	0 to 78	39	FHSS	GFSK	DH5	Y

POWER LINE CONDUCTED EMISSION TEST:

- Pre-Scan has been conducted to determine the worst-case mode from all possible combinations between available modulations, data rates and antenna ports (if EUT with antenna diversity architecture).
- Following channel(s) was (were) selected for the final test as listed below.

EUT CONFIGURE MODE	AVAILABLE CHANNEL	TESTED CHANNEL	MODULATION TECHNOLOGY	MODULATION TYPE	PACKET TYPE
A, B	0 to 78	39	FHSS	GFSK	DH5

ANTENNA PORT CONDUCTED MEASUREMENT:

- This item includes all test value of each mode, but only includes spectrum plot of worst value of each mode.
- Pre-Scan has been conducted to determine the worst-case mode from all possible combinations between available modulations, antenna ports (if EUT with antenna diversity architecture), and packet types.
- Following channel(s) was (were) selected for the final test as listed below.

EUT CONFIGURE MODE	AVAILABLE CHANNEL	TESTED CHANNEL	MODULATION TECHNOLOGY	MODULATION TYPE	PACKET TYPE
A	0 to 78	0, 39, 78	FHSS	GFSK	DH5
A	0 to 78	0, 39, 78	FHSS	8DPSK	DH5

TEST CONDITION:

APPLICABLE TO	ENVIRONMENTAL CONDITIONS	INPUT POWER	TESTED BY
RE≥1G	25deg. C, 65%RH	120Vac, 60Hz	Antony Lee
RE<1G	25deg. C, 65%RH	120Vac, 60Hz	Kay Wu
PLC	22deg. C, 61%RH	120Vac, 60Hz	Antony Lee
APCM	25deg. C, 68%RH	120Vac, 60Hz	Brad Wu

3.3 GENERAL DESCRIPTION OF APPLIED STANDARDS

The EUT is a RF Product. According to the specifications of the manufacturer, it must comply with the requirements of the following standards:

FCC Part 15, Subpart C (15.247)

ANSI C63.4-2003

ANSI C63.10-2009

All test items have been performed and recorded as per the above standards.

NOTE: The EUT is also considered as a kind of personal computer. It has been verified to comply with the requirements of FCC Part 15, Subpart B, Class B (DoC). The test report has been issued separately.



A D T

3.4 DESCRIPTION OF SUPPORT UNITS

The EUT has been tested as an independent unit together with other necessary accessories or support units. The following support units or accessories were used to form a representative test configuration during the tests.

NO.	PRODUCT	BRAND	MODEL NO.	SERIAL NO.	FCC ID
1	NOTEBOOK	DELL	Latitude E5520	NA	FCC DoC Approved

NO.	SIGNAL CABLE DESCRIPTION OF THE ABOVE SUPPORT UNITS
1	NA

NOTE: All power cords of the above support units are non shielded (1.8m).

4. TEST TYPES AND RESULTS

4.1 RADIATED EMISSION MEASUREMENT

4.1.1 LIMITS OF RADIATED EMISSION MEASUREMENT

Radiated emissions which fall in the restricted bands, as defined in Section 15.205(a), must also comply with the radiated emission limits specified in Section 15.209(a). Other emissions shall be at least 20dB below the highest level of the desired power.

FREQUENCIES (MHz)	FIELD STRENGTH (microvolts/meter)	MEASUREMENT DISTANCE (meters)
0.009 ~ 0.490	2400/F(kHz)	300
0.490 ~ 1.705	24000/F(kHz)	30
1.705 ~ 30.0	30	30
30 ~ 88	100	3
88 ~ 216	150	3
216 ~ 960	200	3
Above 960	500	3

NOTE:

1. The lower limit shall apply at the transition frequencies.
2. Emission level (dBuV/m) = 20 log Emission level (uV/m).
3. As shown in 15.35(b), for frequencies above 1000MHz, the field strength limits are based on average detector, however, the peak field strength of any emission shall not exceed the maximum permitted average limits, specified above by more than 20dB under any condition of modulation.

4.1.2 TEST INSTRUMENTS

DESCRIPTION & MANUFACTURER	MODEL NO.	SERIAL NO.	DATE OF CALIBRATION	DUE DATE OF CALIBRATION
Test Receiver ROHDE & SCHWARZ	ESI7	838496/016	Dec. 27, 2010	Dec. 26, 2011
Spectrum Analyzer ROHDE & SCHWARZ	FSP40	100039	Feb. 23, 2011	Feb. 22, 2012
BILOG Antenna SCHWARZBECK	VULB9168	9168-155	Apr. 12, 2011	Apr. 11, 2012
HORN Antenna SCHWARZBECK	BBHA 9120D	9120D-408	Jan. 06, 2011	Jan. 05, 2012
HORN Antenna SCHWARZBECK	BBHA 9170	BBHA9170243	Dec. 27, 2010	Dec. 26, 2011
Preamplifier Agilent	8449B	3008A01961	Oct. 29, 2011	Oct. 28, 2012
Preamplifier Agilent	8447D	2944A10738	Oct. 29, 2011	Oct. 28, 2012
RF signal cable HUBER+SUHNNER	SUCOFLEX 104	250792/4	Aug. 19, 2011	Aug. 18, 2012
RF signal cable HUBER+SUHNNER	SUCOFLEX 104	283397/4	Aug. 19, 2011	Aug. 18, 2012
RF signal cable HUBER+SUHNNER	SUCOFLEX 104	295012/4	Aug. 19, 2011	Aug. 18, 2012
Software ADT.	ADT_Radiated_ V7.6.15.9.2	NA	NA	NA
Antenna Tower inn-co GmbH	MA 4000	010303	NA	NA
Antenna Tower Controller inn-co GmbH	CO2000	019303	NA	NA
Turn Table ADT.	TT100.	TT93021704	NA	NA
Turn Table Controller ADT.	SC100.	SC93021704	NA	NA
High Speed Peak Power Meter	ML2495A	0842014	Apr. 26, 2011	Apr. 25, 2012
Power Sensor	MA2411B	0738404	Apr. 26, 2011	Apr. 25, 2012

- NOTE:**
1. The calibration interval of the above test instruments is 12 months and the calibrations are traceable to NML/ROC and NIST/USA.
 2. The test was performed in HwaYa Chamber 4.
 3. The horn antenna and HP preamplifier (model: 8449B) are used only for the measurement of emission frequency above 1GHz if tested.
 4. The FCC Site Registration No. is 460141.
 5. The IC Site Registration No. is IC7450F-4.

4.1.3 TEST PROCEDURES

- a. The EUT was placed on the top of a rotating table 0.8 meters above the ground at a 3 meter semi-anechoic chamber. The table was rotated 360 degrees to determine the position of the highest radiation.
- b. The EUT was set 3 meters away from the interference-receiving antenna, which was mounted on the top of a variable-height antenna tower.
- c. The antenna is a broadband antenna, and its height is varied from one meter to four meters above the ground to determine the maximum value of the field strength. Both horizontal and vertical polarizations of the antenna are set to make the measurement.
- d. For each suspected emission, the EUT was arranged to its worst case and then the antenna was tuned to heights from 1 meter to 4 meters and the rotatable table was turned from 0 degrees to 360 degrees to find the maximum reading.
- e. The test-receiver system was set to Peak Detect Function and Specified Bandwidth with Maximum Hold Mode.
- f. If the emission level of the EUT in peak mode was lower than the limit specified, then testing could be stopped and the peak values of the EUT would be reported. Otherwise the emissions would be re-tested one by one using peak, quasi-peak or average method as specified and then reported in a data sheet.

NOTE:

1. The resolution bandwidth and video bandwidth of test receiver/spectrum analyzer is 120kHz for Quasi-peak detection at frequency below 1GHz.
2. The resolution bandwidth of test receiver/spectrum analyzer is 1 MHz and video bandwidth is 3MHz for Peak detection at frequency above 1GHz.
3. All modes of operation were investigated and the worst-case emissions are reported.

4.1.4 DEVIATION FROM TEST STANDARD

No deviation.

4.1.5 TEST SETUP

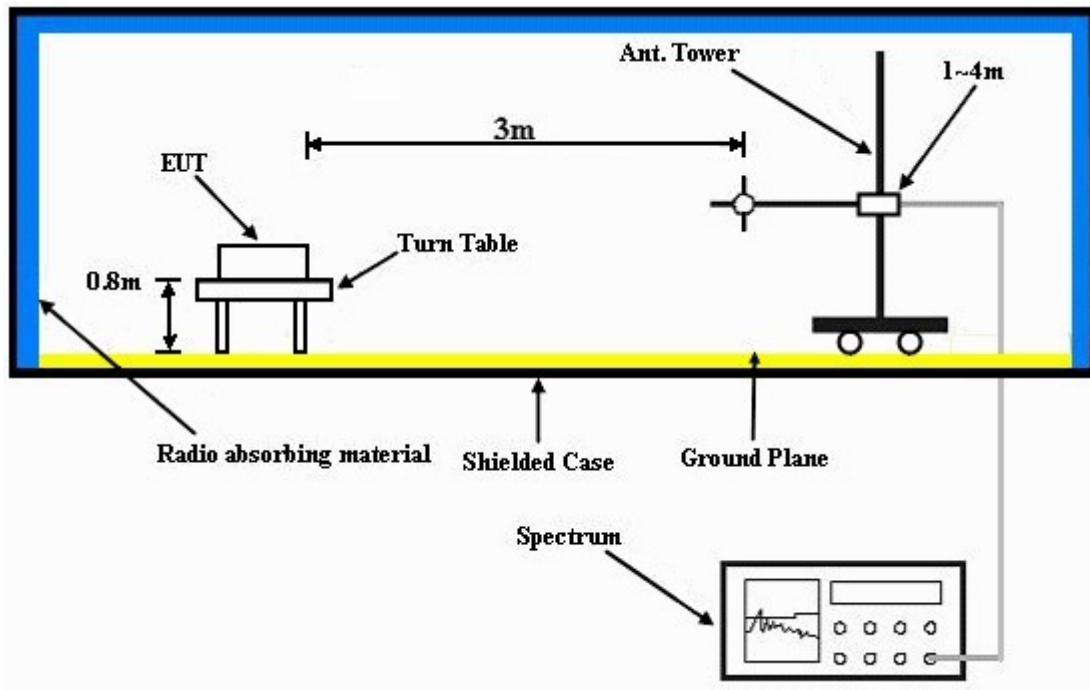

For the actual test configuration, please refer to the attached file (Test Setup Photo).

4.1.6 EUT OPERATING CONDITIONS

TEST MODE A

- Placed the EUT on a testing table.
- Use the software to control the EUT under transmission condition continuously at specific channel frequency.

TEST MODE B

- Connected the EUT to notebook and placed on a testing table.
- Use the software to control the EUT under transmission condition continuously at specific channel frequency.
- The necessary accessories enable the system in full functions.

4.1.7 TEST RESULTS

GFSK

EUT TEST CONDITION		MEASUREMENT DETAIL	
CHANNEL	Channel 0	FREQUENCY RANGE	1 ~ 25GHz
INPUT POWER (SYSTEM)	120Vac, 60 Hz	DETECTOR FUNCTION	Peak (PK) Average (AV)
ENVIRONMENTAL CONDITIONS	25deg. C, 65%RH	TESTED BY	Antony Lee

ANTENNA POLARITY & TEST DISTANCE: HORIZONTAL AT 3 M								
NO.	FREQ. (MHz)	EMISSION LEVEL (dBuV/m)	LIMIT (dBuV/m)	MARGIN (dB)	ANTENNA HEIGHT (m)	TABLE ANGLE (Degree)	RAW VALUE (dBuV)	CORRECTION FACTOR (dB/m)
1	2390.00	44.3 PK	74.0	-29.7	1.17 H	310	11.90	32.40
2	2390.00	34.4 AV	54.0	-19.6	1.17 H	310	2.00	32.40
3	#2398.00	44.3 PK	81.9	-37.6	1.17 H	309	11.90	32.40
4	#2398.00	32.4 AV	51.8	-19.4	1.17 H	309	0.00	32.40
5	#2398.50	47.2 PK	81.9	-34.7	1.17 H	309	14.80	32.40
6	#2398.50	35.1 AV	51.8	-16.7	1.17 H	309	2.70	32.40
7	#2400.00	46.3 PK	81.9	-35.6	1.17 H	309	13.90	32.40
8	#2400.00	16.2 AV	51.8	-35.6	1.17 H	309	-16.20	32.40
9	*2402.00	101.9 PK			1.17 H	309	69.50	32.40
10	*2402.00	71.8 AV			1.17 H	309	39.40	32.40
11	4804.00	47.3 PK	74.0	-26.7	1.00 H	23	8.60	38.70
12	4804.00	17.2 AV	54.0	-36.8	1.00 H	23	-21.50	38.70

- REMARKS:**
1. Emission level (dBuV/m) = Raw Value (dBuV) + Correction Factor (dB/m).
 2. Correction Factor (dB/m) = Antenna Factor (dB/m) + Cable Factor (dB).
 3. The other emission levels were very low against the limit.
 4. Margin value = Emission level – Limit value.
 5. “ * “: Fundamental frequency.
 6. The DH5 packet was the worse case duty cycle for a transmit dwell time on a channel, based upon bluetooth theory the transmitter is on 0.625 * 5 per 296.25 ms per channel. Therefore, the duty cycle correlation factor be equal to: $20\log(3.125 / 100) = -30.1$ dB.
 7. Average value = peak reading + $20\log(\text{duty cycle})$.
 8. "#": The radiated frequency is out the restricted band.



A D T

EUT TEST CONDITION		MEASUREMENT DETAIL	
CHANNEL	Channel 0	FREQUENCY RANGE	1 ~ 25GHz
INPUT POWER (SYSTEM)	120Vac, 60 Hz	DETECTOR FUNCTION	Peak (PK) Average (AV)
ENVIRONMENTAL CONDITIONS	25deg. C, 65%RH	TESTED BY	Antony Lee

ANTENNA POLARITY & TEST DISTANCE: VERTICAL AT 3 M								
NO.	FREQ. (MHz)	EMISSION LEVEL (dBuV/m)	LIMIT (dBuV/m)	MARGIN (dB)	ANTENNA HEIGHT (m)	TABLE ANGLE (Degree)	RAW VALUE (dBuV)	CORRECTION FACTOR (dB/m)
1	2390.00	42.4 PK	74.0	-31.6	1.50 V	18	10.00	32.40
2	2390.00	33.5 AV	54.0	-20.5	1.50 V	18	1.10	32.40
3	#2398.00	45.0 PK	77.7	-32.7	1.50 V	18	12.60	32.40
4	#2398.00	34.4 AV	47.6	-13.2	1.50 V	19	2.00	32.40
5	#2398.50	45.4 PK	77.7	-32.3	1.50 V	19	13.00	32.40
6	#2398.50	35.8 AV	47.6	-11.8	1.50 V	18	3.40	32.40
7	#2400.00	47.2 PK	77.7	-30.5	1.50 V	18	14.80	32.40
8	#2400.00	17.1 AV	47.6	-30.5	1.50 V	18	-15.30	32.40
9	*2402.00	97.7 PK			1.50 V	18	65.30	32.40
10	*2402.00	67.6 AV			1.50 V	18	35.20	32.40
11	4804.00	48.3 PK	74.0	-25.7	1.01 V	129	9.60	38.70
12	4804.00	18.2 AV	54.0	-35.8	1.01 V	129	-20.50	38.70

- REMARKS:**
1. Emission level (dBuV/m) = Raw Value (dBuV) + Correction Factor (dB/m).
 2. Correction Factor (dB/m) = Antenna Factor (dB/m) + Cable Factor (dB).
 3. The other emission levels were very low against the limit.
 4. Margin value = Emission level – Limit value.
 5. “ * “: Fundamental frequency.
 6. The DH5 packet was the worse case duty cycle for a transmit dwell time on a channel, based upon bluetooth theory the transmitter is on $0.625 * 5$ per 296.25 ms per channel. Therefore, the duty cycle correlation factor be equal to: $20\log(3.125 / 100) = -30.1$ dB.
 7. Average value = peak reading + $20\log(\text{duty cycle})$.
 8. "#":The radiated frequency is out the restricted band.



EUT TEST CONDITION		MEASUREMENT DETAIL	
CHANNEL	Channel 39	FREQUENCY RANGE	1 ~ 25GHz
INPUT POWER (SYSTEM)	120Vac, 60 Hz	DETECTOR FUNCTION	Peak (PK) Average (AV)
ENVIRONMENTAL CONDITIONS	25deg. C, 65%RH	TESTED BY	Antony Lee

ANTENNA POLARITY & TEST DISTANCE: HORIZONTAL AT 3 M								
NO.	FREQ. (MHz)	EMISSION LEVEL (dBuV/m)	LIMIT (dBuV/m)	MARGIN (dB)	ANTENNA HEIGHT (m)	TABLE ANGLE (Degree)	RAW VALUE (dBuV)	CORRECTION FACTOR (dB/m)
1	*2441.00	101.8 PK			1.39 H	320	69.30	32.50
2	*2441.00	71.7 AV			1.39 H	320	39.20	32.50
3	#3254.00	43.6 PK	81.8	-38.2	1.00 H	124	8.80	34.80
4	#3254.00	13.5 AV	51.7	-38.2	1.00 H	124	-21.30	34.80
5	4882.00	46.5 PK	74.0	-27.5	1.00 H	58	7.60	38.90
6	4882.00	16.4 AV	54.0	-37.6	1.00 H	58	-22.50	38.90
ANTENNA POLARITY & TEST DISTANCE: VERTICAL AT 3 M								
NO.	FREQ. (MHz)	EMISSION LEVEL (dBuV/m)	LIMIT (dBuV/m)	MARGIN (dB)	ANTENNA HEIGHT (m)	TABLE ANGLE (Degree)	RAW VALUE (dBuV)	CORRECTION FACTOR (dB/m)
1	*2441.00	99.3 PK			1.19 V	38	66.80	32.50
2	*2441.00	69.2 AV			1.19 V	38	36.70	32.50
3	#3254.00	44.5 PK	79.3	-34.8	1.01 V	161	9.70	34.80
4	#3254.00	14.4 AV	49.2	-34.8	1.01 V	161	-20.40	34.80
5	4882.00	47.3 PK	74.0	-26.7	1.00 V	169	8.40	38.90
6	4882.00	17.2 AV	54.0	-36.8	1.00 V	169	-21.70	38.90

- REMARKS:**
1. Emission level (dBuV/m) = Raw Value (dBuV) + Correction Factor (dB/m).
 2. Correction Factor (dB/m) = Antenna Factor (dB/m) + Cable Factor (dB).
 3. The other emission levels were very low against the limit.
 4. Margin value = Emission level – Limit value.
 5. “ * “: Fundamental frequency.
 6. The DH5 packet was the worse case duty cycle for a transmit dwell time on a channel, based upon bluetooth theory the transmitter is on 0.625 * 5 per 296.25 ms per channel. Therefore, the duty cycle correlation factor be equal to: $20\log(3.125 / 100) = -30.1$ dB.
 7. Average value = peak reading + $20\log(\text{duty cycle})$.
 8. "#":The radiated frequency is out the restricted band.



A D T

EUT TEST CONDITION		MEASUREMENT DETAIL	
CHANNEL	Channel 78	FREQUENCY RANGE	1 ~ 25GHz
INPUT POWER (SYSTEM)	120Vac, 60 Hz	DETECTOR FUNCTION	Peak (PK) Average (AV)
ENVIRONMENTAL CONDITIONS	25deg. C, 65%RH	TESTED BY	Antony Lee

ANTENNA POLARITY & TEST DISTANCE: HORIZONTAL AT 3 M								
NO.	FREQ. (MHz)	EMISSION LEVEL (dBuV/m)	LIMIT (dBuV/m)	MARGIN (dB)	ANTENNA HEIGHT (m)	TABLE ANGLE (Degree)	RAW VALUE (dBuV)	CORRECTION FACTOR (dB/m)
1	*2480.00	100.2 PK			1.00 H	223	67.50	32.70
2	*2480.00	70.1 AV			1.00 H	223	37.40	32.70
3	2483.50	39.6 PK	74.0	-34.4	1.00 H	223	6.90	32.70
4	2483.50	9.5 AV	54.0	-44.5	1.00 H	223	-23.20	32.70
5	2485.50	46.3 PK	74.0	-27.7	1.00 H	223	13.60	32.70
6	2485.50	16.2 AV	54.0	-37.8	1.00 H	223	-16.50	32.70
7	4960.00	45.9 PK	74.0	-28.1	1.00 H	263	6.80	39.10
8	4960.00	15.8 AV	54.0	-38.2	1.00 H	263	-23.30	39.10

ANTENNA POLARITY & TEST DISTANCE: VERTICAL AT 3 M								
NO.	FREQ. (MHz)	EMISSION LEVEL (dBuV/m)	LIMIT (dBuV/m)	MARGIN (dB)	ANTENNA HEIGHT (m)	TABLE ANGLE (Degree)	RAW VALUE (dBuV)	CORRECTION FACTOR (dB/m)
1	*2480.00	98.4 PK			1.24 V	25	65.70	32.70
2	*2480.00	68.3 AV			1.24 V	25	35.60	32.70
3	2483.50	38.4 PK	74.0	-35.6	1.24 V	25	5.70	32.70
4	2483.50	8.3 AV	54.0	-45.7	1.24 V	25	-24.40	32.70
5	2485.50	40.2 PK	74.0	-33.8	1.24 V	25	7.50	32.70
6	2485.50	30.3 AV	54.0	-23.7	1.24 V	25	-2.40	32.70
7	4960.00	45.9 PK	74.0	-28.1	1.00 V	18	6.80	39.10
8	4960.00	15.8 AV	54.0	-38.2	1.00 V	18	-23.30	39.10

- REMARKS:**
- Emission level (dBuV/m) = Raw Value (dBuV) + Correction Factor (dB/m).
 - Correction Factor (dB/m) = Antenna Factor (dB/m) + Cable Factor (dB).
 - The other emission levels were very low against the limit.
 - Margin value = Emission level – Limit value.
 - * *: Fundamental frequency.
 - The DH5 packet was the worse case duty cycle for a transmit dwell time on a channel, based upon bluetooth theory the transmitter is on 0.625 * 5 per 296.25 ms per channel. Therefore, the duty cycle correlation factor be equal to: $20\log(3.125 / 100) = -30.1$ dB.
 - Average value = peak reading + $20\log(\text{duty cycle})$.



A D T

8DPSK

EUT TEST CONDITION		MEASUREMENT DETAIL	
CHANNEL	Channel 0	FREQUENCY RANGE	1 ~ 25GHz
INPUT POWER (SYSTEM)	120Vac, 60 Hz	DETECTOR FUNCTION	Peak (PK) Average (AV)
ENVIRONMENTAL CONDITIONS	25deg. C, 65%RH	TESTED BY	Antony Lee

ANTENNA POLARITY & TEST DISTANCE: HORIZONTAL AT 3 M								
NO.	FREQ. (MHz)	EMISSION LEVEL (dBuV/m)	LIMIT (dBuV/m)	MARGIN (dB)	ANTENNA HEIGHT (m)	TABLE ANGLE (Degree)	RAW VALUE (dBuV)	CORRECTION FACTOR (dB/m)
1	2390.00	44.6 PK	74.0	-29.4	1.15 H	308	12.20	32.40
2	2390.00	35.4 AV	54.0	-18.6	1.15 H	308	3.00	32.40
3	#2398.00	51.6 PK	80.7	-29.1	1.17 H	307	19.20	32.40
4	#2398.00	31.0 AV	50.6	-19.6	1.17 H	307	-1.40	32.40
5	#2398.50	43.6 PK	80.7	-37.1	1.17 H	307	11.20	32.40
6	#2398.50	31.0 AV	50.6	-19.6	1.17 H	307	-1.40	32.40
7	#2400.00	44.8 PK	80.7	-35.9	1.17 H	307	12.40	32.40
8	#2400.00	14.7 AV	50.6	-35.9	1.17 H	307	-17.70	32.40
9	*2402.00	100.7 PK			1.17 H	307	68.30	32.40
10	*2402.00	70.6 AV			1.17 H	307	38.20	32.40
11	4804.00	47.1 PK	74.0	-26.9	1.00 H	26	8.40	38.70
12	4804.00	17.0 AV	54.0	-37.0	1.00 H	26	-21.70	38.70

- REMARKS:**
1. Emission level (dBuV/m) = Raw Value (dBuV) + Correction Factor (dB/m).
 2. Correction Factor (dB/m) = Antenna Factor (dB/m) + Cable Factor (dB).
 3. The other emission levels were very low against the limit.
 4. Margin value = Emission level – Limit value.
 5. “ * “: Fundamental frequency.
 6. The DH5 packet was the worse case duty cycle for a transmit dwell time on a channel, based upon bluetooth theory the transmitter is on 0.625 * 5 per 296.25 ms per channel. Therefore, the duty cycle correlation factor be equal to: $20\log(3.125 / 100) = -30.1$ dB.
 7. Average value = peak reading + $20\log(\text{duty cycle})$.



A D T

EUT TEST CONDITION		MEASUREMENT DETAIL	
CHANNEL	Channel 0	FREQUENCY RANGE	1 ~ 25GHz
INPUT POWER (SYSTEM)	120Vac, 60 Hz	DETECTOR FUNCTION	Peak (PK) Average (AV)
ENVIRONMENTAL CONDITIONS	25deg. C, 65%RH	TESTED BY	Antony Lee

ANTENNA POLARITY & TEST DISTANCE: VERTICAL AT 3 M								
NO.	FREQ. (MHz)	EMISSION LEVEL (dBuV/m)	LIMIT (dBuV/m)	MARGIN (dB)	ANTENNA HEIGHT (m)	TABLE ANGLE (Degree)	RAW VALUE (dBuV)	CORRECTION FACTOR (dB/m)
1	2390.00	39.2 PK	74.0	-34.8	1.35 V	17	6.80	32.40
2	2390.00	30.9 AV	54.0	-23.1	1.35 V	17	-1.50	32.40
3	#2398.00	47.9 PK	76.8	-28.9	1.20 V	36	15.50	32.40
4	#2398.00	28.5 AV	46.7	-18.2	1.20 V	36	-3.90	32.40
5	#2398.50	42.4 PK	76.8	-34.4	1.20 V	36	10.00	32.40
6	#2398.50	29.8 AV	46.7	-16.9	1.20 V	36	-2.60	32.40
7	#2400.00	42.0 PK	76.8	-34.8	1.29 V	31	9.60	32.40
8	#2400.00	11.9 AV	46.7	-34.8	1.29 V	31	-20.50	32.40
9	*2402.00	96.8 PK			1.29 V	31	64.40	32.40
10	*2402.00	66.7 AV			1.29 V	31	34.30	32.40
11	4804.00	46.6 PK	74.0	-27.4	1.02 V	125	7.90	38.70
12	4804.00	16.5 AV	54.0	-37.5	1.02 V	125	-22.20	38.70

- REMARKS:**
1. Emission level (dBuV/m) = Raw Value (dBuV) + Correction Factor (dB/m).
 2. Correction Factor (dB/m) = Antenna Factor (dB/m) + Cable Factor (dB).
 3. The other emission levels were very low against the limit.
 4. Margin value = Emission level – Limit value.
 5. “ * “: Fundamental frequency.
 6. The DH5 packet was the worse case duty cycle for a transmit dwell time on a channel, based upon bluetooth theory the transmitter is on $0.625 * 5$ per 296.25 ms per channel. Therefore, the duty cycle correlation factor be equal to: $20\log(3.125 / 100) = -30.1$ dB.
 7. Average value = peak reading + $20\log(\text{duty cycle})$.
 8. "#":The radiated frequency is out the restricted band.



A D T

EUT TEST CONDITION		MEASUREMENT DETAIL	
CHANNEL	Channel 39	FREQUENCY RANGE	1 ~ 25GHz
INPUT POWER (SYSTEM)	120Vac, 60 Hz	DETECTOR FUNCTION	Peak (PK) Average (AV)
ENVIRONMENTAL CONDITIONS	25deg. C, 65%RH	TESTED BY	Antony Lee

ANTENNA POLARITY & TEST DISTANCE: HORIZONTAL AT 3 M								
NO.	FREQ. (MHz)	EMISSION LEVEL (dBuV/m)	LIMIT (dBuV/m)	MARGIN (dB)	ANTENNA HEIGHT (m)	TABLE ANGLE (Degree)	RAW VALUE (dBuV)	CORRECTION FACTOR (dB/m)
1	*2441.00	102.4 PK			1.43 H	314	69.90	32.50
2	*2441.00	72.3 AV			1.43 H	314	39.80	32.50
3	#3254.00	42.3 PK	82.4	-40.1	1.00 H	125	7.50	34.80
4	#3254.00	12.2 AV	52.3	-40.1	1.00 H	125	-22.60	34.80
5	4882.00	46.0 PK	74.0	-28.0	1.02 H	36	7.10	38.90
6	4882.00	15.9 AV	54.0	-38.1	1.02 H	36	-23.00	38.90
ANTENNA POLARITY & TEST DISTANCE: VERTICAL AT 3 M								
NO.	FREQ. (MHz)	EMISSION LEVEL (dBuV/m)	LIMIT (dBuV/m)	MARGIN (dB)	ANTENNA HEIGHT (m)	TABLE ANGLE (Degree)	RAW VALUE (dBuV)	CORRECTION FACTOR (dB/m)
1	*2441.00	98.1 PK			1.25 V	36	65.60	32.50
2	*2441.00	68.0 AV			1.25 V	36	35.50	32.50
3	#3254.00	43.2 PK	78.1	-34.9	1.02 V	157	8.40	34.80
4	#3254.00	13.1 AV	48.0	-34.9	1.02 V	157	-21.70	34.80
5	4882.00	46.6 PK	74.0	-27.4	1.00 V	166	7.70	38.90
6	4882.00	16.5 AV	54.0	-37.5	1.00 V	166	-22.40	38.90

- REMARKS:**
1. Emission level (dBuV/m) = Raw Value (dBuV) + Correction Factor (dB/m).
 2. Correction Factor (dB/m) = Antenna Factor (dB/m) + Cable Factor (dB).
 3. The other emission levels were very low against the limit.
 4. Margin value = Emission level – Limit value.
 5. “ * “: Fundamental frequency.
 6. The DH5 packet was the worse case duty cycle for a transmit dwell time on a channel, based upon bluetooth theory the transmitter is on 0.625 * 5 per 296.25 ms per channel. Therefore, the duty cycle correlation factor be equal to: $20\log(3.125 / 100) = -30.1$ dB.
 7. Average value = peak reading + $20\log(\text{duty cycle})$.
 8. "#":The radiated frequency is out the restricted band.



EUT TEST CONDITION		MEASUREMENT DETAIL	
CHANNEL	Channel 78	FREQUENCY RANGE	1 ~ 25GHz
INPUT POWER (SYSTEM)	120Vac, 60 Hz	DETECTOR FUNCTION	Peak (PK) Average (AV)
ENVIRONMENTAL CONDITIONS	25deg. C, 65%RH	TESTED BY	Antony Lee

ANTENNA POLARITY & TEST DISTANCE: HORIZONTAL AT 3 M								
NO.	FREQ. (MHz)	EMISSION LEVEL (dBuV/m)	LIMIT (dBuV/m)	MARGIN (dB)	ANTENNA HEIGHT (m)	TABLE ANGLE (Degree)	RAW VALUE (dBuV)	CORRECTION FACTOR (dB/m)
1	*2480.00	100.0 PK			1.00 H	215	67.30	32.70
2	*2480.00	69.9 AV			1.00 H	215	37.20	32.70
3	2483.50	38.7 PK	74.0	-35.3	1.00 H	215	6.00	32.70
4	2483.50	8.6 AV	54.0	-45.4	1.00 H	215	-24.10	32.70
5	2485.50	45.4 PK	74.0	-28.6	1.00 H	216	12.70	32.70
6	2485.50	31.7 AV	54.0	-22.3	1.00 H	216	-1.00	32.70
7	4960.00	45.7 PK	74.0	-28.3	1.00 H	254	6.60	39.10
8	4960.00	15.6 AV	54.0	-38.4	1.00 H	254	-23.50	39.10
ANTENNA POLARITY & TEST DISTANCE: VERTICAL AT 3 M								
NO.	FREQ. (MHz)	EMISSION LEVEL (dBuV/m)	LIMIT (dBuV/m)	MARGIN (dB)	ANTENNA HEIGHT (m)	TABLE ANGLE (Degree)	RAW VALUE (dBuV)	CORRECTION FACTOR (dB/m)
1	*2480.00	98.5 PK			1.25 V	24	65.80	32.70
2	*2480.00	68.4 AV			1.25 V	24	35.70	32.70
3	2483.50	37.3 PK	74.0	-36.7	1.25 V	24	4.60	32.70
4	2483.50	7.2 AV	54.0	-46.8	1.25 V	24	-25.50	32.70
5	2485.50	39.9 PK	74.0	-34.1	1.26 V	28	7.20	32.70
6	2485.50	30.4 AV	54.0	-23.6	1.26 V	28	-2.30	32.70
7	4960.00	45.7 PK	74.0	-28.3	1.00 V	15	6.60	39.10
8	4960.00	15.6 AV	54.0	-38.4	1.00 V	15	-23.50	39.10

- REMARKS:**
1. Emission level (dBuV/m) = Raw Value (dBuV) + Correction Factor (dB/m).
 2. Correction Factor (dB/m) = Antenna Factor (dB/m) + Cable Factor (dB).
 3. The other emission levels were very low against the limit.
 4. Margin value = Emission level – Limit value.
 5. “ * “: Fundamental frequency.
 6. The DH5 packet was the worse case duty cycle for a transmit dwell time on a channel, based upon bluetooth theory the transmitter is on 0.625 * 5 per 296.25 ms per channel. Therefore, the duty cycle correlation factor be equal to: $20\log(3.125 / 100) = -30.1$ dB.
 7. Average value = peak reading + $20\log(\text{duty cycle})$.



A D T

BELOW 1GHz WORST-CASE DATA : GFSK

EUT TEST CONDITION		MEASUREMENT DETAIL	
CHANNEL	Channel 39	FREQUENCY RANGE	Below 1000MHz
INPUT POWER (SYSTEM)	120Vac, 60 Hz	DETECTOR FUNCTION	Quasi-Peak
ENVIRONMENTAL CONDITIONS	25deg. C, 65%RH	TESTED BY	Kay Wu
TEST MODE	A		

ANTENNA POLARITY & TEST DISTANCE: HORIZONTAL AT 3 M								
NO.	FREQ. (MHz)	EMISSION LEVEL (dBuV/m)	LIMIT (dBuV/m)	MARGIN (dB)	ANTENNA HEIGHT (m)	TABLE ANGLE (Degree)	RAW VALUE (dBuV)	CORRECTION FACTOR (dB/m)
1	138.78	33.8 QP	43.5	-9.7	2.00 H	289	19.80	14.00
2	195.16	34.4 QP	43.5	-9.1	1.50 H	73	23.50	10.90
3	251.55	35.5 QP	46.0	-10.5	1.00 H	67	22.40	13.10
4	307.93	30.9 QP	46.0	-15.1	1.00 H	259	15.70	15.20
5	545.14	28.7 QP	46.0	-17.3	3.00 H	10	7.10	21.60
6	675.40	31.9 QP	46.0	-14.1	1.00 H	19	7.60	24.30

ANTENNA POLARITY & TEST DISTANCE: VERTICAL AT 3 M								
NO.	FREQ. (MHz)	EMISSION LEVEL (dBuV/m)	LIMIT (dBuV/m)	MARGIN (dB)	ANTENNA HEIGHT (m)	TABLE ANGLE (Degree)	RAW VALUE (dBuV)	CORRECTION FACTOR (dB/m)
1	138.78	28.3 QP	43.5	-15.2	1.00 V	217	14.30	14.00
2	195.16	28.0 QP	43.5	-15.5	1.50 V	334	17.10	10.90
3	251.55	25.9 QP	46.0	-20.1	1.00 V	10	12.80	13.10
4	307.93	25.7 QP	46.0	-20.3	1.50 V	337	10.50	15.20
5	545.14	33.5 QP	46.0	-12.5	1.00 V	292	11.90	21.60
6	675.40	31.6 QP	46.0	-14.4	1.50 V	304	7.30	24.30

- REMARKS:**
1. Emission level (dBuV/m) = Raw Value (dBuV) + Correction Factor (dB/m).
 2. Correction Factor (dB/m) = Antenna Factor (dB/m) + Cable Factor (dB).
 3. The other emission levels were very low against the limit.
 4. Margin value = Emission level – Limit value.



A D T

EUT TEST CONDITION		MEASUREMENT DETAIL	
CHANNEL	Channel 39	FREQUENCY RANGE	Below 1000MHz
INPUT POWER (SYSTEM)	120Vac, 60 Hz	DETECTOR FUNCTION	Quasi-Peak
ENVIRONMENTAL CONDITIONS	25deg. C, 65%RH	TESTED BY	Kay Wu
TEST MODE	B		

ANTENNA POLARITY & TEST DISTANCE: HORIZONTAL AT 3 M								
NO.	FREQ. (MHz)	EMISSION LEVEL (dBuV/m)	LIMIT (dBuV/m)	MARGIN (dB)	ANTENNA HEIGHT (m)	TABLE ANGLE (Degree)	RAW VALUE (dBuV)	CORRECTION FACTOR (dB/m)
1	41.57	32.6 QP	40.0	-7.4	1.00 H	142	18.20	14.40
2	138.78	39.7 QP	43.5	-3.8	2.00 H	64	25.70	14.00
3	166.00	35.7 QP	43.5	-7.8	1.50 H	67	21.70	14.00
4	195.16	34.5 QP	43.5	-9.0	1.50 H	106	23.60	10.90
5	251.55	38.3 QP	46.0	-7.7	1.00 H	160	25.20	13.10
6	432.37	31.9 QP	46.0	-14.1	2.00 H	70	13.30	18.60
ANTENNA POLARITY & TEST DISTANCE: VERTICAL AT 3 M								
NO.	FREQ. (MHz)	EMISSION LEVEL (dBuV/m)	LIMIT (dBuV/m)	MARGIN (dB)	ANTENNA HEIGHT (m)	TABLE ANGLE (Degree)	RAW VALUE (dBuV)	CORRECTION FACTOR (dB/m)
1	41.57	26.3 QP	40.0	-13.7	4.00 V	79	11.90	14.40
2	103.78	23.0 QP	43.5	-20.5	1.00 V	76	12.30	10.70
3	138.78	27.7 QP	43.5	-15.8	3.00 V	328	13.70	14.00
4	195.16	24.7 QP	43.5	-18.8	2.00 V	340	13.80	10.90
5	251.55	25.4 QP	46.0	-20.6	1.50 V	31	12.30	13.10
6	453.75	25.4 QP	46.0	-20.6	2.00 V	118	6.20	19.20

- REMARKS:**
1. Emission level (dBuV/m) = Raw Value (dBuV) + Correction Factor (dB/m).
 2. Correction Factor (dB/m) = Antenna Factor (dB/m) + Cable Factor (dB).
 3. The other emission levels were very low against the limit.
 4. Margin value = Emission level – Limit value.

4.2 CONDUCTED EMISSION MEASUREMENT

4.2.1 LIMITS OF CONDUCTED EMISSION MEASUREMENT

FREQUENCY OF EMISSION (MHz)	CONDUCTED LIMIT (dB μ V)	
	Quasi-peak	Average
0.15 ~ 0.5	66 to 56	56 to 46
0.5 ~ 5	56	46
5 ~ 30	60	50

- NOTE:**
1. The lower limit shall apply at the transition frequencies.
 2. The limit decreases in line with the logarithm of the frequency in the range of 0.15 to 0.50 MHz.
 3. All emanations from a class A/B digital device or system, including any network of conductors and apparatus connected thereto, shall not exceed the level of field strengths specified above.

4.2.2 TEST INSTRUMENTS

DESCRIPTION & MANUFACTURER	MODEL NO.	SERIAL NO.	DATE OF CALIBRATION	DUE DATE OF CALIBRATION
Test Receiver ROHDE & SCHWARZ	ESCS30	100291	Nov. 23, 2011	Nov. 22, 2012
RF signal cable Woken	5D-FB	Cable-HYC01-01	Dec. 30, 2010	Dec. 29, 2011
LISN ROHDE & SCHWARZ	ESH3-Z5	100312	Jul. 07, 2011	Jul. 06, 2012
LISN ROHDE & SCHWARZ	ESH2-Z5	100100	Jan. 06, 2011	Jan. 05, 2012
LISN ROHDE & SCHWARZ	ESH3-Z5	835239/001	Feb. 22, 2011	Feb. 21, 2012
V-LISN SCHWARZBECK	NNBL 8226-2	8226-142	Jun. 30, 2011	Jun. 29, 2012
LISN ROHDE & SCHWARZ	ENV216	100072	Jun. 10, 2011	Jun. 09, 2012
Software ADT	ADT_Cond_ V7.3.7	NA	NA	NA

- NOTE:**
1. The calibration interval of the above test instruments is 12 months and the calibrations are traceable to NML/ROC and NIST/USA.
 2. The test was performed in HwaYa Shielded Room 1.
 3. The VCCI Site Registration No. is C-2040.

4.2.3 TEST PROCEDURES

- a. The EUT was placed 0.4 meters from the conducting wall of the shielded room with EUT being connected to the power mains through a line impedance stabilization network (LISN). Other support units were connected to the power mains through another LISN. The two LISNs provide 50 ohm/ 50uH of coupling impedance for the measuring instrument.
- b. Both lines of the power mains connected to the EUT were checked for maximum conducted interference.
- c. The frequency range from 150kHz to 30MHz was searched. Emission levels under (Limit - 20dB) was not recorded.

NOTE: All modes of operation were investigated and the worst-case emissions are reported.

4.2.4 DEVIATION FROM TEST STANDARD

No deviation.

4.2.5 TEST SETUP

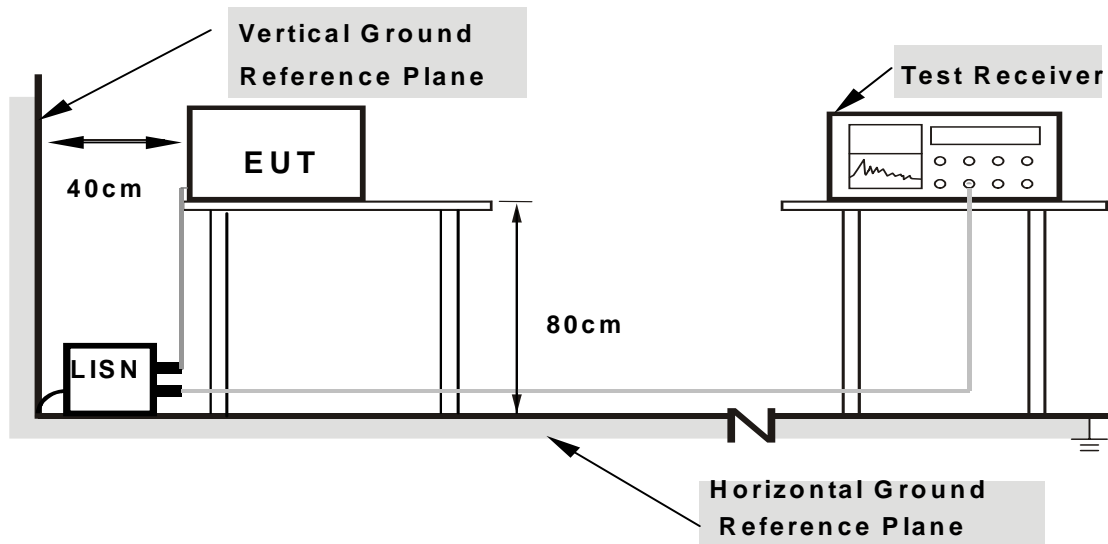

- Note:**
1. Support units were connected to second LISN.
 2. Both of LISNs (AMN) are 80 cm from EUT and at least 80 from other units and other metal planes

For the actual test configuration, please refer to the attached file (Test Setup Photo).

4.2.6 EUT OPERATING CONDITIONS

Same as 4.1.6.

4.2.7 TEST RESULTS

CONDUCTED WORST CASE DATA: GFSK

PHASE	Line 1	6dB BANDWIDTH	9kHz
TEST MODE	A		

No	Freq. [MHz]	Corr. Factor (dB)	Reading Value		Emission Level		Limit		Margin	
			[dB (uV)]		[dB (uV)]		[dB (uV)]		(dB)	
			Q.P.	AV.	Q.P.	AV.	Q.P.	AV.	Q.P.	AV.
1	0.369	0.23	42.07	32.04	42.30	32.27	58.53	48.53	-16.23	-16.26
2	0.564	0.24	32.28	20.69	32.52	20.93	56.00	46.00	-23.48	-25.07
3	0.978	0.20	32.22	19.57	32.42	19.77	56.00	46.00	-23.58	-26.23
4	1.879	0.24	30.15	18.78	30.39	19.02	56.00	46.00	-25.61	-26.98
5	5.727	0.48	30.03	22.46	30.51	22.94	60.00	50.00	-29.49	-27.06
6	22.395	1.35	26.90	16.25	28.25	17.60	60.00	50.00	-31.75	-32.40

- REMARKS:**
1. Q.P. and AV. are abbreviations of quasi-peak and average individually.
 2. "-": The Quasi-peak reading value also meets average limit and measurement with the average detector is unnecessary.
 3. The emission levels of other frequencies were very low against the limit.
 4. Margin value = Emission level - Limit value
 5. Correction factor = Insertion loss + Cable loss
 6. Emission Level = Correction Factor + Reading Value.

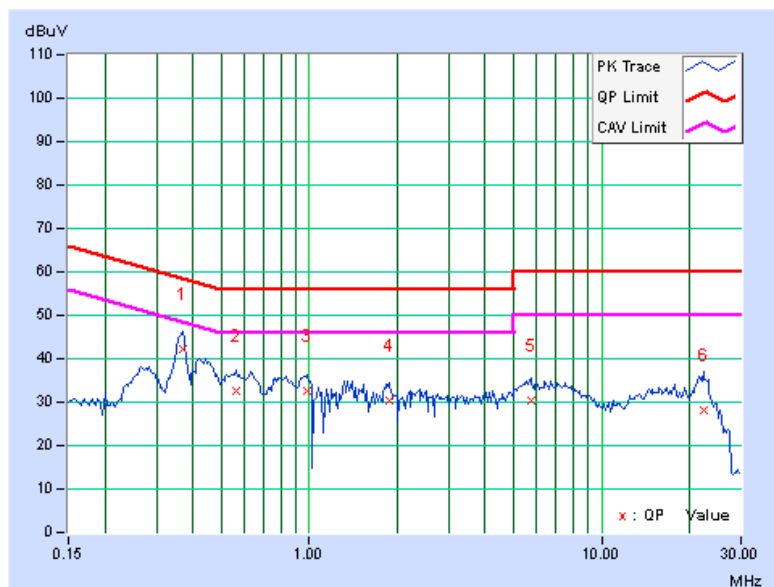

PHASE	Line 2	6dB BANDWIDTH	9kHz
TEST MODE	A		

No	Freq. [MHz]	Corr. Factor (dB)	Reading Value		Emission Level		Limit		Margin	
			[dB (uV)]		[dB (uV)]		[dB (uV)]		(dB)	
			Q.P.	AV.	Q.P.	AV.	Q.P.	AV.	Q.P.	AV.
1	0.365	0.23	39.46	30.35	39.69	30.58	58.62	48.62	-18.93	-18.04
2	0.841	0.26	26.39	17.46	26.65	17.72	56.00	46.00	-29.35	-28.28
3	1.836	0.30	25.32	15.82	25.62	16.12	56.00	46.00	-30.38	-29.88
4	4.379	0.45	21.93	16.04	22.38	16.49	56.00	46.00	-33.62	-29.51
5	7.285	0.57	23.57	13.88	24.14	14.45	60.00	50.00	-35.86	-35.55
6	15.508	0.86	23.09	14.50	23.95	15.36	60.00	50.00	-36.05	-34.64

- REMARKS:**
1. Q.P. and AV. are abbreviations of quasi-peak and average individually.
 2. "-": The Quasi-peak reading value also meets average limit and measurement with the average detector is unnecessary.
 3. The emission levels of other frequencies were very low against the limit.
 4. Margin value = Emission level - Limit value
 5. Correction factor = Insertion loss + Cable loss
 6. Emission Level = Correction Factor + Reading Value.

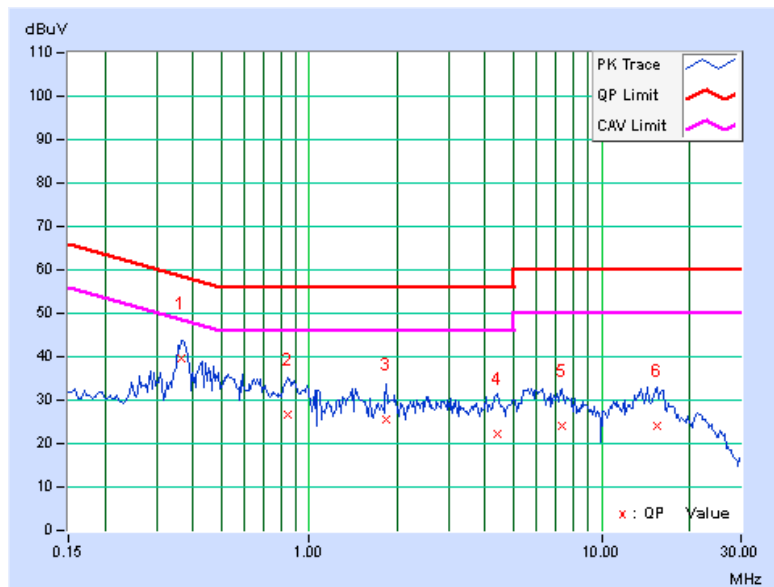

PHASE	Line 1	6dB BANDWIDTH	9kHz
TEST MODE	B		

No	Freq. [MHz]	Corr. Factor (dB)	Reading Value		Emission Level		Limit		Margin	
			[dB (uV)]		[dB (uV)]		[dB (uV)]		(dB)	
			Q.P.	AV.	Q.P.	AV.	Q.P.	AV.	Q.P.	AV.
1	0.154	0.16	42.34	23.69	42.50	23.85	65.79	55.79	-23.28	-31.93
2	0.205	0.14	43.29	20.47	43.43	20.61	63.42	53.42	-19.99	-32.81
3	0.267	0.18	35.43	12.83	35.61	13.01	61.20	51.20	-25.60	-38.20
4	0.392	0.25	22.74	-2.57	22.99	-2.32	58.02	48.02	-35.03	-50.34
5	1.824	0.23	27.03	15.22	27.26	15.45	56.00	46.00	-28.74	-30.55
6	10.430	0.73	28.20	22.25	28.93	22.98	60.00	50.00	-31.07	-27.02

- REMARKS:**
1. Q.P. and AV. are abbreviations of quasi-peak and average individually.
 2. "-": The Quasi-peak reading value also meets average limit and measurement with the average detector is unnecessary.
 3. The emission levels of other frequencies were very low against the limit.
 4. Margin value = Emission level - Limit value
 5. Correction factor = Insertion loss + Cable loss
 6. Emission Level = Correction Factor + Reading Value.

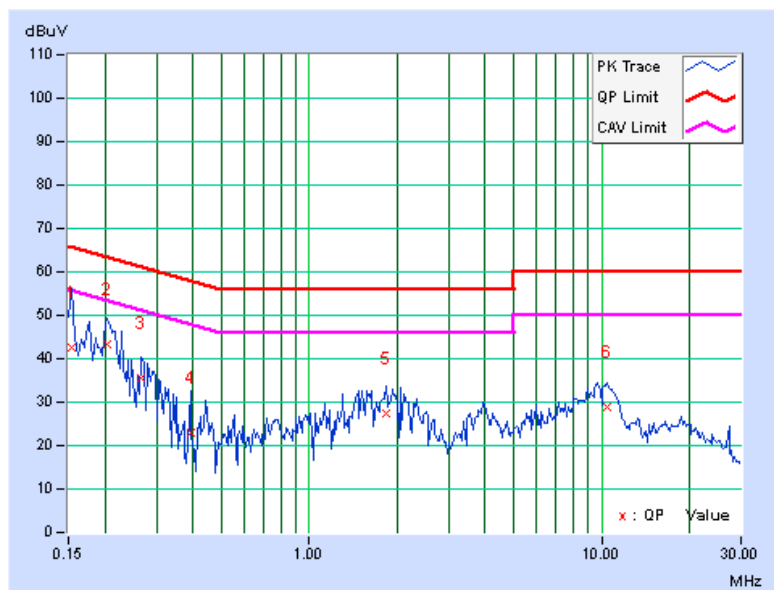

PHASE	Line 2	6dB BANDWIDTH	9kHz
TEST MODE	B		

No	Freq. [MHz]	Corr. Factor (dB)	Reading Value		Emission Level		Limit		Margin	
			[dB (uV)]		[dB (uV)]		[dB (uV)]		(dB)	
			Q.P.	AV.	Q.P.	AV.	Q.P.	AV.	Q.P.	AV.
1	0.150	0.23	43.44	23.71	43.67	23.94	66.00	56.00	-22.33	-32.06
2	0.213	0.21	41.85	21.21	42.06	21.42	63.11	53.11	-21.05	-31.69
3	0.271	0.22	31.82	14.36	32.04	14.58	61.08	51.08	-29.05	-36.51
4	1.430	0.28	27.53	15.16	27.81	15.44	56.00	46.00	-28.19	-30.56
5	1.875	0.30	28.15	14.40	28.45	14.70	56.00	46.00	-27.55	-31.30
6	10.207	0.70	28.44	22.84	29.14	23.54	60.00	50.00	-30.86	-26.46

- REMARKS:**
1. Q.P. and AV. are abbreviations of quasi-peak and average individually.
 2. "-": The Quasi-peak reading value also meets average limit and measurement with the average detector is unnecessary.
 3. The emission levels of other frequencies were very low against the limit.
 4. Margin value = Emission level - Limit value
 5. Correction factor = Insertion loss + Cable loss
 6. Emission Level = Correction Factor + Reading Value.

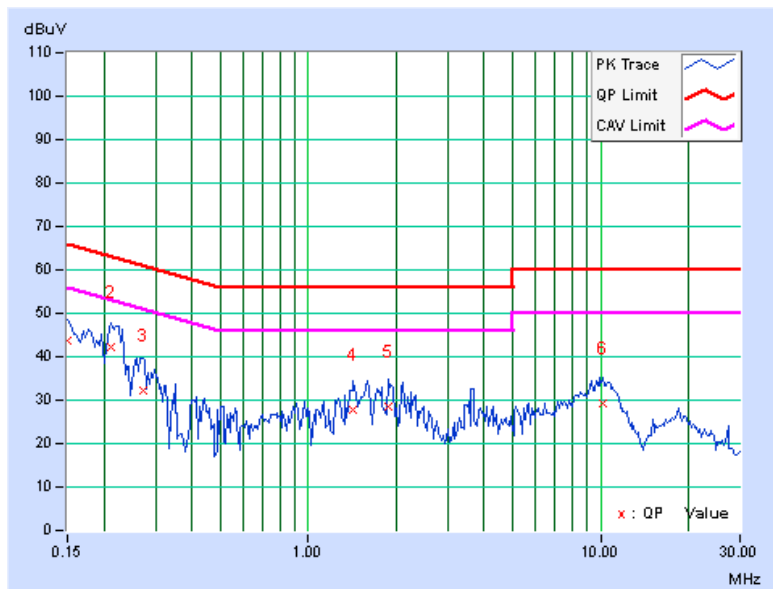

4.3 NUMBER OF HOPPING FREQUENCY USED

4.3.1 LIMIT OF HOPPING FREQUENCY USED

At least 15 channels frequencies, and should be equally spaced.

4.3.2 TEST SETUP

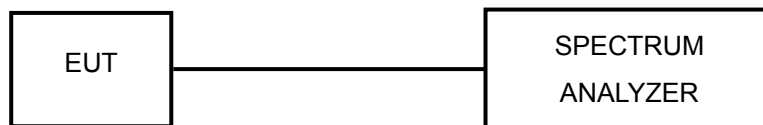

4.3.3 TEST INSTRUMENTS

Refer to section 4.1.2 to get information of above instrument.

4.3.4 TEST PROCEDURES

- a. Check the calibration of the measuring instrument (SA) using either an internal calibrator or a known signal from an external generator.
- b. Turn on the EUT and connect its antenna terminal to measurement via a low loss cable. Then set it to any one measured frequency within its operating range and make sure the instrument is operated in its linear range.
- c. Set the SA on MaxHold Mode, and then keep the EUT in hopping mode. Record all the signals from each channel until each one has been recorded.
- d. Set the SA on View mode and then plot the result on SA screen.
- e. Repeat above procedures until all frequencies measured were complete.

4.3.5 DEVIATION FROM TEST STANDARD

No deviation.

4.3.6 TEST RESULTS

There are 79 hopping frequencies in the hopping mode. Please refer to next two pages for the test result. On the plots, it shows that the hopping frequencies are equally spaced.



A D T

GFSK

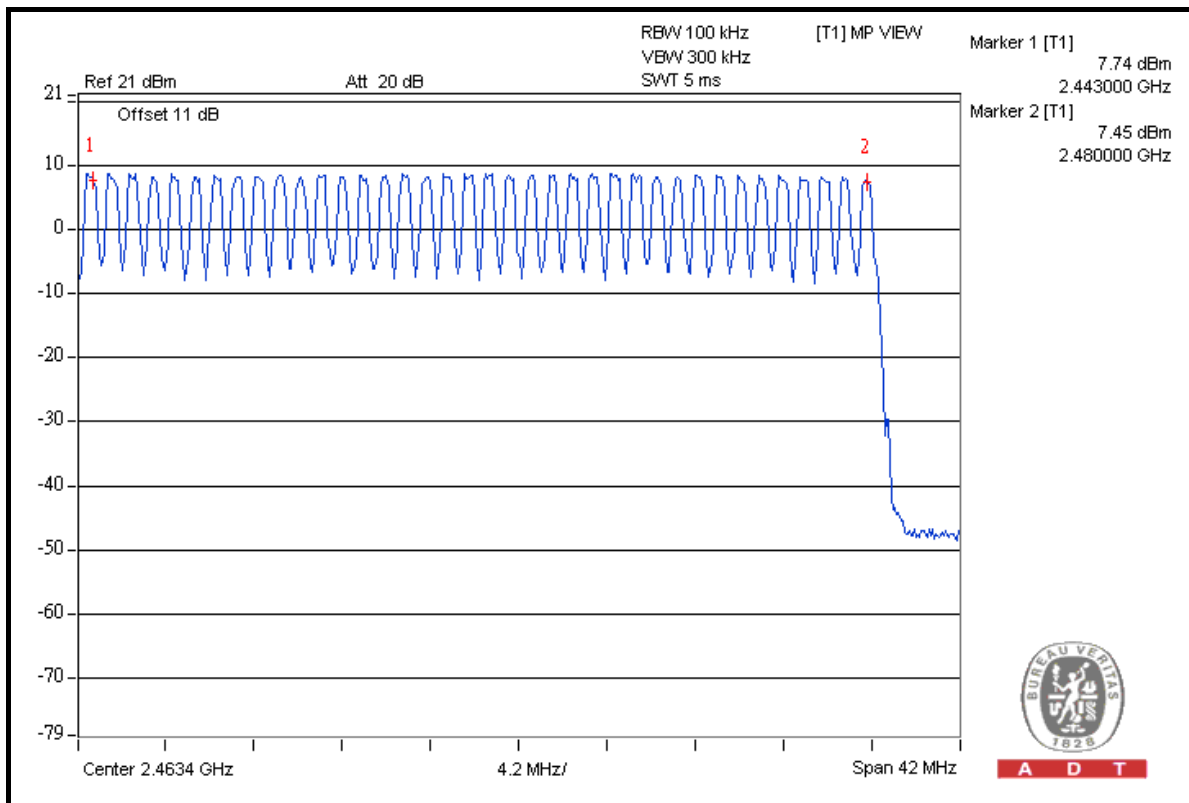
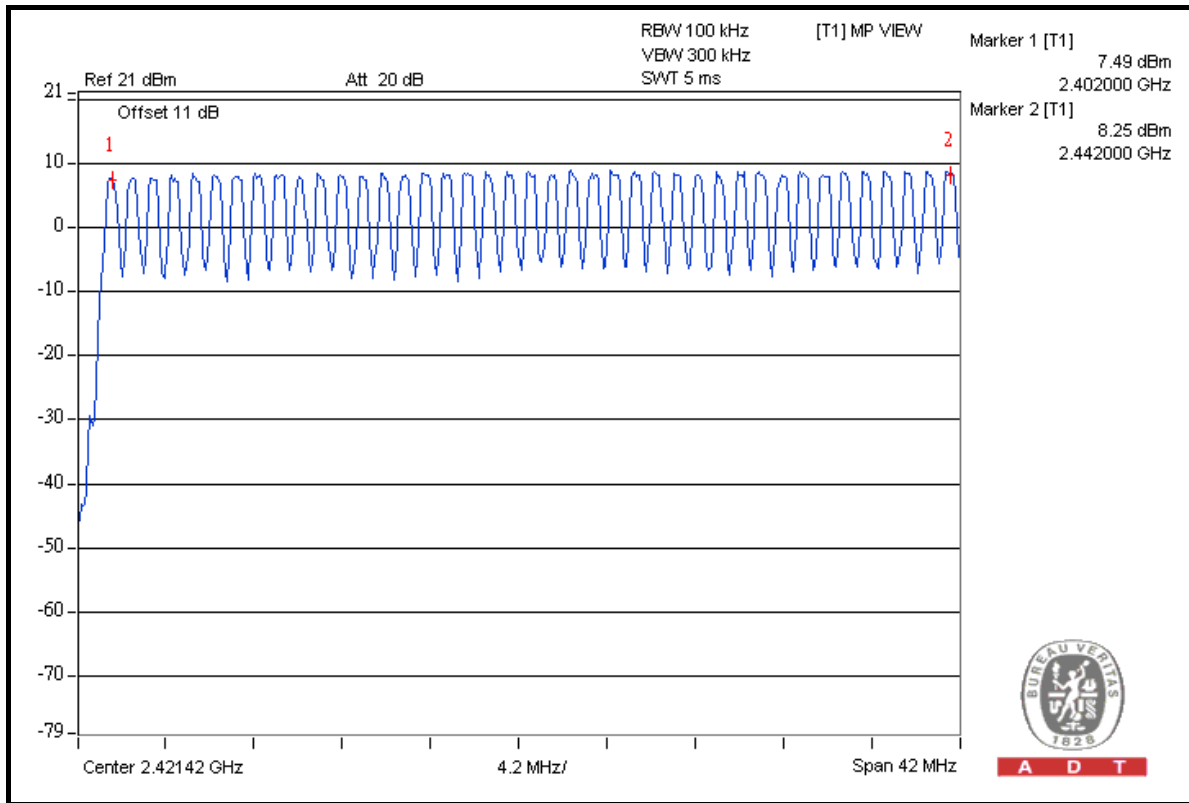



A D T

8DPSK

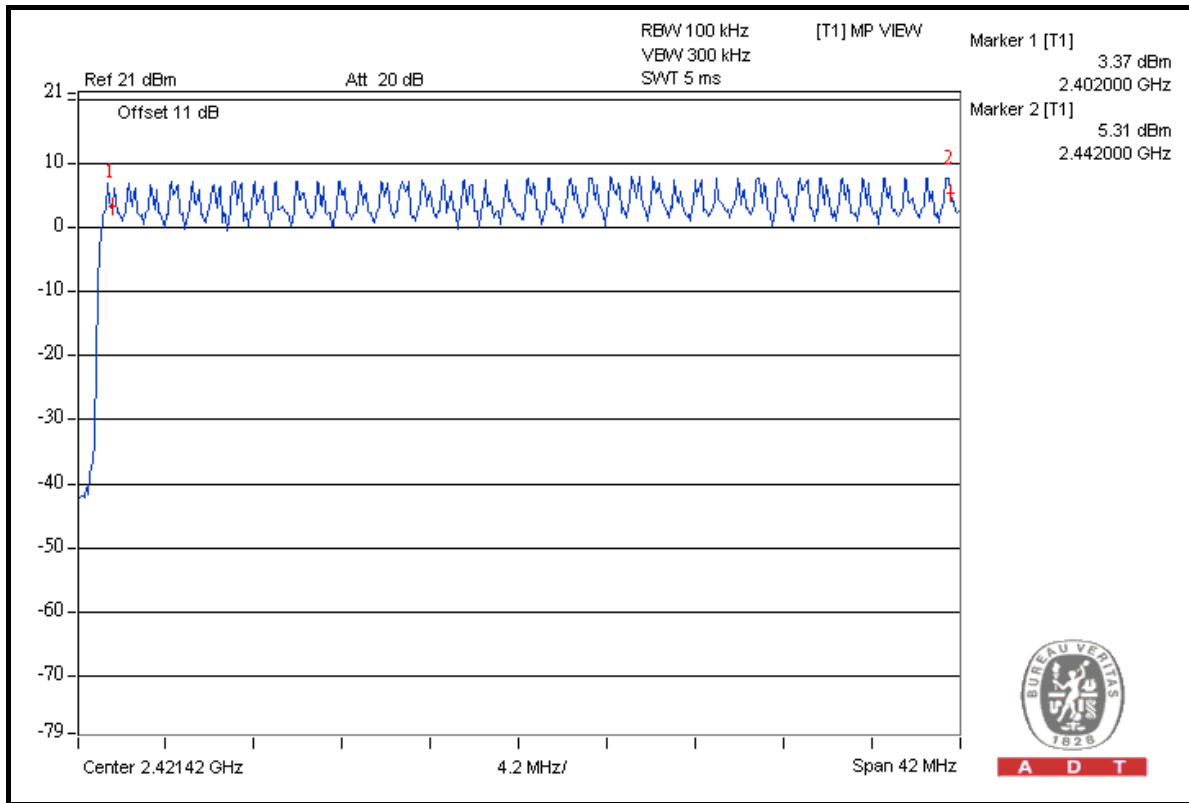

A D T

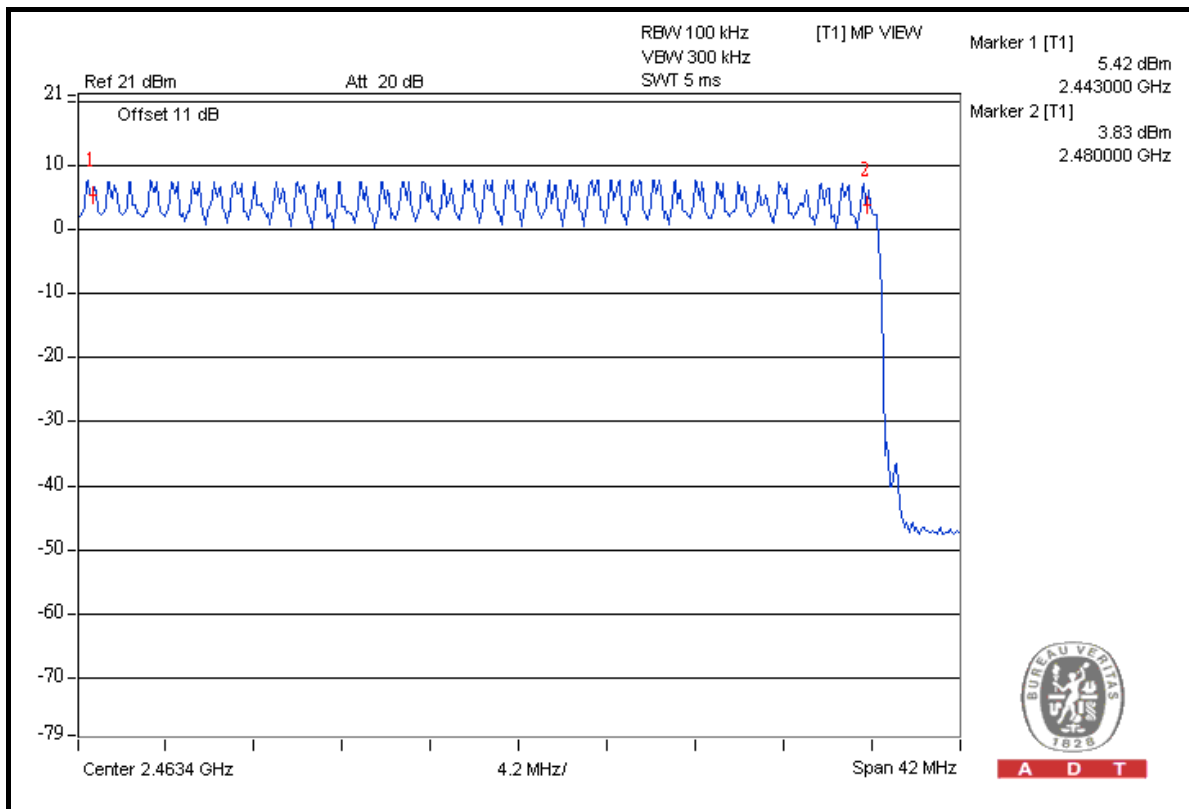

A D T

4.4 DWELL TIME ON EACH CHANNEL

4.4.1 LIMIT OF DWELL TIME USED

The average time of occupancy on any channel shall not be greater than 0.4 seconds within a period of 0.4 seconds multiplied by the number of hopping channels employed.

4.4.2 TEST SETUP

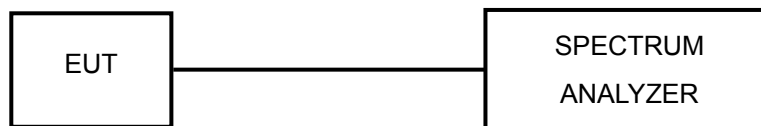

4.4.3 TEST INSTRUMENTS

Refer to section 4.1.2 to get information of above instrument.

4.4.4 TEST PROCEDURES

- a. Check the calibration of the measuring instrument (SA) using either an internal calibrator or a known signal from an external generator.
- b. Turn on the EUT and connect its antenna terminal to measurement via a low loss cable. Then set it to any one measured frequency within its operating range and make sure the instrument is operated in its linear range.
- c. Adjust the center frequency of SA on any frequency be measured and set SA to zero span mode. And then, set RBW and VBW of spectrum analyzer to proper value.
- d. Measure the time duration of one transmission on the measured frequency. And then plot the result with time difference of this time duration.
- e. Repeat above procedures until all different time-slot modes have been completed.

4.4.5 DEVIATION FROM TEST STANDARD

No deviation.

4.4.6 TEST RESULTS

GFSK

Mode	Number of transmission in a 31.6 (79Hopping*0.4)	Length of transmission time (msec)	Result (msec)	Limit (msec)
DH1	52 (times / 5 sec) * 6.32 = 328.64 times	0.444	145.916	400
DH3	27 (times / 5 sec) * 6.32 = 170.64 times	1.680	286.675	400
DH5	17 (times / 5 sec) * 6.32 = 107.44 times	2.930	314.799	400

NOTE: Test plots of the transmitting time slot are shown on next 3 pages.



A D T

DH1

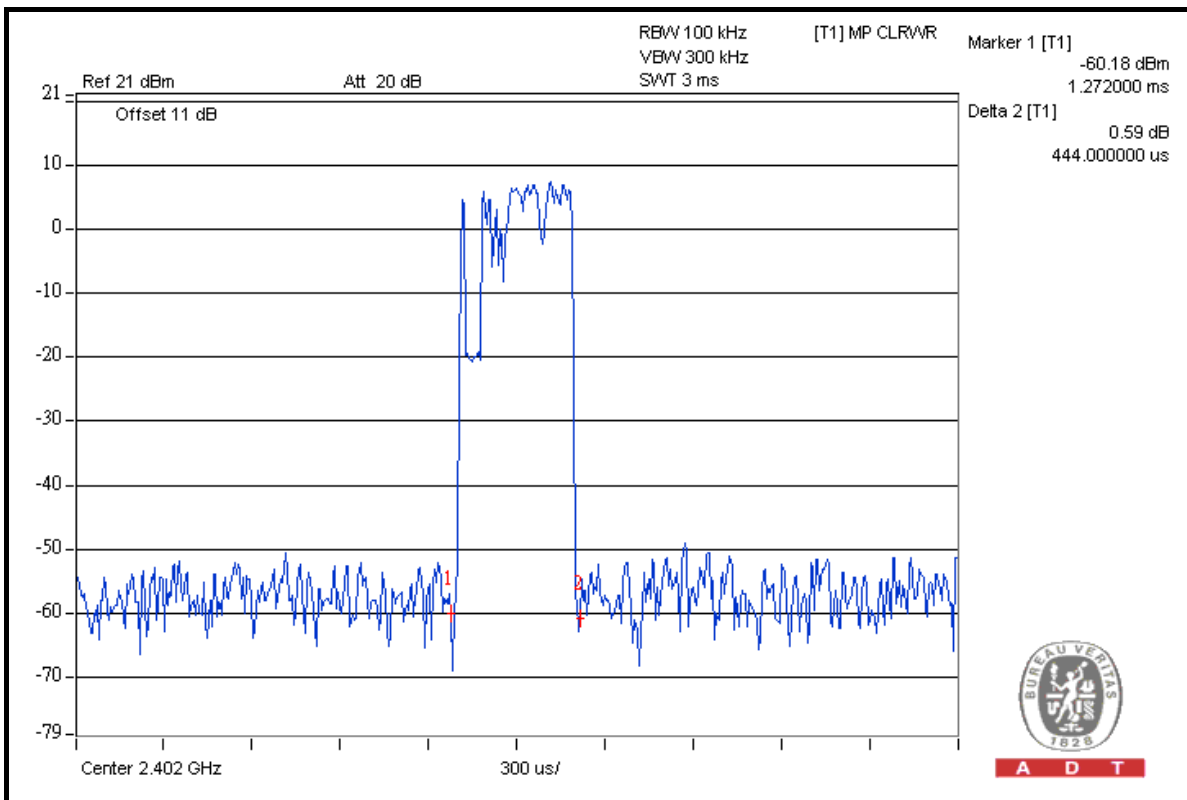
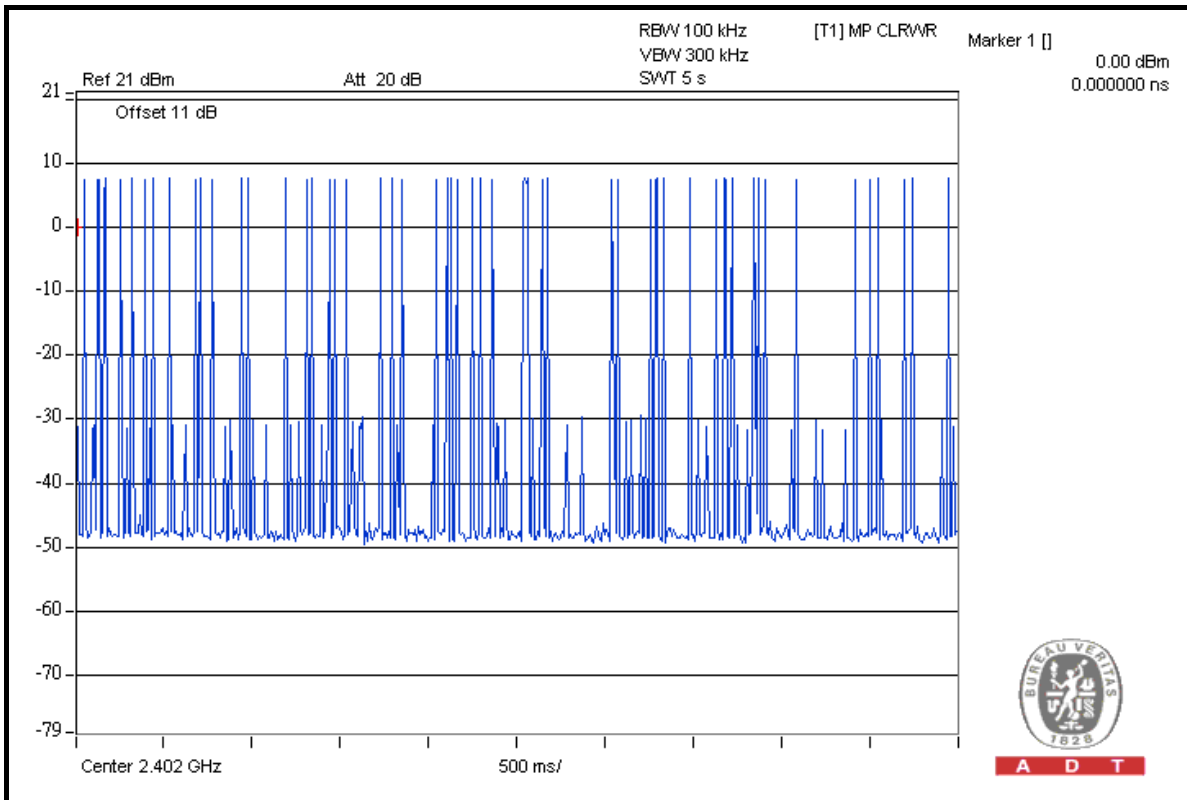



A D T

DH3

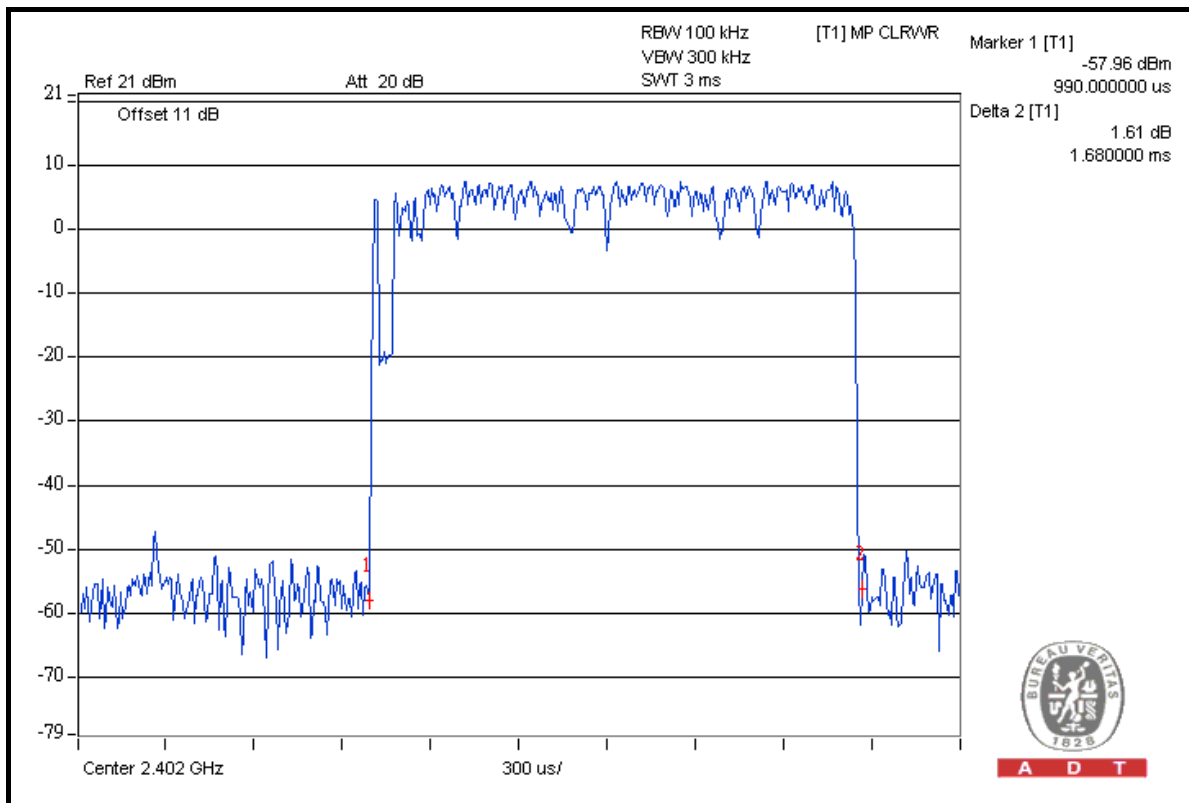
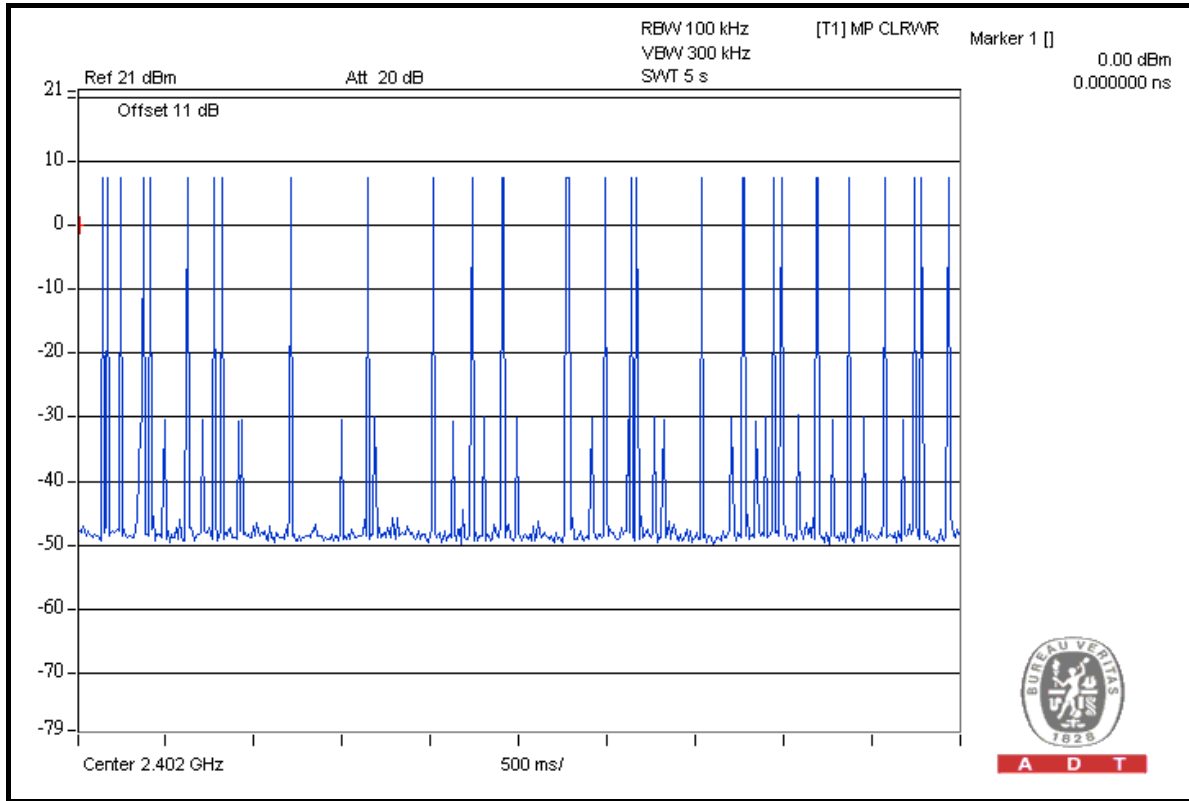



A D T

DH5

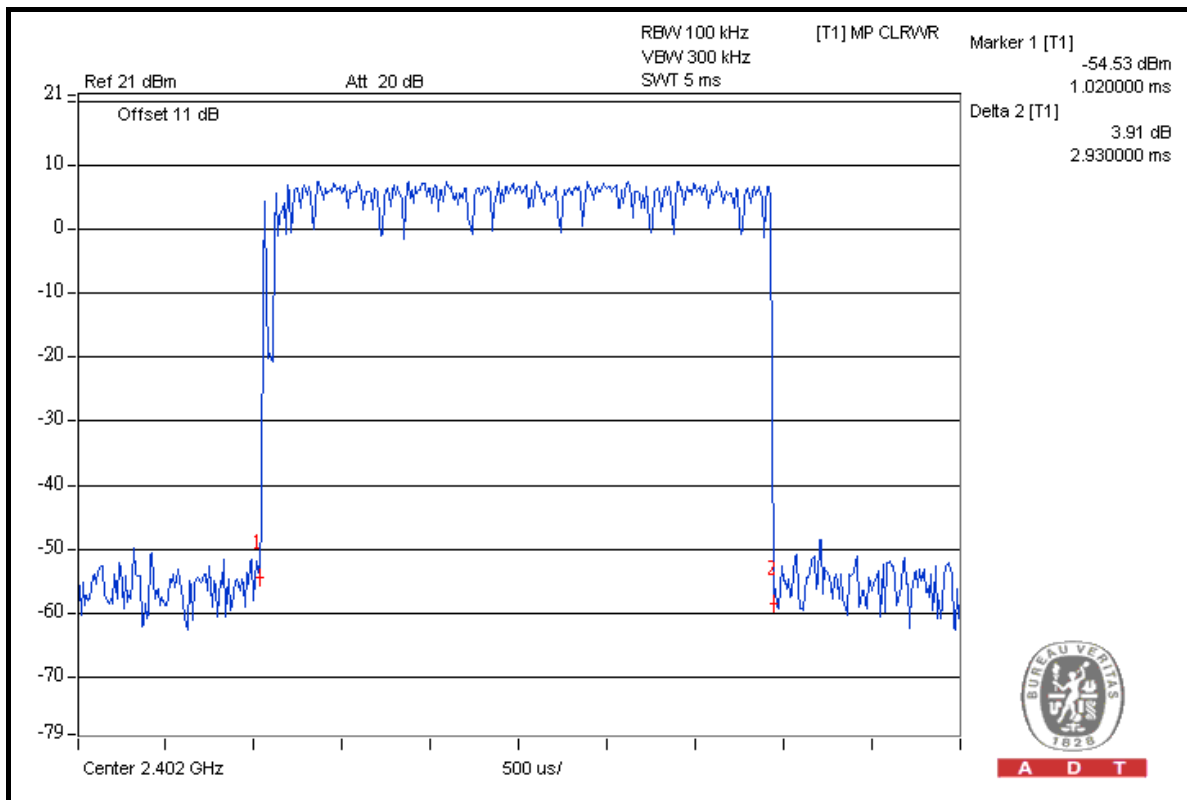
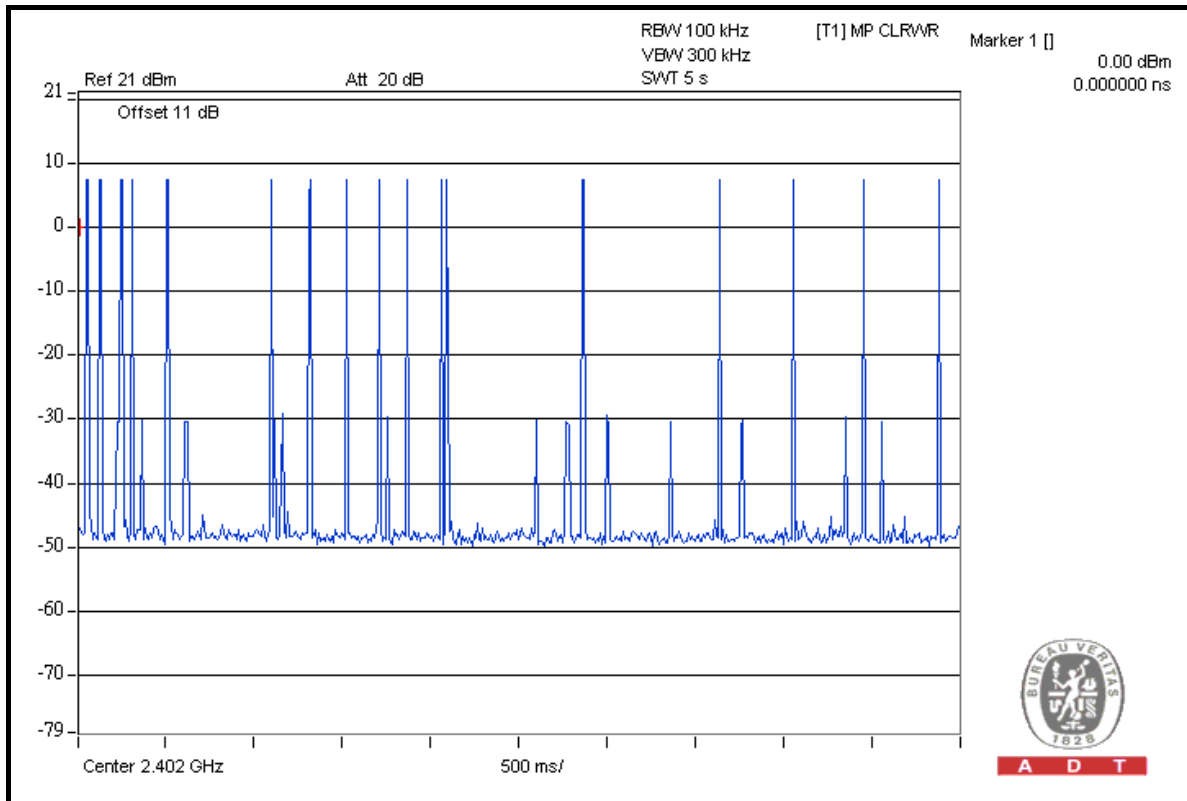



8DPSK

Mode	Number of transmission in a 31.6 (79Hopping*0.4)	Length of transmission time (msec)	Result (msec)	Limit (msec)
DH1	52 (times / 5 sec) * 6.32 = 328.64 times	0.444	145.916	400
DH3	26 (times / 5 sec) * 6.32 = 164.32 times	1.674	275.072	400
DH5	16 (times / 5 sec) * 6.32 = 101.12 times	2.970	300.326	400

NOTE: Test plots of the transmitting time slot are shown on next 3 pages.



A D T

DH1

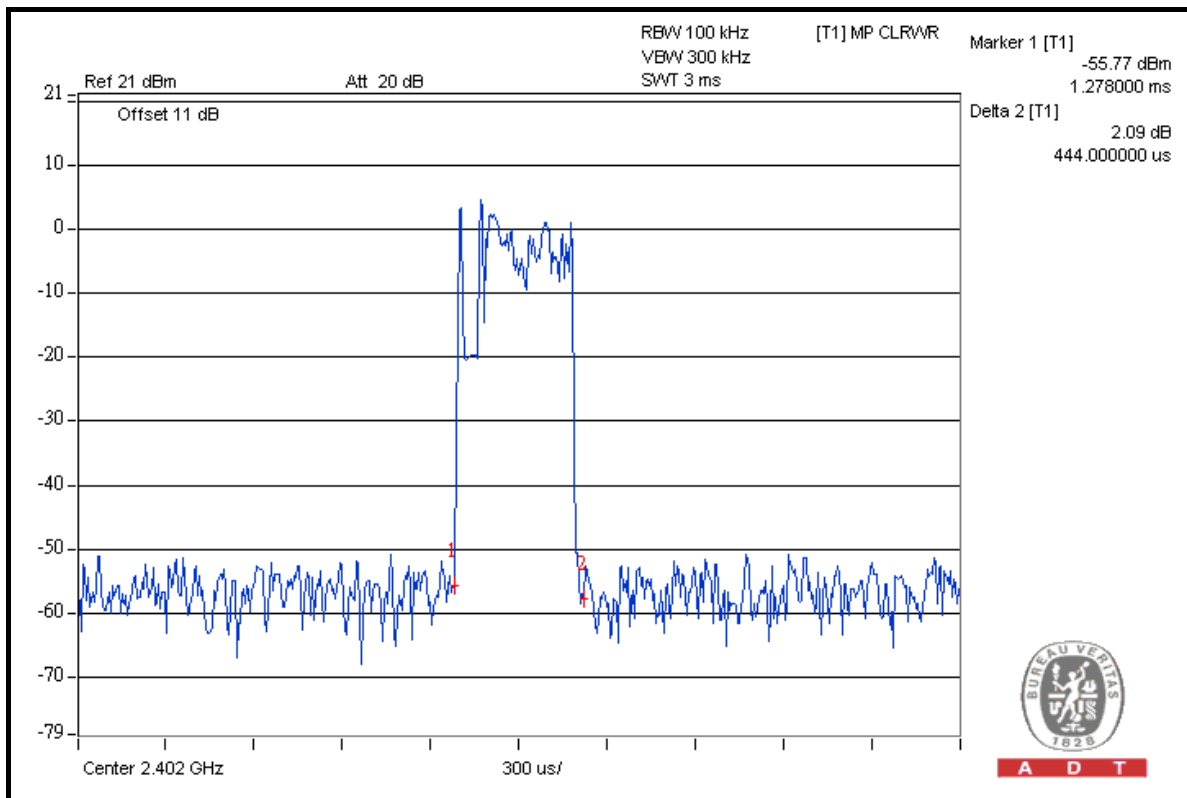
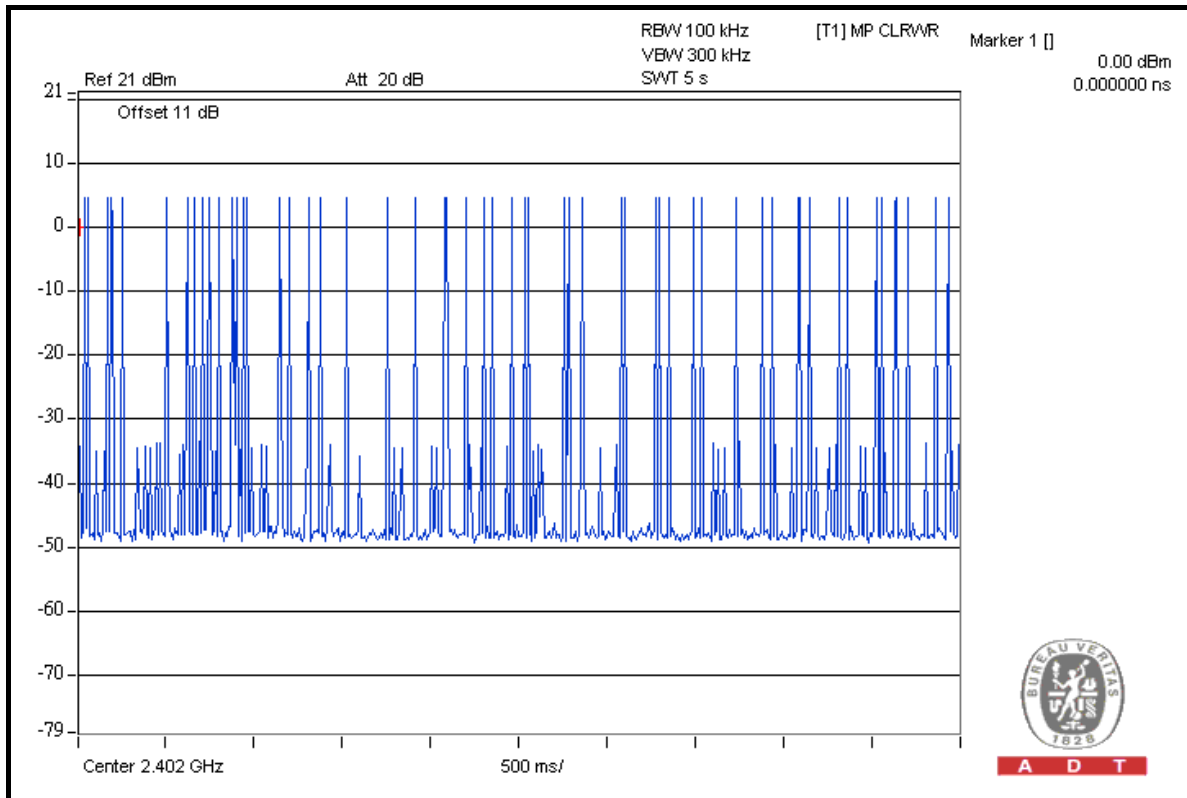



A D T

DH3

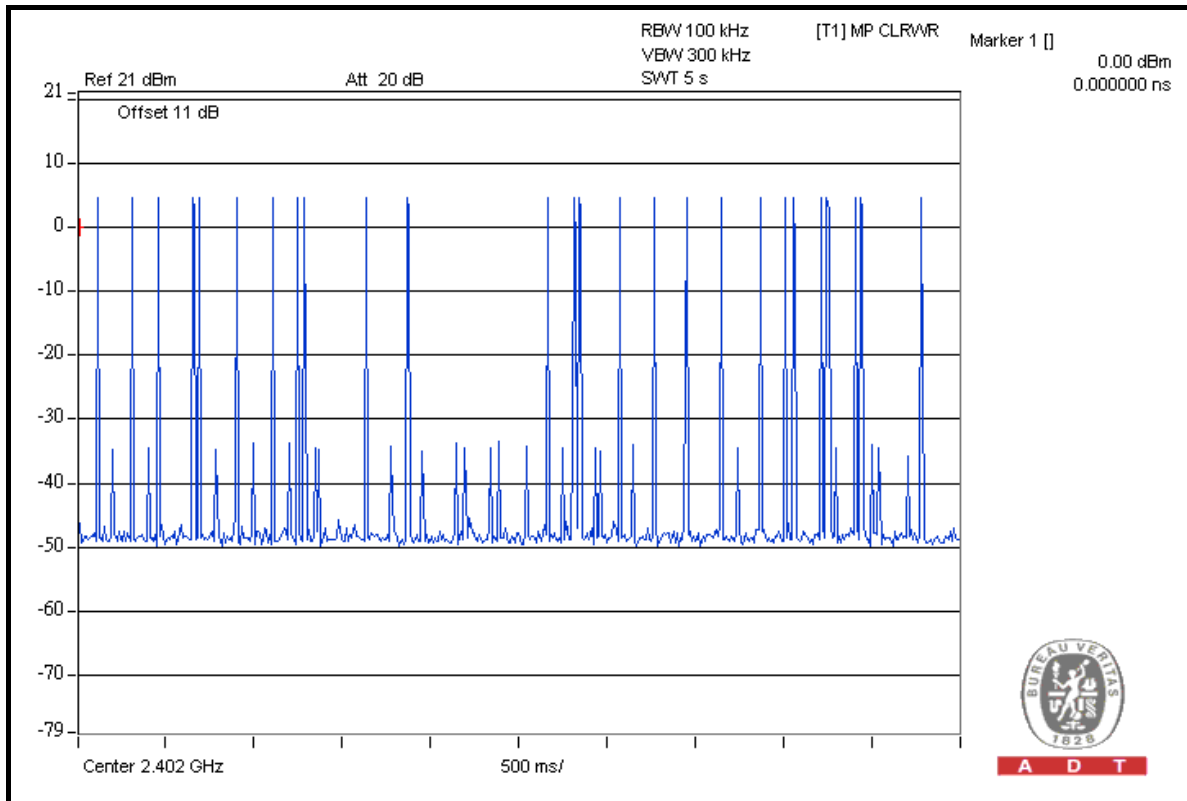

A D T

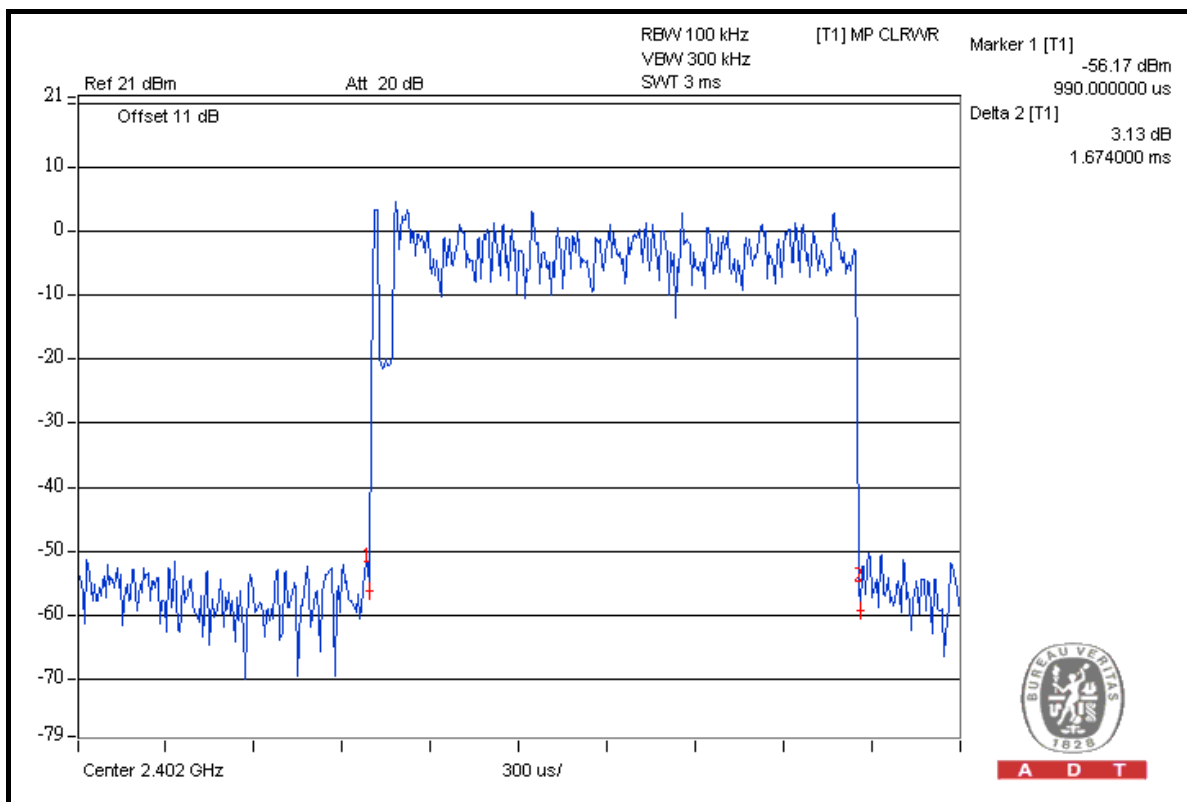

A D T



A D T

DH5

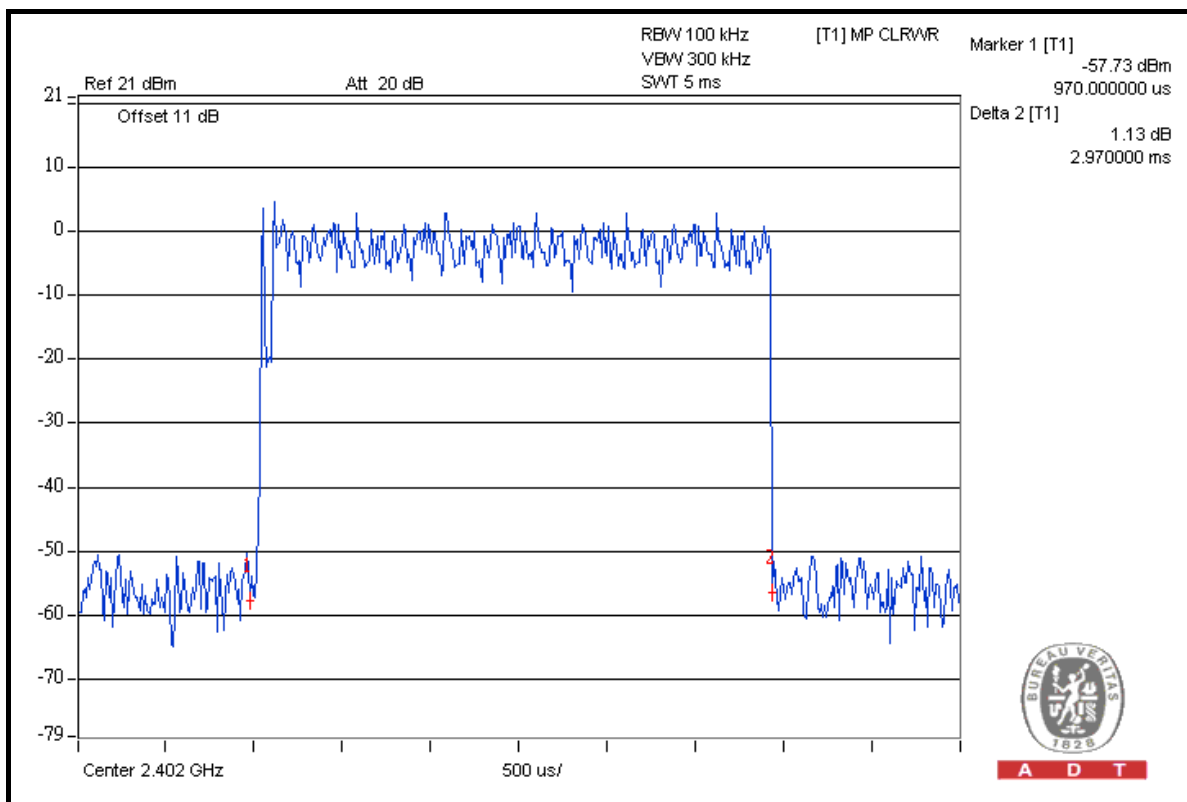
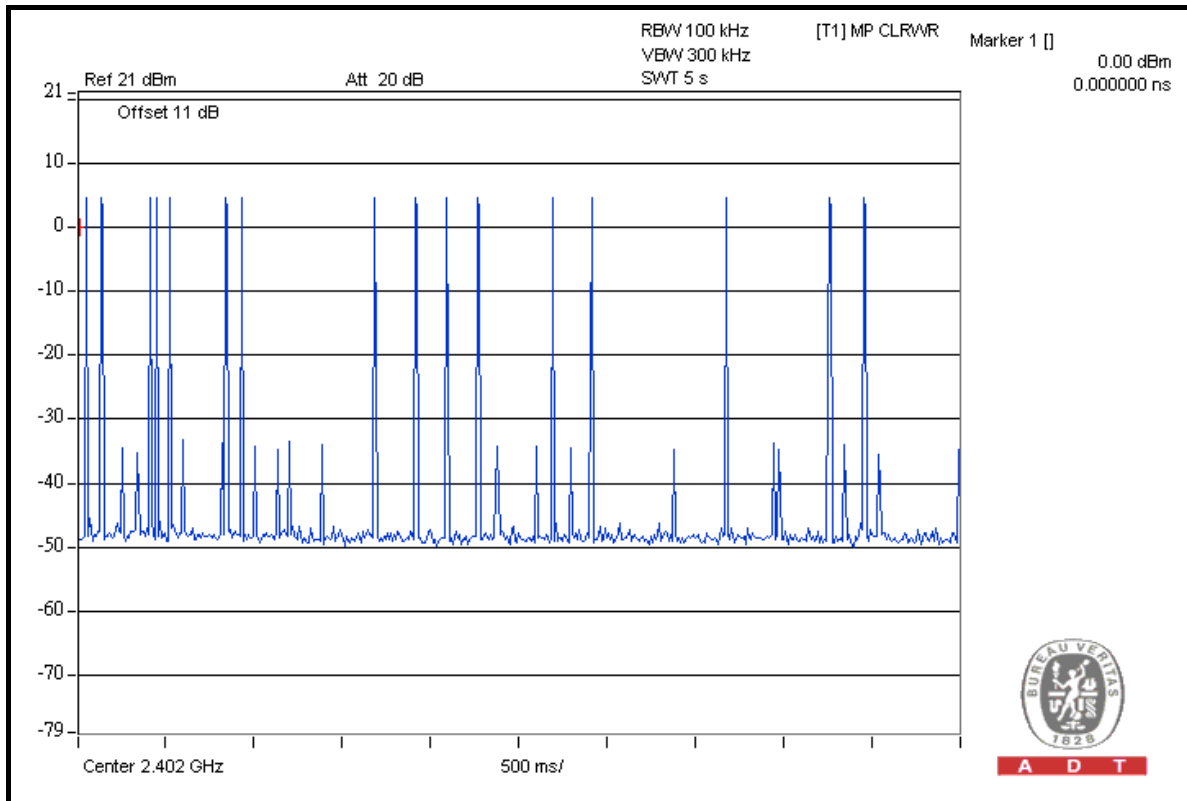

4.5 CHANNEL BANDWIDTH

4.5.1 LIMITS OF CHANNEL BANDWIDTH

For frequency hopping system operating in the 2400-2483.5MHz, If the 20dB bandwidth of hopping channel is greater than 25kHz, two-thirds 20dB bandwidth of hopping channel shall be a minimum limit for the hopping channel separation.

4.5.2 TEST SETUP

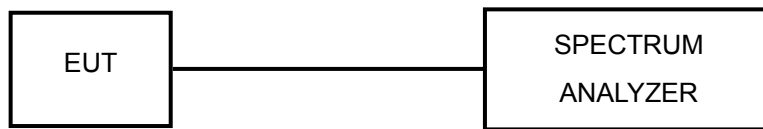

4.5.3 TEST INSTRUMENTS

Refer to section 4.1.2 to get information of above instrument.

4.5.4 TEST PROCEDURE

- a. Check the calibration of the measuring instrument using either an internal calibrator or a known signal from an external generator.
- b. Turn on the EUT and connect it to measurement instrument. Then set it to any one convenient frequency within its operating range. Set a reference level on the measuring instrument equal to the highest peak value.
- c. Measure the frequency difference of two frequencies that were attenuated 20dB from the reference level. Record the frequency difference as the emission bandwidth.
- d. Repeat above procedures until all frequencies measured were complete.

4.5.5 DEVIATION FROM TEST STANDARD

No deviation.

4.5.6 EUT OPERATING CONDITION

The software provided by client enabled the EUT to transmit and receive data at lowest, middle and highest channel frequencies individually.



A D T

4.5.7 TEST RESULTS

GFSK

CHANNEL	CHANNEL FREQUENCY (MHz)	20dB BANDWIDTH (MHz)
0	2402	0.862
39	2441	0.927
78	2480	0.864

CH 39

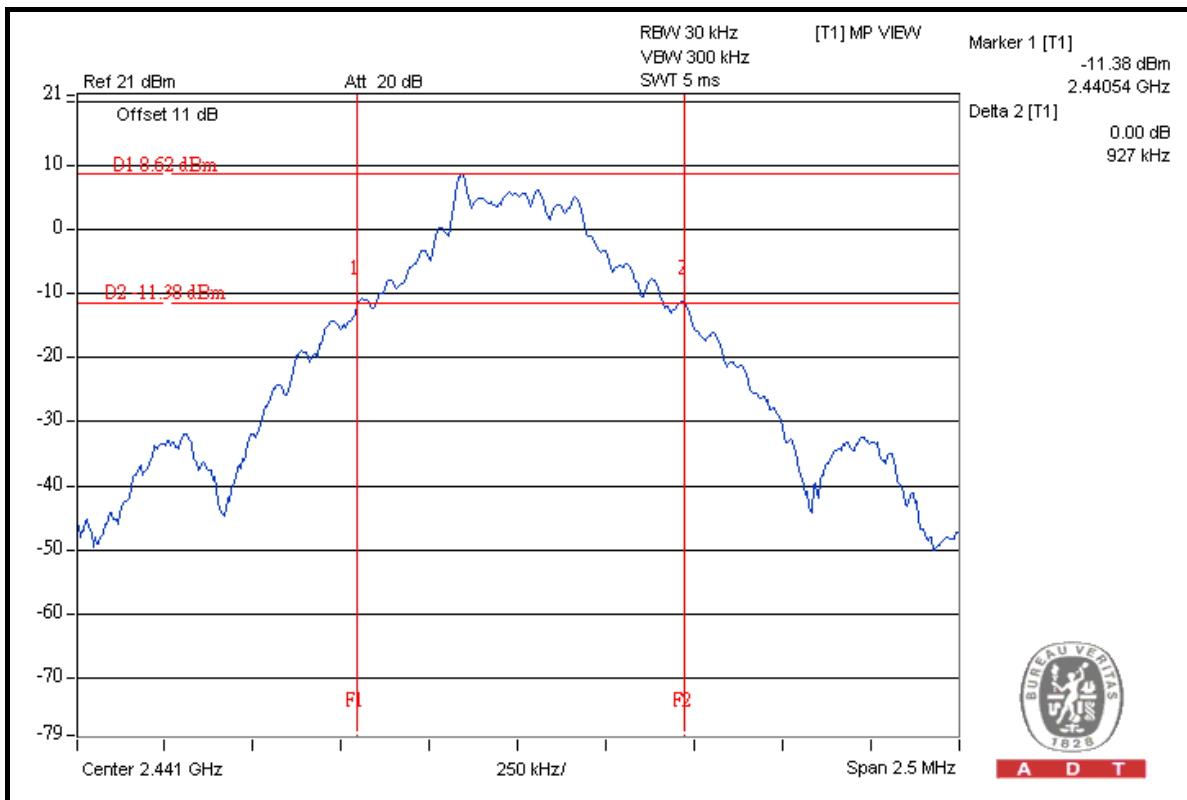



A D T

8DPSK

CHANNEL	CHANNEL FREQUENCY (MHz)	20dB BANDWIDTH (MHz)
0	2402	1.210
39	2441	1.270
78	2480	1.240

CH 39

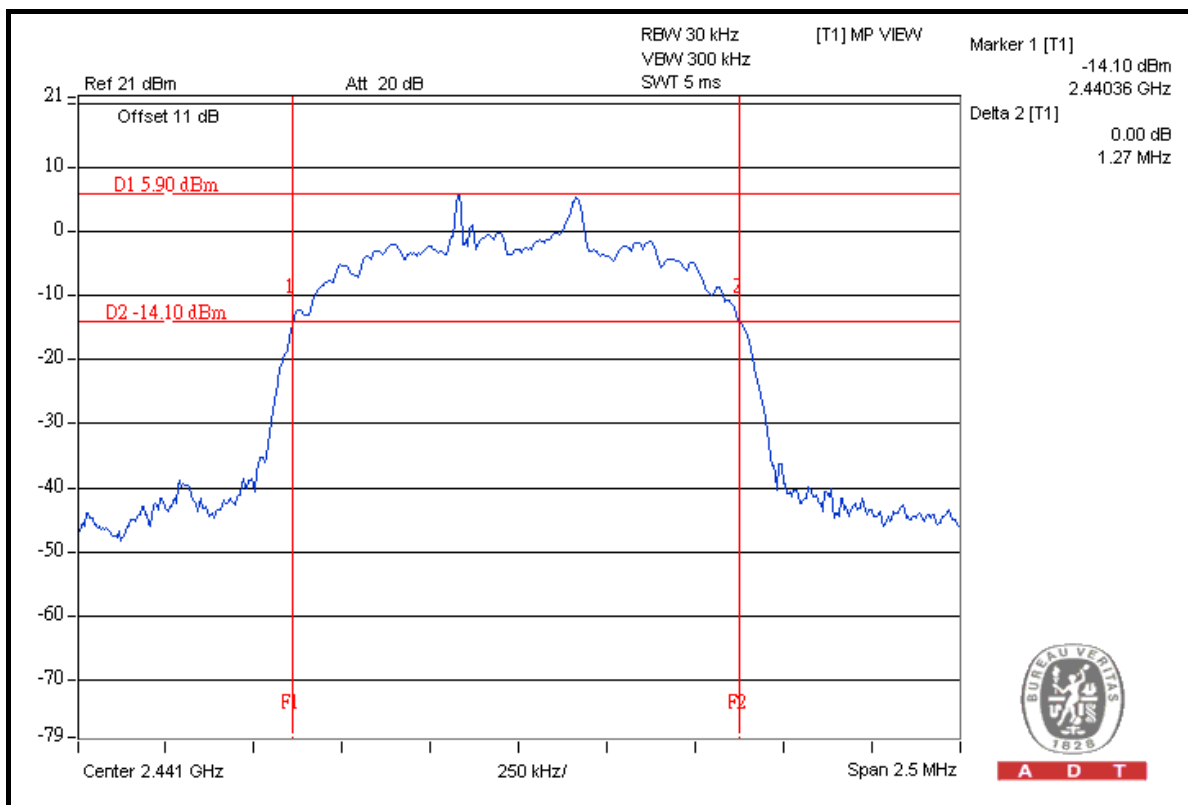

4.6 HOPPING CHANNEL SEPARATION

4.6.1 LIMIT OF HOPPING CHANNEL SEPARATION

At least 25kHz or two-third of 20dB hopping channel bandwidth (whichever is greater).

4.6.2 TEST SETUP

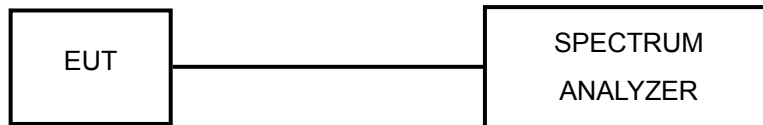

4.6.3 TEST INSTRUMENTS

Refer to section 4.1.2 to get information of above instrument.

4.6.4 TEST PROCEDURES

1. Check the calibration of the measuring instrument using either an internal calibrator or a known signal from an external generator.
2. Turn on the EUT and connect it to measurement instrument. Then set it to any one convenient frequency within its operating range.
3. By using the MaxHold function record the separation of two adjacent channels.
4. Measure the frequency difference of these two adjacent channels by SA MARK function. And then plot the result on SA screen.
5. Repeat above procedures until all frequencies measured were complete.

4.6.5 DEVIATION FROM TEST STANDARD

No deviation.



A D T

4.6.6 TEST RESULTS

GFSK

CHANNEL	FREQUENCY (MHz)	ADJACENT CHANNEL SEPARATION (MHz)	20dB BANDWIDTH (MHz)	MINIMUM LIMIT (MHz)	PASS / FAIL
0	2402	1.010	0.862	0.575	PASS
39	2441	1.000	0.927	0.618	PASS
78	2480	1.000	0.864	0.576	PASS

8DPSK

CHANNEL	FREQUENCY (MHz)	ADJACENT CHANNEL SEPARATION (MHz)	20dB BANDWIDTH (MHz)	MINIMUM LIMIT (MHz)	PASS / FAIL
0	2402	1.010	1.210	0.807	PASS
39	2441	1.000	1.270	0.847	PASS
78	2480	1.010	1.240	0.827	PASS

NOTE: The minimum limit is two-third 20dB bandwidth.

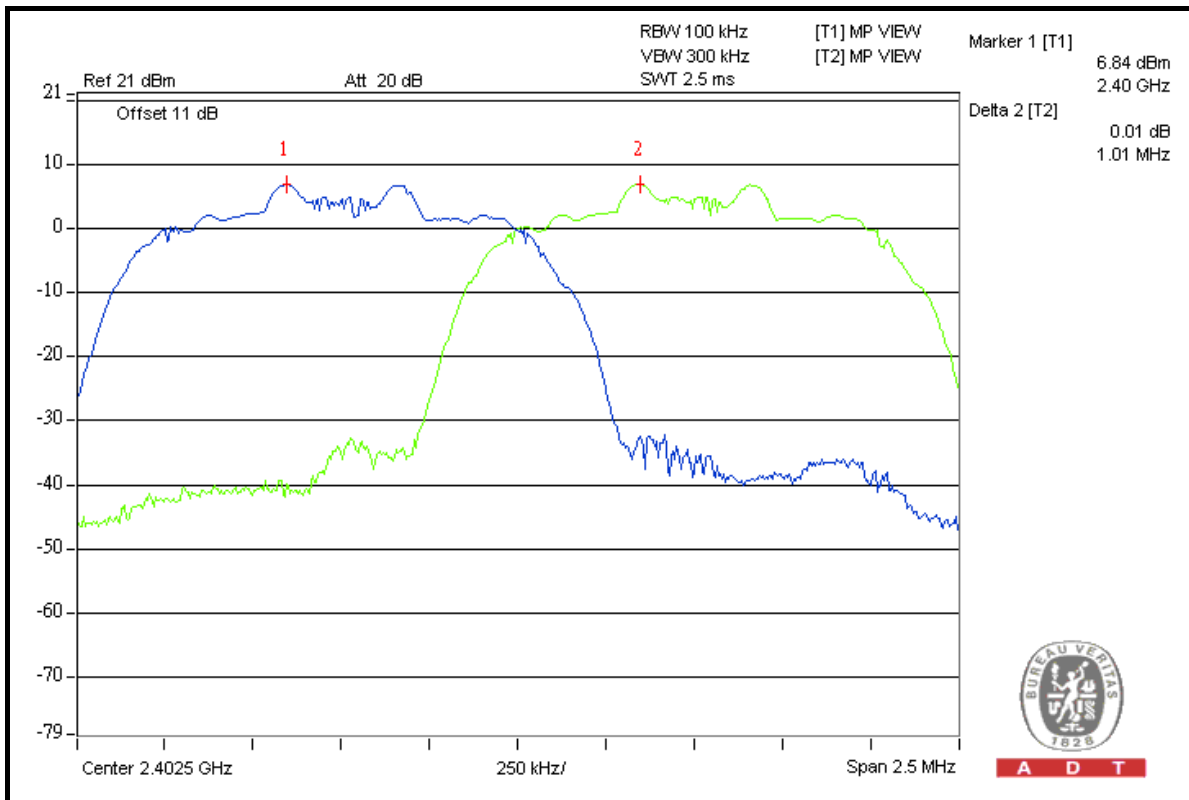

A D T

4.7 MAXIMUM OUTPUT POWER

4.7.1 LIMITS OF MAXIMUM OUTPUT POWER MEASUREMENT

The Maximum Peak Output Power Measurement is 125mW.

4.7.2 TEST SETUP

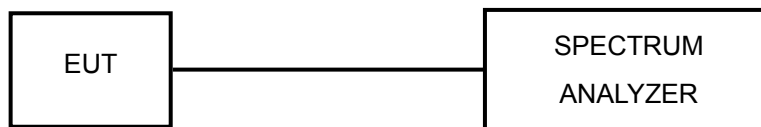

4.7.3 TEST INSTRUMENTS

Refer to section 4.1.2 to get information of above instrument.

4.7.4 TEST PROCEDURES

- a. Check the calibration of the measuring instrument using either an internal calibrator or a known signal from an external generator.
- b. Turn on the EUT and connect it to measurement instrument. Then set it to any one convenient frequency within its operating range. Set a reference level on the measuring instrument equal to the highest peak value.
- c. The center frequency of the spectrum analyzer is set to the fundamental frequency and using 3MHz RBW and 10 MHz VBW.
- d. Measure the captured power within the band and recording the plot.
- e. Repeat above procedures until all frequencies required were complete.

4.7.5 DEVIATION FROM TEST STANDARD

No deviation.

4.7.6 EUT OPERATING CONDITION

The software provided by client enabled the EUT to transmit and receive data at lowest, middle and highest channel frequencies individually.



A D T

4.7.7 TEST RESULTS

GFSK

CHANNEL	CHANNEL FREQUENCY (MHz)	POWER OUTPUT (mW)	POWER OUTPUT (dBm)	POWER LIMIT (mW)	PASS/FAIL
0	2402	7.161	8.55	125	PASS
39	2441	8.017	9.04	125	PASS
78	2480	7.112	8.52	125	PASS

CH 39

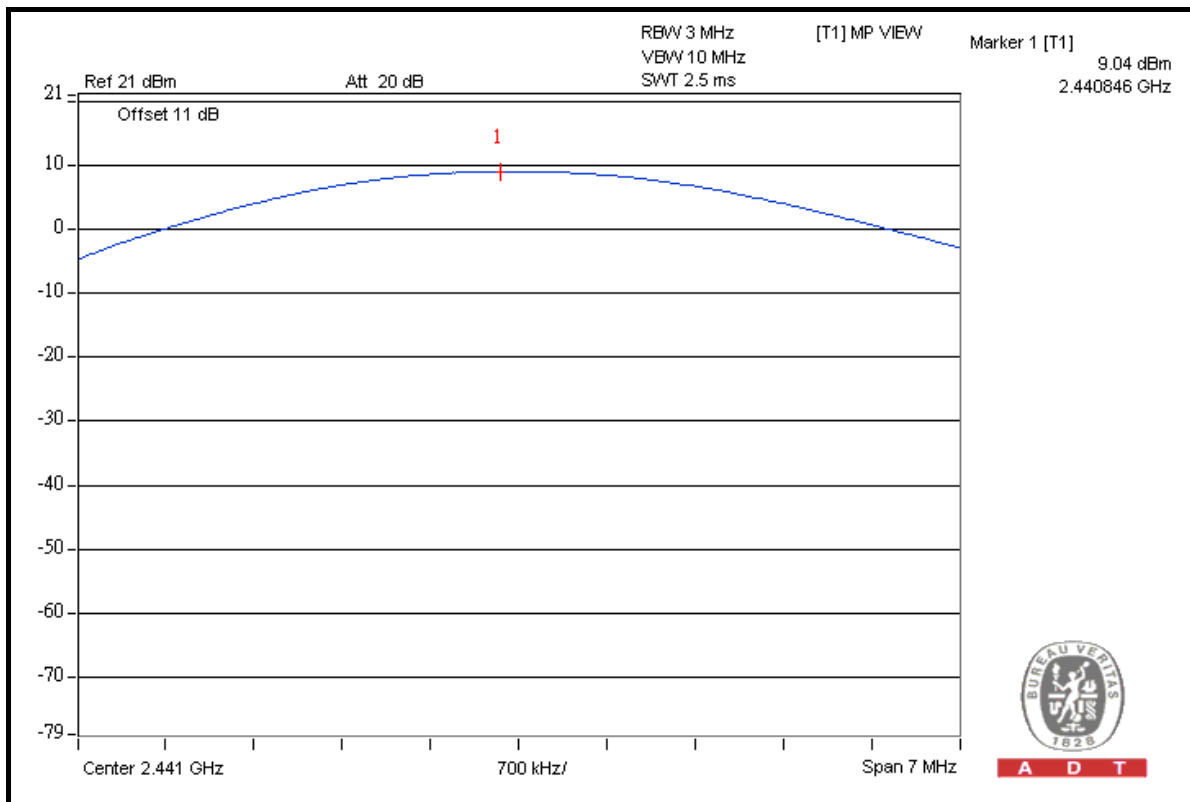



A D T

8DPSK

CHANNEL	CHANNEL FREQUENCY (MHz)	POWER OUTPUT (mW)	POWER OUTPUT (dBm)	POWER LIMIT (mW)	PASS/FAIL
0	2402	6.714	8.27	125	PASS
39	2441	7.674	8.85	125	PASS
78	2480	7.261	8.61	125	PASS

CH 39

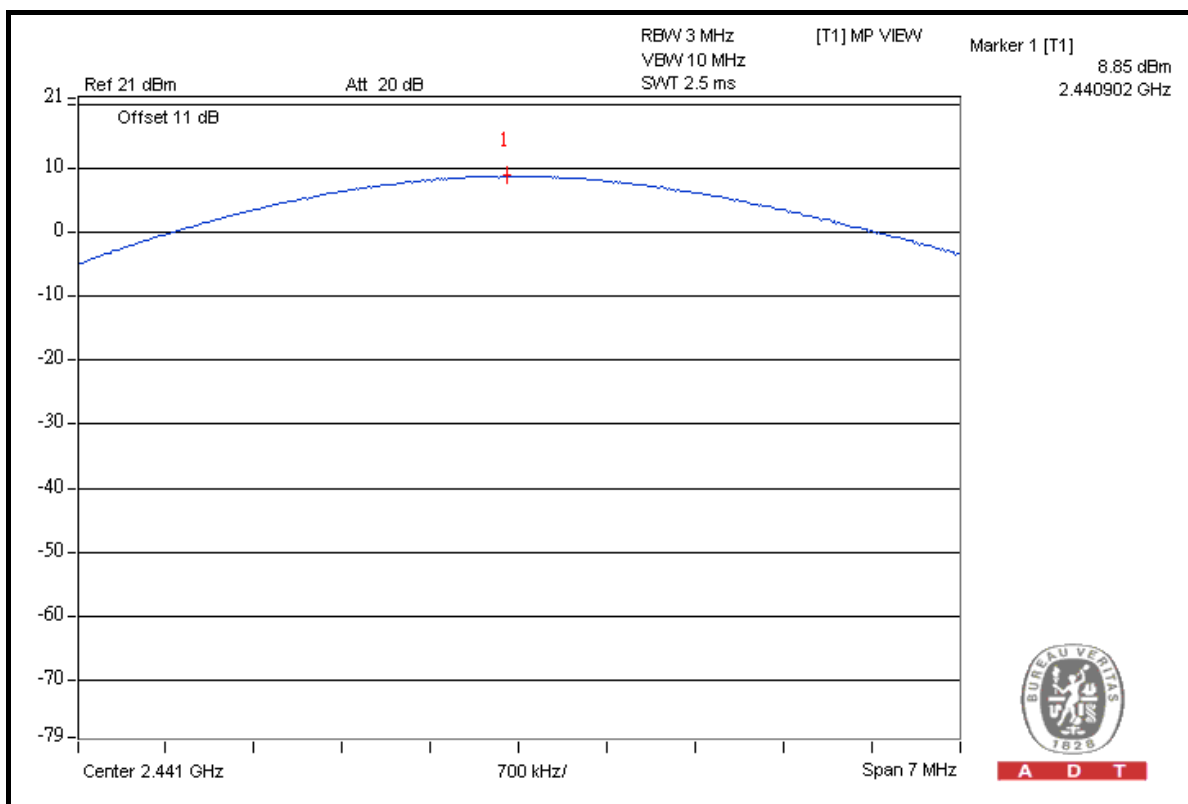

4.8 BAND EDGES MEASUREMENT

4.8.1 LIMITS OF BAND EDGES MEASUREMENT

Below –20dB of the highest emission level of operating band (in 100KHz RBW).

4.8.2 TEST INSTRUMENTS

Refer to section 4.1.2 to get information of above instrument.

4.8.3 TEST PROCEDURE

The transmitter output was connected to the spectrum analyzer via a low lose cable. Set both RBW and VBW of spectrum analyzer to 100 kHz with suitable frequency span including 100 MHz bandwidth from band edge. The band edges was measured and recorded.

4.8.4 DEVIATION FROM TEST STANDARD

No deviation.

4.8.5 EUT OPERATING CONDITION

The software provided by client enabled the EUT to transmit and receive data at lowest, middle and highest channel frequencies individually.

4.8.6 TEST RESULTS

The spectrum plots are attached on the following images. D1 line indicates the highest level, D2 line indicates the 20dB offset below D1. It shows compliance with the requirement in part 15.247(d).

GFSK

RESTRICT BAND (2310 ~ 2390 MHz)

FREQUENCY (MHz)	FUNDAMENTAL EMISSION (dBuV/m)	DELTA (dB)	MAXIMUM FIELD STRENGTH IN RESTRICT BAND (dBuV/m)	LIMIT (dBuV/m)
2402.00 (PK)	101.9	54.77	47.13	74.00
2402.00 (AV)	-	-	17.03	54.00

RESTRICT BAND (2483.5 ~ 2500 MHz)

FREQUENCY (MHz)	FUNDAMENTAL EMISSION (dBuV/m)	DELTA (dB)	MAXIMUM FIELD STRENGTH IN RESTRICT BAND (dBuV/m)	LIMIT (dBuV/m)
2480.00 (PK)	100.2	55.58	44.62	74.00
2480.00 (AV)	-	-	14.52	54.00

NOTE:

1. Delta = Amplitude between the peak of the fundamental and the peak of the band edge emission. Please check following 2 pages.
2. Maximum field strength in restrict band (PK value) = Fundamental emission (PK value) – Delta.
3. Average value = Peak value + 20 Log (duty cycle) = Peak value – 30.1dB.
4. The DH5 packet was the worse case duty cycle for a transmit dwell time on a channel, based upon Bluetooth theory the transmitter is on 0.625 * 5 per 296.25 ms per channel. Therefore, the duty cycle correction factor be equal to: $20\log(3.125/100) = -30.1$ dB.



A D T

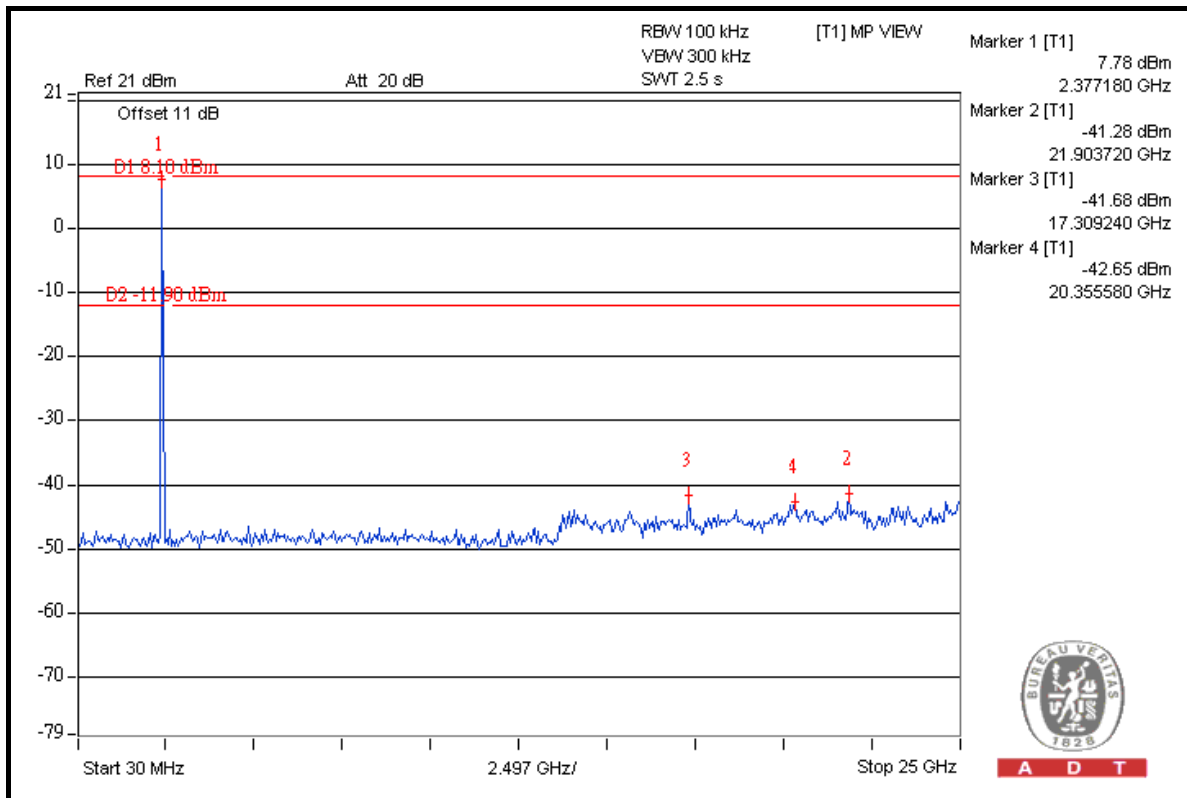
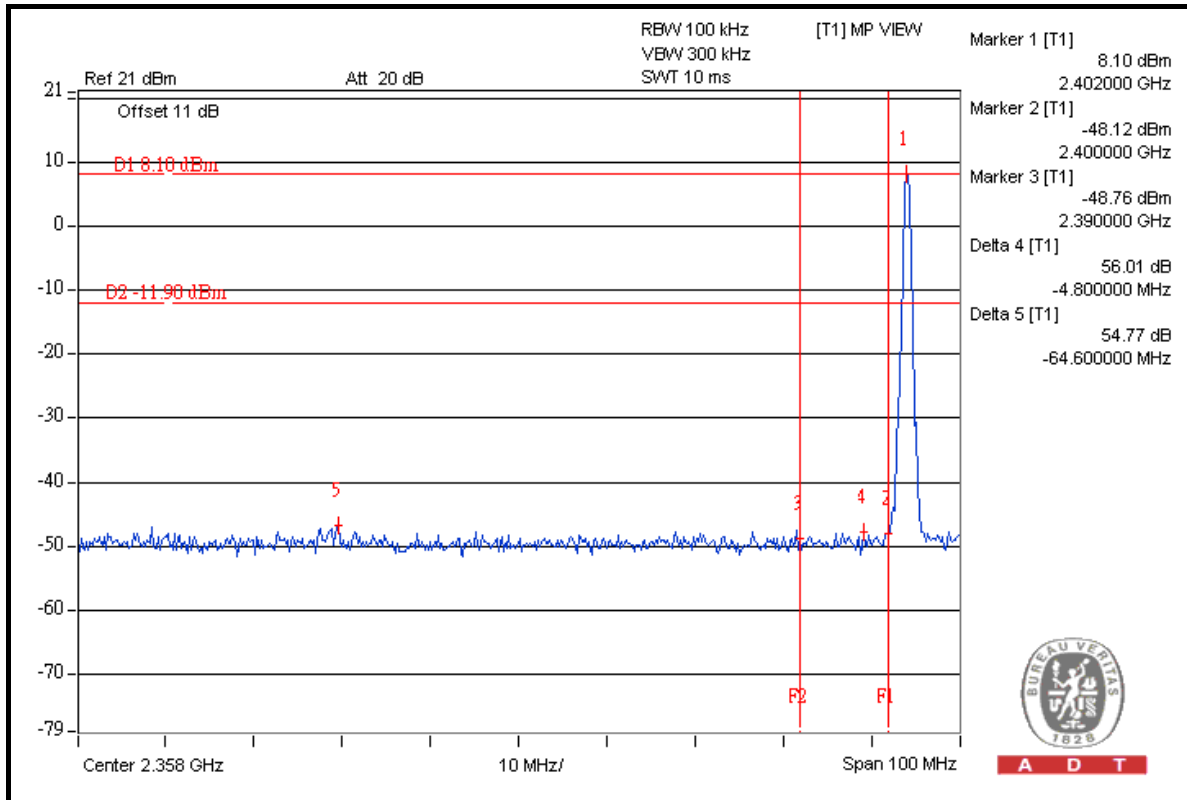



A D T

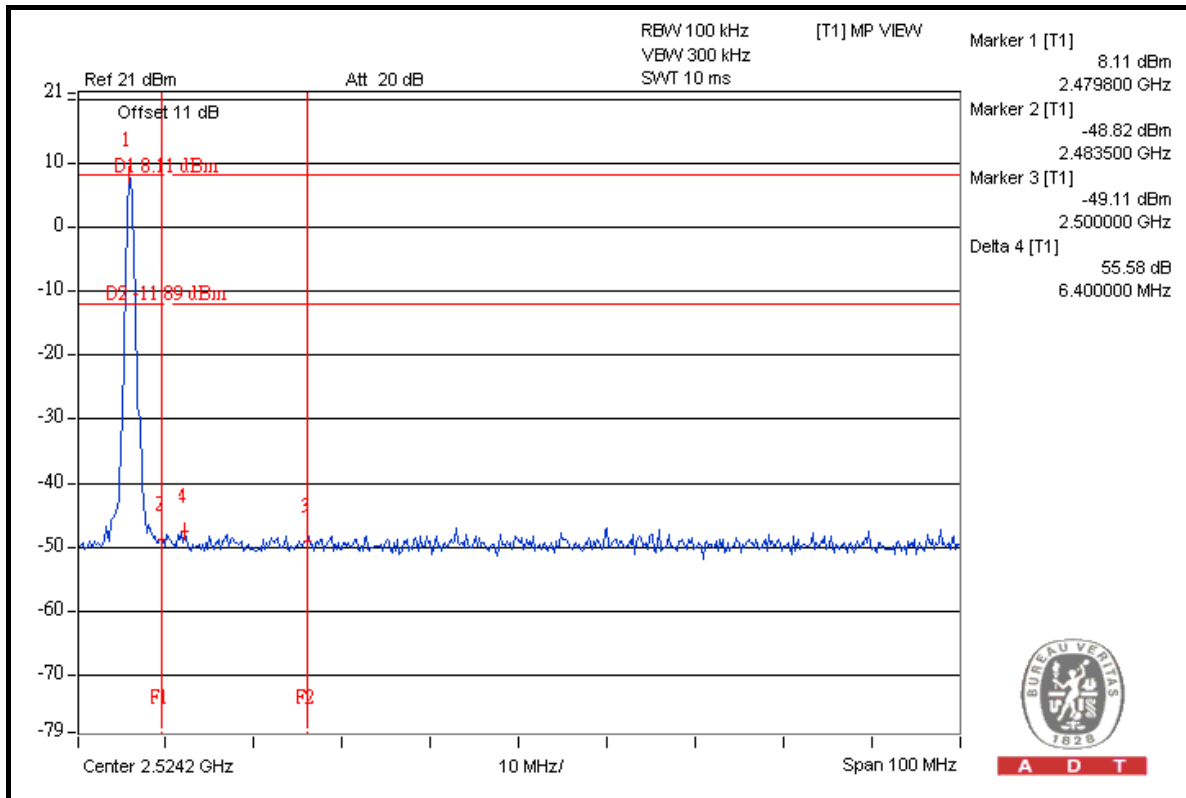

A D T

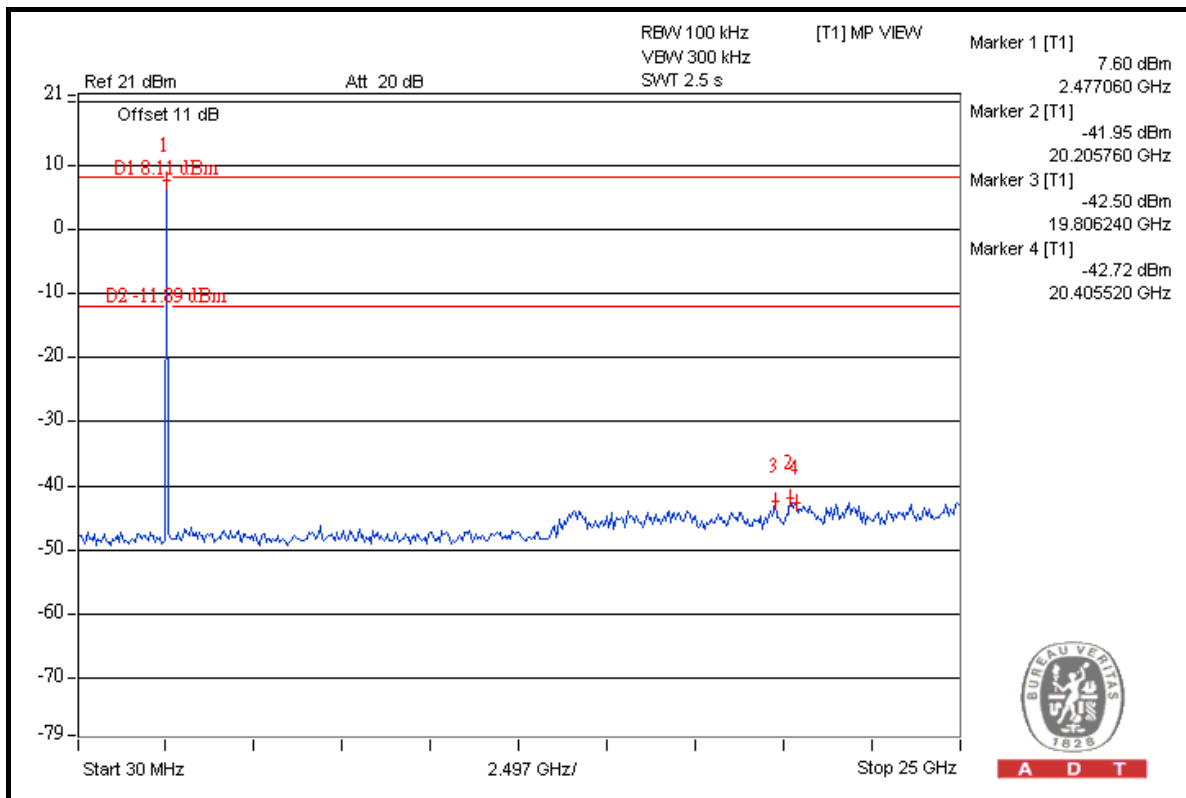

A D T

8DPSK

RESTRICT BAND (2310 ~ 2390 MHz)

FREQUENCY (MHz)	FUNDAMENTAL EMISSION (dBuV/m)	DELTA (dB)	MAXIMUM FIELD STRENGTH IN RESTRICT BAND (dBuV/m)	LIMIT (dBuV/m)
2402.00 (PK)	100.7	53.89	46.81	74.00
2402.00 (AV)	-	-	16.71	54.00

RESTRICT BAND (2483.5 ~ 2500 MHz)

FREQUENCY (MHz)	FUNDAMENTAL EMISSION (dBuV/m)	DELTA (dB)	MAXIMUM FIELD STRENGTH IN RESTRICT BAND (dBuV/m)	LIMIT (dBuV/m)
2480.00 (PK)	100.0	53.09	46.91	74.00
2480.00 (AV)	-	-	16.81	54.00

NOTE:

1. Delta = Amplitude between the peak of the fundamental and the peak of the band edge emission. Please check following 2 pages.
2. Maximum field strength in restrict band (PK value) = Fundamental emission (PK value) – Delta.
3. Average value = Peak value + 20 Log (duty cycle) = Peak value – 30.1dB.
4. The DH5 packet was the worse case duty cycle for a transmit dwell time on a channel, based upon Bluetooth theory the transmitter is on 0.625 * 5 per 296.25 ms per channel. Therefore, the duty cycle correction factor be equal to: $20\log(3.125/100) = -30.1$ dB.



A D T

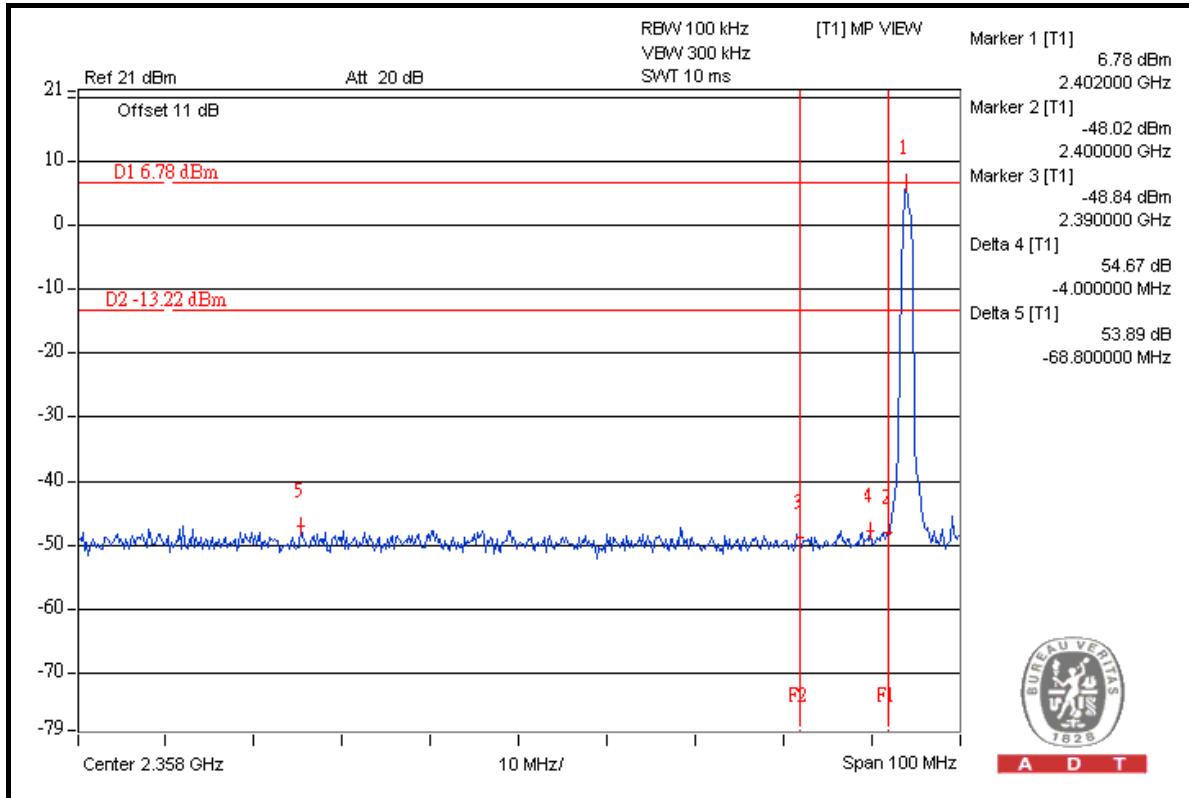

A D T

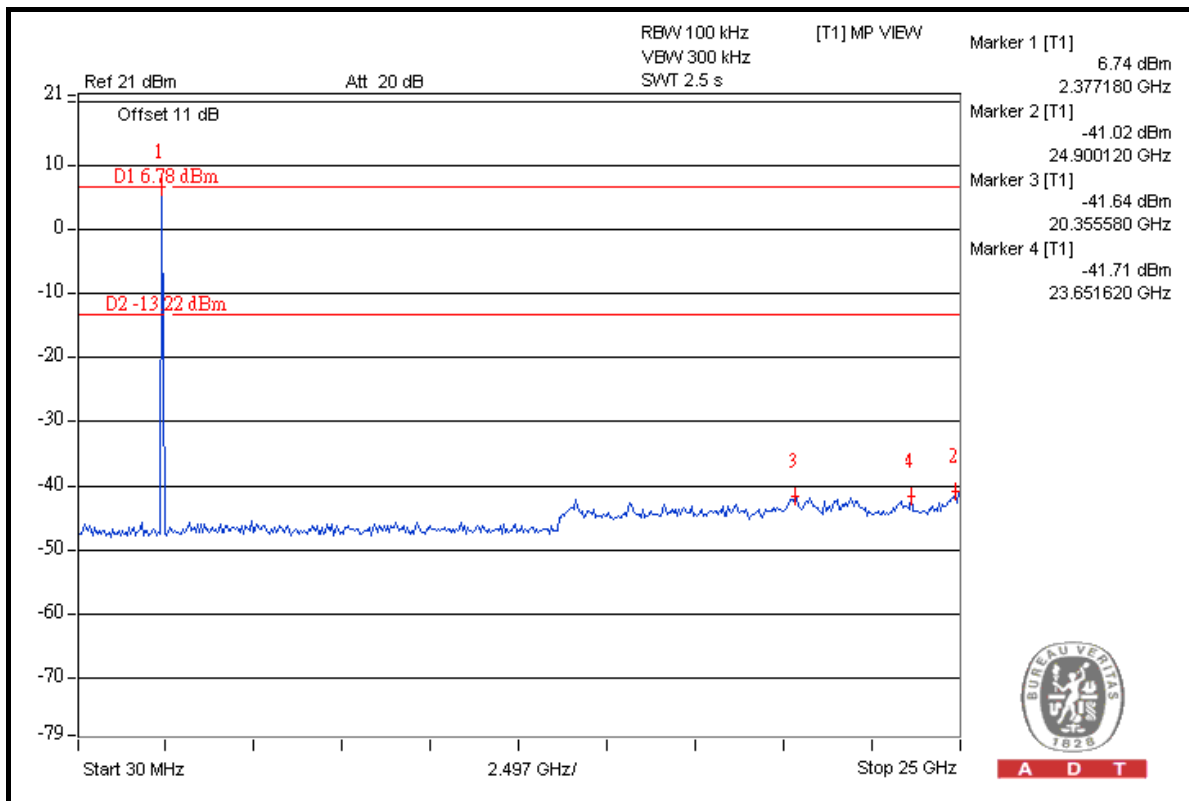

A D T



A D T

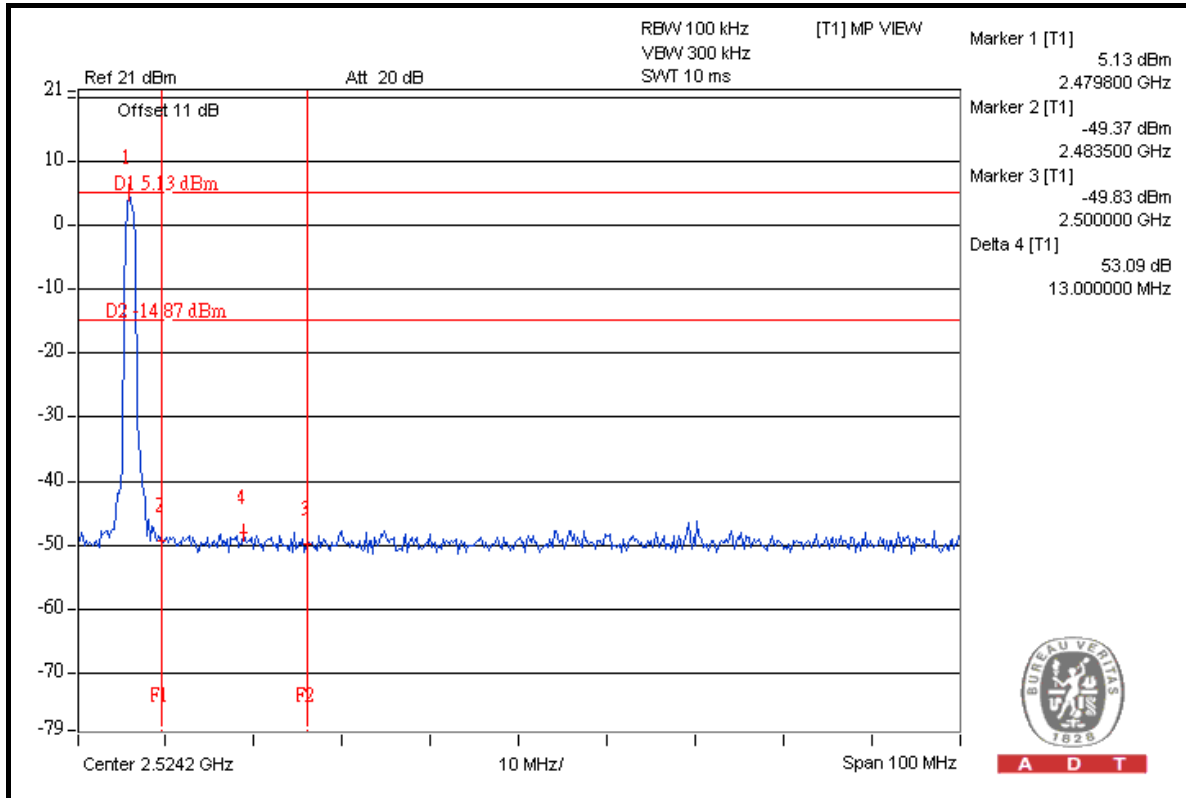

A D T

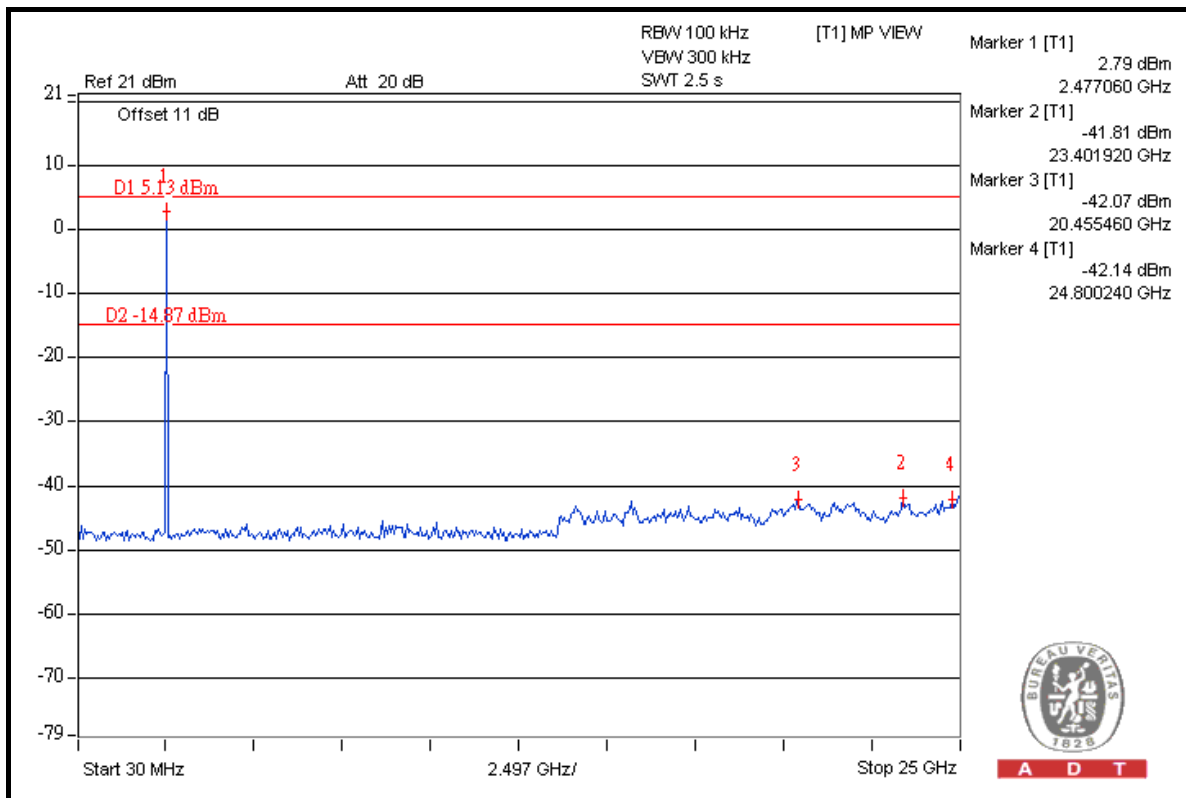

A D T



A D T

5. PHOTOGRAPHS OF THE TEST CONFIGURATION

Please refer to the attached file (Test Setup Photo).



6. INFORMATION ON THE TESTING LABORATORIES

We, Bureau Veritas Consumer Products Services (H.K.) Ltd., Taoyuan Branch, were founded in 1988 to provide our best service in EMC, Radio, Telecom and Safety consultation. Our laboratories are accredited and approved according to ISO/IEC 17025.

Copies of accreditation and authorization certificates of our laboratories obtained from approval agencies can be downloaded from our web site: www.adt.com.tw/index.5.phtml. If you have any comments, please feel free to contact us at the following:

Linko EMC/RF Lab

Tel: 886-2-26052180

Fax: 886-2-26051924

Hsin Chu EMC/RF Lab

Tel: 886-3-5935343

Fax: 886-3-5935342

Hwa Ya EMC/RF/Safety/Telecom Lab

Tel: 886-3-3183232

Fax: 886-3-3185050

Email: service.adt@tw.bureauveritas.com

Web Site: www.adt.com.tw

The address and road map of all our labs can be found in our web site also.

7. APPENDIX A - MODIFICATIONS RECORDERS FOR ENGINEERING CHANGES TO THE EUT BY THE LAB

No modifications were made to the EUT by the lab during the test.

---END---