



FCC TEST REPORT (PART 27)

REPORT NO.: RF111121C23-4

MODEL NO.: WIXHSM-100

FCC ID: MXF- WIXHSM-100

RECEIVED: Nov. 21, 2011

TESTED: Dec. 15 ~ Dec. 30, 2011

ISSUED: Jan. 02, 2012

APPLICANT: Gemtek Technology Co., Ltd.

ADDRESS: No. 15-1, Zhonghua Rd, Hsinchu Industrial Park,
Hsinchu County, Taiwan, R.O.C. 303

ISSUED BY: Bureau Veritas Consumer Products Services
(H.K.) Ltd., Taoyuan Branch

LAB ADDRESS: No. 47, 14th Ling, Chia Pau Vil., Lin Kou Dist.,
New Taipei City, Taiwan (R.O.C)

TEST LOCATION: No. 19, Hwa Ya 2nd Rd, Wen Hwa Tsuen, Kwei
Shan Hsiang, Taoyuan Hsien 333, Taiwan, R.O.C.

This test report consists of 55 pages in total. It may be duplicated completely for legal use with the approval of the applicant. It should not be reproduced except in full, without the written approval of our laboratory. The client should not use it to claim product certification, approval, or endorsement by TAF or any government agency. The test results in the report only apply to the tested sample.





A D T

TABLE OF CONTENTS

RELEASE CONTROL RECORD	4
1 CERTIFICATION	5
2 SUMMARY OF TEST RESULTS	6
2.1 MEASUREMENT UNCERTAINTY	6
3 GENERAL INFORMATION	7
3.1 GENERAL DESCRIPTION OF EUT	7
3.2 DESCRIPTION OF TEST MODES	8
3.2.1 CONFIGURATION OF SYSTEM UNDER TEST	8
3.2.2 TEST MODE APPLICABILITY AND TESTED CHANNEL DETAIL	9
3.3 GENERAL DESCRIPTION OF APPLIED STANDARDS	11
3.4 DESCRIPTION OF SUPPORT UNITS	11
4 TEST TYPES AND RESULTS	12
4.1 OUTPUT POWER MEASUREMENT	12
4.1.1 LIMITS OF OUTPUT POWER MEASUREMENT	12
4.1.2 TEST INSTRUMENTS	13
4.1.3 TEST PROCEDURES	14
4.1.4 TEST SETUP	15
4.1.5 EUT OPERATING CONDITIONS	15
4.1.6 TEST RESULTS	16
4.2 FREQUENCY STABILITY MEASUREMENT	18
4.2.1 LIMITS OF FREQUENCY STABILITY MEASUREMENT	18
4.2.2 TEST INSTRUMENTS	18
4.2.3 TEST PROCEDURE	19
4.2.4 TEST SETUP	19
4.2.5 EUT OPERATING CONDITIONS	19
4.2.6 TEST RESULTS	20
4.3 EMISSION BANDWIDTH MEASUREMENT	22
4.3.1 LIMITS OF EMISSION BANDWIDTH MEASUREMENT	22
4.3.2 TEST INSTRUMENTS	22
4.3.3 TEST PROCEDURE	22
4.3.4 TEST SETUP	23
4.3.5 EUT OPERATING CONDITIONS	23
4.3.6 TEST RESULTS	24
4.4 CHANNEL EDGE MEASUREMENT	26
4.4.1 LIMITS OF CHANNEL EDGE MEASUREMENT	26
4.4.2 TEST INSTRUMENTS	26
4.4.3 TEST SETUP	26
4.4.4 TEST PROCEDURES	27
4.4.5 EUT OPERATING CONDITION	27
4.4.6 TEST RESULTS	28
4.5 CONDUCTED SPURIOUS EMISSIONS	34
4.5.1 LIMITS OF CONDUCTED SPURIOUS EMISSIONS MEASUREMENT	34
4.5.2 TEST INSTRUMENTS	34
4.5.3 TEST PROCEDURE	35
4.5.4 TEST SETUP	35
4.5.5 EUT OPERATING CONDITIONS	35
4.5.6 TEST RESULTS	36
4.6 RADIATED EMISSION MEASUREMENT (BELOW 1GHz)	42
4.6.1 LIMITS OF RADIATED EMISSION MEASUREMENT	42
4.6.2 TEST INSTRUMENTS	43



A D T

4.6.3	TEST PROCEDURES	44
4.6.4	DEVIATION FROM TEST STANDARD	44
4.6.5	TEST SETUP	45
4.6.6	EUT OPERATING CONDITIONS	45
4.6.7	TEST RESULTS	46
5	PHOTOGRAPHS OF THE TEST CONFIGURATION	54
6	INFORMATION ON THE TESTING LABORATORIES	55



RELEASE CONTROL RECORD

ISSUE NO.	REASON FOR CHANGE	DATE ISSUED
Original release	N/A	Jan. 02, 2012



1 CERTIFICATION

PRODUCT: WiMAX Smart Phone

MODEL: WIXHSM-100

BRAND: Gemtek

APPLICANT: Gemtek Technology Co., Ltd.

TESTED: Dec. 15 ~ Dec. 30, 2011

TEST SAMPLE: ENGINEERING SAMPLE

TEST STANDARDS: FCC Part 27, Subpart C & M

The above equipment (Model: WIXHSM-100) has been tested by **Bureau Veritas Consumer Products Services (H.K.) Ltd., Taoyuan Branch**, and found compliance with the requirement of the above standards. The test record, data evaluation & Equipment Under Test (EUT) configurations represented herein are true and accurate accounts of the measurements of the sample's EMC characteristics under the conditions specified in this report.

PREPARED BY :  , DATE: Jan. 02, 2012
Pettie Chen / Specialist

APPROVED BY :  , DATE: Jan. 02, 2012
Gary Chang / Technical Manager

2 SUMMARY OF TEST RESULTS

The EUT has been tested according to the following specifications:

STANDARD SECTION	TEST TYPE AND LIMIT	RESULT	REMARK
FCC Part 27 & Part 2			
2.1046 27.50(h)(2)	Equivalent Isotropically radiated power	PASS	Meet the requirement of limit. Max. e.i.r.p is 20.1dBm
2.1055 27.54	Frequency Stability Stay with the authorized bands of operation	PASS	Meet the requirement of limit.
2.1049 27.53(m)(6)	Emission Bandwidth	PASS	Meet the requirement of limit.
2.1051 27.53(m)(4)(6)	Band Edge Measurements	PASS	Meet the requirement of limit.
2.1051 27.53(m)(4)(6)	Conducted Spurious Emissions	PASS	Meet the requirement of limit.
2.1053 27.53(m)(4)(6)	Radiated Spurious Emissions	PASS	Meet the requirement of limit. Minimum passing margin is -1.0dB at 7779.00MHz.

2.1 MEASUREMENT UNCERTAINTY

Where relevant, the following measurement uncertainty levels have been estimated for tests performed on the EUT as specified in CISPR 16-4-2:

MEASUREMENT	FREQUENCY	UNCERTAINTY
Conducted emissions	9kHz~30MHz	2.44 dB
Radiated emissions	30MHz ~ 200MHz	3.34 dB
	200MHz ~1000MHz	3.35 dB
	1GHz ~ 18GHz	2.26 dB
	18GHz ~ 40GHz	1.94 dB

This uncertainty represents an expanded uncertainty expressed at approximately the 95% confidence level using a coverage factor of $k = 2$.

3 GENERAL INFORMATION

3.1 GENERAL DESCRIPTION OF EUT

EUT	WiMAX Smart Phone	
MODEL NO.	WIXHSM-100	
FCC ID	MXF-WIXHSM-100	
POWER SUPPLY	5.0Vdc (adapter or host equipment) 3.7Vdc (battery)	
CODED TYPE/MODULATION/ CODING RATE	UL	QPSK: 1/2, 3/4
		16QAM: 1/2, 3/4
	DL	QPSK: 1/2, 3/4
		16QAM: 1/2, 3/4
		64QAM: 1/2, 2/3, 3/4, 5/6
MODULATION TECHNOLOGY	OFDMA	
DUPLEX METHOD	TDD	
OPERATING RANGE	Channel Bandwidth 5MHz: 2498.5MHz ~ 2687.5MHz Channel Bandwidth 10MHz: 2501MHz ~ 2685MHz	
CHANNEL BANDWIDTH	5MHz, 10MHz	
MAX. EIRP POWER	Channel Bandwidth: 5MHz: 19.7dBm (0.093W) Channel Bandwidth: 10MHz: 20.1dBm (0.102W)	
ANTENNA TYPE	PIFA antenna with 1dBi gain	
OPERATION TEMPERATURE RANGE	0°C ~ 40°C	
I/O PORTS	Refer to users' manual	
DATA CABLE	1.2 m shielded USB cable without core	
ACCESSORY DEVICES	Battery, Adapter, Earphone (1.3m non-shielded w/o core)	

NOTE:

- The EUT was powered by the following adapters and battery:

ADAPTER 1	
BRAND:	DVE
MODEL:	DSC-5PFC-05 FUS 050100 DSC-5PFC-05 FUS 052100 (For Marketing different)
INPUT:	100-240Vac, 50-60Hz, 0.2A
OUTPUT:	5Vdc, 1A

ADAPTER 2	
BRAND:	SPPS Travel Charger
MODEL:	LFS0501000D-A8S
INPUT:	100-240Vac, 50-60Hz
OUTPUT:	5Vdc, 1000mA

BATTERY	
BRAND:	Skypower
MODEL:	GT-1920
RATING:	3.7Vdc, 1920 mAh

- The EUT can supports different UL / DL ratio, max transmit ratio is up to 18 (UL):29 (DL). After pretesting of output power and spurious emission, 18 (UL):29 (DL) was found to be worst case and was selected for the final test configuration.
- The above EUT information is declared by manufacturer and for more detailed feature description please refers to the manufacturer's specifications or User's Manual.

3.2 DESCRIPTION OF TEST MODES

Three channels of each channel bandwidth had been tested.

CHANNEL (MHz)	CHANNEL BANDWIDTH	
	5.0 MHz	10.0 MHz
LOW	2498.5MHz	2501.0MHz
MIDDLE	2593.0MHz	2593.0MHz
HIGH	2687.5MHz	2685.0MHz

3.2.1 CONFIGURATION OF SYSTEM UNDER TEST

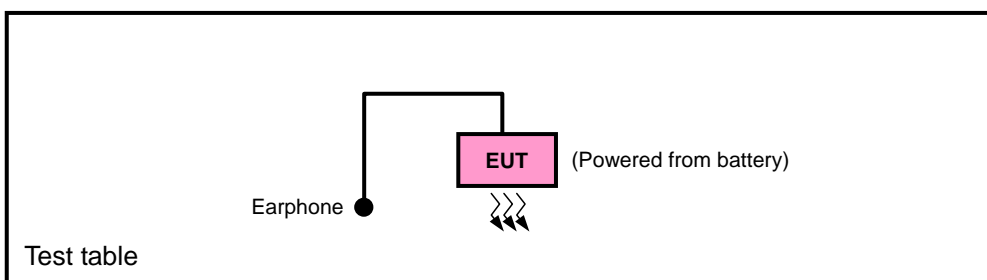



3.2.2 TEST MODE APPLICABILITY AND TESTED CHANNEL DETAIL

EUT CONFIGURE MODE	APPLICABLE TO							DESCRIPTION
	OP	FS	EB	CE	CSE	RE<1G	RE≥1G	
-	√	√	√	√	√	√	√	-

Where **OP**: Output power **FS**: Frequency stability
EB: Emission bandwidth **CE**: Channel edge
CSE: Conducted spurious emissions **RE<1G**: Radiated emission below 1GHz
RE≥1G: Radiated emission above 1GHz **NOTE**: "-" means no effect.

OUTPUT POWER MEASUREMENT:

- Pre-Scan has been conducted to determine the worst-case mode from all possible combinations between available modulations, data rates, XYZ axis and antenna ports (if EUT with antenna diversity architecture).
- Following channel(s) was (were) selected for the final test as listed below.

EUT CONFIGURE MODE	TESTED CHANNEL	MODULATION TECHNOLOGY	CHANNEL BANDWIDTH	MODULATION TYPE	CODING RATE	AXIS
-	L, M, H	OFDMA	5MHz	QPSK	1/2	Z
-	L, M, H	OFDMA	10MHz	QPSK	1/2	Z

FREQUENCY STABILITY MEASUREMENT:

- Pre-Scan has been conducted to determine the worst-case mode from all possible combinations between available modulations, coding rate, and antenna ports (if EUT with antenna diversity architecture).
- Following channel(s) was (were) selected for the final test as listed below.

EUT CONFIGURE MODE	TESTED CHANNEL	MODULATION TECHNOLOGY	CHANNEL BANDWIDTH	MODULATION TYPE	CODING RATE
-	L	OFDMA	5MHz	QPSK	1/2
-	L	OFDMA	10MHz	QPSK	1/2

EMISSION BANDWIDTH MEASUREMENT:

- Pre-Scan has been conducted to determine the worst-case mode from all possible combinations between available modulations, coding rate, and antenna ports (if EUT with antenna diversity architecture).
- Following channel(s) was (were) selected for the final test as listed below.

EUT CONFIGURE MODE	TESTED CHANNEL	MODULATION TECHNOLOGY	CHANNEL BANDWIDTH	MODULATION TYPE	CODING RATE
-	L, M, H	OFDMA	5MHz	QPSK	1/2
-	L, M, H	OFDMA	10MHz	QPSK	1/2



CHANNEL EDGE MEASUREMENT:

- Pre-Scan has been conducted to determine the worst-case mode from all possible combinations between available modulations, coding rate, and antenna ports (if EUT with antenna diversity architecture).
- Following channel(s) was (were) selected for the final test as listed below.

EUT CONFIGURE MODE	TESTED CHANNEL	MODULATION TECHNOLOGY	CHANNEL BANDWIDTH	MODULATION TYPE	CODING RATE
-	L, M, H	OFDMA	5MHz	QPSK	1/2
-	L, M, H	OFDMA	10MHz	QPSK	1/2

CONDUCTED SPURIOUS EMISSIONS MEASUREMENT:

- Pre-Scan has been conducted to determine the worst-case mode from all possible combinations between available modulations, coding rate, and antenna ports (if EUT with antenna diversity architecture).
- Following channel(s) was (were) selected for the final test as listed below.

EUT CONFIGURE MODE	TESTED CHANNEL	MODULATION TECHNOLOGY	CHANNEL BANDWIDTH	MODULATION TYPE	CODING RATE
-	L, M, H	OFDMA	5MHz	QPSK	1/2
-	L, M, H	OFDMA	10MHz	QPSK	1/2

RADIATED EMISSION MEASUREMENT (BELOW 1 GHz):

- Pre-Scan has been conducted to determine the worst-case mode from all possible combinations between available modulations, data rates, XYZ axis and antenna ports (if EUT with antenna diversity architecture).
- Following channel(s) was (were) selected for the final test as listed below.

EUT CONFIGURE MODE	TESTED CHANNEL	MODULATION TECHNOLOGY	CHANNEL BANDWIDTH	MODULATION TYPE	CODING RATE	AXIS
-	H	OFDMA	5MHz	QPSK	1/2	Z
-	M	OFDMA	10MHz	QPSK	1/2	Z

RADIATED EMISSION MEASUREMENT (ABOVE 1 GHz):

- Pre-Scan has been conducted to determine the worst-case mode from all possible combinations between available modulations, data rates, XYZ axis and antenna ports (if EUT with antenna diversity architecture).
- Following channel(s) was (were) selected for the final test as listed below.

EUT CONFIGURE MODE	TESTED CHANNEL	MODULATION TECHNOLOGY	CHANNEL BANDWIDTH	MODULATION TYPE	CODING RATE	AXIS
-	L, M, H	OFDMA	5MHz	QPSK	1/2	Z
-	L, M, H	OFDMA	10MHz	QPSK	1/2	Z



A D T

TEST CONDITION:

APPLICABLE TO	ENVIRONMENTAL CONDITIONS	INPUT POWER	TESTED BY
OP	22deg. C, 70%RH	120Vac, 60Hz	Mark Liao
FS	22deg. C, 70%RH	120Vac, 60Hz	Mark Liao
EB	22deg. C, 70%RH	120Vac, 60Hz	Mark Liao
CE	22deg. C, 70%RH	120Vac, 60Hz	Mark Liao
CSE	22deg. C, 70%RH	120Vac, 60Hz	Mark Liao
RE \geq 1G	21deg. C, 70%RH	120Vac, 60Hz	David Huang
RE $<$ 1G	22deg. C, 70%RH	120Vac, 60Hz	David Huang

3.3 GENERAL DESCRIPTION OF APPLIED STANDARDS

The EUT is a WiMAX product. According to the specifications of the manufacturer, it must comply with the requirements of the following standards:

FCC 47 CFR Part 2

FCC 47 CFR Part 27

ANSI/TIA/EIA-603-C-2004

NOTE: The EUT is also considered as a kind of computer peripheral, because the connection to computer is necessary for typical use. It has been verified to comply with the requirements of FCC Part 15, Subpart B, Class B (DoC). The test report has been issued separately.

3.4 DESCRIPTION OF SUPPORT UNITS

The EUT has been tested as an independent unit.



A D T

4 TEST TYPES AND RESULTS

4.1 OUTPUT POWER MEASUREMENT

4.1.1 LIMITS OF OUTPUT POWER MEASUREMENT

The radiated peak output power shall be according to the specific rule Part 27.50(h)(2) that “User stations are limited to 2 watts” and 27.50(i) specific that “Peak transmit power must be measure over any interval of continuous transmission using instrumentation calibration in terms of rms-equivalent voltage.”



4.1.2 TEST INSTRUMENTS

EIRP POWER MEASUREMENT:

DESCRIPTION & MANUFACTURER	MODEL NO.	SERIAL NO.	DATE OF CALIBRATION	DUE DATE OF CALIBRATION
Test Receiver ROHDE & SCHWARZ	ESIB7	100212	Aug. 02, 2011	Aug. 01, 2012
Spectrum Analyzer ROHDE & SCHWARZ	FSP40	100041	Jul. 21, 2011	Jul. 20, 2012
BILOG Antenna SCHWARZBECK	VULB9168	9168-160	Apr. 13, 2011	Apr. 12, 2012
HORN Antenna SCHWARZBECK	9120D	209	Aug. 25, 2011	Aug. 24, 2012
HORN Antenna SCHWARZBECK	BBHA 9170	148	Jul. 20, 2011	Jul. 19, 2012
Preamplifier Agilent	8447D	2944A10633	Oct. 29, 2011	Oct. 28, 2012
Preamplifier Agilent	8449B	3008A01964	Oct. 29, 2011	Oct. 28, 2012
RF signal cable HUBER+SUHNNER	SUCOFLEX 104	250723/4	Aug. 30, 2011	Aug. 29, 2012
RF signal cable HUBER+SUHNNER	SUCOFLEX 106	12738/6+309224/4	Aug. 30, 2011	Aug. 29, 2012
Software ADT.	ADT_Radiated_ V7.6.15.9.2	NA	NA	NA
Antenna Tower inn-co GmbH	MA 4000	013303	NA	NA
Antenna Tower Controller inn-co GmbH	CO2000	017303	NA	NA
Turn Table ADT.	TT100.	TT93021703	NA	NA
Turn Table Controller ADT.	SC100.	SC93021703	NA	NA
Turn Table Controller ADT.	SC100.	SC93021704	NA	NA

- NOTE:**
1. The calibration interval of the above test instruments is 12 months and the calibrations are traceable to NML/ROC and NIST/USA.
 2. The test was performed in HwaYa Chamber 3.
 3. The horn antenna and HP preamplifier (model: 8449B) are used only for the measurement of emission frequency above 1GHz if tested.
 4. The FCC Site Registration No. is 988962.
 5. The IC Site Registration No. is IC 7450F-3.

4.1.3 TEST PROCEDURES

- a. The power was measured with R&S Spectrum Analyzer. All measurements were done at 3 channels (low, middle and high operational frequency range.)
- b. The conducted peak output power used the power splitter via EUT RF power connector between simulation base station and spectrum analyzer. The path loss included the splitter loss, cable loss and 20dB pad loss. The spectrum set RB/VB 3MHz, then read peak power value and record to the test. (All transmitted path loss shall be considered in the test report data.)
- c. Substitution method is used for E.I.R.P measurement. In the semi-anechoic chamber, EUT placed on the 0.8m height of Turn Table, rotated the table around 360 degrees to search the maximum radiation power and receiver antenna shall be rotated vertical and horizontal polarization and moved height from 1m to 4m to find the maximum polar radiated power. The "Read Value" is the spectrum reading the maximum power value.
- d. The substitution horn antenna is substituted for EUT at the same position and signals generator export the CW signal to the substitution antenna via a TX cable. Rotated the Turn Table and moved receiving antenna to find the maximum radiation power. Adjust output power level of S.G to get a Value of spectrum reading equal to "Read Value" of step b. Record the power level of S.G
- e. $EIRP = \text{Output power level of S.G} - \text{TX cable loss} + \text{Antenna gain of substitution horn.}$

NOTE: The resolution bandwidth and video bandwidth of test receiver/spectrum analyzer is 10MHz/10MHz.

4.1.4 TEST SETUP

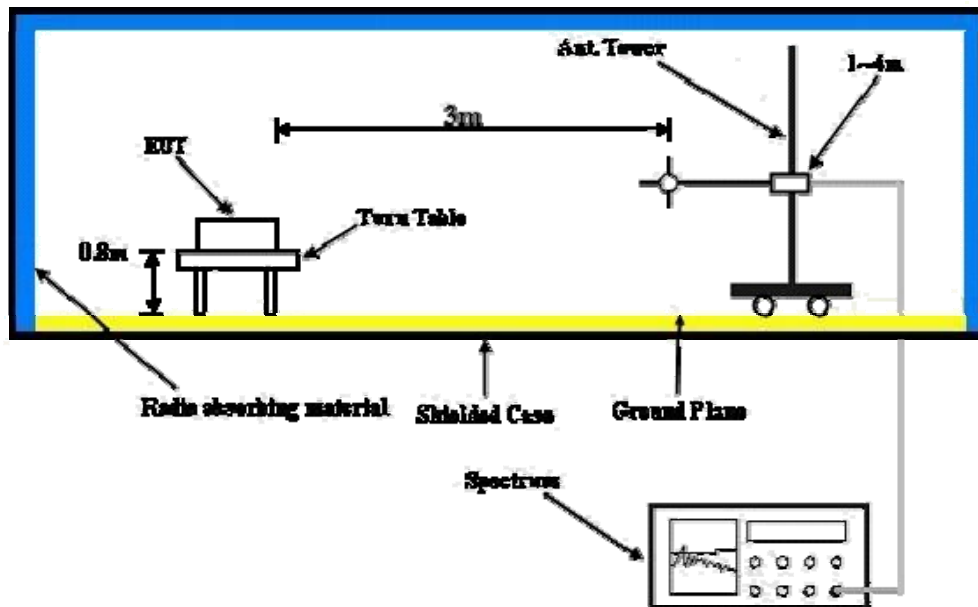

For the actual test configuration, please refer to the attached file (Test Setup Photo).

4.1.5 EUT OPERATING CONDITIONS

- a. Link up EUT with notebook.
- b. The notebook controlled EUT to export rated output power under transmission mode and specific channel frequency.



A D T

4.1.6 TEST RESULTS

CHANNEL BANDWIDTH: 5MHz

EIRP POWER

FREQUENCY		2498.5MHz					
ANTENNA POLARITY & TEST DISTANCE: HORIZONTAL AT 3 M							
No.	Freq. (MHz)	Reading (dBm)	S.G Power Value (dBm)	Correction Factor (dB)	EIRP (dBm)	Limit (dBm)	Margin (dB)
1	2498.5	-22.0	15.7	0.7	16.4	33.0	-16.6
ANTENNA POLARITY & TEST DISTANCE: VERTICAL AT 3 M							
No.	Freq. (MHz)	Reading (dBm)	S.G Power Value (dBm)	Correction Factor (dB)	EIRP (dBm)	Limit (dBm)	Margin (dB)
1	2498.5	-20.1	18.6	0.7	19.3	33.0	-13.7

NOTE: Power Value (dBum) = S.G Power Value (dBm) + Correction Factor (dB).

FREQUENCY		2593.0MHz					
ANTENNA POLARITY & TEST DISTANCE: HORIZONTAL AT 3 M							
No.	Freq. (MHz)	Reading (dBm)	S.G Power Value (dBm)	Correction Factor (dB)	EIRP (dBm)	Limit (dBm)	Margin (dB)
1	2593.0	-22.7	15.3	0.9	16.2	33.0	-16.8
ANTENNA POLARITY & TEST DISTANCE: VERTICAL AT 3 M							
No.	Freq. (MHz)	Reading (dBm)	S.G Power Value (dBm)	Correction Factor (dB)	EIRP (dBm)	Limit (dBm)	Margin (dB)
1	2593.0	-20.8	18.7	0.9	19.6	33.0	-13.4

NOTE: Power Value (dBum) = S.G Power Value (dBm) + Correction Factor (dB).

FREQUENCY		2687.5MHz					
ANTENNA POLARITY & TEST DISTANCE: HORIZONTAL AT 3 M							
No.	Freq. (MHz)	Reading (dBm)	S.G Power Value (dBm)	Correction Factor (dB)	EIRP (dBm)	Limit (dBm)	Margin (dB)
1	2687.5	-24.9	14.3	0.8	15.1	33.0	-17.9
ANTENNA POLARITY & TEST DISTANCE: VERTICAL AT 3 M							
No.	Freq. (MHz)	Reading (dBm)	S.G Power Value (dBm)	Correction Factor (dB)	EIRP (dBm)	Limit (dBm)	Margin (dB)
1	2687.5	-20.6	18.9	0.8	19.7	33.0	-13.3

NOTE: Power Value (dBum) = S.G Power Value (dBm) + Correction Factor (dB).



A D T

CHANNEL BANDWIDTH: 10MHz

EIRP POWER

FREQUENCY		2501.0MHz					
ANTENNA POLARITY & TEST DISTANCE: HORIZONTAL AT 3 M							
No.	Freq. (MHz)	Reading (dBm)	S.G Power Value (dBm)	Correction Factor (dB)	EIRP (dBm)	Limit (dBm)	Margin (dB)
1	2501.0	-20.8	16.9	0.7	17.6	33.0	-15.4
ANTENNA POLARITY & TEST DISTANCE: VERTICAL AT 3 M							
No.	Freq. (MHz)	Reading (dBm)	S.G Power Value (dBm)	Correction Factor (dB)	EIRP (dBm)	Limit (dBm)	Margin (dB)
1	2501.0	-20.3	18.4	0.7	19.1	33.0	-13.9

NOTE: Power Value (dBum) = S.G Power Value (dBm) + Correction Factor (dB).

FREQUENCY		2593.0MHz					
ANTENNA POLARITY & TEST DISTANCE: HORIZONTAL AT 3 M							
No.	Freq. (MHz)	Reading (dBm)	S.G Power Value (dBm)	Correction Factor (dB)	EIRP (dBm)	Limit (dBm)	Margin (dB)
1	2593.0	-21.7	16.3	0.9	17.2	33.0	-15.8
ANTENNA POLARITY & TEST DISTANCE: VERTICAL AT 3 M							
No.	Freq. (MHz)	Reading (dBm)	S.G Power Value (dBm)	Correction Factor (dB)	EIRP (dBm)	Limit (dBm)	Margin (dB)
1	2593.0	-20.3	19.2	0.9	20.1	33.0	-12.9

NOTE: Power Value (dBum) = S.G Power Value (dBm) + Correction Factor (dB).

FREQUENCY		2685.0MHz					
ANTENNA POLARITY & TEST DISTANCE: HORIZONTAL AT 3 M							
No.	Freq. (MHz)	Reading (dBm)	S.G Power Value (dBm)	Correction Factor (dB)	EIRP (dBm)	Limit (dBm)	Margin (dB)
1	2685.0	-23.0	16.2	0.8	17.0	33.0	-16.0
ANTENNA POLARITY & TEST DISTANCE: VERTICAL AT 3 M							
No.	Freq. (MHz)	Reading (dBm)	S.G Power Value (dBm)	Correction Factor (dB)	EIRP (dBm)	Limit (dBm)	Margin (dB)
1	2685.0	-20.6	18.9	0.8	19.7	33.0	-13.3

NOTE: Power Value (dBum) = S.G Power Value (dBm) + Correction Factor (dB).



4.2 FREQUENCY STABILITY MEASUREMENT

4.2.1 LIMITS OF FREQUENCY STABILITY MEASUREMENT

According to the FCC part 2.1055 shall be tested the frequency stability. The rule is defined that” The frequency stability shall be sufficient to ensure that the fundamental emission stays within the authorized frequency block.” The test extreme voltage is according to the 2.1055(d)(1) Vary primary supply voltage from 85 to 115 percent of the nominal value for other than hand carried battery equipment and the extreme temperature rule is comply with specification of EUT $-30^{\circ}\text{C} \sim 50^{\circ}\text{C}$.

4.2.2 TEST INSTRUMENTS

DESCRIPTION & MANUFACTURER	MODEL NO.	SERIAL NO.	DATE OF CALIBRATION	DUE DATE OF CALIBRATION
Spectrum Analyzer Agilent	E4446A	MY43360128	Feb. 22, 2011	Feb. 21, 2012
RF cable	SUCOFLEX 104	257029	Jan. 27, 2011	Jan. 26, 2012
WIT Standard Temperature & Humidity Chamber	MHU-225AU	920409	Jun. 15, 2011	Jun. 14, 2012

NOTE: The calibration interval of the above test instruments is 12 months. And the calibrations are traceable to NML/ROC and NIST/USA.

4.2.3 TEST PROCEDURE

- a. Power must be removed when changing from one temperature to another or one voltage to another voltage. Power warm up is at least 15 min and power applied should perform before recording frequency error.
- b. EUT is connected the external power supply to control the AC input power. The various Volts from the minimum 3.4 Volts to 4.2 Volts. Each step shall be record the frequency error rate.
- c. The temperature range step is 10 degrees in this test items. All temperature levels shall be hold the $\pm 0.5^{\circ}\text{C}$ during the measurement testing.
- d. The each temperature step shall be at least 0.5 hours, consider the EUT could be test under the stability condition.

4.2.4 TEST SETUP

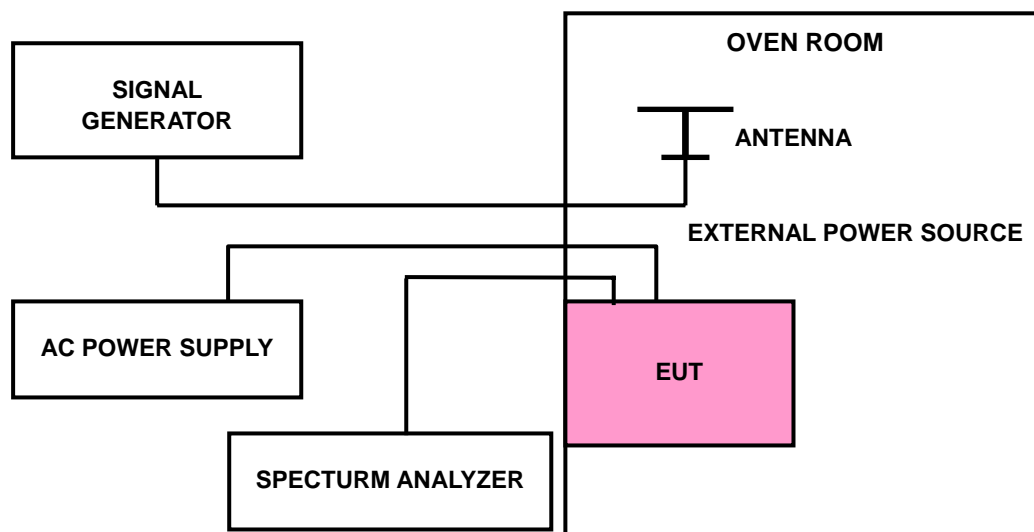

4.2.5 EUT OPERATING CONDITIONS

Same as 4.1.5



A D T

4.2.6 TEST RESULTS

CHANNEL BANDWIDTH	5MHz	MODE	Low Channel
--------------------------	------	-------------	-------------

AFC FREQUENCY ERROR VS. VOLTAGE			
VOLTAGE (Volts)	TEMP. (°C)	FREQUENCY (MHz)	FREQUENCY ERROR (ppm)
3.4	20	2498.500738	0.295
3.7	20	2498.500785	0.314
4.2	20	2498.500813	0.325

AFC FREQUENCY ERROR VS. TEMP.			
VOLTAGE (Volts)	TEMP. (°C)	FREQUENCY (MHz)	FREQUENCY ERROR (ppm)
3.7	50	2498.500459	0.184
3.7	40	2498.500600	0.240
3.7	30	2498.500738	0.295
3.7	20	2498.500785	0.314
3.7	10	2498.500813	0.325
3.7	0	2498.500802	0.321
3.7	-10	2498.500305	0.122
3.7	-20	2498.500669	0.268
3.7	-30	2498.500915	0.366



A D T

CHANNEL BANDWIDTH	10MHz	MODE	Low channel
--------------------------	-------	-------------	-------------

AFC FREQUENCY ERROR VS. VOLTAGE			
VOLTAGE (Volts)	TEMP. (°C)	FREQUENCY (MHz)	FREQUENCY ERROR (ppm)
3.4	20	2501.000933	0.373
3.7	20	2501.000637	0.255
4.2	20	2501.000586	0.234

AFC FREQUENCY ERROR VS. TEMP.			
VOLTAGE (Volts)	TEMP. (°C)	FREQUENCY (MHz)	FREQUENCY ERROR (ppm)
3.7	50	2501.000284	0.114
3.7	40	2501.000463	0.185
3.7	30	2501.000932	0.373
3.7	20	2501.000637	0.255
3.7	10	2501.000837	0.335
3.7	0	2501.001186	0.474
3.7	-10	2501.000386	0.154
3.7	-20	2501.000411	0.164
3.7	-30	2501.000754	0.301

4.3 EMISSION BANDWIDTH MEASUREMENT

4.3.1 LIMITS OF EMISSION BANDWIDTH MEASUREMENT

According to FCC 27.53(m)(6) specified that emission bandwidth is defined as the width of the signal between two points, one below the carrier center frequency and one above the carrier center frequency, outside of which all emissions are attenuated at least 26dB below the transmitter power.

4.3.2 TEST INSTRUMENTS

DESCRIPTION & MANUFACTURER	MODEL NO.	SERIAL NO.	DATE OF CALIBRATION	DUE DATE OF CALIBRATION
Spectrum Analyzer Agilent	E4446A	MY43360128	Feb. 22, 2011	Feb. 21, 2012
RF cable	SUCOFLEX 104	257029	Jan. 27, 2011	Jan. 26, 2012
WIT Standard Temperature & Humidity Chamber	MHU-225AU	920409	Jun. 15, 2011	Jun. 14, 2012

NOTE: The calibration interval of the above test instruments is 12 months and the calibrations are traceable to NML/ROC and NIST/USA.

4.3.3 TEST PROCEDURE

The transmitter output was connected to the spectrum analyzer through an attenuator. The bandwidth of the fundamental frequency was measured by spectrum analyzer with RBW = 51kHz, VBW = 160kHz. The 26dB bandwidth is defined as the total spectrum the power of which is higher than peak power minus 26dB.

4.3.4 TEST SETUP

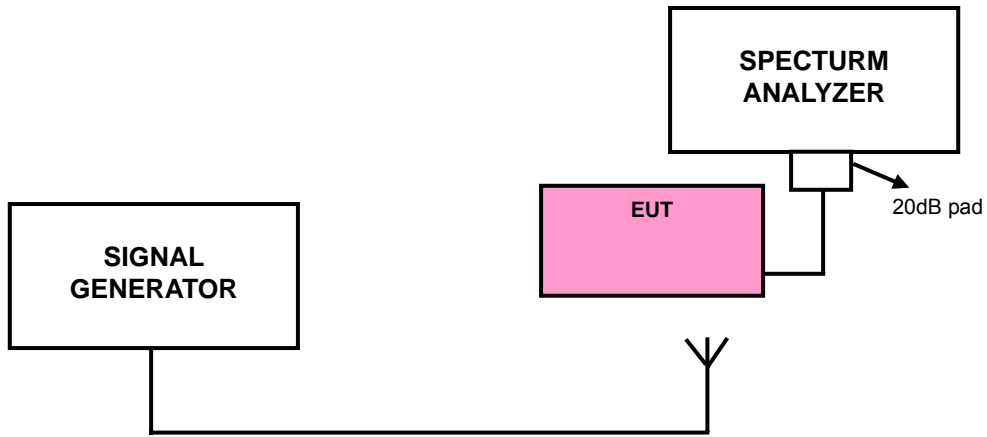

4.3.5 EUT OPERATING CONDITIONS

Same as 4.1.5



A D T

4.3.6 TEST RESULTS

CHANNEL BANDWIDTH: 5MHz

CHANNEL	-26dBc BANDWIDTH (MHz)
Low	4.770
Middle	4.771
High	4.771

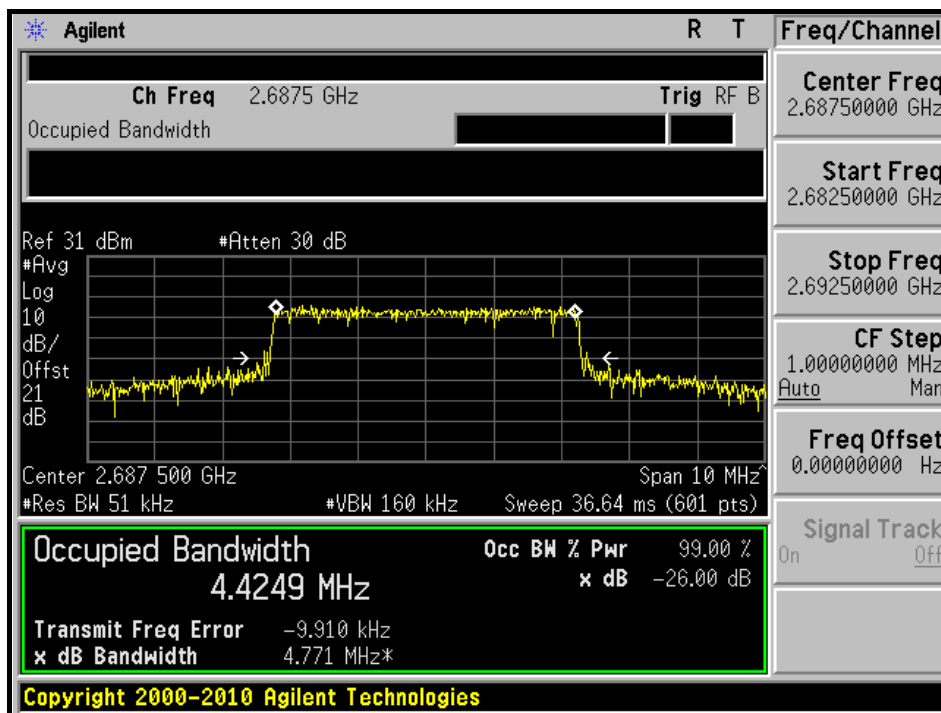



A D T

CHANNEL BANDWIDTH: 10MHz

CHANNEL	-26dBc BANDWIDTH (MHz)
Low	9.521
Middle	9.523
High	9.528

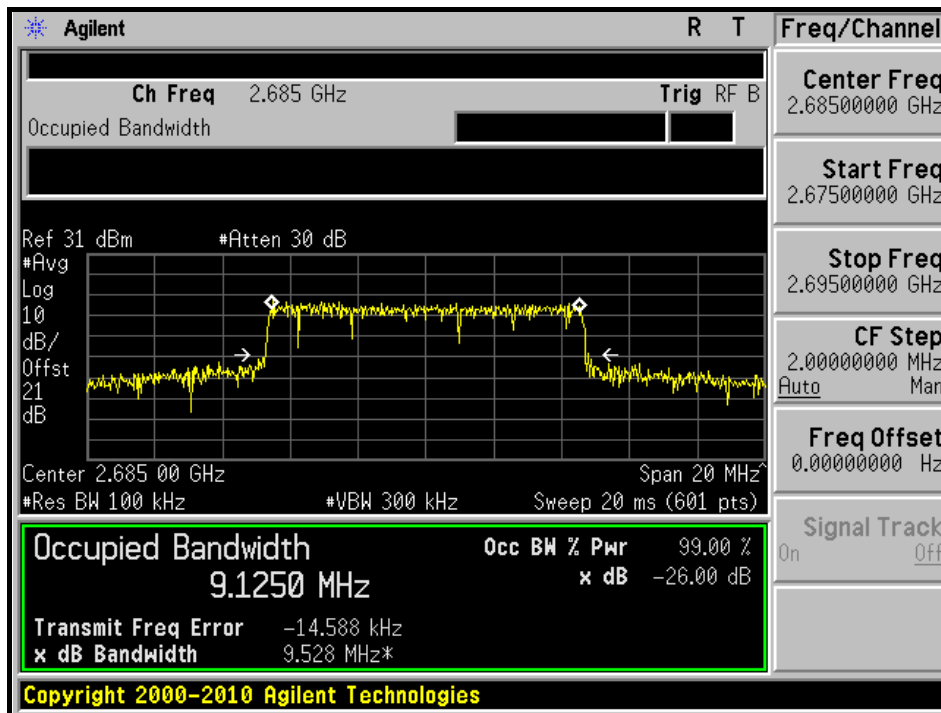



4.4 CHANNEL EDGE MEASUREMENT

4.4.1 LIMITS OF CHANNEL EDGE MEASUREMENT

According to FCC 27.53(m)(4) specified that power of any emission outside of the channel edge must be attenuated below the transmitting power (P) by a factor shall be not less than $43 + 10 \log (P)$ dB at the channel edge, the limit of emission equal to -13dBm . And $55 + 10 \log (P)$ dB at 5.5 MHz from the channel edges, the limit of emission equal to -25dBm . In the 1MHz bands immediately outside and adjacent to the frequency block a resolution bandwidth of at least one percent of the emission bandwidth of the fundamental emission of the transmitter may be employed.

4.4.2 TEST INSTRUMENTS

DESCRIPTION & MANUFACTURER	MODEL NO.	SERIAL NO.	DATE OF CALIBRATION	DUE DATE OF CALIBRATION
Spectrum Analyzer Agilent	E4446A	MY43360128	Feb. 22, 2011	Feb. 21, 2012
RF cable	SUCOFLEX 104	257029	Jan. 27, 2011	Jan. 26, 2012
WIT Standard Temperature & Humidity Chamber	MHU-225AU	920409	Jun. 15, 2011	Jun. 14, 2012

NOTE: The calibration interval of the above test instruments is 12 months. And the calibrations are traceable to NML/ROC and NIST/USA.

4.4.3 TEST SETUP

Same as Item 4.3.4

4.4.4 TEST PROCEDURES

- a. The EUT was set up for the rated peak power. The power was measured with Spectrum Analyzer. All measurements were done at 3 channels: low, middle and high operational frequency range.
- b. The center frequency of spectrum is the band edge frequency and span is 20MHz (Channel Bandwidth: 5MHz) / 30MHz (Channel Bandwidth: 10MHz). RBW of the spectrum is 51kHz (Channel Bandwidth: 5MHz) / 100kHz (Channel Bandwidth: 10MHz).
- c. Record the max trace plot into the test report.

4.4.5 EUT OPERATING CONDITION

Same as 4.1.5

4.4.6 TEST RESULTS

CHANNEL BANDWIDTH: 5MHz

LOW CHANNEL

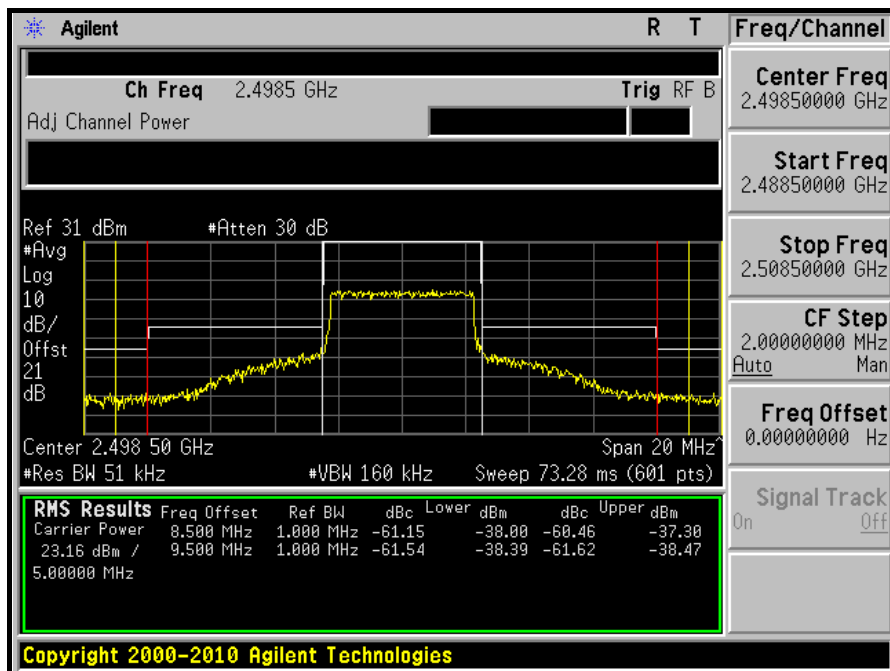
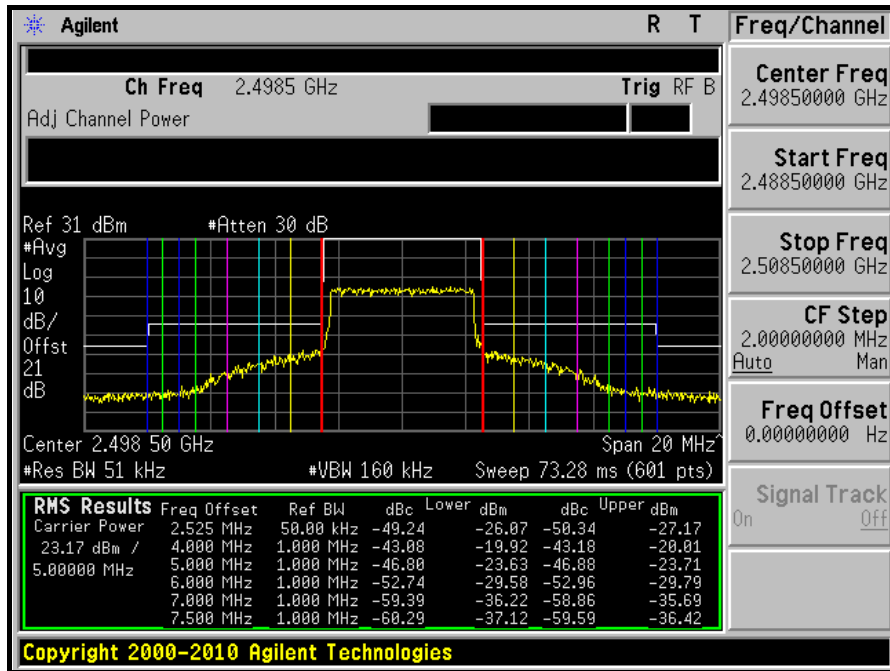



A D T

MIDDLE CHANNEL

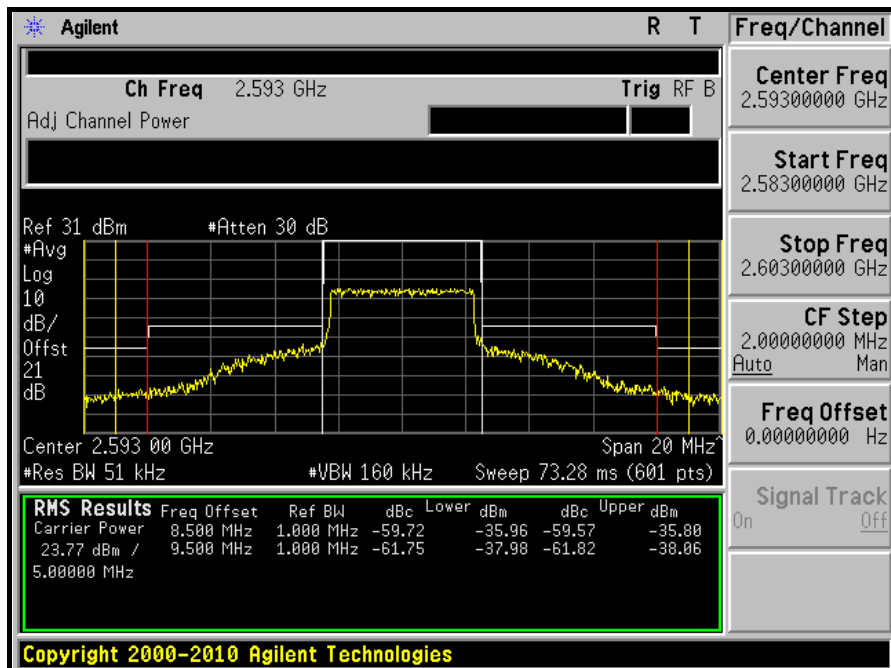
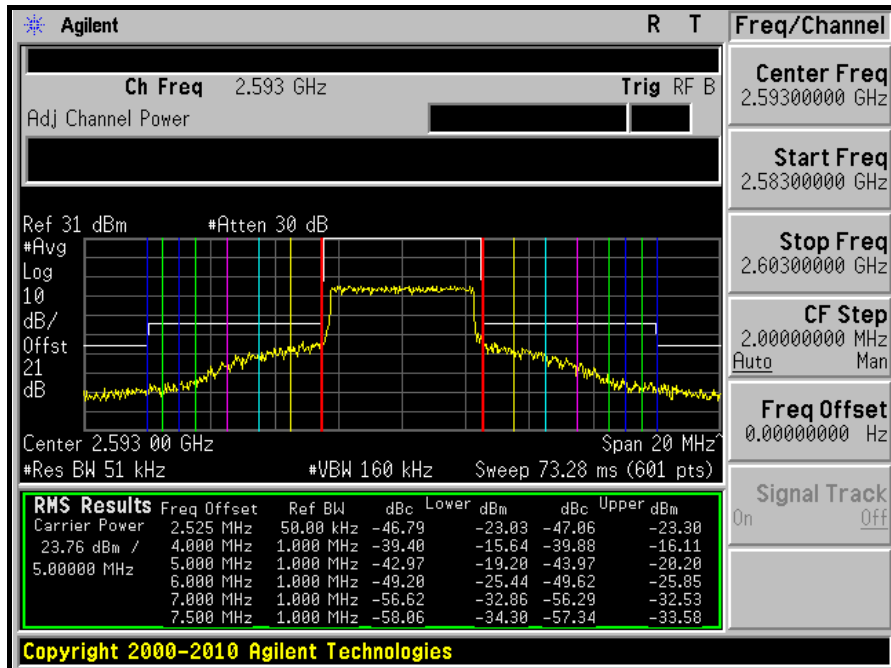



A D T

HIGH CHANNEL

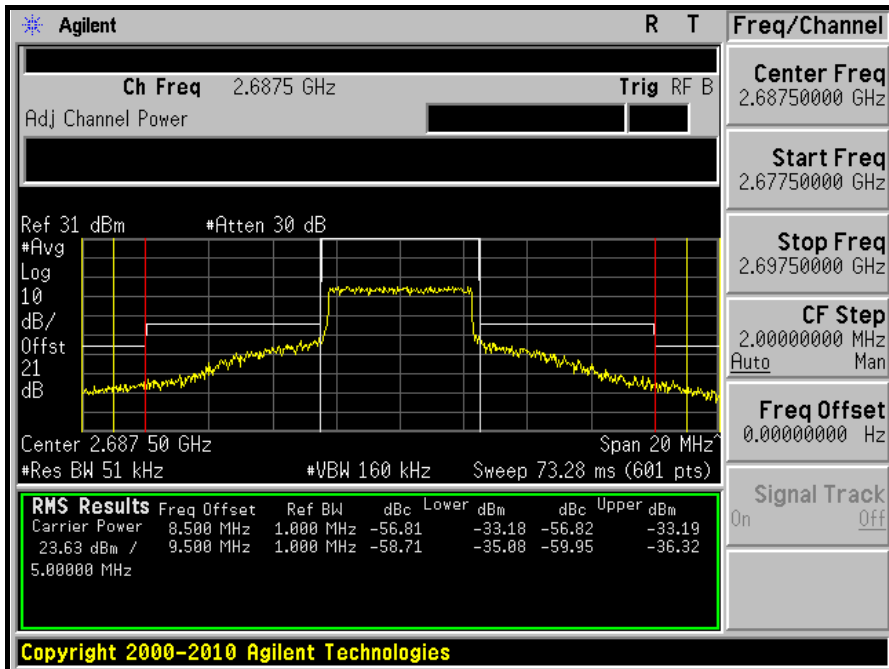
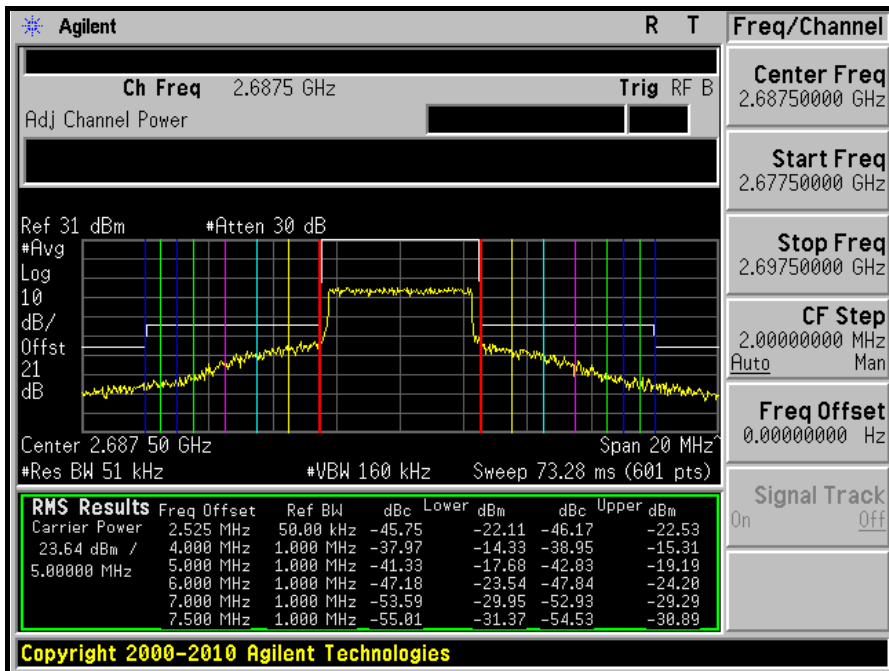



A D T

CHANNEL BANDWIDTH: 10MHz

LOW CHANNEL

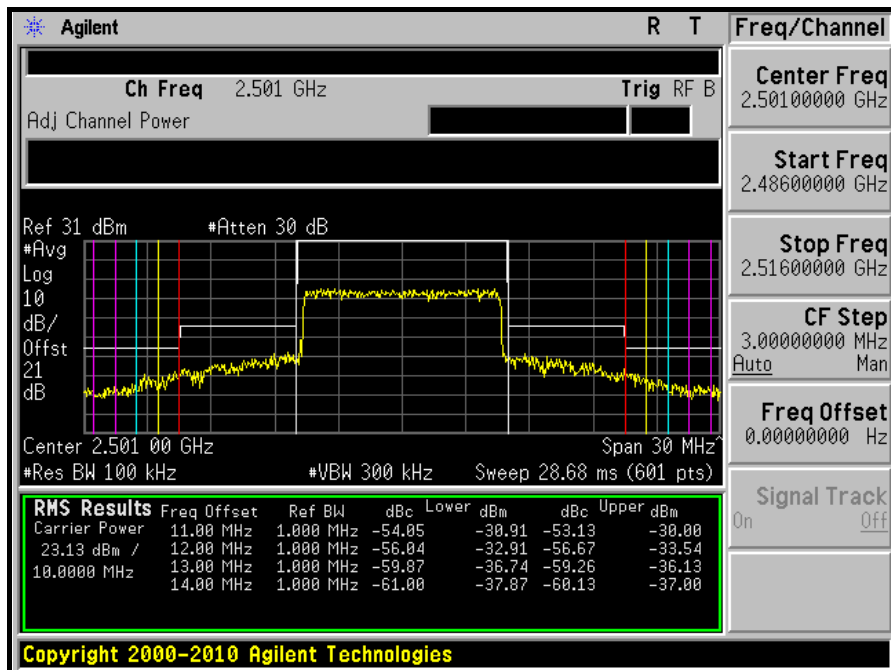
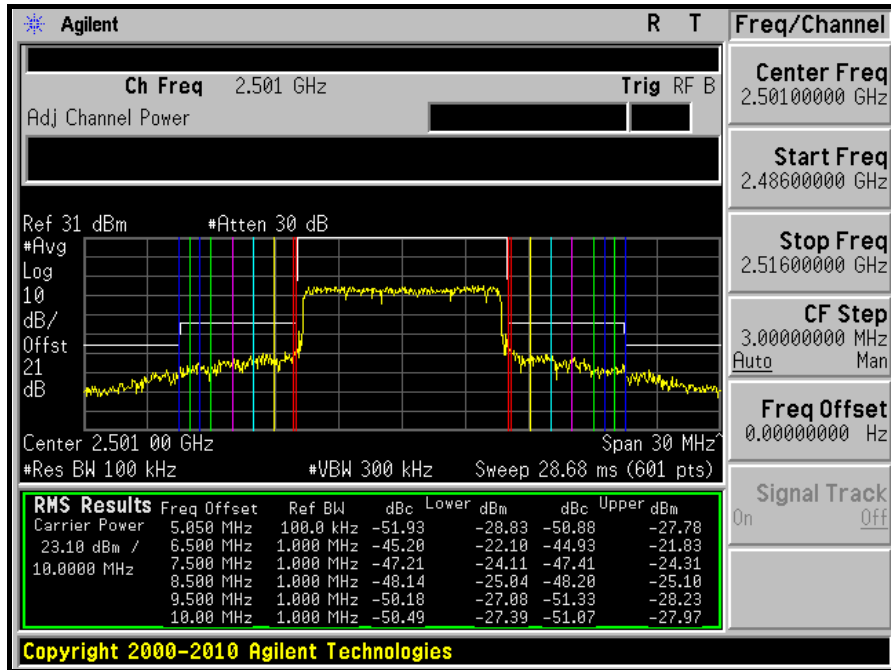



A D T

MIDDLE CHANNEL

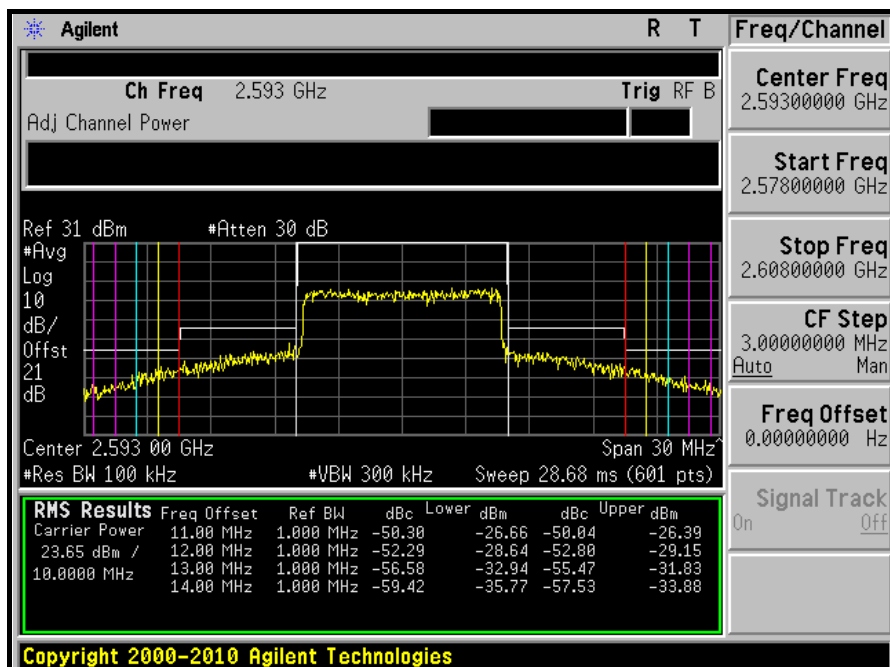
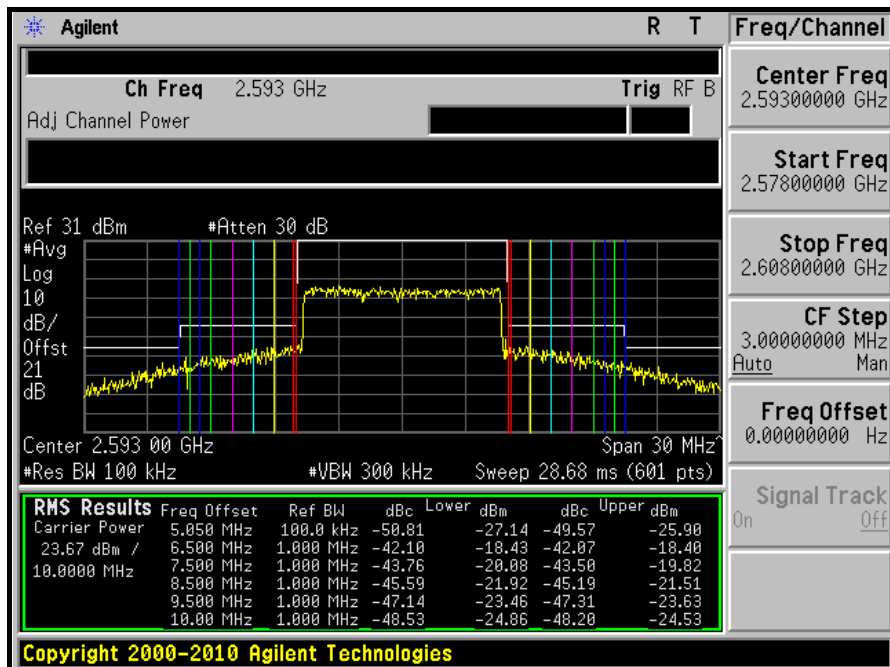



A D T

HIGH CHANNEL

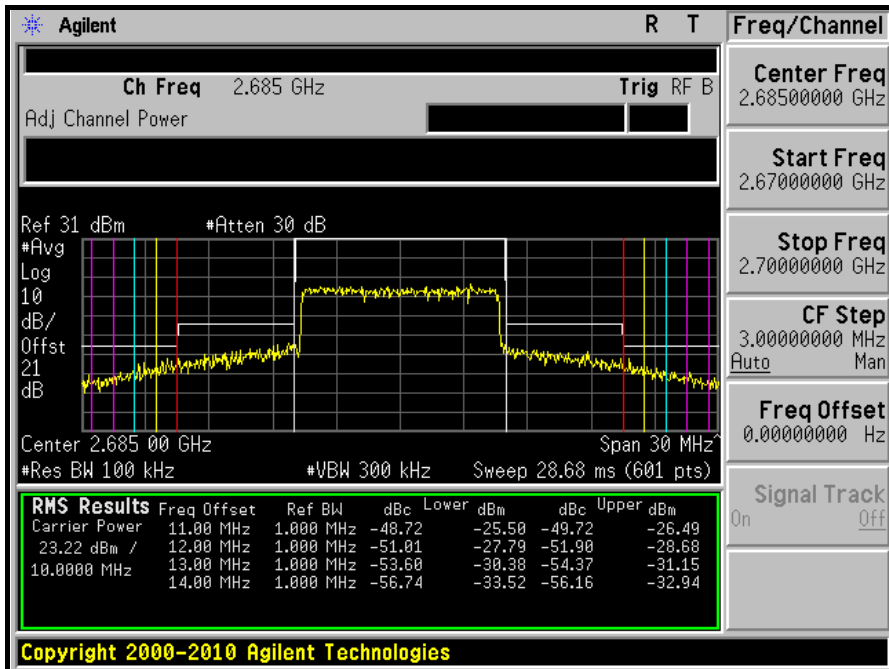
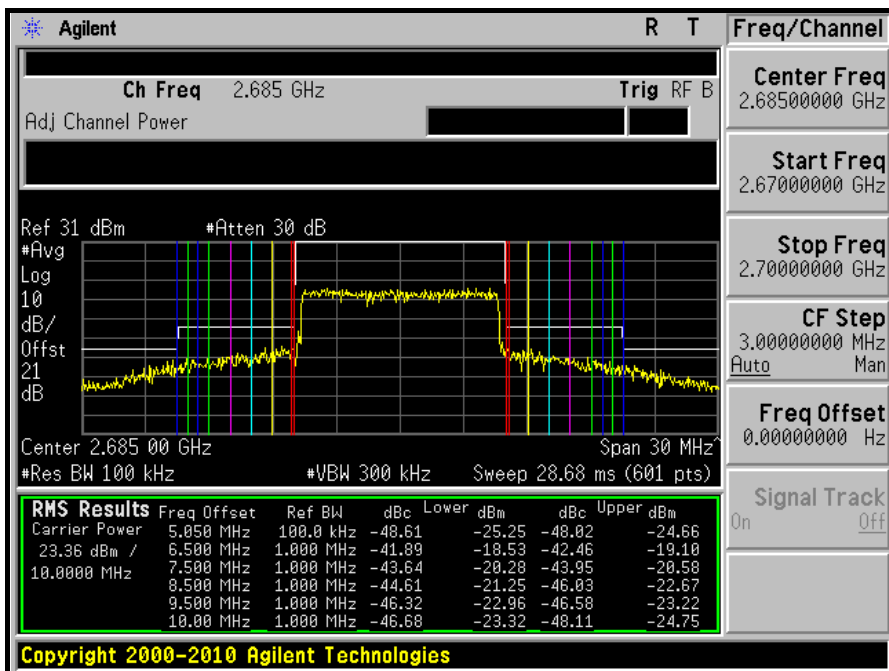

4.5 CONDUCTED SPURIOUS EMISSIONS

4.5.1 LIMITS OF CONDUCTED SPURIOUS EMISSIONS MEASUREMENT

In the FCC 27.53(m)(4), On any frequency outside a licensee's frequency block, the power of any emission shall be attenuated below the transmitter power (P) by at least $55 + 10 \log (P)$ dB. The limit of emission equal to -25 dBm.

4.5.2 TEST INSTRUMENTS

DESCRIPTION & MANUFACTURER	MODEL NO.	SERIAL NO.	DATE OF CALIBRATION	DUE DATE OF CALIBRATION
Spectrum Analyzer Agilent	E4446A	MY43360128	Feb. 22, 2011	Feb. 21, 2012
Wainwright Instruments High Pass Filter	WHK3.1/18G-10SS	ZZ-010096	Mar. 24, 2011	Mar. 23, 2012
JFW 20dB attenuation	50HF-020-SMA	NA	NA	NA
RF cable	SUCOFLEX 104	257029	Jan. 27, 2011	Jan. 26, 2012

NOTE: The calibration interval of the above test instruments is 12 months. And the calibrations are traceable to NML/ROC and NIST/USA.

4.5.3 TEST PROCEDURE

- a. All measurements were done at 3 channels: low, middle and high operational frequency range.
- b. When the spectrum scanned from 30MHz to 27GHz, it shall be connected to the 20dB pad attenuated the carried frequency. The spectrum set RB = 1MHz, VB = 3MHz.

4.5.4 TEST SETUP

Same as 4.3.4

4.5.5 EUT OPERATING CONDITIONS

Same as 4.1.5



A D T

4.5.6 TEST RESULTS

CHANNEL BANDWIDTH: 5MHz

LOW CHANNEL:

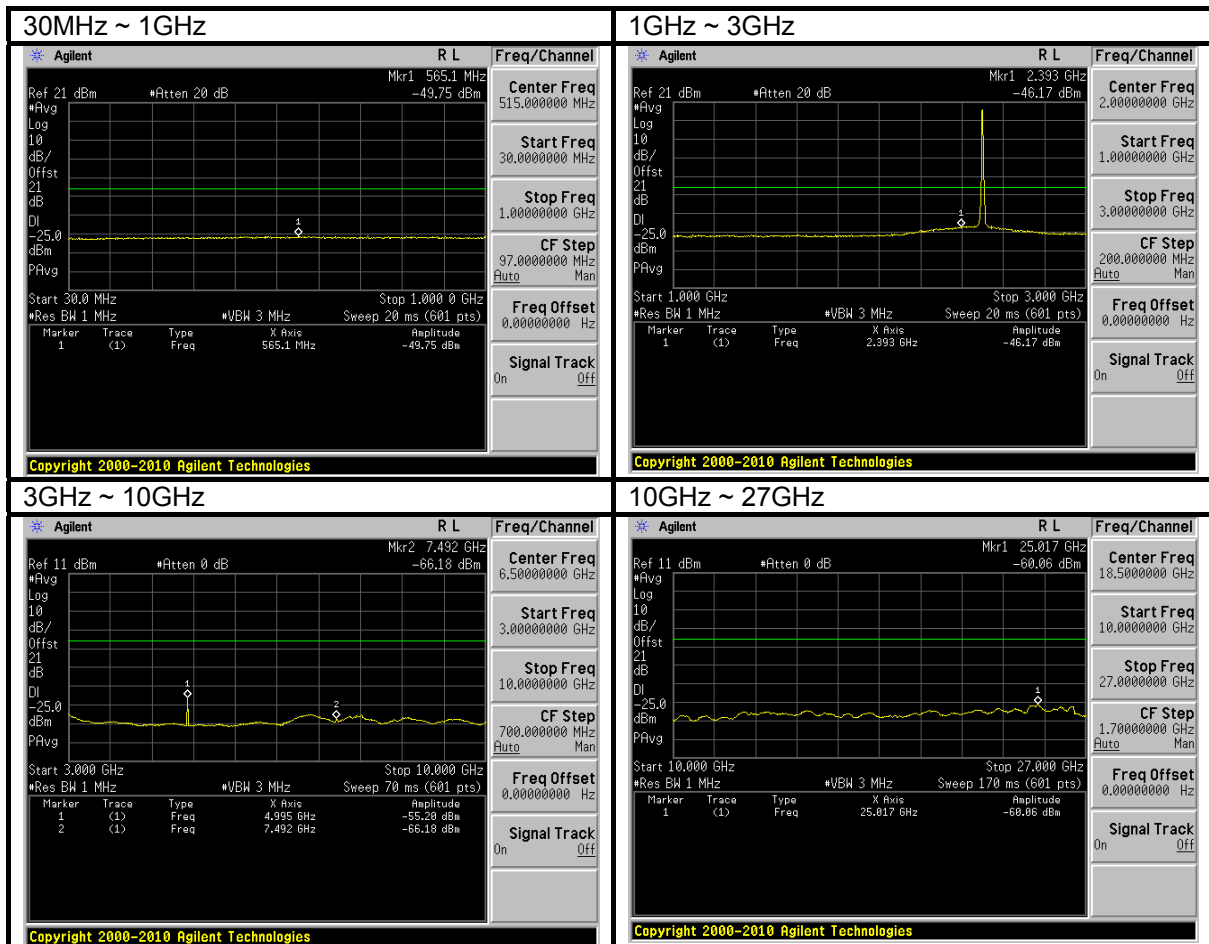



A D T

MIDDLE CHANNEL:

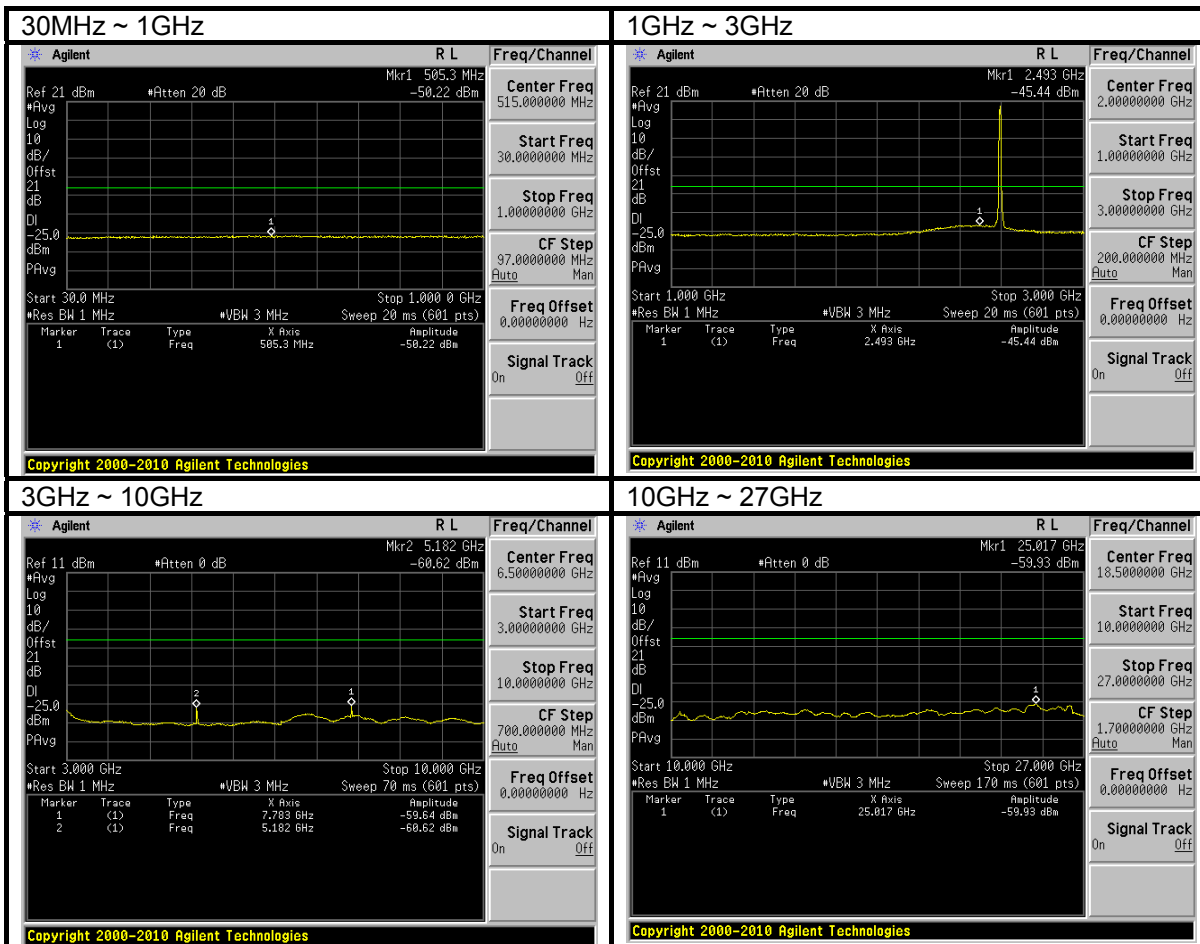



A D T

HIGH CHANNEL:

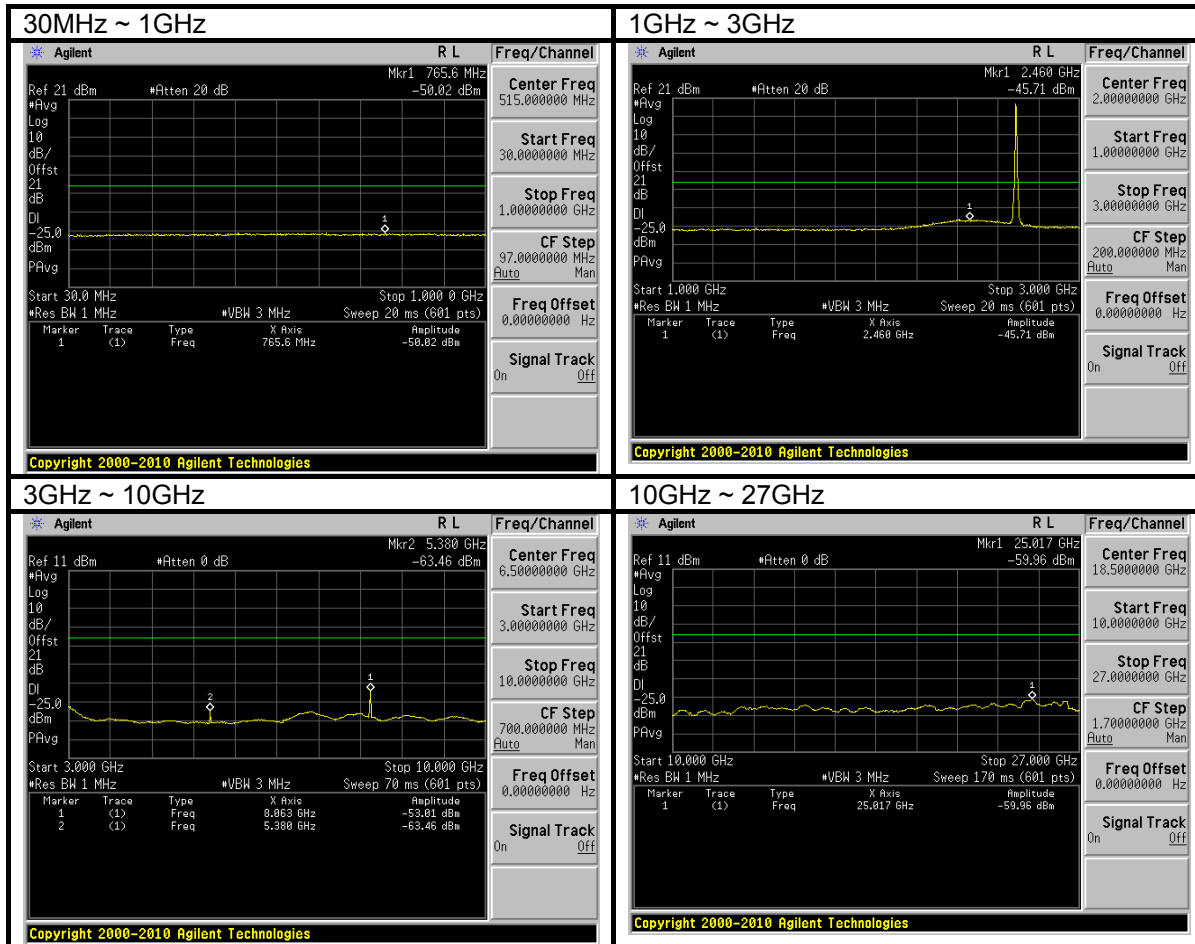



A D T

CHANNEL BANDWIDTH: 10MHz

LOW CHANNEL:

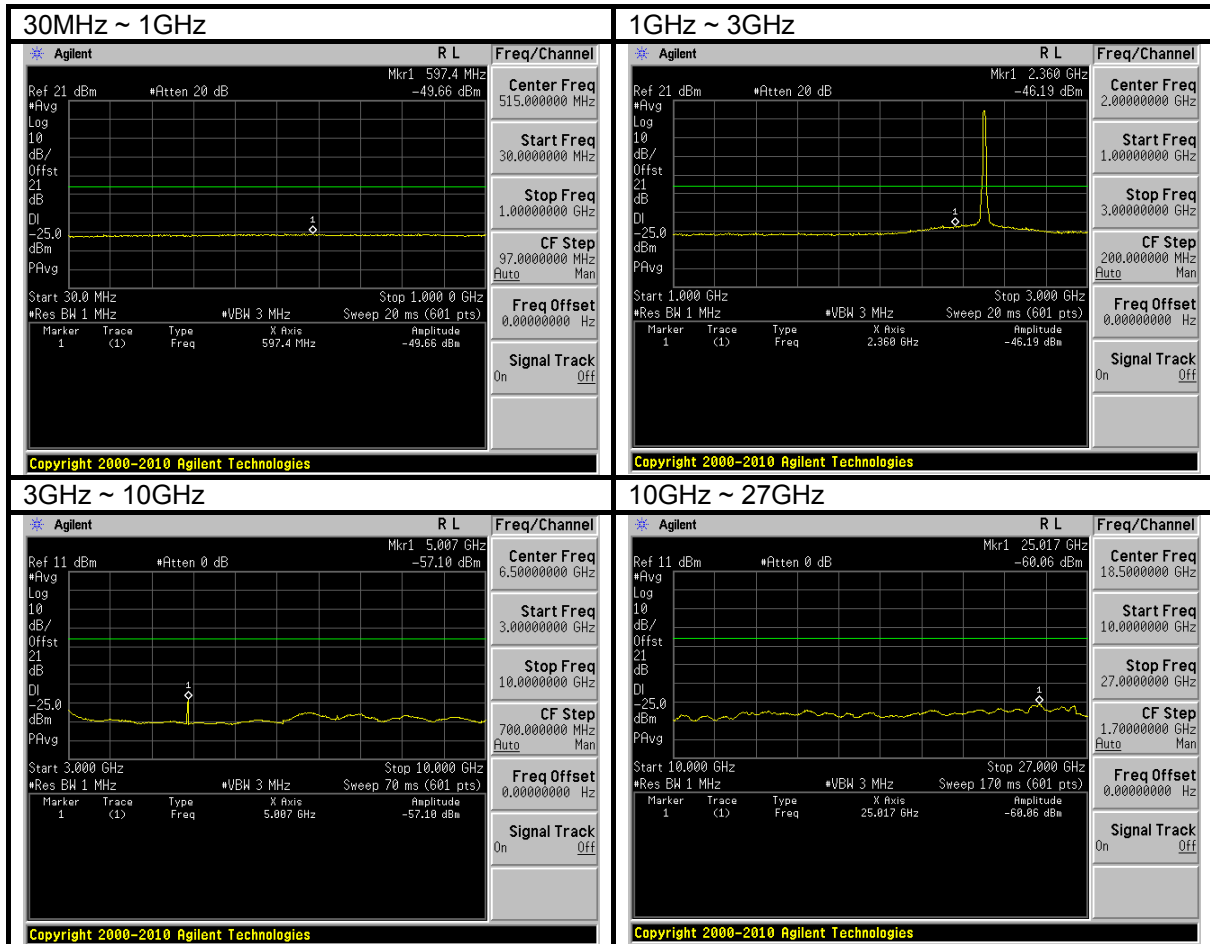



A D T

MIDDLE CHANNEL:

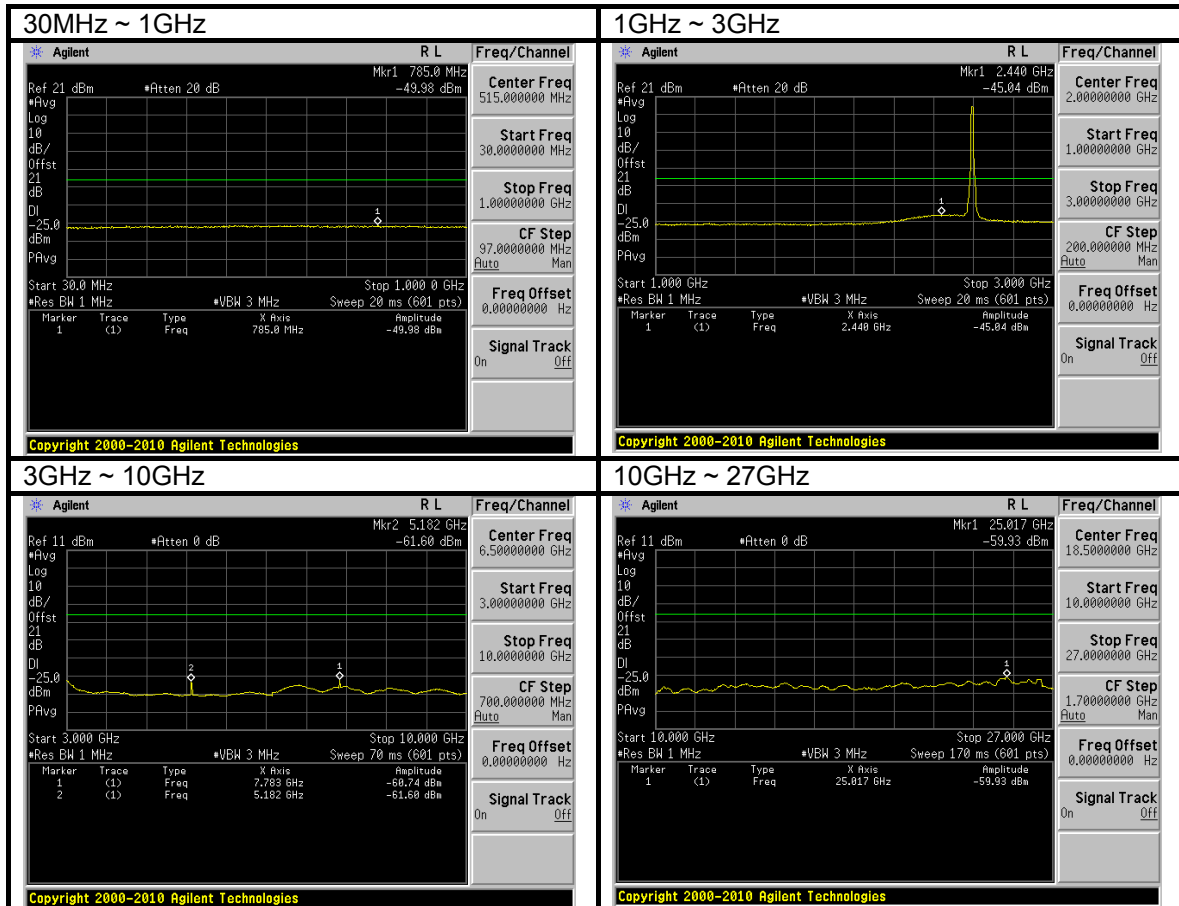



A D T

HIGH CHANNEL:

30MHz ~ 1GHz

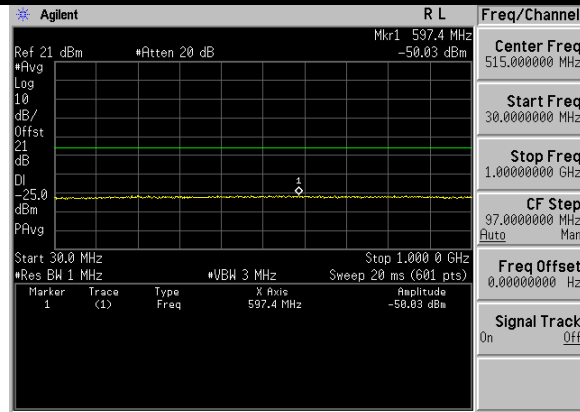

Copyright 2000-2010 Agilent Technologies

1GHz ~ 3GHz

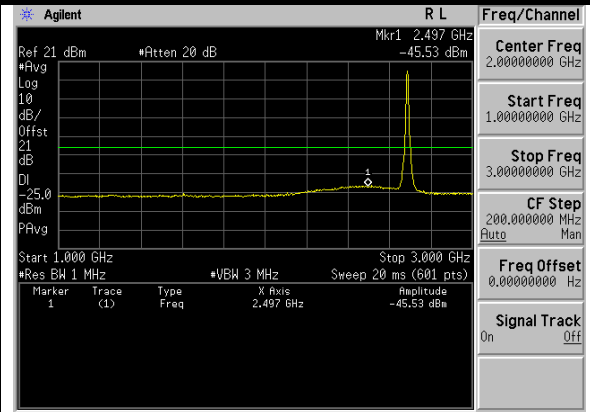

Copyright 2000-2010 Agilent Technologies

3GHz ~ 10GHz

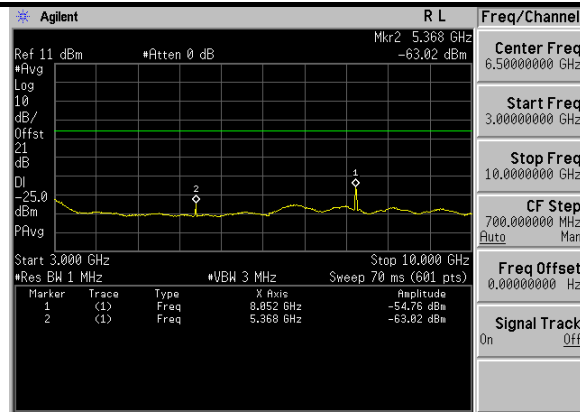

Copyright 2000-2010 Agilent Technologies

10GHz ~ 27GHz

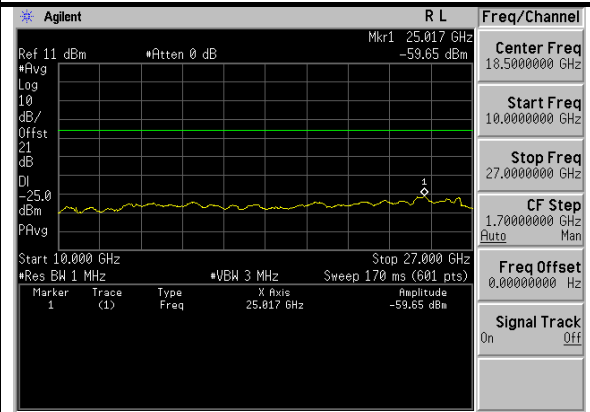

Copyright 2000-2010 Agilent Technologies



A D T

4.6 RADIATED EMISSION MEASUREMENT (BELOW 1GHz)

4.6.1 LIMITS OF RADIATED EMISSION MEASUREMENT

In the FCC 27.53(m) (4), On any frequency outside a licensee's frequency block the power of any emission shall be attenuated below the transmitter power (P) by at least $55 + 10 \log (P)$ dB. The limit of emission equal to -25 dBm.



4.6.2 TEST INSTRUMENTS

DESCRIPTION & MANUFACTURER	MODEL NO.	SERIAL NO.	DATE OF CALIBRATION	DUE DATE OF CALIBRATION
Test Receiver ROHDE & SCHWARZ	ESIB7	100212	Aug. 02, 2011	Aug. 01, 2012
Spectrum Analyzer ROHDE & SCHWARZ	FSP40	100041	Jul. 21, 2011	Jul. 20, 2012
BILOG Antenna SCHWARZBECK	VULB9168	9168-160	Apr. 13, 2011	Apr. 12, 2012
HORN Antenna SCHWARZBECK	9120D	209	Aug. 25, 2011	Aug. 24, 2012
HORN Antenna SCHWARZBECK	BBHA 9170	148	Jul. 20, 2011	Jul. 19, 2012
Preamplifier Agilent	8447D	2944A10633	Oct. 29, 2011	Oct. 28, 2012
Preamplifier Agilent	8449B	3008A01964	Oct. 29, 2011	Oct. 28, 2012
RF signal cable HUBER+SUHNNER	SUCOFLEX 104	250723/4	Aug. 30, 2011	Aug. 29, 2012
RF signal cable HUBER+SUHNNER	SUCOFLEX 106	12738/6+309224/ 4	Aug. 30, 2011	Aug. 29, 2012
Software ADT.	ADT_Radiated_ V7.6.15.9.2	NA	NA	NA
Antenna Tower inn-co GmbH	MA 4000	013303	NA	NA
Antenna Tower Controller inn-co GmbH	CO2000	017303	NA	NA
Turn Table ADT.	TT100.	TT93021703	NA	NA
Turn Table Controller ADT.	SC100.	SC93021703	NA	NA
Turn Table Controller ADT.	SC100.	SC93021704	NA	NA

- NOTE:**
1. The calibration interval of the above test instruments is 12 months and the calibrations are traceable to NML/ROC and NIST/USA.
 2. The test was performed in HwaYa Chamber 3.
 3. The horn antenna and HP preamplifier (model: 8449B) are used only for the measurement of emission frequency above 1GHz if tested.
 4. The FCC Site Registration No. is 988962.
 5. The IC Site Registration No. is IC 7450F-3.

4.6.3 TEST PROCEDURES

- a. The power was measured with R&S Spectrum Analyzer. All measurements were done at 3 channels (low, middle and high channel of operational frequency range.)
- b. Substitution method is used for E.I.R.P measurement. In the semi-anechoic chamber, EUT placed on the 0.8m height of Turn Table, rotated the table around 360 degrees to search the maximum radiation power and receiver antenna shall be rotated vertical and horizontal polarization and moved height from 1m to 4m to find the maximum polar radiated power. The “Read Value” is the spectrum reading the maximum power value.
- c. The substitution antenna is substituted for EUT at the same position and signals generator export the CW signal to the substitution antenna via a TX cable. Rotated the Turn Table and moved receiving antenna to find the maximum radiation power. Adjust output power level of S.G to get a Value of spectrum reading equal to “Read Value “ of step b. Record the power level of S.G
- d. $EIRP = \text{Output power level of S.G} - \text{TX cable loss} + \text{Antenna gain of substitution antenna.}$

NOTE: The resolution bandwidth and video bandwidth of test receiver/spectrum analyzer is 1MHz/3MHz

4.6.4 DEVIATION FROM TEST STANDARD

No deviation

4.6.5 TEST SETUP

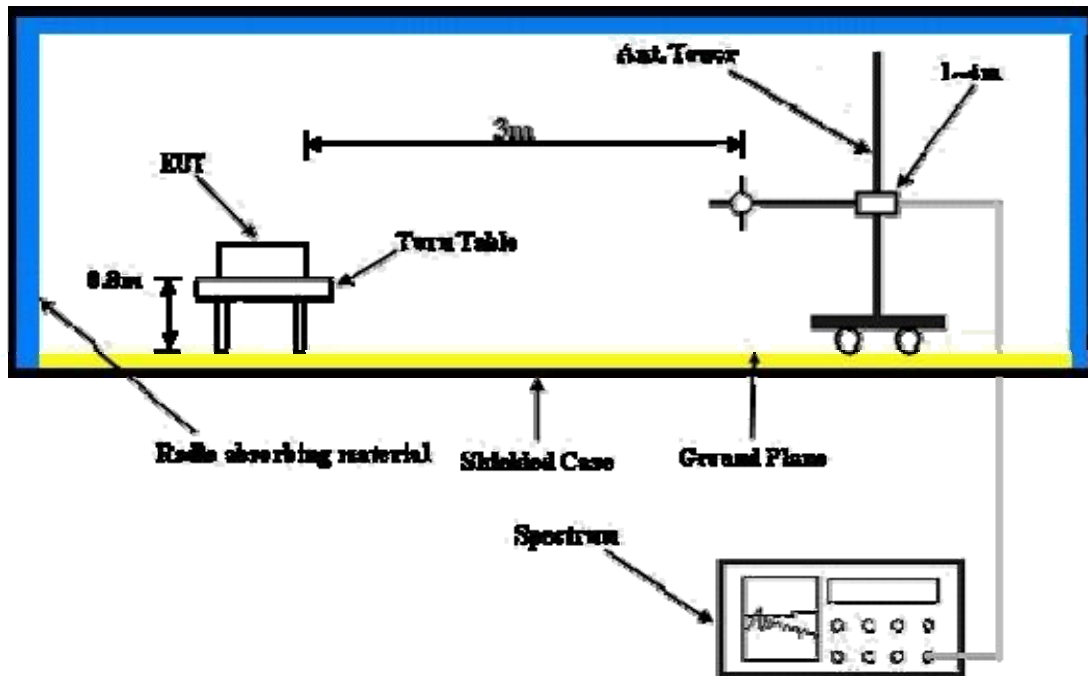

For the actual test configuration, please refer to the related item – Photographs of the Test Configuration.

4.6.6 EUT OPERATING CONDITIONS

Same as 4.1.5



A D T

4.6.7 TEST RESULTS

BELOW 1GHz WORST-CASE DATA

MODE	High channel	FREQUENCY RANGE	Below 1000MHz
CHANNEL BANDWIDTH	5MHz		

ANTENNA POLARITY & TEST DISTANCE: HORIZONTAL AT 3 M							
No.	Freq. (MHz)	Reading (dBm)	S.G Power Value (dBm)	Correction Factor (dB)	EIRP (dBm)	Limit (dBm)	Margin (dB)
1	31.94	-64.2	-47.8	-12.4	-60.2	-25.0	-35.2
2	105.81	-58.6	-65.9	0.6	-65.3	-25.0	-40.3
3	195.23	-46.2	-57.0	4.9	-52.1	-25.0	-27.1
4	251.60	-44.1	-54.6	5.4	-49.2	-25.0	-24.2
5	307.98	-61.6	-70.5	5.1	-65.4	-25.0	-40.4
6	364.35	-65.0	-71.8	5.2	-66.6	-25.0	-41.6

ANTENNA POLARITY & TEST DISTANCE: VERTICAL AT 3 M							
No.	Freq. (MHz)	Reading (dBm)	S.G Power Value (dBm)	Correction Factor (dB)	EIRP (dBm)	Limit (dBm)	Margin (dB)
1	70.82	-59.0	-60.8	-4.7	-65.5	-25.0	-40.5
2	195.23	-57.3	-64.4	4.9	-59.5	-25.0	-34.5
3	251.60	-53.9	-62.1	5.4	-56.7	-25.0	-31.7
4	346.85	-62.9	-69.1	5.2	-63.9	-25.0	-38.9
5	379.90	-60.1	-65.0	5.2	-59.8	-25.0	-34.8
6	692.87	-67.8	-66.7	5.2	-61.5	-25.0	-36.5

NOTE: Power Value (dBum) = S.G Power Value (dBm) + Correction Factor (dB).



A D T

MODE	Mid. channel	FREQUENCY RANGE	Below 1000MHz
CHANNEL BANDWIDTH	10MHz		

ANTENNA POLARITY & TEST DISTANCE: HORIZONTAL AT 3 M

No.	Freq. (MHz)	Reading (dBm)	S.G Power Value (dBm)	Correction Factor (dB)	EIRP (dBm)	Limit (dBm)	Margin (dB)
1	31.94	-66.3	-49.9	-12.4	-62.3	-25.0	-37.3
2	105.81	-56.1	-63.4	0.6	-62.8	-25.0	-37.8
3	195.23	-46.2	-57.0	4.9	-52.1	-25.0	-27.1
4	251.60	-44.0	-54.5	5.4	-49.1	-25.0	-24.1
5	307.98	-61.6	-70.5	5.1	-65.4	-25.0	-40.4
6	364.35	-65.3	-72.1	5.2	-66.9	-25.0	-41.9

ANTENNA POLARITY & TEST DISTANCE: VERTICAL AT 3 M

No.	Freq. (MHz)	Reading (dBm)	S.G Power Value (dBm)	Correction Factor (dB)	EIRP (dBm)	Limit (dBm)	Margin (dB)
1	49.44	-56.3	-52.5	-9.8	-62.3	-25.0	-37.3
2	195.23	-57.0	-64.1	4.9	-59.2	-25.0	-34.2
3	251.60	-53.9	-62.1	5.4	-56.7	-25.0	-31.7
4	267.15	-61.1	-68.8	5.3	-63.5	-25.0	-38.5
5	364.35	-67.2	-72.8	5.2	-67.6	-25.0	-42.6
6	475.15	-69.1	-72.7	5.0	-67.7	-25.0	-42.7

NOTE: Power Value (dBum) = S.G Power Value (dBm) + Correction Factor (dB).



A D T

ABOVE 1GHz

MODE	Low channel	FREQUENCY RANGE	Above 1000MHz
CHANNEL BANDWIDTH	5MHz		

ANTENNA POLARITY & TEST DISTANCE: HORIZONTAL AT 3 M

No.	Freq. (MHz)	Reading (dBm)	S.G Power Value (dBm)	Correction Factor (dB)	EIRP (dBm)	Limit (dBm)	Margin (dB)
1	4997.00	-58.3	-48.9	6.6	-42.3	-25.0	-17.3
2	7495.50	-49.1	-31.6	4.2	-27.4	-25.0	-2.4
3	9994.00	-62.8	-41.8	3.5	-38.3	-25.0	-13.3

ANTENNA POLARITY & TEST DISTANCE: VERTICAL AT 3 M

No.	Freq. (MHz)	Reading (dBm)	S.G Power Value (dBm)	Correction Factor (dB)	EIRP (dBm)	Limit (dBm)	Margin (dB)
1	4997.00	-58.8	-50.5	6.6	-43.9	-25.0	-18.9
2	7495.50	-56.5	-39.7	4.2	-35.5	-25.0	-10.5
3	9994.00	-62.2	-42.4	3.5	-38.9	-25.0	-13.9

NOTE: Power Value (dBm) = S.G Power Value (dBm) + Correction Factor (dB).



A D T

MODE	Mid. channel	FREQUENCY RANGE	Above 1000MHz
CHANNEL BANDWIDTH	5MHz		

ANTENNA POLARITY & TEST DISTANCE: HORIZONTAL AT 3 M

No.	Freq. (MHz)	Reading (dBm)	S.G Power Value (dBm)	Correction Factor (dB)	EIRP (dBm)	Limit (dBm)	Margin (dB)
1	5186.00	-57.3	-47.3	6.7	-40.6	-25.0	-15.6
2	7779.00	-48.2	-30.1	4.1	-26.0	-25.0	-1.0
3	10372.00	-61.5	-39.2	3.0	-36.2	-25.0	-11.2

ANTENNA POLARITY & TEST DISTANCE: VERTICAL AT 3 M

No.	Freq. (MHz)	Reading (dBm)	S.G Power Value (dBm)	Correction Factor (dB)	EIRP (dBm)	Limit (dBm)	Margin (dB)
1	5186.00	-55.2	-46.6	6.7	-39.9	-25.0	-14.9
2	7779.00	-57.2	-40.0	4.1	-35.9	-25.0	-10.9
3	10372.00	-62.0	-41.2	3.0	-38.2	-25.0	-13.2

NOTE: Power Value (dBum) = S.G Power Value (dBm) + Correction Factor (dB).



A D T

MODE	High channel	FREQUENCY RANGE	Above 1000MHz
CHANNEL BANDWIDTH	5MHz		

ANTENNA POLARITY & TEST DISTANCE: HORIZONTAL AT 3 M

No.	Freq. (MHz)	Reading (dBm)	S.G Power Value (dBm)	Correction Factor (dB)	EIRP (dBm)	Limit (dBm)	Margin (dB)
1	5375.00	-47.1	-36.6	6.8	-29.8	-25.0	-4.8
2	8062.50	-48.8	-30.2	4.1	-26.1	-25.0	-1.1
3	10750.00	-59.7	-36.0	2.4	-33.6	-25.0	-8.6

ANTENNA POLARITY & TEST DISTANCE: VERTICAL AT 3 M

No.	Freq. (MHz)	Reading (dBm)	S.G Power Value (dBm)	Correction Factor (dB)	EIRP (dBm)	Limit (dBm)	Margin (dB)
1	5375.00	-56.4	-47.4	6.8	-40.6	-25.0	-15.6
2	8062.50	-58.5	-41.0	4.1	-36.9	-25.0	-11.9
3	10750.00	-63.3	-41.3	2.4	-38.9	-25.0	-13.9

NOTE: Power Value (dBum) = S.G Power Value (dBm) + Correction Factor (dB).



A D T

MODE	Low channel	FREQUENCY RANGE	Above 1000MHz
CHANNEL BANDWIDTH	10MHz		

ANTENNA POLARITY & TEST DISTANCE: HORIZONTAL AT 3 M

No.	Freq. (MHz)	Reading (dBm)	S.G Power Value (dBm)	Correction Factor (dB)	EIRP (dBm)	Limit (dBm)	Margin (dB)
1	5002.00	-58.3	-48.9	6.6	-42.3	-25.0	-17.3
2	7503.00	-49.1	-31.6	4.2	-27.4	-25.0	-2.4
3	10004.00	-61.2	-40.3	3.5	-36.8	-25.0	-11.8

ANTENNA POLARITY & TEST DISTANCE: VERTICAL AT 3 M

No.	Freq. (MHz)	Reading (dBm)	S.G Power Value (dBm)	Correction Factor (dB)	EIRP (dBm)	Limit (dBm)	Margin (dB)
1	5002.00	-59.2	-50.9	6.6	-44.3	-25.0	-19.3
2	7503.00	-56.4	-39.6	4.2	-35.4	-25.0	-10.4
3	10004.00	-61.1	-41.3	3.5	-37.8	-25.0	-12.8

NOTE: Power Value (dBm) = S.G Power Value (dBm) + Correction Factor (dB).



A D T

MODE	Mid. channel	FREQUENCY RANGE	Above 1000MHz
CHANNEL BANDWIDTH	10MHz		

ANTENNA POLARITY & TEST DISTANCE: HORIZONTAL AT 3 M

No.	Freq. (MHz)	Reading (dBm)	S.G Power Value (dBm)	Correction Factor (dB)	EIRP (dBm)	Limit (dBm)	Margin (dB)
1	5186.00	-57.9	-47.9	6.7	-41.2	-25.0	-16.2
2	7779.00	-48.5	-30.4	4.1	-26.3	-25.0	-1.3
3	10372.00	-61.0	-38.7	3.0	-35.7	-25.0	-10.7

ANTENNA POLARITY & TEST DISTANCE: VERTICAL AT 3 M

No.	Freq. (MHz)	Reading (dBm)	S.G Power Value (dBm)	Correction Factor (dB)	EIRP (dBm)	Limit (dBm)	Margin (dB)
1	5186.00	-56.6	-48.0	6.7	-41.3	-25.0	-16.3
2	7779.00	-57.9	-40.7	4.1	-36.6	-25.0	-11.6
3	10372.00	-62.2	-41.4	3.0	-38.4	-25.0	-13.4

NOTE: Power Value (dBum) = S.G Power Value (dBm) + Correction Factor (dB).



A D T

MODE	High channel	FREQUENCY RANGE	Above 1000MHz
CHANNEL BANDWIDTH	10MHz		

ANTENNA POLARITY & TEST DISTANCE: HORIZONTAL AT 3 M

No.	Freq. (MHz)	Reading (dBm)	S.G Power Value (dBm)	Correction Factor (dB)	EIRP (dBm)	Limit (dBm)	Margin (dB)
1	5370.00	-57.3	-46.8	6.8	-40.0	-25.0	-15.0
2	8055.00	-49.0	-30.4	4.1	-26.3	-25.0	-1.3
3	10740.00	-59.4	-35.7	2.4	-33.3	-25.0	-8.3

ANTENNA POLARITY & TEST DISTANCE: VERTICAL AT 3 M

No.	Freq. (MHz)	Reading (dBm)	S.G Power Value (dBm)	Correction Factor (dB)	EIRP (dBm)	Limit (dBm)	Margin (dB)
1	5370.00	-57.4	-48.4	6.8	-41.6	-25.0	-16.6
2	8055.00	-54.8	-37.4	4.1	-33.3	-25.0	-8.3
3	10740.00	-59.5	-37.5	2.4	-35.1	-25.0	-10.1

NOTE: Power Value (dBm) = S.G Power Value (dBm) + Correction Factor (dB).



A D T

5 PHOTOGRAPHS OF THE TEST CONFIGURATION

Please refer to the attached file (Test Setup Photo).



6 INFORMATION ON THE TESTING LABORATORIES

We, Bureau Veritas Consumer Products Services (H.K.) Ltd., Taoyuan Branch, were founded in 1988 to provide our best service in EMC, Radio, Telecom and Safety consultation. Our laboratories are accredited and approved according to ISO/IEC 17025.

Copies of accreditation and authorization certificates of our laboratories obtained from approval agencies can be downloaded from our web site: www.adt.com.tw/index.5.phtml. If you have any comments, please feel free to contact us at the following:

Linko EMC/RF Lab:

Tel: 886-2-26052180

Fax: 886-2-26051924

Hsin Chu EMC/RF Lab:

Tel: 886-3-5935343

Fax: 886-3-5935342

Hwa Ya EMC/RF/Safety/Telecom Lab:

Tel: 886-3-3183232

Fax: 886-3-3185050

Email: service.adt@tw.bureauveritas.com

Web Site: www.adt.com.tw

The address and road map of all our labs can be found in our web site also.

---END---