

FCC C2PC Test Report

FCC ID : MXF-W1701K
Equipment : Tri-Band AP
Model No. : W1701K
Brand Name : Q Fiber
Applicant : Gemtek Technology Co., Ltd.
Address : No. 15-1 Zhonghua Road, Hsinchu Industrial
Park, Hukou, Hsinchu, Taiwan, 30352.
Standard : 47 CFR FCC Part 15.247
Received Date : Jun. 27, 2023
Tested Date : Jan. 04, 2024

We, International Certification Corporation, would like to declare that the tested sample has been evaluated and in compliance with the requirement of the above standards. The test results contained in this report refer exclusively to the product. It shall not be reproduced except in full without the written approval of our laboratory.

Reviewed by:

Approved by:



Along Chen / Assistant Manager



Gary Chang / Manager

Table of Contents

1	GENERAL DESCRIPTION	5
1.1	Information.....	5
1.2	Local Support Equipment List	8
1.3	Test Setup Chart	8
1.4	Test Equipment List and Calibration Data.....	9
1.5	Test Standards	10
1.6	Reference Guidance	10
1.7	Deviation from Test Standard and Measurement Procedure.....	10
1.8	Measurement Uncertainty	10
2	TEST CONFIGURATION.....	11
2.1	Testing Facility	11
2.2	The Worst Test Modes and Channel Details	11
3	TRANSMITTER TEST RESULTS	12
3.1	Unwanted Emissions in Restricted Frequency Bands	12
3.2	AC Power Line Conducted Emissions	14
4	TEST LABORATORY INFORMATION	15

Appendix A. Unwanted Emissions into Restricted Frequency Bands

Appendix B. AC Power Line Conducted Emissions

Release Record

Report No.	Version	Description	Issued Date
FR362701-01AE	Rev. 01	Initial issue	Mar. 18, 2024

Summary of Test Results

FCC Rules	Test Items	Measured	Result
15.207	AC Power Line Conducted Emissions	[dBuV]: 0.788MHz 51.38 (Margin -4.62dB) - QP	Pass
15.247(d) 15.209	Unwanted Emissions	[dBuV/m at 3m]: 42.61MHz 34.26 (Margin -5.74dB) - PK	Pass

Declaration of Conformity:

The test results with all measurement uncertainty excluded are presented in accordance with the regulation limits or requirements declared by manufacturers.

Comments and Explanations:

The declared of product specification for EUT presented in the report are provided by the manufacturer, and the manufacturer takes all the responsibilities for the accuracy of product specification.

1 General Description

1.1 Information

This report is issued as a Class II Permissive Change.

This report is issued as a supplementary report to original ICC report no. FR362701AE. The modification is the adding one Internal Power source. Therefore, all related test items had been tested and presented in the following sections.

1.1.1 Specification of the Equipment under Test (EUT)

RF General Information				
Frequency Range (MHz)	Bluetooth Mode	Ch. Freq. (MHz)	Channel Number	Data Rate
2400-2483.5	LE	2402-2480	0-39 [40]	125 kbps
				500 kbps
				1 Mbps
				2 Mbps
Note: Bluetooth LE (Low energy) uses GFSK modulation.				

1.1.2 Antenna Details

Ant. No.	Type	Connector	Gain (dBi)
1	PIFA	UFL	2.4

1.1.3 Power Supply Type of Equipment under Test (EUT)

Power Supply Type	12Vdc from Internal Power source
--------------------------	----------------------------------

1.1.4 Accessories (Adding Internal Power source was marked in boldface.)

Accessories		
No.	Equipment	Description
1	Internal Power source	Brand: LUCENT TRANS ELECTRONICS CO., LTD. Model: 1A106-US1240 I/P: 100-120Vac, 50/60Hz, 1.4A max O/P: 12V=4.0A, 48.0W
2	Internal Power source	Brand: LEADER ELECTRONICS INC. Model: SL42-1120350-3C I/P: 100-120Vac, 50-60Hz, 1.5A O/P: 12V=3.5A
3	Internal Power source	Brand: Hunan Frecom electronics Co.,Ltd Model: FC042X02-120035 I/P: 100-120Vac, 50/60Hz, 1.2A O/P: 12V=3.5A
4	Fan	Brand: SUNONWEALTH ELECTRIC MACHINE INDUSTRY CO LTD Model: EG75070S1-C395-S99
5	Fan	Brand: Yingfan Model: NB801005HHT4B10001

1.1.5 Channel List

Frequency band (MHz)				2400~2483.5			
Channel	Frequency (MHz)	Channel	Frequency (MHz)	Channel	Frequency (MHz)	Channel	Frequency (MHz)
37	2402	9	2422	18	2442	28	2462
0	2404	10	2424	19	2444	29	2464
1	2406	38	2426	20	2446	30	2466
2	2408	11	2428	21	2448	31	2468
3	2410	12	2430	22	2450	32	2470
4	2412	13	2432	23	2452	33	2472
5	2414	14	2434	24	2454	34	2474
6	2416	15	2436	25	2456	35	2476
7	2418	16	2438	26	2458	36	2478
8	2420	17	2440	27	2460	39	2480

1.1.6 Test Tool and Duty Cycle

Test Tool	BGTool, Version: 2.137-347	
Modulation Mode	Duty Cycle Of Test Signal (%)	Duty Factor (dB)
BT-LE(1Mbps)	88.16%	0.55

1.1.7 Power Index of Test Tool

Modulation Mode	Test Frequency (MHz)
	2402
BT-LE(1Mbps)	100

1.2 Local Support Equipment List

Support Equipment List					
No.	Equipment	Brand	Model	FCC ID	Remarks
1	Laptop	DELL	Latitude 5400	DoC	---
2	Laptop	DELL	Latitude E5470	DoC	---
3	Fixture	---	---	---	---
4	Laptop	DELL	Latitude E5470	---	---

Note: The fixture and laptop are disconnected from EUT and removed from test table when EUT is set to transmit continuously.

1.3 Test Setup Chart

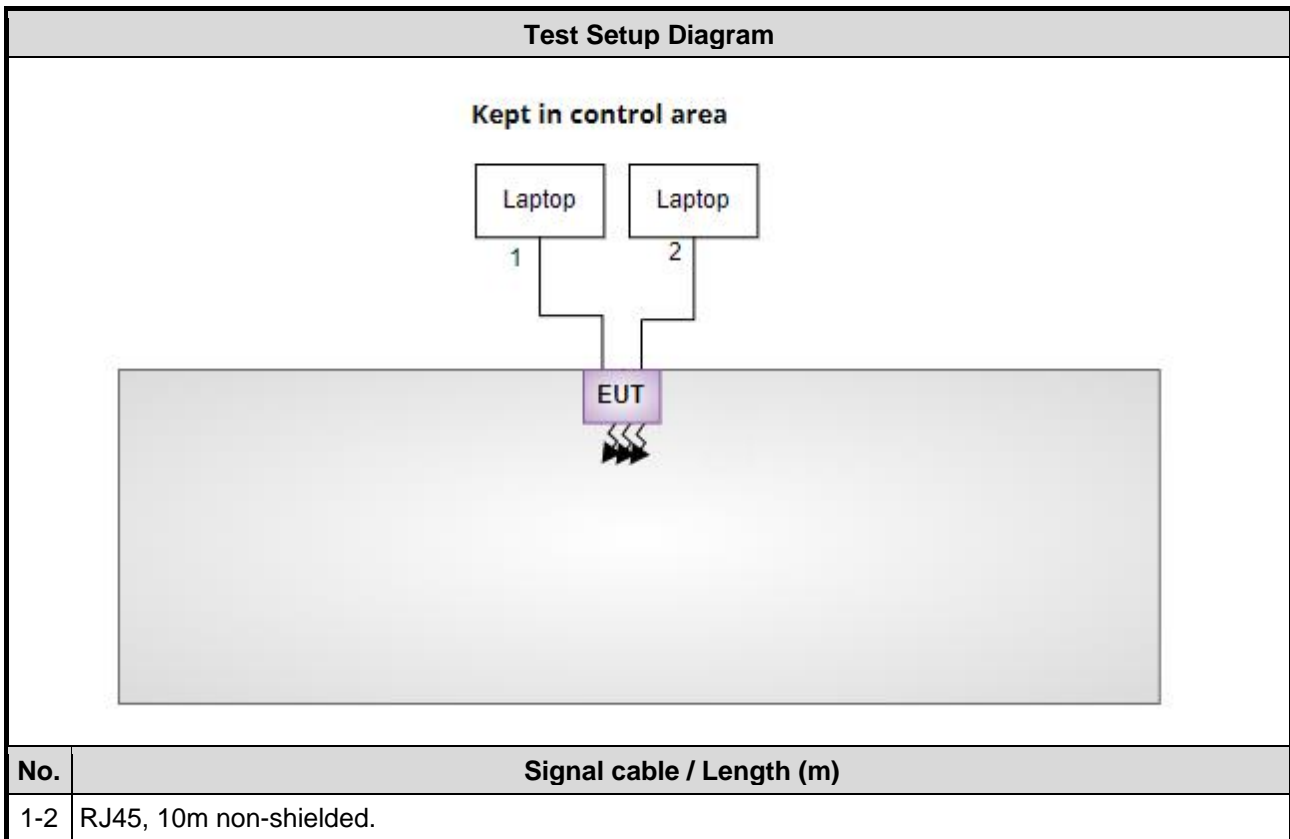

1.4 Test Equipment List and Calibration Data

Test Item	Conducted Emission				
Test Site	Conduction room 1 / (CO01-WS)				
Tested Date	Jan. 04, 2024				
Instrument	Brand	Model No.	Serial No.	Calibration Date	Calibration Until
Receiver	R&S	ESR3	101658	Feb. 17, 2023	Feb. 16, 2024
LISN	R&S	ENV216	101579	May 09, 2023	May 08, 2024
RF Cable-CON	Woken	CFD200-NL	CFD200-NL-001	Oct. 11, 2023	Oct. 10, 2024
LISN (Support Unit)	SCHWARZBECK	Schwarzbeck 8127	8127-666	Feb. 24, 2023	Feb. 23, 2024
50 ohm terminal (Support Unit)	NA	50	01	Jun. 14, 2023	Jun. 13, 2024
Measurement Software	AUDIX	e3	6.120210k	NA	NA

Note: Calibration Interval of instruments listed above is one year.

Test Item	Radiated Emission				
Test Site	966 chamber1 / (03CH01-WS)				
Tested Date	Jan. 04, 2024				
Instrument	Brand	Model No.	Serial No.	Calibration Date	Calibration Until
Receiver	R&S	ESR3	101657	Mar. 03, 2023	Mar. 02, 2024
Spectrum Analyzer	R&S	FSV40	101498	Nov. 23, 2023	Nov. 22, 2024
Loop Antenna	R&S	HFH2-Z2	100330	Oct. 31, 2023	Oct. 30, 2024
Bilog Antenna	SCHWARZBECK	VULB9168	VULB9168-522	Jul. 31, 2023	Jul. 30, 2024
Horn Antenna 1G-18G	SCHWARZBECK	BBHA 9120 D	BBHA 9120 D 1096	Nov. 27, 2023	Nov. 26, 2024
Horn Antenna 18G-40G	SCHWARZBECK	BBHA 9170	BBHA 9170517	Oct. 30, 2023	Oct. 29, 2024
Preamplifier	EMC	EMC02325	980225	Jun. 28, 2023	Jun. 27, 2024
Preamplifier	EMC	EMC118A45SE	980898	Jul. 14, 2023	Jul. 13, 2024
Preamplifier	EMC	EMC184045SE	980903	Jul. 17, 2023	Jul. 16, 2024
Loop Antenna Cable	KOAX KABEL	101354-BW	101354-BW	Oct. 03, 2023	Oct. 02, 2024
LF cable 3M	Woken	CFD400NL-LW	CFD400NL-001	Oct. 03, 2023	Oct. 02, 2024
LF cable 11M	EMC	EMCCFD400-NW-N W-11000	200801	Oct. 03, 2023	Oct. 02, 2024
LF cable 1M	EMC	EMCCFD400-NM-N M-1000	160502	Oct. 03, 2023	Oct. 02, 2024
RF Cable	EMC	EMC104-35M-35M-8000	210920	Oct. 03, 2023	Oct. 02, 2024
RF Cable	EMC	EMC104-35M-35M-3000	210922	Oct. 03, 2023	Oct. 02, 2024
Attenuator	Pasternack	PE7005-10	10-1	Oct. 05, 2023	Oct. 04, 2024
HIGHPASS FILTER 3.1-18G	WHK	WHK3.1/18G-10SS	39	Oct. 05, 2023	Oct. 04, 2024
Measurement Software	AUDIX	e3	6.120210g	NA	NA

Note: Calibration Interval of instruments listed above is one year.

1.5 Test Standards

47 CFR FCC Part 15.247

ANSI C63.10-2013

1.6 Reference Guidance

FCC KDB 558074 D01 15.247 Meas Guidance v05r02

1.7 Deviation from Test Standard and Measurement Procedure

None

1.8 Measurement Uncertainty

The measurement uncertainties given below are based on a 95% confidence level (based on a coverage factor ($k=2$)).

Measurement Uncertainty	
Parameters	Uncertainty
AC conducted emission	± 2.92 dB
Unwanted Emission ≤ 1 GHz	± 3.41 dB
Unwanted Emission > 1 GHz	± 4.59 dB

2 Test Configuration

2.1 Testing Facility

Test Laboratory	International Certification Corporation
Test Site	CO01-WS, 03CH01-WS
Address of Test Site	No.3-1, Lane 6, Wen San 3rd St., Kwei Shan Dist., Tao Yuan City 33381, Taiwan (R.O.C.)

- FCC Designation No.: TW2732
- FCC site registration No.: 181692
- ISED#: 10807A
- CAB identifier: TW2732

2.2 The Worst Test Modes and Channel Details

Test item	Modulation Mode	Test Frequency (MHz)	Test Configuration
AC Power Line Conducted Emissions	BT-LE(1Mbps)	2402	---
Unwanted Emissions ≤ 1GHz	BT-LE(1Mbps)	2402	---
Unwanted Emissions > 1GHz	BT-LE(1Mbps)	2402	---

NOTE:

- The EUT was pretested with 3 orientations placed on the table for the radiated emission measurement – X, Y, and Z-plane. The **Y-plane** results were found as the worst case and were shown in this report.
- Two Fans (SUNONWEALTH ELECTRIC MACHINE INDUSTRY CO LTD and Yingfan) had been covered during the pretest, and found that **SUNONWEALTH ELECTRIC MACHINE INDUSTRY CO LTD** was the worst case and was selected for final test.

3 Transmitter Test Results

3.1 Unwanted Emissions in Restricted Frequency Bands

3.1.1 Limit of Unwanted Emissions in Restricted Frequency Bands

Restricted Band Emissions Limit			
Frequency Range (MHz)	Field Strength (uV/m)	Field Strength (dBuV/m)	Measure Distance (m)
0.009~0.490	2400/F(kHz)	48.5 - 13.8	300
0.490~1.705	24000/F(kHz)	33.8 - 23	30
1.705~30.0	30	29	30
30~88	100	40	3
88~216	150	43.5	3
216~960	200	46	3
Above 960	500	54	3

Note 1:
Quasi-Peak value is measured for frequency below 1GHz except for 9–90 kHz, 110–490 kHz frequency band. Peak and average value are measured for frequency above 1GHz. The limit on average radio frequency emission is as above table. The limit on peak radio frequency emissions is 20 dB above the maximum permitted average emission limit

Note 2:
Measurements may be performed at a distance other than what is specified provided. When performing measurements at a distance other than that specified, the results shall be extrapolated to the specified distance using an extrapolation factor as below, Frequency at or above 30 MHz: 20 dB/decade Frequency below 30 MHz: 40 dB/decade.

3.1.2 Test Procedures

1. Measurement is made at a semi-anechoic chamber that incorporates a turntable allowing a EUT rotation of 360°. A continuously-rotating, remotely-controlled turntable is installed at the test site to support the EUT and facilitate determination of the direction of maximum radiation for each EUT emission frequency. The EUT is placed at test table. For emissions testing at or below 1 GHz, the table height is 80 cm above the reference ground plane. For emission measurements above 1 GHz, the table height is 1.5 m
2. Measurement is made with the antenna positioned in both the horizontal and vertical planes of polarization. The measurement antenna is varied in height (1m ~ 4m) above the reference ground plane to obtain the maximum signal strength. Distance between EUT and antenna is 3 m.
3. This investigation is performed with the EUT rotated 360°, the antenna height scanned between 1 m and 4 m, and the antenna rotated to repeat the measurements for both the horizontal and vertical antenna polarizations.

Note:

1. 120kHz measurement bandwidth of test receiver and Quasi-peak detector is for radiated emission below 1GHz.
2. RBW=1MHz, VBW=3MHz and Peak detector is for peak measured value of radiated emission above 1GHz.
3. RBW=1MHz, VBW=1/T and Peak detector is for average measured value of radiated emission above 1GHz.

3.1.3 Test Setup

Radiated Emissions below 1 GHz

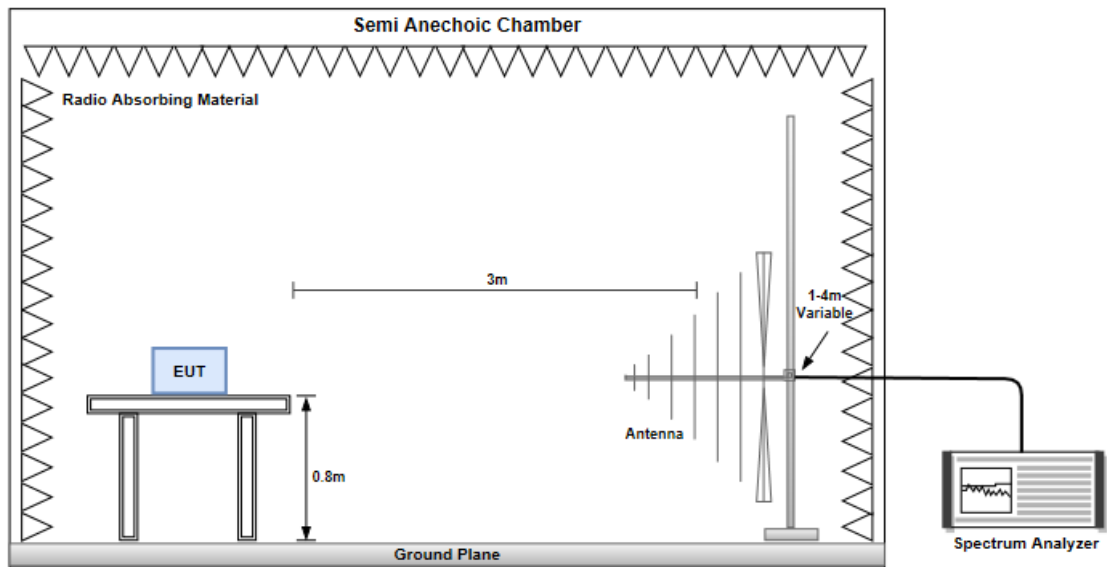

Radiated Emissions above 1 GHz

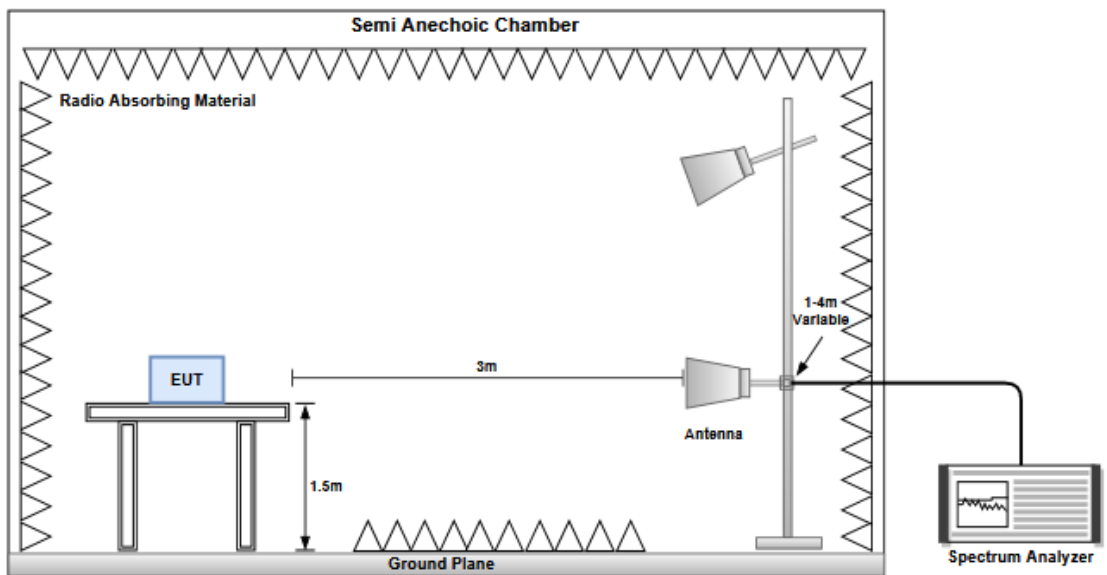

3.1.4 Test Results

Refer to Appendix A.

3.2 AC Power Line Conducted Emissions

3.2.1 Limit of AC Power Line Conducted Emissions

Conducted Emissions Limit		
Frequency Emission (MHz)	Quasi-Peak	Average
0.15-0.5	66 - 56 *	56 - 46 *
0.5-5	56	46
5-30	60	50

Note 1: * Decreases with the logarithm of the frequency.

3.2.2 Test Procedures

1. The device is placed on a test table, raised 80 cm above the reference ground plane. The vertical conducting plane is located 40 cm to the rear of the device.
2. The device is connected to line impedance stabilization network (LISN) and other accessories are connected to other LISN. Measured levels of AC power line conducted emission are across the 50 Ω LISN port.
3. AC conducted emission measurements is made over frequency range from 150 kHz to 30 MHz.
4. This measurement was performed with AC 120V/60Hz

3.2.3 Test Setup

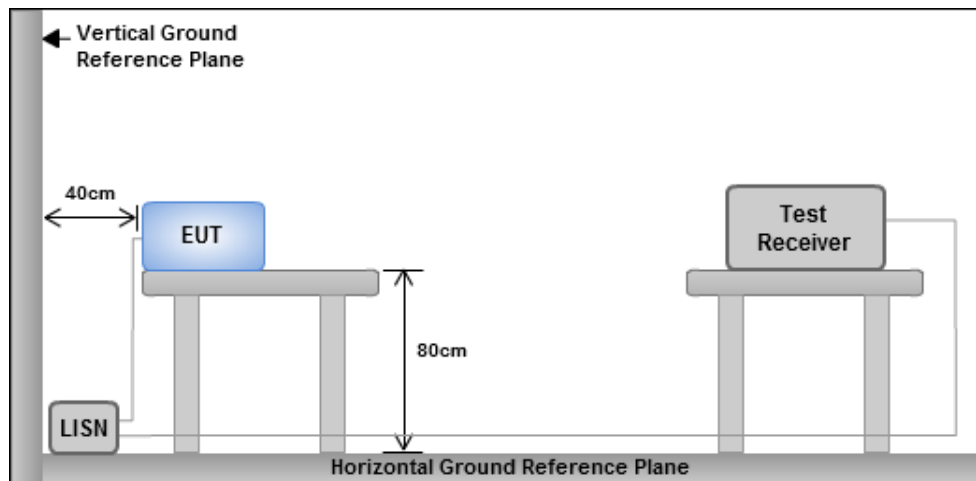

- Note: 1. Support units were connected to second LISN.
2. Both of LISNs (AMN) are 80 cm from EUT and at least 80 cm from other units and other metal planes

3.2.4 Test Results

Refer to Appendix B.

4 Test laboratory information

Established in 2012, ICC provides foremost EMC & RF Testing and advisory consultation services by our skilled engineers and technicians. Our services employ a wide variety of advanced edge test equipment and one of the widest certification extents in the business.

International Certification Corporation (EMC and Wireless Communication Laboratory), it is our definitive objective is to institute long term, trust-based associations with our clients. The expectation we set up with our clients is based on outstanding service, practical expertise and devotion to a certified value structure. Our passion is to grant our clients with best EMC / RF services by oriented knowledgeable and accommodating staff.

Our Test sites are located at Linkou District and Kwei Shan District. Location map can be found on our website <http://www.icertifi.com.tw>.

Linkou

Tel: 886-2-2601-1640

No.30-2, Ding Fwu Tsuen, Lin Kou
District, New Taipei City, Taiwan
(R.O.C.)

Kwei Shan

Tel: 886-3-271-8666

No.3-1, Lane 6, Wen San 3rd
St., Kwei Shan Dist., Tao Yuan
City 33381, Taiwan (R.O.C.)
No.2-1, Lane 6, Wen San 3rd
St., Kwei Shan Dist., Tao Yuan
City 33381, Taiwan (R.O.C.)

Kwei Shan Site II

Tel: 886-3-271-8640

No.14-1, Lane 19, Wen San 3rd
St., Kwei Shan Dist., Tao Yuan
City 33381, Taiwan (R.O.C.)

If you have any suggestion, please feel free to contact us as below information.

Tel: 886-3-271-8666

Fax: 886-3-318-0155

Email: ICC_Service@icertifi.com.tw

==END==



Unwanted Emissions (Below 1GHz)

Modulation	BT-LE (1Mbps)	Test Freq. (MHz)	2402
Polarization	Horizontal		

Test By :Paul Lin Temperature(°C):22 Humidity(%):64

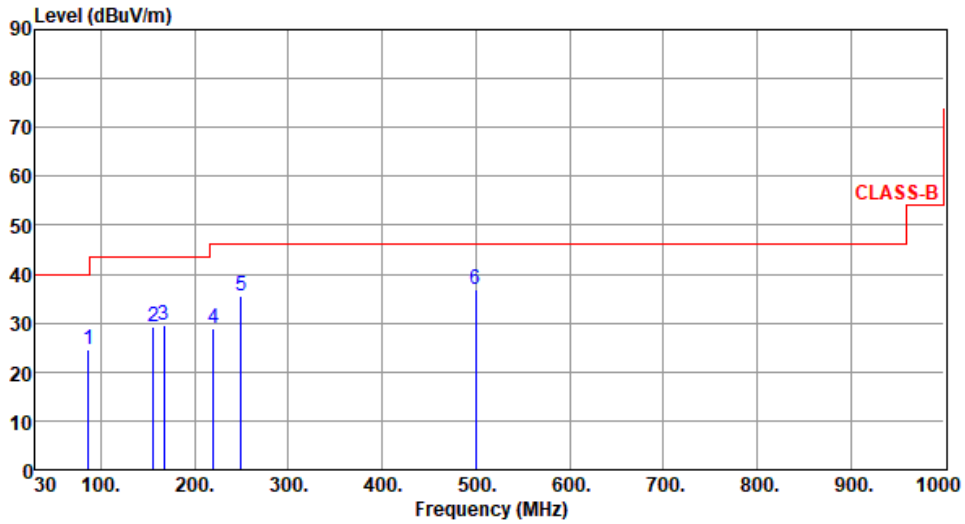

	Freq. MHz	Emission level dBuV/m	Limit dBuV/m	Margin dB	SA reading dBuV	Factor dB/m	Remark	ANT High cm	Turn Table deg
1	86.26	24.71	40.00	-15.29	39.33	-14.62	Peak	---	---
2	156.10	29.31	43.50	-14.19	37.96	-8.65	Peak	---	---
3	166.77	29.48	43.50	-14.02	38.57	-9.09	Peak	---	---
4	220.12	28.82	46.00	-17.18	40.67	-11.85	Peak	---	---
5	249.22	35.57	46.00	-10.43	45.54	-9.97	Peak	---	---
6	499.48	36.70	46.00	-9.30	39.78	-3.08	Peak	---	---

Note 1: Emission Level (dBuV/m) = SA Reading (dBuV) + Factor* (dB/m)

*Factor includes antenna factor , cable loss and amplifier gain

Note 2: Margin (dB) = Emission level (dBuV/m) – Limit (dBuV/m).

Note 3: All spurious emissions below 30MHz are more than 20 dB below the limit.



Modulation	BT-LE (1Mbps)	Test Freq. (MHz)	2402
Polarization	Vertical		

Test By :Paul Lin Temperature(°C):22 Humidity(%):64

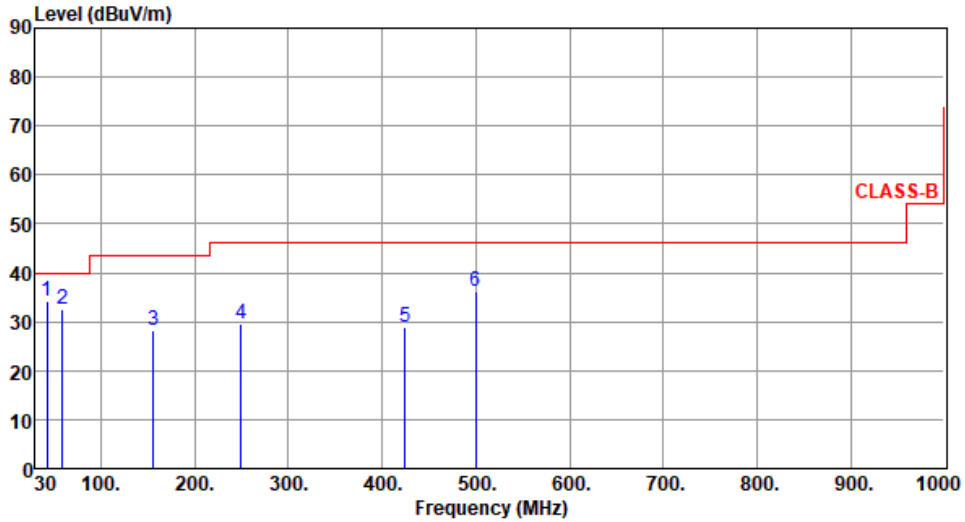

	Freq. MHz	Emission level dBuV/m	Limit dBuV/m	Margin dB	SA reading dBuV	Factor dB/m	Remark	ANT High cm	Turn Table deg
1	42.61	34.26	40.00	-5.74	42.65	-8.39	Peak	---	---
2	59.10	32.56	40.00	-7.44	41.28	-8.72	Peak	---	---
3	156.10	28.31	43.50	-15.19	36.96	-8.65	Peak	---	---
4	249.22	29.44	46.00	-16.56	39.41	-9.97	Peak	---	---
5	424.79	28.75	46.00	-17.25	33.44	-4.69	Peak	---	---
6	499.48	36.20	46.00	-9.80	39.28	-3.08	Peak	---	---

Note 1: Emission Level (dBuV/m) = SA Reading (dBuV) + Factor* (dB/m)

*Factor includes antenna factor , cable loss and amplifier gain

Note 2: Margin (dB) = Emission level (dBuV/m) – Limit (dBuV/m).

Note 3: All spurious emissions below 30MHz are more than 20 dB below the limit.



Unwanted Emissions (Above 1GHz)

Modulation	BT-LE (1Mbps)	Test Freq. (MHz)	2402
Polarization	Horizontal		

Test By :Paul Lin Temperature(°C):22 Humidity(%):64

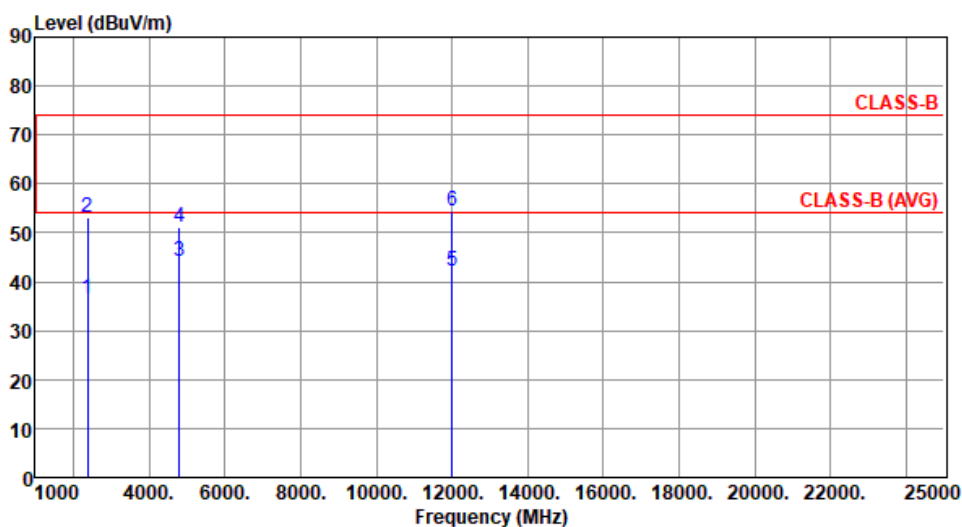

	Freq. MHz	Emission level dBuV/m	Limit dBuV/m	Margin dB	SA reading dBuV	Factor dB/m	Remark	ANT High cm	Turn Table deg
1	2390.00	36.67	54.00	-17.33	41.05	-4.38	Average	372	39
2	2390.00	53.13	74.00	-20.87	57.51	-4.38	Peak	372	39
3	4804.00	44.11	54.00	-9.89	44.49	-0.38	Average	100	323
4	4804.00	51.01	74.00	-22.99	51.39	-0.38	Peak	100	323
5	12010.00	42.01	54.00	-11.99	35.74	6.27	Average	100	98
6	12010.00	54.55	74.00	-19.45	48.28	6.27	Peak	100	98

Note 1: Emission Level (dBuV/m) = SA Reading (dBuV) + Factor* (dB/m)
 *Factor includes antenna factor , cable loss and amplifier gain
 Note 2: Margin (dB) = Emission level (dBuV/m) – Limit (dBuV/m).



Modulation	BT-LE (1Mbps)	Test Freq. (MHz)	2402
Polarization	Vertical		

Test By :Paul Lin Temperature(°C):22 Humidity(%):64

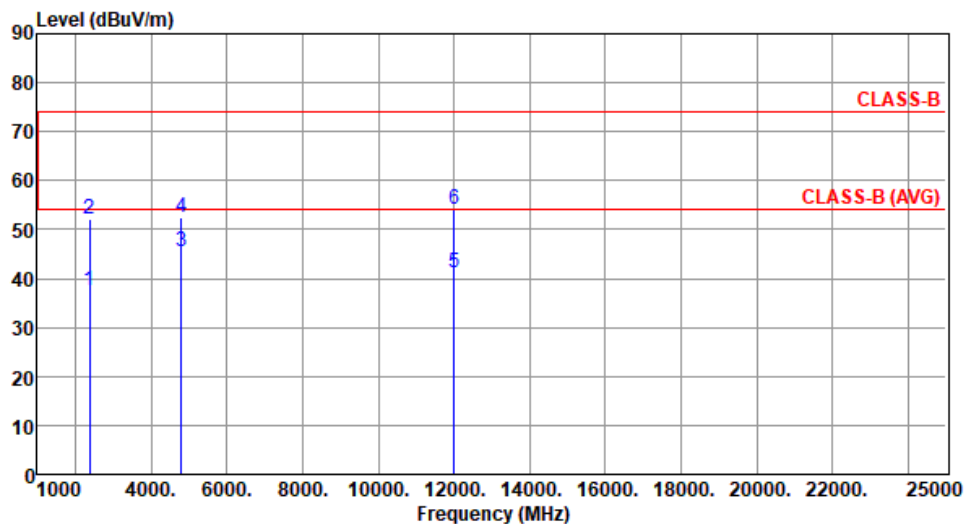

	Freq. MHz	Emission level dBuV/m	Limit dBuV/m	Margin dB	SA reading dBuV	Factor dB/m	Remark	ANT High cm	Turn Table deg
1	2390.00	37.46	54.00	-16.54	41.84	-4.38	Average	123	239
2	2390.00	52.15	74.00	-21.85	56.53	-4.38	Peak	123	239
3	4804.00	45.65	54.00	-8.35	46.03	-0.38	Average	106	143
4	4804.00	52.54	74.00	-21.46	52.92	-0.38	Peak	106	143
5	12010.00	41.10	54.00	-12.90	34.83	6.27	Average	100	58
6	12010.00	54.08	74.00	-19.92	47.81	6.27	Peak	100	58

Note 1: Emission Level (dBuV/m) = SA Reading (dBuV) + Factor* (dB/m)

*Factor includes antenna factor , cable loss and amplifier gain

Note 2: Margin (dB) = Emission level (dBuV/m) – Limit (dBuV/m).



Modulation	BT-LE(1Mbps)	Test Freq. (MHz)	2402
Power Phase	Line		

Test by : Joe Liao Temperature: 24°C Humidity: 63%

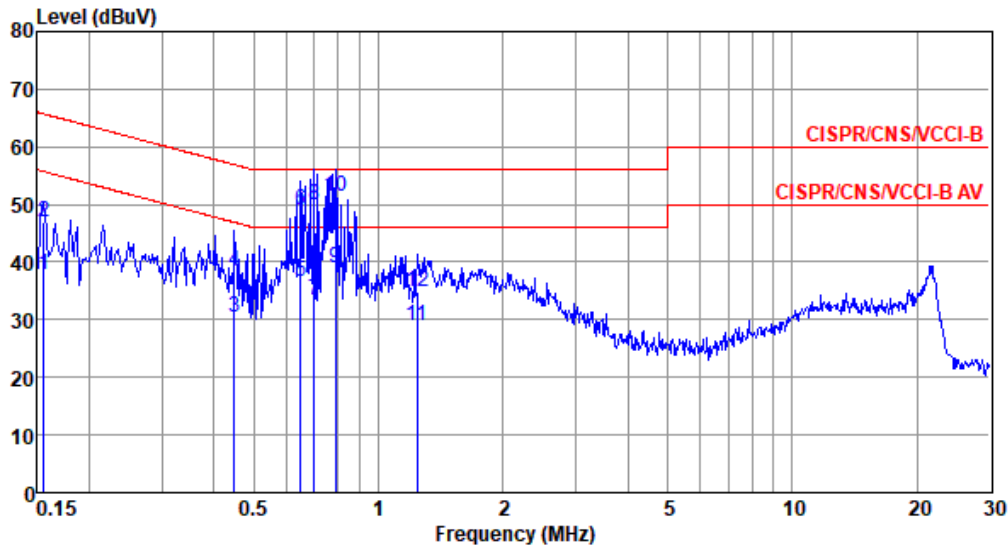

	Freq MHz	Level dBUV	Limit Line dBUV	Over Limit dB	Read Level dBUV	Factor dB	Cable loss dB	Aux dB	Remark
1	0.156	37.77	55.69	-17.92	27.90	9.63	0.06	0.18	Average
2	0.156	46.83	65.69	-18.86	36.96	9.63	0.06	0.18	QP
3	0.449	30.52	46.89	-16.37	20.53	9.62	0.07	0.30	Average
4	0.449	38.28	56.89	-18.61	28.29	9.62	0.07	0.30	QP
5	0.647	36.73	46.00	-9.27	26.69	9.63	0.09	0.32	Average
6	0.647	48.98	56.00	-7.02	38.94	9.63	0.09	0.32	QP
7	0.701	33.25	46.00	-12.75	23.21	9.63	0.09	0.32	Average
8	0.701	49.93	56.00	-6.07	39.89	9.63	0.09	0.32	QP
9	0.788	38.88	46.00	-7.12	28.83	9.63	0.10	0.32	Average
10*	0.788	51.38	56.00	-4.62	41.33	9.63	0.10	0.32	QP
11	1.242	29.06	46.00	-16.94	18.97	9.63	0.12	0.34	Average
12	1.242	34.74	56.00	-21.26	24.65	9.63	0.12	0.34	QP

Note 1: Level (dBUV) = Read Level (dBUV) + LISN Factor (dB) + Cable Loss (dB) + Aux (dB).
 Note 2: Over Limit (dB) = Level (dBUV) - Limit Line (dBUV).



Modulation	BT-LE(1Mbps)	Test Freq. (MHz)	2402
------------	--------------	------------------	------

Power Phase	Neutral
-------------	---------

Test by : Joe Liao Temperature: 24°C Humidity: 63%

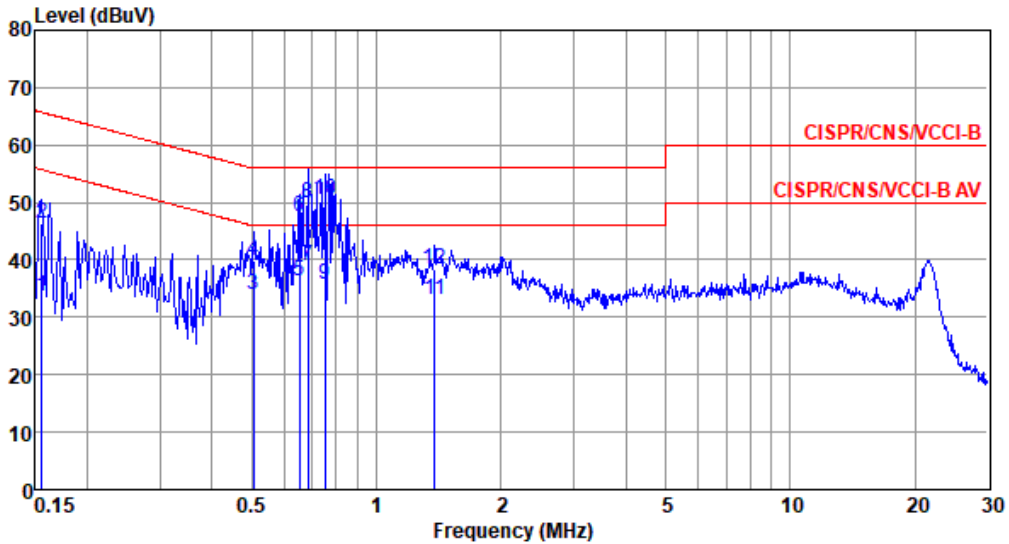

	Freq MHz	Level dBuV	Limit Line dBuV	Over Limit dB	Read Level dBuV	Factor dB	Cable loss dB	Aux dB	Remark
1	0.156	33.71	55.69	-21.98	23.84	9.63	0.06	0.18	Average
2	0.156	46.46	65.69	-19.23	36.59	9.63	0.06	0.18	QP
3	0.505	33.95	46.00	-12.05	23.95	9.62	0.07	0.31	Average
4	0.505	39.73	56.00	-16.27	29.73	9.62	0.07	0.31	QP
5	0.651	36.40	46.00	-9.60	26.36	9.63	0.09	0.32	Average
6	0.651	47.48	56.00	-8.52	37.44	9.63	0.09	0.32	QP
7	0.683	39.03	46.00	-6.97	28.99	9.63	0.09	0.32	Average
8	0.683	50.04	56.00	-5.96	40.00	9.63	0.09	0.32	QP
9	0.751	35.59	46.00	-10.41	25.55	9.63	0.09	0.32	Average
10*	0.751	50.39	56.00	-5.61	40.35	9.63	0.09	0.32	QP
11	1.381	33.06	46.00	-12.94	22.97	9.63	0.12	0.34	Average
12	1.381	38.27	56.00	-17.73	28.18	9.63	0.12	0.34	QP

Note 1: Level (dBuV) = Read Level (dBuV) + LISN Factor (dB) + Cable Loss (dB) + Aux (dB).
 2: Over Limit (dB) = Level (dBuV) – Limit Line (dBuV).