



# FCC TEST REPORT

**REPORT NO.:** RF930702L02A

**MODEL NO.:** WPIB-108GM (refer to page 6 for other models )

**RECEIVED:** NA

**TESTED:** June 18, 2004 ~ July 08, 2004

**PREPARED BY:** Gemtek Technology Co., Ltd.

**ADDRESS:** No.1, Jen Ai Road, Hsinchu Industrial Park,  
Hukou Hsinchu, Taiwan, R.O.C. 303

**ISSUED BY:** Advance Data Technology Corporation

**LAB LOCATION:** No. 19, Hwa Ya 2nd rd., Kueishan, Taoyuan,  
Taiwan, R.O.C.

This test report consists of 68 pages in total. It may be duplicated completely for legal use with the approval of the applicant. It should not be reproduced except in full, without the written approval of our laboratory. The client should not use it to claim product endorsement by CNLA or any government agencies. The test results in the report only apply to the tested sample.



0528  
ILAC MRA



## Table of Contents

1	CERTIFICATION .....	4
2	SUMMARY OF TEST RESULTS .....	5
3	GENERAL INFORMATION.....	6
3.1	GENERAL DESCRIPTION OF EUT .....	6
3.2	DESCRIPTION OF TEST MODES.....	7
3.3	GENERAL DESCRIPTION OF APPLIED STANDARDS.....	7
3.4	DESCRIPTION OF SUPPORT UNITS.....	8
3.5	CONFIGURATION OF SYSTEM UNDER .....	9
4	TEST TYPES AND RESULTS .....	10
4.1	CONDUCTED EMISSION MEASUREMENT.....	10
4.1.1	LIMITS OF CONDUCTED EMISSION MEASUREMENT.....	10
4.1.2	TEST INSTRUMENTS .....	10
4.1.3	TEST PROCEDURES .....	11
4.1.4	DEVIATION FROM TEST STANDARD .....	11
4.1.5	TEST SETUP .....	12
4.1.6	EUT OPERATING CONDITIONS .....	12
4.1.7	TEST RESULTS.....	13
4.2	RADIATED EMISSION MEASUREMENT.....	19
4.2.1	LIMITS OF RADIATED EMISSION MEASUREMENT.....	19
4.2.2	TEST INSTRUMENTS .....	20
4.2.3	TEST PROCEDURES .....	21
4.2.4	DEVIATION FROM TEST STANDARD .....	21
4.2.5	TEST SETUP .....	22
4.2.6	EUT OPERATING CONDITIONS .....	22
4.2.7	TEST RESULTS.....	23
4.2.8	TEST RESULTS (A).....	25
4.2.9	TEST RESULTS (B).....	28
4.3	6dB BANDWIDTH MEASUREMENT .....	31
4.3.1	LIMITS OF 6dB BANDWIDTH MEASUREMENT.....	31
4.3.2	TEST INSTRUMENTS .....	31
4.3.3	TEST PROCEDURE .....	32
4.3.4	DEVIATION FROM TEST STANDARD .....	32
4.3.5	TEST SETUP .....	32
4.3.6	EUT OPERATING CONDITIONS .....	32
4.3.7	TEST RESULTS (A).....	33



4.3.8	TEST RESULTS (B).....	37
4.4	MAXIMUM PEAK OUTPUT POWER.....	41
4.4.1	LIMITS OF MAXIMUM PEAK OUTPUT POWER MEASUREMENT .....	41
4.4.2	TEST INSTRUMENTS .....	41
4.4.3	TEST PROCEDURES .....	42
4.4.4	DEVIATION FROM TEST STANDARD .....	42
4.4.5	TEST SETUP .....	42
4.4.6	EUT OPERATING CONDITIONS .....	42
4.4.7	TEST RESULTS (A).....	43
4.4.8	TEST RESULTS (B).....	43
4.5	POWER SPECTRAL DENSITY MEASUREMENT.....	44
4.5.1	LIMITS OF POWER SPECTRAL DENSITY MEASUREMENT.....	44
4.5.2	TEST INSTRUMENTS .....	44
4.5.3	TEST PROCEDURE .....	45
4.5.4	DEVIATION FROM TEST STANDARD .....	45
4.5.5	TEST SETUP .....	45
4.5.6	EUT OPERATING CONDITIONS .....	45
4.5.7	TEST RESULTS (A).....	46
4.5.8	TEST RESULTS (B).....	50
4.6	BAND EDGES MEASUREMENT.....	54
4.6.1	LIMITS OF BAND EDGES MEASUREMENT.....	54
4.6.2	TEST INSTRUMENTS .....	54
4.6.3	TEST PROCEDURE .....	54
4.6.4	DEVIATION FROM TEST STANDARD .....	54
4.6.5	EUT OPERATING CONDITION.....	55
4.6.6	TEST RESULTS (A).....	55
4.6.7	TEST RESULTS (B).....	60
4.7	ANTENNA REQUIREMENT .....	65
4.7.1	STANDARD APPLICABLE.....	65
4.7.2	ANTENNA CONNECTED CONSTRUCTION .....	65
5	PHOTOGRAPHS OF THE TEST CONFIGURATION .....	66
6	INFORMATION ON THE TESTING LABORATORIES .....	68



## 1 CERTIFICATION

**PRODUCT :** Wireless 802.11g PCI Adapter  
**MODEL NO.:** WPIB-108GM (refer to page 6 for other models )  
**BRAND:** Gemtek (refer to page 6 for other models )  
**PREPARED BY:** Gemtek Technology Co., Ltd.  
**TESTED:** June 18, 2004 ~ July 08, 2004  
**TEST ITEM:** ENGINEERING SAMPLE  
**STANDARDS :** FCC Part 15, Subpart C (Section 15.247),  
ANSI C63.4-2001

The above equipment has been tested by **Advance Data Technology Corporation**, and found compliance with the requirement of the above standards. The test record, data evaluation & Equipment Under Test (EUT) configurations represented herein are true and accurate accounts of the measurements of the sample's EMC characteristics under the conditions specified in this report.

**PREPARED BY:** \_\_\_\_\_ , **DATE:** July 26, 2004  
Windy Chou

**APPROVED BY:** \_\_\_\_\_ , **DATE:** July 26, 2004  
Ken Lu / Manager

## 2 SUMMARY OF TEST RESULTS

The EUT has been tested according to the following specifications:

APPLIED STANDARD: FCC Part 15, Subpart C			
Standard Section	Test Type and Limit	Result	REMARK
15.207	AC Power Conducted Emission	PASS	Meet the requirement of limit. Minimum passing margin is -15.06dB at 0.638MHz.
15.247(a)(2)	Spectrum Bandwidth of a Direct Sequence Spread Spectrum System Limit: min. 500kHz	PASS	Meet the requirement of limit.
15.247(b)	Maximum Peak Output Power Limit: max. 30dBm	PASS	Meet the requirement of limit.
15.247(c)	Transmitter Radiated Emissions Limit: Table 15.209	PASS	Meet the requirement of limit. Minimum passing margin is -2.63dB at 9648.00MHz.
15.247(d)	Power Spectral Density Limit: max. 8dBm	PASS	Meet the requirement of limit.
15.247(c)	Band Edge Measurement Limit: 20 dB less than the peak value of fundamental frequency	PASS	Meet the requirement of limit.

**NOTE:** The information of measurement uncertainty is available upon the customer' s request.



### 3 GENERAL INFORMATION

#### 3.1 GENERAL DESCRIPTION OF EUT

<b>PRODUCT</b>	Wireless 802.11g PCI Adapter
<b>MODEL NO.</b>	WPIB-108GM
<b>POWER SUPPLY</b>	3.3Vdc and 5.5Vdc from host equipment
<b>MODULATION TYPE</b>	BPSK, QPSK, CCK, 16QAM, 64QAM
<b>MODULATION TECHNOLOGY</b>	DSSS, OFDM
<b>TRANSFER RATE</b>	802.11b: 11/5.5/2/1Mbps 802.11g: 54/48/36/24/18/12/9/6Mbps
<b>FREQUENCY RANGE</b>	2412MHz ~ 2462MHz
<b>NUMBER OF CHANNEL</b>	11
<b>MAXIMUM OUTPUT POWER</b>	20.00dBm
<b>ANTENNA TYPE</b>	Dipole antenna with 3.8dBi gain
<b>DATA CABLE</b>	NA
<b>I/O PORTS</b>	PCMCIA
<b>ASSOCIATED DEVICES</b>	NA

**NOTE:**

1. This report is issued as a duplicate report of ADT report no.: RF930702L02. The difference are the product name, model no., brand name and applicant.
2. The models as below are identical to each other except their model and brand name due to marketing requirement.

Brand	Model
Gemtek	WPIB-108GM
ViewSonic	WPCI-100 AND VS10408

3. The EUT operates in the 2.4GHz frequency spectrum with throughput of up to 54Mbps.
4. The EUT complies with IEEE 802.11g draft standards and backwards compatible with IEEE 802.11b products.
5. The above EUT information was declared by manufacturer and for more detailed features description, please refer to the manufacturer's specifications or User's Manual.



### 3.2 DESCRIPTION OF TEST MODES

Eleven channels are provided to this EUT.

Channel	Frequency	Channel	Frequency
1	2412 MHz	7	2442 MHz
2	2417 MHz	8	2447 MHz
3	2422 MHz	9	2452 MHz
4	2427 MHz	10	2457 MHz
5	2432 MHz	11	2462 MHz
6	2437 MHz		

**NOTE:**

1. Below 1GHz, the channel 1, 6, and 11 were pre-tested in chamber. The channel 11, the worst case, was chosen for final test.
2. Above 1GHz, the channel 1, 6, and 11 were tested individually.
3. From our experience and technical viewpoint, we have chosen data rates 11Mbps for CCK technique and 6Mbps for OFDM technique, as the worst cases for the test among other data rates.
4. There are two test results presented in the following sections: The test result A is for CCK technique and the test result B is for OFDM technique.

### 3.3 GENERAL DESCRIPTION OF APPLIED STANDARDS

The EUT is a Wireless PCI Adapter. According to the specifications of the manufacturer, it must comply with the requirements of the following standards:

**FCC Part 15, Subpart C. (15.247)**  
**ANSI C63.4-2001**

All test items have been performed and recorded as per the above standards.

**NOTE:** The EUT is also considered as a kind of computer peripheral, because the connection to computer is necessary for typical use. It has been verified to comply with the requirements of FCC Part 15, Subpart B, Class B (DoC). The test report has been issued separately.



### 3.4 DESCRIPTION OF SUPPORT UNITS

The EUT has been tested as an independent unit together with other necessary accessories or support units. The following support units or accessories were used to form a representative test configuration during the tests.

NO.	PRODUCT	BRAND	MODEL NO.	SERIAL NO.	FCC ID
1	PC	MSI	Hetis 865G Giga	3AS0119585	FCC DoC Approved
2	LCD MONITOR	ACER	AL1721	ET.L0408.0104040 01E6PK00	FCC DoC Approved
3	KEYBOARD	HP	SK-1688	C0306114659	GYUR84SK
4	MOUSE	HP	M-S69	N/A	INZ211443
5	PRINTER	EPSON	LQ-300+	DCGY054146	FCC DoC Approved
6	MODEM	ACEEX	1414V/3	0401008260	IFAXDM1414

NO.	SIGNAL CABLE DESCRIPTION OF THE ABOVE SUPPORT UNITS
1	NA
2	NA
3	1.3m shielded cable without core.
4	1.8m shielded cable without core.
5	1.2m shielded cable without core.
6	1.2m shielded cable without core.

**NOTE:** All power cords of the above support units are non shielded (1.8m).



### 3.5 CONFIGURATION OF SYSTEM UNDER TEST

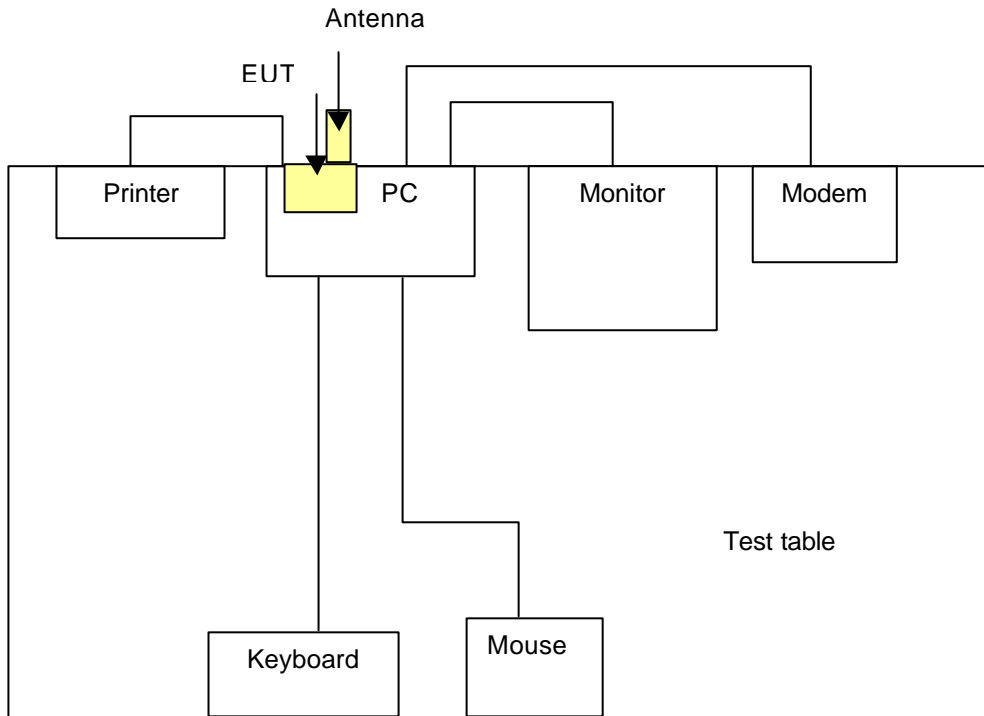



## 4 TEST TYPES AND RESULTS

### 4.1 CONDUCTED EMISSION MEASUREMENT

#### 4.1.1 LIMITS OF CONDUCTED EMISSION MEASUREMENT

FREQUENCY OF EMISSION (MHz)	CONDUCTED LIMIT (dB $\mu$ V)	
	Quasi-peak	Average
0.15-0.5	66 to 56	56 to 46
0.5-5	56	46
5-30	60	50

- NOTE:**
1. The lower limit shall apply at the transition frequencies.
  2. The limit decreases in line with the logarithm of the frequency in the range of 0.15 to 0.50 MHz.
  3. All emanations from a class A/B digital device or system, including any network of conductors and apparatus connected thereto, shall not exceed the level of field strengths specified above.

#### 4.1.2 TEST INSTRUMENTS

DESCRIPTION & MANUFACTURER	MODEL NO.	SERIAL NO.	CALIBRATED UNTIL
Test Receiver ROHDE & SCHWARZ	ESCS30	100291	Dec. 12, 2004
RF signal cable Woken	5D-FB	Cable-HYC01-01	Mar. 02, 2005
LISN ROHDE & SCHWARZ	ESH3-Z5	847265/023	Oct. 22, 2004
LISN ROHDE & SCHWARZ	ESH3-Z5	100220	Dec. 10, 2004
Software ADT	ADT_Cond_V3	NA	NA

- NOTE:**
1. The calibration interval of the above test instruments is 12 months and the calibrations are traceable to NML/ROC and NIST/USA.
  2. The test was performed in HwaYa Shielded Room 1.
  3. The VCCI Site Registration No. is C-2040.Hwa Ya Global Certification Office



#### 4.1.3 TEST PROCEDURES

- a. The EUT was placed 0.4 meters from the conducting wall of the shielded room with EUT being connected to the power mains through a line impedance stabilization network (LISN). Other support units were connected to the power mains through another LISN. The two LISNs provide 50 ohm/ 50uH of coupling impedance for the measuring instrument.
- b. Both lines of the power mains connected to the EUT were checked for maximum conducted interference.
- c. The frequency range from 150kHz to 30MHz was searched. Emission levels under Limit - 20dB was not recorded.

#### 4.1.4 DEVIATION FROM TEST STANDARD

No deviation

#### 4.1.5 TEST SETUP

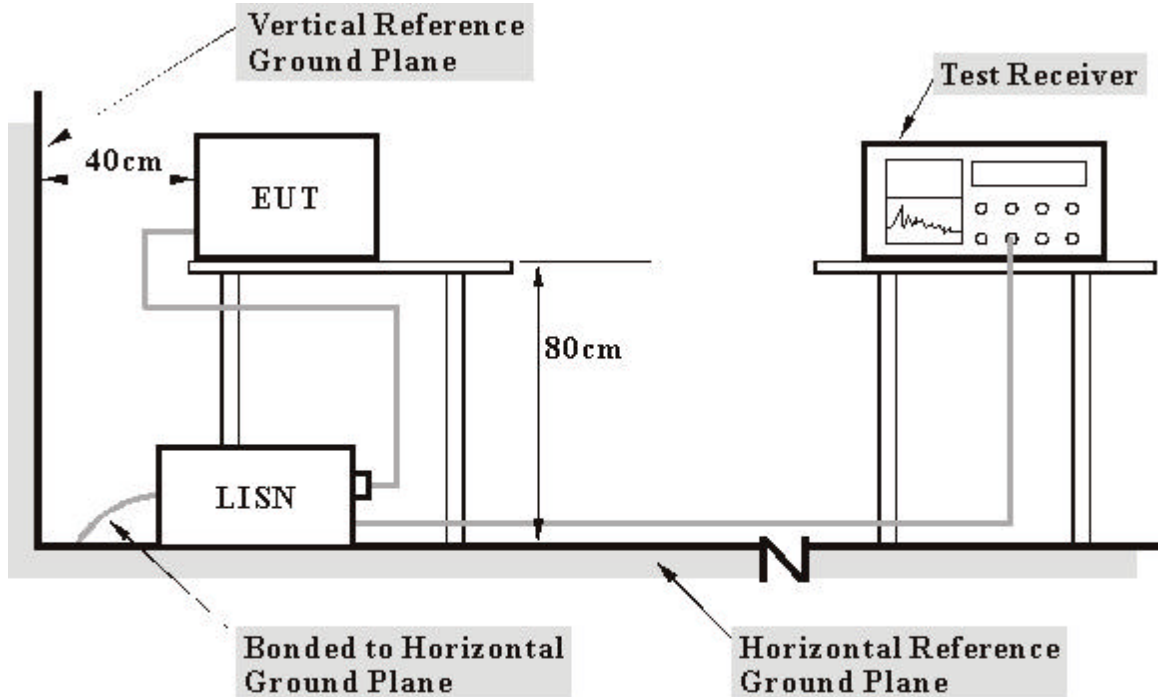

- Note:**
1. Support units were connected to second LISN.
  2. Both of LISNs (AMN) 80 cm from EUT and at the least 80 cm from other units and other metal planes support units.

For the actual test configuration, please refer to the related item – Photographs of the Test Configuration.

#### 4.1.6 EUT OPERATING CONDITIONS

- a. Plug the EUT a computer system placed on a testing table.
- b. The computer system ran a test program (provided by manufacturer) to enable EUT under transmission/receiving condition continuously at specific channel frequency.
- c. The computer system show "H" messages on its screen.
- d. The computer system sent "H" messages to modem.
- e. The computer system sent "H" messages to printer, and the printer prints them on paper.
- f. Repeated c ~e.



4.1.7 TEST RESULTS

<b>EUT</b>	Wireless 802.11g PCI Adapter	<b>MODEL</b>	WPIB-108GM
<b>MODE</b>	Channel 1	<b>6dB BANDWIDTH</b>	9kHz
<b>INPUT POWER (SYSTEM)</b>	120Vac, 60 Hz	<b>PHASE</b>	Line (L)
<b>ENVIRONMENTAL CONDITIONS</b>	23deg. C, 70%RH, 991hPa	<b>TESTED BY:</b> Steven Lu	

No	Freq. [MHz]	Corr. Factor (dB)	Reading Value		Emission Level		Limit		Margin	
			[dB (uV)]		[dB (uV)]		[dB (uV)]		(dB)	
			Q.P.	AV.	Q.P.	AV.	Q.P.	AV.	Q.P.	AV.
1	0.189	0.12	43.99	-	44.11	-	64.08	54.08	-19.97	-
2	0.253	0.12	39.37	-	39.49	-	61.67	51.67	-22.17	-
3	0.447	0.13	34.57	-	34.70	-	56.93	46.93	-22.24	-
4	1.020	0.15	34.65	-	34.80	-	56.00	46.00	-21.20	-
5	19.816	1.01	40.43	-	41.44	-	60.00	50.00	-18.56	-
6	22.820	1.10	40.70	-	41.80	-	60.00	50.00	-18.20	-

- REMARKS:**
1. Q.P. and AV. are abbreviations of quasi-peak and average individually.
  2. "-": The Quasi-peak reading value also meets average limit and measurement with the average detector is unnecessary.
  3. The emission levels of other frequencies were very low against the limit.
  4. Margin value = Emission level - Limit value
  5. Correction factor = Insertion loss + Cable loss
  6. Emission Level = Correction Factor + Reading Value.

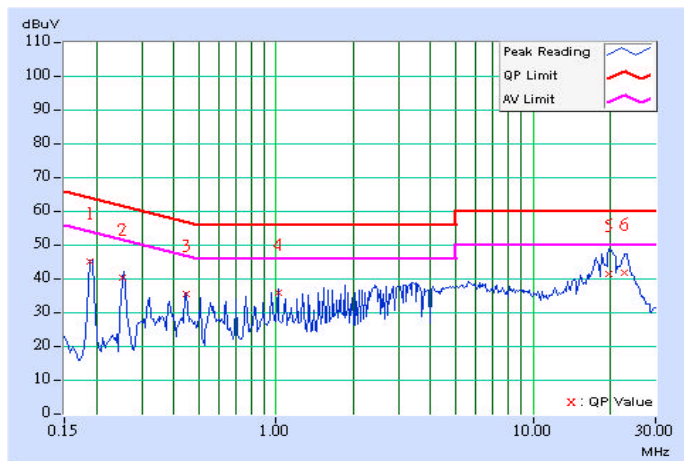



<b>EUT</b>	Wireless 802.11g PCI Adapter	<b>MODEL</b>	WPIB-108GM
<b>MODE</b>	Channel 1	<b>6dB BANDWIDTH</b>	9kHz
<b>INPUT POWER (SYSTEM)</b>	120Vac, 60 Hz	<b>PHASE</b>	Neutral (N)
<b>ENVIRONMENTAL CONDITIONS</b>	23deg. C, 70%RH, 991hPa	<b>TESTED BY:</b> Steven Lu	

No	Freq. [MHz]	Corr. Factor (dB)	Reading Value		Emission Level		Limit		Margin	
			[dB (uV)]		[dB (uV)]		[dB (uV)]		(dB)	
			Q.P.	AV.	Q.P.	AV.	Q.P.	AV.	Q.P.	AV.
1	0.189	0.11	42.90	-	43.01	-	64.08	54.08	-21.07	-
2	0.380	0.12	41.21	-	41.33	-	58.27	48.27	-16.94	-
3	0.634	0.12	40.29	-	40.41	-	56.00	46.00	-15.59	-
4	0.956	0.15	38.83	-	38.98	-	56.00	46.00	-17.02	-
5	3.246	0.18	36.23	-	36.41	-	56.00	46.00	-19.59	-
6	19.220	0.70	40.12	-	40.82	-	60.00	50.00	-19.18	-

- REMARKS:**
1. Q.P. and AV. are abbreviations of quasi-peak and average individually.
  2. "-": The Quasi-peak reading value also meets average limit and measurement with the average detector is unnecessary.
  3. The emission levels of other frequencies were very low against the limit.
  4. Margin value = Emission level - Limit value
  5. Correction factor = Insertion loss + Cable loss
  6. Emission Level = Correction Factor + Reading Value.

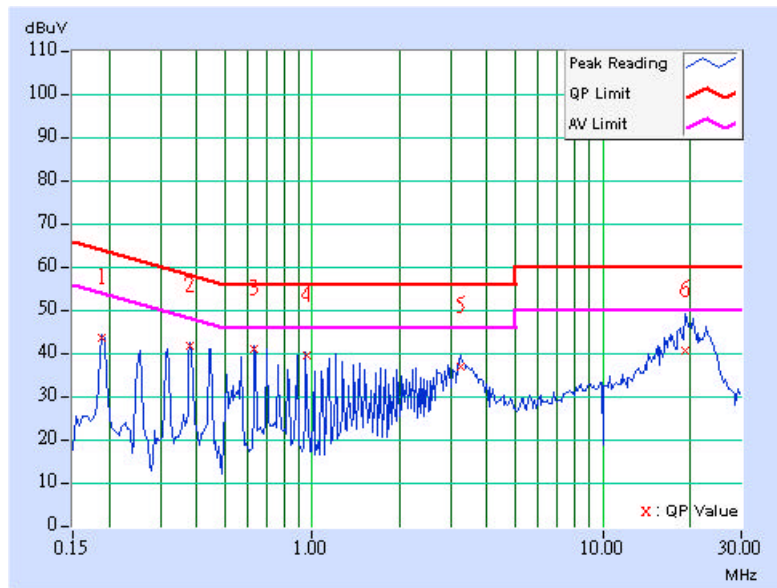



<b>EUT</b>	Wireless 802.11g PCI Adapter	<b>MODEL</b>	WPIB-108GM
<b>MODE</b>	Channel 6	<b>6dB BANDWIDTH</b>	9kHz
<b>INPUT POWER (SYSTEM)</b>	120Vac, 60 Hz	<b>PHASE</b>	Line (L)
<b>ENVIRONMENTAL CONDITIONS</b>	23deg. C, 70%RH, 991hPa	<b>TESTED BY:</b> Steven Lu	

No	Freq. [MHz]	Corr. Factor (dB)	Reading Value		Emission Level		Limit		Margin	
			[dB (uV)]		[dB (uV)]		[dB (uV)]		(dB)	
			Q.P.	AV.	Q.P.	AV.	Q.P.	AV.	Q.P.	AV.
1	0.193	0.12	44.37	-	44.49	-	63.91	53.91	-19.43	-
2	0.255	0.12	40.35	-	40.47	-	61.58	51.58	-21.11	-
3	0.447	0.13	34.65	-	34.78	-	56.93	46.93	-22.16	-
4	3.316	0.19	35.55	-	35.74	-	56.00	46.00	-20.26	-
5	20.480	1.03	39.48	-	40.51	-	60.00	50.00	-19.49	-
6	23.223	1.11	40.86	-	41.97	-	60.00	50.00	-18.03	-

- REMARKS:**
1. Q.P. and AV. are abbreviations of quasi-peak and average individually.
  2. "-": The Quasi-peak reading value also meets average limit and measurement with the average detector is unnecessary.
  3. The emission levels of other frequencies were very low against the limit.
  4. Margin value = Emission level - Limit value
  5. Correction factor = Insertion loss + Cable loss
  6. Emission Level = Correction Factor + Reading Value.

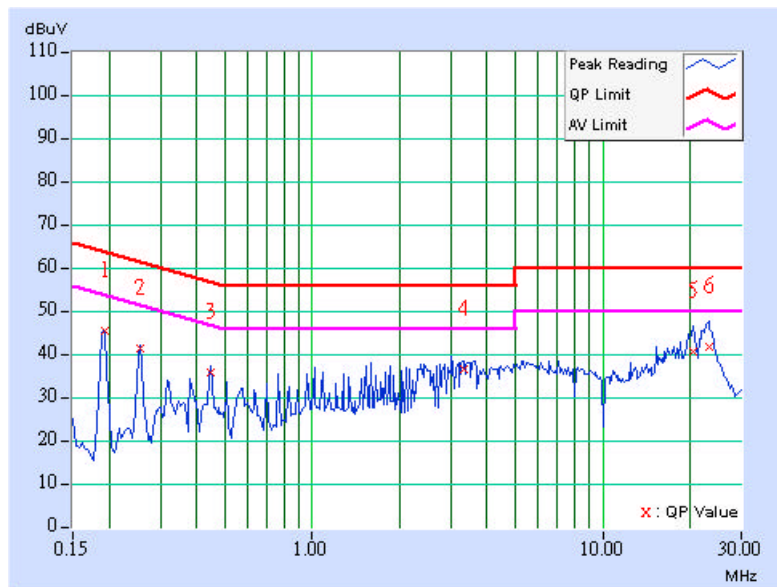



<b>EUT</b>	Wireless 802.11g PCI Adapter	<b>MODEL</b>	WPIB-108GM
<b>MODE</b>	Channel 6	<b>6dB BANDWIDTH</b>	9kHz
<b>INPUT POWER (SYSTEM)</b>	120Vac, 60 Hz	<b>PHASE</b>	Neutral (N)
<b>ENVIRONMENTAL CONDITIONS</b>	23deg. C, 70%RH, 991hPa	<b>TESTED BY:</b> Steven Lu	

No	Freq. [MHz]	Corr. Factor (dB)	Reading Value		Emission Level		Limit		Margin	
			[dB (uV)]		[dB (uV)]		[dB (uV)]		(dB)	
			Q.P.	AV.	Q.P.	AV.	Q.P.	AV.	Q.P.	AV.
1	0.192	0.11	43.33	-	43.44	-	63.96	53.96	-20.52	-
2	0.384	0.12	40.91	-	41.03	-	58.18	48.18	-17.16	-
3	0.638	0.12	40.55	-	40.67	-	56.00	46.00	-15.33	-
4	3.191	0.18	34.83	-	35.01	-	56.00	46.00	-20.99	-
5	19.733	0.71	41.00	-	41.71	-	60.00	50.00	-18.29	-
6	22.993	0.69	40.71	-	41.40	-	60.00	50.00	-18.60	-

- REMARKS:**
1. Q.P. and AV. are abbreviations of quasi-peak and average individually.
  2. "-": The Quasi-peak reading value also meets average limit and measurement with the average detector is unnecessary.
  3. The emission levels of other frequencies were very low against the limit.
  4. Margin value = Emission level - Limit value
  5. Correction factor = Insertion loss + Cable loss
  6. Emission Level = Correction Factor + Reading Value.

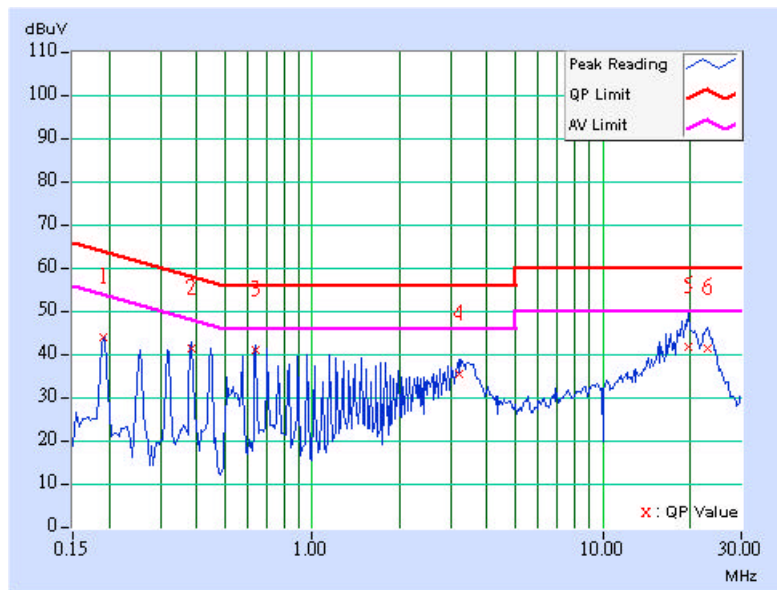





<b>EUT</b>	Wireless 802.11g PCI Adapter	<b>MODEL</b>	WPIB-108GM
<b>MODE</b>	Channel 11	<b>6dB BANDWIDTH</b>	9kHz
<b>INPUT POWER (SYSTEM)</b>	120Vac, 60 Hz	<b>PHASE</b>	Line (L)
<b>ENVIRONMENTAL CONDITIONS</b>	23deg. C, 70%RH, 991hPa	<b>TESTED BY:</b> Steven Lu	

No	Freq. [MHz]	Corr. Factor (dB)	Reading Value		Emission Level		Limit		Margin	
			[dB (uV)]		[dB (uV)]		[dB (uV)]		(dB)	
			Q.P.	AV.	Q.P.	AV.	Q.P.	AV.	Q.P.	AV.
1	0.190	0.12	44.31	-	44.43	-	64.02	54.02	-19.60	-
2	0.255	0.12	40.35	-	40.47	-	61.58	51.58	-21.11	-
3	0.447	0.13	34.79	-	34.92	-	56.93	46.93	-22.02	-
4	1.598	0.16	35.81	-	35.97	-	56.00	46.00	-20.03	-
5	3.516	0.20	35.91	-	36.11	-	56.00	46.00	-19.89	-
6	20.638	1.04	37.33	-	38.37	-	60.00	50.00	-21.63	-

- REMARKS:**
1. Q.P. and AV. are abbreviations of quasi-peak and average individually.
  2. "-": The Quasi-peak reading value also meets average limit and measurement with the average detector is unnecessary.
  3. The emission levels of other frequencies were very low against the limit.
  4. Margin value = Emission level - Limit value
  5. Correction factor = Insertion loss + Cable loss
  6. Emission Level = Correction Factor + Reading Value.

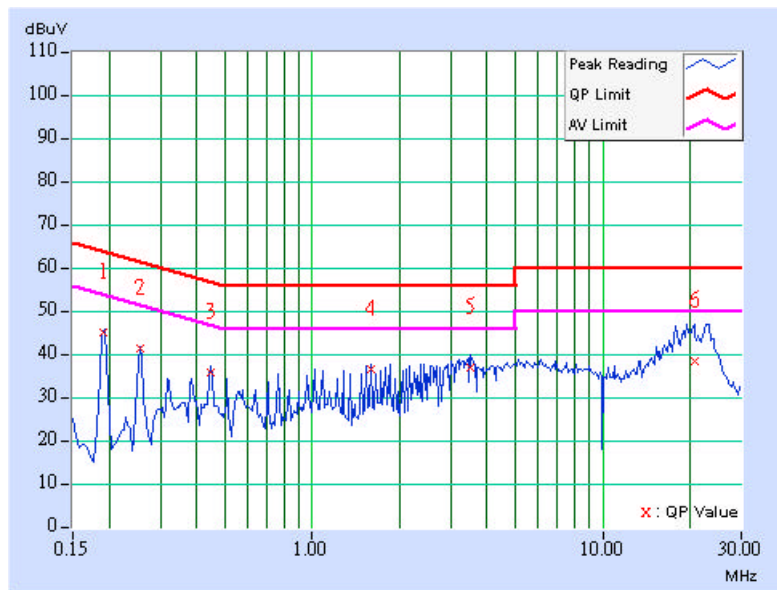



<b>EUT</b>	Wireless 802.11g PCI Adapter	<b>MODEL</b>	WPIB-108GM
<b>MODE</b>	Channel 11	<b>6dB BANDWIDTH</b>	9kHz
<b>INPUT POWER (SYSTEM)</b>	120Vac, 60 Hz	<b>PHASE</b>	Neutral (N)
<b>ENVIRONMENTAL CONDITIONS</b>	23deg. C, 70%RH, 991hPa	<b>TESTED BY:</b> Steven Lu	

No	Freq. [MHz]	Corr. Factor (dB)	Reading Value		Emission Level		Limit		Margin	
			[dB (uV)]		[dB (uV)]		[dB (uV)]		(dB)	
			Q.P.	AV.	Q.P.	AV.	Q.P.	AV.	Q.P.	AV.
1	0.193	0.11	43.16	-	43.27	-	63.91	53.91	-20.64	-
2	0.447	0.12	40.25	-	40.37	-	56.93	46.93	-16.57	-
<b>3</b>	<b>0.638</b>	<b>0.12</b>	<b>40.82</b>	-	<b>40.94</b>	-	<b>56.00</b>	<b>46.00</b>	<b>-15.06</b>	-
4	3.258	0.19	36.11	-	36.30	-	56.00	46.00	-19.70	-
5	20.254	0.71	40.84	-	41.55	-	60.00	50.00	-18.45	-
6	22.940	0.69	40.97	-	41.66	-	60.00	50.00	-18.34	-

- REMARKS:**
1. Q.P. and AV. are abbreviations of quasi-peak and average individually.
  2. "-": The Quasi-peak reading value also meets average limit and measurement with the average detector is unnecessary.
  3. The emission levels of other frequencies were very low against the limit.
  4. Margin value = Emission level - Limit value
  5. Correction factor = Insertion loss + Cable loss
  6. Emission Level = Correction Factor + Reading Value.

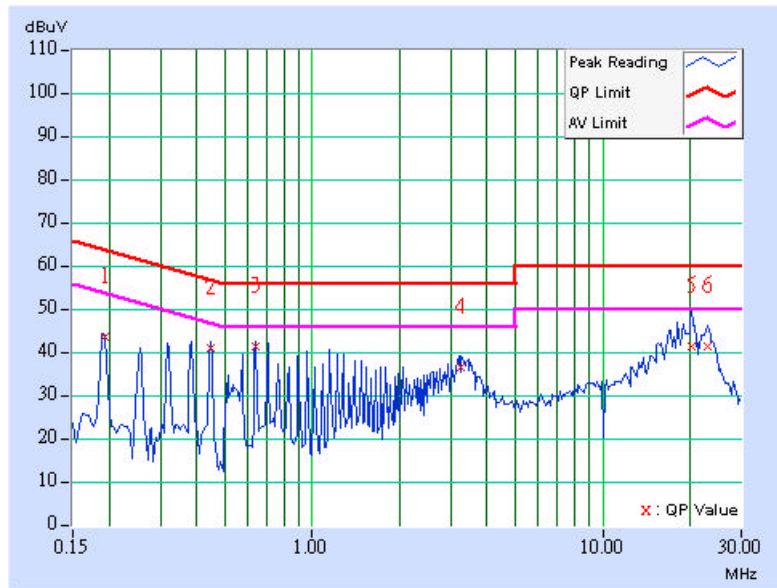



## 4.2 RADIATED EMISSION MEASUREMENT

### 4.2.1 LIMITS OF RADIATED EMISSION MEASUREMENT

Emissions radiated outside of the specified bands, shall be according to the general radiated limits in 15.209 as following:

Frequencies (MHz)	Field strength (microvolts/meter)	Measurement distance (meters)
0.009-0.490	2400/F(kHz)	300
0.490-1.705	24000/F(kHz)	30
1.705-30.0	30	30
30-88	100	3
88-216	150	3
216-960	200	3
Above 960	500	3

#### NOTE:

1. The lower limit shall apply at the transition frequencies.
2. Emission level (dBuV/m) = 20 log Emission level (uV/m).
3. As shown in 15.35(b), for frequencies above 1000MHz, the field strength limits are based on average detector, however, the peak field strength of any emission shall not exceed the maximum permitted average limits, specified above by more than 20dB under any condition of modulation.



## 4.2.2 TEST INSTRUMENTS

DESCRIPTION & MANUFACTURER	MODEL NO.	SERIAL NO.	CALIBRATED UNTIL
Test Receiver ROHDE & SCHWARZ	ESIB7	100188	Jan. 13, 2005
Spectrum Analyzer ROHDE & SCHWARZ	FSP40	100039	Dec. 15, 2004
BILOG Antenna SCHWARZBECK	VULB9168	9168-157	Feb. 03, 2005
HORN Antenna SCHWARZBECK	BBHA 9120 D	9120D-407	Feb. 03, 2005
HORN Antenna SCHWARZBECK	BBHA 9170	BBHA 9170241	Feb. 23, 2005
Preamplifier Agilent	8449B	3008A01961	Jan. 22, 2005
Preamplifier Agilent	8447D	2944A10629	Jan. 14, 2005
RF signal cable HUBER+SUHNER	SUCOFLEX 104	218182/4	Mar. 04, 2005
RF signal cable HUBER+SUHNER	SUCOFLEX 104	218194/4	Mar. 04, 2005
Software ADT.	ADT_Radiated_V5.14	NA	NA
Antenna Tower ADT.	AT100	AT93021702	NA
Turn Table ADT.	TT100.	TT93021702	NA
Controller ADT.	SC100.	SC93021702	NA

- NOTE:**
1. The calibration interval of the above test instruments is 12 months and the calibrations are traceable to NML/ROC and NIST/USA.
  2. The test was performed in HwaYa Chamber 1.
  3. The horn antenna and HP preamplifier (model: 8449B) are used only for the measurement of emission frequency above 1GHz if tested.
  4. The IC Site Registration No. is IC4924-2.



#### 4.2.3 TEST PROCEDURES

- a. The EUT was placed on the top of a rotating table 0.8 meters above the ground at a 3 meter semi-anechoic chamber. The table was rotated 360 degrees to determine the position of the highest radiation.
- b. The EUT was set 3 meters away from the interference-receiving antenna, which was mounted on the top of a variable-height antenna tower.
- c. The antenna is a broadband antenna, and its height is varied from one meter to four meters above the ground to determine the maximum value of the field strength. Both horizontal and vertical polarizations of the antenna are set to make the measurement.
- d. For each suspected emission, the EUT was arranged to its worst case and then the antenna was tuned to heights from 1 meter to 4 meters and the rotatable table was turned from 0 degrees to 360 degrees to find the maximum reading.
- e. The test-receiver system was set to Peak Detect Function and Specified Bandwidth with Maximum Hold Mode.
- f. If the emission level of the EUT in peak mode was 10 dB lower than the limit specified, then testing could be stopped and the peak values of the EUT would be reported. Otherwise the emissions that did not have 10 dB margin would be re-tested one by one using peak, quasi-peak or average method as specified and then reported in a data sheet.

**NOTE:**

1. The resolution bandwidth and video bandwidth of test receiver/spectrum analyzer is 120kHz for Peak detection (PK) and Quasi-peak detection (QP) at frequency below 1GHz.
2. The resolution bandwidth and video bandwidth of test receiver/spectrum analyzer is 1 MHz for Peak detection at frequency above 1GHz.
3. The resolution bandwidth of test receiver/spectrum analyzer is 1 MHz and the video bandwidth is 10 Hz for Average detection (AV) at frequency above 1GHz.

#### 4.2.4 DEVIATION FROM TEST STANDARD

No deviation

#### 4.2.5 TEST SETUP

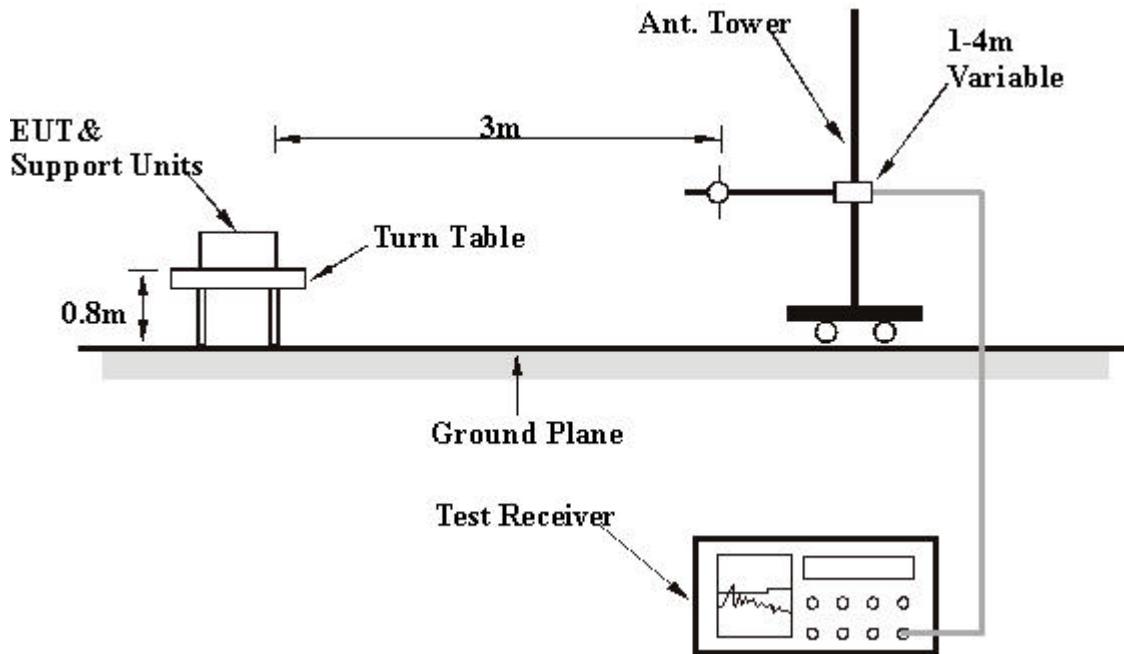

For the actual test configuration, please refer to the related item – Photographs of the Test Configuration.

#### 4.2.6 EUT OPERATING CONDITIONS

Same as 4.1.6



## 4.2.7 TEST RESULTS

<b>EUT</b>	Wireless 802.11g PCI Adapter	<b>MODEL</b>	WPIB-108GM
<b>MODE</b>	Channel 11	<b>FREQUENCY RANGE</b>	Below 1000MHz
<b>INPUT POWER (SYSTEM)</b>	120Vac, 60 Hz	<b>DETECTOR FUNCTION</b>	Quasi-Peak
<b>ENVIRONMENTAL CONDITIONS</b>	26 deg. C, 65 % RH, 991hPa	<b>TESTED BY:</b> Steven Lu	

**ANTENNA POLARITY & TEST DISTANCE: HORIZONTAL AT 3 M**

No.	Freq. (MHz)	Emission Level (dBuV/m)	Limit (dBuV/m)	Margin (dB)	Antenna Height (m)	Table Angle (Degree)	Raw Value (dBuV)	Correction Factor (dB/m)
1	368.24	39.42 QP	46.00	-6.58	1.00 H	133	23.37	16.05
2	471.26	40.47 QP	46.00	-5.53	1.75 H	61	22.12	18.35
3	537.35	43.21 QP	46.00	-2.79	1.50 H	130	23.76	19.45
4	624.83	42.54 QP	46.00	-3.46	1.25 H	31	21.20	21.34
5	671.48	41.74 QP	46.00	-4.26	1.00 H	19	19.79	21.95
6	809.50	42.98 QP	46.00	-3.02	1.00 H	316	19.09	23.89

- REMARKS:**
1. Emission level(dBuV/m)=Raw Value(dBuV) + Correction Factor(dB)
  2. Correction Factor(dB/m) = Antenna Factor (dB/m) + Cable Factor (dB)
  3. The other emission levels were very low against the limit.
  4. Margin value = Emission level – Limit value.



<b>EUT</b>	Wireless 802.11g PCI Adapter	<b>MODEL</b>	WPIB-108GM
<b>MODE</b>	Channel 11	<b>FREQUENCY RANGE</b>	Below 1000MHz
<b>INPUT POWER (SYSTEM)</b>	120Vac, 60 Hz	<b>DETECTOR FUNCTION</b>	Quasi-Peak
<b>ENVIRONMENTAL CONDITIONS</b>	26 deg. C, 65 % RH, 991hPa	<b>TESTED BY:</b> Steven Lu	

**ANTENNA POLARITY & TEST DISTANCE: VERTICAL AT 3 M**

No.	Freq. (MHz)	Emission Level (dBuV/m)	Limit (dBuV/m)	Margin (dB)	Antenna Height (m)	Table Angle (Degree)	Raw Value (dBuV)	Correction Factor (dB/m)
1	368.24	42.89 QP	46.00	-3.11	1.00 V	331	26.84	16.05
2	537.35	42.43 QP	46.00	-3.57	1.00 V	316	22.98	19.45
3	624.83	39.58 QP	46.00	-6.42	1.00 V	217	18.23	21.34
4	675.37	39.84 QP	46.00	-6.16	1.75 V	310	17.84	21.99
5	751.18	39.14 QP	46.00	-6.86	1.00 V	4	15.61	23.54
6	811.44	40.54 QP	46.00	-5.46	1.25 V	202	16.63	23.90

- REMARKS:**
1. Emission level(dBuV/m)=Raw Value(dBuV) + Correction Factor(dB/m)
  2. Correction Factor(dB/m) = Antenna Factor (dB/m) + Cable Factor (dB)
  3. The other emission levels were very low against the limit.
  4. Margin value = Emission level – Limit value.



## 4.2.8 TEST RESULTS (A)

<b>EUT</b>	Wireless 802.11g PCI Adapter	<b>MODEL</b>	WPIB-108GM
<b>CHANNEL</b>	Channel 1	<b>FREQUENCY RANGE</b>	1 ~25GHz
<b>INPUT POWER (SYSTEM)</b>	120Vac, 60 Hz	<b>DETECTOR FUNCTION</b>	Peak(PK) Average (AV)
<b>ENVIRONMENTAL CONDITIONS</b>	25 deg. C, 62 % RH, 991hPa	<b>TESTED BY</b>	Match Tsui

**ANTENNA POLARITY & TEST DISTANCE: HORIZONTAL AT 3 M**

No.	Freq. (MHz)	Emission Level (dBuV/m)	Limit (dBuV/m)	Margin (dB)	Antenna Height (m)	Table Angle (Degree)	Raw Value (dBuV)	Correction Factor (dB/m)
1	1608.00	47.09 PK	74.00	-26.91	1.18 H	226	19.25	27.85
2	2390.00	45.48 PK	74.00	-28.52	1.27 H	73	14.77	30.71
3	*2412.00	105.55 PK			1.27 H	73	74.75	30.80
3	*2412.00	98.81 AV			1.27 H	73	68.01	30.80
4	3216.00	45.77 PK	74.00	-28.23	1.23 H	218	13.13	32.64
4	3216.00	34.63 AV	54.00	-19.37	1.23 H	218	1.99	32.64
5	4824.00	50.18 PK	74.00	-23.82	1.02 H	124	13.60	36.58
5	4824.00	42.61 AV	54.00	-11.39	1.02 H	124	6.03	36.58
6	9648.00	53.10 PK	74.00	-20.90	1.26 H	212	10.98	42.12
6	<b>9648.00</b>	<b>51.37 AV</b>	<b>54.00</b>	<b>-2.63</b>	<b>1.26 H</b>	<b>212</b>	<b>9.25</b>	<b>42.12</b>

**NTENNA POLARITY & TEST DISTANCE: VERTICAL AT 3 M**

No.	Freq. (MHz)	Emission Level (dBuV/m)	Limit (dBuV/m)	Margin (dB)	Antenna Height (m)	Table Angle (Degree)	Raw Value (dBuV)	Correction Factor (dB/m)
1	1608.00	49.69 PK	74.00	-24.31	1.26 V	21	21.85	27.85
1	1608.00	47.46 AV	54.00	-6.54	1.26 V	21	19.62	27.85
2	2390.00	57.57 PK	74.00	-16.43	1.16 V	206	26.86	30.71
2	2390.00	50.07 AV	54.00	-3.93	1.16 V	206	19.36	30.71
3	*2412.00	117.64 PK			1.16 V	206	86.84	30.80
3	*2412.00	110.14 AV			1.16 V	206	79.34	30.80
4	3216.00	49.00 PK	74.00	-25.00	1.27 V	223	16.36	32.64
4	3216.00	42.93 AV	54.00	-11.07	1.27 V	223	10.29	32.64
5	4824.00	48.12 PK	74.00	-25.88	1.20 V	170	11.54	36.58
5	4824.00	45.90 AV	54.00	-8.10	1.20 V	170	9.32	36.58
6	9648.00	56.58 PK	74.00	-17.42	1.26 V	191	14.46	42.12
6	9648.00	50.14 AV	54.00	-3.86	1.26 V	191	8.02	42.12

- REMARKS:**
1. Emission level(dBuV/m)=Raw Value(dBuV) + Correction Factor(dB)
  2. Correction Factor(dB/m) = Antenna Factor (dB/m) + Cable Factor (dB)
  3. The other emission levels were very low against the limit.
  4. Margin value = Emission level – Limit value.
  5. " \* " : Fundamental frequency.



<b>EUT</b>	Wireless 802.11g PCI Adapter	<b>MODEL</b>	WPIB-108GM
<b>CHANNEL</b>	Channel 6	<b>FREQUENCY RANGE</b>	1 ~25GHz
<b>INPUT POWER (SYSTEM)</b>	120Vac, 60 Hz	<b>DETECTOR FUNCTION</b>	Peak(PK) Average (AV)
<b>ENVIRONMENTAL CONDITIONS</b>	24 deg. C, 65 % RH, 991hPa	<b>TESTED BY</b>	Match Tsui

#### ANTENNA POLARITY & TEST DISTANCE: HORIZONTAL AT 3M

No.	Freq. (MHz)	Emission Level (dBuV/m)	Limit (dBuV/m)	Margin (dB)	Antenna Height (m)	Table Angle (Degree)	Raw Value (dBuV)	Correction Factor (dB/m)
1	1624.00	47.96 PK	74.00	-26.04	1.10 H	208	20.09	27.87
1	1624.00	45.92 AV	54.00	-8.08	1.10 H	208	18.05	27.87
2	*2437.00	105.31 PK			1.00 H	105	74.41	30.90
2	*2437.00	98.43 AV			1.00 H	105	67.53	30.90
3	3249.00	45.70 PK	74.00	-28.30	1.26 H	229	13.10	32.60
3	3249.00	34.17 AV	54.00	-19.83	1.26 H	229	1.57	32.60
4	4874.00	49.98 PK	74.00	-24.02	1.00 H	126	13.22	36.76
4	4874.00	41.90 AV	54.00	-12.10	1.00 H	126	5.14	36.76
5	9748.00	53.73 PK	74.00	-20.27	1.20 H	213	15.39	38.34
5	9748.00	47.65 AV	54.00	-6.35	1.20 H	213	9.31	38.34

#### ANTENNA POLARITY & TEST DISTANCE: VERTICAL AT 3M

No.	Freq. (MHz)	Emission Level (dBuV/m)	Limit (dBuV/m)	Margin (dB)	Antenna Height (m)	Table Angle (Degree)	Raw Value (dBuV)	Correction Factor (dB/m)
1	1624.00	49.40 PK	74.00	-24.60	1.09 V	230	21.53	27.87
1	1624.00	48.30 AV	54.00	-5.70	1.09 V	230	20.43	27.87
2	*2437.00	118.19 PK			1.00 V	94	87.29	30.90
2	*2437.00	111.60 AV			1.00 V	94	80.70	30.90
3	3250.00	44.23 PK	74.00	-29.77	1.11 V	216	11.63	32.60
3	3250.00	42.90 AV	54.00	-11.10	1.11 V	216	10.30	32.60
4	4874.00	50.33 PK	74.00	-23.67	1.13 V	220	13.57	36.76
4	4874.00	42.97 AV	54.00	-11.03	1.13 V	220	6.21	36.76
5	9748.00	52.67 PK	74.00	-21.33	1.13 V	165	14.33	38.34
5	9748.00	46.38 AV	54.00	-7.62	1.13 V	165	8.04	38.34

- REMARKS:**
1. Emission level(dBuV/m)=Raw Value(dBuV) + Correction Factor(dB)
  2. Correction Factor(dB/m) = Antenna Factor (dB/m) + Cable Factor (dB)
  3. The other emission levels were very low against the limit.
  4. Margin value = Emission level – Limit value.
  5. " \* " : Fundamental frequency.



<b>EUT</b>	Wireless 802.11g PCI Adapter	<b>MODEL</b>	WPIB-108GM
<b>CHANNEL</b>	Channel 11	<b>FREQUENCY RANGE</b>	1 ~25GHz
<b>INPUT POWER (SYSTEM)</b>	120Vac, 60 Hz	<b>DETECTOR FUNCTION</b>	Peak(PK) Average (AV)
<b>ENVIRONMENTAL CONDITIONS</b>	24 deg. C, 65 % RH, 991hPa	<b>TESTED BY</b>	Match Tsui

#### ANTENNA POLARITY & TEST DISTANCE: HORIZONTAL AT 3M

No.	Freq. (MHz)	Emission Level (dBuV/m)	Limit (dBuV/m)	Margin (dB)	Antenna Height (m)	Table Angle (Degree)	Raw Value (dBuV)	Correction Factor (dB/m)
1	1642.00	48.25 PK	74.00	-25.75	1.13 H	210	20.34	27.91
1	1642.00	47.71 AV	54.00	-6.29	1.13 H	210	20.34	27.91
2	*2462.00	106.83 PK			1.00 H	360	75.84	30.99
2	*2462.00	100.17 AV			1.00 H	360	69.18	30.99
3	2483.50	45.95 PK	74.00	-28.05	1.00 H	360	14.88	31.07
3	2483.50	39.29 AV	54.00	-14.71	1.00 H	360	8.22	31.07
4	3274.00	47.04 PK	74.00	-26.96	1.16 H	64	14.46	32.58
4	3274.00	39.90 AV	54.00	-14.10	1.16 H	64	7.32	32.58
5	4924.00	50.82 PK	74.00	-23.18	1.00 H	142	13.85	36.97
5	4924.00	42.90 AV	54.00	-11.10	1.00 H	142	5.93	36.97
6	9848.00	48.71 PK	74.00	-25.29	1.27 H	212	13.57	35.14
6	9848.00	42.01 AV	54.00	-11.99	1.27 H	212	6.87	35.14

#### ANTENNA POLARITY & TEST DISTANCE: VERTICAL AT 3M

No.	Freq. (MHz)	Emission Level (dBuV/m)	Limit (dBuV/m)	Margin (dB)	Antenna Height (m)	Table Angle (Degree)	Raw Value (dBuV)	Correction Factor (dB/m)
1	1642.00	48.55 PK	74.00	-25.45	1.19 V	100	20.64	27.91
1	1642.00	46.04 AV	54.00	-7.96	1.19 V	100	18.13	27.91
2	*2462.00	117.66 PK			1.00 V	131	86.67	30.99
2	*2462.00	110.91 AV			1.00 V	131	79.92	30.99
3	2483.50	56.78 PK	74.00	-17.22	1.00 V	131	25.71	31.07
3	2483.50	50.03 AV	54.00	-3.97	1.00 V	131	18.96	31.07
4	3284.00	47.12 PK	74.00	-26.88	1.38 V	88	14.55	32.57
4	3284.00	41.40 AV	54.00	-12.60	1.38 V	88	8.83	32.57
5	4924.00	51.44 PK	74.00	-22.56	1.00 V	223	14.47	36.97
5	4924.00	46.64 AV	54.00	-7.36	1.00 V	223	9.67	36.97
6	9848.00	47.95 PK	74.00	-26.05	1.00 V	158	12.81	35.14
6	9848.00	39.83 AV	54.00	-14.17	1.00 V	158	4.69	35.14

- REMARKS:**
1. Emission level(dBuV/m)=Raw Value(dBuV) + Correction Factor(dB)
  2. Correction Factor(dB/m) = Antenna Factor (dB/m) + Cable Factor (dB)
  3. The other emission levels were very low against the limit.
  4. Margin value = Emission level – Limit value.
  5. " \* " : Fundamental frequency.



#### 4.2.9 TEST RESULTS (B)

<b>EUT</b>	Wireless 802.11g PCI Adapter	<b>MODEL</b>	WPIB-108GM
<b>CHANNEL</b>	Channel 1	<b>FREQUENCY RANGE</b>	1 ~25GHz
<b>INPUT POWER (SYSTEM)</b>	120Vac, 60 Hz	<b>DETECTOR FUNCTION</b>	Peak(PK) Average (AV)
<b>ENVIRONMENTAL CONDITIONS</b>	25 deg. C, 62 % RH, 991hPa	<b>TESTED BY</b>	Match Tsui

#### ANTENNA POLARITY & TEST DISTANCE: HORIZONTAL AT 3M

No.	Freq. (MHz)	Emission Level (dBuV/m)	Limit (dBuV/m)	Margin (dB)	Antenna Height (m)	Table Angle (Degree)	Raw Value (dBuV)	Correction Factor (dB/m)
1	1608.00	48.62 PK	74.00	-25.38	1.10 H	213	20.78	27.85
1	1608.00	46.03 AV	54.00	-7.97	1.10 H	213	18.19	27.85
2	2390.00	43.40 PK	74.00	-30.60	1.03 H	321	12.69	30.71
2	2390.00	37.83 AV	54.00	-16.17	1.03 H	321	7.12	30.71
3	*2412.00	103.82 PK			1.03 H	321	73.02	30.80
3	*2412.00	98.25 AV			1.03 H	321	67.45	30.80
4	3274.00	47.82 PK	74.00	-26.18	1.00 H	132	15.24	32.58
4	3274.00	40.11 AV	54.00	-13.89	1.00 H	132	7.53	32.58
5	4824.00	48.21 PK	74.00	-25.79	1.16 H	138	11.63	36.58
5	4824.00	38.69 AV	54.00	-15.31	1.16 H	138	2.11	36.58
6	9648.00	52.28 PK	74.00	-21.72	1.11 H	214	10.16	42.12
6	9648.00	51.03 AV	54.00	-2.97	1.11 H	214	8.91	42.12

#### ANTENNA POLARITY & TEST DISTANCE: VERTICAL AT 3M

No.	Freq. (MHz)	Emission Level (dBuV/m)	Limit (dBuV/m)	Margin (dB)	Antenna Height (m)	Table Angle (Degree)	Raw Value (dBuV)	Correction Factor (dB/m)
1	1608.00	48.73 PK	74.00	-25.27	1.20 V	302	20.89	27.85
1	1608.00	46.19 AV	54.00	-7.81	1.20 V	302	18.35	27.85
2	2390.00	52.31 PK	74.00	-21.69	1.19 V	87	21.60	30.71
2	2390.00	49.90 AV	54.00	-4.10	1.19 V	87	19.19	30.71
3	*2412.00	112.73 PK			1.19 V	87	81.93	30.80
3	*2412.00	109.51 AV			1.19 V	87	78.71	30.80
4	3274.00	46.53 PK	74.00	-27.47	1.13 V	26	13.95	32.58
4	3274.00	38.82 AV	54.00	-15.18	1.13 V	26	6.24	32.58
5	4824.00	44.41 PK	74.00	-29.59	1.25 V	360	7.83	36.58
5	4824.00	39.89 AV	54.00	-14.11	1.25 V	360	3.31	36.58
6	9648.00	52.99 PK	74.00	-21.01	1.25 V	164	10.87	42.12
6	9648.00	50.04 AV	54.00	-3.96	1.25 V	164	7.92	42.12

- REMARKS:**
1. Emission level(dBuV/m)=Raw Value(dBuV) + Correction Factor(dB)
  2. Correction Factor(dB/m) = Antenna Factor (dB/m) + Cable Factor (dB)
  3. The other emission levels were very low against the limit.
  4. Margin value = Emission level – Limit value.
  5. " \* " : Fundamental frequency.



<b>EUT</b>	Wireless 802.11g PCI Adapter	<b>MODEL</b>	WPIB-108GM
<b>CHANNEL</b>	Channel 6	<b>FREQUENCY RANGE</b>	1 ~25GHz
<b>INPUT POWER (SYSTEM)</b>	120Vac, 60 Hz	<b>DETECTOR FUNCTION</b>	Peak(PK) Average (AV)
<b>ENVIRONMENTAL CONDITIONS</b>	25 deg. C, 62 % RH, 991hPa	<b>TESTED BY</b>	Match Tsui

**ANTENNA POLARITY & TEST DISTANCE: HORIZONTAL AT 3M**

No.	Freq. (MHz)	Emission Level (dBuV/m)	Limit (dBuV/m)	Margin (dB)	Antenna Height (m)	Table Angle (Degree)	Raw Value (dBuV)	Correction Factor (dB/m)
1	1624.00	48.59 PK	74.00	-25.41	1.09 H	205	20.72	27.87
1	1624.00	46.15 AV	54.00	-7.85	1.09 H	205	18.28	27.87
2	*2437.00	103.65 PK			1.01 H	98	72.75	30.90
2	*2437.00	100.12 AV			1.01 H	98	69.22	30.90
3	3222.00	44.12 PK	74.00	-29.88	1.02 H	162	11.49	32.63
3	3222.00	38.12 AV	54.00	-15.88	1.02 H	162	5.49	32.63
4	4874.00	45.81 PK	74.00	-28.19	1.00 H	138	9.05	36.76
4	4874.00	41.71 AV	54.00	-12.29	1.00 H	138	4.95	36.76
5	9748.00	45.35 PK	74.00	-28.65	1.00 H	105	7.01	38.34
5	9748.00	42.92 AV	54.00	-11.08	1.00 H	105	4.58	38.34

**ANTENNA POLARITY & TEST DISTANCE: VERTICAL AT 3M**

No.	Freq. (MHz)	Emission Level (dBuV/m)	Limit (dBuV/m)	Margin (dB)	Antenna Height (m)	Table Angle (Degree)	Raw Value (dBuV)	Correction Factor (dB/m)
1	1624.00	49.56 PK	74.00	-24.44	1.28 V	26	21.69	27.87
1	1624.00	47.51 AV	54.00	-6.49	1.28 V	26	19.64	27.87
2	*2437.00	113.52 PK			1.19 V	88	82.62	30.90
2	*2437.00	109.86 AV			1.19 V	88	78.96	30.90
3	3425.00	51.91 PK	74.00	-22.09	1.25 V	131	19.09	32.81
3	3425.00	47.82 AV	54.00	-6.18	1.25 V	131	15.00	32.81
4	4874.00	45.61 PK	74.00	-28.39	1.37 V	118	8.85	36.76
4	4874.00	44.05 AV	54.00	-9.95	1.37 V	118	8.85	36.76
5	9748.00	45.95 PK	74.00	-28.05	1.36 V	171	7.61	38.34
5	9748.00	42.90 AV	54.00	-11.10	1.36 V	171	4.56	38.34

- REMARKS:**
1. Emission level(dBuV/m)=Raw Value(dBuV) + Correction Factor(dB)
  2. Correction Factor(dB/m) = Antenna Factor (dB/m) + Cable Factor (dB)
  3. The other emission levels were very low against the limit.
  4. Margin value = Emission level – Limit value.
4. “ \* “ : Fundamental frequency.



<b>EUT</b>	Wireless 802.11g PCI Adapter	<b>MODEL</b>	WPIB-108GM
<b>CHANNEL</b>	Channel 11	<b>FREQUENCY RANGE</b>	1 ~25GHz
<b>INPUT POWER (SYSTEM)</b>	120Vac, 60 Hz	<b>DETECTOR FUNCTION</b>	Peak(PK) Average (AV)
<b>ENVIRONMENTAL CONDITIONS</b>	25 deg. C, 62 % RH, 991hPa	<b>TESTED BY</b>	Match Tsui

#### ANTENNA POLARITY & TEST DISTANCE: HORIZONTAL AT 3M

No.	Freq. (MHz)	Emission Level (dBuV/m)	Limit (dBuV/m)	Margin (dB)	Antenna Height (m)	Table Angle (Degree)	Raw Value (dBuV)	Correction Factor (dB/m)
1	1641.00	49.21 PK	74.00	-24.79	1.46 H	207	21.30	27.90
1	1641.00	46.72 AV	54.00	-7.28	1.46 H	207	18.81	27.90
2	*2462.00	105.74 PK			1.00 H	101	74.75	30.99
2	*2462.00	99.69 AV			1.00 H	101	68.70	30.99
3	2483.50	46.38 PK	74.00	-27.62	1.00 H	101	15.31	31.07
3	2483.50	40.33 AV	54.00	-13.67	1.00 H	101	9.26	31.07
4	3460.00	48.63 PK	74.00	-25.37	1.00 H	149	15.77	32.86
4	3460.00	42.54 AV	54.00	-11.46	1.00 H	149	9.68	32.86
5	4924.00	43.02 PK	74.00	-30.98	1.00 H	117	6.05	36.97
5	4924.00	68.97 AV	54.00	-15.03	1.00 H	117	2.00	36.97
6	9848.00	39.41 PK	74.00	-34.59	1.29 H	226	4.27	35.14
6	9848.00	35.90 AV	54.00	-18.10	1.29 H	226	0.76	35.14

#### ANTENNA POLARITY & TEST DISTANCE: VERTICAL AT 3M

No.	Freq. (MHz)	Emission Level (dBuV/m)	Limit (dBuV/m)	Margin (dB)	Antenna Height (m)	Table Angle (Degree)	Raw Value (dBuV)	Correction Factor (dB/m)
1	1641.00	50.38 PK	74.00	-23.62	1.15 V	94	22.47	27.90
1	1641.00	48.42 AV	54.00	-5.58	1.15 V	94	20.51	27.90
2	*2462.00	116.38 PK			1.00 V	123	85.39	30.99
2	*2462.00	110.30 AV			1.00 V	123	79.31	30.99
3	2483.50	57.02 PK	74.00	-16.98	1.00 V	123	25.95	31.07
3	2483.50	50.94 AV	54.00	-3.06	1.00 V	123	19.87	31.07
4	3460.00	47.57 PK	74.00	-26.43	1.19 V	146	14.71	32.86
4	3460.00	40.81 AV	54.00	-13.19	1.19 V	146	7.951	32.86
5	4924.00	44.23 PK	74.00	-29.77	1.00 V	348	7.26	36.97
5	4924.00	41.84 AV	54.00	-12.16	1.00 V	348	4.87	36.97

- REMARKS:**
1. Emission level(dBuV/m)=Raw Value(dBuV) + Correction Factor(dB)
  2. Correction Factor(dB/m) = Antenna Factor (dB/m) + Cable Factor (dB)
  3. The other emission levels were very low against the limit.
  4. Margin value = Emission level – Limit value.
  5. " \* " : Fundamental frequency.



### 4.3 6dB BANDWIDTH MEASUREMENT

#### 4.3.1 LIMITS OF 6dB BANDWIDTH MEASUREMENT

The minimum of 6dB Bandwidth Measurement is 0.5 MHz.

#### 4.3.2 TEST INSTRUMENTS

Description & Manufacturer	Model No.	Serial No.	Calibrated Until
SPECTRUM ANALYZER	FSEK30	100049	Aug. 12, 2004

**NOTE:** The calibration interval of the above test instruments is 12 months and the calibrations are traceable to NML/ROC and NIST/USA.

#### 4.3.3 TEST PROCEDURE

The transmitter output was connected to the spectrum analyzer through an attenuator. The bandwidth of the fundamental frequency was measured by spectrum analyzer with 100 kHz RBW and 100kHz VBW. The 6dB bandwidth is defined as the total spectrum the power of which is higher than peak power minus 6dB.

#### 4.3.4 DEVIATION FROM TEST STANDARD

No deviation

#### 4.3.5 TEST SETUP

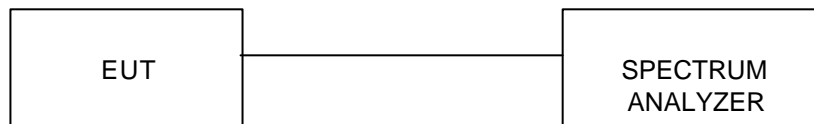

For the actual test configuration, please refer to the related Item – Photographs of the Test Configuration.

#### 4.3.6 EUT OPERATING CONDITIONS

The software provided by client to enable the EUT under transmission condition continuously at lowest, middle and highest channel frequencies individually.





4.3.7 TEST RESULTS (A)

<b>EUT</b>	Wireless 802.11g PCI Adapter	<b>MODEL</b>	WPIB-108GM
<b>INPUT POWER (SYSTEM)</b>	120Vac, 60 Hz	<b>ENVIRONMENTAL CONDITIONS</b>	25deg. C, 65%RH, 991hPa
<b>TESTED BY:</b>	Match Tsui		

<b>CHANNEL</b>	<b>CHANNEL FREQUENCY (MHz)</b>	<b>6dB BANDWIDTH (MHz)</b>	<b>MINIMUM LIMIT (MHz)</b>	<b>PASS/FAIL</b>
1	2412	11.44	0.5	PASS
6	2437	10.96	0.5	PASS
11	2462	11.40	0.5	PASS



CH1

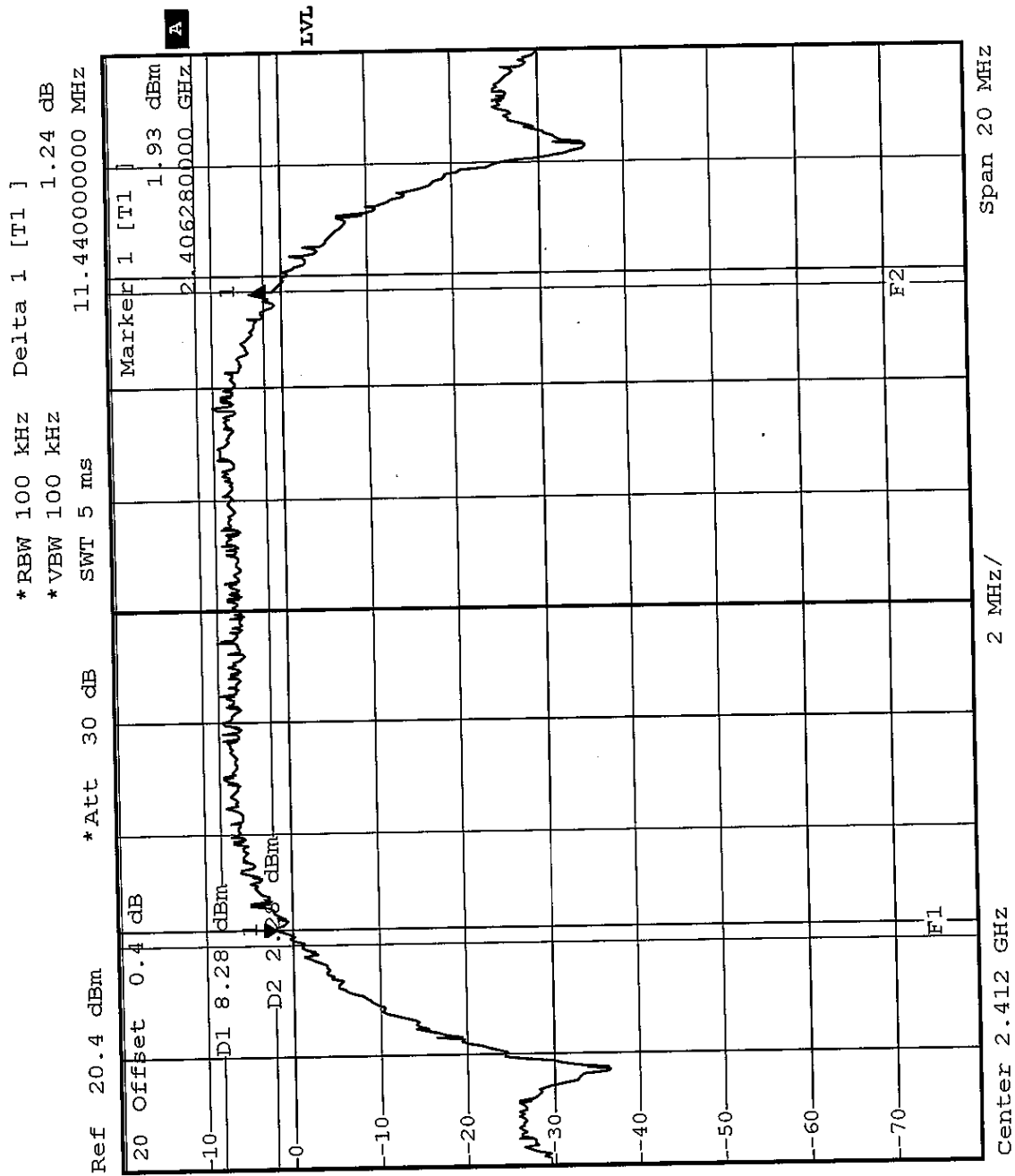

1 PK  
VIEW



CH6

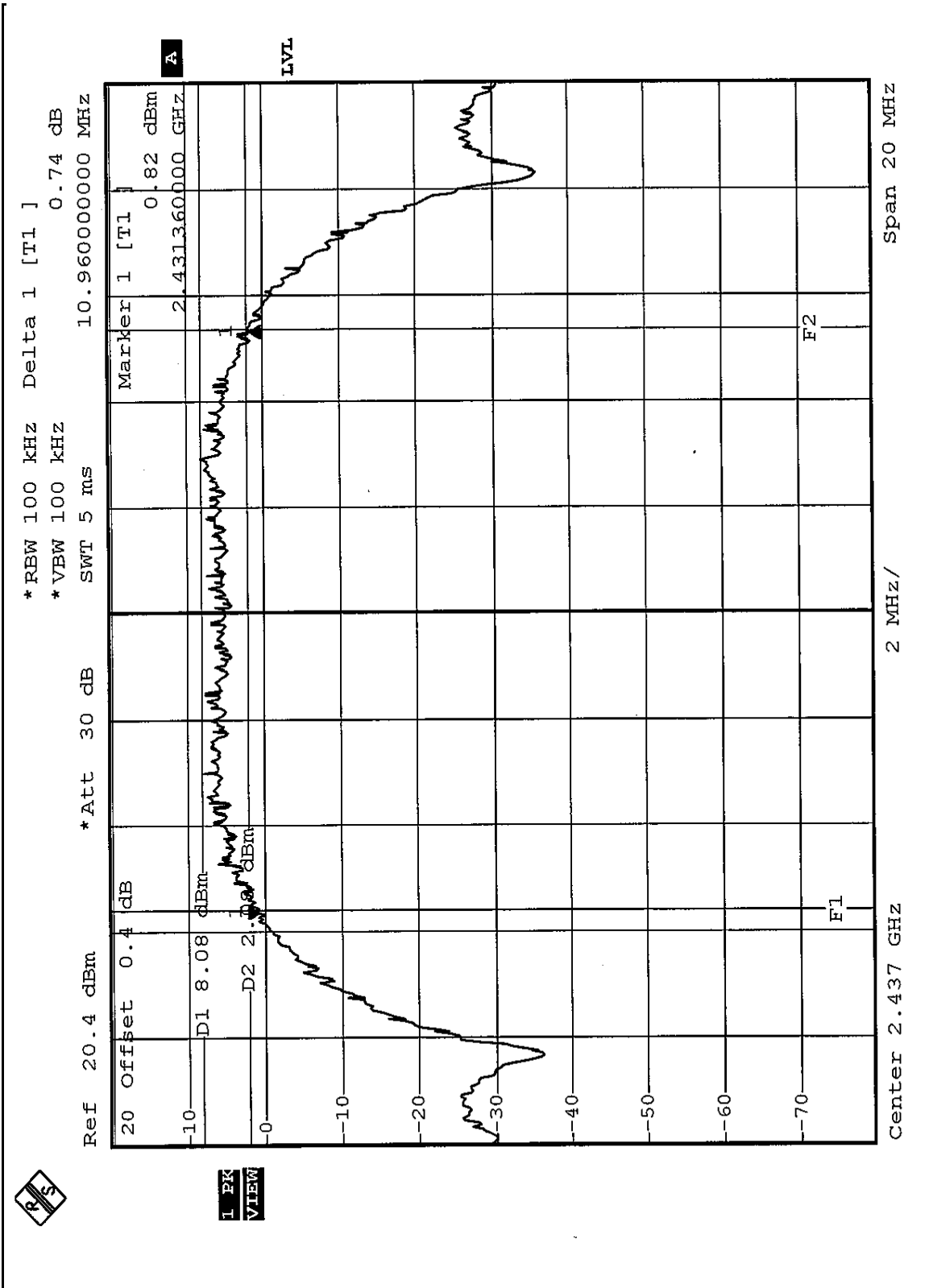



CH11

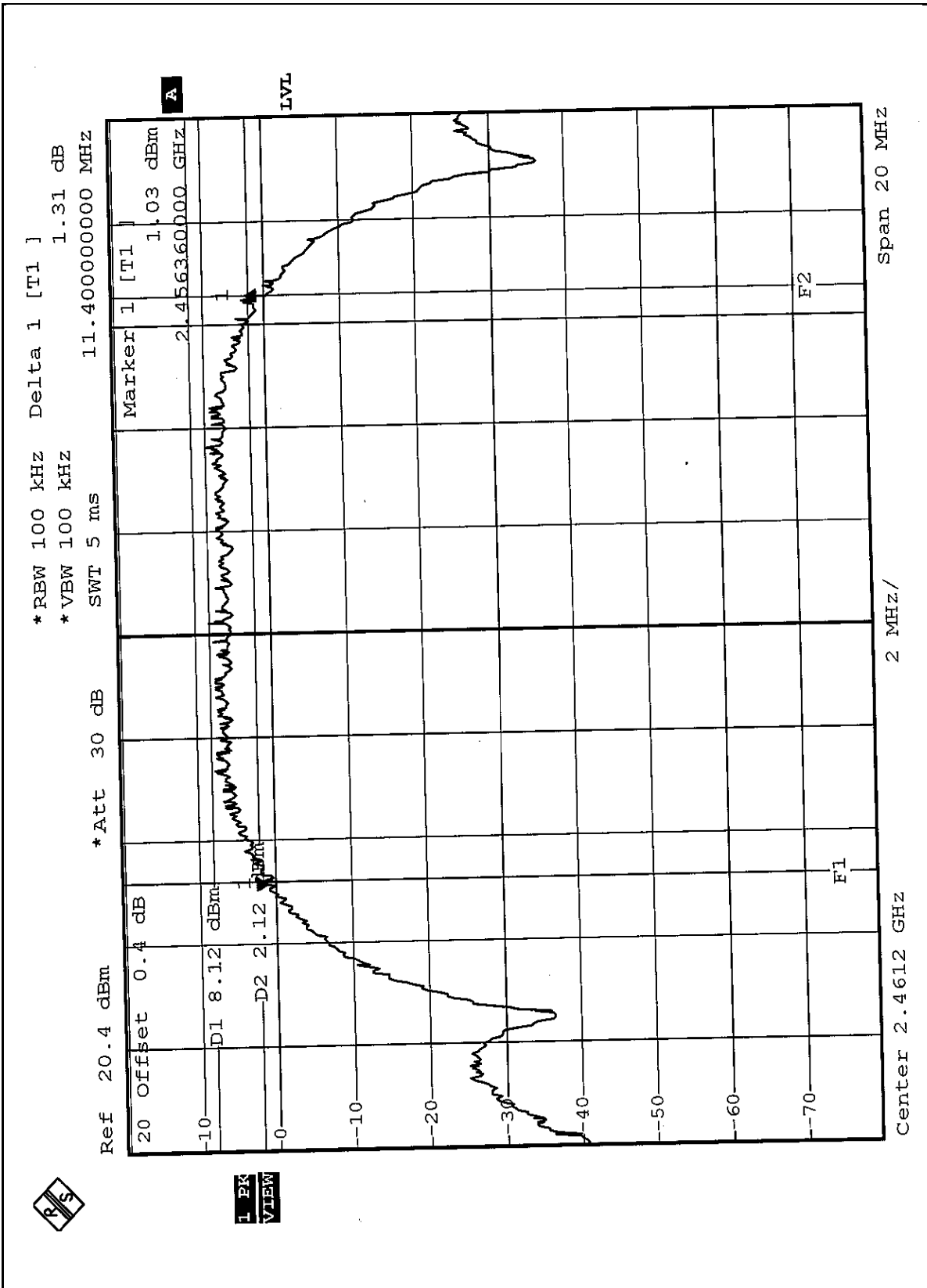



4.3.8 TEST RESULTS (B)

<b>EUT</b>	Wireless 802.11g PCI Adapter	<b>MODEL</b>	WPIB-108GM
<b>INPUT POWER (SYSTEM)</b>	120Vac, 60 Hz	<b>ENVIRONMENTAL CONDITIONS</b>	25deg. C, 65%RH, 991hPa
<b>TESTED BY:</b>	Match Tsui		

<b>CHANNEL</b>	<b>CHANNEL FREQUENCY (MHz)</b>	<b>6dB BANDWIDTH (MHz)</b>	<b>MINIMUM LIMIT (MHz)</b>	<b>PASS/FAIL</b>
1	2412	10.08	0.5	PASS
6	2437	10.04	0.5	PASS
11	2462	10.08	0.5	PASS



CH1

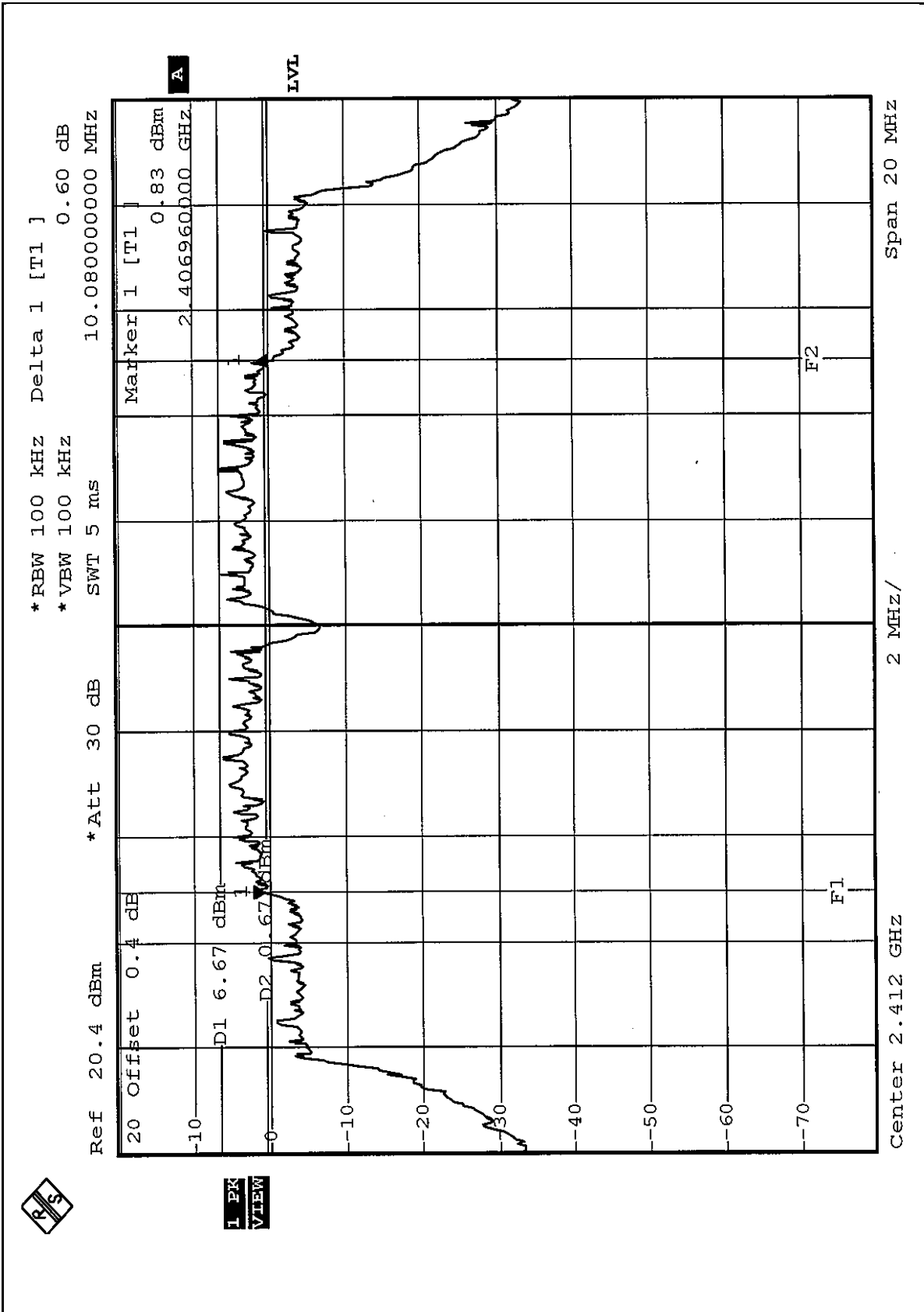



CH6

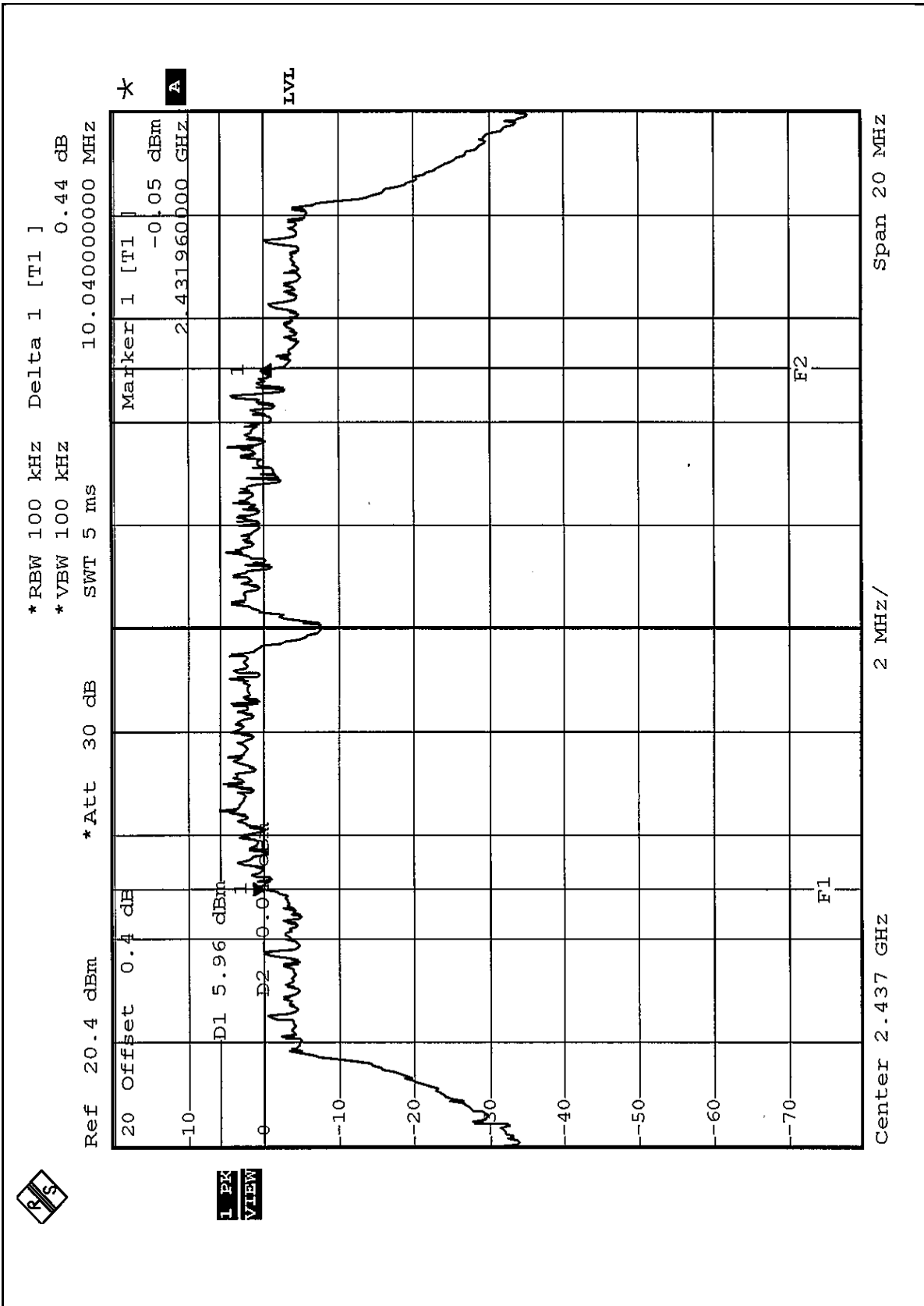



CH11

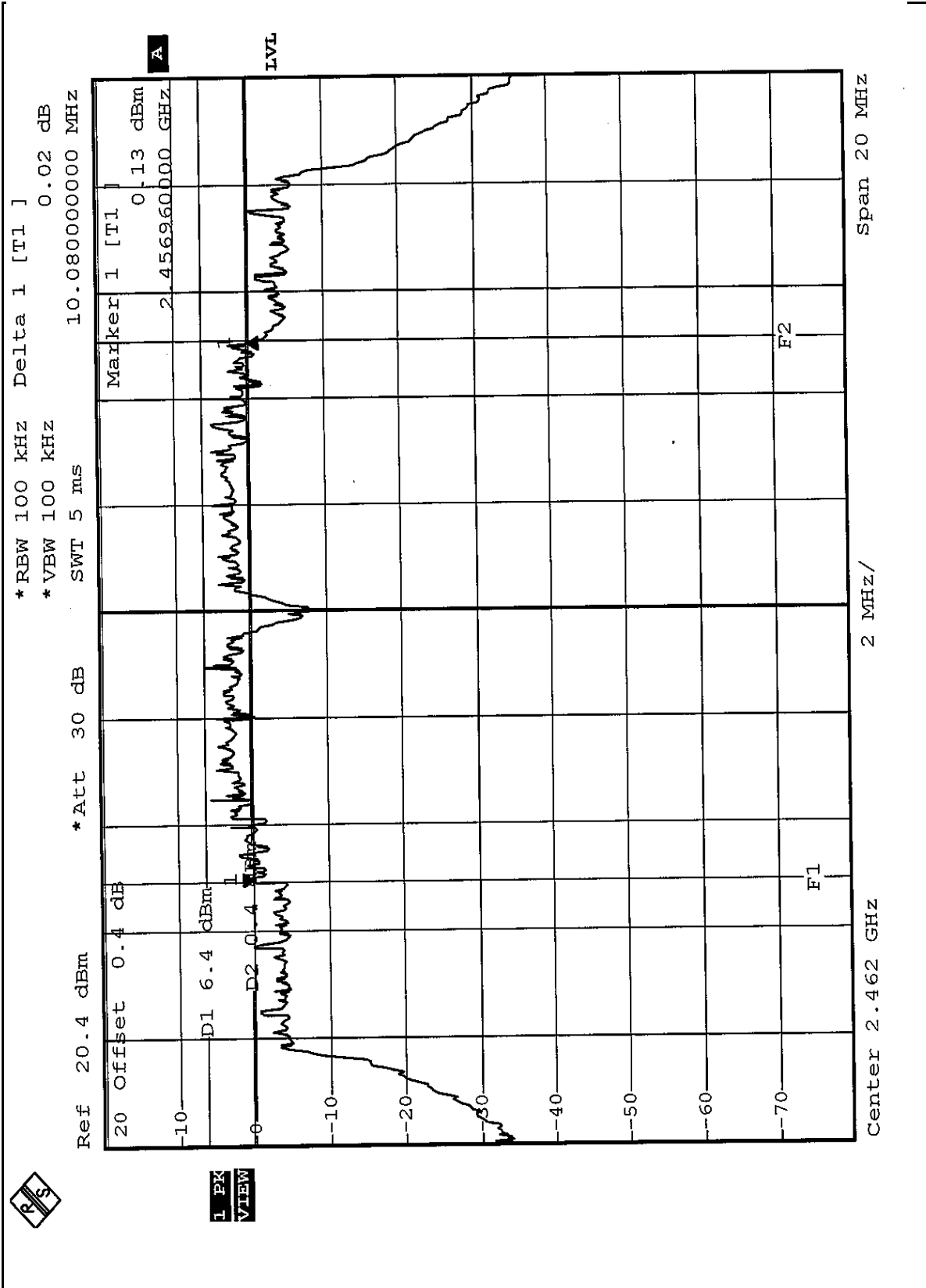





#### 4.4 MAXIMUM PEAK OUTPUT POWER

##### 4.4.1 LIMITS OF MAXIMUM PEAK OUTPUT POWER MEASUREMENT

The Maximum Peak Output Power Measurement is 30dBm.

##### 4.4.2 TEST INSTRUMENTS

Description & Manufacturer	Model No.	Serial No.	Calibrated Until
R&S SPECTRUM ANALYZER	FSEK30	100049	Aug. 12, 2004
AGILENT SIGNAL GENERATOR	E8257C	MY43320668	Dec. 31, 2004
TEKTRONIX OSCILLOSCOPE	TDS 220	C019167	Feb. 1, 2005
NARDA DETECTOR	4503A	FSCM99899	NA

**NOTE:**

The calibration interval of the above test instruments is 12 months and the calibrations are traceable to NML/ROC and NIST/USA.



#### 4.4.3 TEST PROCEDURES

1. A detector was used on the output port of the EUT. An oscilloscope was used to peak the response of the detector.
2. Replaced the EUT by the signal generator. The center frequency of the S.G was adjusted to the center frequency of the measured channel.
3. Adjusted the power to have the same peak reading on oscilloscope. Record the power level.

#### 4.4.4 DEVIATION FROM TEST STANDARD

No deviation

#### 4.4.5 TEST SETUP



#### 4.4.6 EUT OPERATING CONDITIONS

Same as Item 4.3.6



## 4.4.7 TEST RESULTS (A)

<b>EUT</b>	Wireless 802.11g PCI Adapter	<b>MODEL</b>	WPIB-108GM
<b>INPUT POWER (SYSTEM)</b>	120Vac, 60 Hz	<b>ENVIRONMENTAL CONDITIONS</b>	25deg. C, 65%RH, 991hPa
<b>TESTED BY:</b>	Match Tsui		

CHANNEL	CHANNEL FREQUENCY (MHz)	PEAK POWER OUTPUT (dBm)	PEAK POWER LIMIT (dBm)	PASS/FAIL
1	2412	20.00	30	PASS
6	2437	20.00	30	PASS
11	2462	20.00	30	PASS

## 4.4.8 TEST RESULTS (B)

<b>EUT</b>	Wireless 802.11g PCI Adapter	<b>MODEL</b>	WPIB-108GM
<b>INPUT POWER (SYSTEM)</b>	120Vac, 60 Hz	<b>ENVIRONMENTAL CONDITIONS</b>	25deg. C, 65%RH, 991hPa
<b>TESTED BY:</b>	Match Tsui		

CHANNEL	CHANNEL FREQUENCY (MHz)	PEAK POWER OUTPUT (dBm)	PEAK POWER LIMIT (dBm)	PASS/FAIL
1	2412	16.00	30	PASS
6	2437	16.00	30	PASS
11	2462	16.00	30	PASS



## 4.5 POWER SPECTRAL DENSITY MEASUREMENT

### 4.5.1 LIMITS OF POWER SPECTRAL DENSITY MEASUREMENT

The Maximum of Power Spectral Density Measurement is 8dBm.

### 4.5.2 TEST INSTRUMENTS

Description & Manufacturer	Model No.	Serial No.	Calibrated Until
SPECTRUM ANALYZER	FSEK30	100049	Aug. 12, 2004

**NOTE:** The calibration interval of the above test instruments is 12 months and the calibrations are traceable to NML/ROC and NIST/USA.

#### 4.5.3 TEST PROCEDURE

The transmitter output was connected to the spectrum analyzer through an attenuator, the bandwidth of the fundamental frequency was measured with the spectrum analyzer using 3kHz RBW and 30kHz VBW, set sweep time=span/3kHz. The power spectral density was measured and recorded. The sweep time is allowed to be longer than span/3kHz for a full response of the mixer in the spectrum analyzer.

#### 4.5.4 DEVIATION FROM TEST STANDARD

No deviation

#### 4.5.5 TEST SETUP

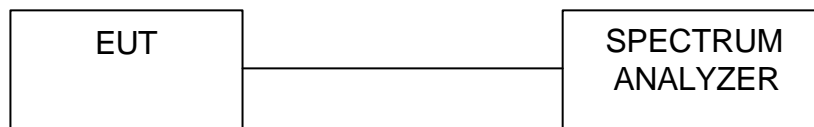

#### 4.5.6 EUT OPERATING CONDITIONS

Same as 4.3.6



4.5.7 TEST RESULTS (A)

<b>EUT</b>	Wireless 802.11g PCI Adapter	<b>MODEL</b>	WPIB-108GM
<b>INPUT POWER (SYSTEM)</b>	120Vac, 60 Hz	<b>ENVIRONMENTAL CONDITIONS</b>	25deg. C, 65%RH, 991hPa
<b>TESTED BY:</b>	Match Tsui		

<b>CHANNEL</b>	<b>CHANNEL FREQUENCY (MHz )</b>	<b>RF POWER LEVEL IN 3 kHz BW (dBm)</b>	<b>MAXIMUM LIMIT (dBm)</b>	<b>PASS/FAIL</b>
1	2412	-6.02	8	PASS
6	2437	-6.21	8	PASS
11	2462	-6.12	8	PASS



CH1

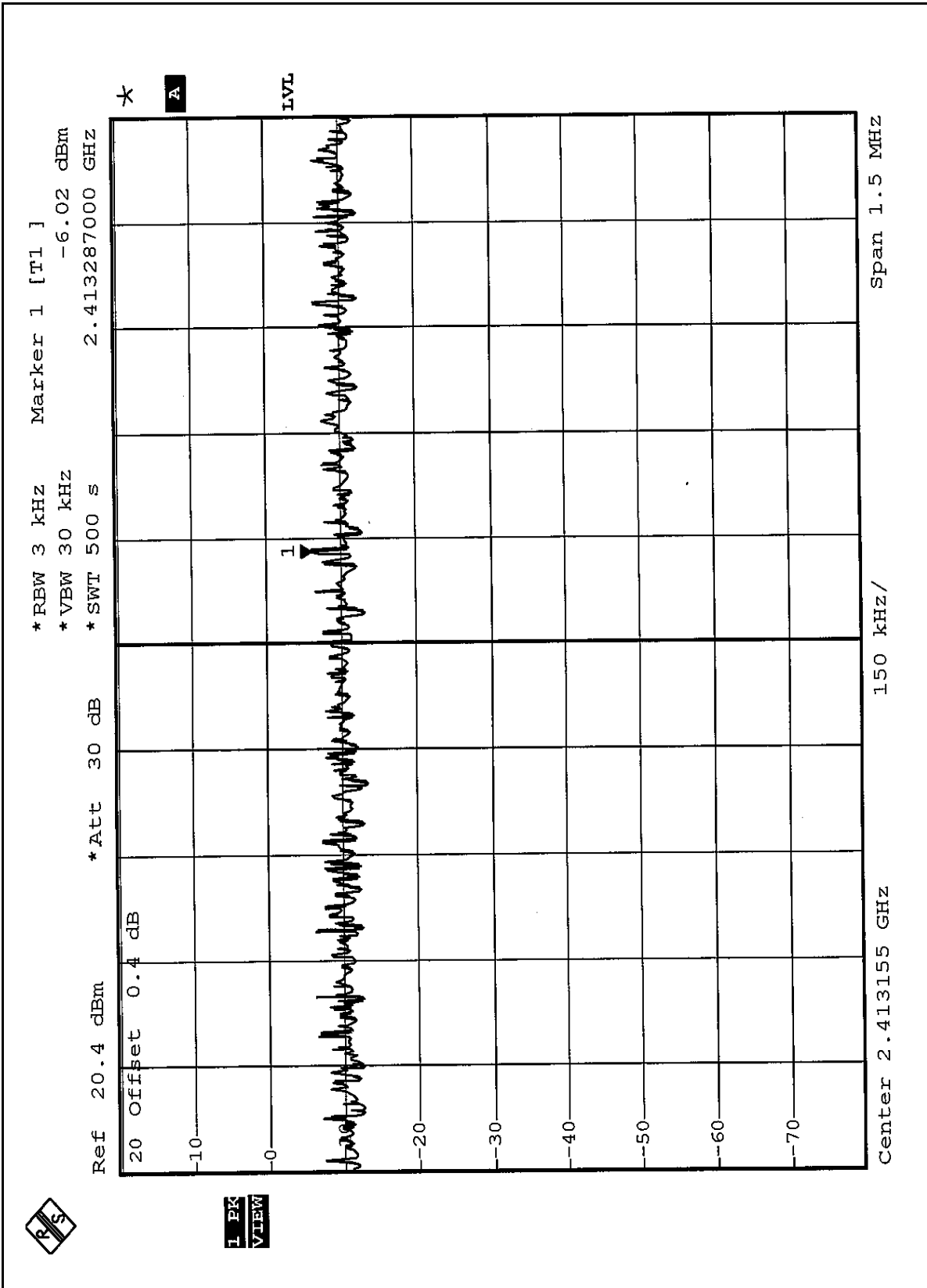

1 PK  
VIEW



CH6

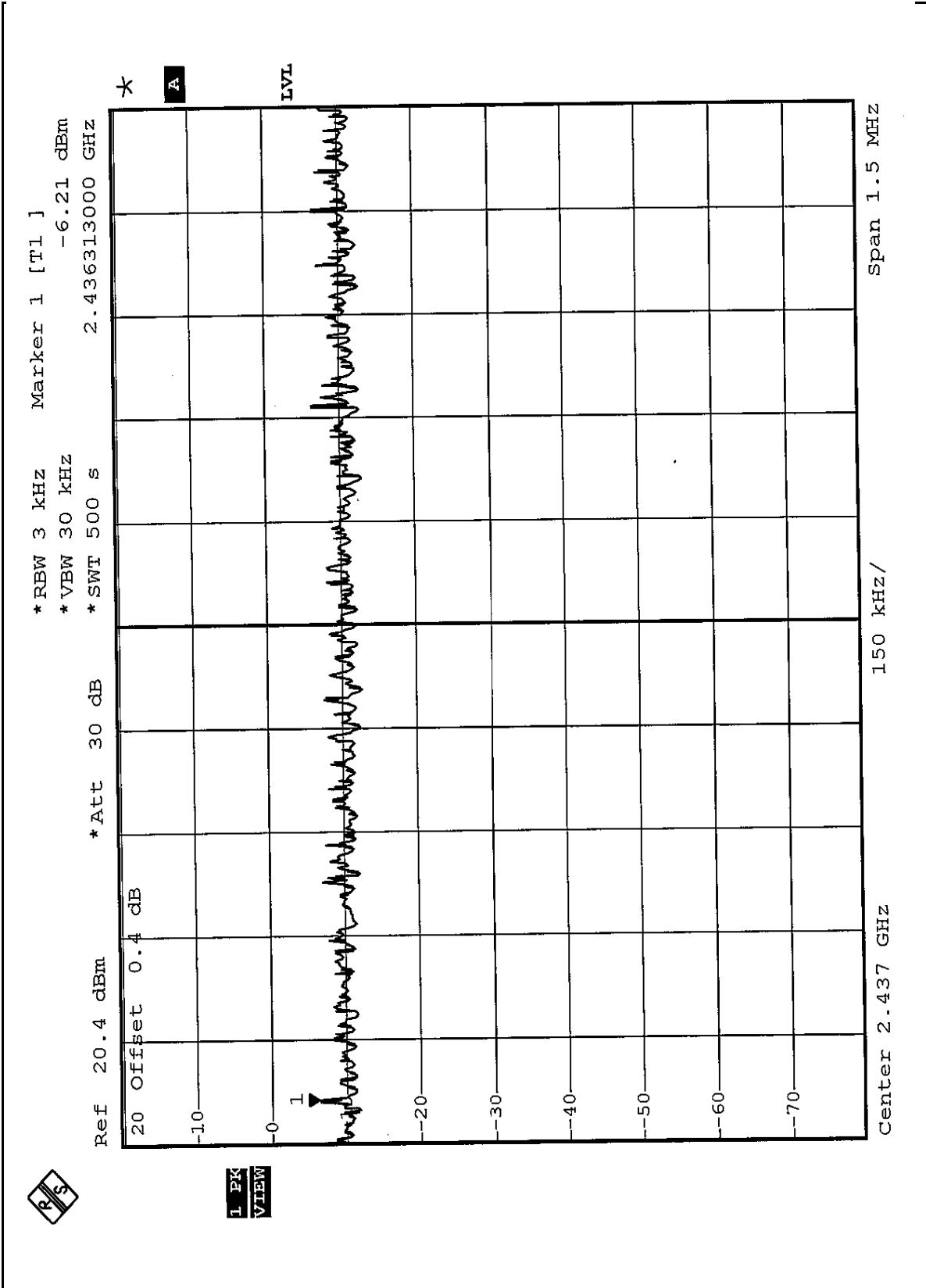





CH11

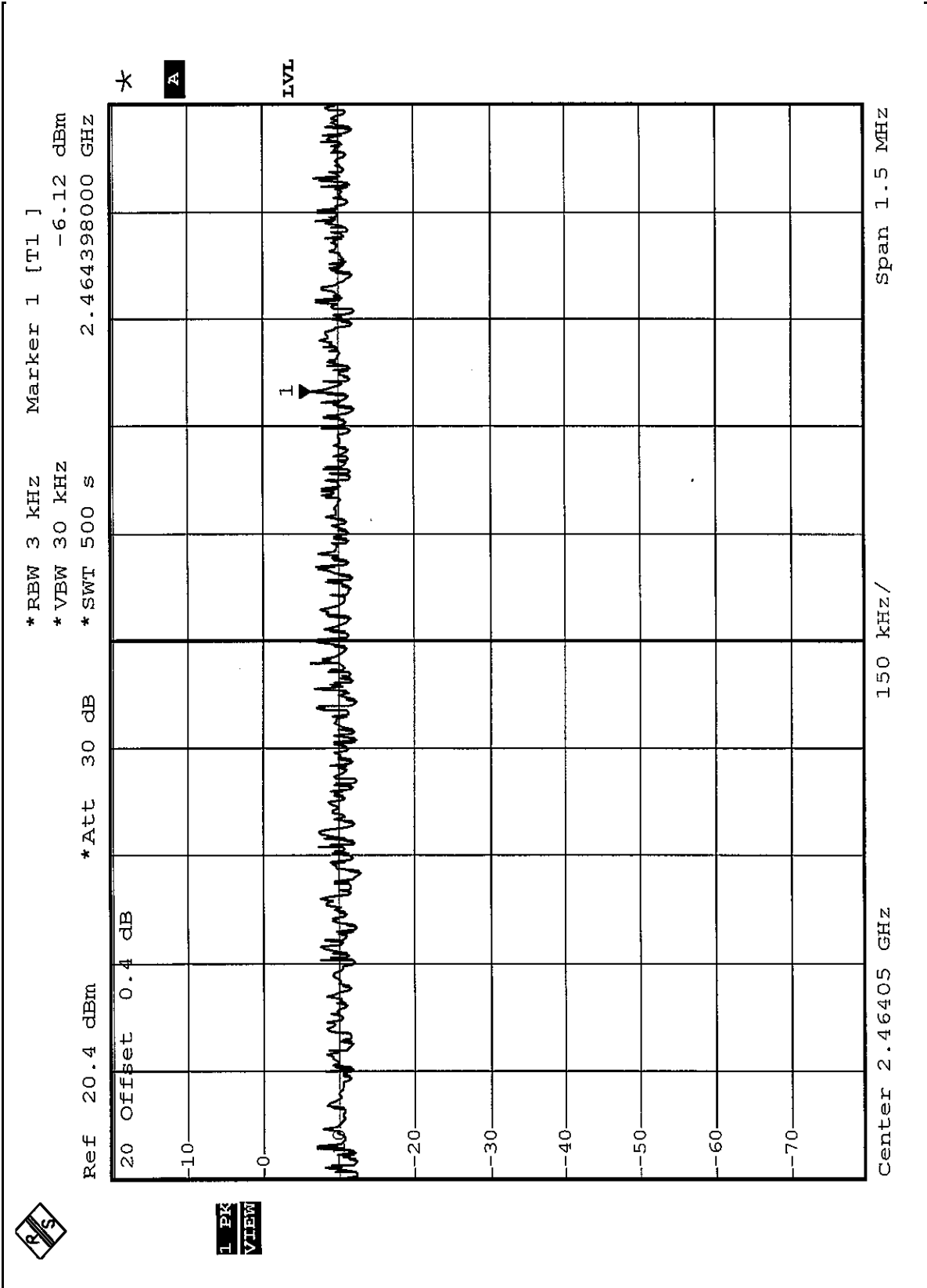



4.5.8 TEST RESULTS (B)

<b>EUT</b>	Wireless 802.11g PCI Adapter	<b>MODEL</b>	WPIB-108GM
<b>INPUT POWER (SYSTEM)</b>	120Vac, 60 Hz	<b>ENVIRONMENTAL CONDITIONS</b>	25deg. C, 65%RH, 991hPa
<b>TESTED BY:</b>	Match Tsui		

<b>CHANNEL</b>	<b>CHANNEL FREQUENCY (MHz )</b>	<b>RF POWER LEVEL IN 3 kHz BW (dBm)</b>	<b>MAXIMUM LIMIT (dBm)</b>	<b>PASS/FAIL</b>
1	2412	-11.13	8	PASS
6	2437	-11.84	8	PASS
11	2462	-11.48	8	PASS



CH1

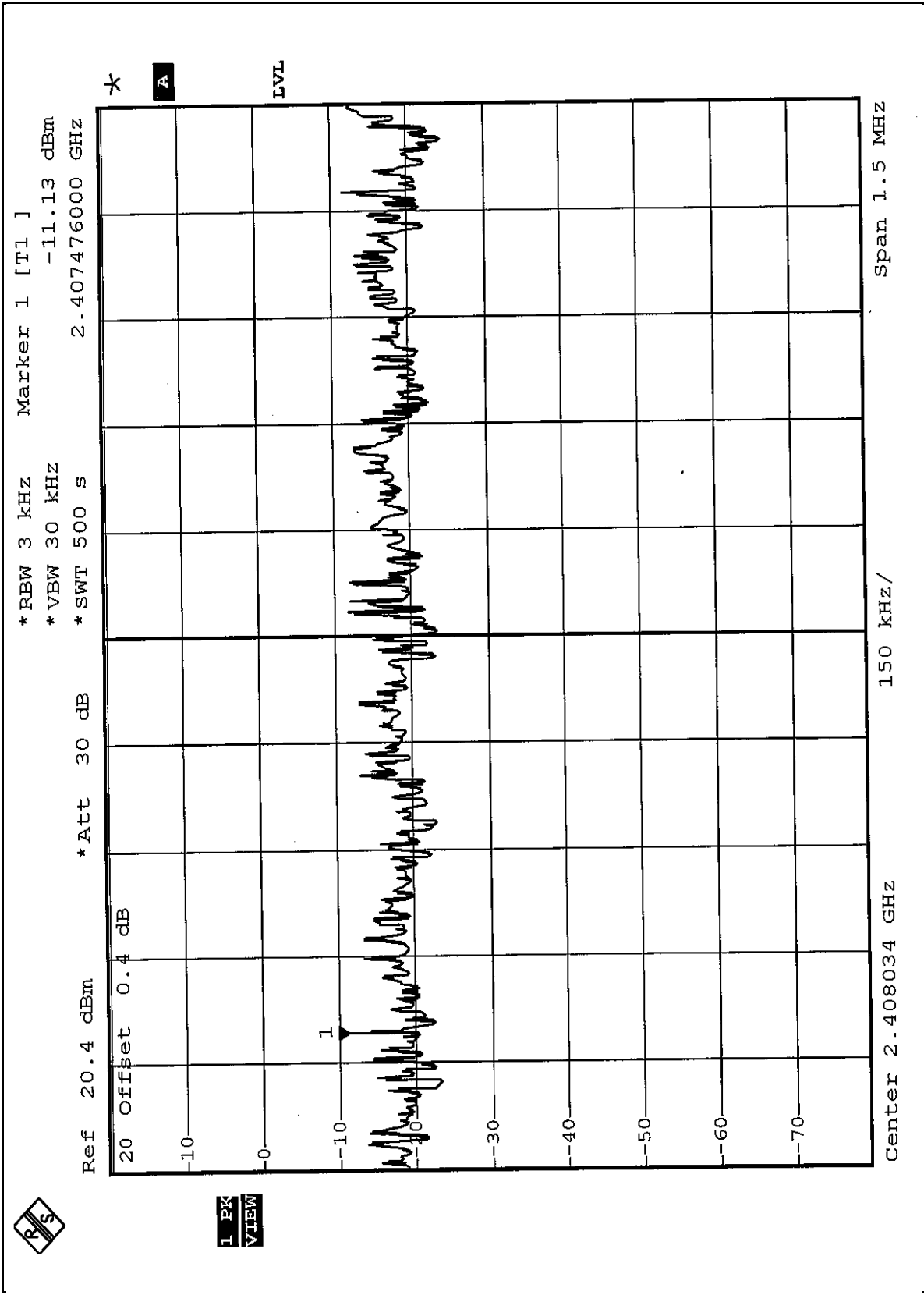



CH6

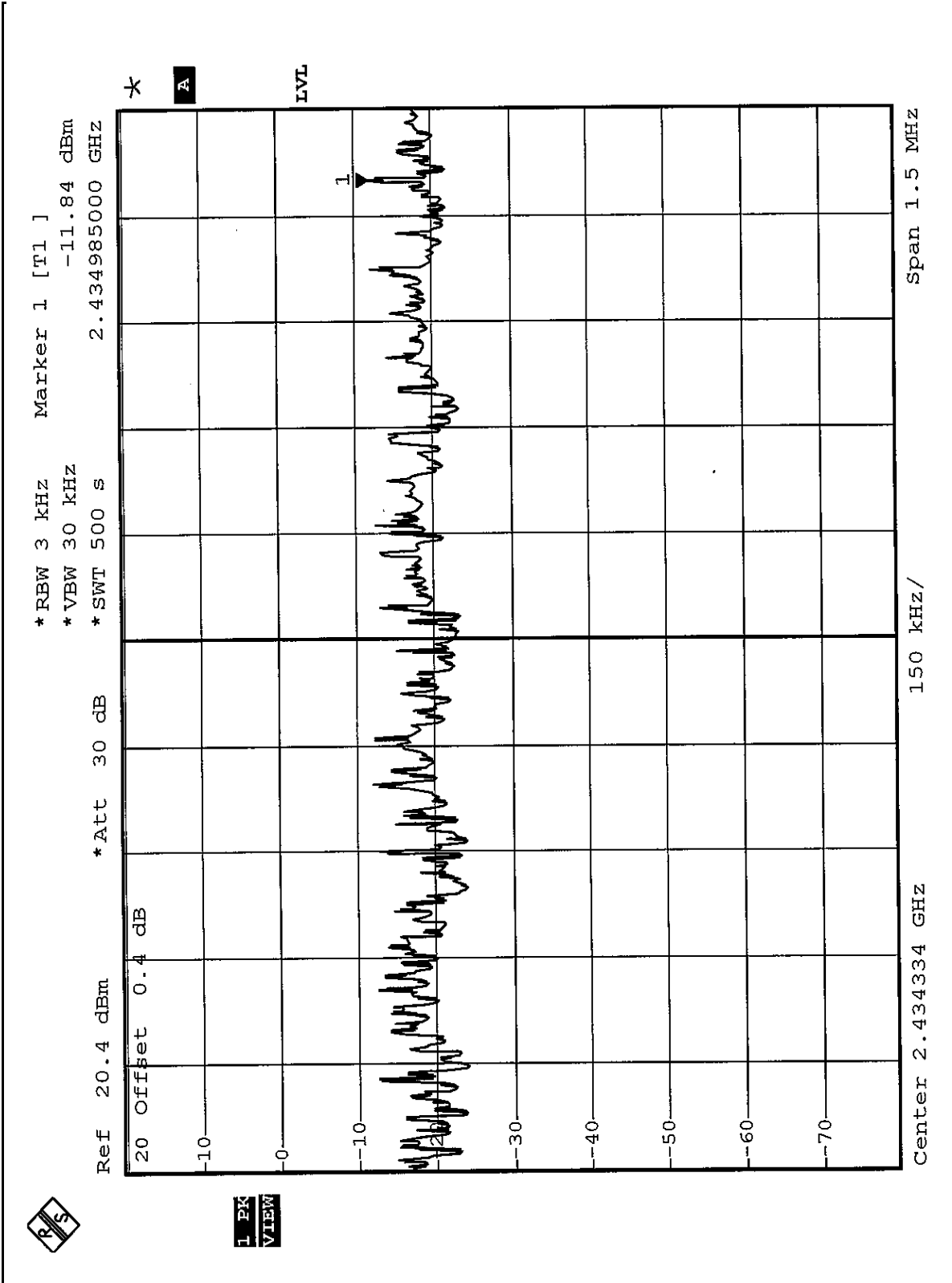



CH11

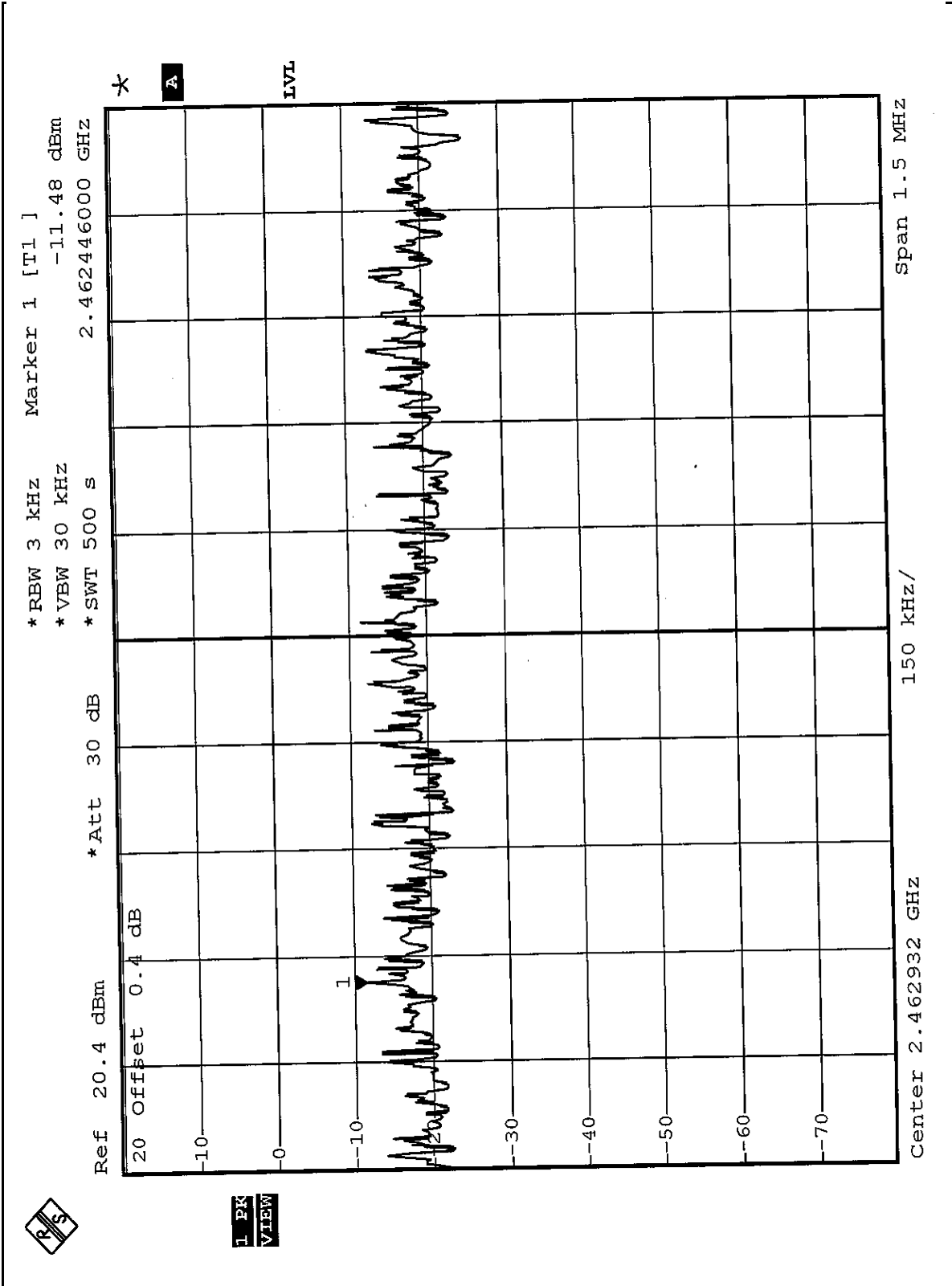



## 4.6 BAND EDGES MEASUREMENT

### 4.6.1 LIMITS OF BAND EDGES MEASUREMENT

Below -20dB of the highest emission level of operating band (in 100kHz Resolution Bandwidth).

### 4.6.2 TEST INSTRUMENTS

Description & Manufacturer	Model No.	Serial No.	Calibrated Until
SPECTRUM ANALYZER	FSEK30	100049	Aug. 12, 2004

**NOTE:** The calibration interval of the above test instruments is 12 months and the calibrations are traceable to NML/ROC and NIST/USA.

### 4.6.3 TEST PROCEDURE

The transmitter output was connected to the spectrum analyzer via a low lose cable. Set both RBW and VBW of spectrum analyzer to 1MHz and 1kHz with suitable frequency span including 100MHz bandwidth from band edge. The band edges was measured and recorded.

### 4.6.4 DEVIATION FROM TEST STANDARD

No deviation



#### 4.6.5 EUT OPERATING CONDITION

Same as Item 4.3.6

#### 4.6.6 TEST RESULTS (A)

The spectrum plots are attached on the following 4 pages. D2 line indicates the highest level, D1 line indicates the 20dB offset below D2. It shows compliance with the requirement in part 15.247(C).

**NOTE 1:**

The band edge emission plot of CCK technique on the following 1-2 pages shows 61.02dB delta between carrier maximum power and local maximum emission in restrict band (2.3900GHz). The emission of carrier strength list in the test result of channel 1 at the item 4.2.8 is 110.14dBuV/m, so the maximum field strength in restrict band is  $110.14 - 61.02 = 49.12$ dBuV/m which is under 54dBuV/m limit.

**NOTE 2:**

The band edge emission plot of CCK technique on the following 3-4 pages shows 60.59dB delta between carrier maximum power and local maximum emission in restrict band (2.4849GHz). The emission of carrier strength list in the test result of channel 11 at the item 4.2.8 is 110.91dBuV/m, so the maximum field strength in restrict band is  $110.91 - 60.59 = 50.32$ dBuV/m which is under 54dBuV/m limit.

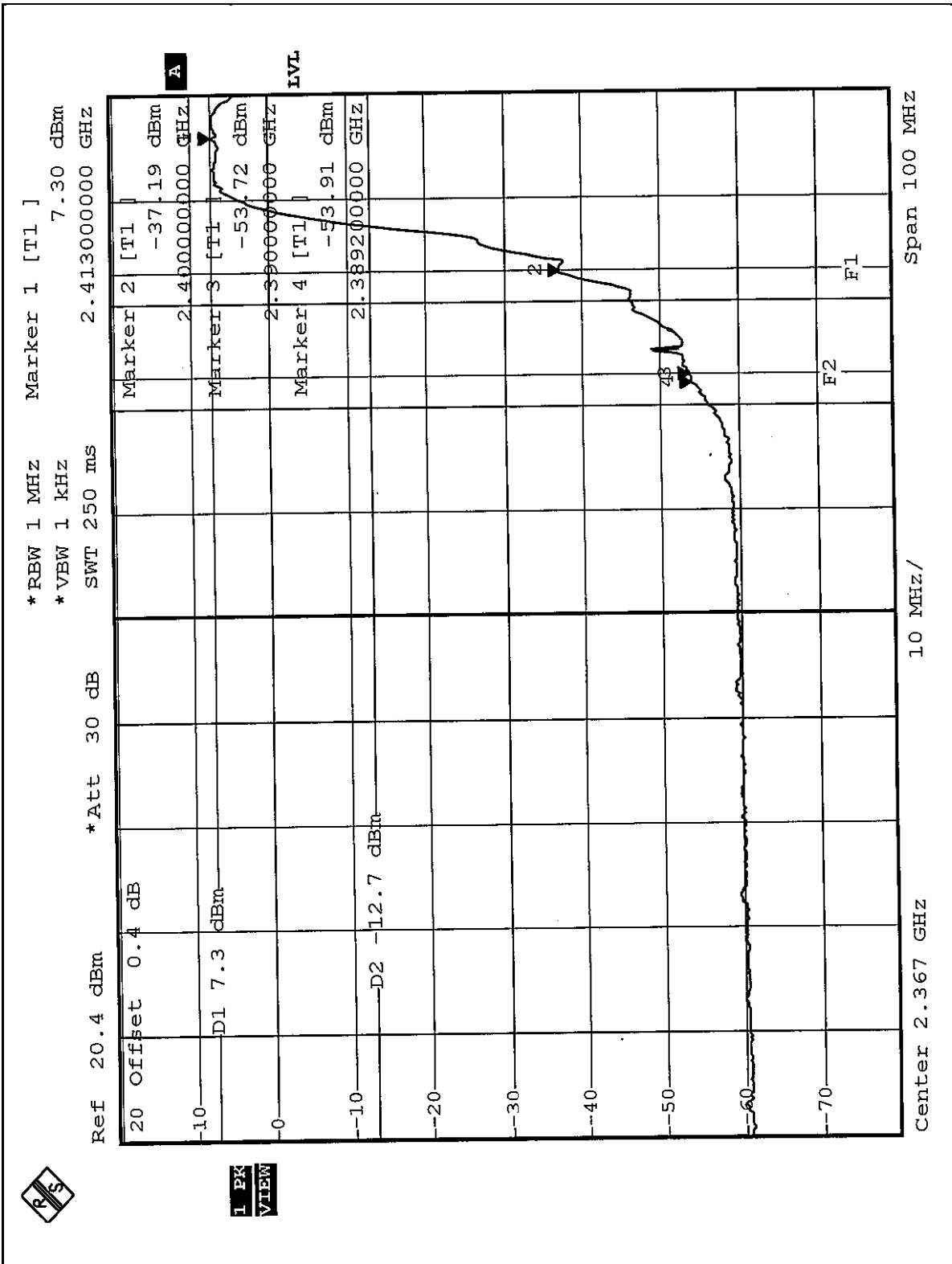



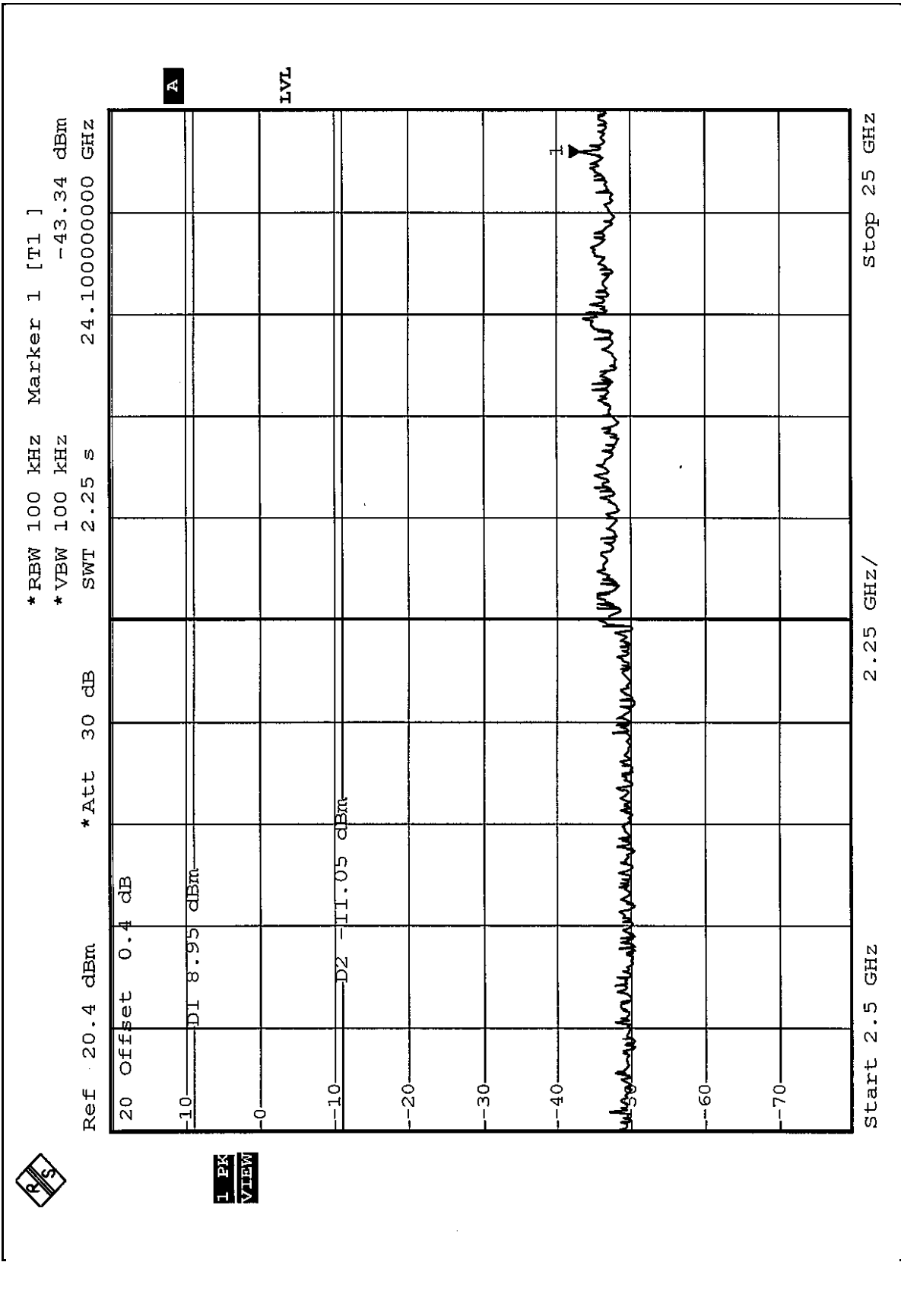



1 PK VIEW

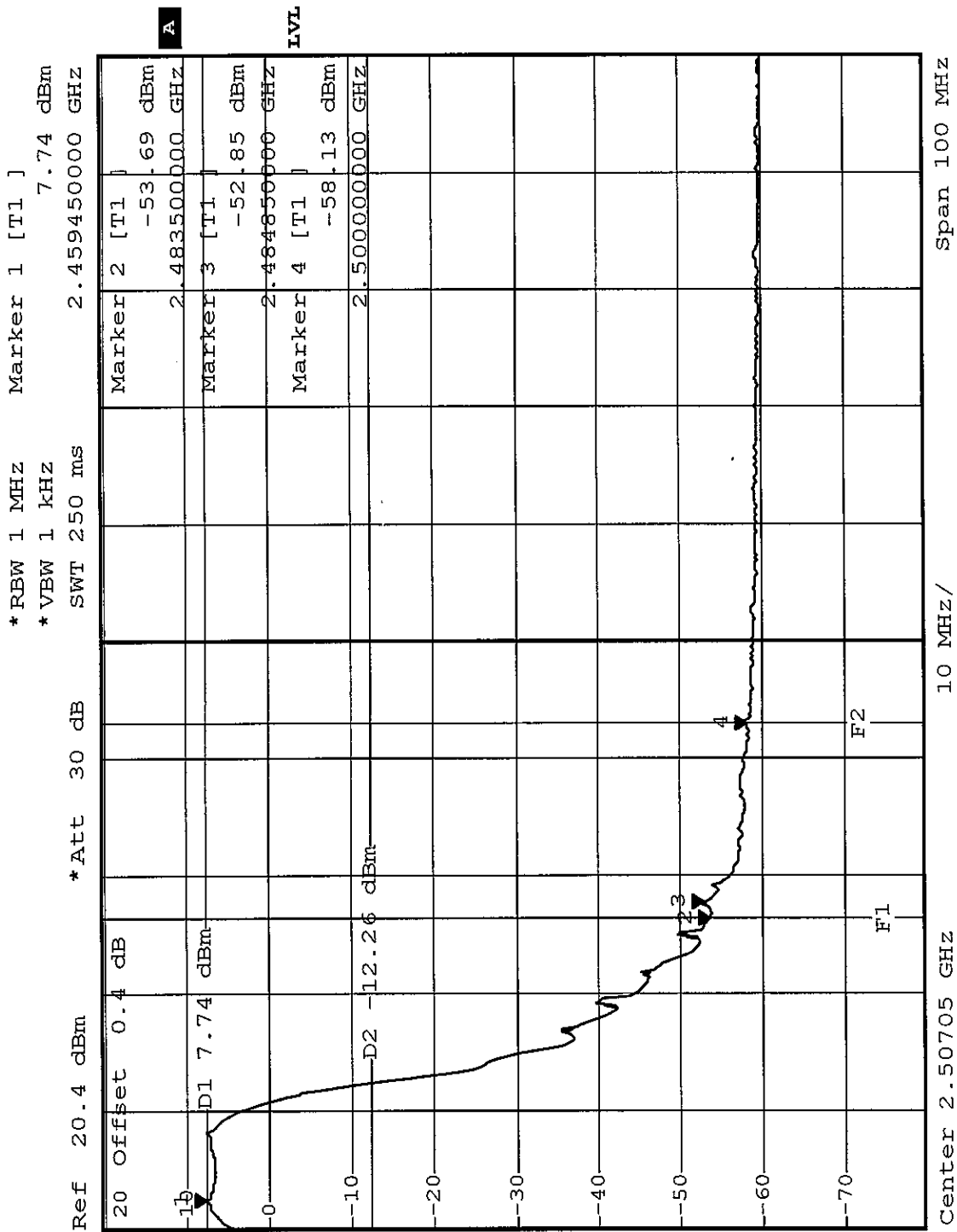

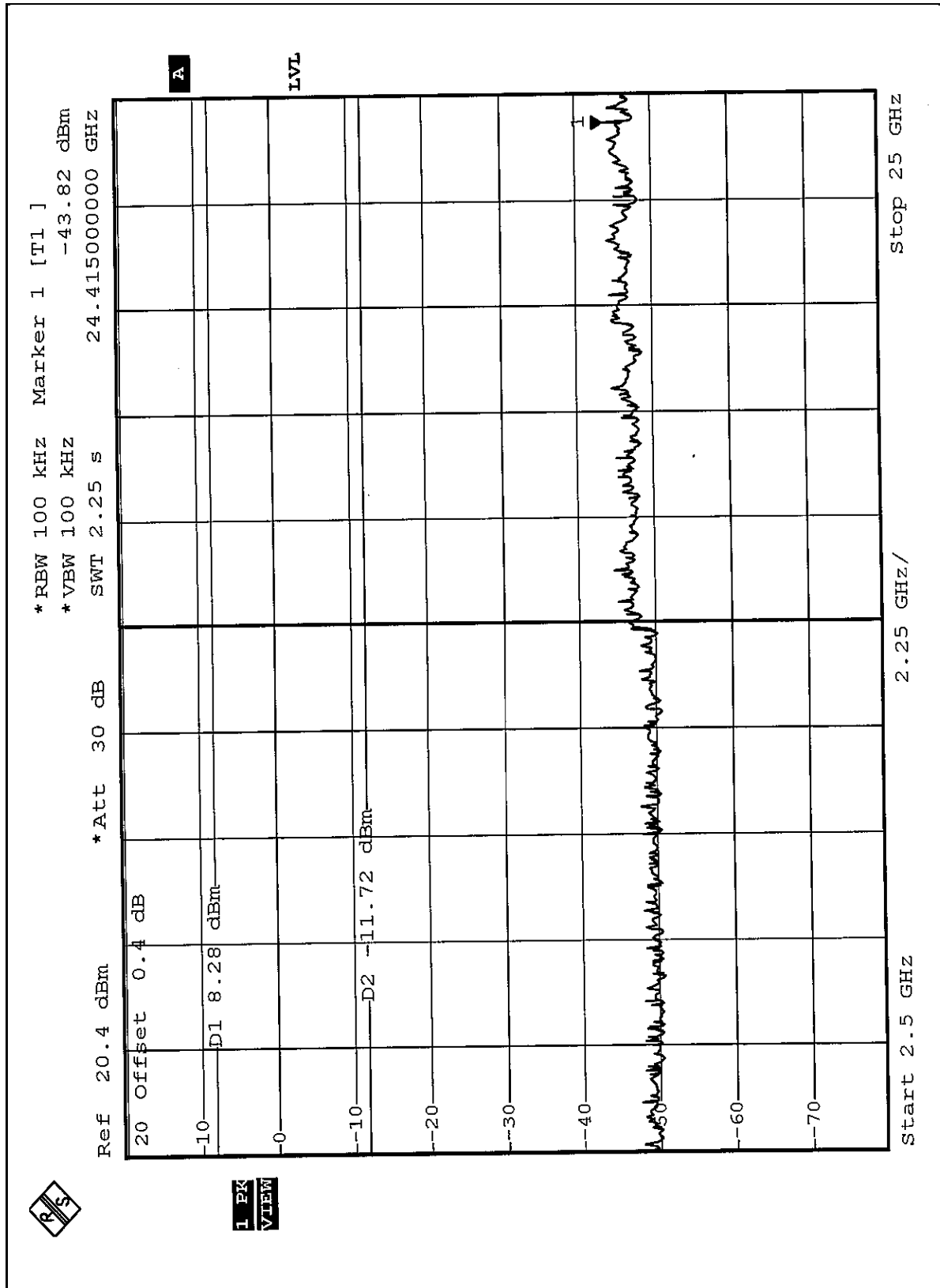



#### 4.6.7 TEST RESULTS (B)

The spectrum plots are attached on the following 4 pages. D2 line indicates the highest level, D1 line indicates the 20dB offset below D2. It shows compliance with the requirement in part 15.247(C).

**NOTE 1:**

The band edge emission plot of OFDM technique on the following 1-2 pages shows 61.54dB delta between carrier maximum power and local maximum emission in restrict band (2.3900GHz). The emission of carrier strength list in the test result of channel 1 at the item 4.2.9 is 109.51dBuV/m, so the maximum field strength in restrict band is  $109.51-61.54=47.97$ dBuV/m which is under 54dBuV/m limit.

**NOTE 2:**

The band edge emission plot of OFDM technique on the following 3-4 pages shows 60.45dB delta between carrier maximum power and local maximum emission in restrict band (2.4839GHz). The emission of carrier strength list in the test result of channel 11 at the item 4.2.9 is 110.30dBuV/m, so the maximum field strength in restrict band is  $110.30-60.45=49.85$ dBuV/m which is under 54dBuV/m limit.

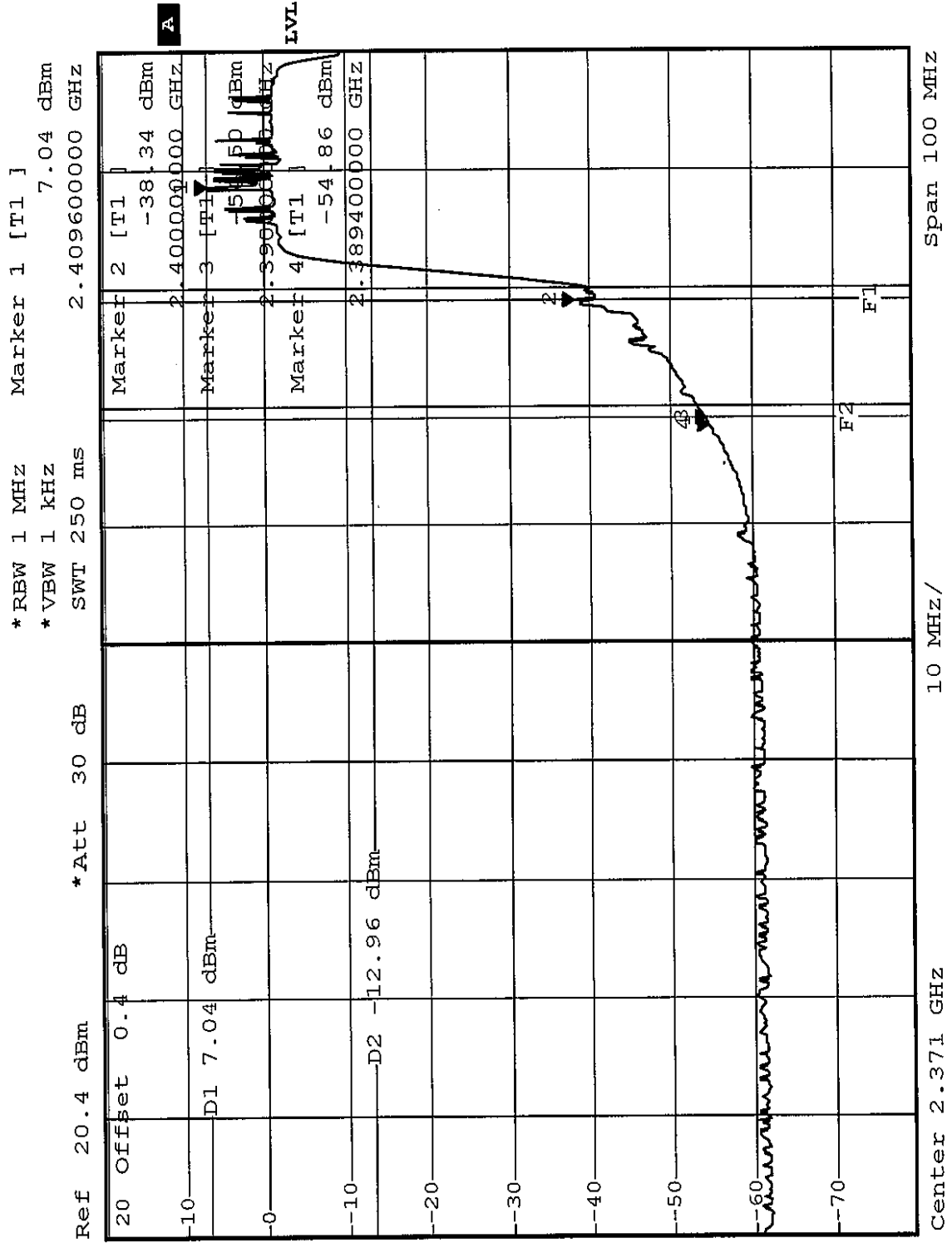

1 PK VIEW

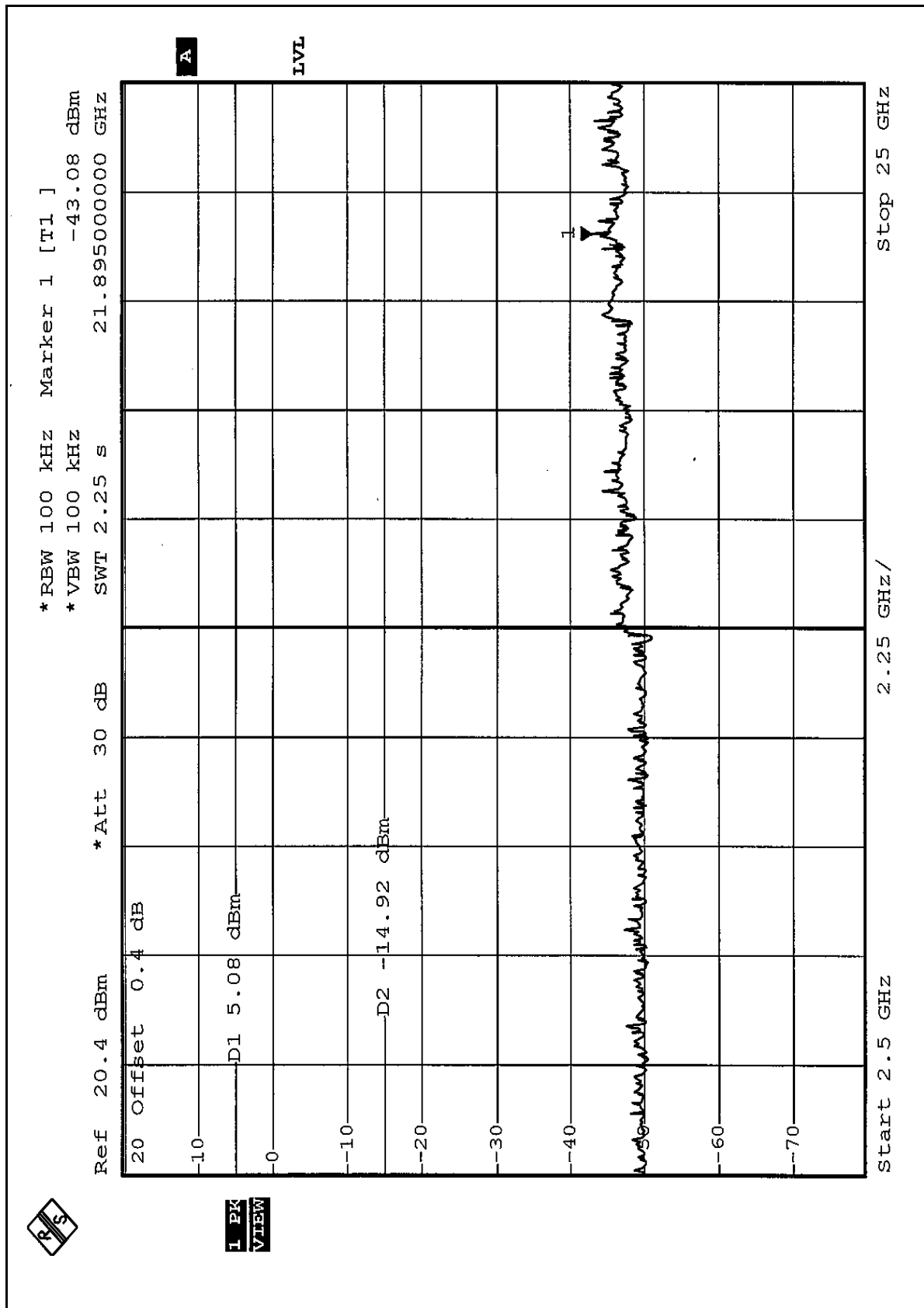

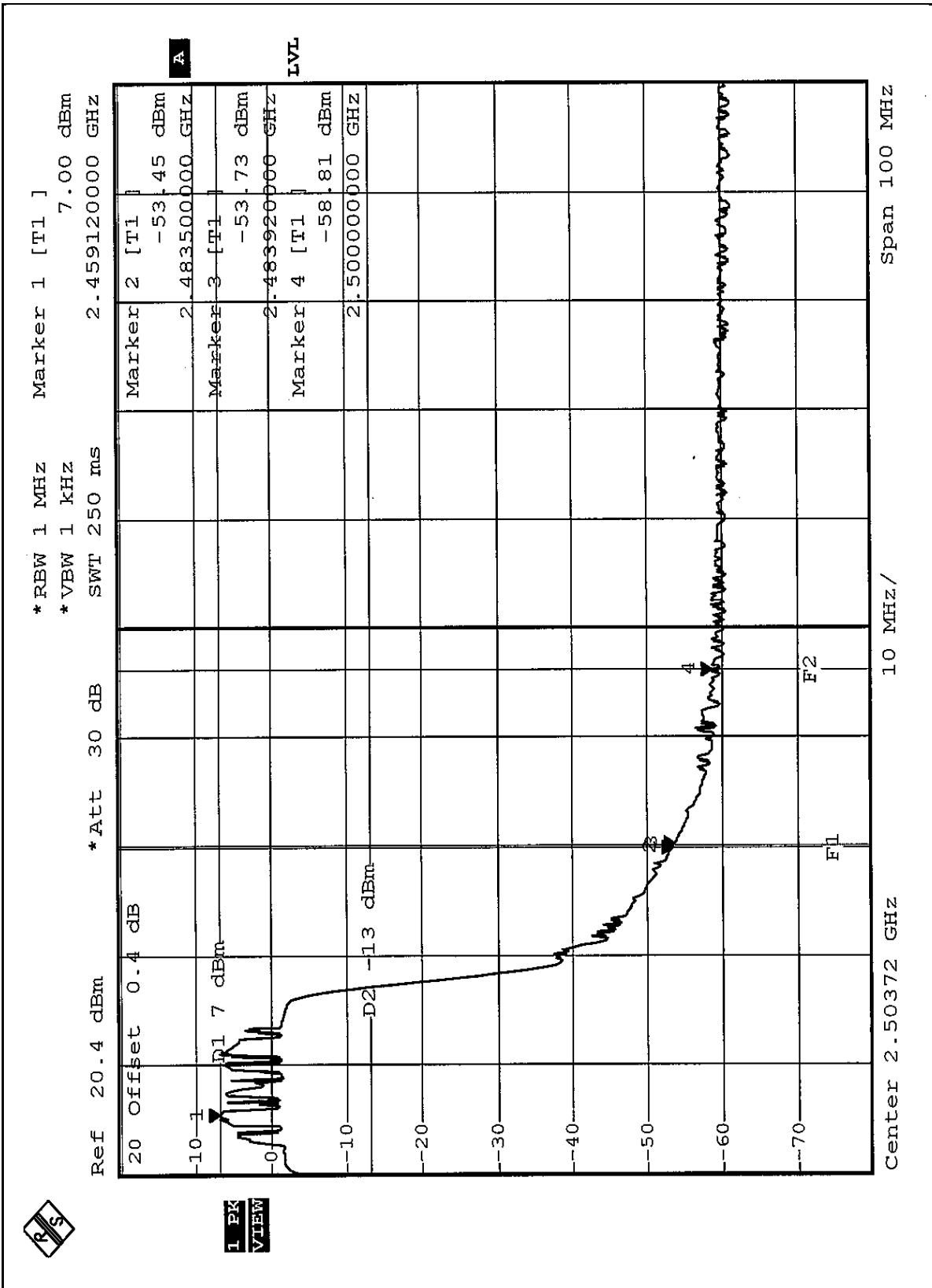

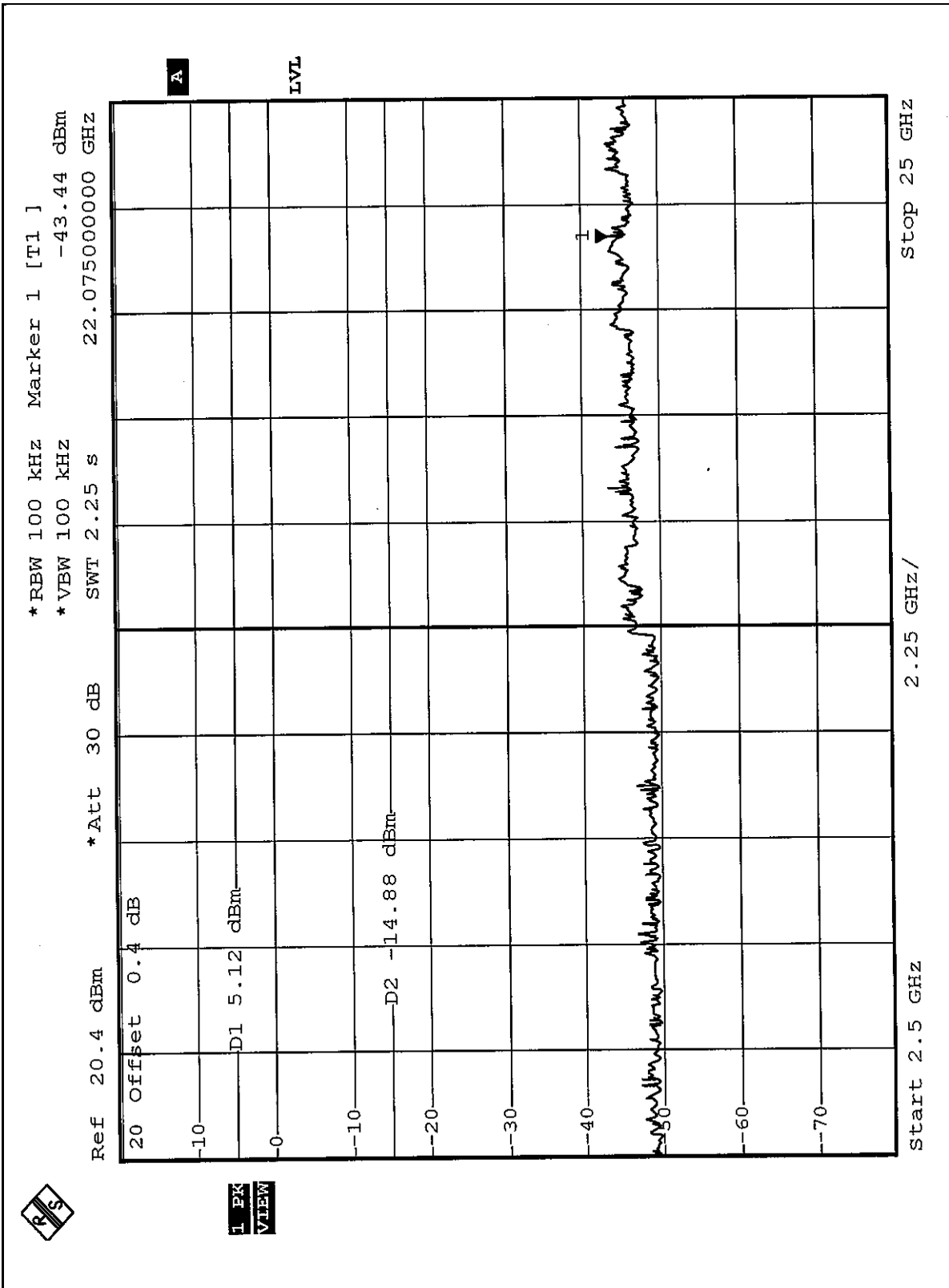





## **4.7 ANTENNA REQUIREMENT**

### **4.7.1 STANDARD APPLICABLE**

For intentional device, according to FCC 47 CFR Section 15.203, an intentional radiator shall be designed to ensure that no antenna other than that furnished by the responsible party shall be used with the device.

And according to FCC 47 CFR Section 15.247 (b), if transmitting antennas of directional gain greater than 6dBi are used, the power shall be reduced by the amount in dB that the directional gain of the antenna exceeds 6dBi.

### **4.7.2 ANTENNA CONNECTED CONSTRUCTION**

The antenna type used in this product is dipole antenna with reversed SMA antenna connector. The maximum Gain of this antenna is only 3.8dBi.

## 5 PHOTOGRAPHS OF THE TEST CONFIGURATION

### CONDUCTED EMISSION TEST

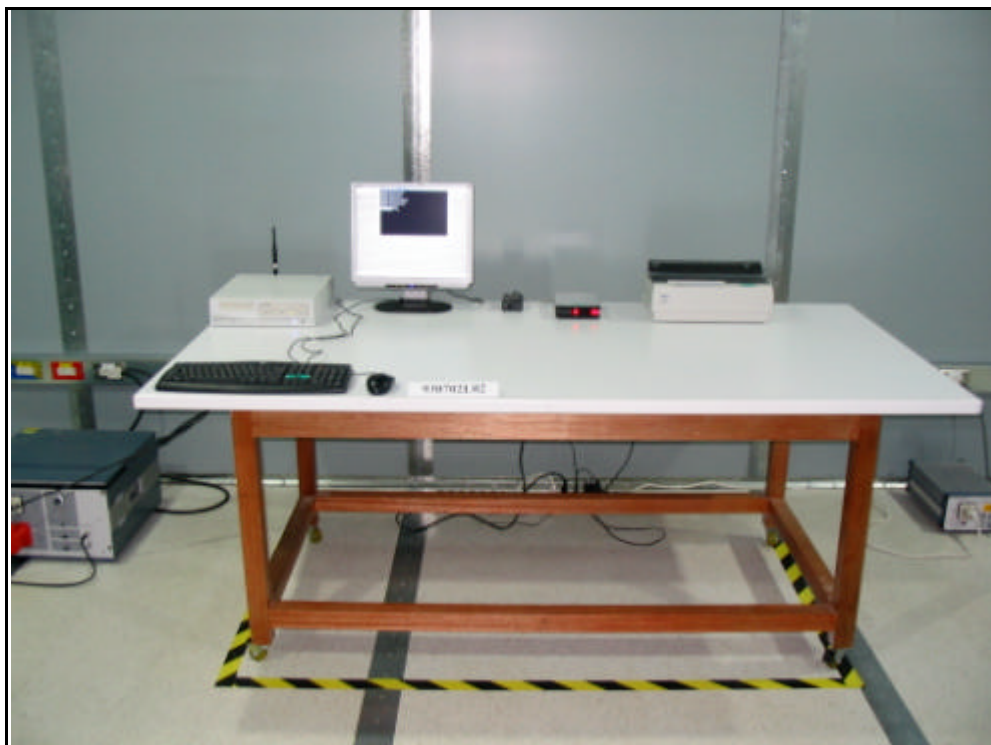

### RADIATED EMISSION TEST

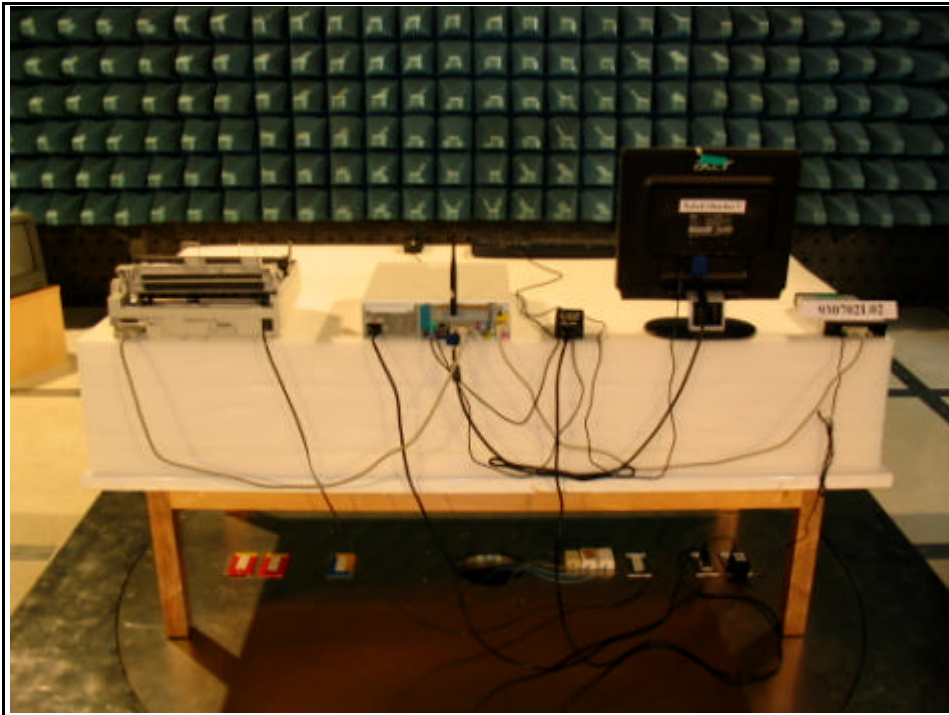



## 6 INFORMATION ON THE TESTING LABORATORIES

We, ADT Corp., were founded in 1988 to provide our best service in EMC, Radio, Telecom and Safety consultation. Our laboratories are accredited and approved by the following approval agencies according to ISO/IEC 17025, Guide 25 or EN 45001:

<b>USA</b>	FCC, NVLAP, UL
<b>Germany</b>	TUV Rheinland
<b>Japan</b>	VCCI
<b>Norway</b>	NEMKO
<b>Canada</b>	INDUSTRY CANADA , CSA
<b>R.O.C.</b>	CNLA, BSMI, DGT
<b>Netherlands</b>	Telefication
<b>Singapore</b>	PSB , GOST-ASIA(MOU)
<b>Russia</b>	CERTIS(MOU)

Copies of accreditation certificates of our laboratories obtained from approval agencies can be downloaded from our web site:

[www.adt.com.tw/index.5/phtml](http://www.adt.com.tw/index.5/phtml). If you have any comments, please feel free to contact us at the following:

**Linko EMC/RF Lab:**

Tel: 886-2-26052180

Fax: 886-2-26052943

**Hsin Chu EMC/RF Lab:**

Tel: 886-3-5935343

Fax: 886-3-5935342

**Hwa Ya EMC/RF/Safety/Telecom Lab:**

Tel: 886-3-3183232

Fax: 886-3-3185050

**Linko RF Lab.**

Tel: 886-3-3270910

Fax: 886-3-3270892

**Email:** [service@mail.adt.com.tw](mailto:service@mail.adt.com.tw)

**Web Site:** [www.adt.com.tw](http://www.adt.com.tw)

The address and road map of all our labs can be found in our web site also.

Report Format Version 1.0