



A D T

FCC TEST REPORT (15.247)

REPORT NO.: RF111114C06

MODEL NO.: HSTNN-GR01

FCC ID: MXF-HNGR01

RECEIVED: Nov. 07, 2011

TESTED: Nov. 07 ~ Nov. 24, 2011

ISSUED: Nov. 25, 2011

APPLICANT: Gemtek Technology Co., Ltd.

ADDRESS: No.15-1, Zhonghua Rd, Hsinchu Industrial Park ,
Hsinchu County, Taiwan, R.O.C.303

ISSUED BY: Bureau Veritas Consumer Products Services (H.K.)
Ltd., Taoyuan Branch

LAB ADDRESS: No. 47, 14th Ling, Chia Pau Vil., Lin Kou Dist., New
Taipei City, Taiwan (R.O.C)

TEST LOCATION: No. 19, Hwa Ya 2nd Rd, Wen Hwa Tsuen, Kwei
Shan Hsiang, Taoyuan Hsien 333, Taiwan, R.O.C.

This test report consists of 43 pages in total. It may be duplicated completely for legal use with the approval of the applicant. It should not be reproduced except in full, without the written approval of our laboratory. The client should not use it to claim product, certification, approval or endorsement by TAF or any government agency. The test results in the report only apply to the tested sample.





A D T

TABLE OF CONTENTS

RELEASE CONTROL RECORD.....	4
1. CERTIFICATION.....	5
2. SUMMARY OF TEST RESULTS	6
2.1 MEASUREMENT UNCERTAINTY.....	6
3. GENERAL INFORMATION.....	7
3.1 GENERAL DESCRIPTION OF EUT	7
3.2 DESCRIPTION OF TEST MODES	8
3.2.1 CONFIGURATION OF SYSTEM UNDER TEST	8
3.2.2 DESCRIPTION OF SUPPORT UNITS	9
3.2.3 TEST MODE APPLICABILITY AND TESTED CHANNEL DETAIL	10
3.3 GENERAL DESCRIPTION OF APPLIED STANDARDS	12
4. TEST TYPES AND RESULTS	13
4.1 RADIATED EMISSION AND BANDEDGE MEASUREMENT.....	13
4.1.1 LIMITS OF RADIATED EMISSION AND BANDEDGE MEASUREMENT	13
4.1.2 TEST INSTRUMENTS.....	14
4.1.3 TEST PROCEDURES	15
4.1.4 DEVIATION FROM TEST STANDARD.....	15
4.1.5 TEST SETUP.....	16
4.1.6 EUT OPERATING CONDITIONS	16
4.1.7 TEST RESULTS	17
4.2 CONDUCTED EMISSION MEASUREMENT	24
4.2.1 LIMITS OF CONDUCTED EMISSION MEASUREMENT	24
4.2.2 TEST INSTRUMENTS.....	24
4.2.3 TEST PROCEDURES	25
4.2.4 DEVIATION FROM TEST STANDARD.....	25
4.2.5 TEST SETUP.....	26
4.2.6 EUT OPERATING CONDITIONS	26
4.2.7 TEST RESULTS	27
4.3 6dB BANDWIDTH MEASUREMENT.....	31
4.3.1 LIMITS OF 6dB BANDWIDTH MEASUREMENT	31
4.3.2 TEST SETUP.....	31
4.3.3 TEST INSTRUMENTS.....	31
4.3.4 TEST PROCEDURE.....	31
4.3.5 DEVIATION FROM TEST STANDARD.....	31
4.3.6 EUT OPERATING CONDITIONS	31



A D T

4.3.7	TEST RESULTS	32
4.4	CONDUCTED OUTPUT POWER.....	33
4.4.1	LIMITS OF MAXIMUM OUTPUT POWER MEASUREMENT.....	33
4.4.2	TEST SETUP.....	33
4.4.3	INSTRUMENTS.....	33
4.4.4	TEST PROCEDURES	33
4.4.5	DEVIATION FROM TEST STANDARD.....	33
4.4.6	EUT OPERATING CONDITIONS	33
4.4.7	TEST RESULTS	34
4.5	POWER SPECTRAL DENSITY MEASUREMENT	35
4.5.1	LIMITS OF POWER SPECTRAL DENSITY MEASUREMENT	35
4.5.2	TEST SETUP.....	35
4.5.3	TEST INSTRUMENTS.....	35
4.5.4	TEST PROCEDURE.....	35
4.5.5	DEVIATION FROM TEST STANDARD.....	35
4.5.6	EUT OPERATING CONDITION.....	35
4.5.7	TEST RESULTS	36
4.6	CONDUCTED EMISSION MEASUREMENT	37
4.6.1	LIMITS OF CONDUCTED EMISSION MEASUREMENT	37
4.6.2	TEST SETUP.....	37
4.6.3	TEST INSTRUMENTS.....	37
4.6.4	TEST PROCEDURE.....	37
4.6.5	DEVIATION FROM TEST STANDARD.....	38
4.6.6	EUT OPERATING CONDITION.....	38
4.6.7	TEST RESULTS	38
5.	PHOTOGRAPHS OF THE TEST CONFIGURATION.....	41
6.	INFORMATION ON THE TESTING LABORATORIES	42
7.	APPENDIX A - MODIFICATIONS RECORDERS FOR ENGINEERING CHANGES TO THE EUT BY THE LAB.....	43



A D T

RELEASE CONTROL RECORD

ISSUE NO.	REASON FOR CHANGE	DATE ISSUED
Original release	NA	Nov. 25, 2011



A D T

1. CERTIFICATION

PRODUCT: Wireless TV connect

MODEL: HSTNN-GR01

BRAND: hp

APPLICANT: Gemtek Technology Co., Ltd.

TESTED: Nov. 07 ~ Nov. 24, 2011

TEST SAMPLE: ENGINEERING SAMPLE

STANDARDS: **FCC Part 15, Subpart C (Section 15.247)**

ANSI C63.4-2003

ANSI C63.10-2009

The above equipment (Model: HSTNN-GR01) has been tested by **Bureau Veritas Consumer Products Services (H.K.) Ltd., Taoyuan Branch**, and found compliance with the requirement of the above standards. The test record, data evaluation & Equipment Under Test (EUT) configurations represented herein are true and accurate accounts of the measurements of the sample's EMC characteristics under the conditions specified in this report.

PREPARED BY :  , DATE: Nov. 25, 2011
Polly Chien / Specialist

APPROVED BY :  , DATE: Nov. 25, 2011
Gary Chang / Technical Manager



2. SUMMARY OF TEST RESULTS

The EUT has been tested according to the following specifications:

APPLIED STANDARD: FCC PART 15, SUBPART C (SECTION 15.247)			
STANDARD SECTION	TEST TYPE	RESULT	REMARK
15.207	AC Power Conducted Emission	PASS	Meet the requirement of limit. Minimum passing margin is -14.16dB at 0.224MHz.
15.247(d) 15.209	Radiated Emissions	PASS	Meet the requirement of limit. Minimum passing margin is -1.0dB at 11490.00MHz
15.247(d)	Band Edge Measurement	PASS	Meet the requirement of limit.
15.247(a)(2)	6dB bandwidth	PASS	Meet the requirement of limit.
15.247(b)	Conducted power	PASS	Meet the requirement of limit.
15.247(e)	Power Spectral Density	PASS	Meet the requirement of limit.
15.203	Antenna Requirement	PASS	No antenna connector is used.

2.1 MEASUREMENT UNCERTAINTY

Where relevant, the following measurement uncertainty levels have been estimated for tests performed on the EUT as specified in CISPR 16-4-2:

MEASUREMENT	FREQUENCY	UNCERTAINTY
Conducted emissions	150kHz~30MHz	2.44 dB
Radiated emissions	30MHz ~ 200MHz	3.19 dB
	200MHz ~1000MHz	3.21 dB
	1GHz ~ 18GHz	2.26 dB
	18GHz ~ 40GHz	1.94 dB

This uncertainty represents an expanded uncertainty expressed at approximately the 95% confidence level using a coverage factor of $k = 2$.



3. GENERAL INFORMATION

3.1 GENERAL DESCRIPTION OF EUT

EUT	Wireless TV connect
MODEL NO.	HSTNN-GR01
FCC ID	MXF-HNGR01
POWER SUPPLY	5Vdc (adapter or host equipment)
MODULATION TYPE/ TECHNOLOGY	Downlink: OFDM 16-QAM Uplink: OOK
DATA RATE	100kbps
OPERATING FREQUENCY	5745 ~ 5805MHz
NUMBER OF CHANNEL	4 for Channel bandwidth (18MHz) 2 for Channel bandwidth (36MHz)
OUTPUT POWER	151.4mW
ANTENNA TYPE	Refer to note as below
ANTENNA CONNECTOR	NA
DATA CABLE	1.2m shielded HDMI cable with 2 cores
I/O PORTS	Refer to user's manual
ACCESSORY DEVICES	Adapter

NOTE:

1. The EUT consumes power from the following adapter:

BRAND:	DVE
MODEL:	DSA-12PFA-05 FUS
INPUT:	100-240Vac~, 50/60Hz, 0.5A
OUTPUT:	5Vdc, 2A
POWER LINE:	1.5m non-shielded cable without core

2. The EUT provides one completed transmitter and five receivers.

MODULATION MODE	TX FUNCTION
Channel bandwidth (18MHz)	1TX
Channel bandwidth (36MHz)	1TX

3. The frequency bands used in this EUT are listed as follows:

Frequency Band (MHz)	5180~5240	5745~5805
Channel bandwidth (18MHz)	√	√
Channel bandwidth (36MHz)	√	√

4. The EUT used the following antennas:

ITEM	ANTENNA TYPE	ANTENNA GAIN	ANTENNA CONNECTOR
Antenna 1 (RX)	Printed	2dBi	none
Antenna 2 (RX)	Printed	2dBi	none
Antenna 3 (RX)	Printed	2dBi	none
Antenna 4 (Tx/RX)	Printed	2dBi	none
Antenna 5 (RX)	Printed	2dBi	none

5. The above EUT information is declared by manufacturer and for more detailed features description, please refer to the manufacturer's specifications or user's manual.

3.2 DESCRIPTION OF TEST MODES

FOR 5.0GHz (5745 ~ 5805MHz):

4 channels are provided for channel bandwidth (18MHz):

FREQUENCY	FREQUENCY
5745MHz	5785MHz
5765MHz	5805MHz

2 channels are provided for channel bandwidth (36MHz):

FREQUENCY	FREQUENCY
5755MHz	5795MHz

3.2.1 CONFIGURATION OF SYSTEM UNDER TEST

Test Mode A

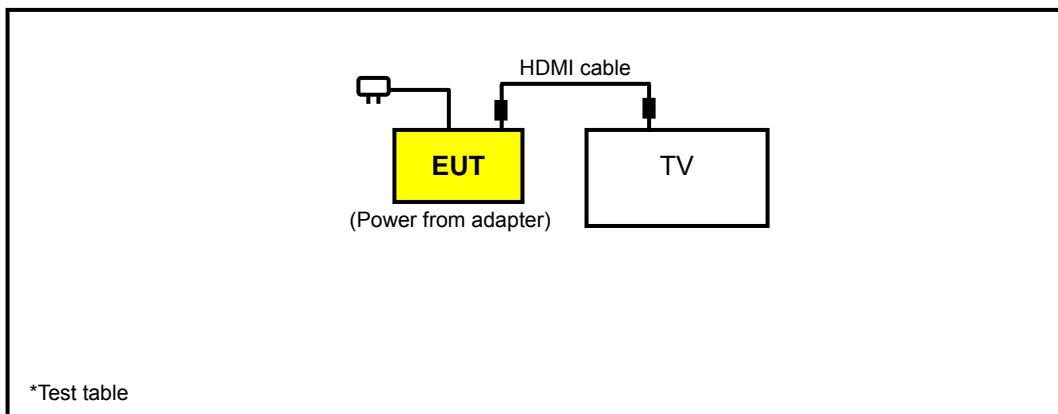

Test Mode B

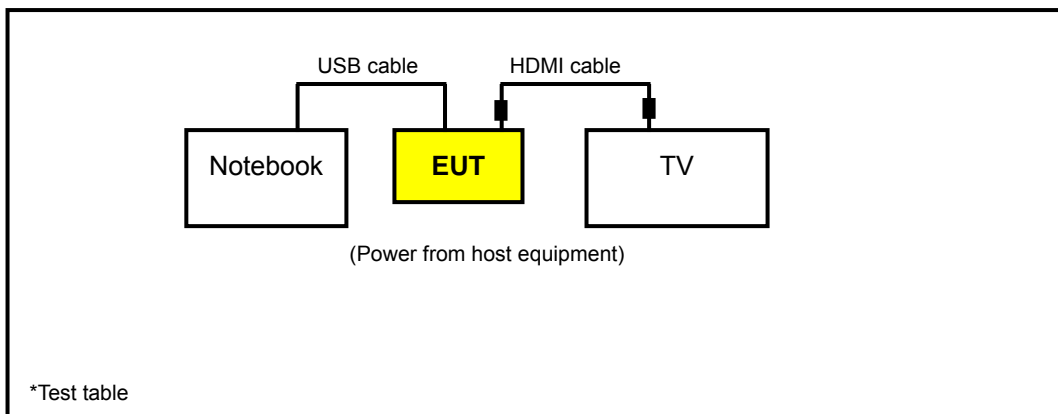



A D T

3.2.2 DESCRIPTION OF SUPPORT UNITS

The EUT has been tested as an independent unit together with other necessary accessories or support units. The following support units or accessories were used to form a representative test configuration during the tests.

NO.	PRODUCT	BRAND	MODEL NO.	SERIAL NO.	FCC ID
1	LCD TV	SANYO	SMT-32HD3	1617323K	NA
2	NOTEBOOK	DELL	D531	CN-0XM006-48643-81U-2786	QDS-BRCM1020

NO.	SIGNAL CABLE DESCRIPTION OF THE ABOVE SUPPORT UNITS
1	NA
2	0.2m shielded USB cable without core.

NOTE:

1. All power cords of the above support units are non shielded (1.8m).
2. The 0.2m USB cable was provided by the client.

3.2.3 TEST MODE APPLICABILITY AND TESTED CHANNEL DETAIL

EUT CONFIGURE MODE	APPLICABLE TO				DESCRIPTION
	RE \geq 1G	RE<1G	PLC	APCM	
A	√	√	√	√	Power from adapter
B	-	√	√	-	Power from host equipment

Where **PLC**: Power Line Conducted Emission **RE<1G**: Radiated Emission below 1GHz
RE \geq 1G: Radiated Emission above 1GHz **APCM**: Antenna Port Conducted Measurement

NOTE: "-" means no effect.

RADIATED EMISSION TEST (ABOVE 1GHz):

- Pre-Scan has been conducted to determine the worst-case mode from all possible combinations between available modulations and antenna ports (if EUT with antenna diversity architecture).
- Following channel(s) was (were) selected for the final test as listed below.

EUT CONFIGURE MODE	MODE	AVAILABLE FREQUENCY	TESTED FREQUENCY	MODULATION TYPE	DATA RATE (Kbps)
A	Channel bandwidth (18MHz)	5745 to 5805	5745, 5785, 5805	OOK	100
A	Channel bandwidth (36MHz)	5755 to 5795	5755, 5795	OOK	100

RADIATED EMISSION TEST (BELOW 1GHz):

- Pre-Scan has been conducted to determine the worst-case mode from all possible combinations between available modulations and antenna ports (if EUT with antenna diversity architecture).
- Following channel(s) was (were) selected for the final test as listed below.

EUT CONFIGURE MODE	MODE	AVAILABLE FREQUENCY	TESTED FREQUENCY	MODULATION TYPE	DATA RATE (Kbps)
A, B	Channel bandwidth (18MHz)	5745 to 5805	5805	OOK	100

POWER LINE CONDUCTED EMISSION TEST:

- Pre-Scan has been conducted to determine the worst-case mode from all possible combinations between available modulations, data rates and antenna ports (if EUT with antenna diversity architecture).
- Following channel(s) was (were) selected for the final test as listed below.

EUT CONFIGURE MODE	MODE	AVAILABLE FREQUENCY	TESTED FREQUENCY	MODULATION TYPE	DATA RATE (Kbps)
A, B	Channel bandwidth (18MHz)	5745 to 5805	5805	OOK	100



BANDEDGE MEASUREMENT:

- Pre-Scan has been conducted to determine the worst-case mode from all possible combinations between available modulations, data rates and antenna ports (if EUT with antenna diversity architecture).
- Following channel(s) was (were) selected for the final test as listed below.

EUT CONFIGUR E MODE	MODE	AVAILABLE FREQUENCY	TESTED FREQUENCY	MODULATION TYPE	DATA RATE (Kbps)
A	Channel bandwidth (18MHz)	5745 to 5805	5745, 5805	OOK	100
A	Channel bandwidth (36MHz)	5755 to 5795	5755, 5795	OOK	100

ANTENNA PORT CONDUCTED MEASUREMENT:

- Pre-Scan has been conducted to determine the worst-case mode from all possible combinations between available modulations, data rates and antenna ports (if EUT with antenna diversity architecture).
- Following channel(s) was (were) selected for the final test as listed below.

EUT CONFIGUR E MODE	MODE	AVAILABLE FREQUENCY	TESTED FREQUENCY	MODULATION TYPE	DATA RATE (Kbps)
A	Channel bandwidth (18MHz)	5745 to 5805	5745, 5785, 5805	OOK	100
A	Channel bandwidth (36MHz)	5755 to 5795	5755, 5795	OOK	100

TEST CONDITION:

APPLICABLE TO	ENVIRONMENTAL CONDITIONS	INPUT POWER (SYSTEM)	TESTED BY
RE≥1G	25deg. C, 68%RH	120Vac, 60Hz	Match Tsui
RE<1G	25deg. C, 65%RH	120Vac, 60Hz	Haru Yang, Antony Lee
PLC	25deg. C, 63%RH	120Vac, 60Hz	Scott Yang
	25deg. C, 65%RH	120Vac, 60Hz	Antony Lee
APCM	25deg. C, 68%RH	120Vac, 60Hz	Match Tsui



A D T

3.3 GENERAL DESCRIPTION OF APPLIED STANDARDS

The EUT is a RF Product. According to the specifications of the manufacturer, it must comply with the requirements of the following standards:

FCC Part 15, Subpart C (15.247)

ANSI C63.4-2003

ANSI C63.10-2009

All test items have been performed and recorded as per the above standards.

NOTE: The EUT is also considered as a kind of computer peripheral, because the connection to computer is necessary for typical use. It has been verified to comply with the requirements of FCC Part 15, Subpart B, Class B (DoC). The test report has been issued separately.



A D T

4. TEST TYPES AND RESULTS

4.1 RADIATED EMISSION AND BANDEDGE MEASUREMENT

4.1.1 LIMITS OF RADIATED EMISSION AND BANDEDGE MEASUREMENT

Radiated emissions which fall in the restricted bands, as defined in Section 15.205(a), must also comply with the radiated emission limits specified in Section 15.209(a). Other emissions shall be at least 20dB below the highest level of the desired power.

FREQUENCIES (MHz)	FIELD STRENGTH (microvolts/meter)	MEASUREMENT DISTANCE (meters)
0.009 ~ 0.490	2400/F(kHz)	300
0.490 ~ 1.705	24000/F(kHz)	30
1.705 ~ 30.0	30	30
30 ~ 88	100	3
88 ~ 216	150	3
216 ~ 960	200	3
Above 960	500	3

NOTE:

1. The lower limit shall apply at the transition frequencies.
2. Emission level (dBuV/m) = 20 log Emission level (uV/m).
3. As shown in 15.35(b), for frequencies above 1000MHz, the field strength limits are based on average detector, however, the peak field strength of any emission shall not exceed the maximum permitted average limits, specified above by more than 20dB under any condition of modulation.



A D T

4.1.2 TEST INSTRUMENTS

DESCRIPTION & MANUFACTURER	MODEL NO.	SERIAL NO.	DATE OF CALIBRATION	DUE DATE OF CALIBRATION
Test Receiver ROHDE & SCHWARZ	ESI7	838496/016	Dec. 27, 2010	Dec. 26, 2011
Spectrum Analyzer ROHDE & SCHWARZ	FSP40	100039	Feb. 23, 2011	Feb. 22, 2012
BILOG Antenna SCHWARZBECK	VULB9168	9168-155	Apr. 12, 2011	Apr. 11, 2012
HORN Antenna SCHWARZBECK	BBHA 9120D	9120D-408	Jan. 06, 2011	Jan. 05, 2012
HORN Antenna SCHWARZBECK	BBHA 9170	BBHA9170243	Dec. 27, 2010	Dec. 26, 2011
Preamplifier Agilent	8449B	3008A01961	Oct. 29, 2011	Oct. 28, 2012
Preamplifier Agilent	8447D	2944A10738	Oct. 29, 2011	Oct. 28, 2012
RF signal cable HUBER+SUHNNER	SUCOFLEX 104	250792/4	Aug. 19, 2011	Aug. 18, 2012
RF signal cable HUBER+SUHNNER	SUCOFLEX 104	283397/4	Aug. 19, 2011	Aug. 18, 2012
RF signal cable HUBER+SUHNNER	SUCOFLEX 104	295012/4	Aug. 19, 2011	Aug. 18, 2012
Software ADT.	ADT_Radiated_ V7.6.15.9.2	NA	NA	NA
Antenna Tower inn-co GmbH	MA 4000	010303	NA	NA
Antenna Tower Controller inn-co GmbH	CO2000	019303	NA	NA
Turn Table ADT.	TT100.	TT93021704	NA	NA
Turn Table Controller ADT.	SC100.	SC93021704	NA	NA
26GHz ~ 40GHz Amplifier	EM26400	815221	Oct. 29, 2011	Oct. 28, 2012
High Speed Peak Power Meter	ML2495A	0842014	Apr. 26, 2011	Apr. 25, 2012
Power Sensor	MA2411B	0738404	Apr. 26, 2011	Apr. 25, 2012

- NOTE:** 1. The calibration interval of the above test instruments is 12 months and the calibrations are traceable to NML/ROC and NIST/USA.
2. The test was performed in HwaYa Chamber 4.
3. The horn antenna and HP preamplifier (model: 8449B) are used only for the measurement of emission frequency above 1GHz if tested.
4. The FCC Site Registration No. is 460141.
5. The IC Site Registration No. is IC7450F-4.



4.1.3 TEST PROCEDURES

- a. The EUT was placed on the top of a rotating table 0.8 meters above the ground at a 3 meters semi-anechoic chamber. The table was rotated 360 degrees to determine the position of the highest radiation.
- b. The EUT was set 3 meters away from the interference-receiving antenna, which was mounted on the top of a variable-height antenna tower.
- c. The antenna is a broadband antenna, and its height is varied from one meter to four meters above the ground to determine the maximum value of the field strength. Both horizontal and vertical polarizations of the antenna are set to make the measurement.
- d. For each suspected emission, the EUT was arranged to its worst case and then the antenna was tuned to heights from 1 meter to 4 meters and the rotatable table was turned from 0 degrees to 360 degrees to find the maximum reading.
- e. The test-receiver system was set to Peak Detect Function and Specified Bandwidth with Maximum Hold Mode.
- f. If the emission level of the EUT in peak mode was lower than the limit specified, then testing could be stopped and the peak values of the EUT would be reported. Otherwise the emissions would be re-tested one by one using peak, quasi-peak or average method as specified and then reported in a data sheet.

NOTE:

1. The resolution bandwidth and video bandwidth of test receiver/spectrum analyzer is 120kHz for Quasi-peak detection at frequency below 1GHz.
2. The resolution bandwidth of test receiver/spectrum analyzer is 100kHz and video bandwidth is 300kHz for Peak detection at frequency above 1GHz.
3. The resolution bandwidth of test receiver/spectrum analyzer is 1MHz and the video bandwidth is 1kHz for Average detection (AV) at frequency above 1GHz.
4. All modes of operation were investigated and the worst-case emissions are reported.

4.1.4 DEVIATION FROM TEST STANDARD

No deviation.

4.1.5 TEST SETUP

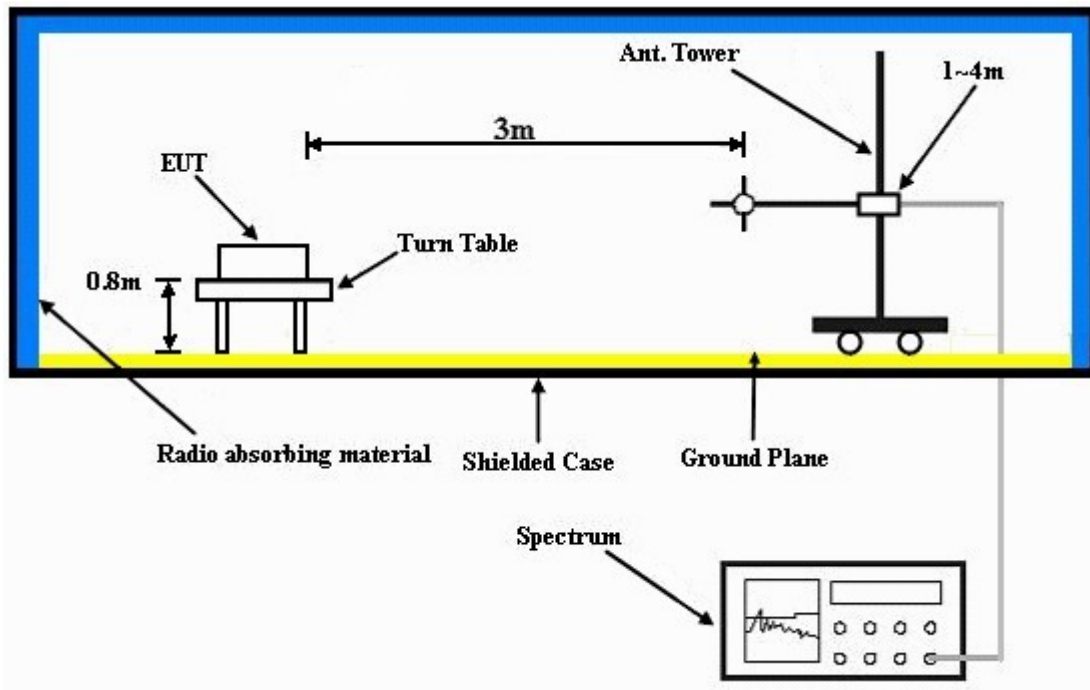

For the actual test configuration, please refer to the attached file (Test Setup Photo).

4.1.6 EUT OPERATING CONDITIONS

- a. Connected the EUT with TV via HDMI cable and placed on a testing table.
- b. Set the EUT under transmitting condition continuously at specific channel frequency.



A D T

4.1.7 TEST RESULTS

Channel bandwidth (18MHz)

EUT TEST CONDITION		MEASUREMENT DETAIL	
TESTED FREQUENCY	5745MHz	FREQUENCY RANGE	1 ~ 40GHz
INPUT POWER	120Vac, 60 Hz	DETECTOR FUNCTION	Peak (PK) Average (AV)
ENVIRONMENTAL CONDITIONS	25deg. C, 68%RH	TESTED BY	Match Tsui

ANTENNA POLARITY & TEST DISTANCE: HORIZONTAL AT 3 M								
NO.	FREQ. (MHz)	EMISSION LEVEL (dBuV/m)	LIMIT (dBuV/m)	MARGIN (dB)	ANTENNA HEIGHT (m)	TABLE ANGLE (Degree)	RAW VALUE (dBuV)	CORRECTION FACTOR (dB/m)
1	#5725.00	59.0 PK	86.4	-27.4	1.33 H	304	19.60	39.40
2	#5725.00	39.2 AV	73.3	-34.1	1.33 H	304	-0.20	39.40
3	*5745.00	106.4 PK			1.33 H	304	66.90	39.50
4	*5745.00	93.3 AV			1.33 H	304	53.80	39.50
5	11490.00	67.5 PK	74.0	-6.5	1.25 H	304	17.80	49.70
6	11490.00	53.0 AV	54.0	-1.0	1.25 H	304	3.30	49.70
ANTENNA POLARITY & TEST DISTANCE: VERTICAL AT 3 M								
NO.	FREQ. (MHz)	EMISSION LEVEL (dBuV/m)	LIMIT (dBuV/m)	MARGIN (dB)	ANTENNA HEIGHT (m)	TABLE ANGLE (Degree)	RAW VALUE (dBuV)	CORRECTION FACTOR (dB/m)
1	#5725.00	56.1 PK	80.8	-24.7	1.00 V	269	16.70	39.40
2	#5725.00	36.5 AV	68.0	-31.5	1.00 V	269	-2.90	39.40
3	*5745.00	100.8 PK			1.00 V	269	61.30	39.50
4	*5745.00	88.0 AV			1.00 V	269	48.50	39.50
5	11490.00	64.8 PK	74.0	-9.2	1.32 V	2	15.10	49.70
6	11490.00	51.5 AV	54.0	-2.5	1.32 V	2	1.80	49.70

- REMARKS:**
1. Emission level (dBuV/m) = Raw Value (dBuV) + Correction Factor (dB/m).
 2. Correction Factor (dB/m) = Antenna Factor (dB/m) + Cable Factor (dB).
 3. The other emission levels were very low against the limit.
 4. Margin value = Emission level – Limit value.
 5. “ * “: Fundamental frequency.
 6. The limit value is defined as per 15.247.
 7. "#":The radiated frequency is out the restricted band.



A D T

EUT TEST CONDITION		MEASUREMENT DETAIL	
TESTED FREQUENCY	5785MHz	FREQUENCY RANGE	1 ~ 40GHz
INPUT POWER	120Vac, 60 Hz	DETECTOR FUNCTION	Peak (PK) Average (AV)
ENVIRONMENTAL CONDITIONS	25deg. C, 68%RH	TESTED BY	Match Tsui

ANTENNA POLARITY & TEST DISTANCE: HORIZONTAL AT 3 M								
NO.	FREQ. (MHz)	EMISSION LEVEL (dBuV/m)	LIMIT (dBuV/m)	MARGIN (dB)	ANTENNA HEIGHT (m)	TABLE ANGLE (Degree)	RAW VALUE (dBuV)	CORRECTION FACTOR (dB/m)
1	#5725.00	46.7 PK	86.3	-39.6	1.32 H	297	7.30	39.40
2	#5725.00	34.5 AV	74.1	-39.6	1.32 H	297	-4.90	39.40
3	*5785.00	106.3 PK			1.32 H	297	66.70	39.60
4	*5785.00	94.1 AV			1.32 H	297	54.50	39.60
5	11570.00	65.3 PK	74.0	-8.7	1.25 H	307	15.80	49.50
6	11570.00	51.9 AV	54.0	-2.1	1.25 H	307	2.40	49.50
ANTENNA POLARITY & TEST DISTANCE: VERTICAL AT 3 M								
NO.	FREQ. (MHz)	EMISSION LEVEL (dBuV/m)	LIMIT (dBuV/m)	MARGIN (dB)	ANTENNA HEIGHT (m)	TABLE ANGLE (Degree)	RAW VALUE (dBuV)	CORRECTION FACTOR (dB/m)
1	#5725.00	45.1 PK	80.1	-35.0	1.00 V	180	5.70	39.40
2	#5725.00	33.8 AV	67.9	-34.1	1.00 V	180	-5.60	39.40
3	*5785.00	100.1 PK			1.00 V	180	60.50	39.60
4	*5785.00	87.9 AV			1.00 V	180	48.30	39.60
5	11570.00	63.2 PK	74.0	-10.8	1.37 V	9	13.70	49.50
6	11570.00	50.8 AV	54.0	-3.2	1.37 V	9	1.30	49.50

- REMARKS:**
1. Emission level (dBuV/m) = Raw Value (dBuV) + Correction Factor (dB/m).
 2. Correction Factor (dB/m) = Antenna Factor (dB/m) + Cable Factor (dB).
 3. The other emission levels were very low against the limit.
 4. Margin value = Emission level – Limit value.
 5. “ * “: Fundamental frequency.
 6. The limit value is defined as per 15.247.
 7. "#":The radiated frequency is out the restricted band.



A D T

EUT TEST CONDITION		MEASUREMENT DETAIL	
TESTED FREQUENCY	5805MHz	FREQUENCY RANGE	1 ~ 40GHz
INPUT POWER	120Vac, 60 Hz	DETECTOR FUNCTION	Peak (PK) Average (AV)
ENVIRONMENTAL CONDITIONS	25deg. C, 68%RH	TESTED BY	Match Tsui

ANTENNA POLARITY & TEST DISTANCE: HORIZONTAL AT 3 M								
NO.	FREQ. (MHz)	EMISSION LEVEL (dBuV/m)	LIMIT (dBuV/m)	MARGIN (dB)	ANTENNA HEIGHT (m)	TABLE ANGLE (Degree)	RAW VALUE (dBuV)	CORRECTION FACTOR (dB/m)
1	*5805.00	106.1 PK			1.32 H	295	66.50	39.60
2	*5805.00	93.2 AV			1.32 H	295	53.60	39.60
3	5850.00	47.9 PK	74.0	-26.1	1.32 H	295	8.20	39.70
4	5850.00	35.0 AV	54.0	-19.0	1.32 H	295	-4.70	39.70
5	11610.00	64.4 PK	74.0	-9.6	1.20 H	310	15.00	49.40
6	11610.00	52.0 AV	54.0	-2.0	1.20 H	310	2.60	49.40
ANTENNA POLARITY & TEST DISTANCE: VERTICAL AT 3 M								
NO.	FREQ. (MHz)	EMISSION LEVEL (dBuV/m)	LIMIT (dBuV/m)	MARGIN (dB)	ANTENNA HEIGHT (m)	TABLE ANGLE (Degree)	RAW VALUE (dBuV)	CORRECTION FACTOR (dB/m)
1	*5805.00	100.1 PK			1.00 V	267	60.50	39.60
2	*5805.00	87.7 AV			1.00 V	267	48.10	39.60
3	5850.00	45.0 PK	74.0	-29.0	1.00 V	267	5.30	39.70
4	5850.00	33.4 AV	54.0	-20.6	1.00 V	267	-6.30	39.70
5	11610.00	64.3 PK	74.0	-9.7	1.36 V	9	14.90	49.40
6	11610.00	50.7 AV	54.0	-3.3	1.36 V	9	1.30	49.40

- REMARKS:**
1. Emission level (dBuV/m) = Raw Value (dBuV) + Correction Factor (dB/m).
 2. Correction Factor (dB/m) = Antenna Factor (dB/m) + Cable Factor (dB).
 3. The other emission levels were very low against the limit.
 4. Margin value = Emission level – Limit value.
 5. “ * “: Fundamental frequency.
 6. The limit value is defined as per 15.247.



A D T

Channel bandwidth (36MHz)

EUT TEST CONDITION		MEASUREMENT DETAIL	
TESTED FREQUENCY	5755MHz	FREQUENCY RANGE	1 ~ 40GHz
INPUT POWER	120Vac, 60 Hz	DETECTOR FUNCTION	Peak (PK) Average (AV)
ENVIRONMENTAL CONDITIONS	25deg. C, 68%RH	TESTED BY	Match Tsui

ANTENNA POLARITY & TEST DISTANCE: HORIZONTAL AT 3 M								
NO.	FREQ. (MHz)	EMISSION LEVEL (dBuV/m)	LIMIT (dBuV/m)	MARGIN (dB)	ANTENNA HEIGHT (m)	TABLE ANGLE (Degree)	RAW VALUE (dBuV)	CORRECTION FACTOR (dB/m)
1	#5725.00	69.2 PK	82.8	-13.6	1.35 H	313	29.80	39.40
2	#5725.00	45.6 AV	70.8	-25.2	1.35 H	313	6.20	39.40
3	*5755.00	102.8 PK			1.35 H	313	63.30	39.50
4	*5755.00	90.8 AV			1.35 H	313	51.30	39.50
5	11510.00	63.9 PK	74.0	-10.1	1.24 H	311	14.30	49.60
6	11510.00	50.9 AV	54.0	-3.1	1.24 H	311	1.30	49.60

ANTENNA POLARITY & TEST DISTANCE: VERTICAL AT 3 M								
NO.	FREQ. (MHz)	EMISSION LEVEL (dBuV/m)	LIMIT (dBuV/m)	MARGIN (dB)	ANTENNA HEIGHT (m)	TABLE ANGLE (Degree)	RAW VALUE (dBuV)	CORRECTION FACTOR (dB/m)
1	#5725.00	61.6 PK	77.5	-15.9	1.00 V	269	22.20	39.40
2	#5725.00	40.6 AV	65.0	-24.4	1.00 V	269	1.20	39.40
3	*5755.00	97.5 PK			1.00 V	269	58.00	39.50
4	*5755.00	85.0 AV			1.00 V	269	45.50	39.50
5	11510.00	61.7 PK	74.0	-12.3	1.37 V	10	12.10	49.60
6	11510.00	51.3 AV	54.0	-2.7	1.37 V	10	1.70	49.60

- REMARKS:**
1. Emission level (dBuV/m) = Raw Value (dBuV) + Correction Factor (dB/m).
 2. Correction Factor (dB/m) = Antenna Factor (dB/m) + Cable Factor (dB).
 3. The other emission levels were very low against the limit.
 4. Margin value = Emission level – Limit value.
 5. “ * “: Fundamental frequency.
 6. The limit value is defined as per 15.247.
 7. "#":The radiated frequency is out the restricted band.



A D T

EUT TEST CONDITION		MEASUREMENT DETAIL	
TESTED FREQUENCY	5795MHz	FREQUENCY RANGE	1 ~ 40GHz
INPUT POWER	120Vac, 60 Hz	DETECTOR FUNCTION	Peak (PK) Average (AV)
ENVIRONMENTAL CONDITIONS	25deg. C, 68%RH	TESTED BY	Match Tsui

ANTENNA POLARITY & TEST DISTANCE: HORIZONTAL AT 3 M								
NO.	FREQ. (MHz)	EMISSION LEVEL (dBuV/m)	LIMIT (dBuV/m)	MARGIN (dB)	ANTENNA HEIGHT (m)	TABLE ANGLE (Degree)	RAW VALUE (dBuV)	CORRECTION FACTOR (dB/m)
1	*5795.00	103.7 PK			1.35 H	313	64.10	39.60
2	*5795.00	90.9 AV			1.35 H	313	51.30	39.60
3	#5850.00	52.0 PK	83.7	-31.7	1.35 H	313	12.30	39.70
4	#5850.00	35.1 AV	70.9	-35.8	1.35 H	313	-4.60	39.70
5	11590.00	62.2 PK	74.0	-11.8	1.20 H	313	12.70	49.50
6	11590.00	51.5 AV	54.0	-2.5	1.20 H	313	2.00	49.50
ANTENNA POLARITY & TEST DISTANCE: VERTICAL AT 3 M								
NO.	FREQ. (MHz)	EMISSION LEVEL (dBuV/m)	LIMIT (dBuV/m)	MARGIN (dB)	ANTENNA HEIGHT (m)	TABLE ANGLE (Degree)	RAW VALUE (dBuV)	CORRECTION FACTOR (dB/m)
1	*5795.00	97.8 PK			1.00 V	178	58.20	39.60
2	*5795.00	84.9 AV			1.00 V	178	45.30	39.60
3	#5850.00	46.4 PK	77.8	-31.4	1.00 V	178	6.70	39.70
4	#5850.00	33.6 AV	64.9	-31.3	1.00 V	178	-6.10	39.70
5	11590.00	62.7 PK	74.0	-11.3	1.36 V	12	13.20	49.50
6	11590.00	51.7 AV	54.0	-2.3	1.36 V	12	2.20	49.50

- REMARKS:**
1. Emission level (dBuV/m) = Raw Value (dBuV) + Correction Factor (dB/m).
 2. Correction Factor (dB/m) = Antenna Factor (dB/m) + Cable Factor (dB).
 3. The other emission levels were very low against the limit.
 4. Margin value = Emission level – Limit value.
 5. “ * “: Fundamental frequency.
 6. The limit value is defined as per 15.247.
 7. "#":The radiated frequency is out the restricted band.



A D T

BELOW 1GHz WORST-CASE DATA : Channel bandwidth (18MHz)

EUT TEST CONDITION		MEASUREMENT DETAIL	
TESTED FREQUENCY	5805MHz	FREQUENCY RANGE	Below 1000MHz
INPUT POWER	120Vac, 60 Hz	DETECTOR FUNCTION	Quasi-Peak
ENVIRONMENTAL CONDITIONS	25deg. C, 65%RH	TESTED BY	Haru Yang
TEST MODE	A		

ANTENNA POLARITY & TEST DISTANCE: HORIZONTAL AT 3 M								
NO.	FREQ. (MHz)	EMISSION LEVEL (dBuV/m)	LIMIT (dBuV/m)	MARGIN (dB)	ANTENNA HEIGHT (m)	TABLE ANGLE (Degree)	RAW VALUE (dBuV)	CORRECTION FACTOR (dB/m)
1	239.88	37.4 QP	46.0	-8.6	1.25 H	97	24.20	13.20
2	300.16	33.8 QP	46.0	-12.2	1.25 H	247	18.50	15.30
3	319.60	41.0 QP	46.0	-5.0	1.25 H	247	25.10	15.90
4	399.31	33.8 QP	46.0	-12.2	2.00 H	55	15.20	18.60
5	799.84	30.2 QP	46.0	-15.8	2.00 H	175	2.80	27.40
6	963.16	29.6 QP	54.0	-24.4	2.00 H	91	0.20	29.40
ANTENNA POLARITY & TEST DISTANCE: VERTICAL AT 3 M								
NO.	FREQ. (MHz)	EMISSION LEVEL (dBuV/m)	LIMIT (dBuV/m)	MARGIN (dB)	ANTENNA HEIGHT (m)	TABLE ANGLE (Degree)	RAW VALUE (dBuV)	CORRECTION FACTOR (dB/m)
1	109.62	23.8 QP	43.5	-19.7	1.25 V	10	11.90	11.90
2	239.88	28.7 QP	46.0	-17.3	1.25 V	61	15.50	13.20
3	300.16	27.0 QP	46.0	-19.0	1.75 V	25	11.70	15.30
4	319.60	32.0 QP	46.0	-14.0	1.25 V	43	16.10	15.90
5	399.31	33.7 QP	46.0	-12.3	2.00 V	178	15.10	18.60
6	920.38	28.6 QP	46.0	-17.4	1.25 V	259	-0.30	28.90

- REMARKS:**
1. Emission level (dBuV/m) = Raw Value (dBuV) + Correction Factor (dB/m).
 2. Correction Factor (dB/m) = Antenna Factor (dB/m) + Cable Factor (dB).
 3. The other emission levels were very low against the limit.
 4. Margin value = Emission level – Limit value.



A D T

EUT TEST CONDITION		MEASUREMENT DETAIL	
TESTED FREQUENCY	5805MHz	FREQUENCY RANGE	Below 1000MHz
INPUT POWER (SYSTEM)	120Vac, 60 Hz	DETECTOR FUNCTION	Quasi-Peak
ENVIRONMENTAL CONDITIONS	25deg. C, 65%RH	TESTED BY	Antony Lee
TEST MODE	B		

ANTENNA POLARITY & TEST DISTANCE: HORIZONTAL AT 3 M								
NO.	FREQ. (MHz)	EMISSION LEVEL (dBuV/m)	LIMIT (dBuV/m)	MARGIN (dB)	ANTENNA HEIGHT (m)	TABLE ANGLE (Degree)	RAW VALUE (dBuV)	CORRECTION FACTOR (dB/m)
1	70.73	26.8 QP	40.0	-13.2	1.00 H	157	14.50	12.30
2	131.00	32.7 QP	43.5	-10.8	1.50 H	211	18.90	13.80
3	175.72	33.6 QP	43.5	-9.9	1.50 H	268	19.80	13.80
4	320.43	31.0 QP	46.0	-15.0	1.00 H	10	15.00	16.00
5	410.98	32.1 QP	46.0	-13.9	1.75 H	40	13.20	18.90
6	665.68	28.0 QP	46.0	-18.0	1.25 H	316	3.40	24.60
ANTENNA POLARITY & TEST DISTANCE: VERTICAL AT 3 M								
NO.	FREQ. (MHz)	EMISSION LEVEL (dBuV/m)	LIMIT (dBuV/m)	MARGIN (dB)	ANTENNA HEIGHT (m)	TABLE ANGLE (Degree)	RAW VALUE (dBuV)	CORRECTION FACTOR (dB/m)
1	70.73	24.7 QP	40.0	-15.3	1.50 V	280	12.40	12.30
2	99.89	24.2 QP	43.5	-19.3	1.00 V	103	13.00	11.20
3	240.21	29.6 QP	46.0	-16.4	1.25 V	154	16.30	13.30
4	320.82	31.2 QP	46.0	-14.8	2.00 V	40	15.20	16.00
5	403.20	31.6 QP	46.0	-14.4	1.75 V	265	12.90	18.70
6	731.79	30.0 QP	46.0	-16.0	2.00 V	43	4.20	25.80

- REMARKS:**
1. Emission level (dBuV/m) = Raw Value (dBuV) + Correction Factor (dB/m).
 2. Correction Factor (dB/m) = Antenna Factor (dB/m) + Cable Factor (dB).
 3. The other emission levels were very low against the limit.
 4. Margin value = Emission level – Limit value.



4.2 CONDUCTED EMISSION MEASUREMENT

4.2.1 LIMITS OF CONDUCTED EMISSION MEASUREMENT

FREQUENCY OF EMISSION (MHz)	CONDUCTED LIMIT (dBµV)	
	Quasi-peak	Average
0.15 ~ 0.5	66 to 56	56 to 46
0.5 ~ 5	56	46
5 ~ 30	60	50

- NOTE:**
1. The lower limit shall apply at the transition frequencies.
 2. The limit decreases in line with the logarithm of the frequency in the range of 0.15 to 0.50MHz.
 3. All emanations from a class A/B digital device or system, including any network of conductors and apparatus connected thereto, shall not exceed the level of field strengths specified above.

4.2.2 TEST INSTRUMENTS

DESCRIPTION & MANUFACTURER	MODEL NO.	SERIAL NO.	DATE OF CALIBRATION	DUE DATE OF CALIBRATION
Test Receiver ROHDE & SCHWARZ	ESCS30	100289	Nov. 23, 2010	Nov. 22, 2011
RF signal cable Woken	5D-FB	Cable-HYCO2-01	Dec. 30, 2010	Dec. 29, 2011
LISN ROHDE & SCHWARZ	ESH2-Z5	100100	Jan. 06, 2011	Jan. 05, 2012
LISN ROHDE & SCHWARZ	ESH3-Z5	100312	Jul. 07, 2011	Jul. 06, 2012
Software ADT	ADT_Cond_ V7.3.7	NA	NA	NA

- NOTE:**
1. The calibration interval of the above test instruments is 12 months and the calibrations are traceable to NML/ROC and NIST/USA.
 2. The test was performed in HwaYa Shielded Room 2.
 3. The VCCI Site Registration No. is C-2047.



A D T

4.2.3 TEST PROCEDURES

- a. The EUT was placed 0.4 meters from the conducting wall of the shielded room with EUT being connected to the power mains through a line impedance stabilization network (LISN). Other support units were connected to the power mains through another LISN. The two LISNs provide 50 ohm/ 50uH of coupling impedance for the measuring instrument.
- b. Both lines of the power mains connected to the EUT were checked for maximum conducted interference.
- c. The frequency range from 150kHz to 30MHz was searched. Emission levels under (Limit - 20dB) was not recorded.

NOTE: All modes of operation were investigated and the worst-case emissions are reported.

4.2.4 DEVIATION FROM TEST STANDARD

No deviation.

4.2.5 TEST SETUP

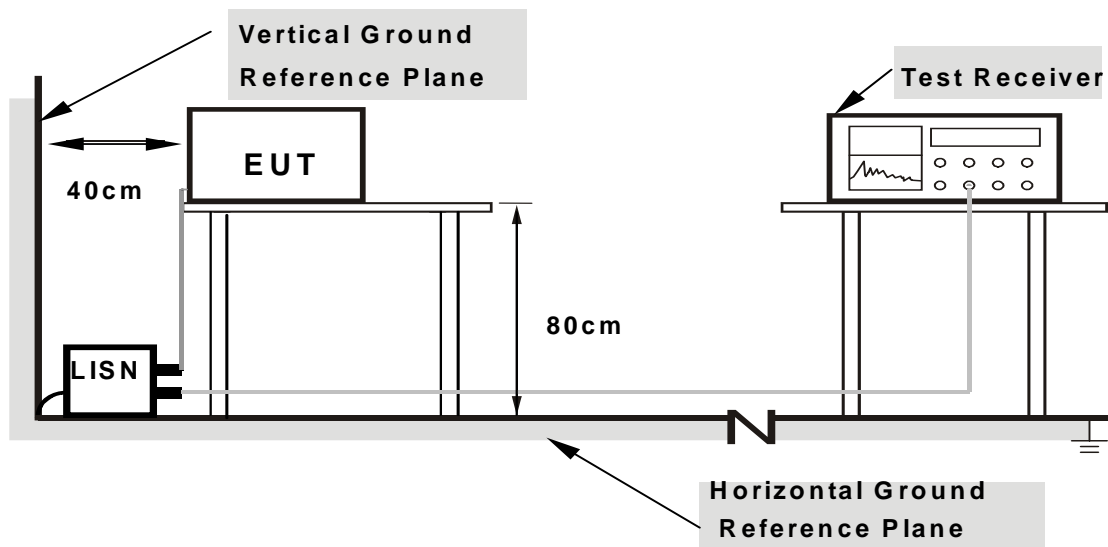

Note: 1.Support units were connected to second LISN.

2.Both of LISNs (AMN) are 80 cm from EUT and at least 80 from other units and other metal planes

For the actual test configuration, please refer to the attached file (Test Setup Photo).

4.2.6 EUT OPERATING CONDITIONS

Same as 4.1.6



A D T

4.2.7 TEST RESULTS

CONDUCTED WORST-CASE DATA : Channel bandwidth (18MHz)

PHASE	Line 1	6dB BANDWIDTH	9kHz
TEST MODE	A		

No	Freq. [MHz]	Corr. Factor (dB)	Reading Value		Emission Level		Limit		Margin	
			[dB (uV)]		[dB (uV)]		[dB (uV)]		(dB)	
			Q.P.	AV.	Q.P.	AV.	Q.P.	AV.	Q.P.	AV.
1	0.150	0.16	43.47	28.83	43.63	28.99	66.00	56.00	-22.37	-27.01
2	0.271	0.18	41.18	34.66	41.36	34.84	61.08	51.08	-19.72	-16.24
3	0.451	0.20	33.02	21.86	33.22	22.06	56.86	46.86	-23.64	-24.80
4	0.834	0.22	32.09	21.33	32.31	21.55	56.00	46.00	-23.69	-24.45
5	2.418	0.28	31.95	21.07	32.23	21.35	56.00	46.00	-23.77	-24.65
6	6.984	0.49	34.14	24.03	34.63	24.52	60.00	50.00	-25.37	-25.48

- REMARKS:**
1. Q.P. and AV. are abbreviations of quasi-peak and average individually.
 2. "-": The Quasi-peak reading value also meets average limit and measurement with the average detector is unnecessary.
 3. The emission levels of other frequencies were very low against the limit.
 4. Margin value = Emission level - Limit value
 5. Correction factor = Insertion loss + Cable loss
 6. Emission Level = Correction Factor + Reading Value.

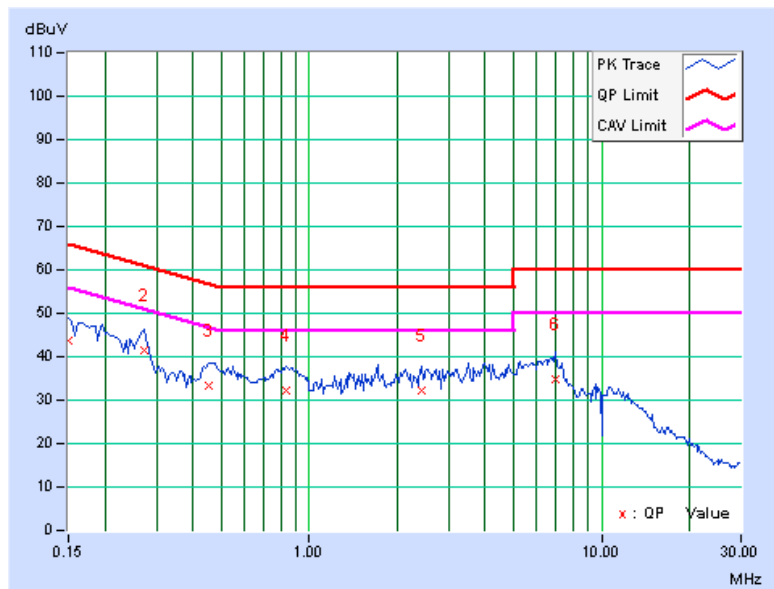

PHASE	Line 2	6dB BANDWIDTH	9kHz
TEST MODE	A		

No	Freq. [MHz]	Corr.	Reading Value		Emission Level		Limit		Margin	
		Factor	[dB (uV)]		[dB (uV)]		[dB (uV)]		(dB)	
		(dB)	Q.P.	AV.	Q.P.	AV.	Q.P.	AV.	Q.P.	AV.
1	0.150	0.19	43.41	26.15	43.60	26.34	66.00	56.00	-22.40	-29.66
2	0.271	0.19	41.40	35.14	41.59	35.33	61.08	51.08	-19.49	-15.75
3	0.459	0.21	31.55	21.20	31.76	21.41	56.72	46.72	-24.96	-25.31
4	0.783	0.21	29.34	20.41	29.55	20.62	56.00	46.00	-26.45	-25.38
5	2.039	0.24	28.83	20.13	29.07	20.37	56.00	46.00	-26.93	-25.63
6	6.910	0.47	28.97	19.18	29.44	19.65	60.00	50.00	-30.56	-30.35

- REMARKS:**
1. Q.P. and AV. are abbreviations of quasi-peak and average individually.
 2. "-": The Quasi-peak reading value also meets average limit and measurement with the average detector is unnecessary.
 3. The emission levels of other frequencies were very low against the limit.
 4. Margin value = Emission level - Limit value
 5. Correction factor = Insertion loss + Cable loss
 6. Emission Level = Correction Factor + Reading Value.

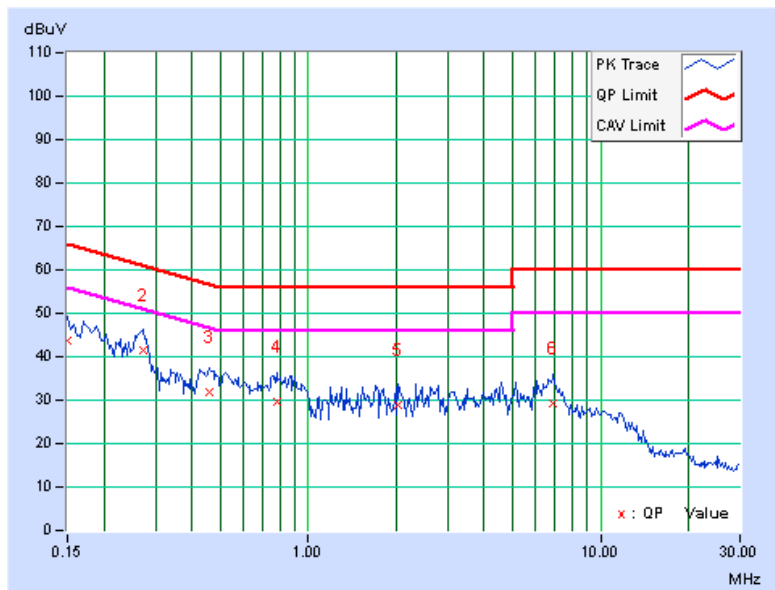

PHASE	Line 1	6dB BANDWIDTH	9kHz
TEST MODE	B		

No	Freq. [MHz]	Corr. Factor (dB)	Reading Value		Emission Level		Limit		Margin	
			[dB (uV)]		[dB (uV)]		[dB (uV)]		(dB)	
			Q.P.	AV.	Q.P.	AV.	Q.P.	AV.	Q.P.	AV.
1	0.170	0.12	49.88	39.27	50.00	39.39	64.98	54.98	-14.99	-15.60
2	0.226	0.12	43.38	38.07	43.50	38.19	62.61	52.61	-19.11	-14.42
3	0.281	0.12	37.41	31.40	37.53	31.52	60.77	50.77	-23.24	-19.25
4	2.027	0.19	34.64	28.88	34.83	29.07	56.00	46.00	-21.17	-16.93
5	3.715	0.29	40.37	29.33	40.66	29.62	56.00	46.00	-15.34	-16.38
6	5.066	0.37	31.69	21.85	32.06	22.22	60.00	50.00	-27.94	-27.78

- REMARKS:**
1. Q.P. and AV. are abbreviations of quasi-peak and average individually.
 2. "-": The Quasi-peak reading value also meets average limit and measurement with the average detector is unnecessary.
 3. The emission levels of other frequencies were very low against the limit.
 4. Margin value = Emission level - Limit value
 5. Correction factor = Insertion loss + Cable loss
 6. Emission Level = Correction Factor + Reading Value.

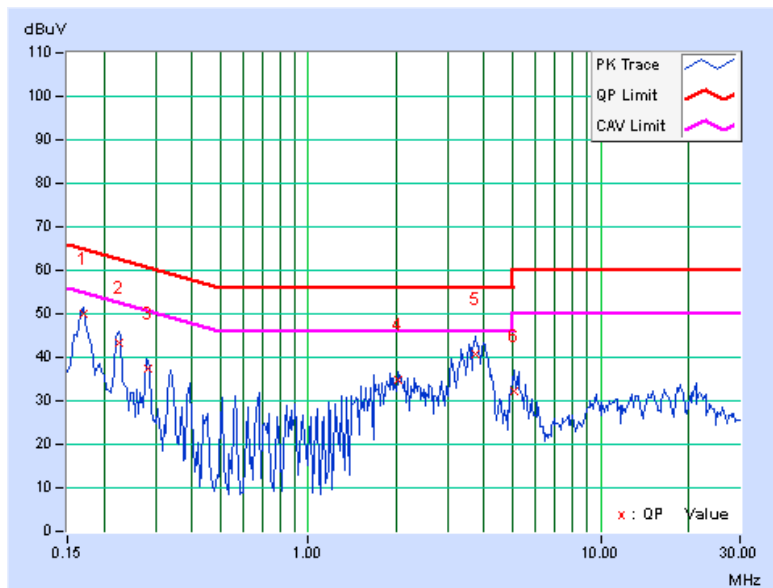

PHASE	Line 2	6dB BANDWIDTH	9kHz
TEST MODE	B		

No	Freq. [MHz]	Corr.	Reading Value		Emission Level		Limit		Margin	
		Factor	[dB (uV)]		[dB (uV)]		[dB (uV)]		(dB)	
		(dB)	Q.P.	AV.	Q.P.	AV.	Q.P.	AV.	Q.P.	AV.
1	0.170	0.13	49.74	39.44	49.87	39.57	64.98	54.98	-15.12	-15.42
2	0.224	0.13	43.56	38.37	43.69	38.50	62.66	52.66	-18.97	-14.16
3	0.283	0.13	36.97	32.93	37.10	33.06	60.73	50.73	-23.63	-17.67
4	1.906	0.20	32.62	25.92	32.82	26.12	56.00	46.00	-23.18	-19.88
5	3.711	0.30	38.54	28.28	38.84	28.58	56.00	46.00	-17.16	-17.42
6	5.230	0.38	32.38	22.42	32.76	22.80	60.00	50.00	-27.24	-27.20

- REMARKS:**
1. Q.P. and AV. are abbreviations of quasi-peak and average individually.
 2. "-": The Quasi-peak reading value also meets average limit and measurement with the average detector is unnecessary.
 3. The emission levels of other frequencies were very low against the limit.
 4. Margin value = Emission level - Limit value
 5. Correction factor = Insertion loss + Cable loss
 6. Emission Level = Correction Factor + Reading Value.

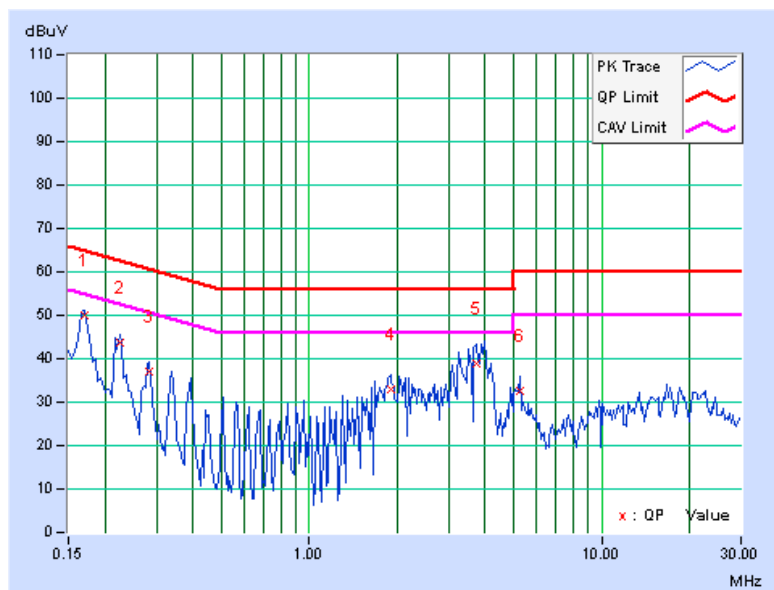

4.3 6dB BANDWIDTH MEASUREMENT

4.3.1 LIMITS OF 6dB BANDWIDTH MEASUREMENT

The minimum of 6dB Bandwidth Measurement is 0.5MHz.

4.3.2 TEST SETUP

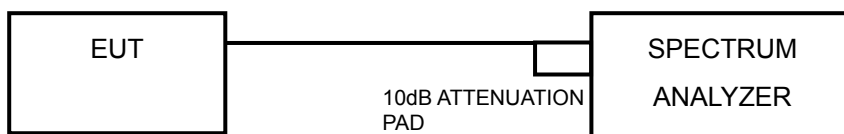

4.3.3 TEST INSTRUMENTS

Refer to section 5.1.2 to get information of above instrument.

4.3.4 TEST PROCEDURE

1. Set resolution bandwidth (RBW) = approximately 1% of the emission bandwidth
2. Set the video bandwidth (VBW) $\geq 3 \times$ RBW, Detector = Peak.
3. Trace mode = max hold.
4. Sweep = auto couple.
5. Measure the maximum width of the emission that is constrained by the frequencies associated with the two amplitude points (upper and lower) that are attenuated by 6 dB relative to the maximum level measured in the fundamental emission

4.3.5 DEVIATION FROM TEST STANDARD

No deviation.

4.3.6 EUT OPERATING CONDITIONS

The software provided by client to enable the EUT under transmission condition continuously at lowest, middle and highest channel frequencies individually.



4.3.7 TEST RESULTS

Channel bandwidth (18MHz)

CHANNEL FREQUENCY (MHz)	6dB BANDWIDTH (MHz)	MINIMUM LIMIT (MHz)	PASS / FAIL
5745	15.45	0.5	PASS
5785	15.46	0.5	PASS
5805	15.47	0.5	PASS

Channel bandwidth (36MHz)

CHANNEL FREQUENCY (MHz)	6dB BANDWIDTH (MHz)	MINIMUM LIMIT (MHz)	PASS / FAIL
5755	30.87	0.5	PASS
5795	30.97	0.5	PASS

4.4 CONDUCTED OUTPUT POWER

4.4.1 LIMITS OF MAXIMUM OUTPUT POWER MEASUREMENT

For systems using digital modulation in the 5725 –5850 MHz bands: 1 Watt (30dBm)

4.4.2 TEST SETUP

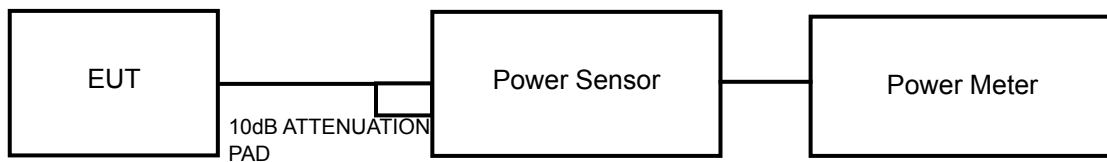

4.4.3 INSTRUMENTS

Refer to section 5.1.2 to get information of above instrument.

4.4.4 TEST PROCEDURES

A power sensor was used on the output port of the EUT. A power meter was used to read the response of the power sensor. Record the power level.

4.4.5 DEVIATION FROM TEST STANDARD

No deviation.

4.4.6 EUT OPERATING CONDITIONS

Same as Item 4.3.6.



4.4.7 TEST RESULTS

Channel bandwidth (18MHz)

CHANNEL FREQUENCY (MHz)	PEAK POWER (mW)	PEAK POWER (dBm)	LIMIT (dBm)	PASS/FAIL
5745	138.0	21.4	30	PASS
5785	134.9	21.3	30	PASS
5805	144.5	21.6	30	PASS

Channel bandwidth (36MHz)

CHANNEL FREQUENCY (MHz)	PEAK POWER (mW)	PEAK POWER (dBm)	LIMIT (dBm)	PASS/FAIL
5755	151.4	21.8	30	PASS
5795	147.9	21.7	30	PASS

4.5 POWER SPECTRAL DENSITY MEASUREMENT

4.5.1 LIMITS OF POWER SPECTRAL DENSITY MEASUREMENT

The Maximum of Power Spectral Density Measurement is 8dBm.

4.5.2 TEST SETUP

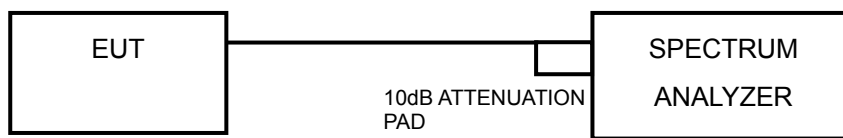

4.5.3 TEST INSTRUMENTS

Refer to section 5.1.2 to get information of above instrument.

4.5.4 TEST PROCEDURE.

1. Set the RBW = 100 kHz, VBW = 300 kHz, Detector = peak.
2. Sweep time = auto couple, Trace mode = max hold, allow trace to fully stabilize.
3. Use the peak marker function to determine the maximum power level in any 100 kHz band segment within the fundamental EBW.
4. Scale the observed power level to an equivalent value in 3 kHz by adjusting (reducing) the measured power by a bandwidth correction factor (BWCF) where $BWCF = 10\log(3 \text{ kHz}/100\text{kHz})$

4.5.5 DEVIATION FROM TEST STANDARD

No deviation.

4.5.6 EUT OPERATING CONDITION

Same as Item 5.3.6.



4.5.7 TEST RESULTS

Channel bandwidth (18MHz)

CHANNEL FREQUENCY (MHz)	PSD (dBm/100kHz)	PSD (dBm/3kHz)	Limit (dBm/3kHz)	PASS /FAIL
5745	1.15	-14.08	8	PASS
5785	1.00	-14.23	8	PASS
5805	3.92	-11.31	8	PASS

Channel bandwidth (36MHz)

CHANNEL FREQUENCY (MHz)	PSD (dBm/100kHz)	PSD (dBm/3kHz)	Limit (dBm/3kHz)	PASS /FAIL
5755	-0.41	-15.64	8	PASS
5795	-0.37	-15.6	8	PASS

4.6 CONDUCTED EMISSION MEASUREMENT

4.6.1 LIMITS OF CONDUCTED EMISSION MEASUREMENT

Below -20dB of the highest emission level of operating band (in 100kHz Resolution Bandwidth).

4.6.2 TEST SETUP

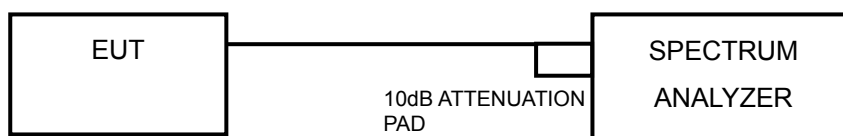

4.6.3 TEST INSTRUMENTS

Refer to section 5.1.2 to get information of above instrument.

4.6.4 TEST PROCEDURE

MEASUREMENT PROCEDURE REF

1. Set the RBW = 100 kHz.
2. Set the VBW \geq 300 kHz.
3. Detector = peak.
4. Sweep time = auto couple.
5. Trace mode = max hold.
6. Allow trace to fully stabilize.
7. Use the peak marker function to determine the maximum power level in any 100 kHz band segment within the fundamental EBW.



A D T

MEASUREMENT PROCEDURE OOBE

1. Set RBW = 100 kHz.
2. Set VBW \geq 300 kHz.
3. Set span to encompass the spectrum to be examined.
4. Detector = peak.
5. Trace Mode = max hold.
6. Sweep = auto couple.

4.6.5 DEVIATION FROM TEST STANDARD

No deviation.

4.6.6 EUT OPERATING CONDITION

Same as Item 5.3.6

4.6.7 TEST RESULTS

The conducted emission test is performed on each TX port of operating mode without summing or adding $10\log(N)$ since the limit is relative emission limit. Only worst data of each operating mode is presented.

The spectrum plots are attached on the following pages. D1 line indicates the highest level, and D2 line indicates the 20dB offset below D1. It shows compliance with the requirement in part 15.247(d).

Channel bandwidth (18MHz)

5745MHz

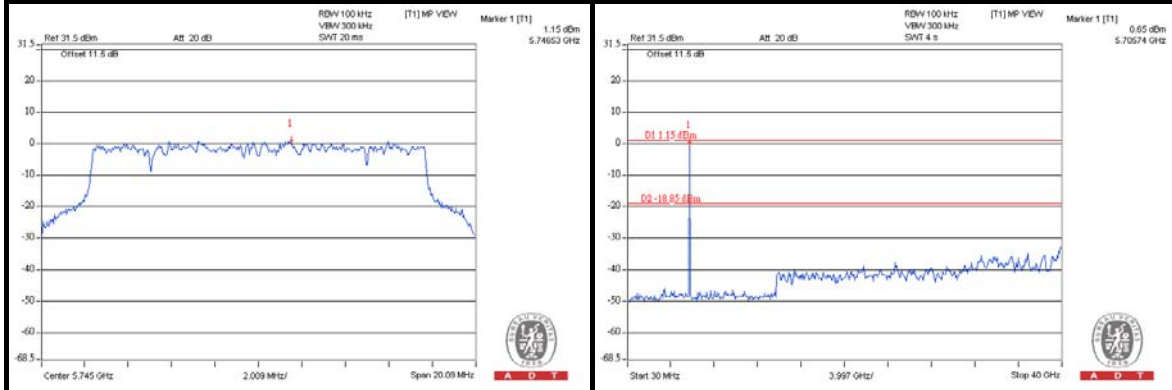

5785MHz

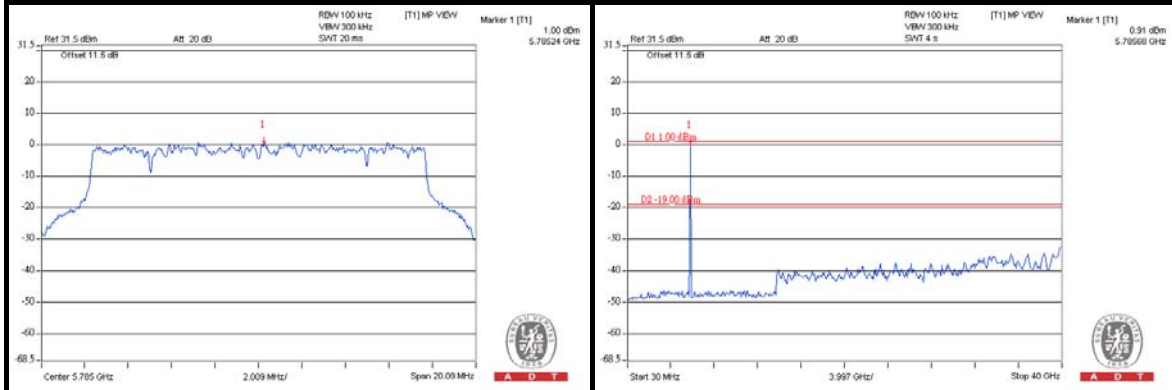

5805MHz

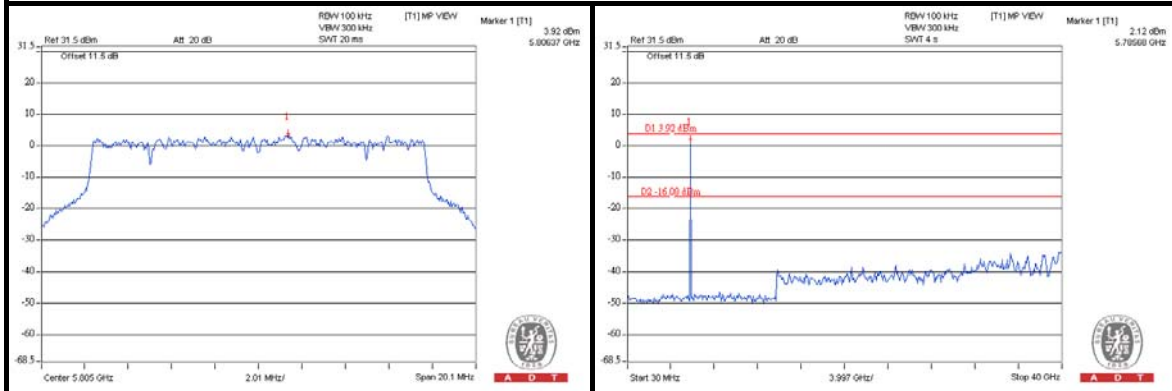

Channel bandwidth (36MHz)

5755MHz

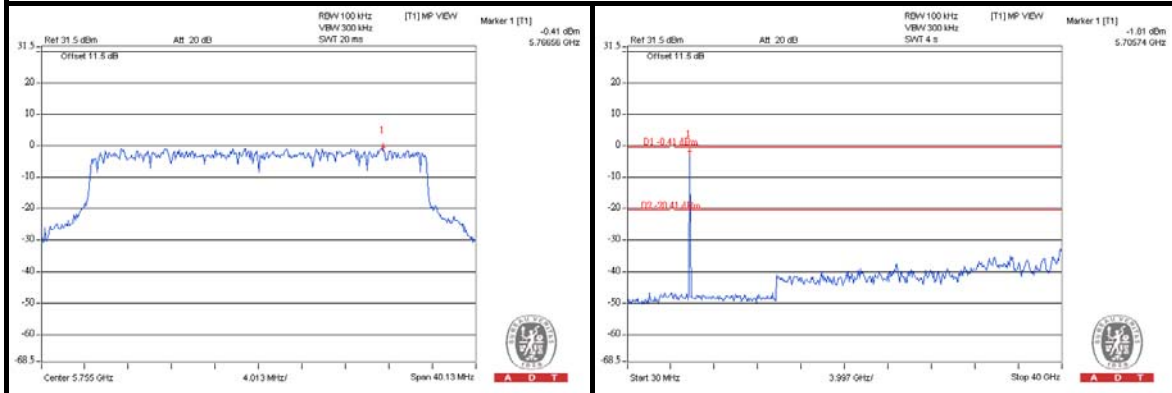

5795MHz

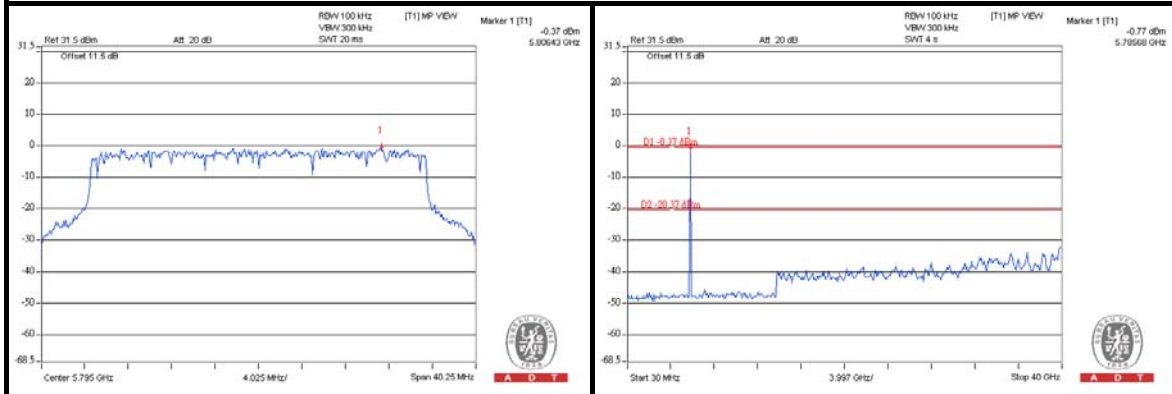



A D T

5. PHOTOGRAPHS OF THE TEST CONFIGURATION

Please refer to the attached file (Test Setup Photo).



A D T

6. INFORMATION ON THE TESTING LABORATORIES

We, Bureau Veritas Consumer Products Services (H.K.) Ltd., Taoyuan Branch, were founded in 1988 to provide our best service in EMC, Radio, Telecom and Safety consultation. Our laboratories are accredited and approved according to ISO/IEC 17025.

Copies of accreditation and authorization certificates of our laboratories obtained from approval agencies can be downloaded from our web site: www.adt.com.tw/index.5.phtml.

If you have any comments, please feel free to contact us at the following:

Linko EMC/RF Lab

Tel: 886-2-26052180

Fax: 886-2-26051924

Hsin Chu EMC/RF Lab

Tel: 886-3-5935343

Fax: 886-3-5935342

Hwa Ya EMC/RF/Safety/Telecom Lab

Tel: 886-3-3183232

Fax: 886-3-3185050

Email: service.adt@tw.bureauveritas.com

Web Site: www.adt.com.tw

The address and road map of all our labs can be found in our web site also.



A D T

7. APPENDIX A - MODIFICATIONS RECORDERS FOR ENGINEERING CHANGES TO THE EUT BY THE LAB

No modifications were made to the EUT by the lab during the test.

---END---