

FCC Test Report

FCC ID : MXF-EL4000
Equipment : Wireless Home Internet
Model No. : EL4000
Brand Name : EarthLink
Applicant : Gemtek Technology Co., Ltd.
Address : No. 15-1 Zhonghua Road, Hsinchu Industrial Park,
Hukou, Hsinchu, Taiwan, 30352.
Standard : 47 CFR FCC Part 15.247
Received Date : Jan. 25, 2022
Tested Date : Jan. 26 ~ Feb. 15, 2022

We, International Certification Corporation, would like to declare that the tested sample has been evaluated and in compliance with the requirement of the above standards. The test results contained in this report refer exclusively to the product. It shall not be reproduced except in full without the written approval of our laboratory.

Reviewed by:

Approved by:



Along Chen / Assistant Manager



Gary Chang / Manager

Table of Contents

| | | |
|----------|---|-----------|
| 1 | GENERAL DESCRIPTION | 5 |
| 1.1 | Information..... | 5 |
| 1.2 | Local Support Equipment List | 8 |
| 1.3 | Test Setup Chart | 8 |
| 1.4 | The Equipment List | 9 |
| 1.5 | Test Standards | 10 |
| 1.6 | Reference Guidance | 10 |
| 1.7 | Deviation from Test Standard and Measurement Procedure..... | 10 |
| 1.8 | Measurement Uncertainty | 10 |
| 2 | TEST CONFIGURATION..... | 11 |
| 2.1 | Testing Facility | 11 |
| 2.2 | The Worst Test Modes and Channel Details | 11 |
| 3 | TRANSMITTER TEST RESULTS | 12 |
| 3.1 | Conducted Emissions..... | 12 |
| 3.2 | 6dB and Occupied Bandwidth..... | 15 |
| 3.3 | RF Output Power..... | 21 |
| 3.4 | Power Spectral Density | 24 |
| 3.5 | Unwanted Emissions into Restricted Frequency Bands | 30 |
| 3.6 | Emissions in Non-Restricted Frequency Bands..... | 58 |
| 4 | TEST LABORATORY INFORMATION | 63 |

Release Record

| Report No. | Version | Description | Issued Date |
|------------|---------|---------------|---------------|
| FR212101AC | Rev. 01 | Initial issue | Mar. 01, 2022 |

Summary of Test Results

| FCC Rules | Test Items | Measured | Result |
|---------------------|------------------------|---|--------|
| 15.207 | Conducted Emissions | [dBuV]: 0.356MHz 32.75 (Margin -16.07dB) - AV | Pass |
| 15.247(d) 15.209 | Radiated Emissions | [dBuV/m at 3m]: 2390.00MHz 53.89 (Margin -0.11dB) - AV | Pass |
| 15.247(b)(3) | Maximum Output Power | Max Power [dBm]: 28.69 | Pass |
| 15.247(a)(2) | 6dB Bandwidth | Meet the requirement of limit | Pass |
| 15.247(e) | Power Spectral Density | Meet the requirement of limit | Pass |
| 15.203 | Antenna Requirement | Meet the requirement of limit | Pass |

Declaration of Conformity:

The test results with all measurement uncertainty excluded are presented in accordance with the regulation limits or requirements declared by manufacturers.

Comments and Explanations:

The declared of product specification for EUT presented in the report are provided by the manufacturer, and the manufacturer takes all the responsibilities for the accuracy of product specification.

1 General Description

1.1 Information

1.1.1 Specification of the Equipment under Test (EUT)

| RF General Information | | | | | |
|------------------------|------------------|-----------------|----------------|------------------------------------|-----------------|
| Frequency Range (MHz) | IEEE Std. 802.11 | Ch. Freq. (MHz) | Channel Number | Transmit Chains (N _{TX}) | Data Rate / MCS |
| 2400-2483.5 | b | 2412-2462 | 1-11 [11] | 1 | 1-11 Mbps |
| 2400-2483.5 | g | 2412-2462 | 1-11 [11] | 2 | 6-54 Mbps |
| 2400-2483.5 | n (HT20) | 2412-2462 | 1-11 [11] | 2 | MCS 0-15 |
| 2400-2483.5 | n (HT40) | 2422-2452 | 3-9 [7] | 2 | MCS 0-15 |
| 2400-2483.5 | ax (HE20) | 2412-2462 | 1-11 [11] | 2 | MCS 0-11 |
| 2400-2483.5 | ax (HE40) | 2422-2452 | 3-9 [7] | 2 | MCS 0-11 |

Note 1: RF output power specifies that Maximum Conducted (Average) Output Power.
 Note 2: DSSS-DBPSK, DQPSK, CCK modulation
 OFDM/OFDMA- BPSK, QPSK, 16QAM, 64QAM, 256QAM and 1024QAM modulation.
 Note 3: 802.11ax supports beamforming function.

1.1.2 Antenna Details

| Ant. No. | Model | Type | Connector | Operating Frequencies (MHz) / Antenna Gain (dBi) | | |
|----------|---------|--------|-----------|--|-----------|-----------|
| | | | | 2400~2483.5 | 5150~5250 | 5725~5850 |
| 1 | 2.4G -1 | Dipole | UFL | 4.2 | --- | --- |
| 2 | 2.4G -2 | Dipole | UFL | 3.4 | --- | --- |
| 3 | 5G - 1 | Dipole | UFL | --- | 5.1 | 4.2 |
| 4 | 5G - 2 | Dipole | UFL | --- | 4.9 | 5 |

1.1.3 Power Supply Type of Equipment under Test (EUT)

| | |
|--------------------------|--------------------|
| Power Supply Type | 12Vdc from adapter |
|--------------------------|--------------------|

1.1.4 Accessories

| Accessories | | |
|-------------|------------|--|
| No. | Equipment | Description |
| 1 | AC adapter | Brand: MOSO Model: MSS-V2500WR120-030E0-US I/P: 100-240V~ 50/60Hz, 1.0A max O/P: 12V=2.5A Power Line: 1.8m non-shielded without core |
| 2 | AC adapter | Brand: LEI Model: ML30B1120250-A1 I/P: 100-120V~ 50/60Hz, 0.8A O/P: 12V=2.5A Power Line: 1.8m non-shielded without core |
| 3 | RJ45 cable | 1.8m non-shielded without core |

1.1.5 Channel List

| Frequency band (MHz) | | 2400~2483.5 | |
|-----------------------------|----------------|------------------------|----------------|
| 802.11bg / n HT20 / ax HE20 | | 802.11n HT40 / ax HE40 | |
| Channel | Frequency(MHz) | Channel | Frequency(MHz) |
| 1 | 2412 | 3 | 2422 |
| 2 | 2417 | 4 | 2427 |
| 3 | 2422 | 5 | 2432 |
| 4 | 2427 | 6 | 2437 |
| 5 | 2432 | 7 | 2442 |
| 6 | 2437 | 8 | 2447 |
| 7 | 2442 | 9 | 2452 |
| 8 | 2447 | --- | --- |
| 9 | 2452 | --- | --- |
| 10 | 2457 | --- | --- |
| 11 | 2462 | --- | --- |

1.1.6 Test Tool and Duty Cycle

| Test Tool | Intel DUT GUI, V610.36 | | |
|----------------------------|------------------------|----------------|------------------|
| Duty Cycle and Duty Factor | Mode | Duty Cycle (%) | Duty Factor (dB) |
| | 11b | 100.00% | 0.00 |
| | 11g | 99.51% | 0.02 |
| | ax HE20-OFDMA | 100.00% | 0.00 |
| | ax HE40-OFDMA | 100.00% | 0.00 |

1.1.7 Power Index of Test Tool

| Modulation Mode | Test Frequency (MHz) | Power Index | |
|-----------------|----------------------|-----------------|-------------|
| | | Non-beamforming | Beamforming |
| 11b | 2412 | 26.5 | -- |
| 11b | 2437 | 26.5 | -- |
| 11b | 2462 | 26.5 | -- |
| 11g | 2412 | 19 | -- |
| 11g | 2437 | 26.5 | -- |
| 11g | 2462 | 20 | -- |
| ax HE20-OFDMA | 2412 | 19 | 19 |
| ax HE20-OFDMA | 2437 | 25.5 | 25.5 |
| ax HE20-OFDMA | 2462 | 20 | 20 |
| ax HE40-OFDMA | 2422 | 17.5 | 17.5 |
| ax HE40-OFDMA | 2437 | 21 | 21 |
| ax HE40-OFDMA | 2452 | 20 | 20 |

1.2 Local Support Equipment List

| Support Equipment List | | | | | |
|------------------------|----------------------|-----------|----------------|--------|------------------------|
| No. | Equipment | Brand | Model | FCC ID | Remarks |
| 1 | Notebook | DELL | Latitude E6440 | DoC | --- |
| 2 | Notebook | DELL | Latitude 5400 | --- | --- |
| 3 | USB 3.0 Flash | Transcend | JetFlash 700 | --- | --- |
| 4 | RJ45 load | ICC | --- | --- | --- |
| 5 | LTE external antenna | --- | --- | --- | Provided by applicant. |

1.3 Test Setup Chart

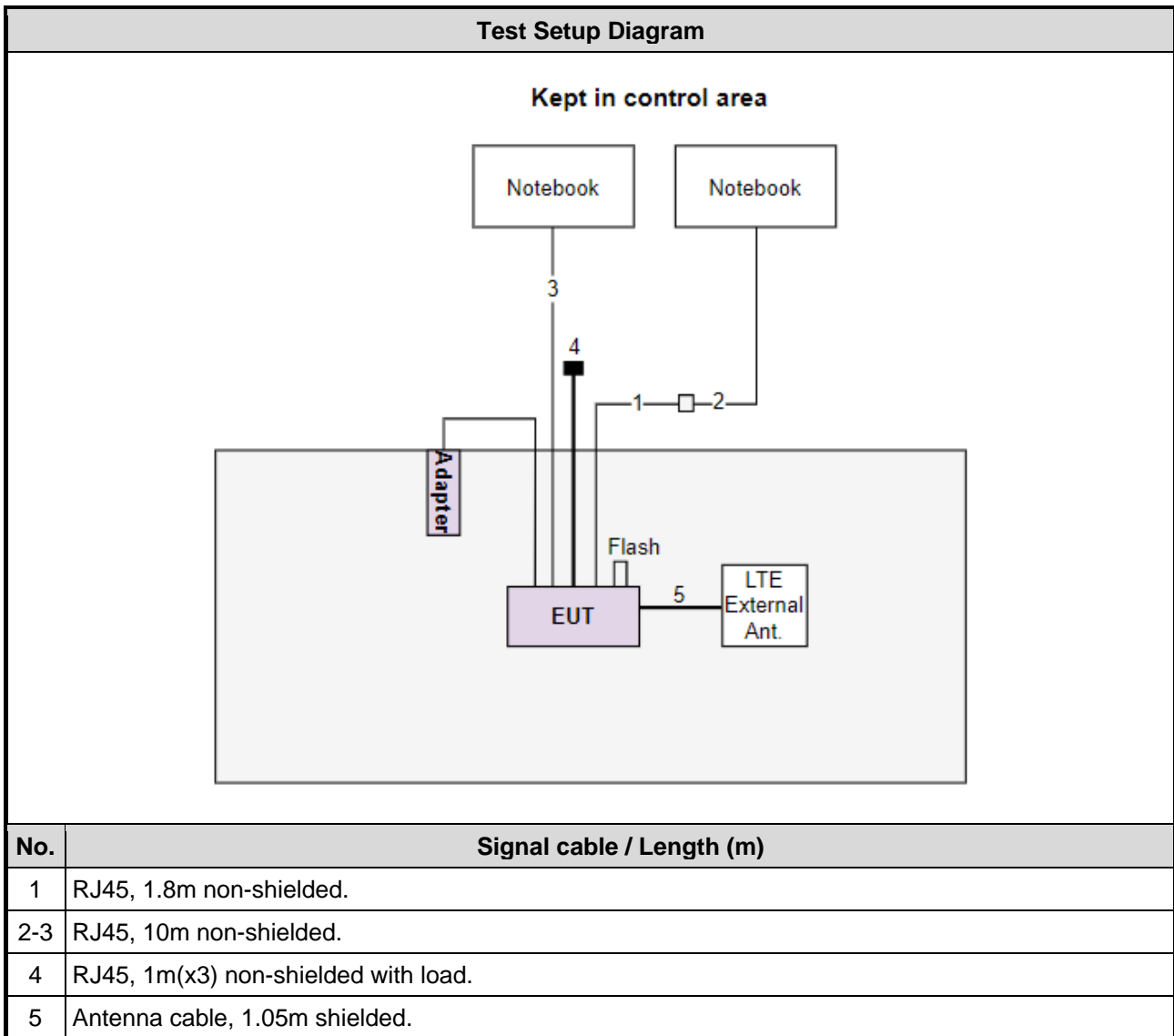

1.4 The Equipment List

| | | | | | |
|-----------------------------------|--------------------------------|------------------|-------------------|-------------------------|--------------------------|
| Test Item | Conducted Emission | | | | |
| Test Site | Conduction room 1 / (CO01-WS) | | | | |
| Tested Date | Feb. 14, 2022 | | | | |
| Instrument | Brand | Model No. | Serial No. | Calibration Date | Calibration Until |
| Receiver | R&S | ESR3 | 101657 | Mar. 12, 2021 | Mar. 11, 2022 |
| LISN | R&S | ENV216 | 101579 | Mar. 17, 2021 | Mar. 16, 2022 |
| LISN (Support Unit) | SCHWARZBECK MESS-ELEKTRONIK | NSLK 8127 | 8127477 | Feb. 25, 2021 | Feb. 24, 2022 |
| RF Cable-CON | Woken | CFD200-NL | CFD200-NL-001 | Oct. 19, 2021 | Oct. 18, 2022 |
| 50 ohm terminal (Support Unit) | NA | 50 | 04 | May 25, 2021 | May 24, 2022 |
| Measurement Software | AUDIX | e3 | 6.120210k | NA | NA |

Note: Calibration Interval of instruments listed above is one year.

| | | | | | |
|-------------------------|----------------------------|---------------------------|-------------------|-------------------------|--------------------------|
| Test Item | Radiated Emission | | | | |
| Test Site | 966 chamber1 / (03CH01-WS) | | | | |
| Tested Date | Jan. 26 ~ Jan. 28, 2022 | | | | |
| Instrument | Brand | Model No. | Serial No. | Calibration Date | Calibration Until |
| Receiver | R&S | ESR3 | 101657 | Mar. 12, 2021 | Mar. 11, 2022 |
| Spectrum Analyzer | R&S | FSV40 | 101498 | Nov. 29, 2021 | Nov. 28, 2022 |
| Loop Antenna | R&S | HFH2-Z2 | 100330 | Nov. 08, 2021 | Nov. 07, 2022 |
| Bilog Antenna | SCHWARZBECK | VULB9168 | VULB9168-522 | Jun. 30, 2021 | Jun. 29, 2022 |
| Horn Antenna 1G-18G | SCHWARZBECK | BBHA 9120 D | BBHA 9120 D 1096 | Dec. 03, 2021 | Dec. 02, 2022 |
| Horn Antenna 18G-40G | SCHWARZBECK | BBHA 9170 | BBHA 9170508 | Jan. 11, 2022 | Jan. 10, 2023 |
| Preamplifier | EMC | EMC02325 | 980225 | Jun. 29, 2021 | Jun. 28, 2022 |
| Preamplifier | Agilent | 83017A | MY39501308 | Sep. 28, 2021 | Sep. 27, 2022 |
| Preamplifier | EMC | EMC184045B | 980192 | Jul. 14, 2021 | Jul. 13, 2022 |
| Loop Antenna Cable | KOAX KABEL | 101354-BW | 101354-BW | Oct. 05, 2021 | Oct. 04, 2022 |
| LF cable 3M | Woken | CFD400NL-LW | CFD400NL-001 | Oct. 05, 2021 | Oct. 04, 2022 |
| LF cable 11M | EMC | EMCCFD400-NW-N W-11000 | 200801 | Oct. 05, 2021 | Oct. 04, 2022 |
| LF cable 1M | EMC | EMCCFD400-NM-N M-1000 | 160502 | Oct. 05, 2021 | Oct. 04, 2022 |
| RF Cable | EMC | EMC104-35M-35M- 8000 | 210920 | Oct. 05, 2021 | Oct. 04, 2022 |
| RF Cable | HUBER+SUHNER | SUCOFLEX104 | MY16019/4 | Oct. 05, 2021 | Oct. 04, 2022 |
| Measurement Software | AUDIX | e3 | 6.120210g | NA | NA |

Note: Calibration Interval of instruments listed above is one year.

| | | | | | |
|---|---------------|------------------|-------------------|-------------------------|--------------------------|
| Test Item | RF Conducted | | | | |
| Test Site | (TH01-WS) | | | | |
| Tested Date | Feb. 15, 2022 | | | | |
| Instrument | Brand | Model No. | Serial No. | Calibration Date | Calibration Until |
| Spectrum Analyzer | R&S | FSV40 | 101498 | Nov. 29, 2021 | Nov. 28, 2022 |
| Power Meter | Anritsu | ML2495A | 1241002 | Nov. 07, 2021 | Nov. 06, 2022 |
| Power Sensor | Anritsu | MA2411B | 1207366 | Nov. 07, 2021 | Nov. 06, 2022 |
| Measurement Software | Sporton | SENSE-15247_DTS | V5.10 | NA | NA |
| Note: Calibration Interval of instruments listed above is one year. | | | | | |

1.5 Test Standards

47 CFR FCC Part 15.247
ANSI C63.10-2013

1.6 Reference Guidance

FCC KDB 558074 D01 15.247 Meas Guidance v05r02
FCC KDB 662911 D01 Multiple Transmitter Output v02r01

1.7 Deviation from Test Standard and Measurement Procedure

None

1.8 Measurement Uncertainty

The measurement uncertainties given below are based on a 95% confidence level (based on a coverage factor (k=2)).

| Measurement Uncertainty | |
|--------------------------|-------------|
| Parameters | Uncertainty |
| Bandwidth | ±34.130 Hz |
| Conducted power | ±0.808 dB |
| Power density | ±0.583 dB |
| Conducted emission | ±2.715 dB |
| AC conducted emission | ±2.92 dB |
| Radiated emission ≤ 1GHz | ±3.41 dB |
| Radiated emission > 1GHz | ±4.59 dB |

2 Test Configuration

2.1 Testing Facility

| | |
|-----------------------------|--|
| Test Laboratory | International Certification Corporation |
| Test Site | CO01-WS, 03CH01-WS, TH01-WS |
| Address of Test Site | No.3-1, Lane 6, Wen San 3rd St., Kwei Shan Dist., Tao Yuan City 33381, Taiwan (R.O.C.) |

- FCC Designation No.: TW2732
- FCC site registration No.: 181692
- ISED#: 10807A
- CAB identifier: TW2732

2.2 The Worst Test Modes and Channel Details

| Test item | Modulation Mode | Test Frequency (MHz) | Data Rate (Mbps) / MCS | Test Configuration |
|--|-----------------|----------------------|------------------------|--------------------|
| Non-beamforming mode | | | | |
| Conducted Emissions | 11g | 2437 | 6 Mbps | -- |
| Radiated Emissions ≤1GHz | 11g | 2437 | 6 Mbps | -- |
| Maximum Output Power | 11b | 2412 / 2437 / 2462 | 1 Mbps | -- |
| | 11g | 2412 / 2437 / 2462 | 6 Mbps | |
| | ax HE20-OFDMA | 2412 / 2437 / 2462 | MCS 0 | |
| | ax HE40-OFDMA | 2422 / 2437 / 2452 | MCS 0 | |
| Radiated Emissions >1GHz 6dB bandwidth Power spectral density | 11b | 2412 / 2437 / 2462 | 1 Mbps | -- |
| | 11g | 2412 / 2437 / 2462 | 6 Mbps | |
| | ax HE20-OFDMA | 2412 / 2437 / 2462 | MCS 0 | |
| | ax HE40-OFDMA | 2422 / 2437 / 2452 | MCS 0 | |
| Beamforming mode | | | | |
| Maximum Output Power | ax HE20-OFDMA | 2412 / 2437 / 2462 | MCS 0 | -- |
| | ax HE40-OFDMA | 2422 / 2437 / 2452 | MCS 0 | |
| NOTE: | | | | |
| 1. Two adapters (MOSO & LEI) had been covered during the pretest and found that LEI adapter was the worst case for radiated emission test and MOSO adapter was the worst case for conducted emission test. | | | | |
| 2. Non-beamforming and beamforming mode had been covered during the pretest. The worst mode is Non-beamforming thus Non-beamforming is tested for all test items. | | | | |

3 Transmitter Test Results

3.1 Conducted Emissions

3.1.1 Limit of Conducted Emissions

| Conducted Emissions Limit | | |
|---------------------------|------------|-----------|
| Frequency Emission (MHz) | Quasi-Peak | Average |
| 0.15-0.5 | 66 - 56 * | 56 - 46 * |
| 0.5-5 | 56 | 46 |
| 5-30 | 60 | 50 |

Note 1: * Decreases with the logarithm of the frequency.

3.1.2 Test Procedures

1. The device is placed on a test table, raised 80 cm above the reference ground plane. The vertical conducting plane is located 40 cm to the rear of the device.
2. The device is connected to line impedance stabilization network (LISN) and other accessories are connected to other LISN. Measured levels of AC power line conducted emission are across the 50 Ω LISN port.
3. AC conducted emission measurements is made over frequency range from 150 kHz to 30 MHz.
4. This measurement was performed with AC 120V / 60Hz.

3.1.3 Test Setup



- Note: 1. Support units were connected to second LISN.
 2. Both of LISNs (AMN) are 80 cm from EUT and at least 80 cm from other units and other metal planes

3.1.4 Test Result of Conducted Emissions

| | | | |
|-------------|------|------------------|------|
| Modulation | 11g | Test Freq. (MHz) | 2437 |
| Power Phase | Line | | |

Test by : Joe Liao Temperature: 16°C Humidity: 64%

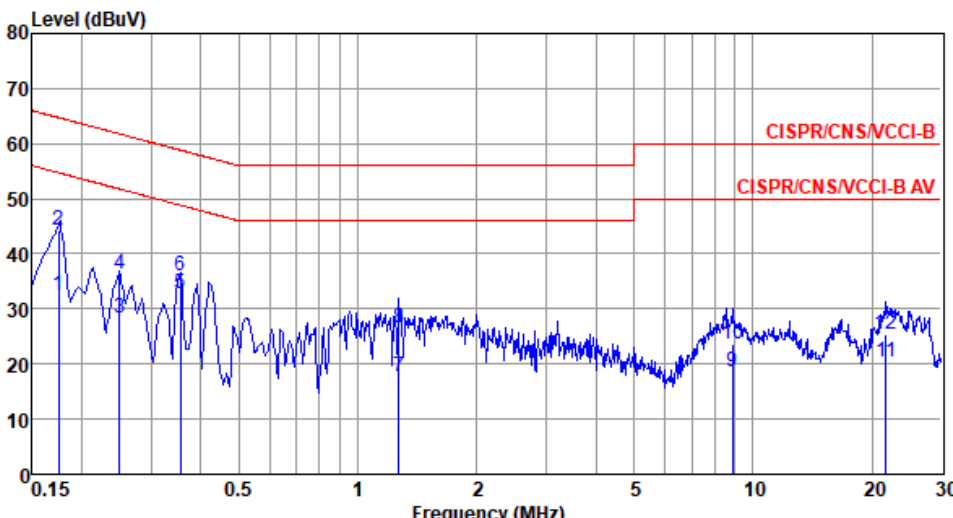

| | Freq MHz | Level dBuV | Limit Line dBuV | Over Limit dB | Read Level dBuV | Factor dB | Cable loss dB | Aux dB | Remark |
|----|-------------|---------------|-----------------------|---------------------|-----------------------|--------------|---------------------|-----------|---------|
| 1 | 0.175 | 32.42 | 54.73 | -22.31 | 22.48 | 9.65 | 0.08 | 0.21 | Average |
| 2 | 0.175 | 44.21 | 64.73 | -20.52 | 34.27 | 9.65 | 0.08 | 0.21 | QP |
| 3 | 0.249 | 28.25 | 51.78 | -23.53 | 18.26 | 9.65 | 0.08 | 0.26 | Average |
| 4 | 0.249 | 36.38 | 61.78 | -25.40 | 26.39 | 9.65 | 0.08 | 0.26 | QP |
| 5* | 0.356 | 32.75 | 48.82 | -16.07 | 22.69 | 9.64 | 0.08 | 0.34 | Average |
| 6 | 0.356 | 35.97 | 58.82 | -22.85 | 25.91 | 9.64 | 0.08 | 0.34 | QP |
| 7 | 1.269 | 17.74 | 46.00 | -28.26 | 7.54 | 9.65 | 0.17 | 0.38 | Average |
| 8 | 1.269 | 26.71 | 56.00 | -29.29 | 16.51 | 9.65 | 0.17 | 0.38 | QP |
| 9 | 8.869 | 18.53 | 50.00 | -31.47 | 7.97 | 9.70 | 0.42 | 0.44 | Average |
| 10 | 8.869 | 23.49 | 60.00 | -36.51 | 12.93 | 9.70 | 0.42 | 0.44 | QP |
| 11 | 21.715 | 20.25 | 50.00 | -29.75 | 9.25 | 9.67 | 0.67 | 0.66 | Average |
| 12 | 21.715 | 25.29 | 60.00 | -34.71 | 14.29 | 9.67 | 0.67 | 0.66 | QP |

Note 1: Level (dBuV) = Read Level (dBuV) + LISN Factor (dB) + Cable Loss (dB) + Aux (dB).
 Note 2: Over Limit (dB) = Level (dBuV) – Limit Line (dBuV).

| | | | |
|--------------------|---------|-------------------------|------|
| Modulation | 11g | Test Freq. (MHz) | 2437 |
| Power Phase | Neutral | | |

Test by : Joe Liao Temperature: 16°C Humidity: 64%

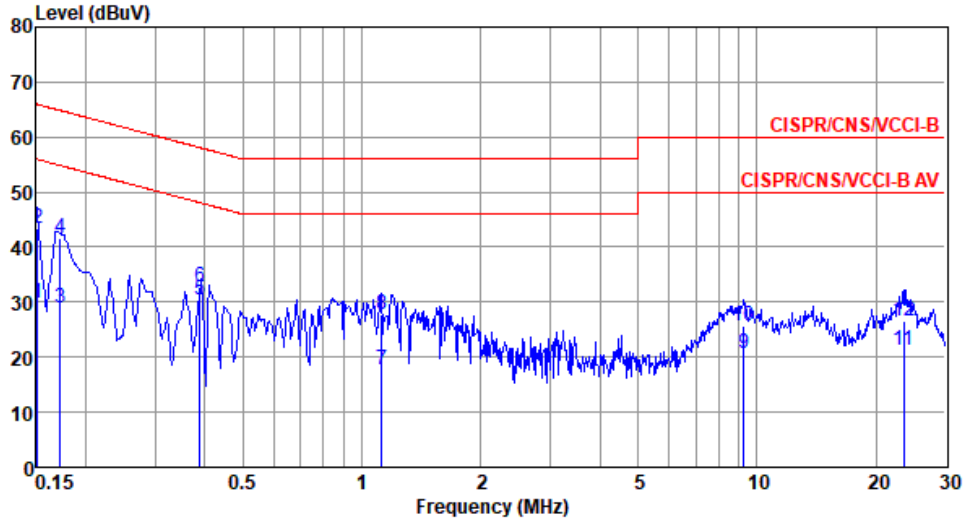

| | Freq MHz | Level dBuV | Limit Line dBuV | Over Limit dB | Read Level dBuV | Factor dB | Cable loss dB | Aux dB | Remark |
|----|-------------|---------------|-----------------------|---------------------|-----------------------|--------------|---------------------|-----------|---------|
| 1 | 0.151 | 29.72 | 55.96 | -26.24 | 19.79 | 9.69 | 0.08 | 0.16 | Average |
| 2 | 0.151 | 43.52 | 65.96 | -22.44 | 33.59 | 9.69 | 0.08 | 0.16 | QP |
| 3 | 0.172 | 28.86 | 54.86 | -26.00 | 18.92 | 9.69 | 0.08 | 0.17 | Average |
| 4 | 0.172 | 41.54 | 64.86 | -23.32 | 31.60 | 9.69 | 0.08 | 0.17 | QP |
| 5* | 0.390 | 30.28 | 48.07 | -17.79 | 20.34 | 9.67 | 0.08 | 0.19 | Average |
| 6 | 0.390 | 32.67 | 58.07 | -25.40 | 22.73 | 9.67 | 0.08 | 0.19 | QP |
| 7 | 1.123 | 17.78 | 46.00 | -28.22 | 7.65 | 9.68 | 0.17 | 0.28 | Average |
| 8 | 1.123 | 27.78 | 56.00 | -28.22 | 17.65 | 9.68 | 0.17 | 0.28 | QP |
| 9 | 9.253 | 20.67 | 50.00 | -29.33 | 10.12 | 9.75 | 0.43 | 0.37 | Average |
| 10 | 9.253 | 25.59 | 60.00 | -34.41 | 15.04 | 9.75 | 0.43 | 0.37 | QP |
| 11 | 23.511 | 21.33 | 50.00 | -28.67 | 10.31 | 9.84 | 0.68 | 0.50 | Average |
| 12 | 23.511 | 26.66 | 60.00 | -33.34 | 15.64 | 9.84 | 0.68 | 0.50 | QP |

Note 1: Level (dBuV) = Read Level (dBuV) + LISN Factor (dB) + Cable Loss (dB) + Aux (dB).
 Note 2: Over Limit (dB) = Level (dBuV) – Limit Line (dBuV).

3.2 6dB and Occupied Bandwidth

3.2.1 Limit of 6dB Bandwidth

The minimum 6dB bandwidth shall be at least 500 kHz.

3.2.2 Test Procedures

6dB Bandwidth

1. Set resolution bandwidth (RBW) = 100 kHz, Video bandwidth = 300 kHz.
2. Detector = Peak, Trace mode = max hold.
3. Sweep = auto couple, Allow the trace to stabilize.
4. Measure the maximum width of the emission that is constrained by the frequencies associated with the two outermost amplitude points (upper and lower) that are attenuated by 6dB relative to the maximum level measured in the fundamental emission.

Occupied Bandwidth

1. Set resolution bandwidth (RBW) = 1% ~ 5 % of OBW, Video bandwidth = 3 x RBW
2. Detector = Sample, Trace mode = max hold.
3. Sweep = auto couple, Allow the trace to stabilize.
4. Use the OBW measurement function of spectrum analyzer to measure the occupied bandwidth.

3.2.3 Test Setup

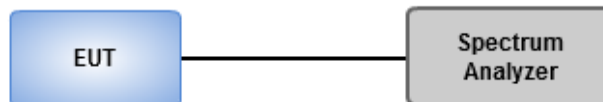

3.2.4 Test Result of 6dB and Occupied Bandwidth

| | | | |
|--------------------------|------------|------------------|------------|
| Ambient Condition | 21°C / 66% | Tested By | Aska Huang |
|--------------------------|------------|------------------|------------|

Summary

| Mode | Max-N dB (Hz) | Max-OBW (Hz) | ITU-Code | Min-N dB (Hz) | Min-OBW (Hz) |
|---|------------------|-----------------|----------|------------------|-----------------|
| 2.4-2.4835GHz | - | - | - | - | - |
| 802.11b_Nss1,(1Mbps)_1TX | 8.116M | 11.939M | 11M9G1D | 8.043M | 11.867M |
| 802.11g_Nss1,(6Mbps)_2TX | 16.377M | 19.03M | 19M0D1D | 16.159M | 16.57M |
| 802.11ax HEW20_Nss1,(MCS0)_2TX-OFDMA | 19.13M | 19.103M | 19M1D1D | 18.841M | 18.958M |
| 802.11ax HEW40_Nss1,(MCS0)_2TX-OFDMA | 38.261M | 38.495M | 38M5D1D | 38.116M | 37.627M |

Max-N dB = Maximum 6dB down bandwidth; **Max-OBW** = Maximum 99% occupied bandwidth;
Min-N dB = Minimum 6dB down bandwidth; **Min-OBW** = Minimum 99% occupied bandwidth;

Result

| Mode | Result | Limit (Hz) | Port 1-N dB (Hz) | Port 1-OBW (Hz) | Port 2-N dB (Hz) | Port 2-OBW (Hz) |
|--------------------------------------|--------|---------------|---------------------|--------------------|---------------------|--------------------|
| 802.11b_Nss1,(1Mbps)_1TX | - | - | - | - | - | - |
| 2412MHz | Pass | 500k | 8.043M | 11.867M | | |
| 2437MHz | Pass | 500k | 8.043M | 11.939M | | |
| 2462MHz | Pass | 500k | 8.116M | 11.939M | | |
| 802.11g_Nss1,(6Mbps)_2TX | - | - | - | - | - | - |
| 2412MHz | Pass | 500k | 16.377M | 16.787M | 16.377M | 16.57M |
| 2437MHz | Pass | 500k | 16.304M | 19.03M | 16.377M | 18.741M |
| 2462MHz | Pass | 500k | 16.159M | 16.787M | 16.377M | 16.643M |
| 802.11ax HEW20_Nss1,(MCS0)_2TX-OFDMA | - | - | - | - | - | - |
| 2412MHz | Pass | 500k | 19.058M | 18.958M | 18.841M | 18.958M |
| 2437MHz | Pass | 500k | 19.058M | 19.103M | 19.13M | 19.03M |
| 2462MHz | Pass | 500k | 19.13M | 18.958M | 19.13M | 18.958M |
| 802.11ax HEW40_Nss1,(MCS0)_2TX-OFDMA | - | - | - | - | - | - |
| 2422MHz | Pass | 500k | 38.116M | 38.205M | 38.116M | 38.35M |
| 2437MHz | Pass | 500k | 38.261M | 38.495M | 38.261M | 38.061M |
| 2452MHz | Pass | 500k | 38.116M | 37.916M | 38.116M | 37.627M |

Port X-N dB = Port X 6dB down bandwidth; **Port X-OBW** = Port X 99% occupied bandwidth;

802.11b_Nss1,(1Mbps)_1TX

EBW

2412MHz

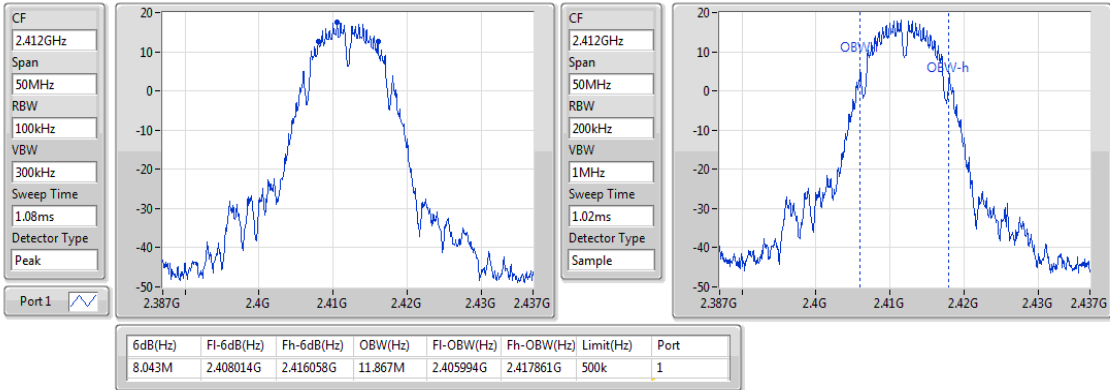

802.11b_Nss1,(1Mbps)_1TX

EBW

2437MHz

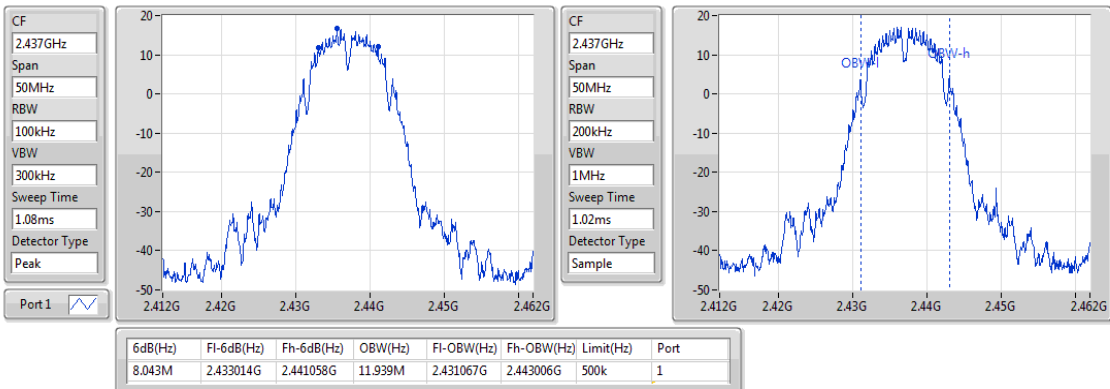

802.11b_Nss1,(1Mbps)_1TX

EBW

2462MHz

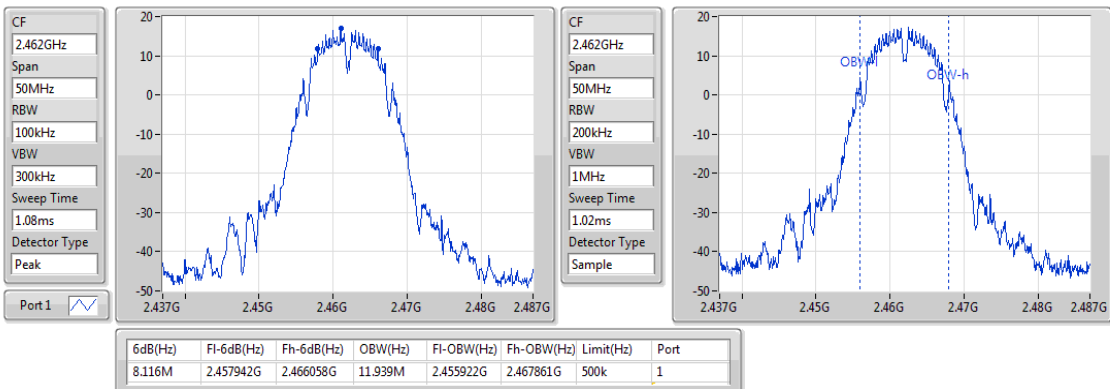

802.11g_Nss1,(6Mbps)_2TX

EBW

2412MHz

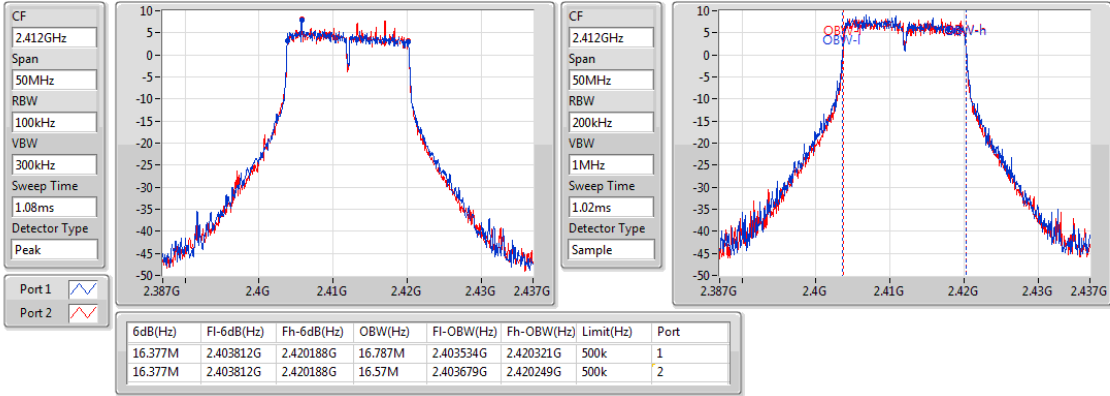

802.11g_Nss1,(6Mbps)_2TX

EBW

2437MHz

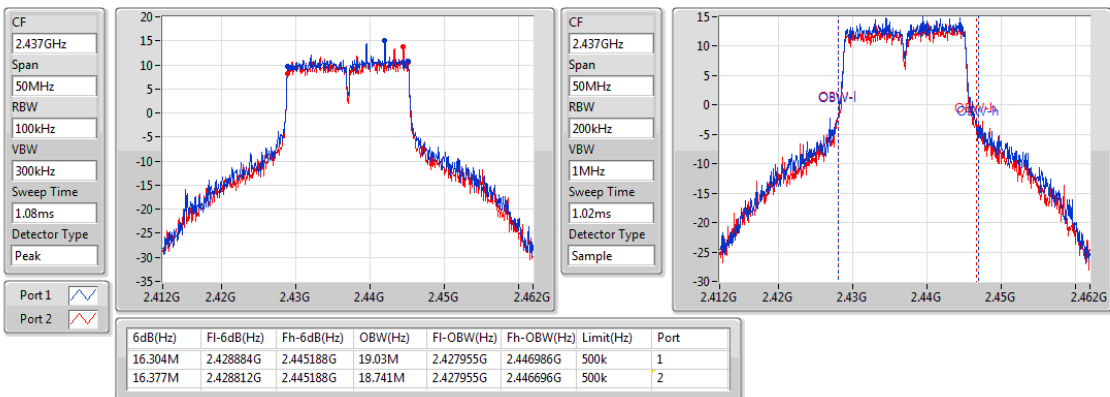

802.11g_Nss1,(6Mbps)_2TX

EBW

2462MHz

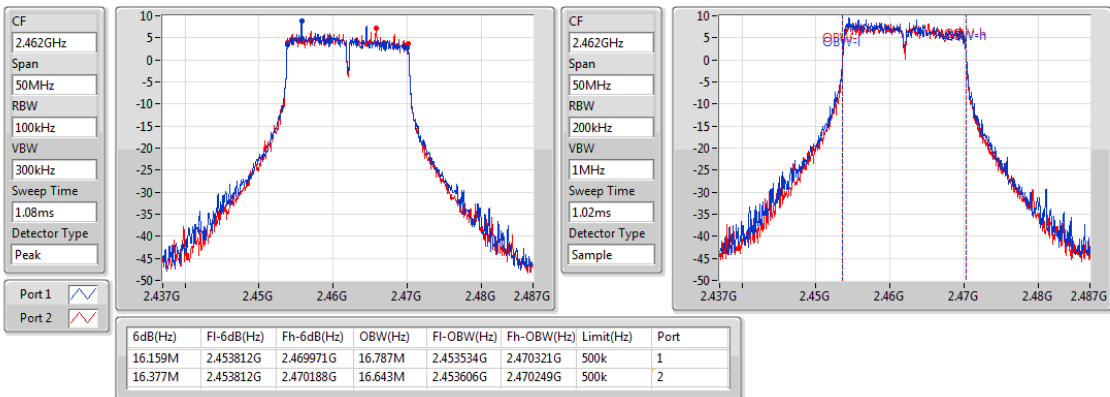

802.11ax HEW20_Nss1,(MCS0)_2TX

EBW

2412MHz

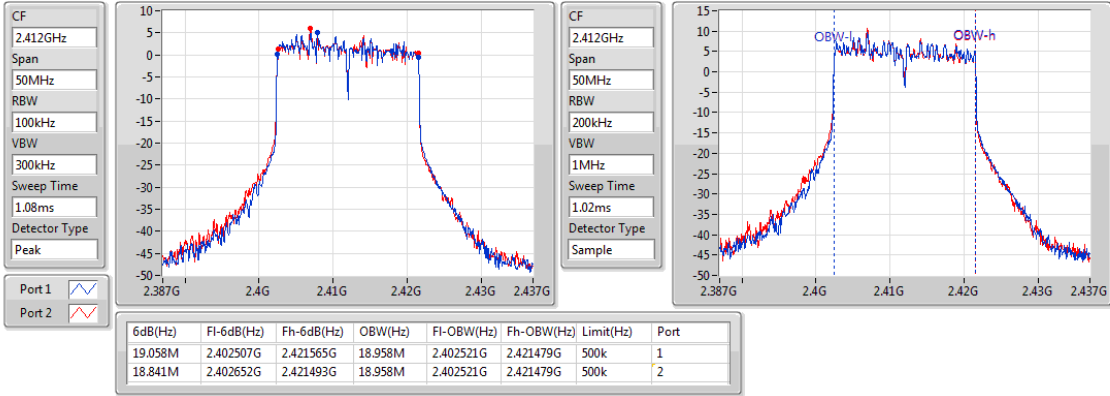

802.11ax HEW20_Nss1,(MCS0)_2TX

EBW

2437MHz

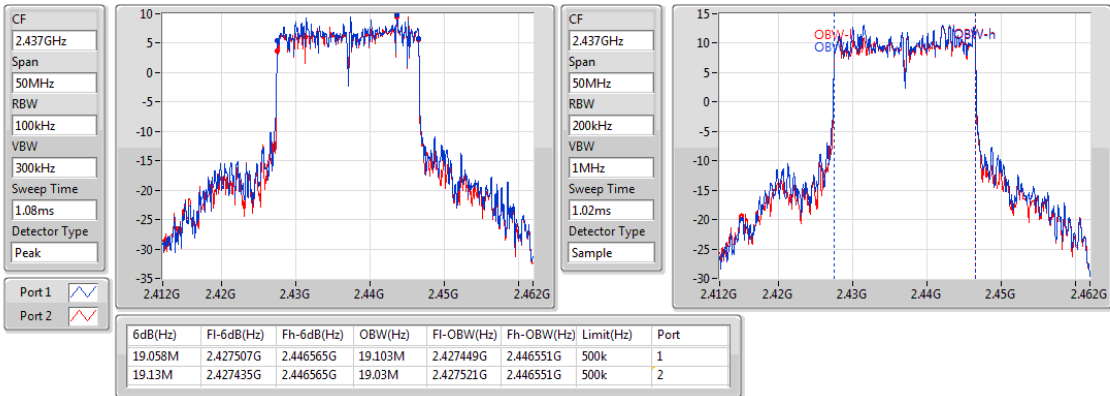

802.11ax HEW20_Nss1,(MCS0)_2TX

EBW

2462MHz

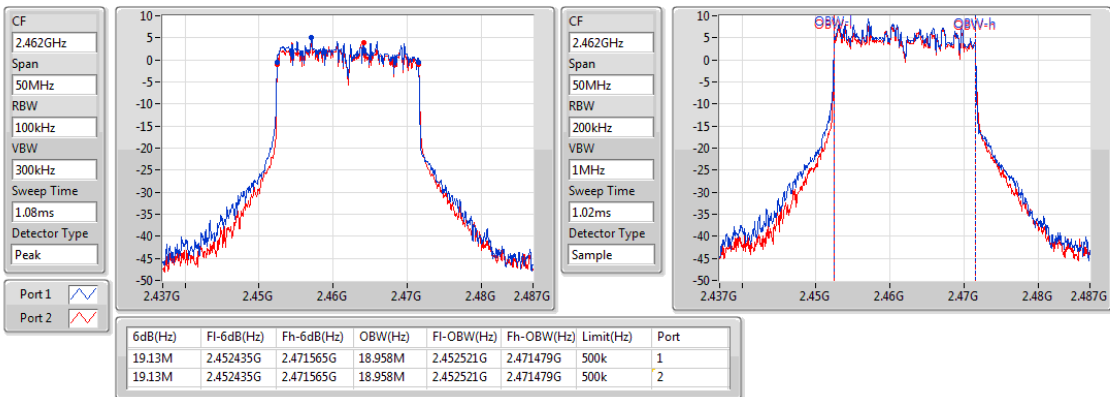

802.11ax HEW40_Nss1,(MCS0)_2TX

EBW

2422MHz

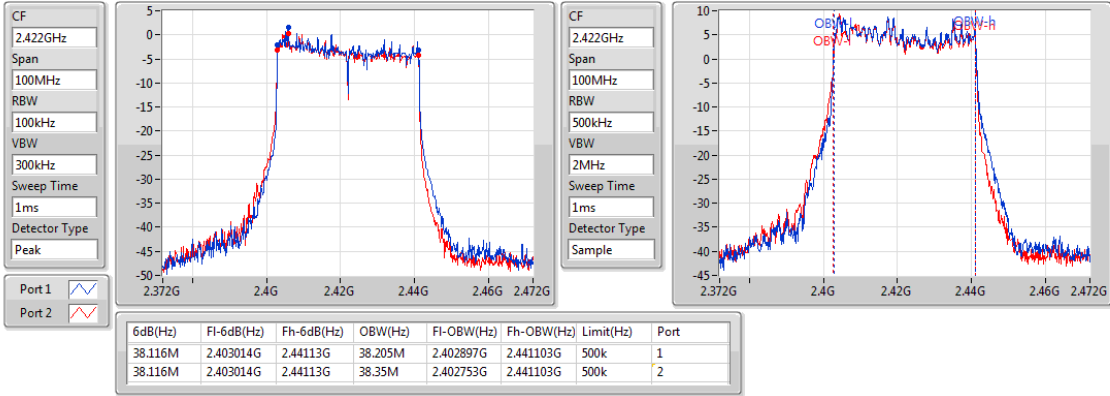

802.11ax HEW40_Nss1,(MCS0)_2TX

EBW

2437MHz

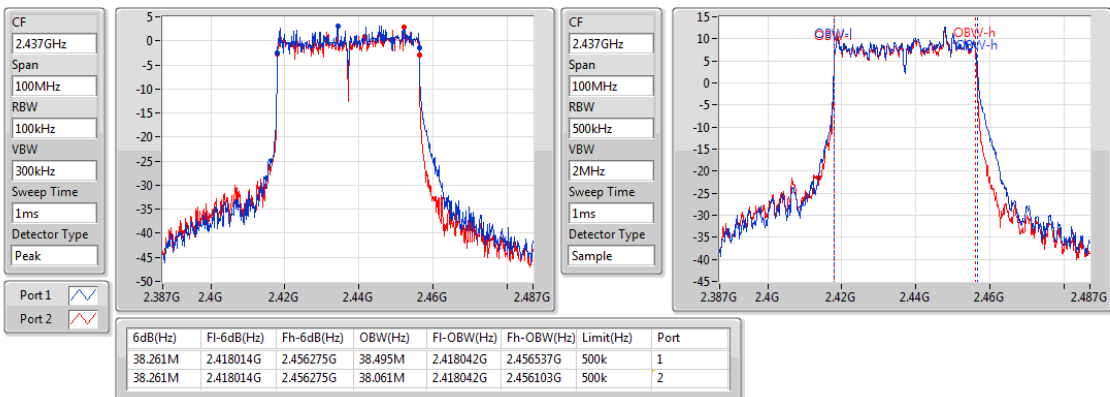

802.11ax HEW40_Nss1,(MCS0)_2TX

EBW

2452MHz

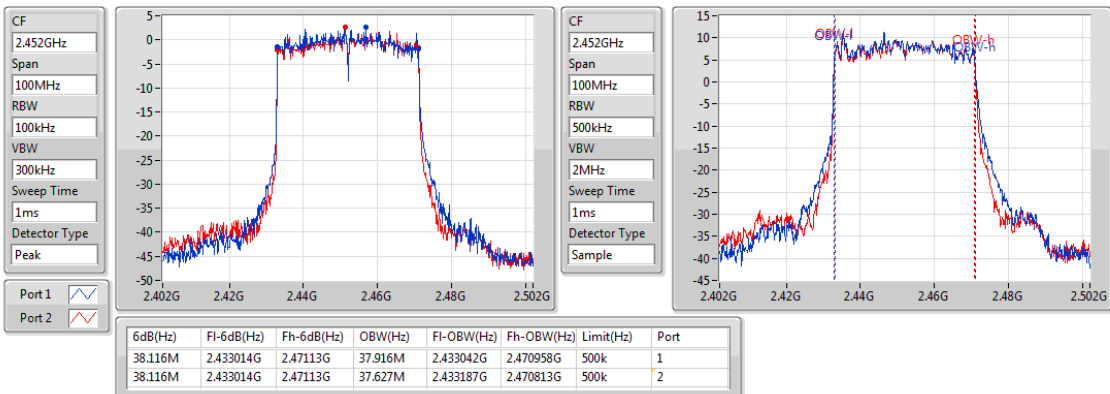

3.3 RF Output Power

3.3.1 Limit of RF Output Power

Conducted power shall not exceed 1Watt.

Antenna gain $\leq 6\text{dBi}$, no any corresponding reduction is in output power limit.

3.3.2 Test Procedures

A broadband RF power meter is used for output power measurement. The video bandwidth of power meter is greater than DTS bandwidth of EUT. If duty cycle of test signal is not 100 %, trigger and gating function of power meter will be enabled to capture transmission burst for measuring output power.

3.3.3 Test Setup

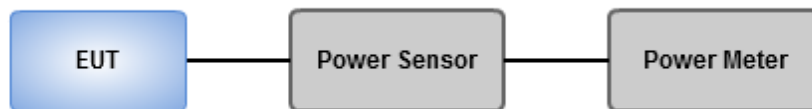

3.3.4 Test Result of Maximum Output Power

| | | | |
|--------------------------|------------|------------------|------------|
| Ambient Condition | 21°C / 66% | Tested By | Aska Huang |
|--------------------------|------------|------------------|------------|

Non-beamforming mode

Summary of Conducted (Average) Output Power

| Mode | Total Power (dBm) | Total Power (W) |
|---|----------------------|--------------------|
| 2.4-2.4835GHz | - | - |
| 802.11b_Nss1,(1Mbps)_1TX | 26.23 | 0.41976 |
| 802.11g_Nss1,(6Mbps)_2TX | 28.69 | 0.73961 |
| 802.11ax HEW20_Nss1,(MCS0)_2TX-OFDMA | 27.08 | 0.51050 |
| 802.11ax HEW40_Nss1,(MCS0)_2TX-OFDMA | 24.00 | 0.25119 |

Result

| Mode | Result | DG (dBi) | Port 1 (dBm) | Port 2 (dBm) | Total Power (dBm) | Power Limit (dBm) | EIRP (dBm) | EIRP Limit (dBm) |
|---|--------|-------------|-----------------|-----------------|-------------------------|-------------------------|---------------|---------------------|
| 802.11b_Nss1,(1Mbps)_1TX | - | - | - | - | - | - | - | - |
| 2412MHz | Pass | 4.20 | 26.23 | - | 26.23 | 30.00 | 30.43 | 36.00 |
| 2437MHz | Pass | 4.20 | 25.76 | - | 25.76 | 30.00 | 29.96 | 36.00 |
| 2462MHz | Pass | 4.20 | 25.77 | - | 25.77 | 30.00 | 29.97 | 36.00 |
| 802.11g_Nss1,(6Mbps)_2TX | - | - | - | - | - | - | - | - |
| 2412MHz | Pass | 4.20 | 19.61 | 19.76 | 22.70 | 30.00 | 26.90 | 36.00 |
| 2437MHz | Pass | 4.20 | 25.75 | 25.61 | 28.69 | 30.00 | 32.89 | 36.00 |
| 2462MHz | Pass | 4.20 | 20.1 | 20.05 | 23.09 | 30.00 | 27.29 | 36.00 |
| 802.11ax HEW20_Nss1,(MCS0)_2TX-OFDMA | - | - | - | - | - | - | - | - |
| 2412MHz | Pass | 4.20 | 19.93 | 19.73 | 22.84 | 30.00 | 27.04 | 36.00 |
| 2437MHz | Pass | 4.20 | 24.14 | 23.99 | 27.08 | 30.00 | 31.28 | 36.00 |
| 2462MHz | Pass | 4.20 | 20.09 | 20.12 | 23.12 | 30.00 | 27.32 | 36.00 |
| 802.11ax HEW40_Nss1,(MCS0)_2TX-OFDMA | - | - | - | - | - | - | - | - |
| 2422MHz | Pass | 4.20 | 17.82 | 17.63 | 20.74 | 30.00 | 24.94 | 36.00 |
| 2437MHz | Pass | 4.20 | 21.11 | 20.86 | 24.00 | 30.00 | 28.20 | 36.00 |
| 2452MHz | Pass | 4.20 | 19.93 | 20.12 | 23.04 | 30.00 | 27.24 | 36.00 |

DG = Directional Gain; Port X = Port X output power

Beamforming mode

Summary of Conducted (Average) Output Power

| Mode | Total Power (dBm) | Total Power (W) |
|--|-------------------|-----------------|
| 2.4-2.4835GHz | - | - |
| 802.11ax HEW20-BF_Nss1,(MCS0)_2TX-OFDMA | 27.03 | 0.50466 |
| 802.11ax HEW40-BF_Nss1,(MCS0)_2TX-OFDMA | 23.90 | 0.24547 |

Result

| Mode | Result | DG (dBi) | Port 1 (dBm) | Port 2 (dBm) | Total Power (dBm) | Power Limit (dBm) | EIRP (dBm) | EIRP Limit (dBm) |
|--|--------|----------|--------------|--------------|-------------------|-------------------|------------|------------------|
| 802.11ax HEW20-BF_Nss1,(MCS0)_2TX-OFDM A | - | - | - | - | - | - | - | - |
| 2412MHz | Pass | 6.82 | 19.81 | 19.65 | 22.74 | 29.18 | 29.56 | 36.00 |
| 2437MHz | Pass | 6.82 | 24.09 | 23.95 | 27.03 | 29.18 | 33.85 | 36.00 |
| 2462MHz | Pass | 6.82 | 20.03 | 20.01 | 23.03 | 29.18 | 29.85 | 36.00 |
| 802.11ax HEW40-BF_Nss1,(MCS0)_2TX-OFDM A | - | - | - | - | - | - | - | - |
| 2422MHz | Pass | 6.82 | 17.71 | 17.52 | 20.63 | 29.18 | 27.45 | 36.00 |
| 2437MHz | Pass | 6.82 | 21.05 | 20.73 | 23.90 | 29.18 | 30.72 | 36.00 |
| 2452MHz | Pass | 6.82 | 19.82 | 20.05 | 22.95 | 29.18 | 29.77 | 36.00 |

DG = Directional Gain; Port X = Port X output power

Directional Gain = $10 * \log((10^{4.2/20} + 10^{3.4/20})^2 / 2) = 6.82 \text{ dBi} > 6 \text{ dBi}$, limit shall be reduced to $30 \text{ dBm} - (6.82 \text{ dBi} - 6 \text{ dBi}) = 29.18 \text{ dBm}$

3.4 Power Spectral Density

3.4.1 Limit of Power Spectral Density

Power spectral density shall not be greater than 8 dBm in any 3 kHz band.

3.4.2 Test Procedures

- 1 Set RBW to: $3 \text{ kHz} \leq \text{RBW} \leq 100 \text{ kHz}$, Set VBW $\geq [3 \times \text{RBW}]$. Detector = RMS.
- 2 Sweep time = auto couple.
- 3 Employ trace averaging (RMS) mode over a minimum of 100 traces.
- 4 Use the peak marker function to determine the maximum amplitude level.

3.4.3 Test Setup

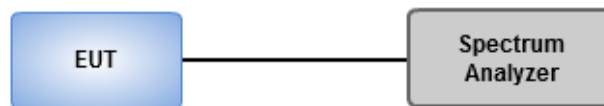

3.4.4 Test Result of Power Spectral Density

| | | | |
|--------------------------|------------|------------------|------------|
| Ambient Condition | 21°C / 66% | Tested By | Aska Huang |
|--------------------------|------------|------------------|------------|

Summary

| Mode | PD (dBm/RBW) |
|--------------------------------------|-----------------|
| 2.4-2.4835GHz | - |
| 802.11b_Nss1,(1Mbps)_1TX | -2.69 |
| 802.11g_Nss1,(6Mbps)_2TX | -3.12 |
| 802.11ax HEW20_Nss1,(MCS0)_2TX-OFDMA | 7.00 |
| 802.11ax HEW40_Nss1,(MCS0)_2TX-OFDMA | 1.97 |

RBW= 3 kHz

Result

| Mode | Result | DG (dBi) | Port 1 (dBm/RBW) | Port 2 (dBm/RBW) | PD (dBm/RBW) | PD Limit (dBm/RBW) |
|--------------------------------------|--------|-------------|---------------------|---------------------|-----------------|-----------------------|
| 802.11b_Nss1,(1Mbps)_1TX | - | - | - | - | - | - |
| 2412MHz | Pass | 4.20 | -2.69 | - | -2.69 | 8.00 |
| 2437MHz | Pass | 4.20 | -3.91 | - | -3.91 | 8.00 |
| 2462MHz | Pass | 4.20 | -3.98 | - | -3.98 | 8.00 |
| 802.11g_Nss1,(6Mbps)_2TX | - | - | - | - | - | - |
| 2412MHz | Pass | 6.82 | -11.17 | -11.52 | -9.49 | 7.18 |
| 2437MHz | Pass | 6.82 | -5.95 | -5.81 | -3.12 | 7.18 |
| 2462MHz | Pass | 6.82 | -11.43 | -11.48 | -9.08 | 7.18 |
| 802.11ax HEW20_Nss1,(MCS0)_2TX-OFDMA | - | - | - | - | - | - |
| 2412MHz | Pass | 6.82 | -1.11 | -0.59 | 2.01 | 7.18 |
| 2437MHz | Pass | 6.82 | 4.27 | 3.70 | 7.00 | 7.18 |
| 2462MHz | Pass | 6.82 | -0.26 | -0.50 | 2.63 | 7.18 |
| 802.11ax HEW40_Nss1,(MCS0)_2TX-OFDMA | - | - | - | - | - | - |
| 2422MHz | Pass | 6.82 | -4.44 | -5.56 | -1.95 | 7.18 |
| 2437MHz | Pass | 6.82 | -1.20 | -0.89 | 1.97 | 7.18 |
| 2452MHz | Pass | 6.82 | -2.42 | -2.22 | 0.69 | 7.18 |

DG = Directional Gain

For 2TX function

Directional Gain = $10 * \log((10^{4.2/20} + 10^{3.4/20})^2 / 2) = 6.82 \text{ dBi} > 6 \text{ dBi}$, limit shall be reduced to 8 dBm – (6.82 dBi – 6 dBi) = 7.18 dBm

PD = trace bin-by-bin of each transmits port summing can be performed maximum power density;

Port X = Port X power density;

RBW= 3 kHz

802.11b_Nss1,(1Mbps)_1TX

PSD

2412MHz

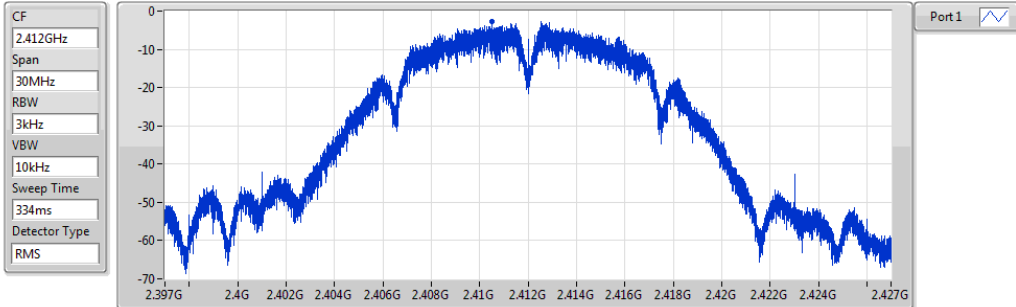

| Sum | PD | Port 1 |
|-----------|-----------|-----------|
| (dBm/RBW) | (dBm/RBW) | (dBm/RBW) |
| -2.69 | -2.69 | -2.69 |

802.11b_Nss1,(1Mbps)_1TX

PSD

2437MHz

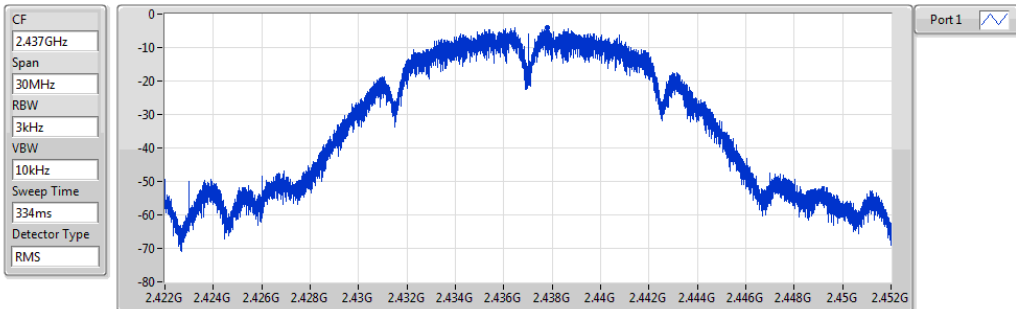

| Sum | PD | Port 1 |
|-----------|-----------|-----------|
| (dBm/RBW) | (dBm/RBW) | (dBm/RBW) |
| -3.91 | -3.91 | -3.91 |

802.11b_Nss1,(1Mbps)_1TX

PSD

2462MHz

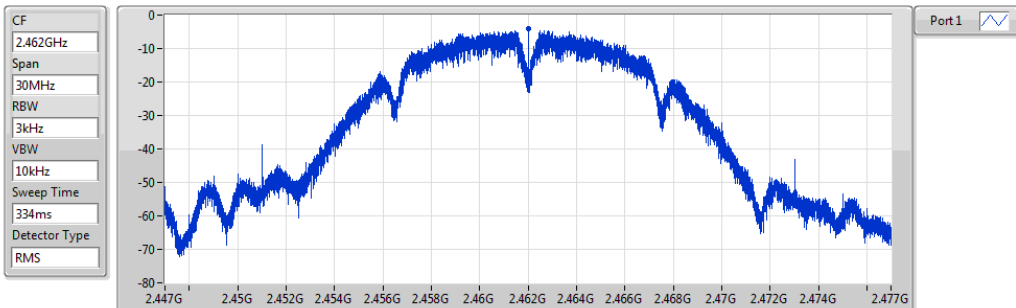

| Sum | PD | Port 1 |
|-----------|-----------|-----------|
| (dBm/RBW) | (dBm/RBW) | (dBm/RBW) |
| -3.98 | -3.98 | -3.98 |

802.11g_Nss1,(6Mbps)_2TX

PSD

2412MHz

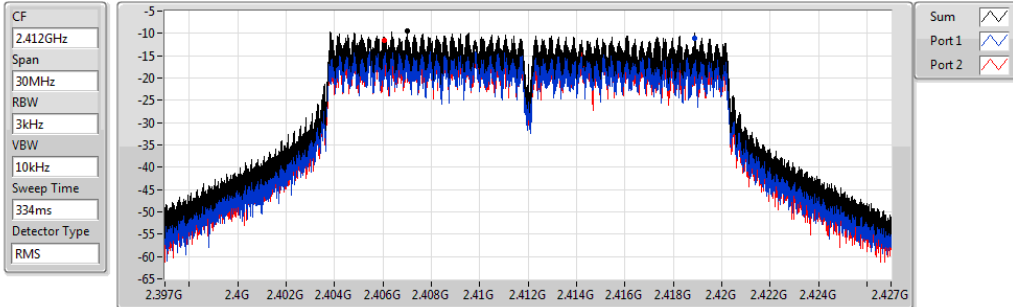

| Sum | PD | Port 1 | Port 2 |
|-----------|-----------|-----------|-----------|
| (dBm/RBW) | (dBm/RBW) | (dBm/RBW) | (dBm/RBW) |
| -9.49 | -9.49 | -11.17 | -11.52 |

802.11g_Nss1,(6Mbps)_2TX

PSD

2437MHz

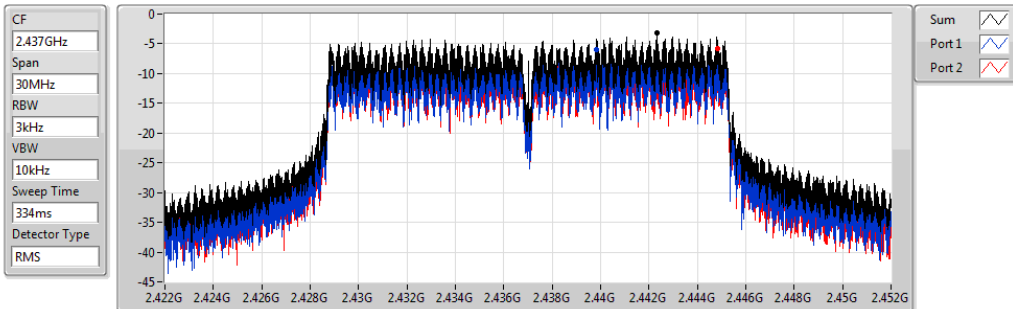

| Sum | PD | Port 1 | Port 2 |
|-----------|-----------|-----------|-----------|
| (dBm/RBW) | (dBm/RBW) | (dBm/RBW) | (dBm/RBW) |
| -3.12 | -3.12 | -5.95 | -5.81 |

802.11g_Nss1,(6Mbps)_2TX

PSD

2462MHz

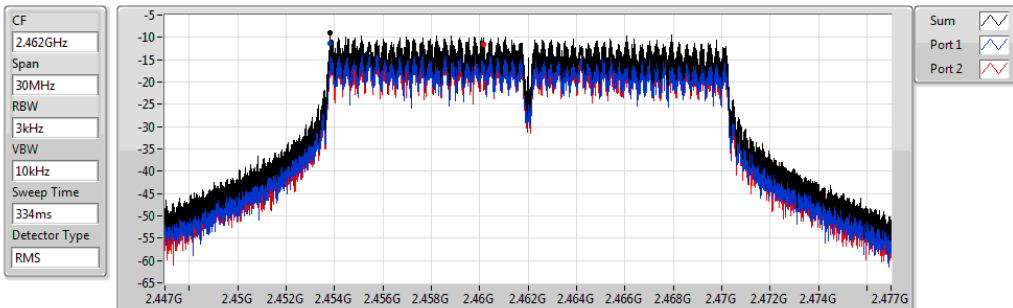

| Sum | PD | Port 1 | Port 2 |
|-----------|-----------|-----------|-----------|
| (dBm/RBW) | (dBm/RBW) | (dBm/RBW) | (dBm/RBW) |
| -9.08 | -9.08 | -11.43 | -11.48 |

802.11ax HEW20_Nss1,(MCS0)_2TX

PSD

2412MHz

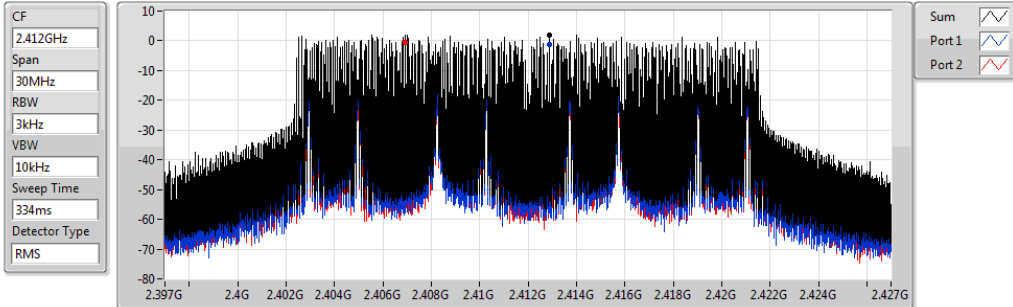

| Sum | PD | Port 1 | Port 2 |
|-----------|-----------|-----------|-----------|
| (dBm/RBW) | (dBm/RBW) | (dBm/RBW) | (dBm/RBW) |
| 2.01 | 2.01 | -1.11 | -0.59 |

802.11ax HEW20_Nss1,(MCS0)_2TX

PSD

2437MHz

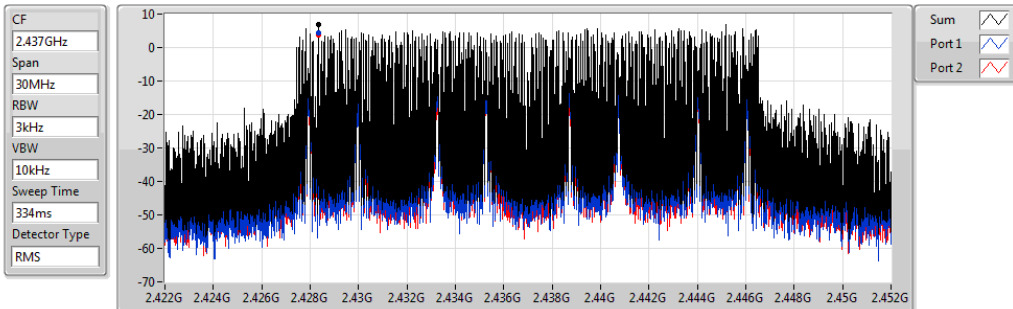

| Sum | PD | Port 1 | Port 2 |
|-----------|-----------|-----------|-----------|
| (dBm/RBW) | (dBm/RBW) | (dBm/RBW) | (dBm/RBW) |
| 7.00 | 7.00 | 4.27 | 3.70 |

802.11ax HEW20_Nss1,(MCS0)_2TX

PSD

2462MHz

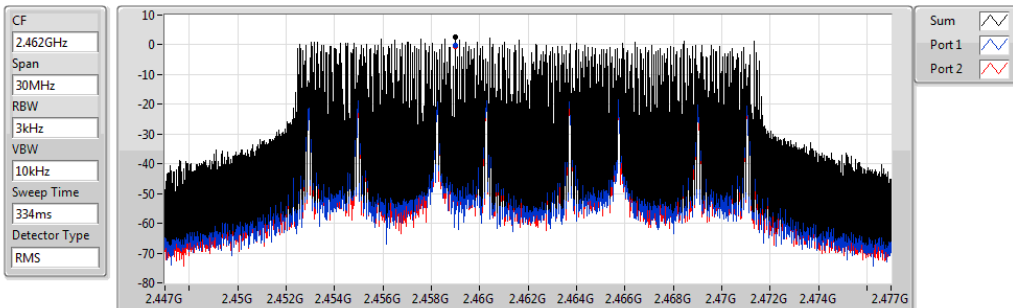

| Sum | PD | Port 1 | Port 2 |
|-----------|-----------|-----------|-----------|
| (dBm/RBW) | (dBm/RBW) | (dBm/RBW) | (dBm/RBW) |
| 2.63 | 2.63 | -0.26 | -0.50 |

802.11ax HEW40_Nss1,(MCS0)_2TX

PSD

2422MHz

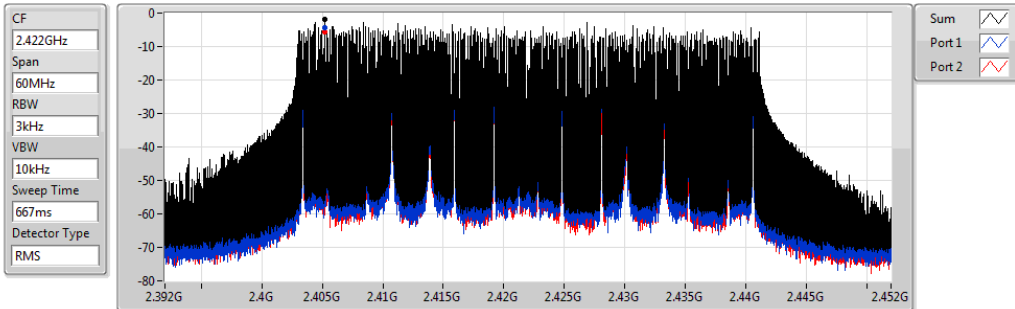

| Sum | PD | Port 1 | Port 2 |
|-----------|-----------|-----------|-----------|
| (dBm/RBW) | (dBm/RBW) | (dBm/RBW) | (dBm/RBW) |
| -1.95 | -1.95 | -4.44 | -5.56 |

802.11ax HEW40_Nss1,(MCS0)_2TX

PSD

2437MHz

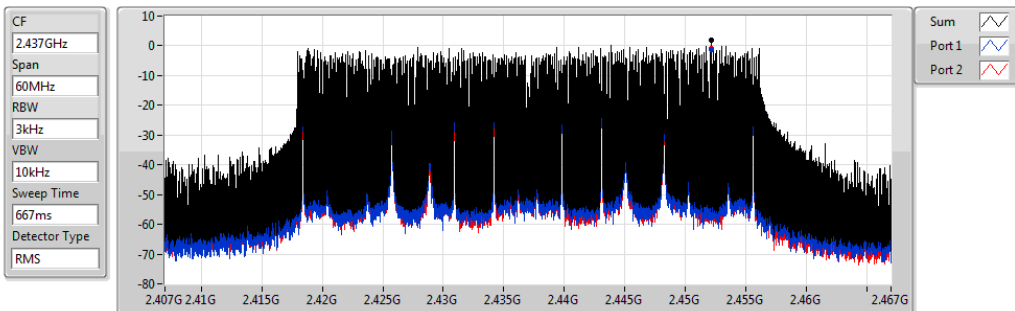

| Sum | PD | Port 1 | Port 2 |
|-----------|-----------|-----------|-----------|
| (dBm/RBW) | (dBm/RBW) | (dBm/RBW) | (dBm/RBW) |
| 1.97 | 1.97 | -1.20 | -0.89 |

802.11ax HEW40_Nss1,(MCS0)_2TX

PSD

2452MHz

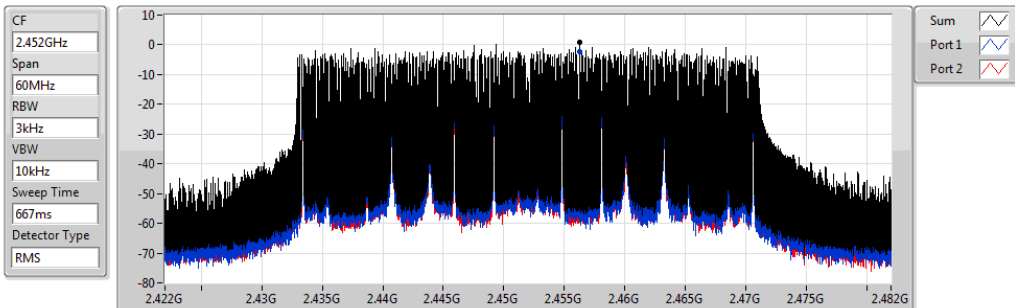

| Sum | PD | Port 1 | Port 2 |
|-----------|-----------|-----------|-----------|
| (dBm/RBW) | (dBm/RBW) | (dBm/RBW) | (dBm/RBW) |
| 0.69 | 0.69 | -2.42 | -2.22 |

3.5 Unwanted Emissions into Restricted Frequency Bands

3.5.1 Limit of Unwanted Emissions into Restricted Frequency Bands

| Restricted Band Emissions Limit | | | |
|---------------------------------|-----------------------|-------------------------|----------------------|
| Frequency Range (MHz) | Field Strength (uV/m) | Field Strength (dBuV/m) | Measure Distance (m) |
| 0.009~0.490 | 2400/F(kHz) | 48.5 - 13.8 | 300 |
| 0.490~1.705 | 24000/F(kHz) | 33.8 - 23 | 30 |
| 1.705~30.0 | 30 | 29 | 30 |
| 30~88 | 100 | 40 | 3 |
| 88~216 | 150 | 43.5 | 3 |
| 216~960 | 200 | 46 | 3 |
| Above 960 | 500 | 54 | 3 |

Note 1:
Quasi-Peak value is measured for frequency below 1GHz except for 9–90 kHz, 110–490 kHz frequency band. Peak and average value are measured for frequency above 1GHz. The limit on average radio frequency emission is as above table. The limit on peak radio frequency emissions is 20 dB above the maximum permitted average emission limit

Note 2:
Measurements may be performed at a distance other than what is specified provided. When performing measurements at a distance other than that specified, the results shall be extrapolated to the specified distance using an extrapolation factor as below, Frequency at or above 30 MHz: 20 dB/decade Frequency below 30 MHz: 40 dB/decade.

3.5.2 Test Procedures

1. Measurement is made at a semi-anechoic chamber that incorporates a turntable allowing a EUT rotation of 360°. A continuously-rotating, remotely-controlled turntable is installed at the test site to support the EUT and facilitate determination of the direction of maximum radiation for each EUT emission frequency. The EUT is placed at test table. For emissions testing at or below 1 GHz, the table height is 80 cm above the reference ground plane. For emission measurements above 1 GHz, the table height is 1.5 m
2. Measurement is made with the antenna positioned in both the horizontal and vertical planes of polarization. The measurement antenna is varied in height (1m ~ 4m) above the reference ground plane to obtain the maximum signal strength. Distance between EUT and antenna is 3 m.
3. This investigation is performed with the EUT rotated 360°, the antenna height scanned between 1 m and 4 m, and the antenna rotated to repeat the measurements for both the horizontal and vertical antenna polarizations.

Note:

1. 120kHz measurement bandwidth of test receiver and Quasi-peak detector is for radiated emission below 1GHz.
2. RBW=1MHz, VBW=3MHz and Peak detector is for peak measured value of radiated emission above 1GHz.
3. RBW=1MHz, VBW=1/T and Peak detector is for average measured value of radiated emission above 1GHz.

3.5.3 Test Setup

Radiated Emissions below 1 GHz



Radiated Emissions above 1 GHz

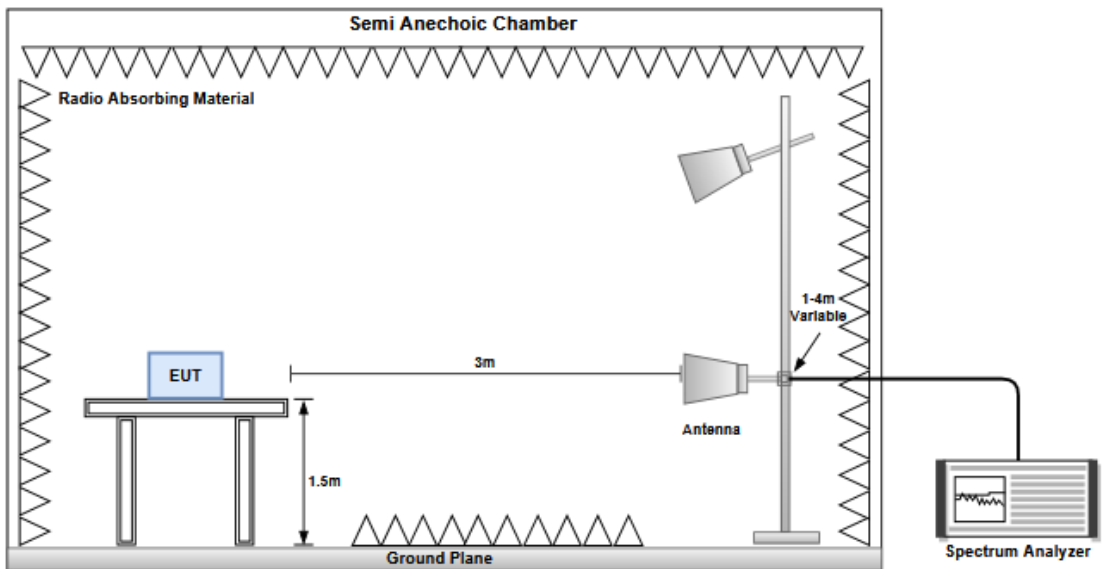

3.5.4 Transmitter Radiated Unwanted Emissions (Below 1GHz)

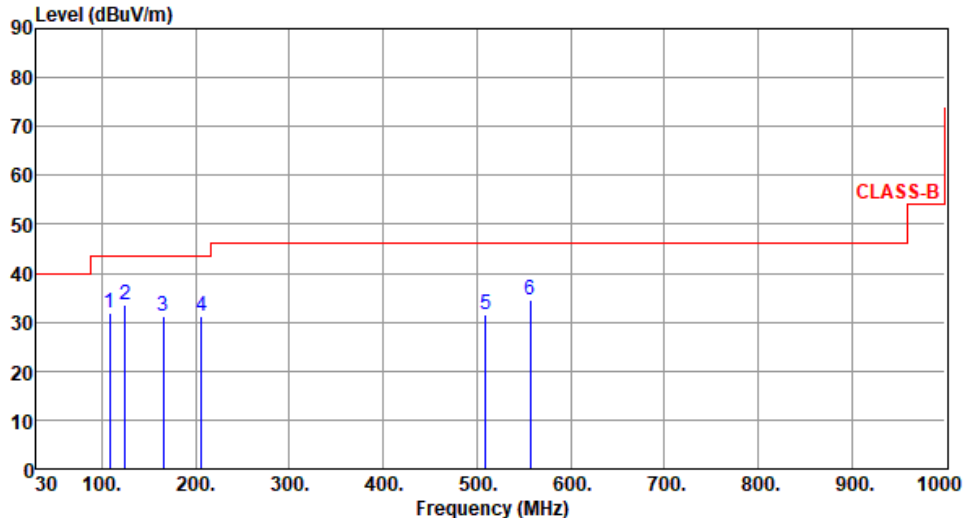
| Modulation | 11g | Test Freq. (MHz) | 2437 | | | | | | | | | | | | | | | | | | | | | | | | | | | | | | | | | | | | | | | | | | | | | | | | | | | | | | | | | | | | | |
|---|---|-------------------------|--------|--------|--------|---|---|--------|--------|--------|--------|--------|--------|-------|-------|-------|-------|-------|-------|-------|-------|-------|-------|-------|-------|--------|-------|--------|--------|--------|--------|-------|-------|-------|-------|-------|-------|--------|--------|-------|--------|-------|-------|------|------|------|------|------|------|-----|-----|-----|-----|-----|-----|-----|-----|-----|-----|-----|-----|--|--|--|
| Polarization | Horizontal | | | | | | | | | | | | | | | | | | | | | | | | | | | | | | | | | | | | | | | | | | | | | | | | | | | | | | | | | | | | | | | |
| Test By : Roger Lu Temperature(°C):23 Humidity(%):67 | | | | | | | | | | | | | | | | | | | | | | | | | | | | | | | | | | | | | | | | | | | | | | | | | | | | | | | | | | | | | | | | |
|  <p>The graph plots Level (dBuV/m) on the y-axis (0 to 90) against Frequency (MHz) on the x-axis (30 to 1000). A red line represents the CLASS-B limit, which is constant at 40 dBuV/m from 30 MHz to 100 MHz, then steps up to 45 dBuV/m from 100 MHz to 1000 MHz. Six blue vertical lines indicate emission peaks at 108.26 MHz (1), 124.35 MHz (2), 165.86 MHz (3), 206.59 MHz (4), 509.36 MHz (5), and 557.26 MHz (6). All peaks are well below the CLASS-B limit.</p> | | | | | | | | | | | | | | | | | | | | | | | | | | | | | | | | | | | | | | | | | | | | | | | | | | | | | | | | | | | | | | | | |
| | <table border="1"> <thead> <tr> <th>1</th> <th>2</th> <th>3</th> <th>4</th> <th>5</th> <th>6</th> </tr> </thead> <tbody> <tr> <td>108.26</td> <td>124.35</td> <td>165.86</td> <td>206.59</td> <td>509.36</td> <td>557.26</td> </tr> <tr> <td>31.98</td> <td>33.59</td> <td>31.26</td> <td>31.22</td> <td>31.58</td> <td>34.58</td> </tr> <tr> <td>43.50</td> <td>43.50</td> <td>43.50</td> <td>43.50</td> <td>46.00</td> <td>46.00</td> </tr> <tr> <td>-11.52</td> <td>-9.91</td> <td>-12.24</td> <td>-12.28</td> <td>-14.42</td> <td>-11.42</td> </tr> <tr> <td>44.03</td> <td>43.87</td> <td>40.22</td> <td>43.18</td> <td>34.65</td> <td>36.82</td> </tr> <tr> <td>-12.05</td> <td>-10.28</td> <td>-8.96</td> <td>-11.96</td> <td>-3.07</td> <td>-2.24</td> </tr> <tr> <td>Peak</td> <td>Peak</td> <td>Peak</td> <td>Peak</td> <td>Peak</td> <td>Peak</td> </tr> <tr> <td>---</td> <td>---</td> <td>---</td> <td>---</td> <td>---</td> <td>---</td> </tr> <tr> <td>---</td> <td>---</td> <td>---</td> <td>---</td> <td>---</td> <td>---</td> </tr> </tbody> </table> | 1 | 2 | 3 | 4 | 5 | 6 | 108.26 | 124.35 | 165.86 | 206.59 | 509.36 | 557.26 | 31.98 | 33.59 | 31.26 | 31.22 | 31.58 | 34.58 | 43.50 | 43.50 | 43.50 | 43.50 | 46.00 | 46.00 | -11.52 | -9.91 | -12.24 | -12.28 | -14.42 | -11.42 | 44.03 | 43.87 | 40.22 | 43.18 | 34.65 | 36.82 | -12.05 | -10.28 | -8.96 | -11.96 | -3.07 | -2.24 | Peak | Peak | Peak | Peak | Peak | Peak | --- | --- | --- | --- | --- | --- | --- | --- | --- | --- | --- | --- | | | |
| 1 | 2 | 3 | 4 | 5 | 6 | | | | | | | | | | | | | | | | | | | | | | | | | | | | | | | | | | | | | | | | | | | | | | | | | | | | | | | | | | | |
| 108.26 | 124.35 | 165.86 | 206.59 | 509.36 | 557.26 | | | | | | | | | | | | | | | | | | | | | | | | | | | | | | | | | | | | | | | | | | | | | | | | | | | | | | | | | | | |
| 31.98 | 33.59 | 31.26 | 31.22 | 31.58 | 34.58 | | | | | | | | | | | | | | | | | | | | | | | | | | | | | | | | | | | | | | | | | | | | | | | | | | | | | | | | | | | |
| 43.50 | 43.50 | 43.50 | 43.50 | 46.00 | 46.00 | | | | | | | | | | | | | | | | | | | | | | | | | | | | | | | | | | | | | | | | | | | | | | | | | | | | | | | | | | | |
| -11.52 | -9.91 | -12.24 | -12.28 | -14.42 | -11.42 | | | | | | | | | | | | | | | | | | | | | | | | | | | | | | | | | | | | | | | | | | | | | | | | | | | | | | | | | | | |
| 44.03 | 43.87 | 40.22 | 43.18 | 34.65 | 36.82 | | | | | | | | | | | | | | | | | | | | | | | | | | | | | | | | | | | | | | | | | | | | | | | | | | | | | | | | | | | |
| -12.05 | -10.28 | -8.96 | -11.96 | -3.07 | -2.24 | | | | | | | | | | | | | | | | | | | | | | | | | | | | | | | | | | | | | | | | | | | | | | | | | | | | | | | | | | | |
| Peak | Peak | Peak | Peak | Peak | Peak | | | | | | | | | | | | | | | | | | | | | | | | | | | | | | | | | | | | | | | | | | | | | | | | | | | | | | | | | | | |
| --- | --- | --- | --- | --- | --- | | | | | | | | | | | | | | | | | | | | | | | | | | | | | | | | | | | | | | | | | | | | | | | | | | | | | | | | | | | |
| --- | --- | --- | --- | --- | --- | | | | | | | | | | | | | | | | | | | | | | | | | | | | | | | | | | | | | | | | | | | | | | | | | | | | | | | | | | | |
| <p>Note 1: Emission Level (dBuV/m) = SA Reading (dBuV) + Factor* (dB/m) *Factor includes antenna factor , cable loss and amplifier gain Note 2: Margin (dB) = Emission level (dBuV/m) – Limit (dBuV/m). Note 3: All spurious emissions below 30MHz are more than 20 dB below the limit.</p> | | | | | | | | | | | | | | | | | | | | | | | | | | | | | | | | | | | | | | | | | | | | | | | | | | | | | | | | | | | | | | | | |

| | | | |
|---------------------|----------|-------------------------|------|
| Modulation | 11g | Test Freq. (MHz) | 2437 |
| Polarization | Vertical | | |

Test By :Roger Lu Temperature(°C):23 Humidity(%):67

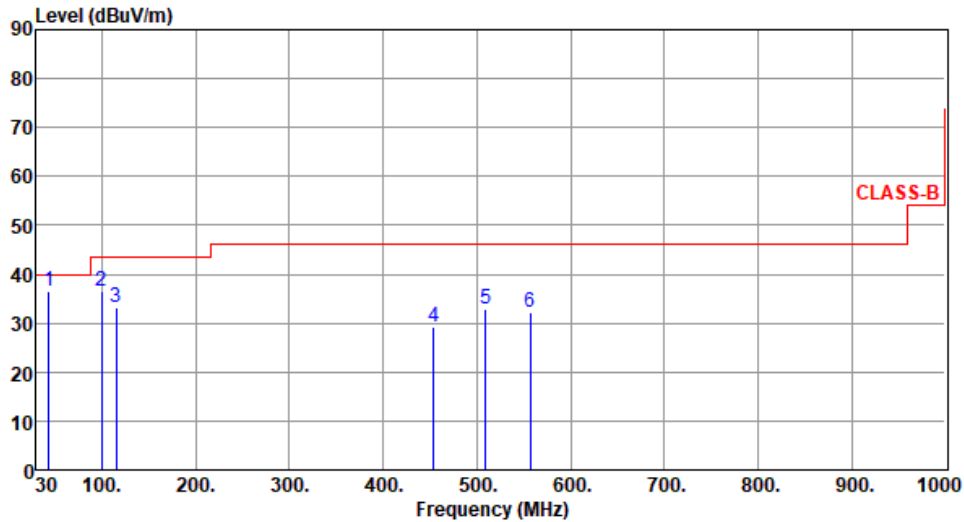

| | Freq. MHz | Emission level dBuV/m | Limit dBuV/m | Margin dB | SA reading dBuV | Factor dB/m | Remark | ANT High cm | Turn Table deg |
|---|--------------|-----------------------------|-----------------|--------------|-----------------------|----------------|--------|-------------------|----------------------|
| 1 | 43.26 | 36.66 | 40.00 | -3.34 | 45.18 | -8.52 | QP | 100 | 258 |
| 2 | 99.56 | 36.56 | 43.50 | -6.94 | 50.01 | -13.45 | Peak | --- | --- |
| 3 | 115.26 | 33.34 | 43.50 | -10.16 | 44.46 | -11.12 | Peak | --- | --- |
| 4 | 454.15 | 29.37 | 46.00 | -16.63 | 33.52 | -4.15 | Peak | --- | --- |
| 5 | 509.35 | 32.86 | 46.00 | -13.14 | 35.93 | -3.07 | Peak | --- | --- |
| 6 | 556.68 | 32.05 | 46.00 | -13.95 | 34.32 | -2.27 | Peak | --- | --- |

Note 1: Emission Level (dBuV/m) = SA Reading (dBuV) + Factor* (dB/m)

*Factor includes antenna factor , cable loss and amplifier gain

Note 2: Margin (dB) = Emission level (dBuV/m) – Limit (dBuV/m).

Note 3: All spurious emissions below 30MHz are more than 20 dB below the limit.

3.5.5 Transmitter Radiated Unwanted Emissions (Above 1GHz) for 11b

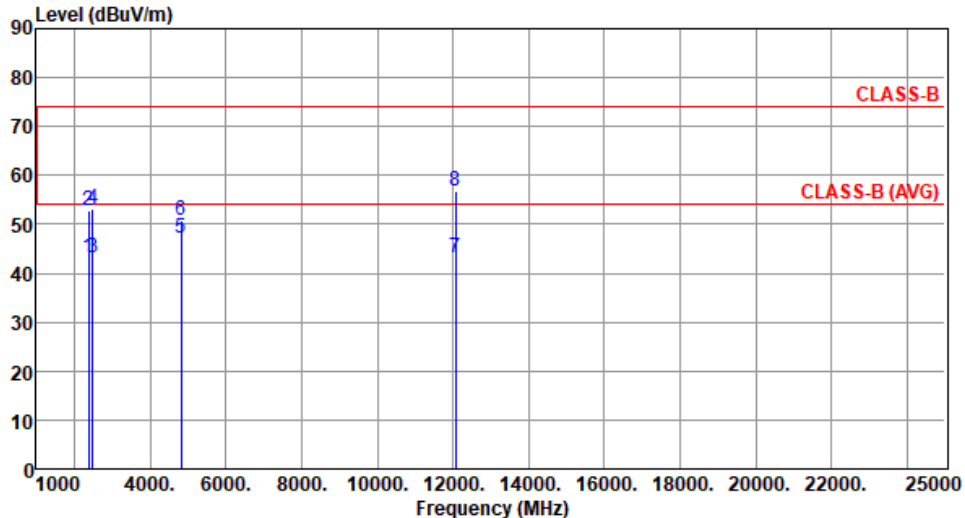
| Modulation | 11b | Test Freq. (MHz) | 2412 | | | | | | |
|---|------------|------------------|--------|--------|------------|--------|---------|----------|------------|
| Polarization | Horizontal | | | | | | | | |
| Test By : Akun Chung Temperature(°C): 23 Humidity(%): 65 | | | | | | | | | |
|  | | | | | | | | | |
| | Freq. | Emission level | Limit | Margin | SA reading | Factor | Remark | ANT High | Turn Table |
| | MHz | dBuV/m | dBuV/m | dB | dBuV | dB/m | | cm | deg |
| 1 | 2390.00 | 43.13 | 54.00 | -10.87 | 45.88 | -2.75 | Average | 100 | 175 |
| 2 | 2390.00 | 52.83 | 74.00 | -21.17 | 55.58 | -2.75 | Peak | 100 | 175 |
| 3 | 2483.50 | 43.17 | 54.00 | -10.83 | 45.87 | -2.70 | Average | 100 | 175 |
| 4 | 2483.50 | 53.25 | 74.00 | -20.75 | 55.95 | -2.70 | Peak | 100 | 175 |
| 5 | 4824.00 | 47.02 | 54.00 | -6.98 | 42.88 | 4.14 | Average | 381 | 280 |
| 6 | 4824.00 | 50.70 | 74.00 | -23.30 | 46.56 | 4.14 | Peak | 381 | 280 |
| 7 | 12060.00 | 43.23 | 54.00 | -10.77 | 29.44 | 13.79 | Average | 100 | 299 |
| 8 | 12060.00 | 56.66 | 74.00 | -17.34 | 42.87 | 13.79 | Peak | 100 | 299 |

Note 1: Emission Level (dBuV/m) = SA Reading (dBuV) + Factor* (dB/m)
*Factor includes antenna factor , cable loss and amplifier gain
Note 2: Margin (dB) = Emission level (dBuV/m) – Limit (dBuV/m).

| | | | |
|---------------------|----------|-------------------------|------|
| Modulation | 11b | Test Freq. (MHz) | 2412 |
| Polarization | Vertical | | |

Test By :Akun Chung Temperature(°C):23 Humidity(%):65

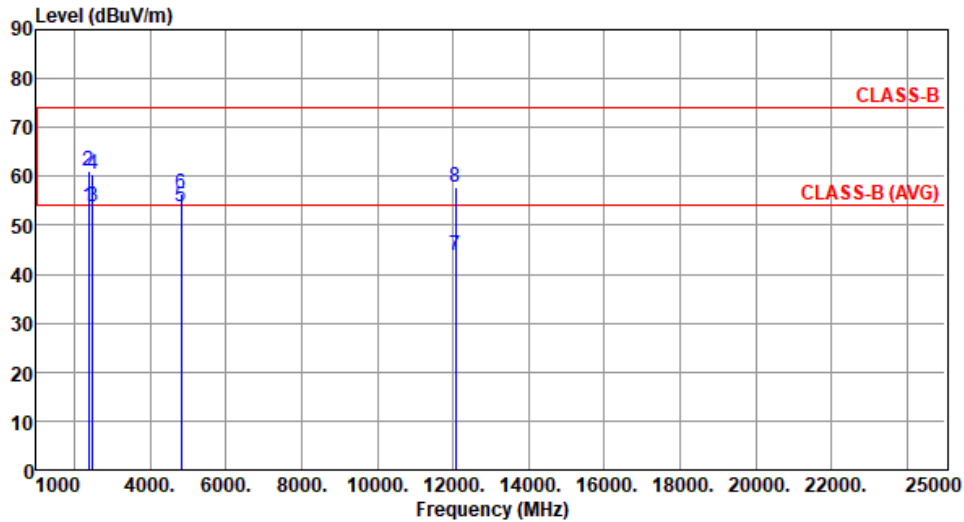

| | Freq. MHz | Emission level dBuV/m | Limit dBuV/m | Margin dB | SA reading dBuV | Factor dB/m | Remark | ANT High cm | Turn Table deg |
|---|--------------|-----------------------------|-----------------|--------------|-----------------------|----------------|---------|-------------------|----------------------|
| 1 | 2390.00 | 53.82 | 54.00 | -0.18 | 56.57 | -2.75 | Average | 172 | 96 |
| 2 | 2390.00 | 61.13 | 74.00 | -12.87 | 63.88 | -2.75 | Peak | 172 | 96 |
| 3 | 2483.50 | 53.87 | 54.00 | -0.13 | 56.57 | -2.70 | Average | 172 | 96 |
| 4 | 2483.50 | 60.59 | 74.00 | -13.41 | 63.29 | -2.70 | Peak | 172 | 96 |
| 5 | 4824.00 | 53.68 | 54.00 | -0.32 | 49.54 | 4.14 | Average | 351 | 352 |
| 6 | 4824.00 | 56.50 | 74.00 | -17.50 | 52.36 | 4.14 | Peak | 351 | 352 |
| 7 | 12060.00 | 43.74 | 54.00 | -10.26 | 29.95 | 13.79 | Average | 100 | 345 |
| 8 | 12060.00 | 57.75 | 74.00 | -16.25 | 43.96 | 13.79 | Peak | 100 | 345 |

Note 1: Emission Level (dBuV/m) = SA Reading (dBuV) + Factor* (dB/m)

*Factor includes antenna factor , cable loss and amplifier gain

Note 2: Margin (dB) = Emission level (dBuV/m) – Limit (dBuV/m).

| | | | |
|---------------------|------------|-------------------------|------|
| Modulation | 11b | Test Freq. (MHz) | 2437 |
| Polarization | Horizontal | | |

Test By :Akun Chung Temperature(°C):23 Humidity(%):65

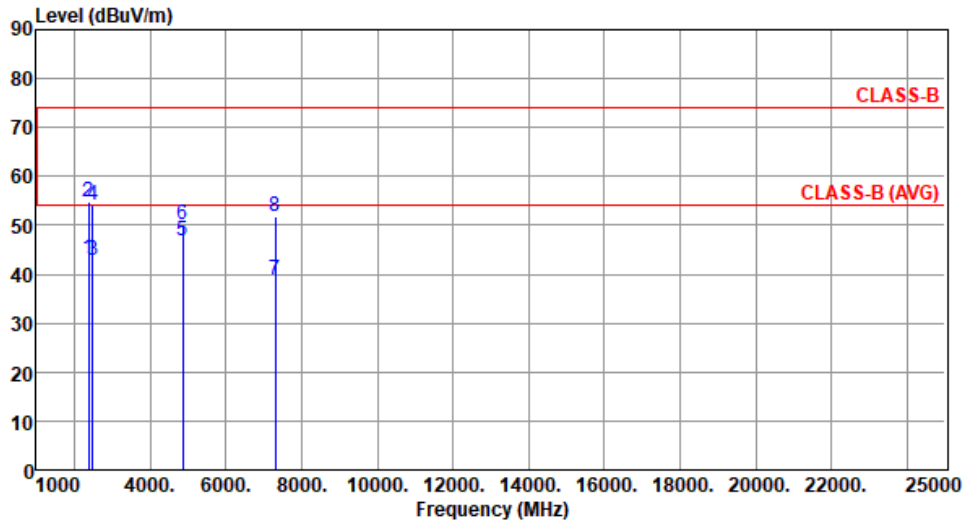

| | Freq. MHz | Emission level dBuV/m | Limit dBuV/m | Margin dB | SA reading dBuV | Factor dB/m | Remark | ANT High cm | Turn Table deg |
|---|--------------|-----------------------------|-----------------|--------------|-----------------------|----------------|---------|-------------------|----------------------|
| 1 | 2390.00 | 43.13 | 54.00 | -10.87 | 45.88 | -2.75 | Average | 100 | 173 |
| 2 | 2390.00 | 54.80 | 74.00 | -19.20 | 57.55 | -2.75 | Peak | 100 | 173 |
| 3 | 2483.50 | 42.83 | 54.00 | -11.17 | 45.53 | -2.70 | Average | 100 | 173 |
| 4 | 2483.50 | 54.25 | 74.00 | -19.75 | 56.95 | -2.70 | Peak | 100 | 173 |
| 5 | 4874.00 | 46.67 | 54.00 | -7.33 | 42.54 | 4.13 | Average | 382 | 274 |
| 6 | 4874.00 | 50.26 | 74.00 | -23.74 | 46.13 | 4.13 | Peak | 382 | 274 |
| 7 | 7311.00 | 38.99 | 54.00 | -15.01 | 29.71 | 9.28 | Average | 100 | 280 |
| 8 | 7311.00 | 51.94 | 74.00 | -22.06 | 42.66 | 9.28 | Peak | 100 | 280 |

Note 1: Emission Level (dBuV/m) = SA Reading (dBuV) + Factor* (dB/m)

*Factor includes antenna factor , cable loss and amplifier gain

Note 2: Margin (dB) = Emission level (dBuV/m) – Limit (dBuV/m).

| | | | |
|---------------------|----------|-------------------------|------|
| Modulation | 11b | Test Freq. (MHz) | 2437 |
| Polarization | Vertical | | |

Test By :Akun Chung Temperature(°C):23 Humidity(%):65

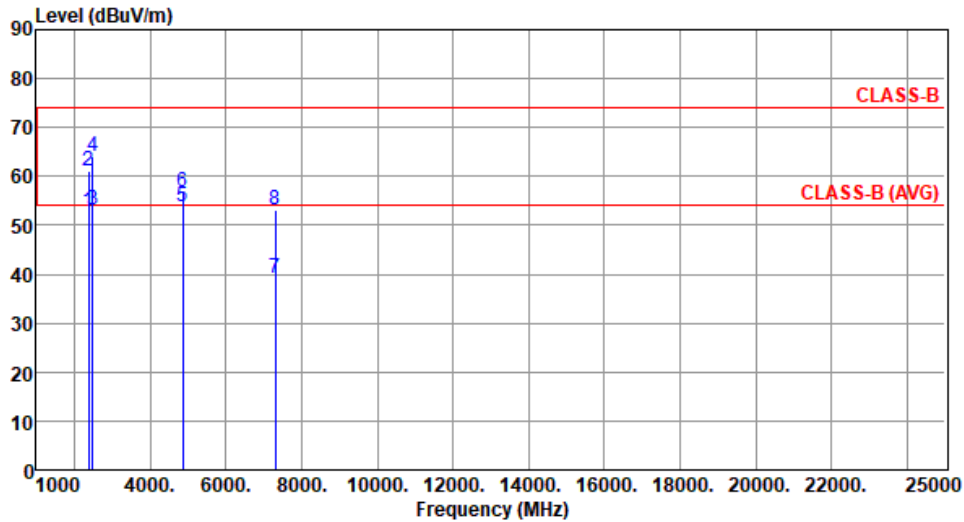

| | Freq. MHz | Emission level dBuV/m | Limit dBuV/m | Margin dB | SA reading dBuV | Factor dB/m | Remark | ANT High cm | Turn Table deg |
|---|--------------|-----------------------------|-----------------|--------------|-----------------------|----------------|---------|-------------------|----------------------|
| 1 | 2390.00 | 52.88 | 54.00 | -1.12 | 55.63 | -2.75 | Average | 155 | 85 |
| 2 | 2390.00 | 61.21 | 74.00 | -12.79 | 63.96 | -2.75 | Peak | 155 | 85 |
| 3 | 2483.50 | 53.29 | 54.00 | -0.71 | 55.99 | -2.70 | Average | 155 | 77 |
| 4 | 2483.50 | 64.18 | 74.00 | -9.82 | 66.88 | -2.70 | Peak | 155 | 77 |
| 5 | 4874.00 | 53.87 | 54.00 | -0.13 | 49.74 | 4.13 | Average | 365 | 358 |
| 6 | 4874.00 | 56.63 | 74.00 | -17.37 | 52.50 | 4.13 | Peak | 365 | 358 |
| 7 | 7311.00 | 39.27 | 54.00 | -14.73 | 29.99 | 9.28 | Average | 100 | 350 |
| 8 | 7311.00 | 53.26 | 74.00 | -20.74 | 43.98 | 9.28 | Peak | 100 | 350 |

Note 1: Emission Level (dBuV/m) = SA Reading (dBuV) + Factor* (dB/m)

*Factor includes antenna factor , cable loss and amplifier gain

Note 2: Margin (dB) = Emission level (dBuV/m) – Limit (dBuV/m).

| | | | |
|---------------------|------------|-------------------------|------|
| Modulation | 11b | Test Freq. (MHz) | 2462 |
| Polarization | Horizontal | | |

Test By :Akun Chung Temperature(°C):23 Humidity(%):65

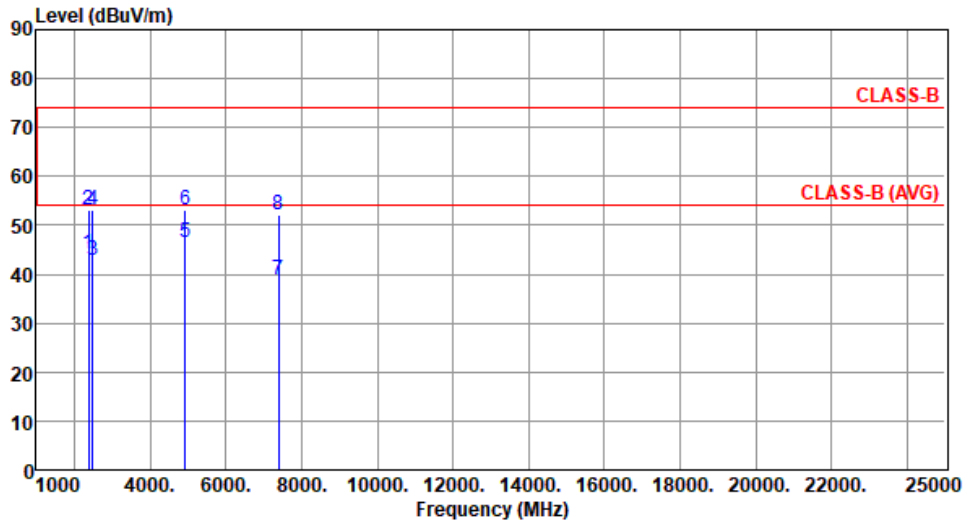

| | Freq. MHz | Emission level dBuV/m | Limit dBuV/m | Margin dB | SA reading dBuV | Factor dB/m | Remark | ANT High cm | Turn Table deg |
|---|--------------|-----------------------------|-----------------|--------------|-----------------------|----------------|---------|-------------------|----------------------|
| 1 | 2390.00 | 44.13 | 54.00 | -9.87 | 46.88 | -2.75 | Average | 100 | 178 |
| 2 | 2390.00 | 53.13 | 74.00 | -20.87 | 55.88 | -2.75 | Peak | 100 | 178 |
| 3 | 2483.50 | 42.90 | 54.00 | -11.10 | 45.60 | -2.70 | Average | 100 | 178 |
| 4 | 2483.50 | 53.18 | 74.00 | -20.82 | 55.88 | -2.70 | Peak | 100 | 178 |
| 5 | 4924.00 | 46.50 | 54.00 | -7.50 | 42.44 | 4.06 | Average | 338 | 288 |
| 6 | 4924.00 | 53.01 | 74.00 | -20.99 | 48.95 | 4.06 | Peak | 338 | 288 |
| 7 | 7386.00 | 38.79 | 54.00 | -15.21 | 29.54 | 9.25 | Average | 100 | 290 |
| 8 | 7386.00 | 52.12 | 74.00 | -21.88 | 42.87 | 9.25 | Peak | 100 | 290 |

Note 1: Emission Level (dBuV/m) = SA Reading (dBuV) + Factor* (dB/m)

*Factor includes antenna factor , cable loss and amplifier gain

Note 2: Margin (dB) = Emission level (dBuV/m) – Limit (dBuV/m).

| | | | |
|---------------------|----------|-------------------------|------|
| Modulation | 11b | Test Freq. (MHz) | 2462 |
| Polarization | Vertical | | |

Test By :Akun Chung Temperature(°C):23 Humidity(%):65

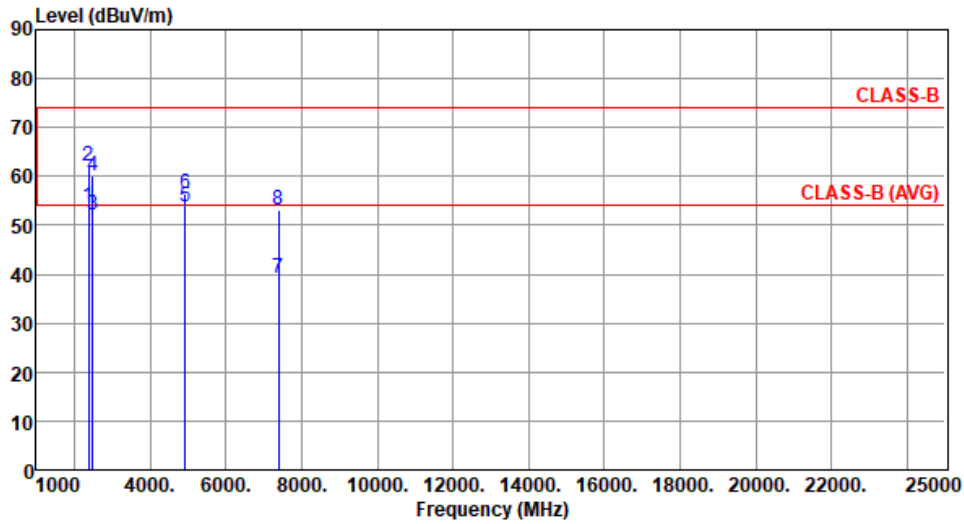

| | Freq. MHz | Emission level dBuV/m | Limit dBuV/m | Margin dB | SA reading dBuV | Factor dB/m | Remark | ANT High cm | Turn Table deg |
|---|--------------|-----------------------------|-----------------|--------------|-----------------------|----------------|---------|-------------------|----------------------|
| 1 | 2390.00 | 53.82 | 54.00 | -0.18 | 56.57 | -2.75 | Average | 117 | 81 |
| 2 | 2390.00 | 62.10 | 74.00 | -11.90 | 64.85 | -2.75 | Peak | 117 | 81 |
| 3 | 2483.50 | 52.26 | 54.00 | -1.74 | 54.96 | -2.70 | Average | 117 | 81 |
| 4 | 2483.50 | 60.15 | 74.00 | -13.85 | 62.85 | -2.70 | Peak | 117 | 81 |
| 5 | 4924.00 | 53.69 | 54.00 | -0.31 | 49.63 | 4.06 | Average | 345 | 357 |
| 6 | 4924.00 | 56.39 | 74.00 | -17.61 | 52.33 | 4.06 | Peak | 345 | 357 |
| 7 | 7386.00 | 39.13 | 54.00 | -14.87 | 29.88 | 9.25 | Average | 100 | 355 |
| 8 | 7386.00 | 53.16 | 74.00 | -20.84 | 43.91 | 9.25 | Peak | 100 | 355 |

Note 1: Emission Level (dBuV/m) = SA Reading (dBuV) + Factor* (dB/m)

*Factor includes antenna factor , cable loss and amplifier gain

Note 2: Margin (dB) = Emission level (dBuV/m) – Limit (dBuV/m).

3.5.6 Transmitter Radiated Unwanted Emissions (Above 1GHz) for 11g

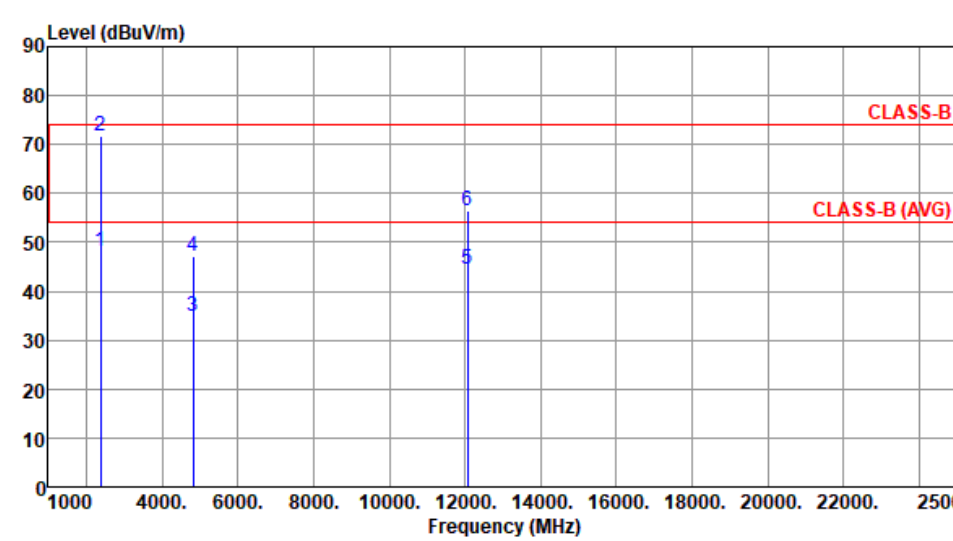
| | | | | | | | | | |
|---|--------------|-----------------------------|-----------------|--------------|-----------------------|----------------|---------|-------------------|----------------------|
| Modulation | 11g | Test Freq. (MHz) | 2412 | | | | | | |
| Polarization | Horizontal | | | | | | | | |
| Test By : Akun Chung Temperature(°C): 23 Humidity(%): 65 | | | | | | | | | |
|  | | | | | | | | | |
| | Freq. MHz | Emission level dBuV/m | Limit dBuV/m | Margin dB | SA reading dBuV | Factor dB/m | Remark | ANT High cm | Turn Table deg |
| 1 | 2390.00 | 48.13 | 54.00 | -5.87 | 50.88 | -2.75 | Average | 101 | 259 |
| 2 | 2390.00 | 71.80 | 74.00 | -2.20 | 74.55 | -2.75 | Peak | 101 | 259 |
| 3 | 4824.00 | 34.80 | 54.00 | -19.20 | 30.66 | 4.14 | Average | 100 | 7 |
| 4 | 4824.00 | 47.13 | 74.00 | -26.87 | 42.99 | 4.14 | Peak | 100 | 7 |
| 5 | 12060.00 | 44.38 | 54.00 | -9.62 | 30.59 | 13.79 | Average | 100 | 4 |
| 6 | 12060.00 | 56.43 | 74.00 | -17.57 | 42.64 | 13.79 | Peak | 100 | 4 |
| <p>Note 1: Emission Level (dBuV/m) = SA Reading (dBuV) + Factor* (dB/m) *Factor includes antenna factor , cable loss and amplifier gain Note 2: Margin (dB) = Emission level (dBuV/m) – Limit (dBuV/m).</p> | | | | | | | | | |

| | | | |
|---------------------|----------|-------------------------|------|
| Modulation | 11g | Test Freq. (MHz) | 2412 |
| Polarization | Vertical | | |

Test By : Akun Chung Temperature(°C): 23 Humidity(%): 65

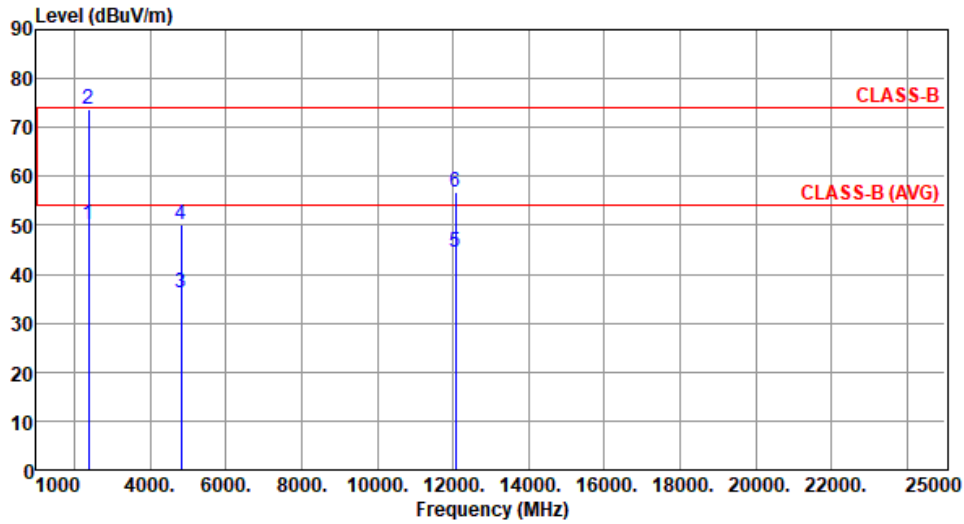

| | Freq. MHz | Emission level dBuV/m | Limit dBuV/m | Margin dB | SA reading dBuV | Factor dB/m | Remark | ANT High cm | Turn Table deg |
|---|--------------|-----------------------------|-----------------|--------------|-----------------------|----------------|---------|-------------------|----------------------|
| 1 | 2390.00 | 50.19 | 54.00 | -3.81 | 52.94 | -2.75 | Average | 121 | 116 |
| 2 | 2390.00 | 73.85 | 74.00 | -0.15 | 76.60 | -2.75 | Peak | 121 | 116 |
| 3 | 4824.00 | 36.03 | 54.00 | -17.97 | 31.89 | 4.14 | Average | 310 | 355 |
| 4 | 4824.00 | 50.02 | 74.00 | -23.98 | 45.88 | 4.14 | Peak | 310 | 355 |
| 5 | 12060.00 | 44.47 | 54.00 | -9.53 | 30.68 | 13.79 | Average | 100 | 350 |
| 6 | 12060.00 | 56.65 | 74.00 | -17.35 | 42.86 | 13.79 | Peak | 100 | 350 |

Note 1: Emission Level (dBuV/m) = SA Reading (dBuV) + Factor* (dB/m)

*Factor includes antenna factor , cable loss and amplifier gain

Note 2: Margin (dB) = Emission level (dBuV/m) – Limit (dBuV/m).

| | | | |
|---------------------|------------|-------------------------|------|
| Modulation | 11g | Test Freq. (MHz) | 2437 |
| Polarization | Horizontal | | |

Test By :Akun Chung Temperature(°C):23 Humidity(%):65

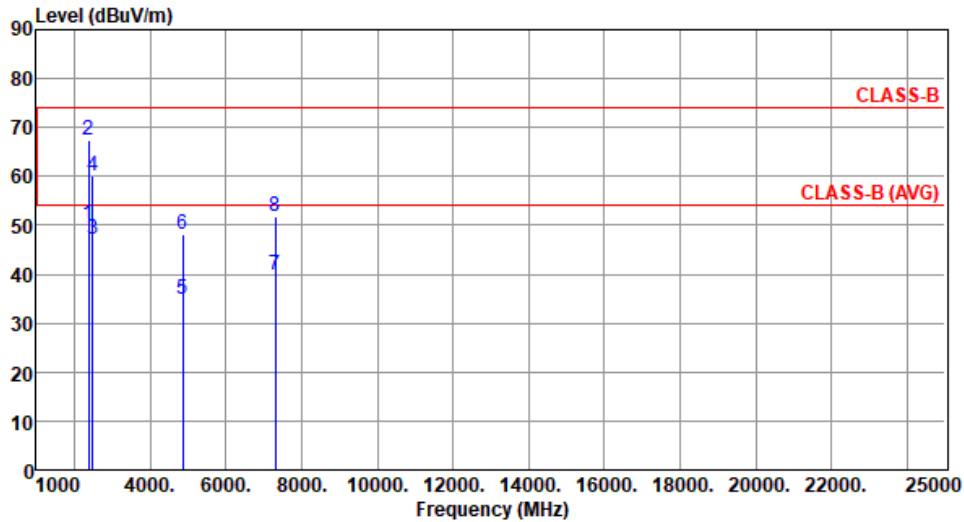

| | Freq. MHz | Emission level dBuV/m | Limit dBuV/m | Margin dB | SA reading dBuV | Factor dB/m | Remark | ANT High cm | Turn Table deg |
|---|--------------|-----------------------------|-----------------|--------------|-----------------------|----------------|---------|-------------------|----------------------|
| 1 | 2390.00 | 50.15 | 54.00 | -3.85 | 52.90 | -2.75 | Average | 101 | 266 |
| 2 | 2390.00 | 67.50 | 74.00 | -6.50 | 70.25 | -2.75 | Peak | 101 | 266 |
| 3 | 2483.50 | 47.02 | 54.00 | -6.98 | 49.72 | -2.70 | Average | 101 | 266 |
| 4 | 2483.50 | 60.15 | 74.00 | -13.85 | 62.85 | -2.70 | Peak | 101 | 266 |
| 5 | 4874.00 | 34.99 | 54.00 | -19.01 | 30.86 | 4.13 | Average | 199 | 8 |
| 6 | 4874.00 | 48.00 | 74.00 | -26.00 | 43.87 | 4.13 | Peak | 199 | 8 |
| 7 | 7311.00 | 39.78 | 54.00 | -14.22 | 30.50 | 9.28 | Average | 100 | 15 |
| 8 | 7311.00 | 51.76 | 74.00 | -22.24 | 42.48 | 9.28 | Peak | 100 | 15 |

Note 1: Emission Level (dBuV/m) = SA Reading (dBuV) + Factor* (dB/m)

*Factor includes antenna factor , cable loss and amplifier gain

Note 2: Margin (dB) = Emission level (dBuV/m) – Limit (dBuV/m).

| | | | |
|---------------------|----------|-------------------------|------|
| Modulation | 11g | Test Freq. (MHz) | 2437 |
| Polarization | Vertical | | |

Test By : Akun Chung Temperature(°C): 23 Humidity(%): 65

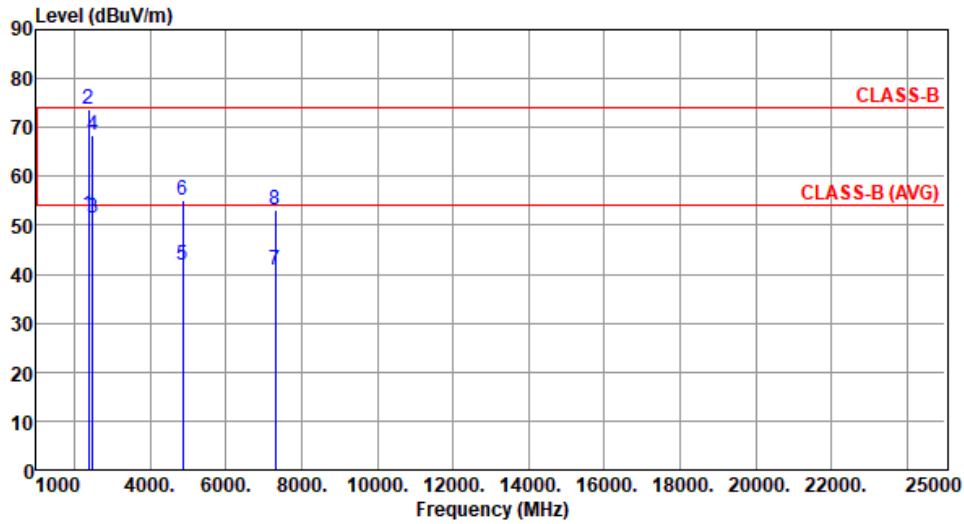

| | Freq. MHz | Emission level dBuV/m | Limit dBuV/m | Margin dB | SA reading dBuV | Factor dB/m | Remark | ANT High cm | Turn Table deg |
|---|--------------|-----------------------------|-----------------|--------------|-----------------------|----------------|---------|-------------------|----------------------|
| 1 | 2390.00 | 52.16 | 54.00 | -1.84 | 54.91 | -2.75 | Average | 100 | 125 |
| 2 | 2390.00 | 73.75 | 74.00 | -0.25 | 76.50 | -2.75 | Peak | 100 | 125 |
| 3 | 2483.50 | 51.41 | 54.00 | -2.59 | 54.11 | -2.70 | Average | 102 | 53 |
| 4 | 2483.50 | 68.25 | 74.00 | -5.75 | 70.95 | -2.70 | Peak | 102 | 53 |
| 5 | 4874.00 | 41.82 | 54.00 | -12.18 | 37.69 | 4.13 | Average | 311 | 357 |
| 6 | 4874.00 | 55.01 | 74.00 | -18.99 | 50.88 | 4.13 | Peak | 311 | 357 |
| 7 | 7311.00 | 40.94 | 54.00 | -13.06 | 31.66 | 9.28 | Average | 100 | 346 |
| 8 | 7311.00 | 53.16 | 74.00 | -20.84 | 43.88 | 9.28 | Peak | 100 | 346 |

Note 1: Emission Level (dBuV/m) = SA Reading (dBuV) + Factor* (dB/m)
 *Factor includes antenna factor , cable loss and amplifier gain
 Note 2: Margin (dB) = Emission level (dBuV/m) – Limit (dBuV/m).

| | | | |
|---------------------|------------|-------------------------|------|
| Modulation | 11g | Test Freq. (MHz) | 2462 |
| Polarization | Horizontal | | |

Test By :Akun Chung Temperature(°C):23 Humidity(%):65

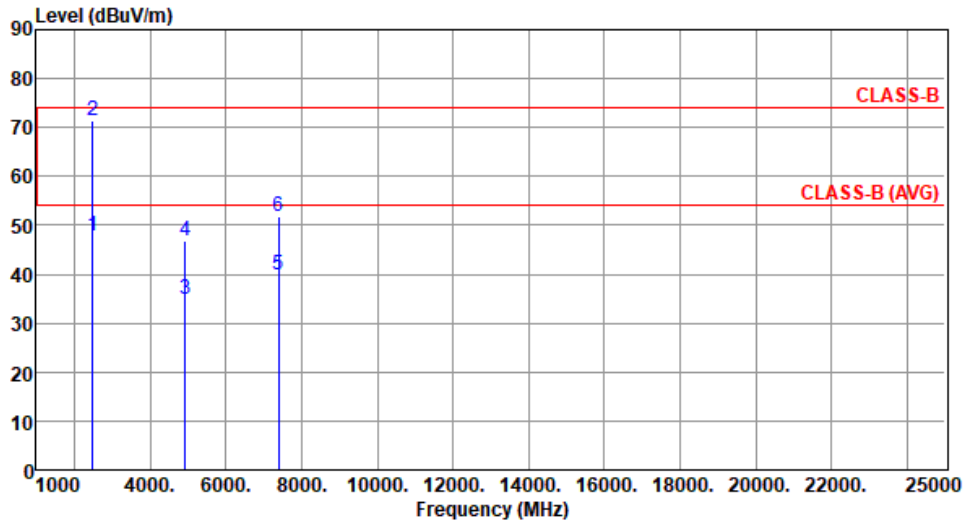

| | Freq. MHz | Emission level dBUV/m | Limit dBUV/m | Margin dB | SA reading dBUV | Factor dB/m | Remark | ANT High cm | Turn Table deg |
|---|--------------|-----------------------------|-----------------|--------------|-----------------------|----------------|---------|-------------------|----------------------|
| 1 | 2483.50 | 47.97 | 54.00 | -6.03 | 50.67 | -2.70 | Average | 100 | 281 |
| 2 | 2483.50 | 71.45 | 74.00 | -2.55 | 74.15 | -2.70 | Peak | 100 | 281 |
| 3 | 4924.00 | 34.74 | 54.00 | -19.26 | 30.68 | 4.06 | Average | 100 | 6 |
| 4 | 4924.00 | 46.74 | 74.00 | -27.26 | 42.68 | 4.06 | Peak | 100 | 6 |
| 5 | 7386.00 | 39.95 | 54.00 | -14.05 | 30.70 | 9.25 | Average | 100 | 9 |
| 6 | 7386.00 | 51.91 | 74.00 | -22.09 | 42.66 | 9.25 | Peak | 100 | 9 |

Note 1: Emission Level (dBUV/m) = SA Reading (dBUV) + Factor* (dB/m)
 *Factor includes antenna factor , cable loss and amplifier gain
 Note 2: Margin (dB) = Emission level (dBUV/m) – Limit (dBUV/m).

| | | | |
|---------------------|----------|-------------------------|------|
| Modulation | 11g | Test Freq. (MHz) | 2462 |
| Polarization | Vertical | | |

Test By :Akun Chung Temperature(°C):23 Humidity(%):65

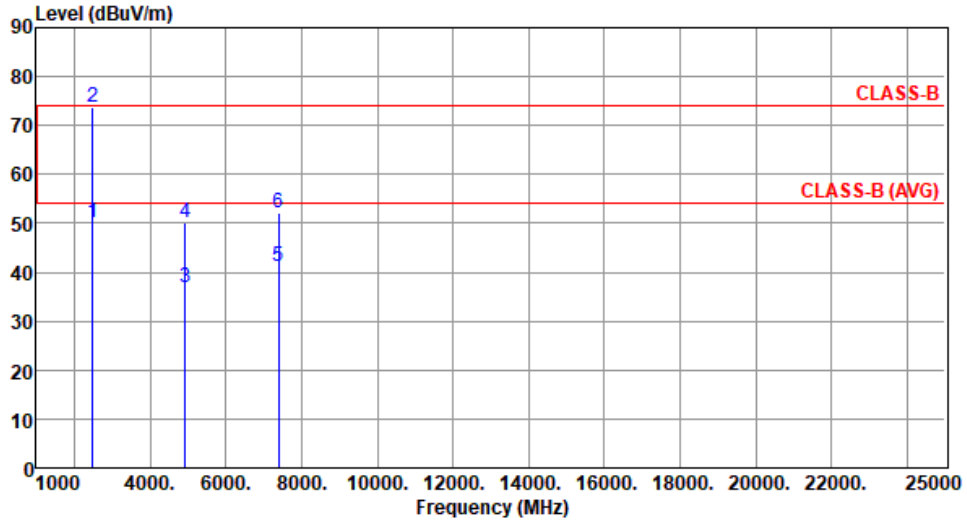

| | Freq. MHz | Emission level dBuV/m | Limit dBuV/m | Margin dB | SA reading dBuV | Factor dB/m | Remark | ANT High cm | Turn Table deg |
|---|-----------|-----------------------|--------------|-----------|-----------------|-------------|---------|-------------|----------------|
| 1 | 2483.50 | 50.16 | 54.00 | -3.84 | 52.86 | -2.70 | Average | 119 | 38 |
| 2 | 2483.50 | 73.88 | 74.00 | -0.12 | 76.58 | -2.70 | Peak | 119 | 38 |
| 3 | 4924.00 | 36.96 | 54.00 | -17.04 | 32.90 | 4.06 | Average | 315 | 352 |
| 4 | 4924.00 | 50.01 | 74.00 | -23.99 | 45.95 | 4.06 | Peak | 315 | 352 |
| 5 | 7386.00 | 41.12 | 54.00 | -12.88 | 31.87 | 9.25 | Average | 100 | 345 |
| 6 | 7386.00 | 52.20 | 74.00 | -21.80 | 42.95 | 9.25 | Peak | 100 | 345 |

Note 1: Emission Level (dBuV/m) = SA Reading (dBuV) + Factor* (dB/m)
 *Factor includes antenna factor , cable loss and amplifier gain
 Note 2: Margin (dB) = Emission level (dBuV/m) – Limit (dBuV/m).

3.5.7 Transmitter Radiated Unwanted Emissions (Above 1GHz) for ax HE20-OFDMA

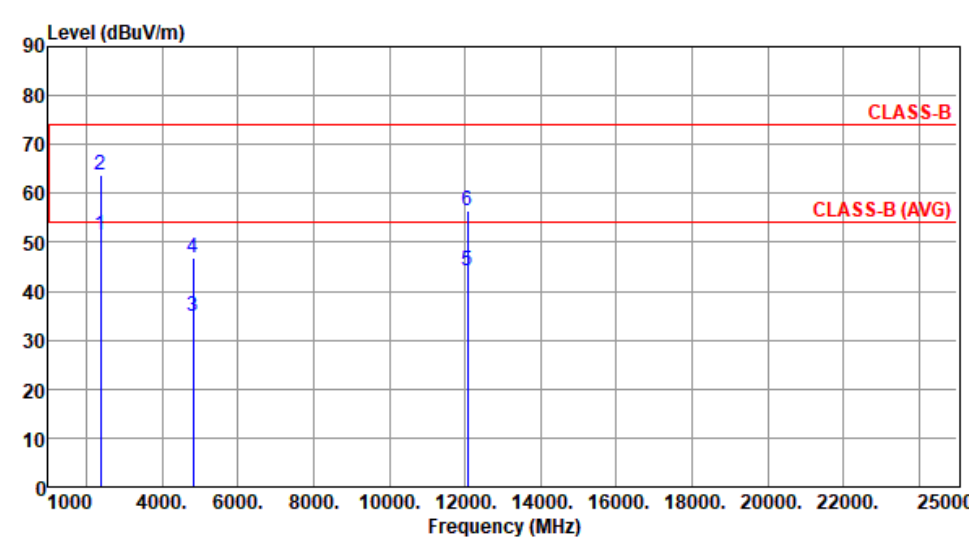
| | | | | | | | | | |
|---|------------|-------------------------|--------|--------|------------|--------|---------|----------|------------|
| Modulation | ax HE20 | Test Freq. (MHz) | 2412 | | | | | | |
| Polarization | Horizontal | | | | | | | | |
| Test By : Akun Chung Temperature(°C): 23 Humidity(%): 65 | | | | | | | | | |
|  | | | | | | | | | |
| | Freq. | Emission level | Limit | Margin | SA reading | Factor | Remark | ANT High | Turn Table |
| | MHz | dBuV/m | dBuV/m | dB | dBuV | dB/m | | cm | deg |
| 1 | 2390.00 | 51.62 | 54.00 | -2.38 | 54.37 | -2.75 | Average | 100 | 280 |
| 2 | 2390.00 | 63.80 | 74.00 | -10.20 | 66.55 | -2.75 | Peak | 100 | 280 |
| 3 | 4824.00 | 34.74 | 54.00 | -19.26 | 30.60 | 4.14 | Average | 100 | 4 |
| 4 | 4824.00 | 46.72 | 74.00 | -27.28 | 42.58 | 4.14 | Peak | 100 | 4 |
| 5 | 12060.00 | 44.27 | 54.00 | -9.73 | 30.48 | 13.79 | Average | 100 | 11 |
| 6 | 12060.00 | 56.33 | 74.00 | -17.67 | 42.54 | 13.79 | Peak | 100 | 11 |

Note 1: Emission Level (dBuV/m) = SA Reading (dBuV) + Factor* (dB/m)
 *Factor includes antenna factor , cable loss and amplifier gain
 Note 2: Margin (dB) = Emission level (dBuV/m) – Limit (dBuV/m).

| | | | |
|---------------------|----------|-------------------------|------|
| Modulation | ax HE20 | Test Freq. (MHz) | 2412 |
| Polarization | Vertical | | |

Test By :Akun Chung Temperature(°C):23 Humidity(%):65

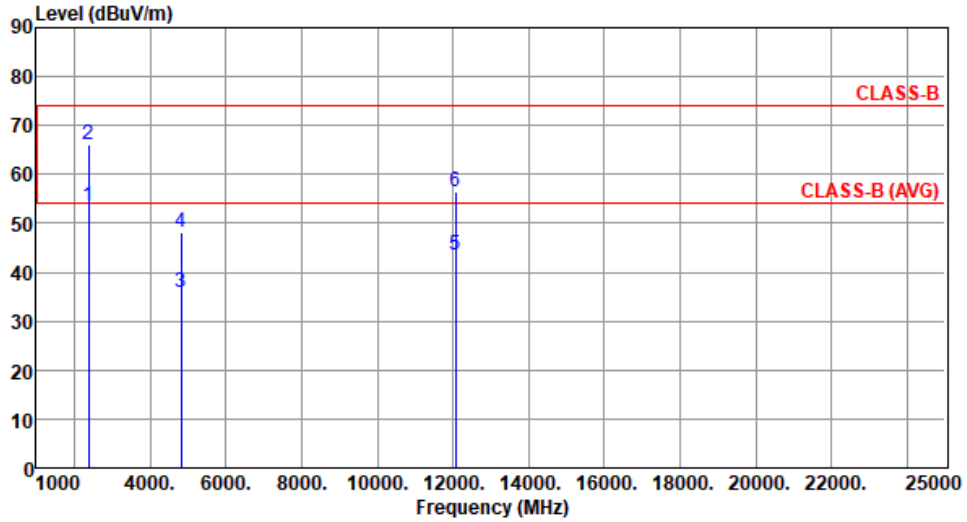

| | Freq. MHz | Emission level dBuV/m | Limit dBuV/m | Margin dB | SA reading dBuV | Factor dB/m | Remark | ANT High cm | Turn Table deg |
|---|--------------|-----------------------------|-----------------|--------------|-----------------------|----------------|---------|-------------------|----------------------|
| 1 | 2390.00 | 53.51 | 54.00 | -0.49 | 56.26 | -2.75 | Average | 100 | 51 |
| 2 | 2390.00 | 66.20 | 74.00 | -7.80 | 68.95 | -2.75 | Peak | 100 | 51 |
| 3 | 4824.00 | 35.91 | 54.00 | -18.09 | 31.77 | 4.14 | Average | 325 | 342 |
| 4 | 4824.00 | 48.09 | 74.00 | -25.91 | 43.95 | 4.14 | Peak | 325 | 342 |
| 5 | 12060.00 | 43.65 | 54.00 | -10.35 | 29.86 | 13.79 | Average | 100 | 350 |
| 6 | 12060.00 | 56.48 | 74.00 | -17.52 | 42.69 | 13.79 | Peak | 100 | 350 |

Note 1: Emission Level (dBuV/m) = SA Reading (dBuV) + Factor* (dB/m)
 *Factor includes antenna factor , cable loss and amplifier gain
 Note 2: Margin (dB) = Emission level (dBuV/m) – Limit (dBuV/m).

| | | | |
|---------------------|------------|-------------------------|------|
| Modulation | ax HE20 | Test Freq. (MHz) | 2437 |
| Polarization | Horizontal | | |

Test By :Akun Chung Temperature(°C):23 Humidity(%):65

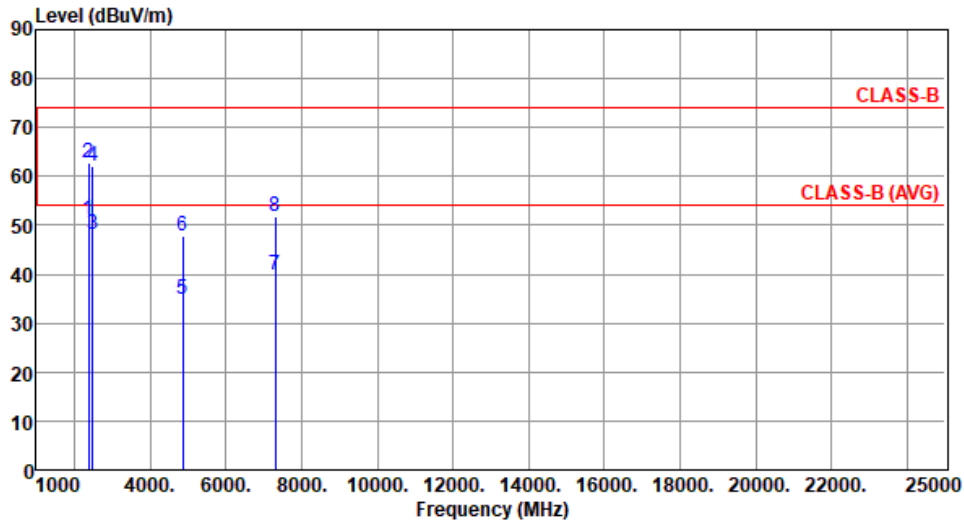

| | Freq. MHz | Emission level dBuV/m | Limit dBuV/m | Margin dB | SA reading dBuV | Factor dB/m | Remark | ANT High cm | Turn Table deg |
|---|-----------|-----------------------|--------------|-----------|-----------------|-------------|---------|-------------|----------------|
| 1 | 2390.00 | 51.02 | 54.00 | -2.98 | 53.77 | -2.75 | Average | 100 | 290 |
| 2 | 2390.00 | 62.80 | 74.00 | -11.20 | 65.55 | -2.75 | Peak | 100 | 290 |
| 3 | 2483.50 | 48.09 | 54.00 | -5.91 | 50.79 | -2.70 | Average | 100 | 290 |
| 4 | 2483.50 | 62.15 | 74.00 | -11.85 | 64.85 | -2.70 | Peak | 100 | 290 |
| 5 | 4874.00 | 34.91 | 54.00 | -19.09 | 30.78 | 4.13 | Average | 203 | 5 |
| 6 | 4874.00 | 47.88 | 74.00 | -26.12 | 43.75 | 4.13 | Peak | 203 | 5 |
| 7 | 7311.00 | 39.72 | 54.00 | -14.28 | 30.44 | 9.28 | Average | 100 | 7 |
| 8 | 7311.00 | 51.83 | 74.00 | -22.17 | 42.55 | 9.28 | Peak | 100 | 7 |

Note 1: Emission Level (dBuV/m) = SA Reading (dBuV) + Factor* (dB/m)
 *Factor includes antenna factor , cable loss and amplifier gain
 Note 2: Margin (dB) = Emission level (dBuV/m) – Limit (dBuV/m).

| | | | |
|---------------------|----------|-------------------------|------|
| Modulation | ax HE20 | Test Freq. (MHz) | 2437 |
| Polarization | Vertical | | |

Test By :Akun Chung Temperature(°C):23 Humidity(%):65

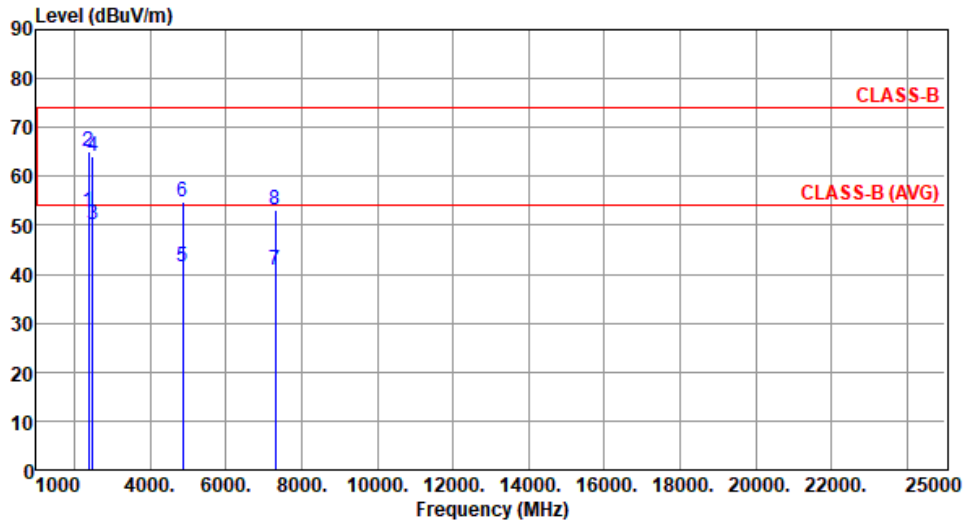

| | Freq. MHz | Emission level dBuV/m | Limit dBuV/m | Margin dB | SA reading dBuV | Factor dB/m | Remark | ANT High cm | Turn Table deg |
|---|--------------|-----------------------------|-----------------|--------------|-----------------------|----------------|---------|-------------------|----------------------|
| 1 | 2390.00 | 52.83 | 54.00 | -1.17 | 55.58 | -2.75 | Average | 100 | 122 |
| 2 | 2390.00 | 65.20 | 74.00 | -8.80 | 67.95 | -2.75 | Peak | 100 | 122 |
| 3 | 2483.50 | 50.16 | 54.00 | -3.84 | 52.86 | -2.70 | Average | 100 | 122 |
| 4 | 2483.50 | 64.10 | 74.00 | -9.90 | 66.80 | -2.70 | Peak | 100 | 122 |
| 5 | 4874.00 | 41.68 | 54.00 | -12.32 | 37.55 | 4.13 | Average | 308 | 352 |
| 6 | 4874.00 | 54.76 | 74.00 | -19.24 | 50.63 | 4.13 | Peak | 308 | 352 |
| 7 | 7311.00 | 40.87 | 54.00 | -13.13 | 31.59 | 9.28 | Average | 100 | 344 |
| 8 | 7311.00 | 53.03 | 74.00 | -20.97 | 43.75 | 9.28 | Peak | 100 | 344 |

Note 1: Emission Level (dBuV/m) = SA Reading (dBuV) + Factor* (dB/m)

*Factor includes antenna factor , cable loss and amplifier gain

Note 2: Margin (dB) = Emission level (dBuV/m) – Limit (dBuV/m).

| | | | |
|---------------------|------------|-------------------------|------|
| Modulation | ax HE20 | Test Freq. (MHz) | 2462 |
| Polarization | Horizontal | | |

Test By : Akun Chung Temperature(°C): 23 Humidity(%): 65

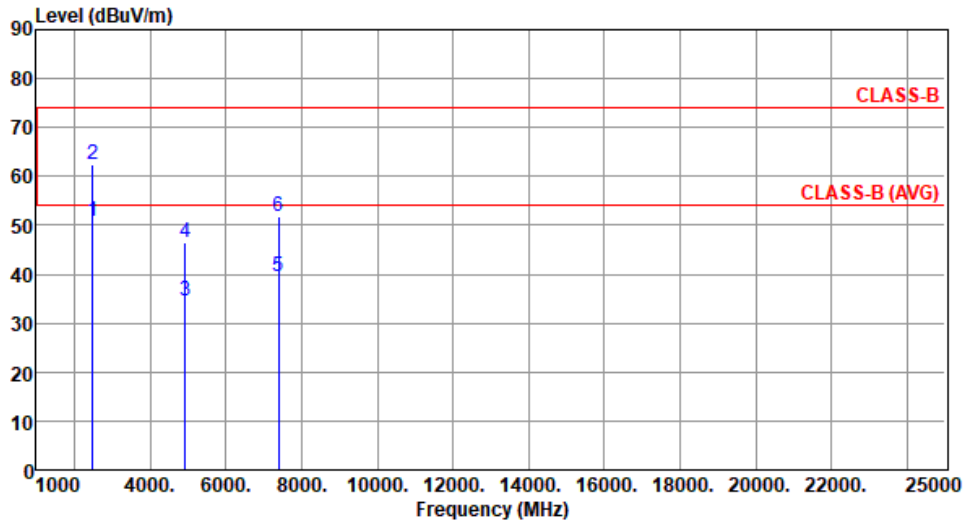

| | Freq. MHz | Emission level dBuV/m | Limit dBuV/m | Margin dB | SA reading dBuV | Factor dB/m | Remark | ANT High cm | Turn Table deg |
|---|--------------|-----------------------------|-----------------|--------------|-----------------------|----------------|---------|-------------------|----------------------|
| 1 | 2483.50 | 50.84 | 54.00 | -3.16 | 53.54 | -2.70 | Average | 100 | 269 |
| 2 | 2483.50 | 62.51 | 74.00 | -11.49 | 65.21 | -2.70 | Peak | 100 | 269 |
| 3 | 4924.00 | 34.63 | 54.00 | -19.37 | 30.57 | 4.06 | Average | 100 | 4 |
| 4 | 4924.00 | 46.51 | 74.00 | -27.49 | 42.45 | 4.06 | Peak | 100 | 4 |
| 5 | 7386.00 | 39.65 | 54.00 | -14.35 | 30.40 | 9.25 | Average | 100 | 9 |
| 6 | 7386.00 | 51.67 | 74.00 | -22.33 | 42.42 | 9.25 | Peak | 100 | 9 |

Note 1: Emission Level (dBuV/m) = SA Reading (dBuV) + Factor* (dB/m)

*Factor includes antenna factor , cable loss and amplifier gain

Note 2: Margin (dB) = Emission level (dBuV/m) – Limit (dBuV/m).

| | | | |
|---------------------|----------|-------------------------|------|
| Modulation | ax HE20 | Test Freq. (MHz) | 2462 |
| Polarization | Vertical | | |

Test By :Akun Chung Temperature(°C):23 Humidity(%):65

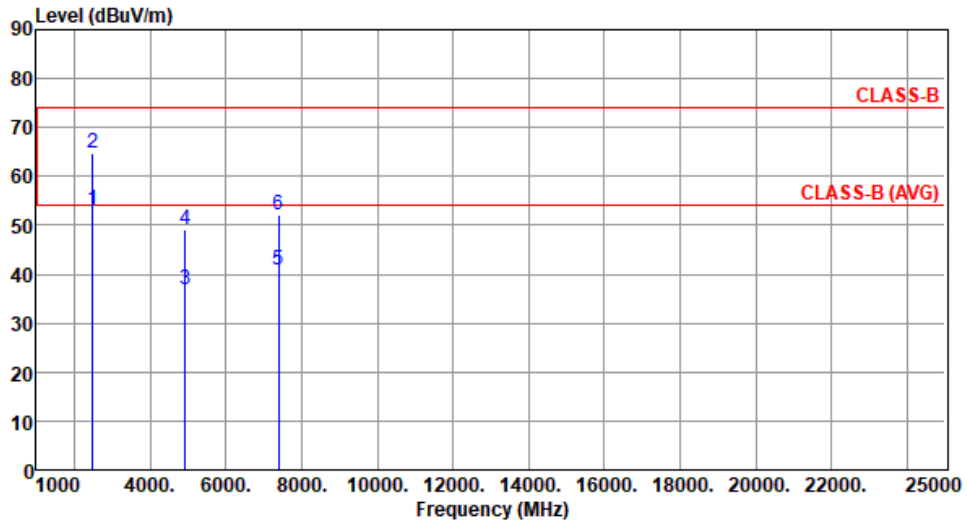

| | Freq. MHz | Emission level dBuV/m | Limit dBuV/m | Margin dB | SA reading dBuV | Factor dB/m | Remark | ANT High cm | Turn Table deg |
|---|--------------|-----------------------------|-----------------|--------------|-----------------------|----------------|---------|-------------------|----------------------|
| 1 | 2483.50 | 53.18 | 54.00 | -0.82 | 55.88 | -2.70 | Average | 121 | 167 |
| 2 | 2483.50 | 64.85 | 74.00 | -9.15 | 67.55 | -2.70 | Peak | 121 | 167 |
| 3 | 4924.00 | 36.74 | 54.00 | -17.26 | 32.68 | 4.06 | Average | 315 | 345 |
| 4 | 4924.00 | 49.02 | 74.00 | -24.98 | 44.96 | 4.06 | Peak | 315 | 345 |
| 5 | 7386.00 | 40.82 | 54.00 | -13.18 | 31.57 | 9.25 | Average | 100 | 350 |
| 6 | 7386.00 | 52.05 | 74.00 | -21.95 | 42.80 | 9.25 | Peak | 100 | 350 |

Note 1: Emission Level (dBuV/m) = SA Reading (dBuV) + Factor* (dB/m)

*Factor includes antenna factor , cable loss and amplifier gain

Note 2: Margin (dB) = Emission level (dBuV/m) – Limit (dBuV/m).

3.5.8 Transmitter Radiated Unwanted Emissions (Above 1GHz) for ax HE40-OFDMA

| | | | | | | | | | |
|--|---------------|-------------------------|--------|--------|------------|--------|---------|----------|------------|
| Modulation | ax HE40-OFDMA | Test Freq. (MHz) | 2422 | | | | | | |
| Polarization | Horizontal | | | | | | | | |
| Test By : Akun Chung Temperature(°C): 23 Humidity(%): 65 | | | | | | | | | |
| | | | | | | | | | |
| | Freq. | Emission level | Limit | Margin | SA reading | Factor | Remark | ANT High | Turn Table |
| | MHz | dBuV/m | dBuV/m | dB | dBuV | dB/m | | cm | deg |
| 1 | 2390.00 | 51.38 | 54.00 | -2.62 | 54.13 | -2.75 | Average | 100 | 279 |
| 2 | 2390.00 | 64.77 | 74.00 | -9.23 | 67.52 | -2.75 | Peak | 100 | 279 |
| 3 | 4844.00 | 34.55 | 54.00 | -19.45 | 30.39 | 4.16 | Average | 100 | 4 |
| 4 | 4844.00 | 46.44 | 74.00 | -27.56 | 42.28 | 4.16 | Peak | 100 | 4 |
| 5 | 7266.00 | 39.53 | 54.00 | -14.47 | 30.30 | 9.23 | Average | 100 | 16 |
| 6 | 7266.00 | 51.61 | 74.00 | -22.39 | 42.38 | 9.23 | Peak | 100 | 16 |

Note 1: Emission Level (dBuV/m) = SA Reading (dBuV) + Factor* (dB/m)
 *Factor includes antenna factor , cable loss and amplifier gain
 Note 2: Margin (dB) = Emission level (dBuV/m) – Limit (dBuV/m).

| | | | |
|---------------------|---------------|-------------------------|------|
| Modulation | ax HE40-OFDMA | Test Freq. (MHz) | 2422 |
| Polarization | Vertical | | |

Test By :Akun Chung Temperature(°C):23 Humidity(%):65

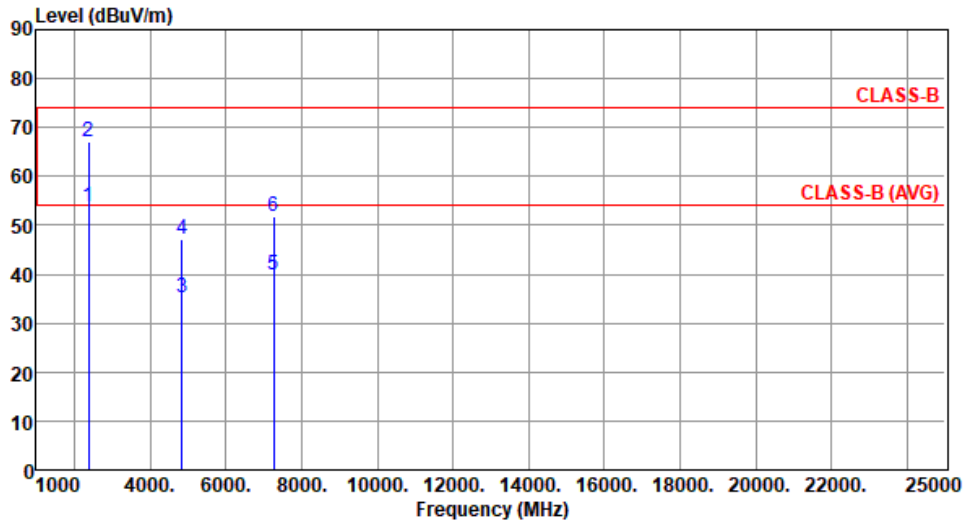

| | Freq. MHz | Emission level dBuV/m | Limit dBuV/m | Margin dB | SA reading dBuV | Factor dB/m | Remark | ANT High cm | Turn Table deg |
|---|-----------|-----------------------|--------------|-----------|-----------------|-------------|---------|-------------|----------------|
| 1 | 2390.00 | 53.88 | 54.00 | -0.12 | 56.63 | -2.75 | Average | 150 | 49 |
| 2 | 2390.00 | 67.10 | 74.00 | -6.90 | 69.85 | -2.75 | Peak | 150 | 49 |
| 3 | 4844.00 | 35.04 | 54.00 | -18.96 | 30.88 | 4.16 | Average | 100 | 350 |
| 4 | 4844.00 | 47.02 | 74.00 | -26.98 | 42.86 | 4.16 | Peak | 100 | 350 |
| 5 | 7266.00 | 39.89 | 54.00 | -14.11 | 30.66 | 9.23 | Average | 100 | 353 |
| 6 | 7266.00 | 51.79 | 74.00 | -22.21 | 42.56 | 9.23 | Peak | 100 | 353 |

Note 1: Emission Level (dBuV/m) = SA Reading (dBuV) + Factor* (dB/m)

*Factor includes antenna factor , cable loss and amplifier gain

Note 2: Margin (dB) = Emission level (dBuV/m) – Limit (dBuV/m).

| | | | |
|---------------------|---------------|-------------------------|------|
| Modulation | ax HE40-OFDMA | Test Freq. (MHz) | 2437 |
| Polarization | Horizontal | | |

Test By :Akun Chung Temperature(°C):23 Humidity(%):65

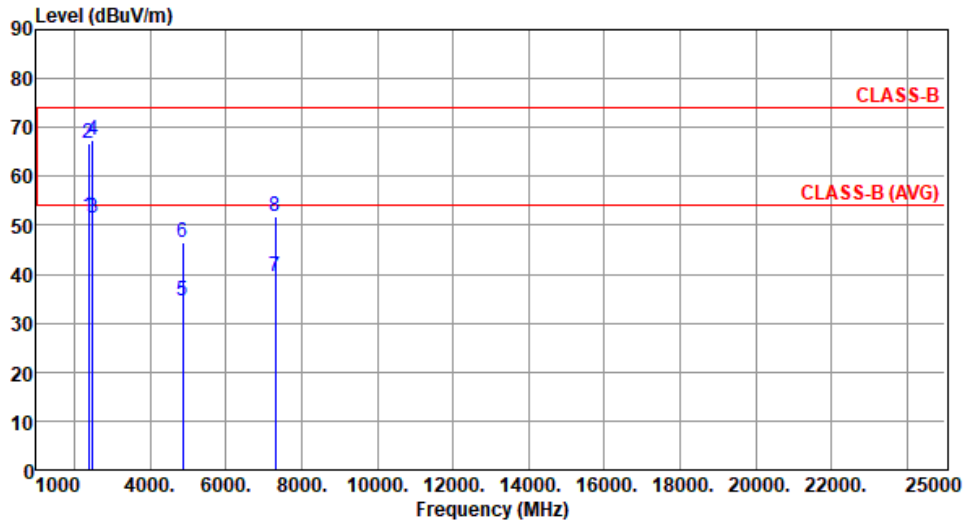

| | Freq. MHz | Emission level dBuV/m | Limit dBuV/m | Margin dB | SA reading dBuV | Factor dB/m | Remark | ANT High cm | Turn Table deg |
|---|--------------|-----------------------------|-----------------|--------------|-----------------------|----------------|---------|-------------------|----------------------|
| 1 | 2390.00 | 51.77 | 54.00 | -2.23 | 54.52 | -2.75 | Average | 100 | 282 |
| 2 | 2390.00 | 66.81 | 74.00 | -7.19 | 69.56 | -2.75 | Peak | 100 | 282 |
| 3 | 2483.50 | 51.51 | 54.00 | -2.49 | 54.21 | -2.70 | Average | 100 | 282 |
| 4 | 2483.50 | 67.25 | 74.00 | -6.75 | 69.95 | -2.70 | Peak | 100 | 282 |
| 5 | 4874.00 | 34.46 | 54.00 | -19.54 | 30.33 | 4.13 | Average | 100 | 2 |
| 6 | 4874.00 | 46.53 | 74.00 | -27.47 | 42.40 | 4.13 | Peak | 100 | 2 |
| 7 | 7311.00 | 39.55 | 54.00 | -14.45 | 30.27 | 9.28 | Average | 100 | 4 |
| 8 | 7311.00 | 51.67 | 74.00 | -22.33 | 42.39 | 9.28 | Peak | 100 | 4 |

Note 1: Emission Level (dBuV/m) = SA Reading (dBuV) + Factor* (dB/m)

*Factor includes antenna factor , cable loss and amplifier gain

Note 2: Margin (dB) = Emission level (dBuV/m) – Limit (dBuV/m).

| | | | |
|---------------------|---------------|-------------------------|------|
| Modulation | ax HE40-OFDMA | Test Freq. (MHz) | 2437 |
| Polarization | Vertical | | |

Test By : Akun Chung Temperature(°C): 23 Humidity(%): 65

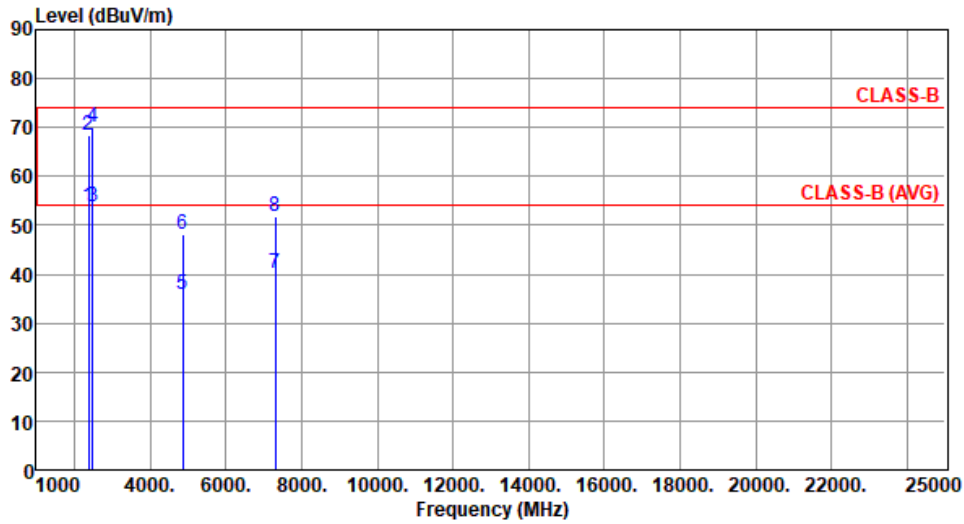

| | Freq. MHz | Emission level dBuV/m | Limit dBuV/m | Margin dB | SA reading dBuV | Factor dB/m | Remark | ANT High cm | Turn Table deg |
|---|--------------|-----------------------------|-----------------|--------------|-----------------------|----------------|---------|-------------------|----------------------|
| 1 | 2390.00 | 53.89 | 54.00 | -0.11 | 56.64 | -2.75 | Average | 169 | 114 |
| 2 | 2390.00 | 68.27 | 74.00 | -5.73 | 71.02 | -2.75 | Peak | 169 | 114 |
| 3 | 2483.50 | 53.84 | 54.00 | -0.16 | 56.54 | -2.70 | Average | 169 | 114 |
| 4 | 2483.50 | 70.15 | 74.00 | -3.85 | 72.85 | -2.70 | Peak | 169 | 114 |
| 5 | 4874.00 | 35.99 | 54.00 | -18.01 | 31.86 | 4.13 | Average | 348 | 341 |
| 6 | 4874.00 | 48.11 | 74.00 | -25.89 | 43.98 | 4.13 | Peak | 348 | 341 |
| 7 | 7311.00 | 40.27 | 54.00 | -13.73 | 30.99 | 9.28 | Average | 100 | 350 |
| 8 | 7311.00 | 51.88 | 74.00 | -22.12 | 42.60 | 9.28 | Peak | 100 | 350 |

Note 1: Emission Level (dBuV/m) = SA Reading (dBuV) + Factor* (dB/m)

*Factor includes antenna factor , cable loss and amplifier gain

Note 2: Margin (dB) = Emission level (dBuV/m) – Limit (dBuV/m).

| | | | |
|---------------------|---------------|-------------------------|------|
| Modulation | ax HE40-OFDMA | Test Freq. (MHz) | 2452 |
| Polarization | Horizontal | | |

Test By :Akun Chung Temperature(°C):23 Humidity(%):65

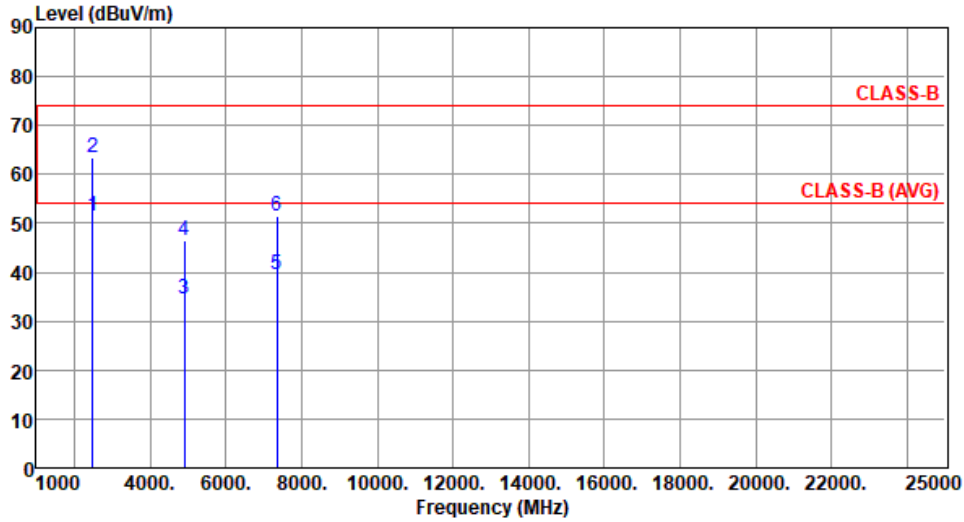

| | Freq. MHz | Emission level dBuV/m | Limit dBuV/m | Margin dB | SA reading dBuV | Factor dB/m | Remark | ANT High cm | Turn Table deg |
|---|--------------|-----------------------------|-----------------|--------------|-----------------------|----------------|---------|-------------------|----------------------|
| 1 | 2483.50 | 51.45 | 54.00 | -2.55 | 54.15 | -2.70 | Average | 100 | 286 |
| 2 | 2483.50 | 63.55 | 74.00 | -10.45 | 66.25 | -2.70 | Peak | 100 | 286 |
| 3 | 4904.00 | 34.44 | 54.00 | -19.56 | 30.35 | 4.09 | Average | 100 | 7 |
| 4 | 4904.00 | 46.38 | 74.00 | -27.62 | 42.29 | 4.09 | Peak | 100 | 7 |
| 5 | 7356.00 | 39.37 | 54.00 | -14.63 | 30.11 | 9.26 | Average | 100 | 6 |
| 6 | 7356.00 | 51.44 | 74.00 | -22.56 | 42.18 | 9.26 | Peak | 100 | 6 |

Note 1: Emission Level (dBuV/m) = SA Reading (dBuV) + Factor* (dB/m)

*Factor includes antenna factor , cable loss and amplifier gain

Note 2: Margin (dB) = Emission level (dBuV/m) – Limit (dBuV/m).

| | | | |
|---------------------|---------------|-------------------------|------|
| Modulation | ax HE40-OFDMA | Test Freq. (MHz) | 2452 |
| Polarization | Vertical | | |

Test By : Akun Chung Temperature(°C): 23 Humidity(%): 65

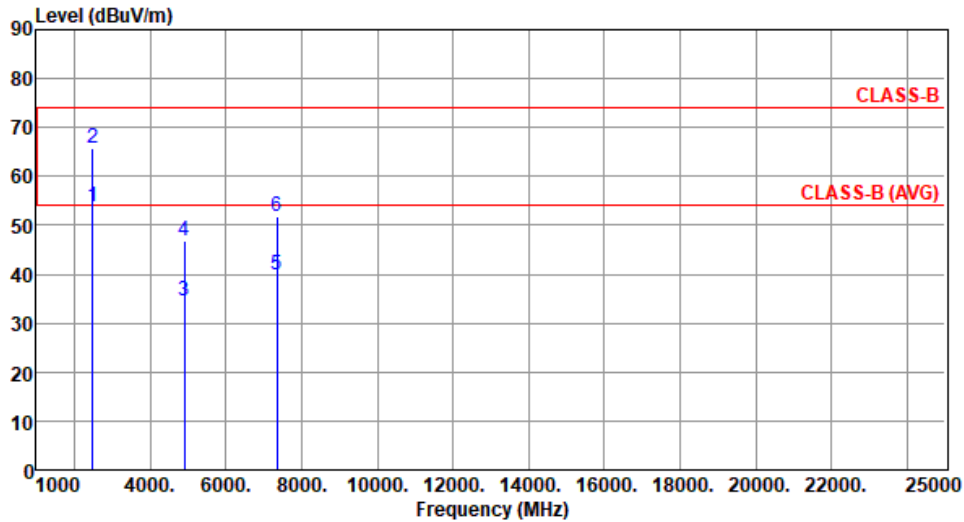

| | Freq. MHz | Emission level dBuV/m | Limit dBuV/m | Margin dB | SA reading dBuV | Factor dB/m | Remark | ANT High cm | Turn Table deg |
|---|--------------|-----------------------------|-----------------|--------------|-----------------------|----------------|---------|-------------------|----------------------|
| 1 | 2483.50 | 53.83 | 54.00 | -0.17 | 56.53 | -2.70 | Average | 163 | 115 |
| 2 | 2483.50 | 65.85 | 74.00 | -8.15 | 68.55 | -2.70 | Peak | 163 | 115 |
| 3 | 4904.00 | 34.69 | 54.00 | -19.31 | 30.60 | 4.09 | Average | 100 | 347 |
| 4 | 4904.00 | 46.74 | 74.00 | -27.26 | 42.65 | 4.09 | Peak | 100 | 347 |
| 5 | 7356.00 | 39.89 | 54.00 | -14.11 | 30.63 | 9.26 | Average | 100 | 350 |
| 6 | 7356.00 | 51.79 | 74.00 | -22.21 | 42.53 | 9.26 | Peak | 100 | 350 |

Note 1: Emission Level (dBuV/m) = SA Reading (dBuV) + Factor* (dB/m)

*Factor includes antenna factor , cable loss and amplifier gain

Note 2: Margin (dB) = Emission level (dBuV/m) – Limit (dBuV/m).

3.6 Emissions in Non-Restricted Frequency Bands

3.6.1 Emissions in Non-Restricted Frequency Bands Limit

Peak power in any 100 kHz bandwidth outside of the authorized frequency band shall be attenuated by at least 30 dB relative to the maximum in-band peak PSD level in 100 kHz.

3.6.2 Test Procedures

Reference level measurement

1. Set RBW=100kHz, VBW = 300kHz , Detector = Peak, Sweep time = Auto
2. Trace = max hold , Allow Trace to fully stabilize
3. Use the peak marker function to determine the maximum PSD level

Emission level measurement

1. Set RBW=100kHz, VBW = 300kHz , Detector = Peak, Sweep time = Auto
2. Trace = max hold , Allow Trace to fully stabilize
3. Scan Frequency range is up to 25GHz
4. Use the peak marker function to determine the maximum amplitude level

3.6.3 Test Setup

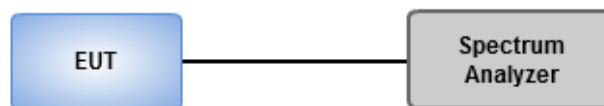

3.6.4 Unwanted Emissions into Non-Restricted Frequency Bands

| | | | |
|-------------------|------------|-----------|------------|
| Ambient Condition | 21°C / 66% | Tested By | Aska Huang |
|-------------------|------------|-----------|------------|

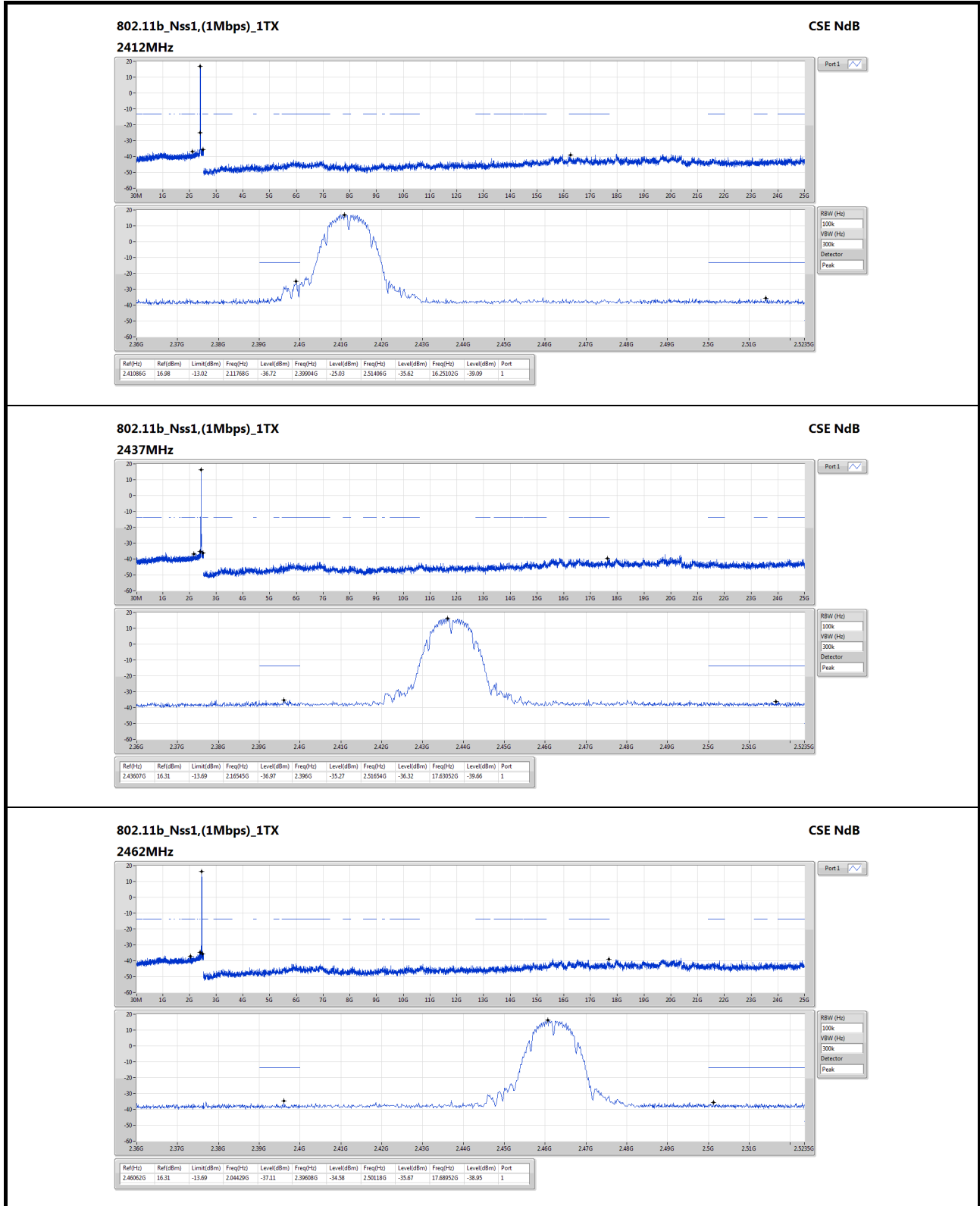

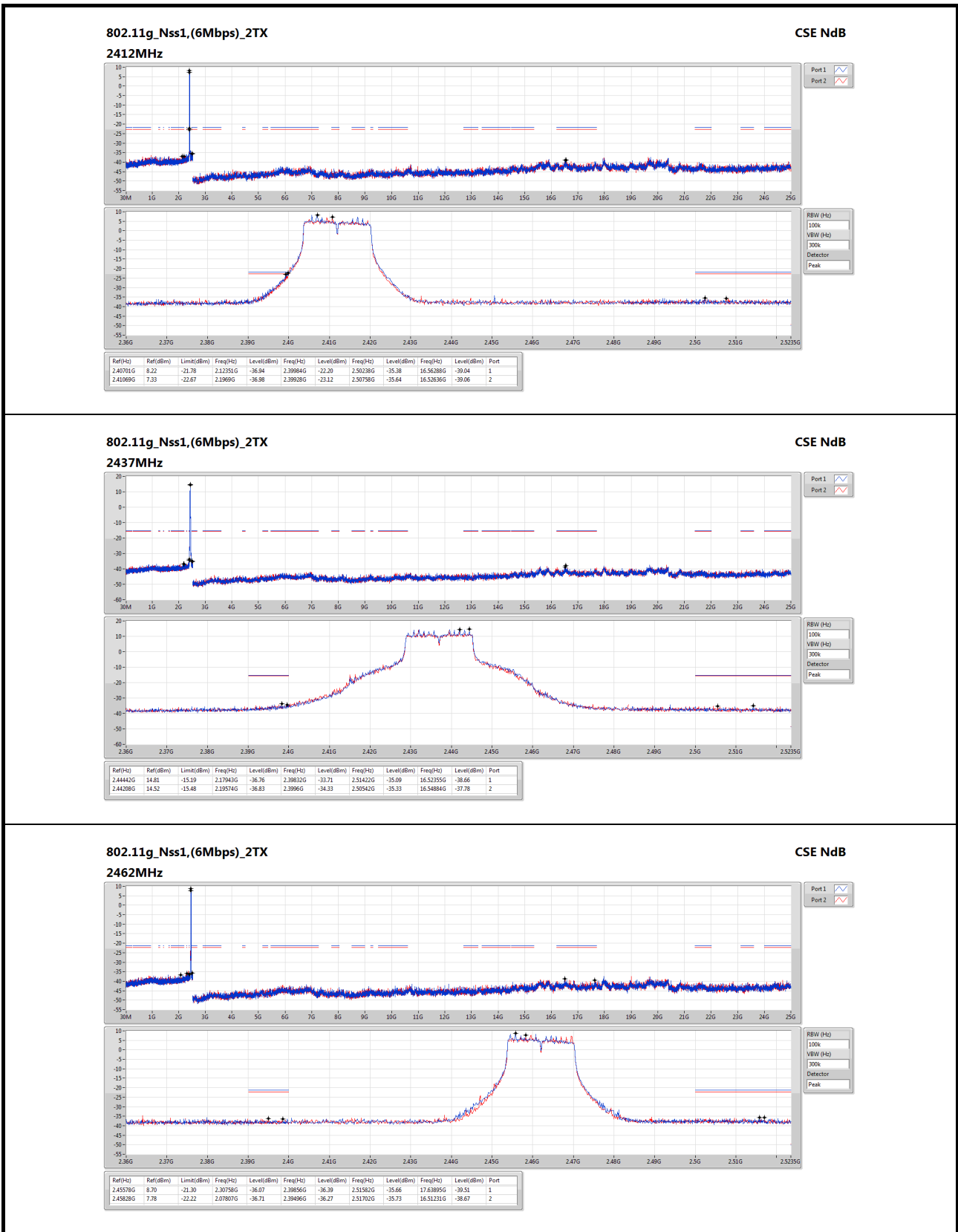

802.11ax HEW20_Nss1,(MCS0)_2TX
2412MHz

CSE NdB

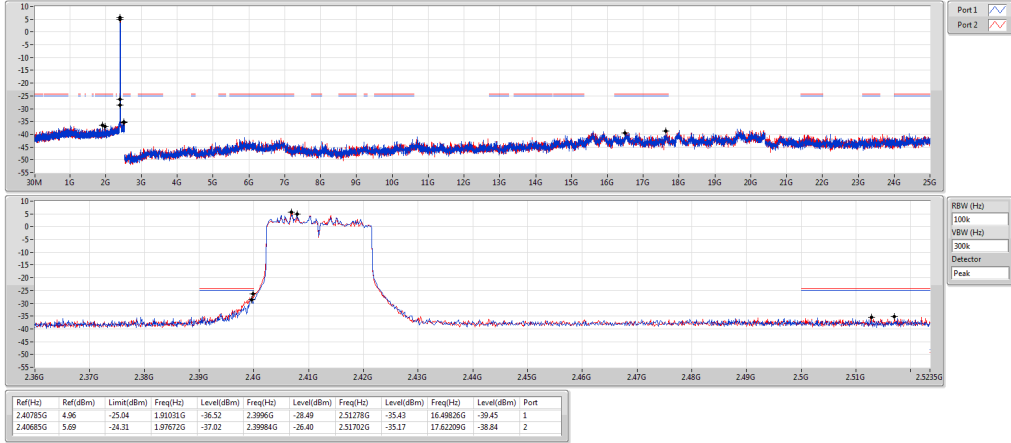

802.11ax HEW20_Nss1,(MCS0)_2TX
2437MHz

CSE NdB

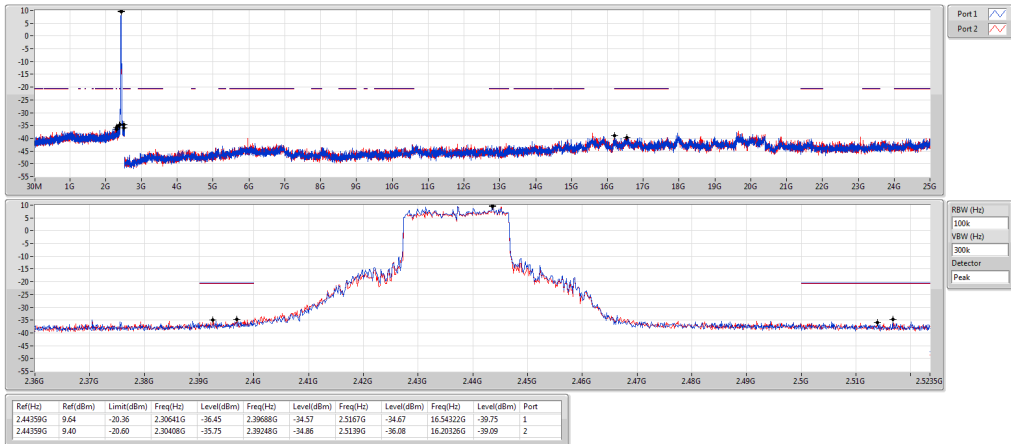

802.11ax HEW20_Nss1,(MCS0)_2TX
2462MHz

CSE NdB

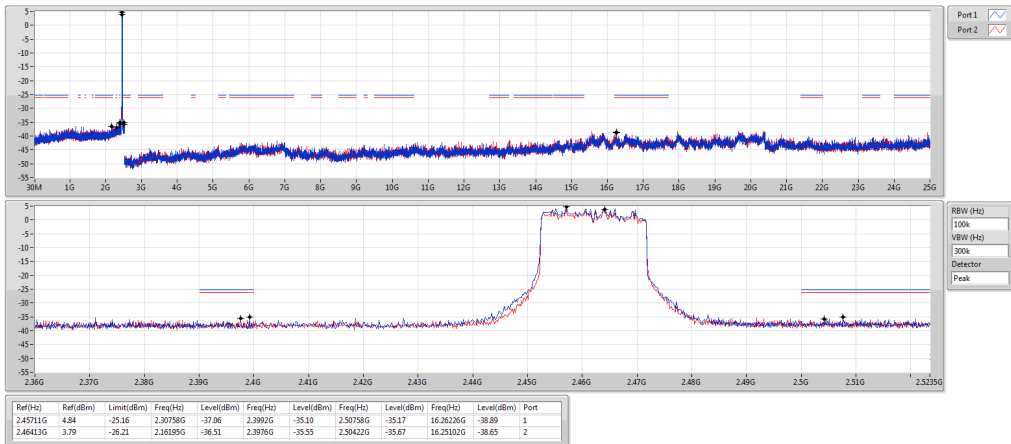

802.11ax HEW40_Nss1,(MCS0)_2TX
2422MHz

CSE NdB

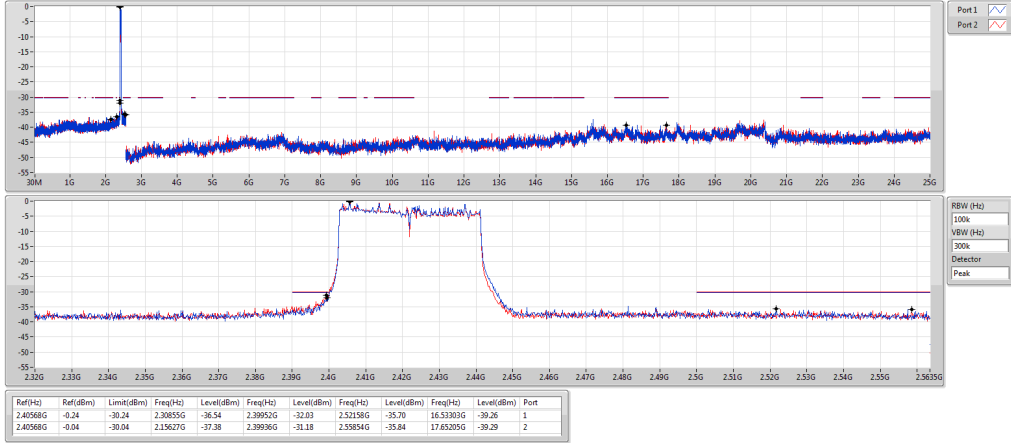

802.11ax HEW40_Nss1,(MCS0)_2TX
2437MHz

CSE NdB

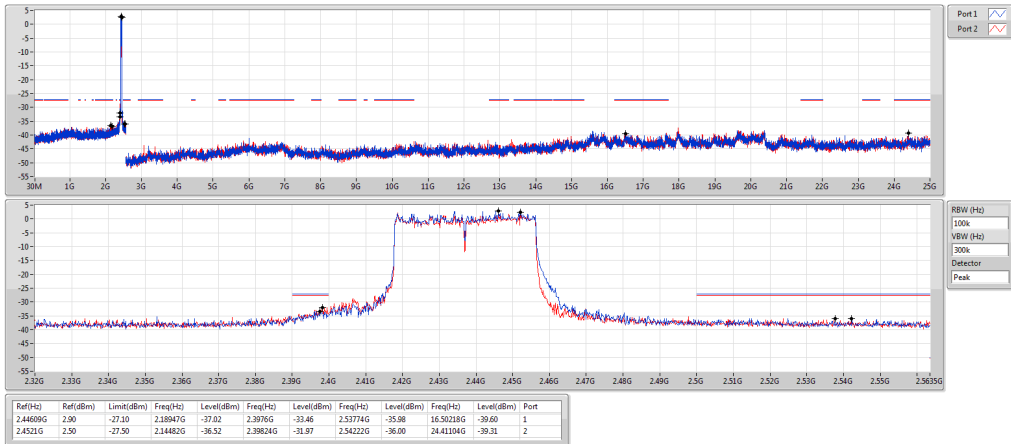

802.11ax HEW40_Nss1,(MCS0)_2TX
2452MHz

CSE NdB

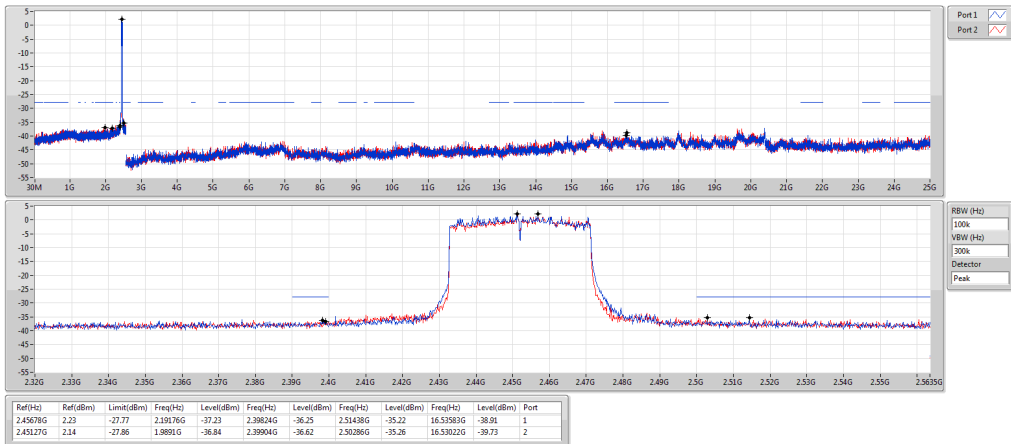

4 Test laboratory information

Established in 2012, ICC provides foremost EMC & RF Testing and advisory consultation services by our skilled engineers and technicians. Our services employ a wide variety of advanced edge test equipment and one of the widest certification extents in the business.

International Certification Corporation (EMC and Wireless Communication Laboratory), it is our definitive objective is to institute long term, trust-based associations with our clients. The expectation we set up with our clients is based on outstanding service, practical expertise and devotion to a certified value structure. Our passion is to grant our clients with best EMC / RF services by oriented knowledgeable and accommodating staff.

Our Test sites are located at Linkou District and Kwei Shan District. Location map can be found on our website <http://www.icertifi.com.tw>.

Linkou

Tel: 886-2-2601-1640

No.30-2, Ding Fwu Tsuen, Lin Kou
District, New Taipei City, Taiwan
(R.O.C.)

Kwei Shan

Tel: 886-3-271-8666

No.3-1, Lane 6, Wen San 3rd
St., Kwei Shan Dist., Tao Yuan
City 33381, Taiwan (R.O.C.)
No.2-1, Lane 6, Wen San 3rd
St., Kwei Shan Dist., Tao Yuan
City 33381, Taiwan (R.O.C.)

Kwei Shan Site II

Tel: 886-3-271-8640

No.14-1, Lane 19, Wen San 3rd
St., Kwei Shan Dist., Tao Yuan
City 333, Taiwan (R.O.C.)

If you have any suggestion, please feel free to contact us as below information.

Tel: 886-3-271-8666

Fax: 886-3-318-0345

Email: ICC_Service@icertifi.com.tw

==END==