



# FCC TEST REPORT

**REPORT NO.:** RF950414L02B

**MODEL NO.:** USR5412

**RECEIVED:** Apr. 10, 2006

**TESTED:** Apr. 10 ~ Apr. 14, 2006

**ISSUED:** Jul. 07, 2006

**APPLICANT:** Gemtek Technology Co., Ltd.

**ADDRESS:** No.1, Jen Ai Road, Hsinchu Industrial Park,  
Hukou Hsinchu, Taiwan, R.O.C. 303

**ISSUED BY:** Advance Data Technology Corporation

**LAB ADDRESS:** 47 14<sup>th</sup> Lin, Chiapau Tsun, Linko, Taipei, Taiwan,  
R.O.C.

**TEST LOCATION:** No. 19, Hwa Ya 2<sup>nd</sup> Rd., Kueishan, Taoyuan,  
Taiwan, R.O.C.

This test report consists of 103 pages in total. It may be duplicated completely for legal use with the approval of the applicant. It should not be reproduced except in full, without the written approval of our laboratory. The client should not use it to claim product endorsement by CNLA, A2LA or any government agencies. The test results in the report only apply to the tested sample.





## TABLE OF CONTENTS

1.	CERTIFICATION .....	4
2.	SUMMARY OF TEST RESULTS .....	5
2.1	MEASUREMENT UNCERTAINTY .....	5
3.	GENERAL INFORMATION .....	6
3.1	GENERAL DESCRIPTION OF EUT .....	6
3.2	DESCRIPTION OF TEST MODES .....	7
3.2.1	CONFIGURATION OF SYSTEM UNDER TEST .....	7
3.2.2	TEST MODE APPLICABILITY AND TESTED CHANNEL DETAIL .....	8
3.3	GENERAL DESCRIPTION OF APPLIED STANDARDS .....	10
3.4	DESCRIPTION OF SUPPORT UNITS .....	11
4.	TEST TYPES AND RESULTS .....	12
4.1	CONDUCTED EMISSION MEASUREMENT .....	12
4.1.1	LIMITS OF CONDUCTED EMISSION MEASUREMENT .....	12
4.1.2	TEST INSTRUMENTS .....	12
4.1.3	TEST PROCEDURES .....	13
4.1.4	DEVIATION FROM TEST STANDARD .....	13
4.1.5	TEST SETUP .....	14
4.1.6	EUT OPERATING CONDITIONS .....	14
4.1.7	TEST RESULTS .....	15
4.2	RADIATED EMISSION MEASUREMENT .....	33
4.2.1	LIMITS OF RADIATED EMISSION MEASUREMENT .....	33
4.2.2	TEST INSTRUMENTS .....	34
4.2.3	TEST PROCEDURES .....	35
4.2.4	DEVIATION FROM TEST STANDARD .....	35
4.2.5	TEST SETUP .....	36
4.2.6	EUT OPERATING CONDITIONS .....	36
4.2.7	TEST RESULTS .....	37
4.3	6dB BANDWIDTH MEASUREMENT .....	52
4.3.1	LIMITS OF 6dB BANDWIDTH MEASUREMENT .....	52
4.3.2	TEST INSTRUMENTS .....	52
4.3.3	TEST PROCEDURE .....	52
4.3.4	DEVIATION FROM TEST STANDARD .....	52
4.3.5	TEST SETUP .....	53
4.3.6	EUT OPERATING CONDITIONS .....	53
4.3.7	TEST RESULTS .....	54
4.4	MAXIMUM PEAK OUTPUT POWER .....	66
4.4.1	LIMITS OF MAXIMUM PEAK OUTPUT POWER MEASUREMENT .....	66
4.4.2	INSTRUMENTS .....	66
4.4.3	TEST PROCEDURES .....	66
4.4.4	DEVIATION FROM TEST STANDARD .....	66
4.4.5	TEST SETUP .....	67
4.4.6	EUT OPERATING CONDITIONS .....	67
4.4.7	TEST RESULTS .....	68
4.5	POWER SPECTRAL DENSITY MEASUREMENT .....	70
4.5.1	LIMITS OF POWER SPECTRAL DENSITY MEASUREMENT .....	70
4.5.2	TEST INSTRUMENTS .....	70
4.5.3	TEST PROCEDURE .....	70
4.5.4	DEVIATION FROM TEST STANDARD .....	70



4.5.5	TEST SETUP .....	71
4.5.6	EUT OPERATING CONDITION .....	71
4.5.7	TEST RESULTS .....	72
4.6	BAND EDGES MEASUREMENT .....	84
4.6.1	LIMITS OF BAND EDGES MEASUREMENT .....	84
4.6.2	TEST INSTRUMENTS .....	84
4.6.3	TEST PROCEDURE .....	84
4.6.4	DEVIATION FROM TEST STANDARD .....	84
4.6.5	EUT OPERATING CONDITION .....	84
4.6.6	TEST RESULTS .....	85
4.7	ANTENNA REQUIREMENT .....	101
4.7.1	STANDARD APPLICABLE .....	101
4.7.2	ANTENNA CONNECTED CONSTRUCTION.....	101
5.	INFORMATION ON THE TESTING LABORATORIES .....	102
APPENDIX-A	.....	A-1



# 1. CERTIFICATION

**PRODUCT:** Wireless Nd, PC Card  
**MODEL NO.:** USR5412  
**BRAND:** USRobotics  
**APPLICANT:** Gemtek Technology Co., Ltd.  
**TESTED:** Apr. 10 ~ Apr. 14, 2006  
**TEST SAMPLE:** ENGINEERING SAMPLE  
**STANDARDS:** FCC Part 15, Subpart C (Section 15.247),  
ANSI C63.4-2003

The above equipment has been tested by **Advance Data Technology Corporation**, and found compliance with the requirement of the above standards. The test record, data evaluation & Equipment Under Test (EUT) configurations represented herein are true and accurate accounts of the measurements of the sample's EMC characteristics under the conditions specified in this report.

**PREPARED BY** : Andrea Hsia , **DATE:** Jul. 07, 2006  
Andrea Hsia

**TECHNICAL ACCEPTANCE** : Long Chen , **DATE:** Jul. 07, 2006  
Responsible for RF Long Chen

**APPROVED BY** : Gary Chang , **DATE:** Jul. 07, 2006  
Gary Chang / Supervisor

## 2. SUMMARY OF TEST RESULTS

The EUT has been tested according to the following specifications:

APPLIED STANDARD: FCC Part 15, Subpart C			
STANDARD SECTION	TEST TYPE AND LIMIT	RESULT	REMARK
15.207	AC Power Conducted Emission	PASS	Meet the requirement of limit. Minimum passing margin is -18.60dB at 0.154MHz.
15.247(a)(2)	Spectrum Bandwidth of a Direct Sequence Spread Spectrum System Limit : min. 500kHz	PASS	Meet the requirement of limit.
15.247(b)	Maximum Peak Output Power Limit: max. 30dBm	PASS	Meet the requirement of limit.
15.247(d)	Transmitter Radiated Emissions Limit: Table 15.209	PASS	Meet the requirement of limit. Minimum passing margin is -1.12dB at 2387.00MHz.
15.247(e)	Power Spectral Density Limit: max. 8dBm	PASS	Meet the requirement of limit.
15.247(d)	Band Edge Measurement Limit: 20dB less than the peak value of fundamental frequency	PASS	Meet the requirement of limit.

### 2.1 MEASUREMENT UNCERTAINTY

Where relevant, the following measurement uncertainty levels have been estimated for tests performed on the EUT as specified in CISPR 16-4:

MEASUREMENT	FREQUENCY	UNCERTAINTY
Conducted emissions	9kHz ~ 30MHz	2.44dB
Radiated emissions	30MHz ~ 200MHz	3.55dB
	200MHz ~ 1000MHz	3.58dB
	1GHz ~ 18GHz	1.10dB
	18GHz ~ 40GHz	0.91dB

This uncertainty represents an expanded uncertainty expressed at approximately the 95% confidence level using a coverage factor of  $k = 2$ .

### 3. GENERAL INFORMATION

#### 3.1 GENERAL DESCRIPTION OF EUT

<b>PRODUCT</b>	Wireless N <sub>d</sub> PC Card
<b>MODEL NO.</b>	USR5412
<b>FCC ID</b>	MXF-C950622G
<b>POWER SUPPLY</b>	3.3Vdc from host equipment
<b>MODULATION TYPE</b>	CCK, DQPSK, DBPSK for DSSS 64QAM, 16QAM, QPSK, BPSK for OFDM
<b>MODULATION TECHNOLOGY</b>	DSSS, OFDM
<b>TRANSFER RATE</b>	802.11b: 11/ 5.5/ 2/ 1Mbps 802.11g: 54/ 48/ 36/ 24/ 18/ 12/ 9/ 6Mbps Draft 802.11n (20MHz): 130/ 117/ 104/ 78/ 52/ 39/ 26/ 13Mbps Draft 802.11n (40MHz): 270/ 243/ 216/ 162/ 108/ 81/ 54/ 27Mbps
<b>FREQUENCY RANGE</b>	2412MHz ~ 2462MHz
<b>NUMBER OF CHANNEL</b>	11 for 802.11b, 802.11g, draft 802.11n (20MHz) 7 for draft 802.11n (40MHz)
<b>MAXIMUM OUTPUT POWER</b>	135.687mW
<b>ANTENNA TYPE</b>	Printed antenna with 1.5dBi gain
<b>DATA CABLE</b>	NA
<b>I/O PORTS</b>	NA

**NOTE:**

1. This is a duplicate report of RF950414L02, the differences are changing the model name, product name, brand name and applicant.
2. The EUT incorporates a MIMO function with 802.11b, 802.11g, draft 802.11n. Physically, the card provides two completed transmit and three receivers.
3. The EUT is 2 \* 3 spatial MIMO (2Tx & 3Rx) without beam forming function that only operate dual chain configuration (both chain 0 and chain 1 transceivers are operational).
4. When the EUT operating in draft 802.11n, the software operation, which is defined by manufacturer, only set 0 ~ 15 of "MCS" (MCS: Modulation and Coding Schemes) for dual Tx.
5. The EUT complies with draft 802.11n standards and backwards compatible with 802.11b, 802.11g products.
6. The EUT operates in the 2.4GHz frequency spectrum with throughput of up to 270Mbps.
7. The above EUT information was declared by manufacturer and for more detailed features description, please refer to the manufacturer's specifications or user's manual.

### 3.2 DESCRIPTION OF TEST MODES

Eleven channels are provided for 802.11b, 802.11g, draft 802.11n (20MHz):

CHANNEL	FREQUENCY	CHANNEL	FREQUENCY
1	2412MHz	7	2442MHz
2	2417MHz	8	2447MHz
3	2422MHz	9	2452MHz
4	2427MHz	10	2457MHz
5	2432MHz	11	2462MHz
6	2437MHz		

Seven channels are provided for draft 802.11n (40MHz):

CHANNEL	FREQUENCY	CHANNEL	FREQUENCY
1	2422MHz	5	2442MHz
2	2427MHz	6	2447MHz
3	2432MHz	7	2452MHz
4	2437MHz		

#### 3.2.1 CONFIGURATION OF SYSTEM UNDER TEST

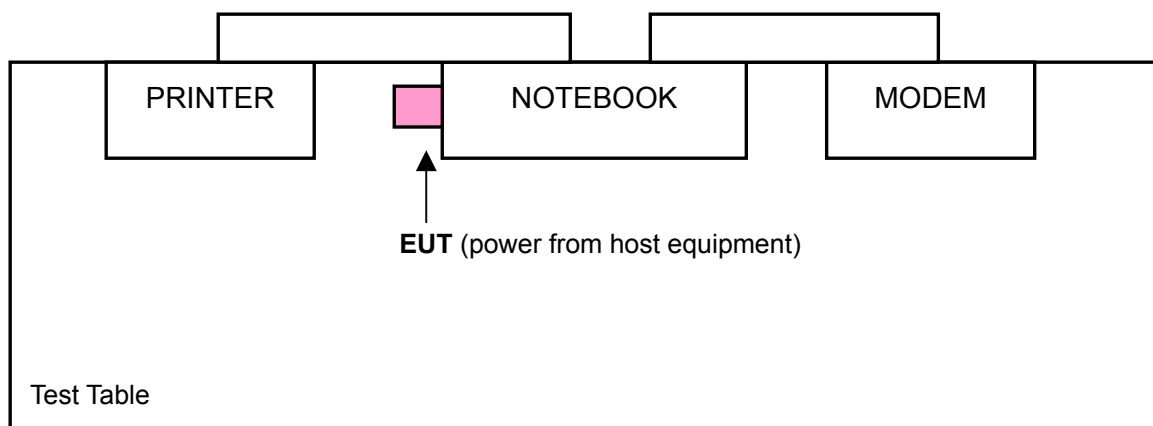

### 3.2.2 TEST MODE APPLICABILITY AND TESTED CHANNEL DETAIL

EUT CONFIGURE MODE	APPLICABLE TO				DESCRIPTION
	PLC	RE < 1G	RE ≥ 1G	APCM	
-	√	√	√	√	-

Where **PLC**: Power Line Conducted Emission

**RE < 1G**: Radiated Emission below 1GHz

**RE ≥ 1G**: Radiated Emission above 1GHz

**APCM**: Antenna Port Conducted Measurement

#### **POWER LINE CONDUCTED EMISSION TEST:**

- Pre-Scan has been conducted to determine the worst-case mode from all possible combinations between available modulations, data rates and antenna ports (if EUT with antenna diversity architecture).
- Following channel(s) was (were) selected for the final test as listed below.

MODE	AVAILABLE CHANNEL	TESTED CHANNEL	MODULATION TECHNOLOGY	MODULATION TYPE	DATA RATE (Mbps)	TX CONDITION
802.11g	1 to 11	1, 6, 11	OFDM	BPSK	6	Single
Draft 802.11n (20MHz)	1 to 11	1, 6, 11	OFDM	BPSK	13	Dual
Draft 802.11n (40MHz)	1 to 7	1, 4, 7	OFDM	BPSK	27	Dual

#### **RADIATED EMISSION TEST (BELOW 1 GHz):**

- Pre-Scan has been conducted to determine the worst-case mode from all possible combinations between available modulations, data rates and antenna ports (if EUT with antenna diversity architecture).
- Following channel(s) was (were) selected for the final test as listed below.

MODE	AVAILABLE CHANNEL	TESTED CHANNEL	MODULATION TECHNOLOGY	MODULATION TYPE	DATA RATE (Mbps)	TX CONDITION
802.11g	1 to 11	1	OFDM	BPSK	6	Single
Draft 802.11n (20MHz)	1 to 11	1	OFDM	BPSK	13	Dual
Draft 802.11n (40MHz)	1 to 7	1	OFDM	BPSK	27	Dual



**RADIATED EMISSION TEST (ABOVE 1 GHz):**

- Pre-Scan has been conducted to determine the worst-case mode from all possible combinations between available modulations, data rates and antenna ports (if EUT with antenna diversity architecture).
- Following channel(s) was (were) selected for the final test as listed below.

MODE	AVAILABLE CHANNEL	TESTED CHANNEL	MODULATION TECHNOLOGY	MODULATION TYPE	DATA RATE (Mbps)	TX CONDITION
802.11b	1 to 11	1, 6, 11	DSSS	DBPSK	1	Single
802.11g	1 to 11	1, 6, 11	OFDM	BPSK	6	Single
Draft 802.11n (20MHz)	1 to 11	1, 6, 11	OFDM	BPSK	13	Dual
Draft 802.11n (40MHz)	1 to 7	1, 4, 7	OFDM	BPSK	27	Dual

**BANDEDGE MEASUREMENT:**

- Pre-Scan has been conducted to determine the worst-case mode from all possible combinations between available modulations, data rates and antenna ports (if EUT with antenna diversity architecture).
- Following channel(s) was (were) selected for the final test as listed below.

MODE	AVAILABLE CHANNEL	TESTED CHANNEL	MODULATION TECHNOLOGY	MODULATION TYPE	DATA RATE (Mbps)	TX CONDITION
802.11b	1 to 11	1, 11	DSSS	DBPSK	1	Single
802.11g	1 to 11	1, 11	OFDM	BPSK	6	Single
Draft 802.11n (20MHz)	1 to 11	1, 11	OFDM	BPSK	13	Dual
Draft 802.11n (40MHz)	1 to 7	1, 7	OFDM	BPSK	27	Dual



**ANTENNA PORT CONDUCTED MEASUREMENT:**

- Pre-Scan has been conducted to determine the worst-case mode from all possible combinations between available modulations, data rates and antenna ports (if EUT with antenna diversity architecture).
- Following channel(s) was (were) selected for the final test as listed below.

MODE	AVAILABLE CHANNEL	TESTED CHANNEL	MODULATION TECHNOLOGY	MODULATION TYPE	DATA RATE (Mbps)	TX CONDITION
802.11b	1 to 11	1, 6, 11	DSSS	DBPSK	1	Single
802.11g	1 to 11	1, 6, 11	OFDM	BPSK	6	Single
Draft 802.11n (20MHz)	1 to 11	1, 6, 11	OFDM	BPSK	13	Dual
Draft 802.11n (40MHz)	1 to 7	1, 4, 7	OFDM	BPSK	27	Dual

**3.3 GENERAL DESCRIPTION OF APPLIED STANDARDS**

The EUT is a RF product. According to the specifications of the manufacturer, it must comply with the requirements of the following standards:

**FCC Part 15, Subpart C. (15.247)**

**ANSI C63.4-2003**

All test items have been performed and recorded as per the above standards.

**NOTE:** The EUT is also considered as a kind of computer peripheral, because the connection to computer is necessary for typical use. It has been verified to comply with the requirements of FCC Part 15, Subpart B, Class B (DoC). The test report has been issued separately.



### 3.4 DESCRIPTION OF SUPPORT UNITS

The EUT has been tested as an independent unit together with other necessary accessories or support units. The following support units or accessories were used to form a representative test configuration during the tests.

NO.	PRODUCT	BRAND	MODEL NO.	SERIAL NO.	FCC ID
1	NOTEBOOK COMPUTER	DELL	PP05L	12130898320	E2K24CLNS
2	PRINTER	EPSON	LQ-300+	DCGY047265	FCC DoC Approved
3	MODEM	ACEEX	1414V/3	0401008248	IFAXDM1414

NO.	SIGNAL CABLE DESCRIPTION OF THE ABOVE SUPPORT UNITS
1	NA
2	NA
3	NA

**NOTE:** All power cords of the above support units are non shielded (1.8m).

## 4. TEST TYPES AND RESULTS

### 4.1 CONDUCTED EMISSION MEASUREMENT

#### 4.1.1 LIMITS OF CONDUCTED EMISSION MEASUREMENT

FREQUENCY OF EMISSION (MHz)	CONDUCTED LIMIT (dB $\mu$ V)	
	Quasi-peak	Average
0.15-0.5	66 to 56	56 to 46
0.5-5	56	46
5-30	60	50

- NOTE:**
1. The lower limit shall apply at the transition frequencies.
  2. The limit decreases in line with the logarithm of the frequency in the range of 0.15 to 0.50 MHz.
  3. All emanations from a class A/B digital device or system, including any network of conductors and apparatus connected thereto, shall not exceed the level of field strengths specified above.

#### 4.1.2 TEST INSTRUMENTS

DESCRIPTION & MANUFACTURER	MODEL NO.	SERIAL NO.	CALIBRATED UNTIL
Test Receiver ROHDE & SCHWARZ	ESCS30	100291	Nov. 11, 2006
RF signal cable Woken	5D-FB	Cable-HYC01-01	Jan. 06, 2007
LISN SCHWARZBECK	NNBL 8226-2	8226-142	May 02, 2006
LISN ROHDE & SCHWARZ	ESH2-Z5	100104	Feb. 07, 2007
Software ADT	ADT_Cond_V3	NA	NA

- NOTE:**
1. The calibration interval of the above test instruments is 12 months and the calibrations are traceable to NML/ROC and NIST/USA.
  2. The test was performed in HwaYa Shielded Room 1.
  3. The VCCI Site Registration No. is C-2040.

#### 4.1.3 TEST PROCEDURES

- a. The EUT was placed 0.4 meters from the conducting wall of the shielded room with EUT being connected to the power mains through a line impedance stabilization network (LISN). Other support units were connected to the power mains through another LISN. The two LISNs provide 50 ohm/ 50uH of coupling impedance for the measuring instrument.
- b. Both lines of the power mains connected to the EUT were checked for maximum conducted interference.
- c. The frequency range from 150kHz to 30MHz was searched. Emission levels under (Limit - 20dB) was not recorded.

#### 4.1.4 DEVIATION FROM TEST STANDARD

No deviation

#### 4.1.5 TEST SETUP

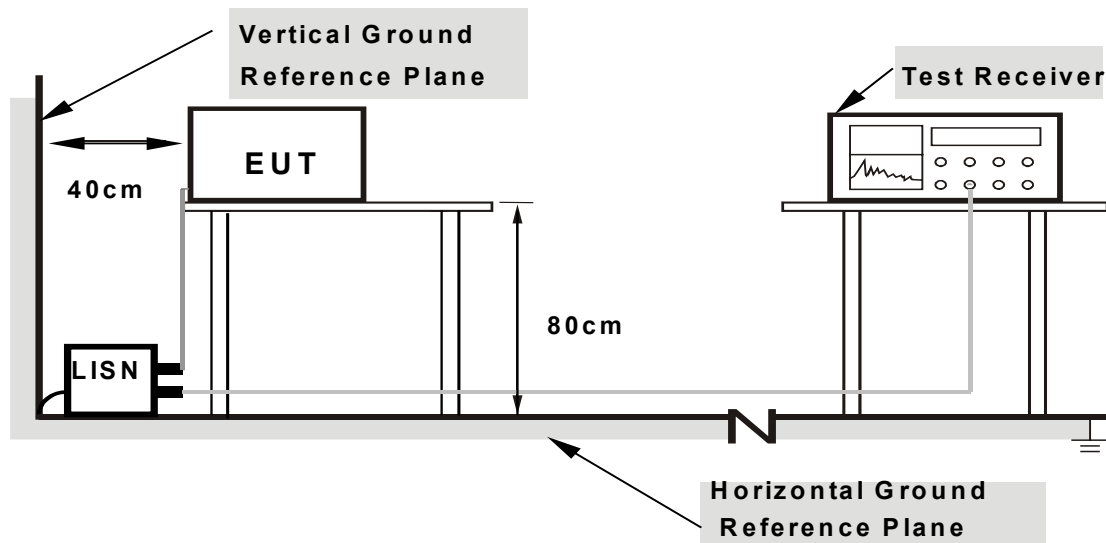

- Note:**
1. Support units were connected to second LISN.
  2. Both of LISNs (AMN) are 80 cm from EUT and at least 80 from other units and other metal planes

For the actual test configuration, please refer to the related item – Photographs of the Test Configuration.

#### 4.1.6 EUT OPERATING CONDITIONS

- a. Connected the EUT into the notebook system and placed on a testing table.
- b. The computer system ran a test program (provided by manufacturer) to enable EUT under transmission condition continuously at specific channel frequency.
- c. The notebook system displayed “H” messages on its screen.
- d. The notebook system show “H” messages to modem.
- e. The notebook system sent "H" messages to printer and the printer prints them on paper.
- f. Repeated item c ~e.

#### 4.1.7 TEST RESULTS

##### CONDUCTED WORST-CASE DATA: 802.11g OFDM MODULATION:

EUT TEST CONDITION		MEASUREMENT DETAIL	
CHANNEL	Channel 1	PHASE	Line 1
MODULATION TYPE	BPSK	6dB BANDWIDTH	9 kHz
TRANSFER RATE	6Mbps	INPUT POWER (SYSTEM)	120Vac, 60 Hz
ENVIRONMENTAL CONDITIONS	23deg. C, 60%RH, 991hPa	TESTED BY	Match Tsui

No	Freq. [MHz]	Corr. Factor (dB)	Reading Value [dB (uV)]		Emission Level [dB (uV)]		Limit [dB (uV)]		Margin (dB)	
			Q.P.	AV.	Q.P.	AV.	Q.P.	AV.	Q.P.	AV.
1	0.150	0.10	40.57	-	40.67	-	66.00	56.00	-25.33	-
2	0.228	0.10	38.56	-	38.66	-	62.52	52.52	-23.86	-
3	0.353	0.10	31.61	-	31.71	-	58.89	48.89	-27.18	-
4	0.705	0.15	25.35	-	25.50	-	56.00	46.00	-30.50	-
5	2.012	0.20	29.69	-	29.89	-	56.00	46.00	-26.11	-
6	10.016	0.46	36.57	-	37.03	-	60.00	50.00	-22.97	-

- REMARKS:**
1. Q.P. and AV. are abbreviations of quasi-peak and average individually.
  2. "-": The Quasi-peak reading value also meets average limit and measurement with the average detector is unnecessary.
  3. The emission levels of other frequencies were very low against the limit.
  4. Margin value = Emission level - Limit value
  5. Correction factor = Insertion loss + Cable loss
  6. Emission Level = Correction Factor + Reading Value.

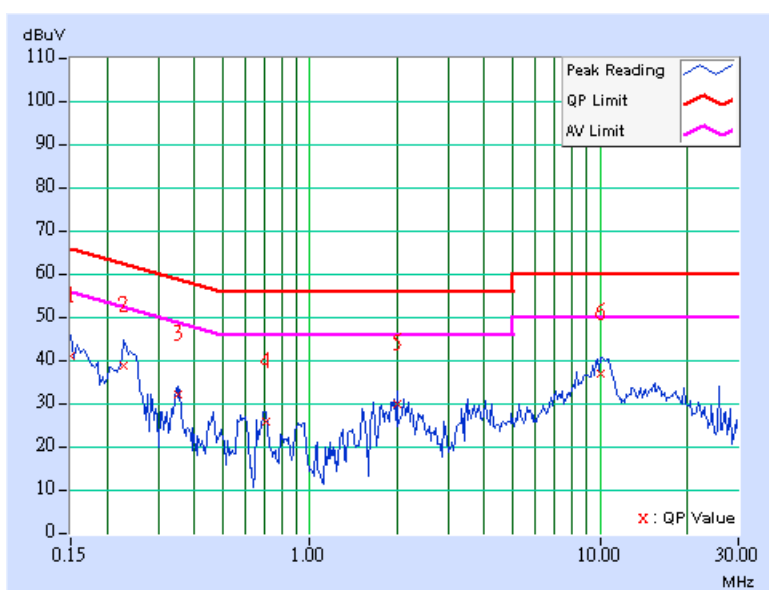

EUT TEST CONDITION		MEASUREMENT DETAIL	
CHANNEL	Channel 1	PHASE	Line 2
MODULATION TYPE	BPSK	6dB BANDWIDTH	9 kHz
TRANSFER RATE	6Mbps	INPUT POWER (SYSTEM)	120Vac, 60 Hz
ENVIRONMENTAL CONDITIONS	23deg. C, 60%RH, 991hPa	TESTED BY	Match Tsui

No	Freq. [MHz]	Corr. Factor (dB)	Reading Value [dB (uV)]		Emission Level [dB (uV)]		Limit [dB (uV)]		Margin (dB)	
			Q.P.	AV.	Q.P.	AV.	Q.P.	AV.	Q.P.	AV.
			1	0.150	0.10	40.74	-	40.84	-	66.00
2	0.224	0.10	36.53	-	36.63	-	62.66	52.66	-26.03	-
3	0.349	0.10	30.45	-	30.55	-	58.98	48.98	-28.43	-
4	1.750	0.18	29.25	-	29.43	-	56.00	46.00	-26.57	-
5	3.582	0.33	23.40	-	23.73	-	56.00	46.00	-32.27	-
6	10.277	0.46	37.18	-	37.64	-	60.00	50.00	-22.36	-

- REMARKS:**
1. Q.P. and AV. are abbreviations of quasi-peak and average individually.
  2. "-": The Quasi-peak reading value also meets average limit and measurement with the average detector is unnecessary.
  3. The emission levels of other frequencies were very low against the limit.
  4. Margin value = Emission level - Limit value
  5. Correction factor = Insertion loss + Cable loss
  6. Emission Level = Correction Factor + Reading Value.

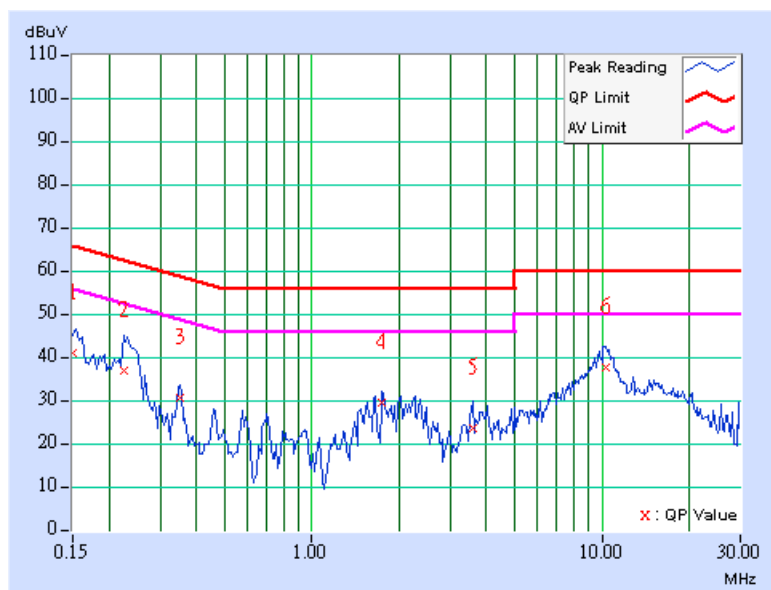



EUT TEST CONDITION		MEASUREMENT DETAIL	
CHANNEL	Channel 6	PHASE	Line 1
MODULATION TYPE	BPSK	6dB BANDWIDTH	9 kHz
TRANSFER RATE	6Mbps	INPUT POWER (SYSTEM)	120Vac, 60 Hz
ENVIRONMENTAL CONDITIONS	23deg. C, 60%RH, 991hPa	TESTED BY	Match Tsui

No	Freq. [MHz]	Corr. Factor (dB)	Reading Value [dB (uV)]		Emission Level [dB (uV)]		Limit [dB (uV)]		Margin (dB)	
			Q.P.	AV.	Q.P.	AV.	Q.P.	AV.	Q.P.	AV.
1	0.150	0.10	42.00	-	42.10	-	66.00	56.00	-23.90	-
2	0.228	0.10	38.72	-	38.82	-	62.52	52.52	-23.70	-
3	0.353	0.10	31.65	-	31.75	-	58.89	48.89	-27.14	-
4	0.570	0.13	21.18	-	21.31	-	56.00	46.00	-34.69	-
5	1.703	0.20	23.87	-	24.07	-	56.00	46.00	-31.93	-
6	10.117	0.46	35.30	-	35.76	-	60.00	50.00	-24.24	-

- REMARKS:**
1. Q.P. and AV. are abbreviations of quasi-peak and average individually.
  2. "-": The Quasi-peak reading value also meets average limit and measurement with the average detector is unnecessary.
  3. The emission levels of other frequencies were very low against the limit.
  4. Margin value = Emission level - Limit value
  5. Correction factor = Insertion loss + Cable loss
  6. Emission Level = Correction Factor + Reading Value.

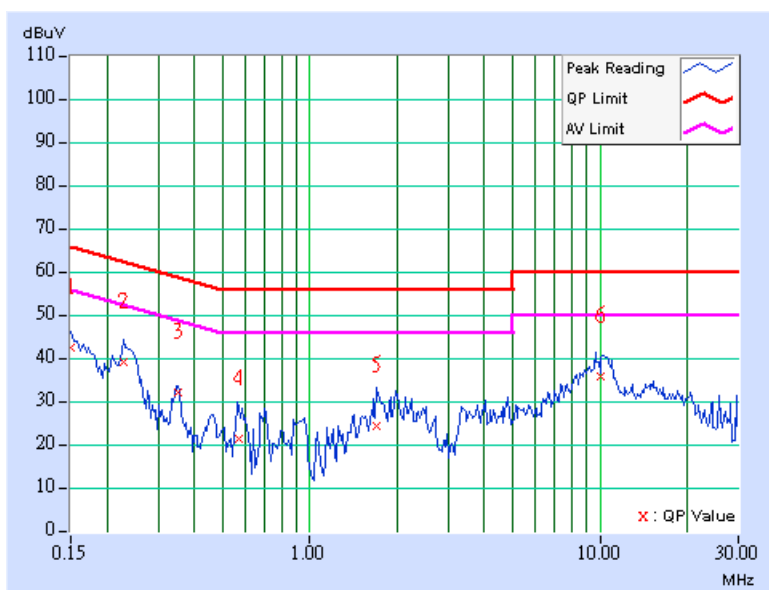

EUT TEST CONDITION		MEASUREMENT DETAIL	
CHANNEL	Channel 6	PHASE	Line 2
MODULATION TYPE	BPSK	6dB BANDWIDTH	9 kHz
TRANSFER RATE	6Mbps	INPUT POWER (SYSTEM)	120Vac, 60 Hz
ENVIRONMENTAL CONDITIONS	23deg. C, 60%RH, 991hPa	TESTED BY	Match Tsui

No	Freq. [MHz]	Corr. Factor (dB)	Reading Value [dB (uV)]		Emission Level [dB (uV)]		Limit [dB (uV)]		Margin (dB)	
			Q.P.	AV.	Q.P.	AV.	Q.P.	AV.	Q.P.	AV.
1	0.158	0.10	38.24	-	38.34	-	65.58	55.58	-27.24	-
2	0.232	0.10	38.64	-	38.74	-	62.38	52.38	-23.64	-
3	0.353	0.10	30.83	-	30.93	-	58.89	48.89	-27.96	-
4	0.580	0.10	21.27	-	21.37	-	56.00	46.00	-34.63	-
5	2.016	0.20	30.43	-	30.63	-	56.00	46.00	-25.37	-
6	10.070	0.46	36.64	-	37.10	-	60.00	50.00	-22.90	-

- REMARKS:**
1. Q.P. and AV. are abbreviations of quasi-peak and average individually.
  2. "-": The Quasi-peak reading value also meets average limit and measurement with the average detector is unnecessary.
  3. The emission levels of other frequencies were very low against the limit.
  4. Margin value = Emission level - Limit value
  5. Correction factor = Insertion loss + Cable loss
  6. Emission Level = Correction Factor + Reading Value.

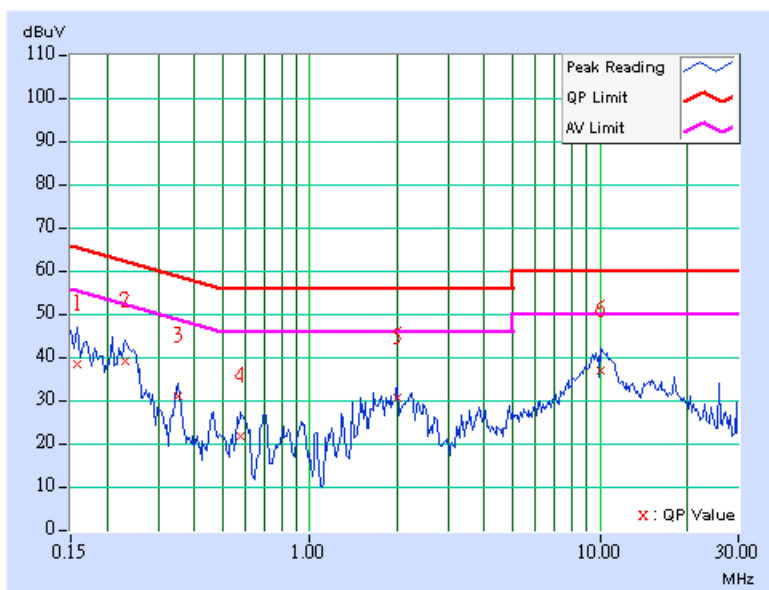

EUT TEST CONDITION		MEASUREMENT DETAIL	
CHANNEL	Channel 11	PHASE	Line 1
MODULATION TYPE	BPSK	6dB BANDWIDTH	9 kHz
TRANSFER RATE	6Mbps	INPUT POWER (SYSTEM)	120Vac, 60 Hz
ENVIRONMENTAL CONDITIONS	23deg. C, 60%RH, 991hPa	TESTED BY	Match Tsui

No	Freq. [MHz]	Corr. Factor (dB)	Reading Value [dB (uV)]		Emission Level [dB (uV)]		Limit [dB (uV)]		Margin (dB)	
			Q.P.	AV.	Q.P.	AV.	Q.P.	AV.	Q.P.	AV.
1	0.150	0.10	41.88	-	41.98	-	66.00	56.00	-24.02	-
2	0.224	0.10	36.27	-	36.37	-	62.66	52.66	-26.29	-
3	0.576	0.13	21.86	-	21.99	-	56.00	46.00	-34.01	-
4	2.012	0.20	29.41	-	29.61	-	56.00	46.00	-26.39	-
5	9.980	0.46	35.98	-	36.44	-	60.00	50.00	-23.56	-
6	15.371	0.64	29.68	-	30.32	-	60.00	50.00	-29.68	-

- REMARKS:**
1. Q.P. and AV. are abbreviations of quasi-peak and average individually.
  2. "-": The Quasi-peak reading value also meets average limit and measurement with the average detector is unnecessary.
  3. The emission levels of other frequencies were very low against the limit.
  4. Margin value = Emission level - Limit value
  5. Correction factor = Insertion loss + Cable loss
  6. Emission Level = Correction Factor + Reading Value.

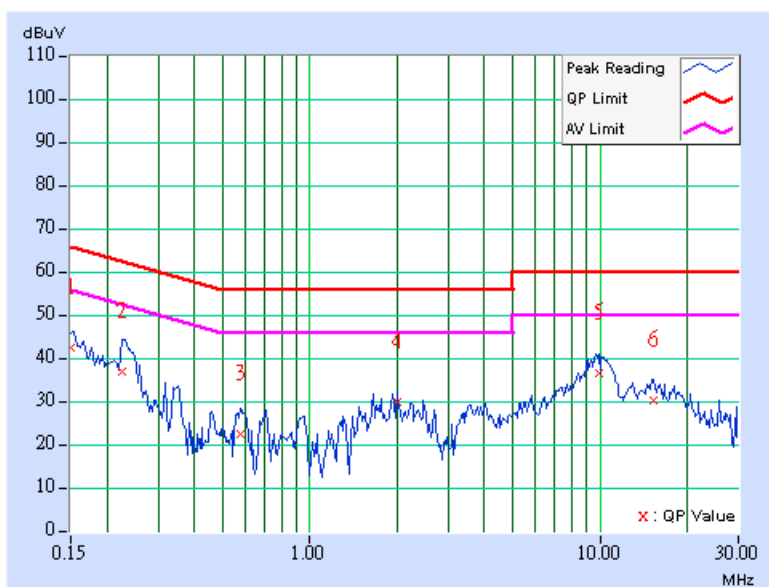

EUT TEST CONDITION		MEASUREMENT DETAIL	
CHANNEL	Channel 11	PHASE	Line 2
MODULATION TYPE	BPSK	6dB BANDWIDTH	9 kHz
TRANSFER RATE	6Mbps	INPUT POWER (SYSTEM)	120Vac, 60 Hz
ENVIRONMENTAL CONDITIONS	23deg. C, 60%RH, 991hPa	TESTED BY	Match Tsui

No	Freq. [MHz]	Corr. Factor (dB)	Reading Value [dB (uV)]		Emission Level [dB (uV)]		Limit [dB (uV)]		Margin (dB)	
			Q.P.	AV.	Q.P.	AV.	Q.P.	AV.	Q.P.	AV.
1	0.150	0.10	42.16	-	42.26	-	66.00	56.00	-23.74	-
2	0.228	0.10	36.85	-	36.95	-	62.52	52.52	-25.57	-
3	0.353	0.10	30.85	-	30.95	-	58.89	48.89	-27.94	-
4	1.488	0.15	24.53	-	24.68	-	56.00	46.00	-31.32	-
5	2.195	0.22	26.10	-	26.32	-	56.00	46.00	-29.68	-
6	10.402	0.47	36.76	-	37.23	-	60.00	50.00	-22.77	-

- REMARKS:**
1. Q.P. and AV. are abbreviations of quasi-peak and average individually.
  2. "-": The Quasi-peak reading value also meets average limit and measurement with the average detector is unnecessary.
  3. The emission levels of other frequencies were very low against the limit.
  4. Margin value = Emission level - Limit value
  5. Correction factor = Insertion loss + Cable loss
  6. Emission Level = Correction Factor + Reading Value.

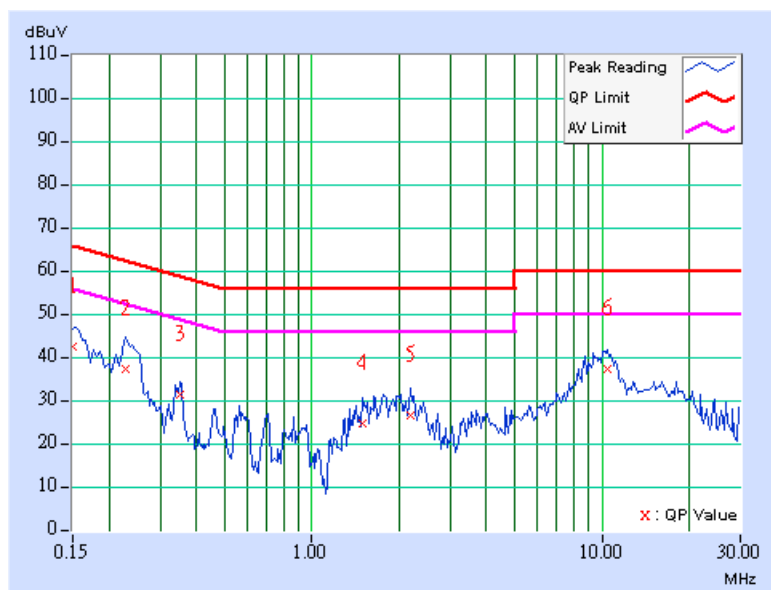

**DRAFT 802.11n (20MHz) OFDM MODULATION: DUAL TX:**

EUT TEST CONDITION		MEASUREMENT DETAIL	
CHANNEL	Channel 1	PHASE	Line 1
MODULATION TYPE	BPSK	6dB BANDWIDTH	9 kHz
TRANSFER RATE	13Mbps	INPUT POWER (SYSTEM)	120Vac, 60 Hz
ENVIRONMENTAL CONDITIONS	20deg. C, 60%RH, 991hPa	TESTED BY	Match Tsui

No	Freq. [MHz]	Corr. Factor (dB)	Reading Value [dB (uV)]		Emission Level [dB (uV)]		Limit [dB (uV)]		Margin (dB)	
			Q.P.	AV.	Q.P.	AV.	Q.P.	AV.	Q.P.	AV.
1	0.150	0.10	40.51	-	40.61	-	66.00	56.00	-25.39	-
2	0.224	0.10	35.34	-	35.44	-	62.66	52.66	-27.22	-
3	0.357	0.10	28.66	-	28.76	-	58.80	48.80	-30.04	-
4	1.656	0.20	30.75	-	30.95	-	56.00	46.00	-25.05	-
5	2.270	0.24	28.73	-	28.97	-	56.00	46.00	-27.03	-
6	10.023	0.46	36.54	-	37.00	-	60.00	50.00	-23.00	-

- REMARKS:**
1. Q.P. and AV. are abbreviations of quasi-peak and average individually.
  2. "-": The Quasi-peak reading value also meets average limit and measurement with the average detector is unnecessary.
  3. The emission levels of other frequencies were very low against the limit.
  4. Margin value = Emission level - Limit value
  5. Correction factor = Insertion loss + Cable loss
  6. Emission Level = Correction Factor + Reading Value.

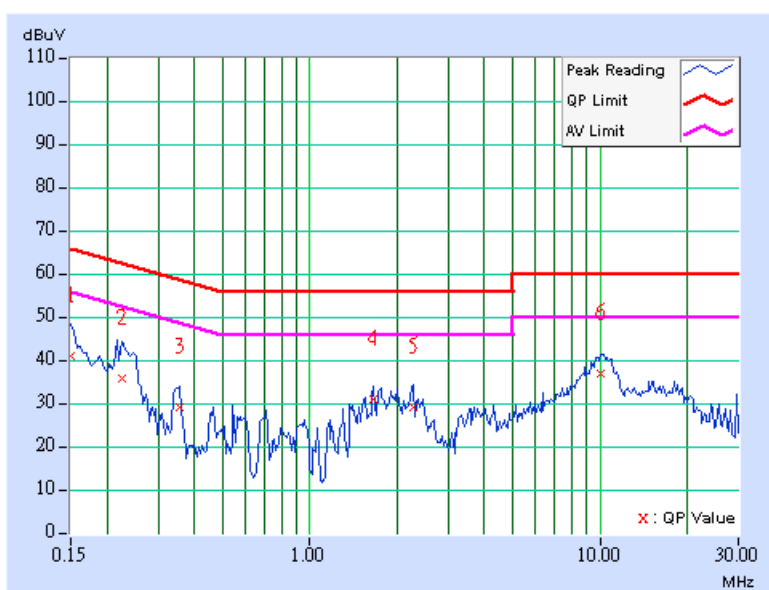

EUT TEST CONDITION		MEASUREMENT DETAIL	
CHANNEL	Channel 1	PHASE	Line 2
MODULATION TYPE	BPSK	6dB BANDWIDTH	9 kHz
TRANSFER RATE	13Mbps	INPUT POWER (SYSTEM)	120Vac, 60 Hz
ENVIRONMENTAL CONDITIONS	20deg. C, 60%RH, 991hPa	TESTED BY	Match Tsui

No	Freq.	Corr.	Reading Value		Emission Level		Limit		Margin	
	[MHz]	(dB)	[dB (uV)]		[dB (uV)]		[dB (uV)]		(dB)	
			Q.P.	AV.	Q.P.	AV.	Q.P.	AV.	Q.P.	AV.
1	0.150	0.10	44.85	-	44.95	-	66.00	56.00	-21.05	-
2	0.249	0.10	38.21	-	38.31	-	61.81	51.81	-23.50	-
3	0.353	0.10	31.75	-	31.85	-	58.89	48.89	-27.04	-
4	0.709	0.10	25.36	-	25.46	-	56.00	46.00	-30.54	-
5	1.746	0.17	28.55	-	28.72	-	56.00	46.00	-27.28	-
6	10.602	0.47	36.12	-	36.59	-	60.00	50.00	-23.41	-

- REMARKS:**
1. Q.P. and AV. are abbreviations of quasi-peak and average individually.
  2. "-": The Quasi-peak reading value also meets average limit and measurement with the average detector is unnecessary.
  3. The emission levels of other frequencies were very low against the limit.
  4. Margin value = Emission level - Limit value
  5. Correction factor = Insertion loss + Cable loss
  6. Emission Level = Correction Factor + Reading Value.

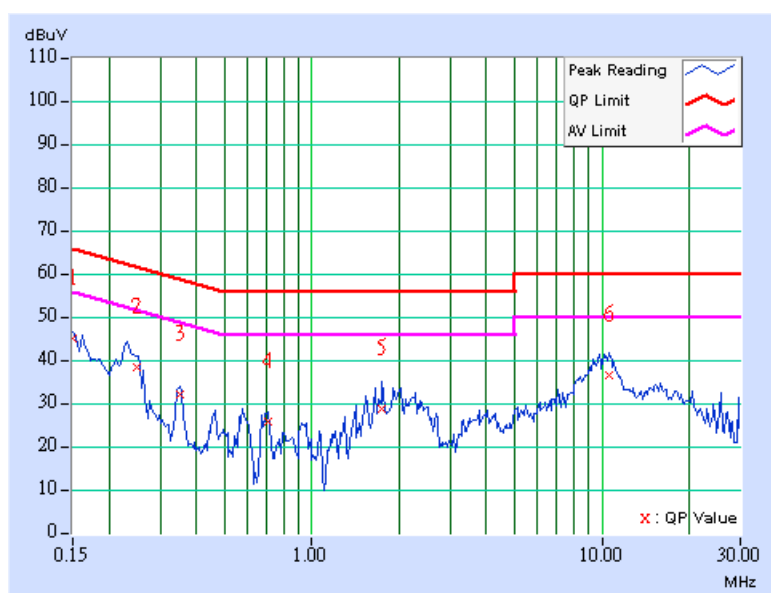

EUT TEST CONDITION		MEASUREMENT DETAIL	
CHANNEL	Channel 6	PHASE	Line 1
MODULATION TYPE	BPSK	6dB BANDWIDTH	9 kHz
TRANSFER RATE	13Mbps	INPUT POWER (SYSTEM)	120Vac, 60 Hz
ENVIRONMENTAL CONDITIONS	20deg. C, 60%RH, 991hPa	TESTED BY	Match Tsui

No	Freq. [MHz]	Corr. Factor (dB)	Reading Value [dB (uV)]		Emission Level [dB (uV)]		Limit [dB (uV)]		Margin (dB)	
			Q.P.	AV.	Q.P.	AV.	Q.P.	AV.	Q.P.	AV.
			1	0.150	0.10	42.28	-	42.38	-	66.00
2	0.232	0.10	38.46	-	38.56	-	62.38	52.38	-23.82	-
3	0.353	0.10	31.59	-	31.69	-	58.89	48.89	-27.20	-
4	1.746	0.20	26.29	-	26.49	-	56.00	46.00	-29.51	-
5	2.258	0.23	27.78	-	28.01	-	56.00	46.00	-27.99	-
6	10.090	0.46	35.98	-	36.44	-	60.00	50.00	-23.56	-

- REMARKS:**
1. Q.P. and AV. are abbreviations of quasi-peak and average individually.
  2. "-": The Quasi-peak reading value also meets average limit and measurement with the average detector is unnecessary.
  3. The emission levels of other frequencies were very low against the limit.
  4. Margin value = Emission level - Limit value
  5. Correction factor = Insertion loss + Cable loss
  6. Emission Level = Correction Factor + Reading Value.

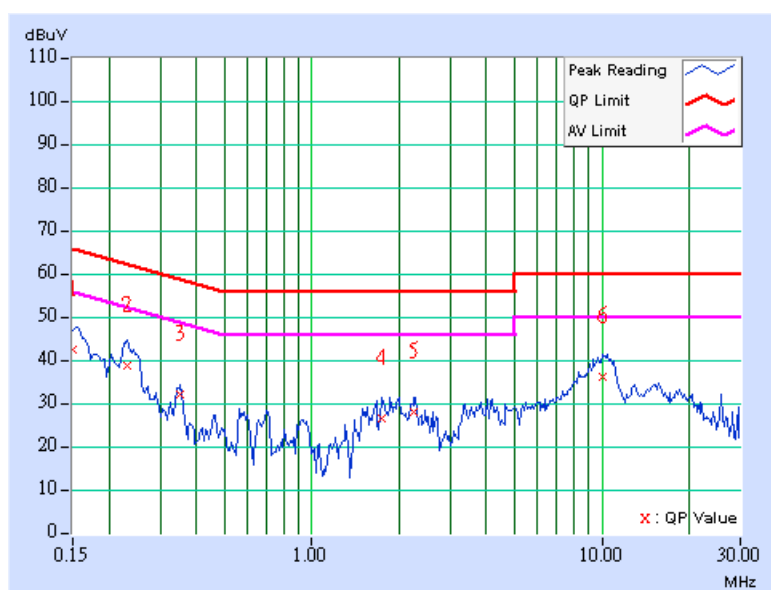

EUT TEST CONDITION		MEASUREMENT DETAIL	
CHANNEL	Channel 6	PHASE	Line 2
MODULATION TYPE	BPSK	6dB BANDWIDTH	9 kHz
TRANSFER RATE	13Mbps	INPUT POWER (SYSTEM)	120Vac, 60 Hz
ENVIRONMENTAL CONDITIONS	20deg. C, 60%RH, 991hPa	TESTED BY	Match Tsui

No	Freq. [MHz]	Corr. Factor (dB)	Reading Value [dB (uV)]		Emission Level [dB (uV)]		Limit [dB (uV)]		Margin (dB)	
			Q.P.	AV.	Q.P.	AV.	Q.P.	AV.	Q.P.	AV.
			1	0.150	0.10	41.86	-	41.96	-	66.00
2	0.232	0.10	37.75	-	37.85	-	62.38	52.38	-24.53	-
3	0.353	0.10	30.91	-	31.01	-	58.89	48.89	-27.88	-
4	1.520	0.15	26.09	-	26.24	-	56.00	46.00	-29.76	-
5	2.008	0.20	30.65	-	30.85	-	56.00	46.00	-25.15	-
6	10.047	0.46	36.68	-	37.14	-	60.00	50.00	-22.86	-

- REMARKS:**
1. Q.P. and AV. are abbreviations of quasi-peak and average individually.
  2. "-": The Quasi-peak reading value also meets average limit and measurement with the average detector is unnecessary.
  3. The emission levels of other frequencies were very low against the limit.
  4. Margin value = Emission level - Limit value
  5. Correction factor = Insertion loss + Cable loss
  6. Emission Level = Correction Factor + Reading Value.

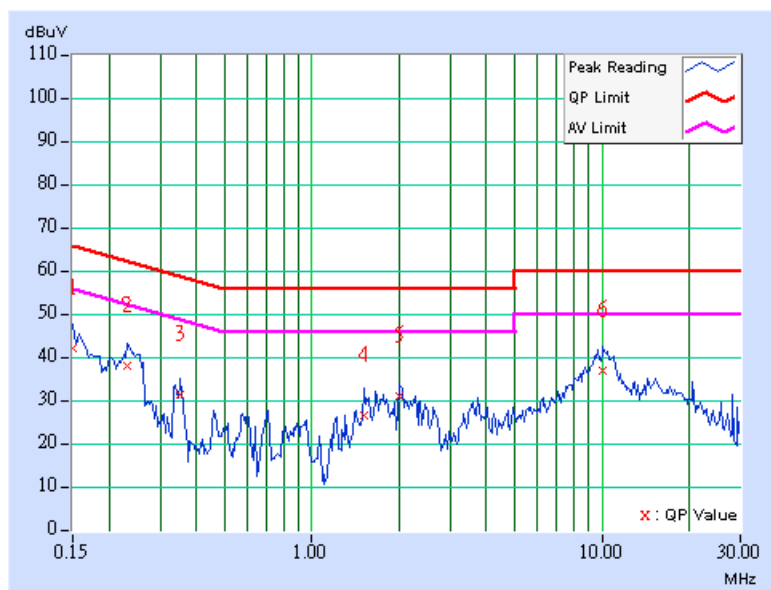



EUT TEST CONDITION		MEASUREMENT DETAIL	
CHANNEL	Channel 11	PHASE	Line 1
MODULATION TYPE	BPSK	6dB BANDWIDTH	9 kHz
TRANSFER RATE	13Mbps	INPUT POWER (SYSTEM)	120Vac, 60 Hz
ENVIRONMENTAL CONDITIONS	20deg. C, 60%RH, 991hPa	TESTED BY	Match Tsui

No	Freq. [MHz]	Corr. Factor (dB)	Reading Value [dB (uV)]		Emission Level [dB (uV)]		Limit [dB (uV)]		Margin (dB)	
			Q.P.	AV.	Q.P.	AV.	Q.P.	AV.	Q.P.	AV.
1	0.154	0.10	47.09	-	47.19	-	65.79	55.79	-18.60	-
2	0.255	0.10	38.62	-	38.72	-	61.58	51.58	-22.86	-
3	0.361	0.10	31.15	-	31.25	-	58.71	48.71	-27.46	-
4	1.691	0.20	28.65	-	28.85	-	56.00	46.00	-27.15	-
5	9.980	0.46	37.23	-	37.69	-	60.00	50.00	-22.31	-
6	15.617	0.65	30.19	-	30.84	-	60.00	50.00	-29.16	-

- REMARKS:**
1. Q.P. and AV. are abbreviations of quasi-peak and average individually.
  2. "-": The Quasi-peak reading value also meets average limit and measurement with the average detector is unnecessary.
  3. The emission levels of other frequencies were very low against the limit.
  4. Margin value = Emission level - Limit value
  5. Correction factor = Insertion loss + Cable loss
  6. Emission Level = Correction Factor + Reading Value.

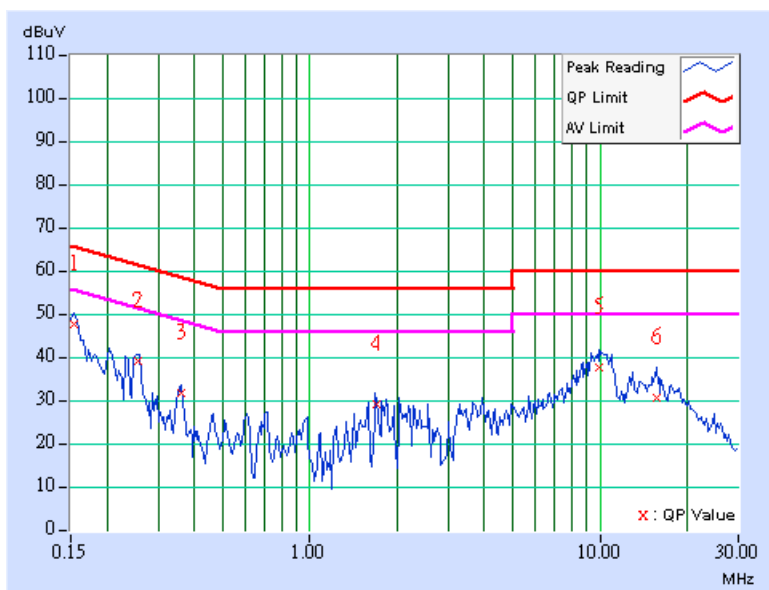

EUT TEST CONDITION		MEASUREMENT DETAIL	
CHANNEL	Channel 11	PHASE	Line 2
MODULATION TYPE	BPSK	6dB BANDWIDTH	9 kHz
TRANSFER RATE	13Mbps	INPUT POWER (SYSTEM)	120Vac, 60 Hz
ENVIRONMENTAL CONDITIONS	20deg. C, 60%RH, 991hPa	TESTED BY	Match Tsui

No	Freq. [MHz]	Corr. Factor (dB)	Reading Value [dB (uV)]		Emission Level [dB (uV)]		Limit [dB (uV)]		Margin (dB)	
			Q.P.	AV.	Q.P.	AV.	Q.P.	AV.	Q.P.	AV.
1	0.150	0.10	45.49	-	45.59	-	66.00	56.00	-20.41	-
2	0.255	0.10	38.50	-	38.60	-	61.60	51.60	-23.00	-
3	0.357	0.10	31.43	-	31.53	-	58.80	48.80	-27.27	-
4	0.717	0.10	24.21	-	24.31	-	56.00	46.00	-31.69	-
5	1.686	0.17	30.23	-	30.40	-	56.00	46.00	-25.60	-
6	10.727	0.47	36.56	-	37.03	-	60.00	50.00	-22.97	-

- REMARKS:**
1. Q.P. and AV. are abbreviations of quasi-peak and average individually.
  2. "-": The Quasi-peak reading value also meets average limit and measurement with the average detector is unnecessary.
  3. The emission levels of other frequencies were very low against the limit.
  4. Margin value = Emission level - Limit value
  5. Correction factor = Insertion loss + Cable loss
  6. Emission Level = Correction Factor + Reading Value.

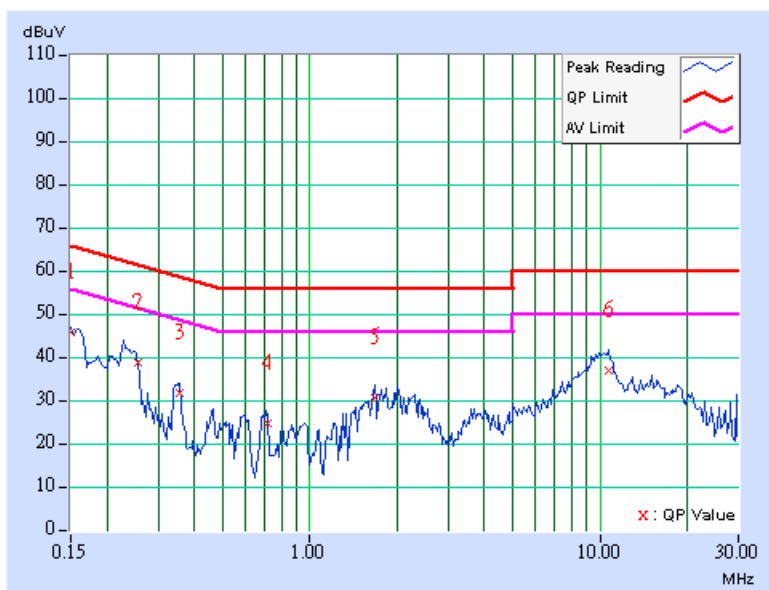

**DRAFT 802.11n (40MHz) OFDM MODULATION: DUAL TX:**

EUT TEST CONDITION		MEASUREMENT DETAIL	
CHANNEL	Channel 1	PHASE	Line 1
MODULATION TYPE	BPSK	6dB BANDWIDTH	9 kHz
TRANSFER RATE	27Mbps	INPUT POWER (SYSTEM)	120Vac, 60 Hz
ENVIRONMENTAL CONDITIONS	20deg. C, 60%RH, 991hPa	TESTED BY	Match Tsui

No	Freq. [MHz]	Corr. Factor (dB)	Reading Value [dB (uV)]		Emission Level [dB (uV)]		Limit [dB (uV)]		Margin (dB)	
			Q.P.	AV.	Q.P.	AV.	Q.P.	AV.	Q.P.	AV.
1	0.150	0.10	46.60	-	46.70	-	66.00	56.00	-19.30	-
2	0.255	0.10	38.64	-	38.74	-	61.58	51.58	-22.84	-
3	0.357	0.10	31.33	-	31.43	-	58.80	48.80	-27.37	-
4	0.713	0.15	24.54	-	24.69	-	56.00	46.00	-31.31	-
5	1.946	0.20	27.85	-	28.05	-	56.00	46.00	-27.95	-
6	10.238	0.47	36.45	-	36.92	-	60.00	50.00	-23.08	-

- REMARKS:**
1. Q.P. and AV. are abbreviations of quasi-peak and average individually.
  2. "-": The Quasi-peak reading value also meets average limit and measurement with the average detector is unnecessary.
  3. The emission levels of other frequencies were very low against the limit.
  4. Margin value = Emission level - Limit value
  5. Correction factor = Insertion loss + Cable loss
  6. Emission Level = Correction Factor + Reading Value.

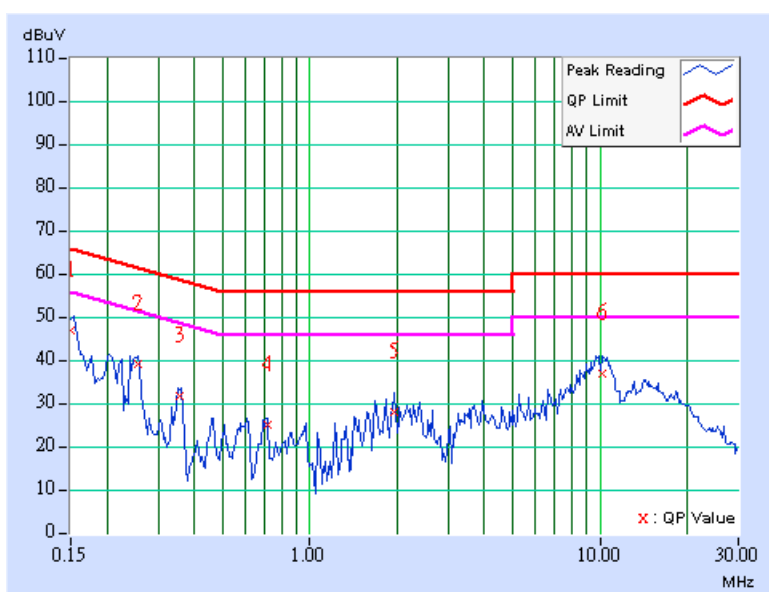

EUT TEST CONDITION		MEASUREMENT DETAIL	
CHANNEL	Channel 1	PHASE	Line 2
MODULATION TYPE	BPSK	6dB BANDWIDTH	9 kHz
TRANSFER RATE	27Mbps	INPUT POWER (SYSTEM)	120Vac, 60 Hz
ENVIRONMENTAL CONDITIONS	20deg. C, 60%RH, 991hPa	TESTED BY	Match Tsui

No	Freq. [MHz]	Corr. Factor (dB)	Reading Value [dB (uV)]		Emission Level [dB (uV)]		Limit [dB (uV)]		Margin (dB)	
			Q.P.	AV.	Q.P.	AV.	Q.P.	AV.	Q.P.	AV.
			1	0.150	0.10	45.73	-	45.83	-	66.00
2	0.252	0.10	38.68	-	38.78	-	61.71	51.71	-22.93	-
3	0.361	0.10	29.94	-	30.04	-	58.71	48.71	-28.67	-
4	1.680	0.17	30.74	-	30.91	-	56.00	46.00	-25.09	-
5	10.285	0.46	37.91	-	38.37	-	60.00	50.00	-21.63	-
6	15.355	0.54	30.44	-	30.98	-	60.00	50.00	-29.02	-

- REMARKS:**
1. Q.P. and AV. are abbreviations of quasi-peak and average individually.
  2. "-": The Quasi-peak reading value also meets average limit and measurement with the average detector is unnecessary.
  3. The emission levels of other frequencies were very low against the limit.
  4. Margin value = Emission level - Limit value
  5. Correction factor = Insertion loss + Cable loss
  6. Emission Level = Correction Factor + Reading Value.

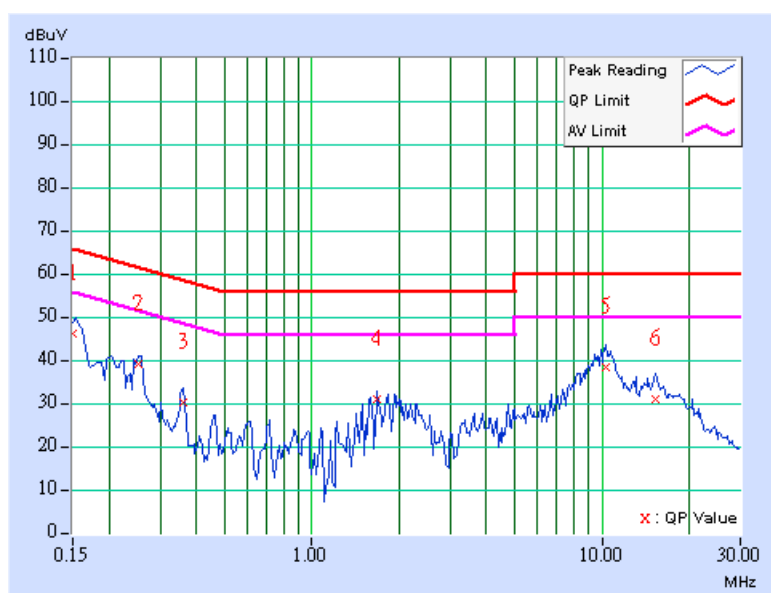

EUT TEST CONDITION		MEASUREMENT DETAIL	
CHANNEL	Channel 4	PHASE	Line 1
MODULATION TYPE	BPSK	6dB BANDWIDTH	9 kHz
TRANSFER RATE	27Mbps	INPUT POWER (SYSTEM)	120Vac, 60 Hz
ENVIRONMENTAL CONDITIONS	20deg. C, 60%RH, 991hPa	TESTED BY	Match Tsui

No	Freq. [MHz]	Corr. Factor (dB)	Reading Value [dB (uV)]		Emission Level [dB (uV)]		Limit [dB (uV)]		Margin (dB)	
			Q.P.	AV.	Q.P.	AV.	Q.P.	AV.	Q.P.	AV.
			1	0.150	0.10	46.66	-	46.76	-	66.00
2	0.255	0.10	38.64	-	38.74	-	61.58	51.58	-22.84	-
3	0.357	0.10	31.35	-	31.45	-	58.80	48.80	-27.35	-
4	1.930	0.20	29.41	-	29.61	-	56.00	46.00	-26.39	-
5	9.711	0.46	35.53	-	35.99	-	60.00	50.00	-24.01	-
6	15.695	0.66	29.78	-	30.44	-	60.00	50.00	-29.56	-

- REMARKS:**
1. Q.P. and AV. are abbreviations of quasi-peak and average individually.
  2. "-": The Quasi-peak reading value also meets average limit and measurement with the average detector is unnecessary.
  3. The emission levels of other frequencies were very low against the limit.
  4. Margin value = Emission level - Limit value
  5. Correction factor = Insertion loss + Cable loss
  6. Emission Level = Correction Factor + Reading Value.

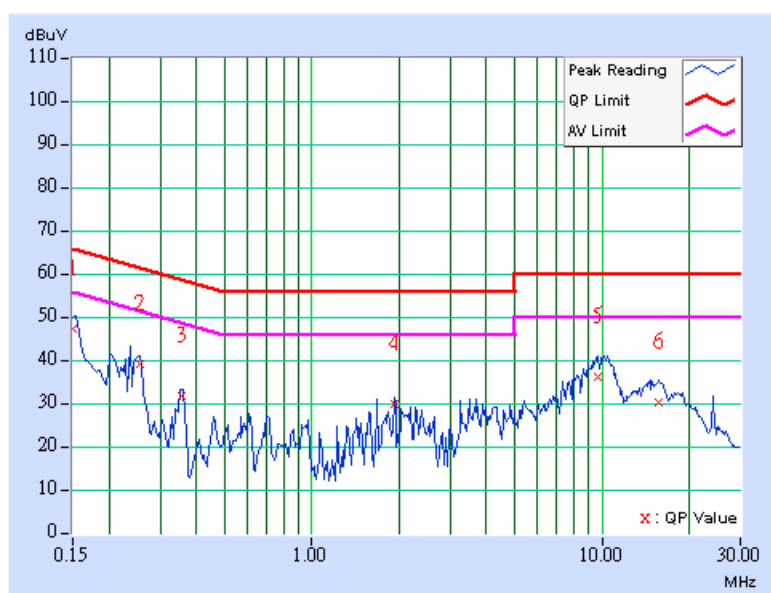

EUT TEST CONDITION		MEASUREMENT DETAIL	
CHANNEL	Channel 4	PHASE	Line 2
MODULATION TYPE	BPSK	6dB BANDWIDTH	9 kHz
TRANSFER RATE	27Mbps	INPUT POWER (SYSTEM)	120Vac, 60 Hz
ENVIRONMENTAL CONDITIONS	20deg. C, 60%RH, 991hPa	TESTED BY	Match Tsui

No	Freq. [MHz]	Corr. Factor (dB)	Reading Value [dB (uV)]		Emission Level [dB (uV)]		Limit [dB (uV)]		Margin (dB)	
			Q.P.	AV.	Q.P.	AV.	Q.P.	AV.	Q.P.	AV.
			1	0.150	0.10	45.98	-	46.08	-	66.00
2	0.252	0.10	38.70	-	38.80	-	61.71	51.71	-22.91	-
3	0.357	0.10	31.47	-	31.57	-	58.80	48.80	-27.23	-
4	1.684	0.17	30.01	-	30.18	-	56.00	46.00	-25.82	-
5	2.035	0.20	29.48	-	29.68	-	56.00	46.00	-26.32	-
6	10.531	0.47	36.91	-	37.38	-	60.00	50.00	-22.62	-

- REMARKS:**
1. Q.P. and AV. are abbreviations of quasi-peak and average individually.
  2. "-": The Quasi-peak reading value also meets average limit and measurement with the average detector is unnecessary.
  3. The emission levels of other frequencies were very low against the limit.
  4. Margin value = Emission level - Limit value
  5. Correction factor = Insertion loss + Cable loss
  6. Emission Level = Correction Factor + Reading Value.

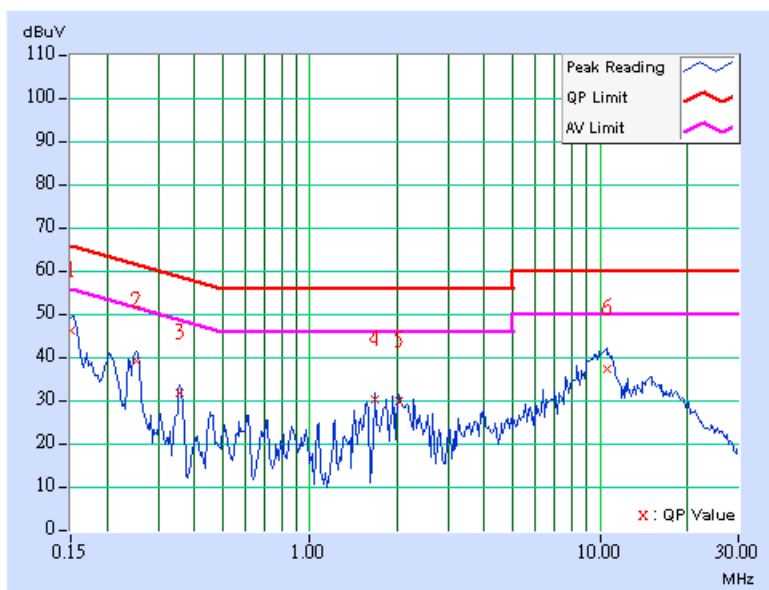

EUT TEST CONDITION		MEASUREMENT DETAIL	
CHANNEL	Channel 7	PHASE	Line 1
MODULATION TYPE	BPSK	6dB BANDWIDTH	9 kHz
TRANSFER RATE	27Mbps	INPUT POWER (SYSTEM)	120Vac, 60 Hz
ENVIRONMENTAL CONDITIONS	20deg. C, 60%RH, 991hPa	TESTED BY	Match Tsui

No	Freq. [MHz]	Corr. Factor (dB)	Reading Value [dB (uV)]		Emission Level [dB (uV)]		Limit [dB (uV)]		Margin (dB)	
			Q.P.	AV.	Q.P.	AV.	Q.P.	AV.	Q.P.	AV.
1	0.150	0.10	46.70	-	46.80	-	66.00	56.00	-19.20	-
2	0.255	0.10	38.82	-	38.92	-	61.58	51.58	-22.66	-
3	0.357	0.10	31.29	-	31.39	-	58.80	48.80	-27.41	-
4	0.607	0.13	24.24	-	24.37	-	56.00	46.00	-31.63	-
5	1.944	0.20	27.93	-	28.13	-	56.00	46.00	-27.87	-
6	10.727	0.48	33.94	-	34.42	-	60.00	50.00	-25.58	-

- REMARKS:**
1. Q.P. and AV. are abbreviations of quasi-peak and average individually.
  2. "-": The Quasi-peak reading value also meets average limit and measurement with the average detector is unnecessary.
  3. The emission levels of other frequencies were very low against the limit.
  4. Margin value = Emission level - Limit value
  5. Correction factor = Insertion loss + Cable loss
  6. Emission Level = Correction Factor + Reading Value.

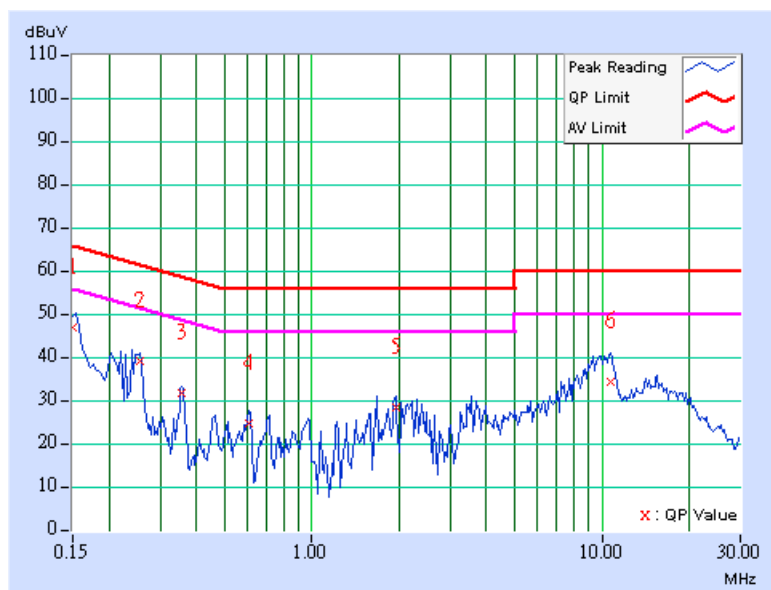

EUT TEST CONDITION		MEASUREMENT DETAIL	
CHANNEL	Channel 7	PHASE	Line 2
MODULATION TYPE	BPSK	6dB BANDWIDTH	9 kHz
TRANSFER RATE	27Mbps	INPUT POWER (SYSTEM)	120Vac, 60 Hz
ENVIRONMENTAL CONDITIONS	20deg. C, 60%RH, 991hPa	TESTED BY	Match Tsui

No	Freq. [MHz]	Corr. Factor (dB)	Reading Value [dB (uV)]		Emission Level [dB (uV)]		Limit [dB (uV)]		Margin (dB)	
			Q.P.	AV.	Q.P.	AV.	Q.P.	AV.	Q.P.	AV.
			1	0.150	0.10	45.98	-	46.08	-	66.00
2	0.252	0.10	38.76	-	38.86	-	61.71	51.71	-22.85	-
3	0.357	0.10	31.51	-	31.61	-	58.80	48.80	-27.19	-
4	0.603	0.10	21.93	-	22.03	-	56.00	46.00	-33.97	-
5	2.035	0.20	29.18	-	29.38	-	56.00	46.00	-26.62	-
6	10.547	0.47	36.47	-	36.94	-	60.00	50.00	-23.06	-

- REMARKS:**
1. Q.P. and AV. are abbreviations of quasi-peak and average individually.
  2. "-": The Quasi-peak reading value also meets average limit and measurement with the average detector is unnecessary.
  3. The emission levels of other frequencies were very low against the limit.
  4. Margin value = Emission level - Limit value
  5. Correction factor = Insertion loss + Cable loss
  6. Emission Level = Correction Factor + Reading Value.

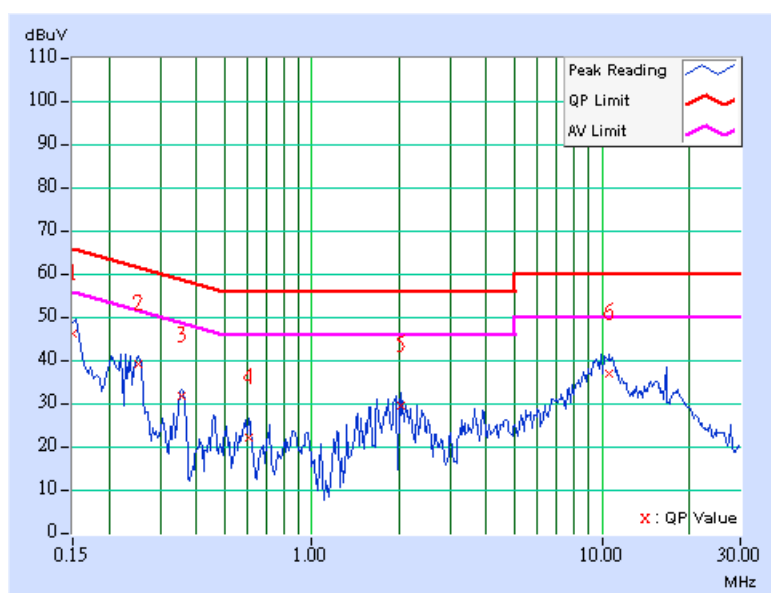



## 4.2 RADIATED EMISSION MEASUREMENT

### 4.2.1 LIMITS OF RADIATED EMISSION MEASUREMENT

Emissions radiated outside of the specified bands, shall be according to the general radiated limits in 15.209 as following:

FREQUENCIES (MHz)	FIELD STRENGTH (microvolts/meter)	MEASUREMENT DISTANCE (meters)
0.009 ~ 0.490	2400 / F(kHz)	300
0.490 ~ 1.705	24000 / F(kHz)	30
1.705 ~ 30.0	30	30
30 ~ 88	100	3
88 ~ 216	150	3
216 ~ 960	200	3
Above 960	500	3

**NOTE:**

1. The lower limit shall apply at the transition frequencies.
2. Emission level (dBuV/m) = 20 log Emission level (uV/m).
3. As shown in 15.35(b), for frequencies above 1000MHz, the field strength limits are based on average detector, however, the peak field strength of any emission shall not exceed the maximum permitted average limits, specified above by more than 20dB under any condition of modulation.



#### 4.2.2 TEST INSTRUMENTS

DESCRIPTION & MANUFACTURER	MODEL NO.	SERIAL NO.	CALIBRATED UNTIL
Test Receiver ROHDE & SCHWARZ	ESI7	100033	May. 19, 2006
Spectrum Analyzer ROHDE & SCHWARZ	FSP40	100025	Dec. 05, 2006
BILOG Antenna SCHWARZBECK	VULB9168	9168-160	Jun. 01, 2006
HORN Antenna SCHWARZBECK	9120D	9120D-408	Jan. 08, 2007
HORN Antenna SCHWARZBECK	BBHA 9170	BBHA9170243	Jan. 19, 2007
Preamplifier Agilent	8447D	2944A10633	Nov. 04, 2006
Preamplifier Agilent	8449B	3008A01964	Oct. 30, 2006
RF signal cable HUBER+SUHNNER	SUCOFLEX 104	214377/4	Dec. 13, 2006
RF signal cable HUBER+SUHNNER	SUCOFLEX 104	219272/4	Dec. 13, 2006
Software ADT.	ADT_Radiated_V5.14	NA	NA
Antenna Tower inn-co GmbH	MA 4000	013303	NA
Antenna Tower Controller inn-co GmbH	CO2000	017303	NA
Turn Table ADT.	TT100.	TT93021703	NA
Turn Table Controller ADT.	SC100.	SC93021703	NA

- NOTE:**
1. The calibration interval of the above test instruments is 12 months and the calibrations are traceable to NML/ROC and NIST/USA.
  2. The test was performed in HwaYa Chamber 2.
  3. The horn antenna and HP preamplifier (model: 8449B) are used only for the measurement of emission frequency above 1GHz if tested.
  4. The VCCI Site Registration No. is R-237.
  5. The IC Site Registration No. is IC4924-3.

#### 4.2.3 TEST PROCEDURES

- a. The EUT was placed on the top of a rotating table 0.8 meters above the ground at a 3 meters semi-anechoic chamber. The table was rotated 360 degrees to determine the position of the highest radiation.
- b. The EUT was set 3 meters away from the interference-receiving antenna, which was mounted on the top of a variable-height antenna tower.
- c. The antenna is a broadband antenna, and its height is varied from one meter to four meters above the ground to determine the maximum value of the field strength. Both horizontal and vertical polarizations of the antenna are set to make the measurement.
- d. For each suspected emission, the EUT was arranged to its worst case and then the antenna was tuned to heights from 1 meter to 4 meters and the rotatable table was turned from 0 degrees to 360 degrees to find the maximum reading.
- e. The test-receiver system was set to Peak Detect Function and Specified Bandwidth with Maximum Hold Mode.
- f. If the emission level of the EUT in peak mode was lower than the limit specified, then testing could be stopped and the peak values of the EUT would be reported. Otherwise the emissions would be re-tested one by one using peak, quasi-peak or average method as specified and then reported in a data sheet.

**NOTE:**

1. The resolution bandwidth and video bandwidth of test receiver/spectrum analyzer is 120kHz for Peak detection (PK) and Quasi-peak detection (QP) at frequency below 1GHz.
2. The resolution bandwidth and video bandwidth of test receiver/spectrum analyzer is 1 MHz for Peak detection at frequency above 1GHz.
3. The resolution bandwidth of test receiver/spectrum analyzer is 1MHz and the video bandwidth is 100Hz for Average detection (AV) at frequency above 1GHz.

#### 4.2.4 DEVIATION FROM TEST STANDARD

No deviation

#### 4.2.5 TEST SETUP

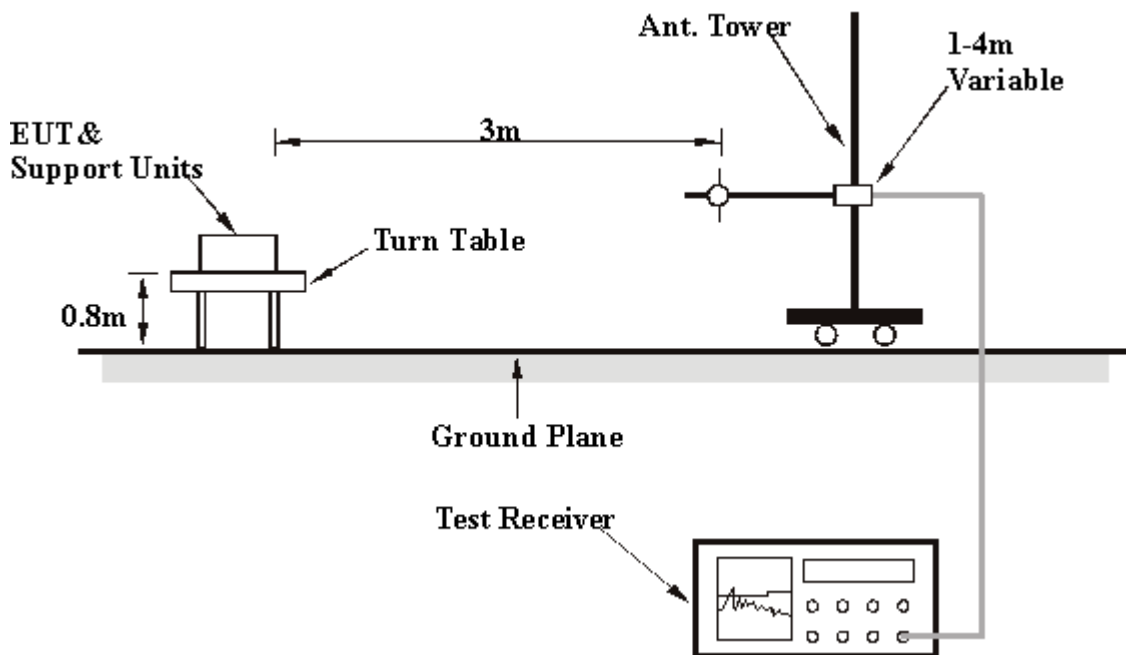

For the actual test configuration, please refer to the related item – Photographs of the Test Configuration.

#### 4.2.6 EUT OPERATING CONDITIONS

Same as 4.1.6

## 4.2.7 TEST RESULTS

### BELOW 1GHz WORST-CASE DATA

#### 802.11g OFDM MODULATION:

EUT TEST CONDITION		MEASUREMENT DETAIL	
CHANNEL	Channel 1	FREQUENCY RANGE	Below 1000MHz
MODULATION TYPE	BPSK for 802.11g	INPUT POWER (SYSTEM)	120Vac, 60 Hz
TRANSFER RATE	6Mbps	DETECTOR FUNCTION	Quasi-Peak
ENVIRONMENTAL CONDITIONS	25deg. C, 68%RH, 991hPa	TESTED BY	Long Chen

ANTENNA POLARITY & TEST DISTANCE: HORIZONTAL AT 3 M								
No.	Freq. (MHz)	Emission Level (dBuV/m)	Limit (dBuV/m)	Margin (dB)	Antenna Height (m)	Table Angle (Degree)	Raw Value (dBuV)	Correction Factor (dB/m)
1	199.12	26.91 QP	43.50	-16.59	1.50 H	139	15.70	11.21
2	265.21	36.68 QP	46.00	-9.32	1.00 H	349	23.17	13.51
3	331.30	38.77 QP	46.00	-7.23	1.00 H	22	22.38	16.38
4	463.49	27.05 QP	46.00	-18.95	1.00 H	244	7.52	19.53
5	601.50	25.64 QP	46.00	-20.36	1.50 H	163	2.48	23.16
6	720.08	28.57 QP	46.00	-17.43	1.00 H	88	3.47	25.10

ANTENNA POLARITY & TEST DISTANCE: VERTICAL AT 3 M								
No.	Freq. (MHz)	Emission Level (dBuV/m)	Limit (dBuV/m)	Margin (dB)	Antenna Height (m)	Table Angle (Degree)	Raw Value (dBuV)	Correction Factor (dB/m)
1	131.08	27.90 QP	43.50	-15.60	1.00 V	25	15.58	12.32
2	199.12	28.72 QP	43.50	-14.78	1.00 V	91	17.51	11.21
3	232.16	29.22 QP	46.00	-16.78	1.00 V	121	17.08	12.13
4	298.26	27.30 QP	46.00	-18.70	1.00 V	109	11.50	15.80
5	333.25	29.60 QP	46.00	-16.40	1.00 V	115	13.18	16.42
6	861.98	30.44 QP	46.00	-15.56	1.00 V	139	3.21	27.24

- REMARKS:**
1. Emission level(dBuV/m)=Raw Value(dBuV) + Correction Factor(dB/m)
  2. Correction Factor(dB/m) = Antenna Factor (dB/m) + Cable Factor (dB)
  3. The other emission levels were very low against the limit.
  4. Margin value = Emission level – Limit value.

**DRAFT 802.11n (20MHz) OFDM MODULATION: DUAL TX:**

EUT TEST CONDITION		MEASUREMENT DETAIL	
CHANNEL	Channel 1	FREQUENCY RANGE	Below 1000MHz
MODULATION TYPE	BPSK for draft 802.11n (20MHz)	INPUT POWER (SYSTEM)	120Vac, 60 Hz
TRANSFER RATE	13Mbps	DETECTOR FUNCTION	Quasi-Peak
ENVIRONMENTAL CONDITIONS	25deg. C, 68%RH, 991hPa	TESTED BY	Long Chen

ANTENNA POLARITY & TEST DISTANCE: HORIZONTAL AT 3 M								
No.	Freq. (MHz)	Emission Level (dBuV/m)	Limit (dBuV/m)	Margin (dB)	Antenna Height (m)	Table Angle (Degree)	Raw Value (dBuV)	Correction Factor (dB/m)
1	199.86	30.54 QP	43.50	-12.96	1.25 H	36	19.36	11.18
2	232.87	34.04 QP	46.00	-11.96	1.00 H	154	21.88	12.16
3	265.88	39.30 QP	46.00	-6.70	1.25 H	250	25.67	13.63
4	300.32	34.54 QP	46.00	-11.46	1.25 H	257	18.64	15.90
5	333.95	37.74 QP	46.00	-8.26	1.25 H	58	21.31	16.43
6	467.58	31.36 QP	46.00	-14.64	1.00 H	25	11.73	19.63

ANTENNA POLARITY & TEST DISTANCE: VERTICAL AT 3 M								
No.	Freq. (MHz)	Emission Level (dBuV/m)	Limit (dBuV/m)	Margin (dB)	Antenna Height (m)	Table Angle (Degree)	Raw Value (dBuV)	Correction Factor (dB/m)
1	199.89	35.78 QP	43.50	-7.72	1.00 V	150	24.60	11.18
2	232.16	30.45 QP	46.00	-15.55	2.00 V	121	18.32	12.13
3	333.09	33.58 QP	46.00	-12.42	1.25 V	250	17.17	16.41
4	465.43	29.55 QP	46.00	-16.45	1.00 V	187	9.98	19.58
5	733.69	31.95 QP	46.00	-14.05	1.50 V	244	6.31	25.64
6	955.29	33.92 QP	46.00	-12.08	3.00 V	355	5.58	28.34

- REMARKS:**
1. Emission level(dBuV/m)=Raw Value(dBuV) + Correction Factor(dB/m)
  2. Correction Factor(dB/m) = Antenna Factor (dB/m) + Cable Factor (dB)
  3. The other emission levels were very low against the limit.
  4. Margin value = Emission level – Limit value.

**DRAFT 802.11n (40MHz) OFDM MODULATION: DUAL TX:**

EUT TEST CONDITION		MEASUREMENT DETAIL	
CHANNEL	Channel 1	FREQUENCY RANGE	Below 1000MHz
MODULATION TYPE	BPSK for draft 802.11n (40MHz)	INPUT POWER (SYSTEM)	120Vac, 60 Hz
TRANSFER RATE	27Mbps	DETECTOR FUNCTION	Quasi-Peak
ENVIRONMENTAL CONDITIONS	25deg. C, 68%RH, 991hPa	TESTED BY	Long Chen

ANTENNA POLARITY & TEST DISTANCE: HORIZONTAL AT 3 M								
No.	Freq. (MHz)	Emission Level (dBuV/m)	Limit (dBuV/m)	Margin (dB)	Antenna Height (m)	Table Angle (Degree)	Raw Value (dBuV)	Correction Factor (dB/m)
1	199.12	26.12 QP	43.50	-17.38	1.00 H	172	14.90	11.21
2	232.16	29.17 QP	46.00	-16.83	2.00 H	331	17.03	12.13
3	265.41	35.00 QP	46.00	-11.00	1.25 H	100	21.45	13.55
4	331.41	35.56 QP	46.00	-10.44	1.00 H	36	19.17	16.39
5	411.00	24.50 QP	46.00	-21.50	1.00 H	142	6.01	18.49
6	463.49	30.52 QP	46.00	-15.48	1.50 H	100	10.99	19.53

ANTENNA POLARITY & TEST DISTANCE: VERTICAL AT 3 M								
No.	Freq. (MHz)	Emission Level (dBuV/m)	Limit (dBuV/m)	Margin (dB)	Antenna Height (m)	Table Angle (Degree)	Raw Value (dBuV)	Correction Factor (dB/m)
1	131.08	26.90 QP	43.50	-16.60	1.00 V	349	14.57	12.32
2	164.13	24.70 QP	43.50	-18.80	1.00 V	157	11.24	13.47
3	265.10	34.58 QP	46.00	-11.42	1.50 V	100	21.09	13.49
4	329.84	31.30 QP	46.00	-14.70	1.25 V	25	14.94	16.36
5	601.50	25.26 QP	46.00	-20.74	1.00 V	301	2.10	23.16
6	935.85	30.97 QP	46.00	-15.03	1.00 V	91	2.84	28.12

- REMARKS:**
1. Emission level(dBuV/m)=Raw Value(dBuV) + Correction Factor(dB/m)
  2. Correction Factor(dB/m) = Antenna Factor (dB/m) + Cable Factor (dB)
  3. The other emission levels were very low against the limit.
  4. Margin value = Emission level – Limit value.

### 802.11b DSSS MODULATION:

EUT TEST CONDITION		MEASUREMENT DETAIL	
CHANNEL	Channel 1	FREQUENCY RANGE	1 ~ 25GHz
MODULATION TYPE	DBPSK	INPUT POWER (SYSTEM)	120Vac, 60 Hz
TRANSFER RATE	1Mbps	DETECTOR FUNCTION	Peak(PK) Average (AV)
ENVIRONMENTAL CONDITIONS	22deg. C, 63%RH, 991hPa	TESTED BY	Brad Wu

ANTENNA POLARITY & TEST DISTANCE: HORIZONTAL AT 3 M								
NO.	FREQ. (MHz)	EMISSION LEVEL (dBuV/m)	LIMIT (dBuV/m)	MARGIN (dB)	ANTENNA HEIGHT (m)	TABLE ANGLE (Degree)	RAW VALUE (dBuV)	CORRECTION FACTOR (dB/m)
1	1056.00	48.57 PK	74.00	-25.43	1.04 H	129	20.91	27.66
2	1056.00	46.34 AV	54.00	-7.66	1.04 H	129	18.68	27.66
3	2387.00	62.49 PK	74.00	-11.51	1.33 H	249	30.39	32.10
4	<b>2387.00</b>	<b>52.88 AV</b>	<b>54.00</b>	<b>-1.12</b>	<b>1.33 H</b>	<b>249</b>	<b>20.78</b>	<b>32.10</b>
5	*2412.00	108.58 PK			1.34 H	250	76.39	32.19
6	*2412.00	104.30 AV			1.34 H	250	72.11	32.19
7	4824.00	53.25 PK	74.00	-20.75	1.10 H	357	14.60	38.65
8	4824.00	49.18 AV	54.00	-4.82	1.10 H	357	10.53	38.65

ANTENNA POLARITY & TEST DISTANCE: VERTICAL AT 3 M								
NO.	FREQ. (MHz)	EMISSION LEVEL (dBuV/m)	LIMIT (dBuV/m)	MARGIN (dB)	ANTENNA HEIGHT (m)	TABLE ANGLE (Degree)	RAW VALUE (dBuV)	CORRECTION FACTOR (dB/m)
1	1056.00	45.37 PK	74.00	-28.63	1.12 V	247	17.71	27.66
2	1056.00	43.21 AV	54.00	-10.79	1.12 V	247	15.55	27.66
3	2387.00	49.56 PK	74.00	-24.44	1.11 V	145	17.46	32.10
4	2387.00	45.55 AV	54.00	-8.45	1.11 V	145	13.45	32.10
5	*2412.00	100.98 PK			1.11 V	145	68.79	32.19
6	*2412.00	96.97 AV			1.11 V	145	64.78	32.19
7	4824.00	47.56 PK	74.00	-26.44	1.16 V	311	8.91	38.65
8	4824.00	40.23 AV	54.00	-13.77	1.16 V	311	1.58	38.65

- REMARKS:**
1. Emission level (dBuV/m) = Raw Value (dBuV) + Correction Factor (dB/m).
  2. Correction Factor (dB/m) = Antenna Factor (dB/m) + Cable Factor (dB).
  3. The other emission levels were very low against the limit.
  4. Margin value = Emission level – Limit value.
  5. The limit value is defined as per 15.247.
  6. “ \* “: Fundamental frequency.





EUT TEST CONDITION		MEASUREMENT DETAIL	
CHANNEL	Channel 6	FREQUENCY RANGE	1 ~ 25GHz
MODULATION TYPE	DBPSK	INPUT POWER (SYSTEM)	120Vac, 60 Hz
TRANSFER RATE	1Mbps	DETECTOR FUNCTION	Peak(PK) Average (AV)
ENVIRONMENTAL CONDITIONS	24deg. C, 63%RH, 991hPa	TESTED BY	Brad Wu

ANTENNA POLARITY & TEST DISTANCE: HORIZONTAL AT 3 M								
NO.	FREQ. (MHz)	EMISSION LEVEL (dBuV/m)	LIMIT (dBuV/m)	MARGIN (dB)	ANTENNA HEIGHT (m)	TABLE ANGLE (Degree)	RAW VALUE (dBuV)	CORRECTION FACTOR (dB/m)
1	1056.00	48.68 PK	74.00	-25.32	1.05 H	131	21.02	27.66
2	1056.00	46.47 AV	54.00	-7.53	1.05 H	131	18.81	27.66
3	*2437.00	108.64 PK			1.33 H	248	76.35	32.29
4	*2437.00	104.36 AV			1.33 H	248	72.07	32.29
5	4874.00	53.14 PK	74.00	-20.86	1.07 H	349	14.35	38.79
6	4874.00	49.12 AV	54.00	-4.88	1.07 H	349	10.33	38.79

ANTENNA POLARITY & TEST DISTANCE: VERTICAL AT 3 M								
NO.	FREQ. (MHz)	EMISSION LEVEL (dBuV/m)	LIMIT (dBuV/m)	MARGIN (dB)	ANTENNA HEIGHT (m)	TABLE ANGLE (Degree)	RAW VALUE (dBuV)	CORRECTION FACTOR (dB/m)
1	1056.00	45.68 PK	74.00	-28.32	1.13 V	251	18.02	27.66
2	1056.00	43.52 AV	54.00	-10.48	1.13 V	251	15.86	27.66
3	*2437.00	101.06 PK			1.10 V	147	68.77	32.29
4	*2437.00	97.03 AV			1.10 V	147	64.74	32.29
5	4874.00	47.42 PK	74.00	-26.58	1.12 V	309	8.63	38.79
6	4874.00	40.11 AV	54.00	-13.89	1.12 V	309	1.32	38.79

- REMARKS:**
1. Emission level (dBuV/m) = Raw Value (dBuV) + Correction Factor (dB/m).
  2. Correction Factor (dB/m) = Antenna Factor (dB/m) + Cable Factor (dB).
  3. The other emission levels were very low against the limit.
  4. Margin value = Emission level – Limit value.
  5. The limit value is defined as per 15.247.
  6. “ \* “: Fundamental frequency.



EUT TEST CONDITION		MEASUREMENT DETAIL	
CHANNEL	Channel 11	FREQUENCY RANGE	1 ~ 25GHz
MODULATION TYPE	DBPSK	INPUT POWER (SYSTEM)	120Vac, 60 Hz
TRANSFER RATE	1Mbps	DETECTOR FUNCTION	Peak(PK) Average (AV)
ENVIRONMENTAL CONDITIONS	24deg. C, 63%RH, 991hPa	TESTED BY	Brad Wu

ANTENNA POLARITY & TEST DISTANCE: HORIZONTAL AT 3 M								
NO.	FREQ. (MHz)	EMISSION LEVEL (dBuV/m)	LIMIT (dBuV/m)	MARGIN (dB)	ANTENNA HEIGHT (m)	TABLE ANGLE (Degree)	RAW VALUE (dBuV)	CORRECTION FACTOR (dB/m)
1	1056.00	48.65 PK	74.00	-25.35	1.01 H	134	20.99	27.66
2	1056.00	46.42 AV	54.00	-7.58	1.01 H	134	18.76	27.66
3	*2462.00	108.72 PK			1.28 H	250	76.34	32.38
4	*2462.00	104.56 AV			1.28 H	250	72.18	32.38
5	2483.50	56.55 PK	74.00	-17.45	1.28 H	250	24.09	32.46
6	2483.50	52.39 AV	54.00	-1.61	1.28 H	250	19.93	32.46
7	4924.00	53.36 PK	74.00	-20.64	1.05 H	349	14.44	38.92
8	4924.00	49.27 AV	54.00	-4.73	1.05 H	349	10.35	38.92

ANTENNA POLARITY & TEST DISTANCE: VERTICAL AT 3 M								
NO.	FREQ. (MHz)	EMISSION LEVEL (dBuV/m)	LIMIT (dBuV/m)	MARGIN (dB)	ANTENNA HEIGHT (m)	TABLE ANGLE (Degree)	RAW VALUE (dBuV)	CORRECTION FACTOR (dB/m)
1	1056.00	45.48 PK	74.00	-28.52	1.10 V	241	17.82	27.66
2	1056.00	43.35 AV	54.00	-10.65	1.10 V	241	15.69	27.66
3	*2462.00	101.07 PK			1.11 V	145	68.69	32.38
4	*2462.00	97.08 AV			1.11 V	145	64.70	32.38
5	2483.50	48.90 PK	74.00	-25.10	1.11 V	145	16.44	32.46
6	2483.50	44.91 AV	54.00	-9.09	1.11 V	145	12.45	32.46
7	4924.00	47.62 PK	74.00	-26.38	1.09 V	308	8.70	38.92
8	4924.00	40.28 AV	54.00	-13.72	1.09 V	308	1.36	38.92

- REMARKS:**
1. Emission level (dBuV/m) = Raw Value (dBuV) + Correction Factor (dB/m).
  2. Correction Factor (dB/m) = Antenna Factor (dB/m) + Cable Factor (dB).
  3. The other emission levels were very low against the limit.
  4. Margin value = Emission level – Limit value.
  5. The limit value is defined as per 15.247.
  6. “ \* “: Fundamental frequency.



**802.11g OFDM MODULATION:**

EUT TEST CONDITION		MEASUREMENT DETAIL	
CHANNEL	Channel 1	FREQUENCY RANGE	1 ~ 25GHz
MODULATION TYPE	BPSK	INPUT POWER (SYSTEM)	120Vac, 60 Hz
TRANSFER RATE	6Mbps	DETECTOR FUNCTION	Peak(PK) Average (AV)
ENVIRONMENTAL CONDITIONS	24deg. C, 63%RH, 991hPa	TESTED BY	Brad Wu

ANTENNA POLARITY & TEST DISTANCE: HORIZONTAL AT 3 M								
NO.	FREQ. (MHz)	EMISSION LEVEL (dBuV/m)	LIMIT (dBuV/m)	MARGIN (dB)	ANTENNA HEIGHT (m)	TABLE ANGLE (Degree)	RAW VALUE (dBuV)	CORRECTION FACTOR (dB/m)
1	1056.00	49.21 PK	74.00	-24.79	1.06 H	131	21.55	27.66
2	1056.00	47.02 AV	54.00	-6.98	1.06 H	131	19.36	27.66
3	2390.00	62.26 PK	74.00	-11.74	1.27 H	273	30.15	32.11
4	2390.00	52.45 AV	54.00	-1.55	1.27 H	273	20.34	32.11
5	*2412.00	110.14 PK			1.27 H	273	77.95	32.19
6	*2412.00	100.33 AV			1.27 H	273	68.14	32.19
7	4824.00	51.14 PK	74.00	-22.86	1.16 H	341	12.49	38.65
8	4824.00	41.85 AV	54.00	-12.15	1.16 H	341	3.20	38.65

ANTENNA POLARITY & TEST DISTANCE: VERTICAL AT 3 M								
NO.	FREQ. (MHz)	EMISSION LEVEL (dBuV/m)	LIMIT (dBuV/m)	MARGIN (dB)	ANTENNA HEIGHT (m)	TABLE ANGLE (Degree)	RAW VALUE (dBuV)	CORRECTION FACTOR (dB/m)
1	1056.00	46.54 PK	74.00	-27.46	1.28 V	76	18.88	27.66
2	1056.00	44.01 AV	54.00	-9.99	1.28 V	76	16.35	27.66
3	2390.00	55.13 PK	74.00	-18.87	1.16 V	30	23.02	32.11
4	2390.00	44.91 AV	54.00	-9.09	1.16 V	30	12.80	32.11
5	*2412.00	103.51 PK			1.16 V	30	71.32	32.19
6	*2412.00	93.29 AV			1.16 V	30	61.10	32.19
7	4824.00	48.68 PK	74.00	-25.32	1.05 V	147	10.03	38.65
8	4824.00	39.11 AV	54.00	-14.89	1.05 V	147	0.46	38.65

- REMARKS:**
1. Emission level (dBuV/m) = Raw Value (dBuV) + Correction Factor (dB/m).
  2. Correction Factor (dB/m) = Antenna Factor (dB/m) + Cable Factor (dB).
  3. The other emission levels were very low against the limit.
  4. Margin value = Emission level – Limit value.
  5. The limit value is defined as per 15.247.
  6. “ \* “: Fundamental frequency.



EUT TEST CONDITION		MEASUREMENT DETAIL	
CHANNEL	Channel 6	FREQUENCY RANGE	1 ~ 25GHz
MODULATION TYPE	BPSK	INPUT POWER (SYSTEM)	120Vac, 60 Hz
TRANSFER RATE	6Mbps	DETECTOR FUNCTION	Peak(PK) Average (AV)
ENVIRONMENTAL CONDITIONS	24deg. C, 63%RH, 991hPa	TESTED BY	Brad Wu

ANTENNA POLARITY & TEST DISTANCE: HORIZONTAL AT 3 M								
NO.	FREQ. (MHz)	EMISSION LEVEL (dBuV/m)	LIMIT (dBuV/m)	MARGIN (dB)	ANTENNA HEIGHT (m)	TABLE ANGLE (Degree)	RAW VALUE (dBuV)	CORRECTION FACTOR (dB/m)
1	1056.00	48.79 PK	74.00	-25.21	1.09 H	105	21.13	27.66
2	1056.00	46.63 AV	54.00	-7.37	1.09 H	105	18.97	27.66
3	*2437.00	110.25 PK			1.26 H	271	77.96	32.29
4	*2437.00	100.41 AV			1.26 H	271	68.12	32.29
5	4874.00	52.96 PK	74.00	-21.04	1.14 H	220	14.17	38.79
6	4874.00	42.99 AV	54.00	-11.01	1.14 H	220	4.20	38.79

ANTENNA POLARITY & TEST DISTANCE: VERTICAL AT 3 M								
NO.	FREQ. (MHz)	EMISSION LEVEL (dBuV/m)	LIMIT (dBuV/m)	MARGIN (dB)	ANTENNA HEIGHT (m)	TABLE ANGLE (Degree)	RAW VALUE (dBuV)	CORRECTION FACTOR (dB/m)
1	1056.00	44.89 PK	74.00	-29.11	1.10 V	123	17.23	27.66
2	1056.00	42.77 AV	54.00	-11.23	1.10 V	123	15.11	27.66
3	*2437.00	103.64 PK			1.15 V	32	71.35	32.29
4	*2437.00	93.42 AV			1.15 V	32	61.13	32.29
5	4874.00	49.26 PK	74.00	-24.74	1.01 V	172	10.47	38.79
6	4874.00	39.45 AV	54.00	-14.55	1.01 V	172	0.66	38.79

- REMARKS:**
1. Emission level (dBuV/m) = Raw Value (dBuV) + Correction Factor (dB/m).
  2. Correction Factor (dB/m) = Antenna Factor (dB/m) + Cable Factor (dB).
  3. The other emission levels were very low against the limit.
  4. Margin value = Emission level – Limit value.
  5. The limit value is defined as per 15.247.
  6. “ \* “: Fundamental frequency.



EUT TEST CONDITION		MEASUREMENT DETAIL	
CHANNEL	Channel 11	FREQUENCY RANGE	1 ~ 25GHz
MODULATION TYPE	BPSK	INPUT POWER (SYSTEM)	120Vac, 60 Hz
TRANSFER RATE	6Mbps	DETECTOR FUNCTION	Peak(PK) Average (AV)
ENVIRONMENTAL CONDITIONS	24deg. C, 63%RH, 991hPa	TESTED BY	Brad Wu

ANTENNA POLARITY & TEST DISTANCE: HORIZONTAL AT 3 M								
NO.	FREQ. (MHz)	EMISSION LEVEL (dBuV/m)	LIMIT (dBuV/m)	MARGIN (dB)	ANTENNA HEIGHT (m)	TABLE ANGLE (Degree)	RAW VALUE (dBuV)	CORRECTION FACTOR (dB/m)
1	1056.00	49.67 PK	74.00	-24.33	1.04 H	126	22.01	27.66
2	1056.00	46.31 AV	54.00	-7.69	1.04 H	126	18.65	27.66
3	*2462.00	110.20 PK			1.26 H	271	77.82	32.38
4	*2462.00	100.35 AV			1.26 H	271	67.97	32.38
5	2483.50	62.64 PK	74.00	-11.36	1.26 H	271	30.18	32.46
6	2483.50	52.79 AV	54.00	-1.21	1.26 H	271	20.33	32.46
7	4924.00	54.71 PK	74.00	-19.29	1.05 H	261	15.79	38.92
8	4924.00	43.68 AV	54.00	-10.32	1.05 H	261	4.76	38.92

ANTENNA POLARITY & TEST DISTANCE: VERTICAL AT 3 M								
NO.	FREQ. (MHz)	EMISSION LEVEL (dBuV/m)	LIMIT (dBuV/m)	MARGIN (dB)	ANTENNA HEIGHT (m)	TABLE ANGLE (Degree)	RAW VALUE (dBuV)	CORRECTION FACTOR (dB/m)
1	1056.00	44.89 PK	74.00	-29.11	1.00 V	225	17.23	27.66
2	1056.00	43.26 AV	54.00	-10.74	1.00 V	225	15.60	27.66
3	*2462.00	103.62 PK			1.06 V	38	71.24	32.38
4	*2462.00	93.43 AV			1.06 V	38	61.05	32.38
5	2483.50	56.06 PK	74.00	-17.94	1.39 V	63	23.60	32.46
6	2483.50	45.87 AV	54.00	-8.13	1.39 V	63	13.41	32.46
7	4924.00	52.96 PK	74.00	-21.04	1.08 V	24	14.04	38.92
8	4924.00	37.90 AV	54.00	-16.10	1.08 V	24	-1.02	38.92

- REMARKS:**
1. Emission level (dBuV/m) = Raw Value (dBuV) + Correction Factor (dB/m).
  2. Correction Factor (dB/m) = Antenna Factor (dB/m) + Cable Factor (dB).
  3. The other emission levels were very low against the limit.
  4. Margin value = Emission level – Limit value.
  5. The limit value is defined as per 15.247.
  6. “ \* “: Fundamental frequency.



**DRAFT 802.11n (20MHz) OFDM MODULATION: DUAL TX:**

EUT TEST CONDITION		MEASUREMENT DETAIL	
CHANNEL	Channel 1	FREQUENCY RANGE	1 ~ 25GHz
MODULATION TYPE	BPSK	INPUT POWER (SYSTEM)	120Vac, 60 Hz
TRANSFER RATE	13Mbps	DETECTOR FUNCTION	Peak(PK) Average (AV)
ENVIRONMENTAL CONDITIONS	23deg. C, 62%RH, 991hPa	TESTED BY	Brad Wu

ANTENNA POLARITY & TEST DISTANCE: HORIZONTAL AT 3 M								
NO.	FREQ. (MHz)	EMISSION LEVEL (dBuV/m)	LIMIT (dBuV/m)	MARGIN (dB)	ANTENNA HEIGHT (m)	TABLE ANGLE (Degree)	RAW VALUE (dBuV)	CORRECTION FACTOR (dB/m)
1	1056.00	48.97 PK	74.00	-25.03	1.42 H	250	21.31	27.66
2	1056.00	46.82 AV	54.00	-7.18	1.42 H	250	19.16	27.66
3	2390.00	63.05 PK	74.00	-10.95	1.08 H	257	30.94	32.11
4	2390.00	52.34 AV	54.00	-1.66	1.08 H	257	20.23	32.11
5	*2412.00	113.26 PK			1.31 H	269	81.07	32.19
6	*2412.00	102.55 AV			1.31 H	269	70.36	32.19
7	4824.00	49.99 PK	74.00	-24.01	1.25 H	54	11.34	38.65
8	4824.00	41.30 AV	54.00	-12.70	1.25 H	54	2.65	38.65

ANTENNA POLARITY & TEST DISTANCE: VERTICAL AT 3 M								
NO.	FREQ. (MHz)	EMISSION LEVEL (dBuV/m)	LIMIT (dBuV/m)	MARGIN (dB)	ANTENNA HEIGHT (m)	TABLE ANGLE (Degree)	RAW VALUE (dBuV)	CORRECTION FACTOR (dB/m)
1	1056.00	45.98 PK	74.00	-28.02	1.00 V	97	18.32	27.66
2	1056.00	42.14 AV	54.00	-11.86	1.00 V	97	14.48	27.66
3	2390.00	58.20 PK	74.00	-15.80	1.00 V	125	26.09	32.11
4	2390.00	47.92 AV	54.00	-6.08	1.00 V	125	15.81	32.11
5	*2412.00	109.91 PK			1.26 V	146	77.72	32.19
6	*2412.00	99.63 AV			1.26 V	146	67.44	32.19
7	4824.00	48.00 PK	74.00	-26.00	1.52 V	169	9.35	38.65
8	4824.00	40.40 AV	54.00	-13.60	1.52 V	169	1.75	38.65

- REMARKS:**
1. Emission level (dBuV/m) = Raw Value (dBuV) + Correction Factor (dB/m).
  2. Correction Factor (dB/m) = Antenna Factor (dB/m) + Cable Factor (dB).
  3. The other emission levels were very low against the limit.
  4. Margin value = Emission level – Limit value.
  5. The limit value is defined as per 15.247.
  6. “ \* “: Fundamental frequency.



EUT TEST CONDITION		MEASUREMENT DETAIL	
CHANNEL	Channel 6	FREQUENCY RANGE	1 ~ 25GHz
MODULATION TYPE	BPSK	INPUT POWER (SYSTEM)	120Vac, 60 Hz
TRANSFER RATE	13Mbps	DETECTOR FUNCTION	Peak(PK) Average (AV)
ENVIRONMENTAL CONDITIONS	23deg. C, 62%RH, 991hPa	TESTED BY	Brad Wu

ANTENNA POLARITY & TEST DISTANCE: HORIZONTAL AT 3 M								
NO.	FREQ. (MHz)	EMISSION LEVEL (dBuV/m)	LIMIT (dBuV/m)	MARGIN (dB)	ANTENNA HEIGHT (m)	TABLE ANGLE (Degree)	RAW VALUE (dBuV)	CORRECTION FACTOR (dB/m)
1	1056.00	49.77 PK	74.00	-24.23	1.53 H	288	22.11	27.66
2	1056.00	47.61 AV	54.00	-6.39	1.53 H	288	19.95	27.66
3	*2437.00	112.89 PK			1.22 H	289	80.60	32.29
4	*2437.00	102.10 AV			1.22 H	289	69.81	32.29
5	4874.00	52.97 PK	74.00	-21.03	1.63 H	228	14.18	38.79
6	4874.00	41.68 AV	54.00	-12.32	1.63 H	228	2.89	38.79

ANTENNA POLARITY & TEST DISTANCE: VERTICAL AT 3 M								
NO.	FREQ. (MHz)	EMISSION LEVEL (dBuV/m)	LIMIT (dBuV/m)	MARGIN (dB)	ANTENNA HEIGHT (m)	TABLE ANGLE (Degree)	RAW VALUE (dBuV)	CORRECTION FACTOR (dB/m)
1	1056.00	47.80 PK	74.00	-26.20	1.02 V	65	20.14	27.66
2	1056.00	44.30 AV	54.00	-9.70	1.02 V	65	16.64	27.66
3	*2437.00	109.72 PK			1.22 V	154	77.43	32.29
4	*2437.00	98.98 AV			1.22 V	154	66.69	32.29
5	4874.00	48.47 PK	74.00	-25.53	1.00 V	258	9.68	38.79
6	4874.00	39.11 AV	54.00	-14.89	1.00 V	258	0.32	38.79

- REMARKS:**
1. Emission level (dBuV/m) = Raw Value (dBuV) + Correction Factor (dB/m).
  2. Correction Factor (dB/m) = Antenna Factor (dB/m) + Cable Factor (dB).
  3. The other emission levels were very low against the limit.
  4. Margin value = Emission level – Limit value.
  5. The limit value is defined as per 15.247.
  6. “ \* “: Fundamental frequency.

EUT TEST CONDITION		MEASUREMENT DETAIL	
CHANNEL	Channel 11	FREQUENCY RANGE	1 ~ 25GHz
MODULATION TYPE	BPSK	INPUT POWER (SYSTEM)	120Vac, 60 Hz
TRANSFER RATE	13Mbps	DETECTOR FUNCTION	Peak(PK) Average (AV)
ENVIRONMENTAL CONDITIONS	23deg. C, 62%RH, 991hPa	TESTED BY	Brad Wu

ANTENNA POLARITY & TEST DISTANCE: HORIZONTAL AT 3 M								
NO.	FREQ. (MHz)	EMISSION LEVEL (dBuV/m)	LIMIT (dBuV/m)	MARGIN (dB)	ANTENNA HEIGHT (m)	TABLE ANGLE (Degree)	RAW VALUE (dBuV)	CORRECTION FACTOR (dB/m)
1	1056.00	49.26 PK	74.00	-24.74	1.48 H	339	21.60	27.66
2	1056.00	46.86 AV	54.00	-7.14	1.48 H	339	19.20	27.66
3	*2462.00	113.10 PK			1.00 H	300	80.72	32.38
4	*2462.00	102.32 AV			1.00 H	300	69.94	32.38
5	2483.50	63.46 PK	74.00	-10.54	1.42 H	287	31.00	32.46
6	2483.50	52.68 AV	54.00	-1.32	1.42 H	287	20.22	32.46
7	4924.00	51.94 PK	74.00	-22.06	1.25 H	36	13.02	38.92
8	4924.00	42.47 AV	54.00	-11.53	1.25 H	36	3.55	38.92

ANTENNA POLARITY & TEST DISTANCE: VERTICAL AT 3 M								
NO.	FREQ. (MHz)	EMISSION LEVEL (dBuV/m)	LIMIT (dBuV/m)	MARGIN (dB)	ANTENNA HEIGHT (m)	TABLE ANGLE (Degree)	RAW VALUE (dBuV)	CORRECTION FACTOR (dB/m)
1	1056.00	45.17 PK	74.00	-28.83	1.00 V	39	17.51	27.66
2	1056.00	43.15 AV	54.00	-10.85	1.00 V	39	15.49	27.66
3	*2462.00	109.84 PK			1.10 V	17	77.46	32.38
4	*2462.00	99.15 AV			1.10 V	17	66.77	32.38
5	2483.50	59.20 PK	74.00	-14.80	1.24 V	37	26.74	32.46
6	2483.50	48.51 AV	54.00	-5.49	1.24 V	37	16.05	32.46
7	4924.00	48.35 PK	74.00	-25.65	1.00 V	69	9.43	38.92
8	4924.00	39.80 AV	54.00	-14.20	1.00 V	69	0.88	38.92

- REMARKS:**
1. Emission level (dBuV/m) = Raw Value (dBuV) + Correction Factor (dB/m).
  2. Correction Factor (dB/m) = Antenna Factor (dB/m) + Cable Factor (dB).
  3. The other emission levels were very low against the limit.
  4. Margin value = Emission level – Limit value.
  5. The limit value is defined as per 15.247.
  6. “ \* “: Fundamental frequency.





**DRAFT 802.11n (40MHz) OFDM MODULATION: DUAL TX:**

EUT TEST CONDITION		MEASUREMENT DETAIL	
CHANNEL	Channel 1	FREQUENCY RANGE	1 ~ 25GHz
MODULATION TYPE	BPSK	INPUT POWER (SYSTEM)	120Vac, 60 Hz
TRANSFER RATE	27Mbps	DETECTOR FUNCTION	Peak(PK) Average (AV)
ENVIRONMENTAL CONDITIONS	23deg. C, 62%RH, 991hPa	TESTED BY	Brad Wu

ANTENNA POLARITY & TEST DISTANCE: HORIZONTAL AT 3 M								
NO.	FREQ. (MHz)	EMISSION LEVEL (dBuV/m)	LIMIT (dBuV/m)	MARGIN (dB)	ANTENNA HEIGHT (m)	TABLE ANGLE (Degree)	RAW VALUE (dBuV)	CORRECTION FACTOR (dB/m)
1	1056.00	48.97 PK	74.00	-25.03	1.45 H	358	21.31	27.66
2	1056.00	46.24 AV	54.00	-7.76	1.45 H	358	18.58	27.66
3	2390.00	67.17 PK	74.00	-6.83	1.24 H	288	35.06	32.11
4	2390.00	52.81 AV	54.00	-1.19	1.24 H	288	20.70	32.11
5	*2422.00	110.84 PK			1.36 H	300	78.61	32.23
6	*2422.00	99.84 AV			1.36 H	300	67.61	32.23
7	4844.00	50.58 PK	74.00	-23.42	1.00 H	350	11.88	38.70
8	4844.00	40.64 AV	54.00	-13.36	1.00 H	350	1.94	38.70

ANTENNA POLARITY & TEST DISTANCE: VERTICAL AT 3 M								
NO.	FREQ. (MHz)	EMISSION LEVEL (dBuV/m)	LIMIT (dBuV/m)	MARGIN (dB)	ANTENNA HEIGHT (m)	TABLE ANGLE (Degree)	RAW VALUE (dBuV)	CORRECTION FACTOR (dB/m)
1	1056.00	46.10 PK	74.00	-27.90	1.00 V	98	18.44	27.66
2	1056.00	43.24 AV	54.00	-10.76	1.00 V	98	15.58	27.66
3	2390.00	60.18 PK	74.00	-13.82	1.26 V	258	28.07	32.11
4	2390.00	49.59 AV	54.00	-4.41	1.26 V	258	17.48	32.11
5	*2422.00	107.61 PK			1.00 V	12	75.38	32.23
6	*2422.00	97.02 AV			1.00 V	12	64.79	32.23
7	4844.00	48.50 PK	74.00	-25.50	1.16 V	258	9.80	38.70
8	4844.00	39.82 AV	54.00	-14.18	1.16 V	258	1.12	38.70

- REMARKS:**
1. Emission level (dBuV/m) = Raw Value (dBuV) + Correction Factor (dB/m).
  2. Correction Factor (dB/m) = Antenna Factor (dB/m) + Cable Factor (dB).
  3. The other emission levels were very low against the limit.
  4. Margin value = Emission level – Limit value.
  5. The limit value is defined as per 15.247.
  6. “ \* “: Fundamental frequency.



EUT TEST CONDITION		MEASUREMENT DETAIL	
CHANNEL	Channel 4	FREQUENCY RANGE	1 ~ 25GHz
MODULATION TYPE	BPSK	INPUT POWER (SYSTEM)	120Vac, 60 Hz
TRANSFER RATE	27Mbps	DETECTOR FUNCTION	Peak(PK) Average (AV)
ENVIRONMENTAL CONDITIONS	23deg. C, 62%RH, 991hPa	TESTED BY	Brad Wu

ANTENNA POLARITY & TEST DISTANCE: HORIZONTAL AT 3 M								
NO.	FREQ. (MHz)	EMISSION LEVEL (dBuV/m)	LIMIT (dBuV/m)	MARGIN (dB)	ANTENNA HEIGHT (m)	TABLE ANGLE (Degree)	RAW VALUE (dBuV)	CORRECTION FACTOR (dB/m)
1	1056.00	49.41 PK	74.00	-24.59	1.00 H	25	21.75	27.66
1	1056.00	46.89 AV	54.00	-7.11	1.00 H	25	19.23	27.66
2	*2437.00	110.81 PK			1.00 H	290	78.52	32.29
2	*2437.00	100.14 AV			1.00 H	290	67.85	32.29
3	4874.00	53.05 PK	74.00	-20.95	1.24 H	351	14.26	38.79
3	4874.00	42.71 AV	54.00	-11.29	1.24 H	351	3.92	38.79

ANTENNA POLARITY & TEST DISTANCE: VERTICAL AT 3 M								
NO.	FREQ. (MHz)	EMISSION LEVEL (dBuV/m)	LIMIT (dBuV/m)	MARGIN (dB)	ANTENNA HEIGHT (m)	TABLE ANGLE (Degree)	RAW VALUE (dBuV)	CORRECTION FACTOR (dB/m)
1	1056.00	47.14 PK	74.00	-26.86	1.44 V	38	19.48	27.66
1	1056.00	43.66 AV	54.00	-10.34	1.44 V	38	16.00	27.66
2	*2437.00	107.46 PK			1.52 V	155	75.17	32.29
2	*2437.00	96.58 AV			1.52 V	155	64.29	32.29
3	4874.00	51.02 PK	74.00	-22.98	1.50 V	38	12.23	38.79
3	4874.00	41.51 AV	54.00	-12.49	1.50 V	38	2.72	38.79

- REMARKS:**
1. Emission level (dBuV/m) = Raw Value (dBuV) + Correction Factor (dB/m).
  2. Correction Factor (dB/m) = Antenna Factor (dB/m) + Cable Factor (dB).
  3. The other emission levels were very low against the limit.
  4. Margin value = Emission level – Limit value.
  5. The limit value is defined as per 15.247.
  6. “ \* “: Fundamental frequency.



EUT TEST CONDITION		MEASUREMENT DETAIL	
CHANNEL	Channel 7	FREQUENCY RANGE	1 ~ 25GHz
MODULATION TYPE	BPSK	INPUT POWER (SYSTEM)	120Vac, 60 Hz
TRANSFER RATE	27Mbps	DETECTOR FUNCTION	Peak(PK) Average (AV)
ENVIRONMENTAL CONDITIONS	23deg. C, 62%RH, 991hPa	TESTED BY	Brad Wu

ANTENNA POLARITY & TEST DISTANCE: HORIZONTAL AT 3 M								
NO.	FREQ. (MHz)	EMISSION LEVEL (dBuV/m)	LIMIT (dBuV/m)	MARGIN (dB)	ANTENNA HEIGHT (m)	TABLE ANGLE (Degree)	RAW VALUE (dBuV)	CORRECTION FACTOR (dB/m)
1	1056.00	48.33 PK	74.00	-25.67	1.44 H	297	20.67	27.66
1	1056.00	46.16 AV	54.00	-7.84	1.44 H	297	18.50	27.66
2	*2452.00	110.71 PK			1.00 H	236	78.37	32.34
2	*2452.00	99.31 AV			1.00 H	236	66.97	32.34
3	2483.50	63.16 PK	74.00	-10.84	1.24 H	254	30.70	32.46
3	2483.50	52.06 AV	54.00	-1.94	1.24 H	254	19.60	32.46
4	4904.00	52.95 PK	74.00	-21.05	1.00 H	38	14.08	38.87
4	4904.00	42.01 AV	54.00	-11.99	1.00 H	38	3.14	38.87

ANTENNA POLARITY & TEST DISTANCE: VERTICAL AT 3 M								
NO.	FREQ. (MHz)	EMISSION LEVEL (dBuV/m)	LIMIT (dBuV/m)	MARGIN (dB)	ANTENNA HEIGHT (m)	TABLE ANGLE (Degree)	RAW VALUE (dBuV)	CORRECTION FACTOR (dB/m)
1	1056.00	46.80 PK	74.00	-27.20	1.00 V	54	19.14	27.66
1	1056.00	43.13 AV	54.00	-10.87	1.00 V	54	15.47	27.66
2	*2452.00	106.96 PK			1.00 V	335	74.62	32.34
2	*2452.00	96.33 AV			1.00 V	335	63.99	32.34
3	2483.50	58.41 PK	74.00	-15.59	1.06 V	157	25.95	32.46
3	2483.50	47.78 AV	54.00	-6.22	1.06 V	157	15.32	32.46
4	4904.00	49.21 PK	74.00	-24.79	1.00 V	36	10.34	38.87
4	4904.00	41.26 AV	54.00	-12.74	1.00 V	36	2.39	38.87

- REMARKS:**
1. Emission level (dBuV/m) = Raw Value (dBuV) + Correction Factor (dB/m).
  2. Correction Factor (dB/m) = Antenna Factor (dB/m) + Cable Factor (dB).
  3. The other emission levels were very low against the limit.
  4. Margin value = Emission level – Limit value.
  5. The limit value is defined as per 15.247.
  6. “ \* “: Fundamental frequency.



### 4.3 6dB BANDWIDTH MEASUREMENT

#### 4.3.1 LIMITS OF 6dB BANDWIDTH MEASUREMENT

The minimum of 6dB Bandwidth Measurement is 0.5 MHz.

#### 4.3.2 TEST INSTRUMENTS

DESCRIPTION & MANUFACTURER	MODEL NO.	SERIAL NO.	CALIBRATED UNTIL
SPECTRUM ANALYZER	FSEK 30	100049	Aug. 14, 2006

**NOTE:** The calibration interval of the above test instruments is 12 months and the calibrations are traceable to NML/ROC and NIST/USA.

#### 4.3.3 TEST PROCEDURE

The transmitter output was connected to the spectrum analyzer through an attenuator. The bandwidth of the fundamental frequency was measured by spectrum analyzer with 100kHz RBW and 100kHz VBW. The 6dB bandwidth is defined as the total spectrum the power of which is higher than peak power minus 6dB.

#### 4.3.4 DEVIATION FROM TEST STANDARD

No deviation

#### 4.3.5 TEST SETUP

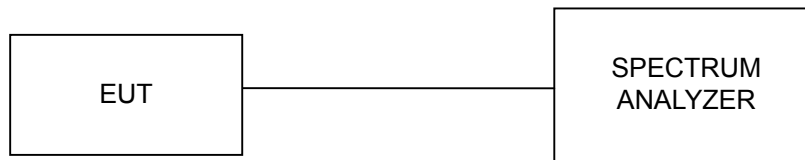

#### 4.3.6 EUT OPERATING CONDITIONS

The software provided by client to enable the EUT under transmission condition continuously at lowest, middle and highest channel frequencies individually.

### 4.3.7 TEST RESULTS

#### 802.11b DSSS MODULATION:

<b>MODULATION TYPE</b>	DBPSK	<b>TRANSFER RATE</b>	1Mbps
<b>INPUT POWER (SYSTEM)</b>	120Vac, 60 Hz	<b>ENVIRONMENTAL CONDITIONS</b>	25deg.C, 63%RH, 991hPa
<b>TESTED BY</b>	Long Chen		

CHANNEL	CHANNEL FREQUENCY (MHz)	6dB BANDWIDTH (MHz)	MINIMUM LIMIT (MHz)	PASS / FAIL
1	2412	10.16	0.5	PASS
6	2437	10.16	0.5	PASS
11	2462	10.16	0.5	PASS

#### CH 1

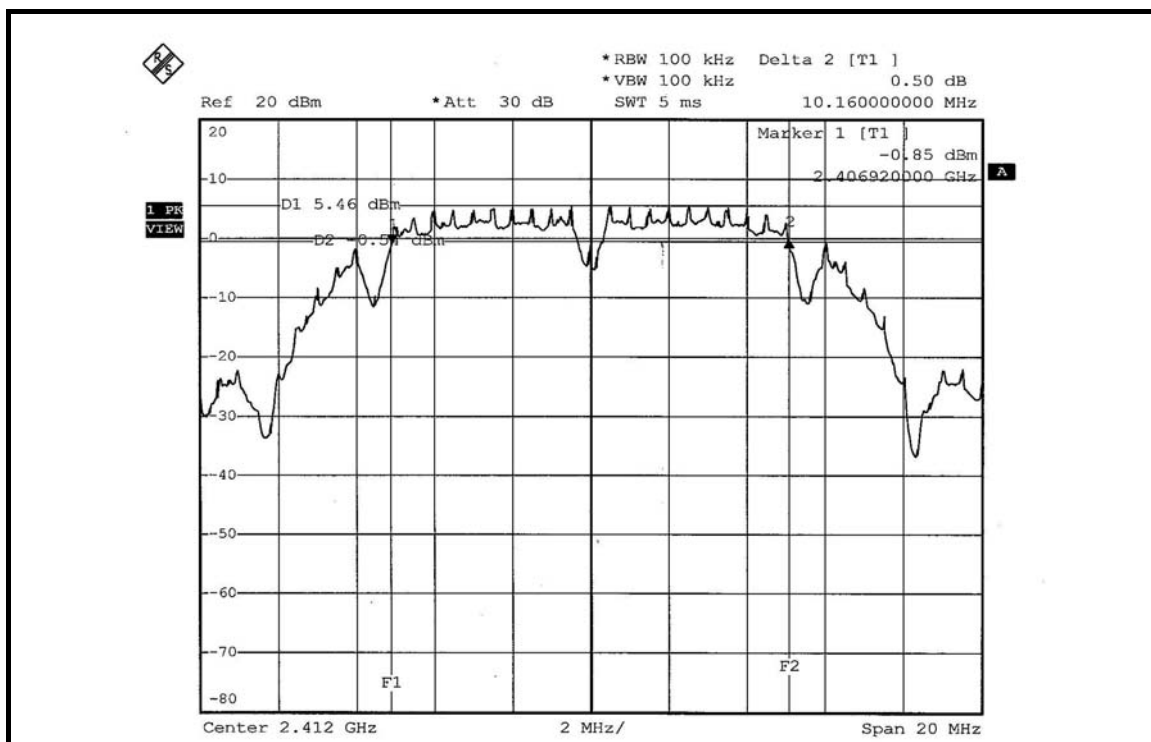

CH 6

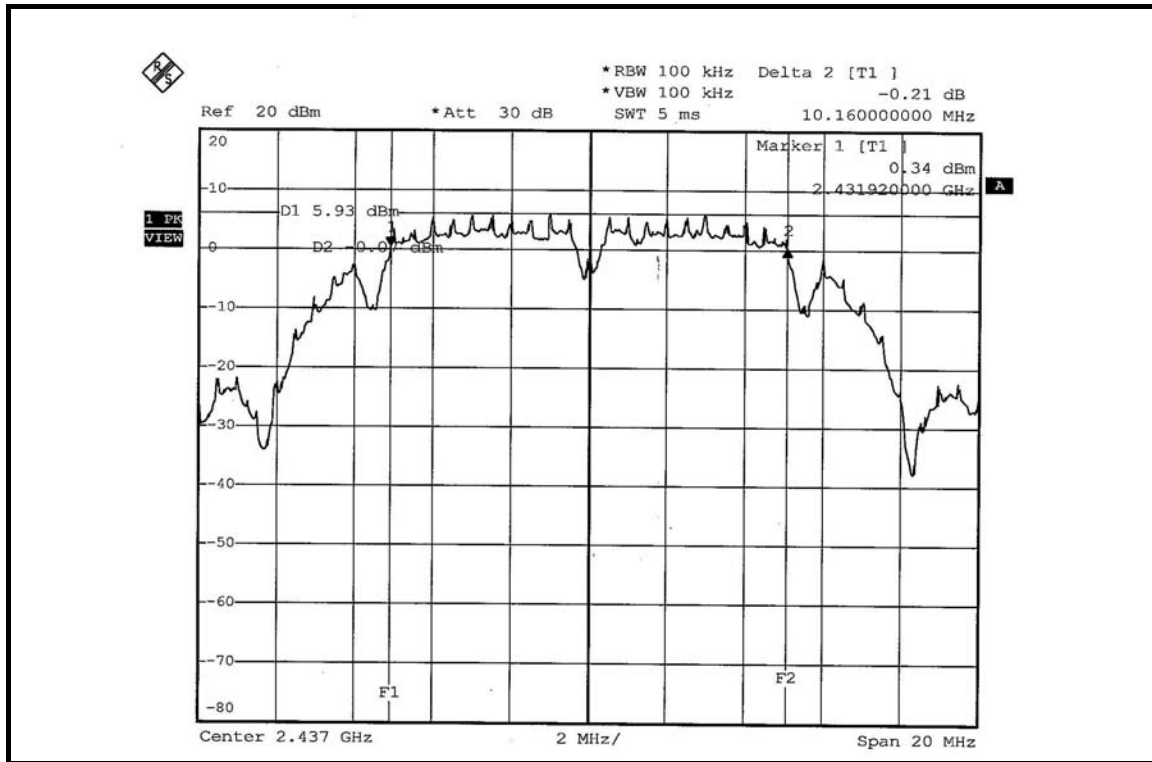

CH 11

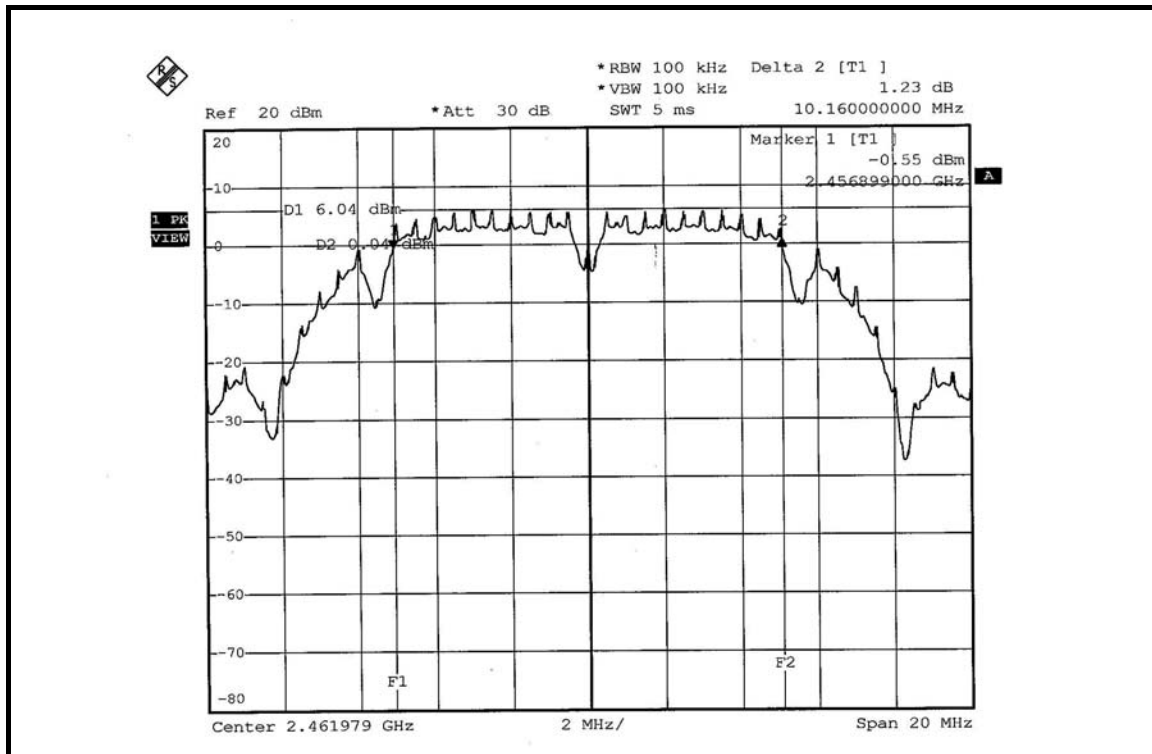

### 802.11g OFDM MODULATION:

<b>MODULATION TYPE</b>	BPSK	<b>TRANSFER RATE</b>	6Mbps
<b>INPUT POWER (SYSTEM)</b>	120Vac, 60 Hz	<b>ENVIRONMENTAL CONDITIONS</b>	25deg.C, 63%RH, 991hPa
<b>TESTED BY</b>	Long Chen		

CHANNEL	CHANNEL FREQUENCY (MHz)	6dB BANDWIDTH (MHz)	MINIMUM LIMIT (MHz)	PASS / FAIL
1	2412	15.00	0.5	PASS
6	2437	15.04	0.5	PASS
11	2462	15.08	0.5	PASS

### CH 1

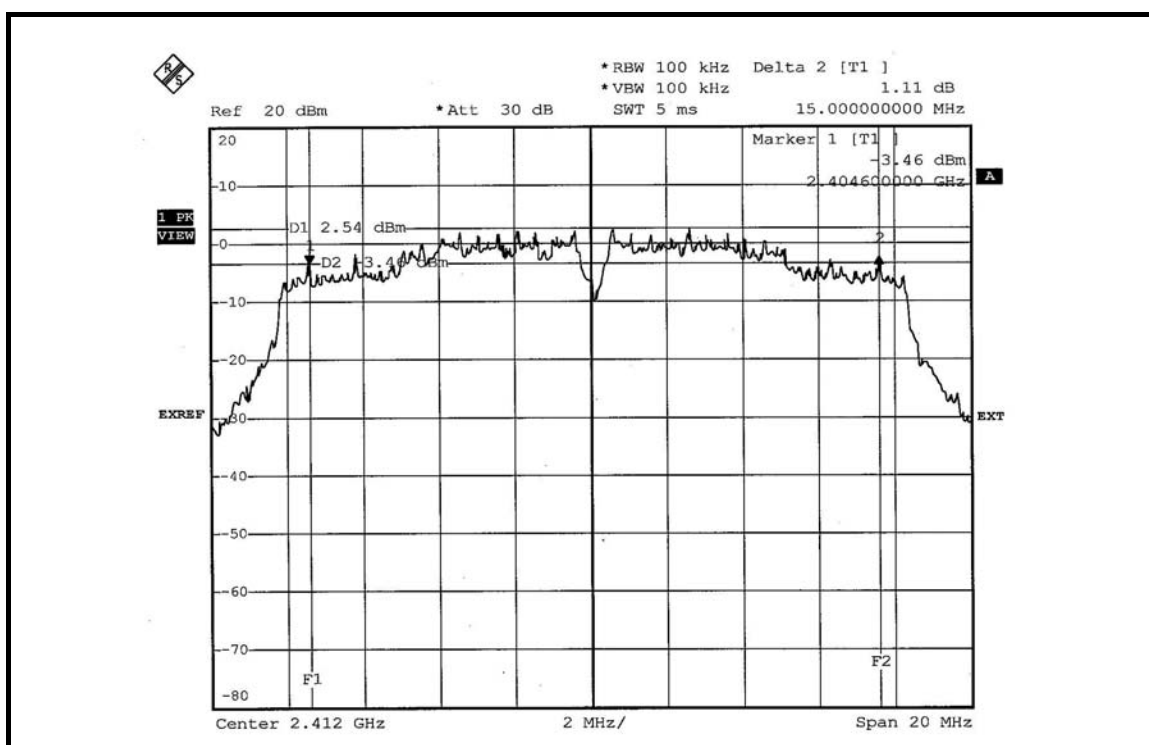



CH 6

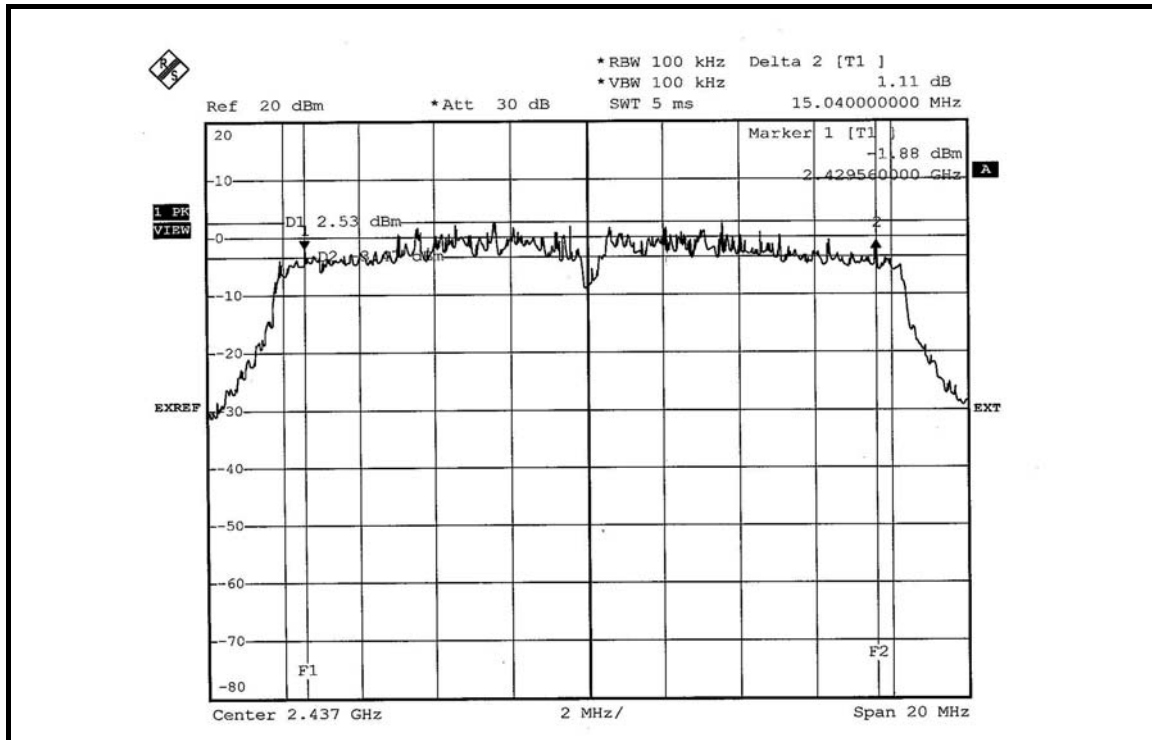

CH 11

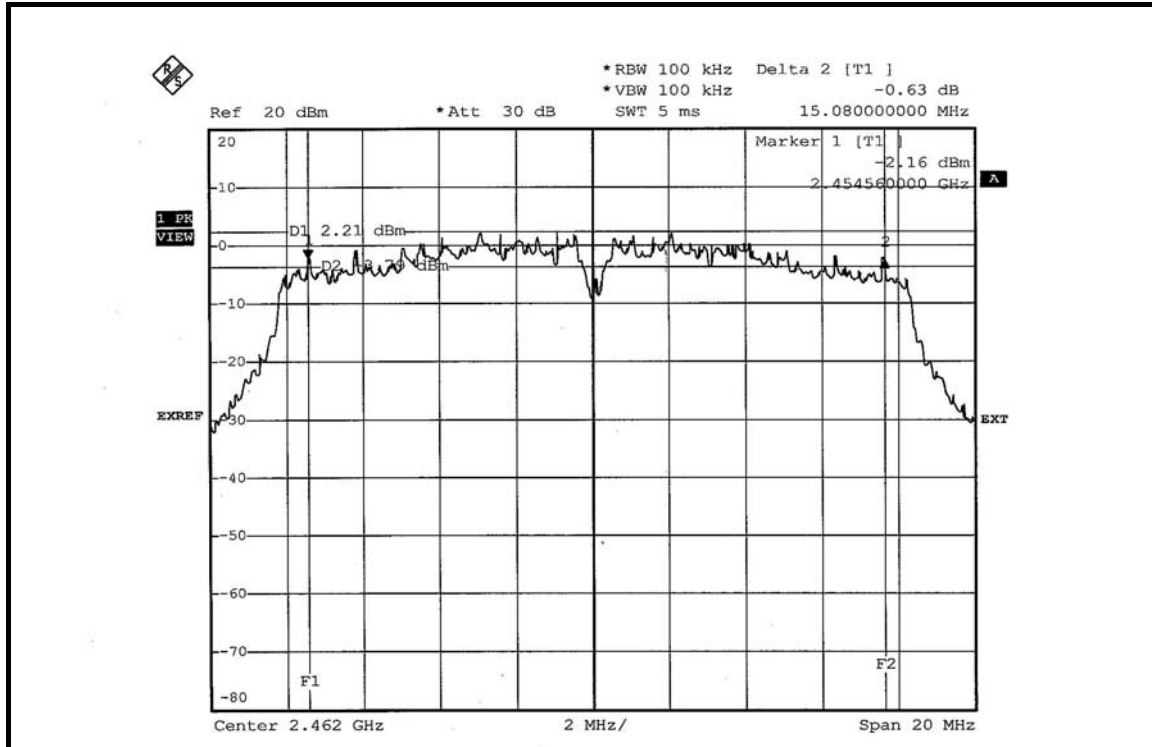



**DRAFT 802.11n (20MHz) OFDM MODULATION: DUAL TX:**

<b>MODULATION TYPE</b>	BPSK	<b>TRANSFER RATE</b>	13Mbps
<b>INPUT POWER (SYSTEM)</b>	120Vac, 60 Hz	<b>ENVIRONMENTAL CONDITIONS</b>	25deg.C, 63%RH, 991hPa
<b>TESTED BY</b>	Long Chen		

CHANNEL	CHANNEL FREQUENCY (MHz)	6dB BANDWIDTH (MHz)		MINIMUM LIMIT (MHz)	PASS / FAIL
		CHAIN 0	CHAIN 1		
1	2412	16.68	16.60	0.5	PASS
6	2437	16.84	16.68	0.5	PASS
11	2462	16.80	16.88	0.5	PASS

**FOR CHAIN 0: CH 1**

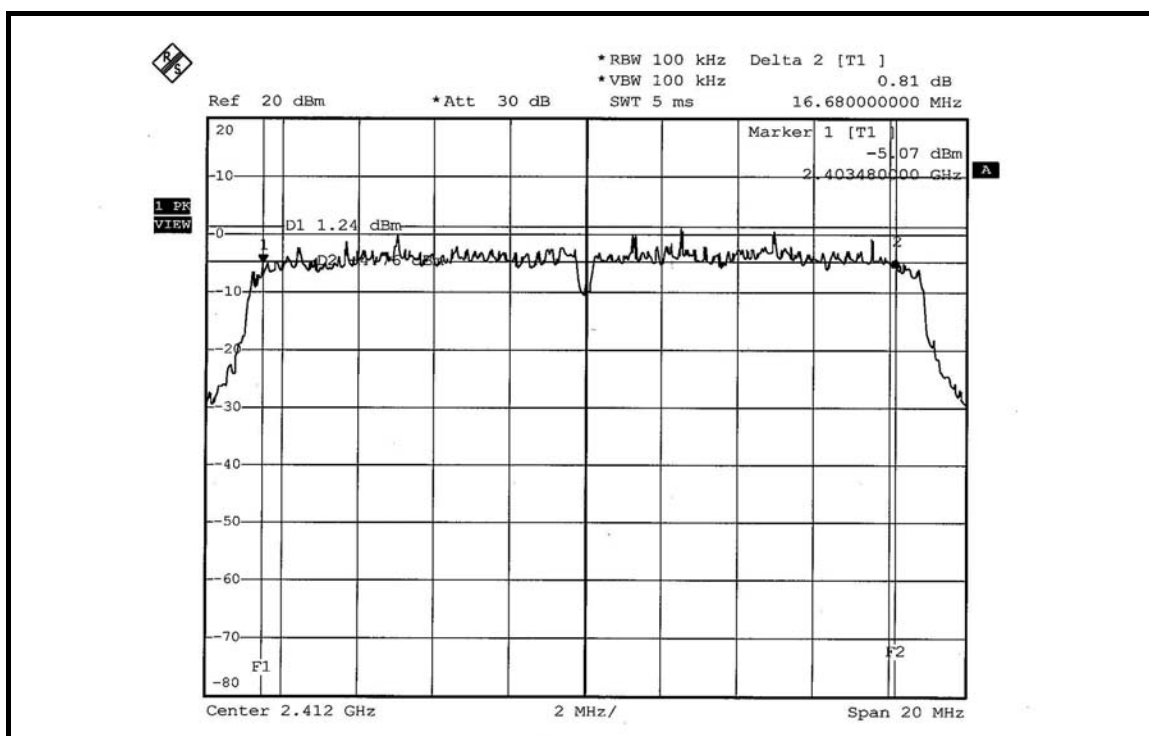

CH 6

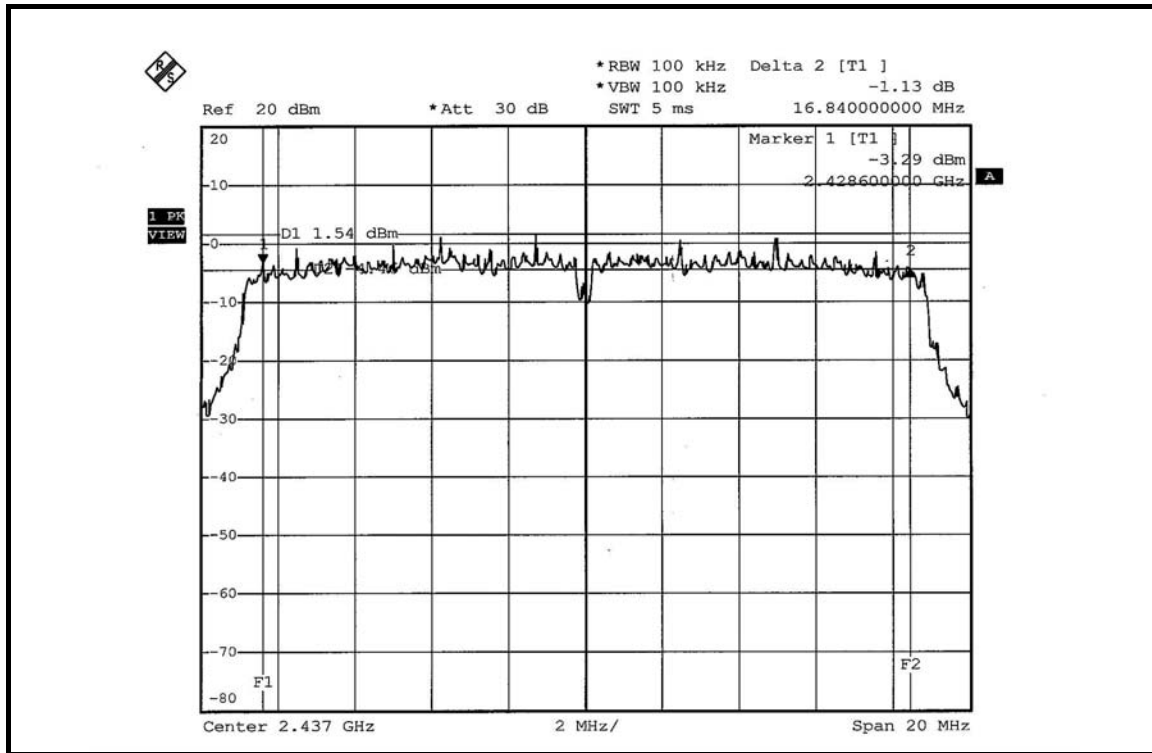

CH 11

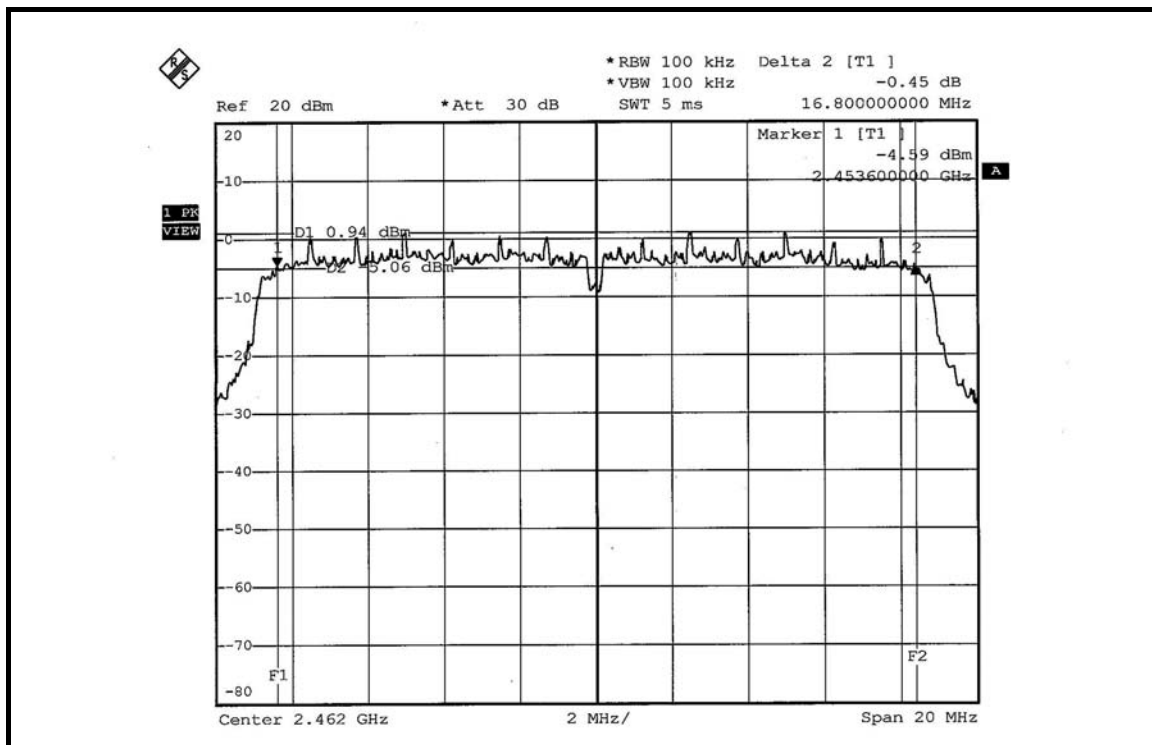

FOR CHAIN 1: CH 1

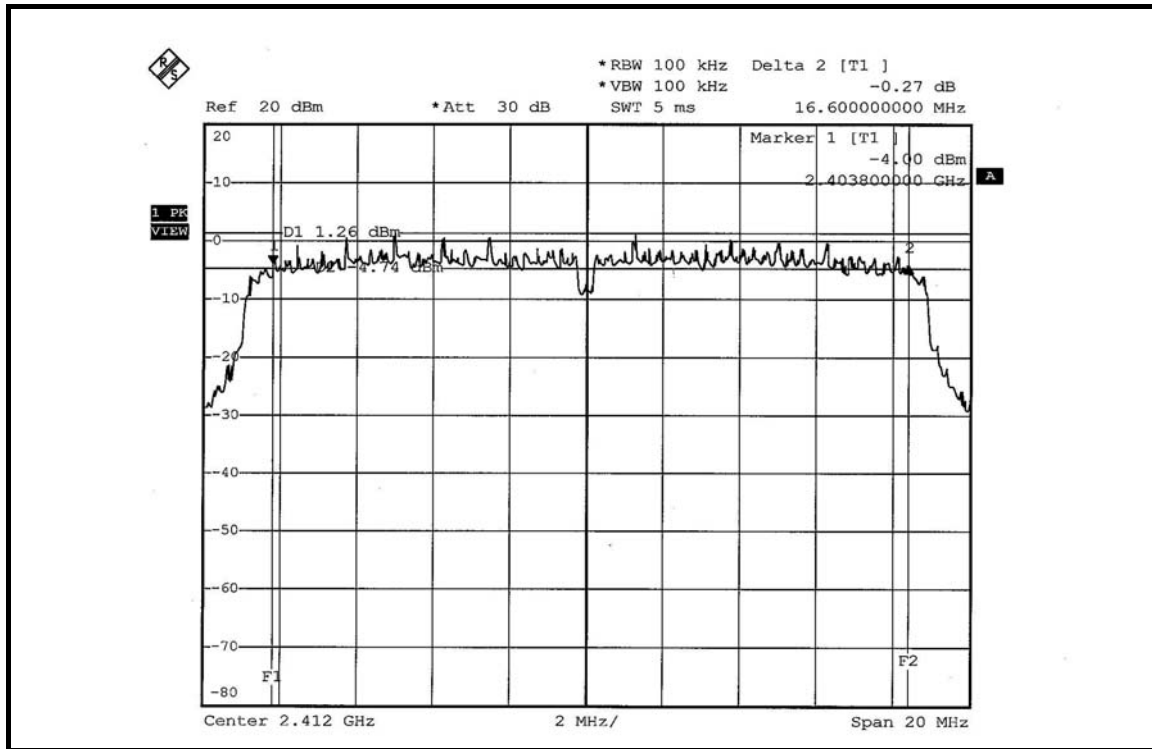

CH 6

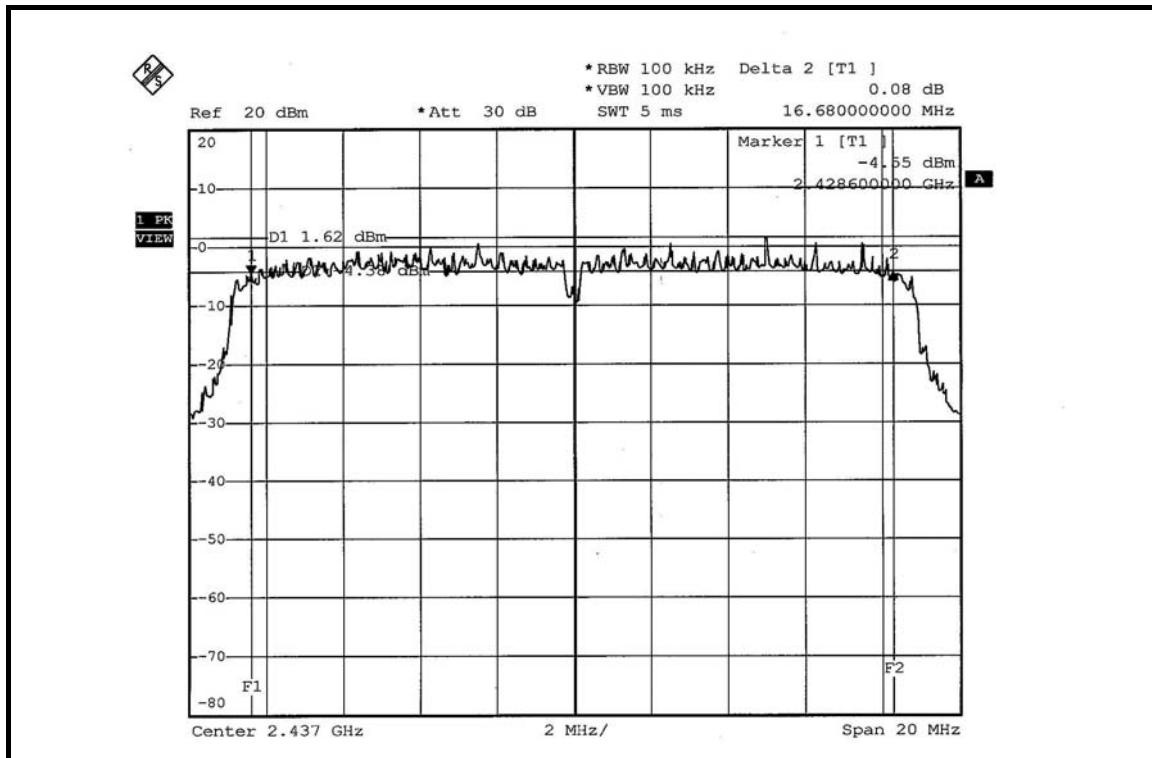

CH 11

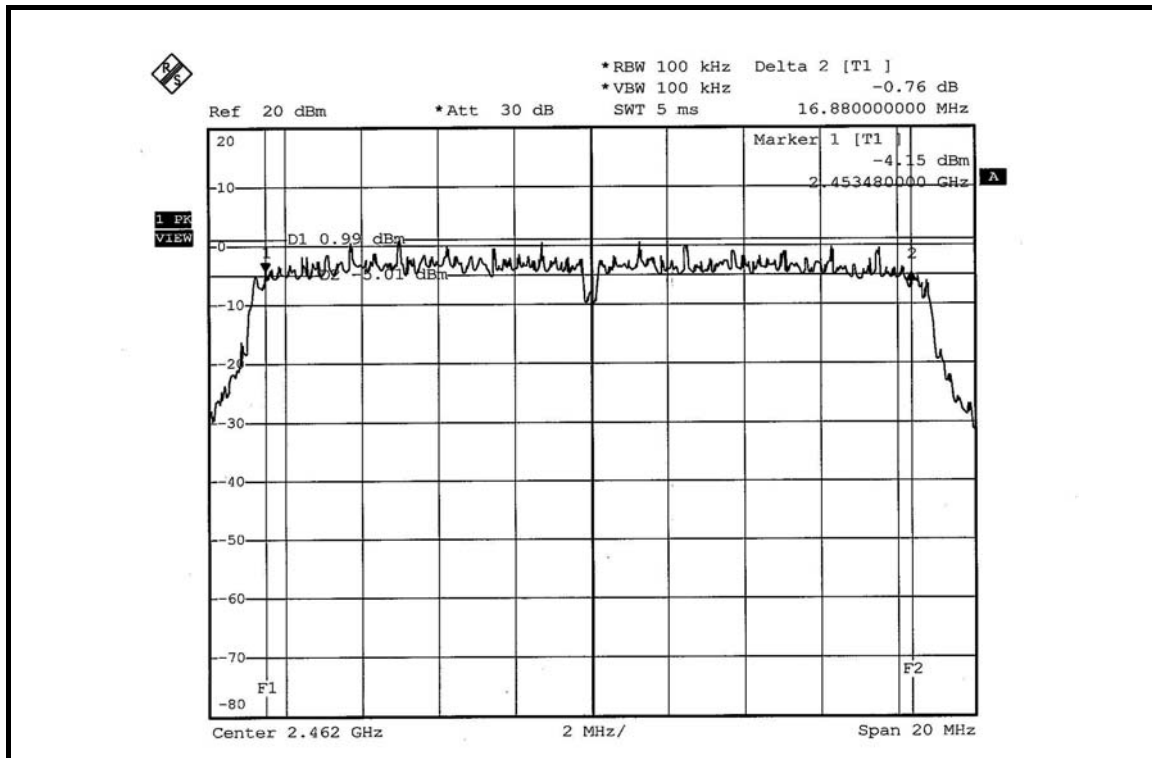



**DRAFT 802.11n (40MHz) OFDM MODULATION: DUAL TX:**

<b>MODULATION TYPE</b>	BPSK	<b>TRANSFER RATE</b>	27Mbps
<b>INPUT POWER (SYSTEM)</b>	120Vac, 60 Hz	<b>ENVIRONMENTAL CONDITIONS</b>	25deg.C, 63%RH, 991hPa
<b>TESTED BY</b>	Long Chen		

CHANNEL	CHANNEL FREQUENCY (MHz)	6dB BANDWIDTH (MHz)		MINIMUM LIMIT (MHz)	PASS / FAIL
		CHAIN 0	CHAIN 1		
1	2422	35.12	35.52	0.5	PASS
4	2437	35.12	35.60	0.5	PASS
7	2452	35.20	35.28	0.5	PASS

**FOR CHAIN 0: CH 1**

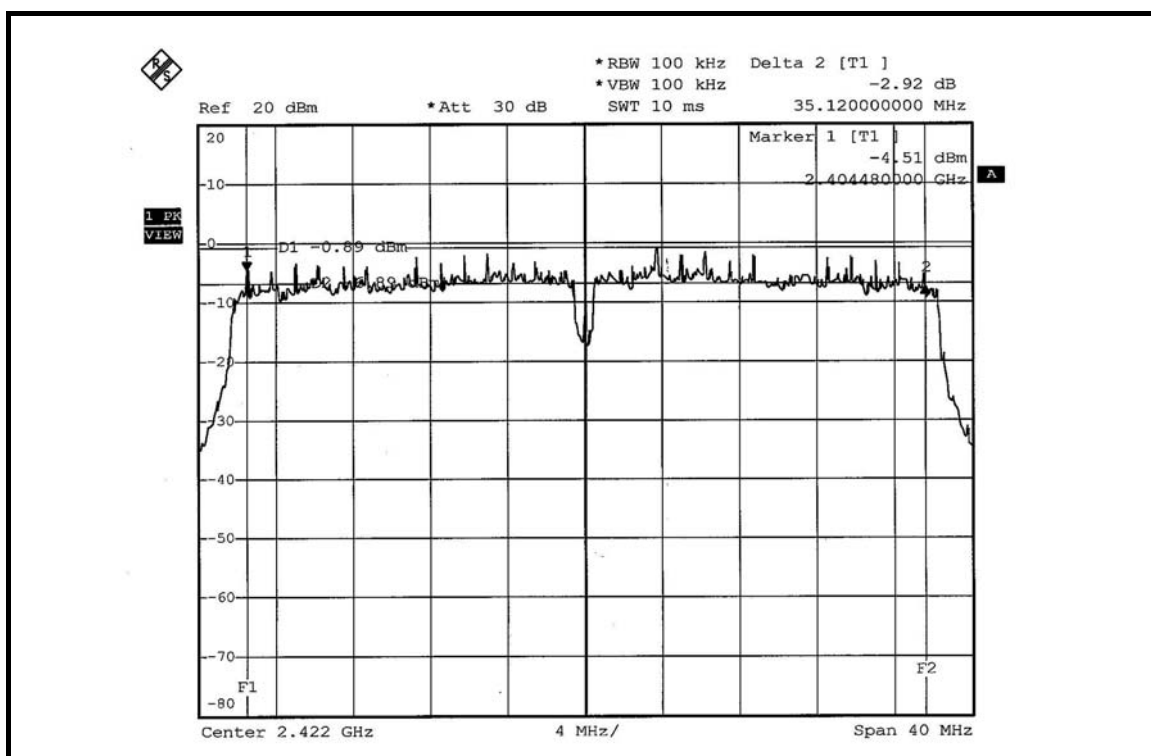

CH 4

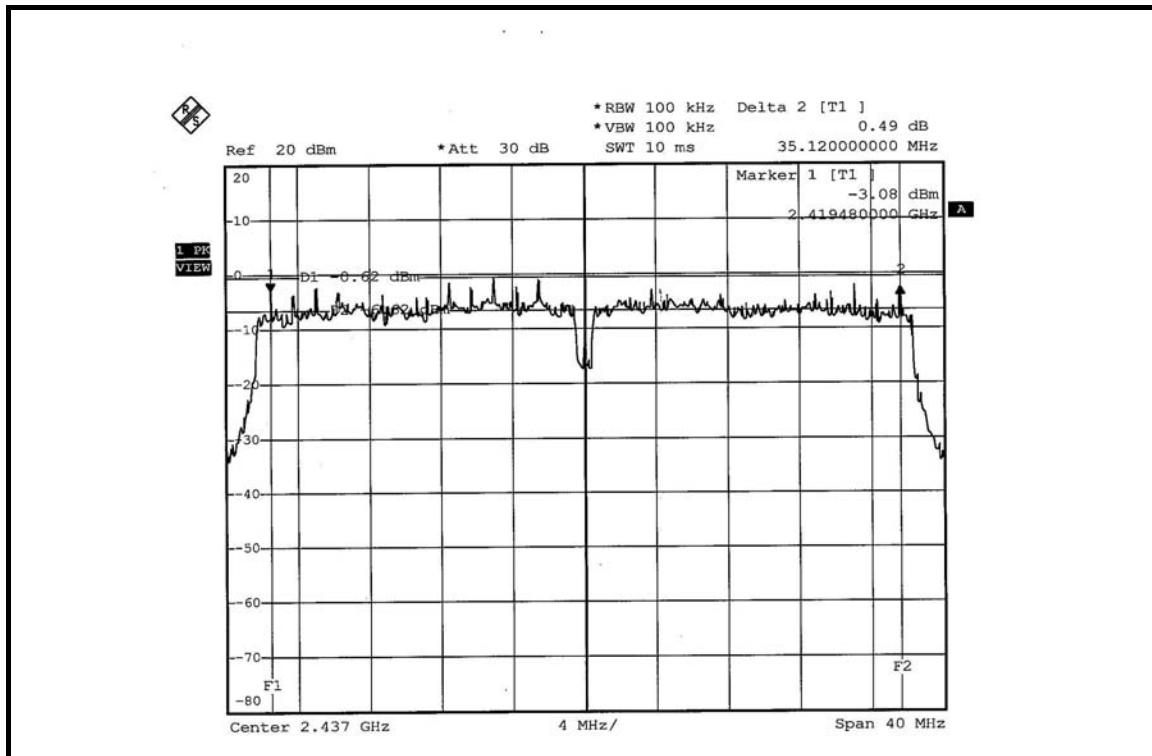

CH 7

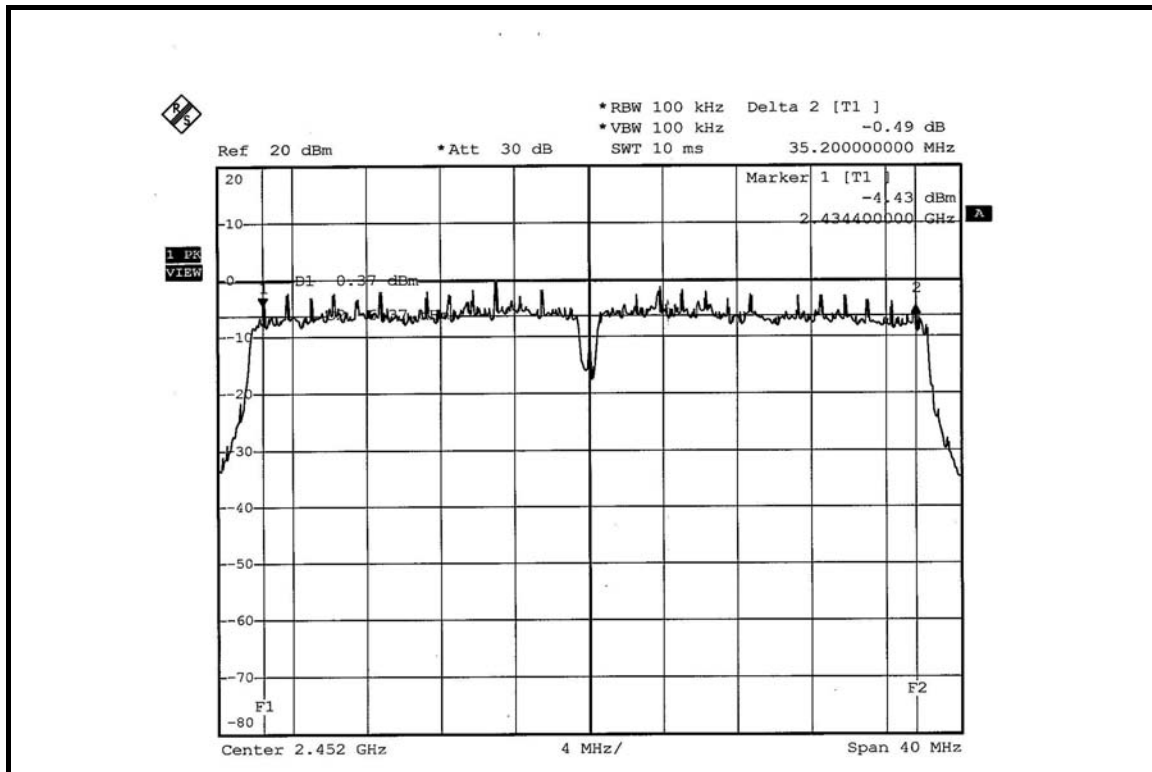

FOR CHAIN 1: CH 1

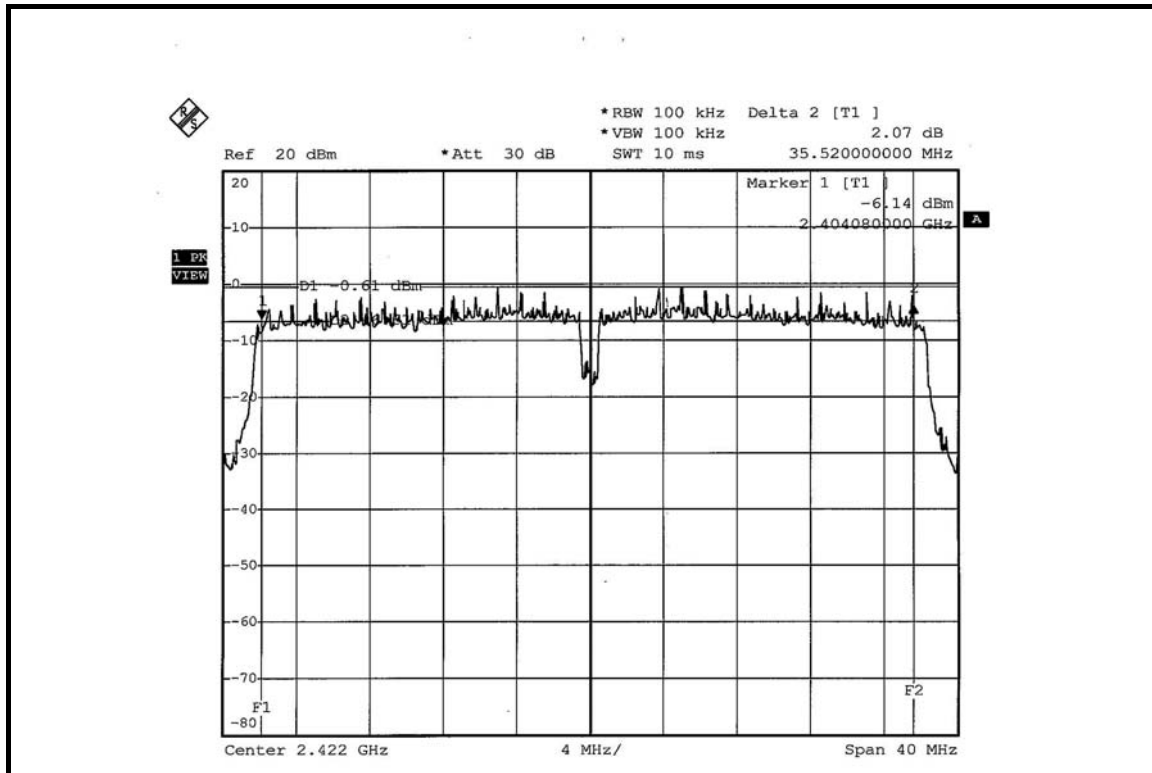

CH 4

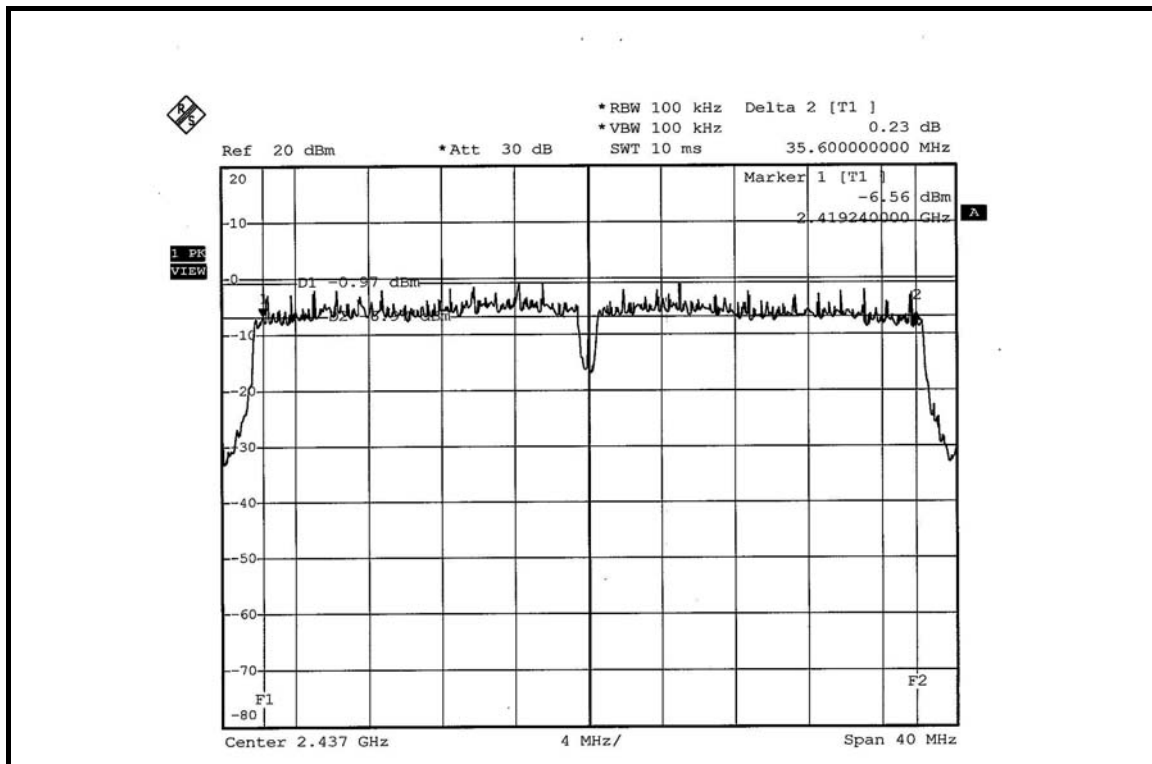



CH 7

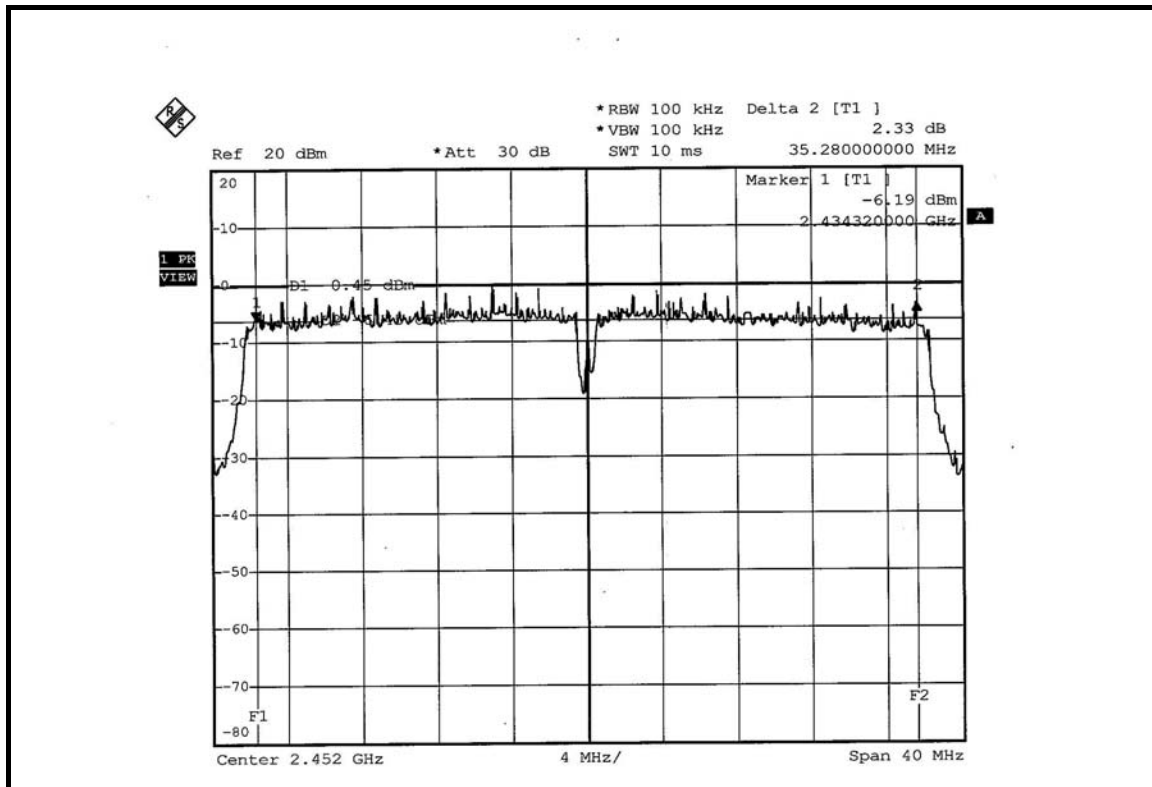



#### 4.4 MAXIMUM PEAK OUTPUT POWER

##### 4.4.1 LIMITS OF MAXIMUM PEAK OUTPUT POWER MEASUREMENT

The Maximum Peak Output Power Measurement is 30dBm.

##### 4.4.2 INSTRUMENTS

DESCRIPTION & MANUFACTURER	MODEL NO.	SERIAL NO.	CALIBRATED UNTIL
R&S SPECTRUM ANALYZER	FSEK30	100049	Aug. 14, 2006
AGILENT SIGNAL GENERATOR	E8257C	MY43320668	Dec. 07, 2006
DIGITAL RT OSCILLOSCOPE	TDS1012	C037299	Nov. 28, 2006
NARDA DETECTOR	4503A	FSCM99899	NA

**NOTE:** The calibration interval of the above test instruments is 12 months and the calibrations are traceable to NML/ROC and NIST/USA.

##### 4.4.3 TEST PROCEDURES

1. A detector was used on the output port of the EUT. An oscilloscope was used to read the response of the detector.
2. Replaced the EUT by the signal generator. The center frequency of the S.G was adjusted to the center frequency of the measured channel.
3. Adjusted the power to have the same reading on oscilloscope. Record the power level.

##### 4.4.4 DEVIATION FROM TEST STANDARD

No deviation

#### 4.4.5 TEST SETUP

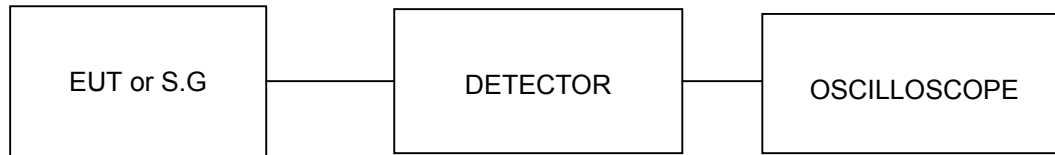

#### 4.4.6 EUT OPERATING CONDITIONS

Same as Item 4.3.6



#### 4.4.7 TEST RESULTS

##### 802.11b DSSS MODULATION:

<b>MODULATION TYPE</b>	DBPSK	<b>TRANSFER RATE</b>	1Mbps
<b>INPUT POWER (SYSTEM)</b>	120Vac, 60 Hz	<b>ENVIRONMENTAL CONDITIONS</b>	25deg.C, 63%RH, 991hPa
<b>TESTED BY</b>	Long Chen		

CHANNEL	CHANNEL FREQUENCY (MHz)	PEAK POWER OUTPUT (mW)	PEAK POWER OUTPUT (dBm)	PEAK POWER LIMIT (dBm)	PASS / FAIL
1	2412	68.865	18.38	30	PASS
6	2437	68.391	18.35	30	PASS
11	2462	68.707	18.37	30	PASS

##### 802.11g OFDM MODULATION:

<b>MODULATION TYPE</b>	BPSK	<b>TRANSFER RATE</b>	6Mbps
<b>INPUT POWER (SYSTEM)</b>	120Vac, 60 Hz	<b>ENVIRONMENTAL CONDITIONS</b>	25deg.C, 63%RH, 991hPa
<b>TESTED BY</b>	Long Chen		

CHANNEL	CHANNEL FREQUENCY (MHz)	PEAK POWER OUTPUT (mW)	PEAK POWER OUTPUT (dBm)	PEAK POWER LIMIT (dBm)	PASS / FAIL
1	2412	75.336	18.77	30	PASS
6	2437	74.989	18.75	30	PASS
11	2462	75.162	18.76	30	PASS



**DRAFT 802.11n (20MHz) OFDM MODULATION: DUAL TX:**

<b>MODULATION TYPE</b>	BPSK	<b>TRANSFER RATE</b>	13Mbps
<b>INPUT POWER (SYSTEM)</b>	120Vac, 60 Hz	<b>ENVIRONMENTAL CONDITIONS</b>	25deg.C, 63%RH, 991hPa
<b>TESTED BY</b>	Long Chen		

CHANNEL	CHANNEL FREQUENCY (MHz)	PEAK POWER OUTPUT (mW)		PEAK POWER OUTPUT (dBm)		TOTAL PEAK POWER (mW)	TOTAL PEAK POWER (dBm)	PEAK POWER LIMIT (dBm)	PASS / FAIL
		CHAIN 0	CHAIN 1	CHAIN 0	CHAIN 1				
1	2412	68.391	66.681	18.35	18.24	135.072	21.31	30	PASS
6	2437	68.077	67.143	18.33	18.27	135.220	21.31	30	PASS
11	2462	67.608	66.222	18.30	18.21	133.830	21.27	30	PASS

**DRAFT 802.11n (40MHz) OFDM MODULATION: DUAL TX:**

<b>MODULATION TYPE</b>	BPSK	<b>TRANSFER RATE</b>	27Mbps
<b>INPUT POWER (SYSTEM)</b>	120Vac, 60 Hz	<b>ENVIRONMENTAL CONDITIONS</b>	25deg.C, 63%RH, 991hPa
<b>TESTED BY</b>	Long Chen		

CHANNEL	CHANNEL FREQUENCY (MHz)	PEAK POWER OUTPUT (mW)		PEAK POWER OUTPUT (dBm)		TOTAL PEAK POWER (mW)	TOTAL PEAK POWER (dBm)	PEAK POWER LIMIT (dBm)	PASS / FAIL
		CHAIN 0	CHAIN 1	CHAIN 0	CHAIN 1				
1	2422	66.681	68.865	18.24	18.38	135.546	21.32	30	PASS
4	2437	67.453	68.234	18.29	18.34	135.687	21.33	30	PASS
7	2452	67.608	67.608	18.30	18.30	135.217	21.31	30	PASS



## 4.5 POWER SPECTRAL DENSITY MEASUREMENT

### 4.5.1 LIMITS OF POWER SPECTRAL DENSITY MEASUREMENT

The Maximum of Power Spectral Density Measurement is 8dBm.

### 4.5.2 TEST INSTRUMENTS

DESCRIPTION & MANUFACTURER	MODEL NO.	SERIAL NO.	CALIBRATED UNTIL
R&S SPECTRUM ANALYZER	FSEK30	100049	Aug. 14, 2006

**NOTE:** The calibration interval of the above test instruments is 12 months and the calibrations are traceable to NML/ROC and NIST/USA.

### 4.5.3 TEST PROCEDURE

The transmitter output was connected to the spectrum analyzer through an attenuator, the bandwidth of the fundamental frequency was measured with the spectrum analyzer using 3kHz RBW and 30kHz VBW, set sweep time = span/3kHz. The power spectral density was measured and recorded.

The sweep time is allowed to be longer than span/3kHz for a full response of the mixer in the spectrum analyzer.

### 4.5.4 DEVIATION FROM TEST STANDARD

No deviation

#### 4.5.5 TEST SETUP

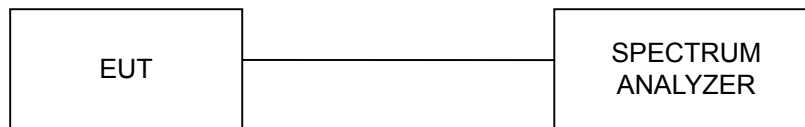

#### 4.5.6 EUT OPERATING CONDITION

Same as Item 4.3.6

### 4.5.7 TEST RESULTS

#### 802.11b DSSS MODULATION:

<b>MODULATION TYPE</b>	DBPSK	<b>TRANSFER RATE</b>	1Mbps
<b>INPUT POWER (SYSTEM)</b>	120Vac, 60 Hz	<b>ENVIRONMENTAL CONDITIONS</b>	25deg.C, 63%RH, 991hPa
<b>TESTED BY</b>	Long Chen		

CHANNEL	CHANNEL FREQUENCY (MHz )	RF POWER LEVEL IN 3kHz BW (dBm)	MAXIMUM LIMIT (dBm)	PASS / FAIL
1	2412	-8.04	8	PASS
6	2437	-8.09	8	PASS
11	2462	-8.05	8	PASS

#### CH 1

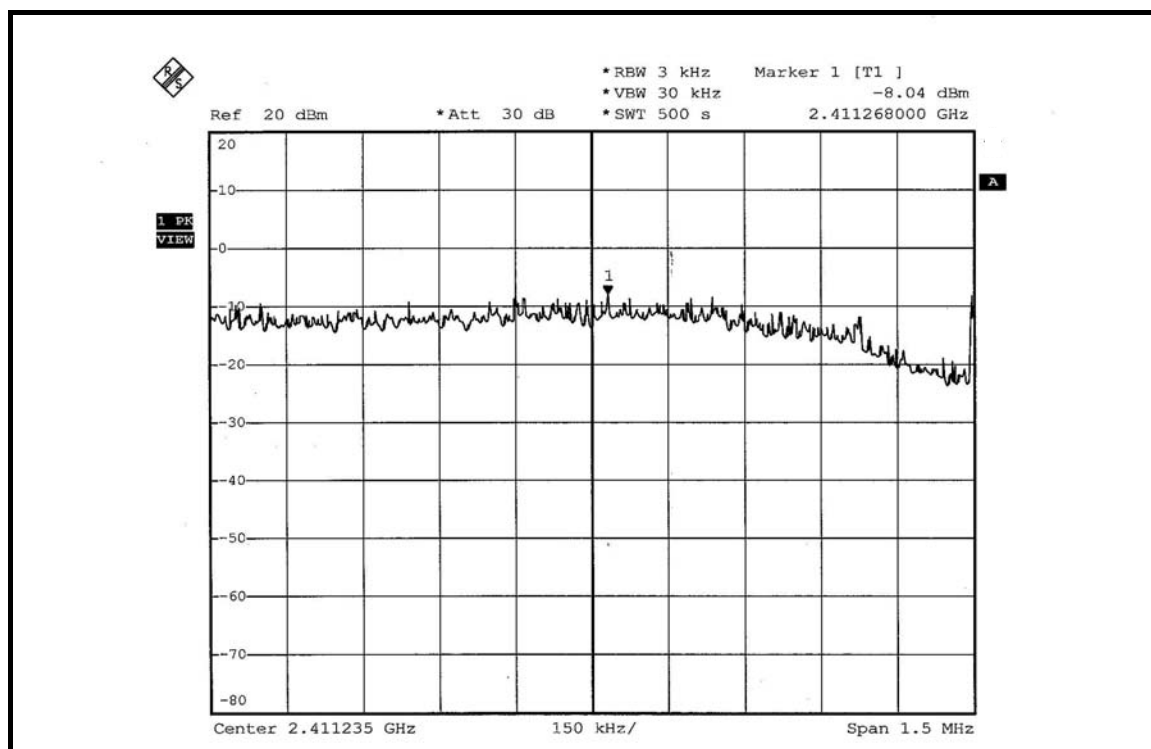



CH 6

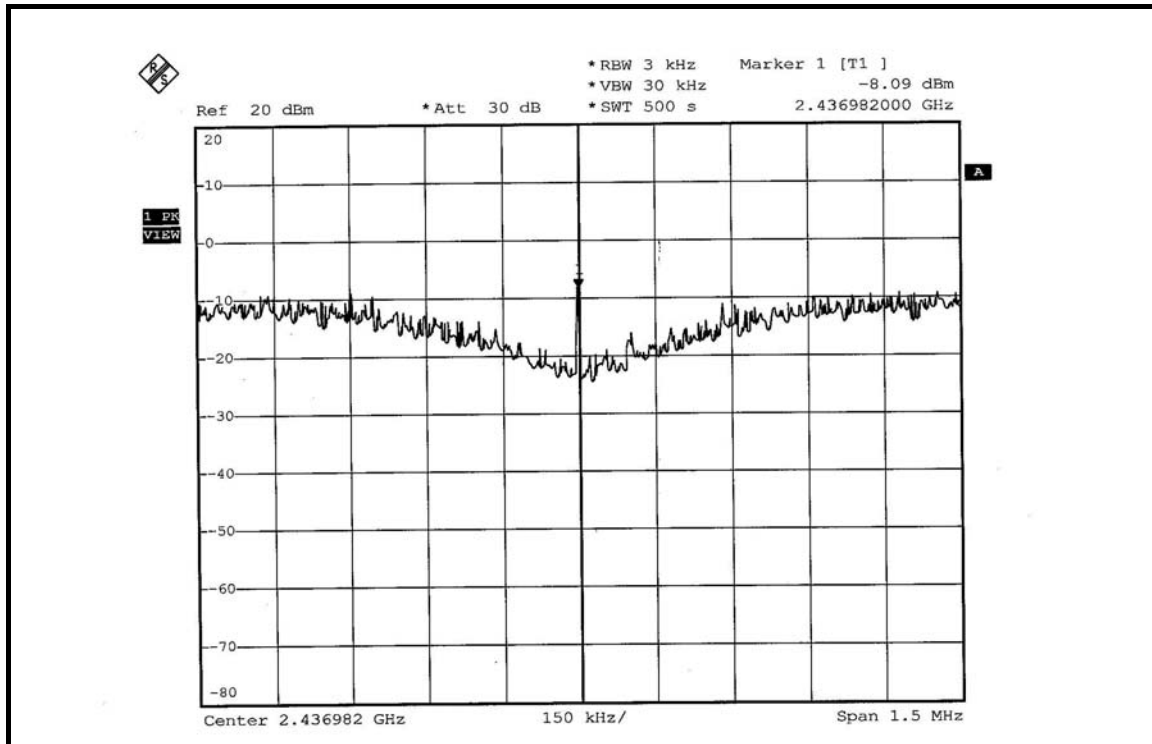

CH 11

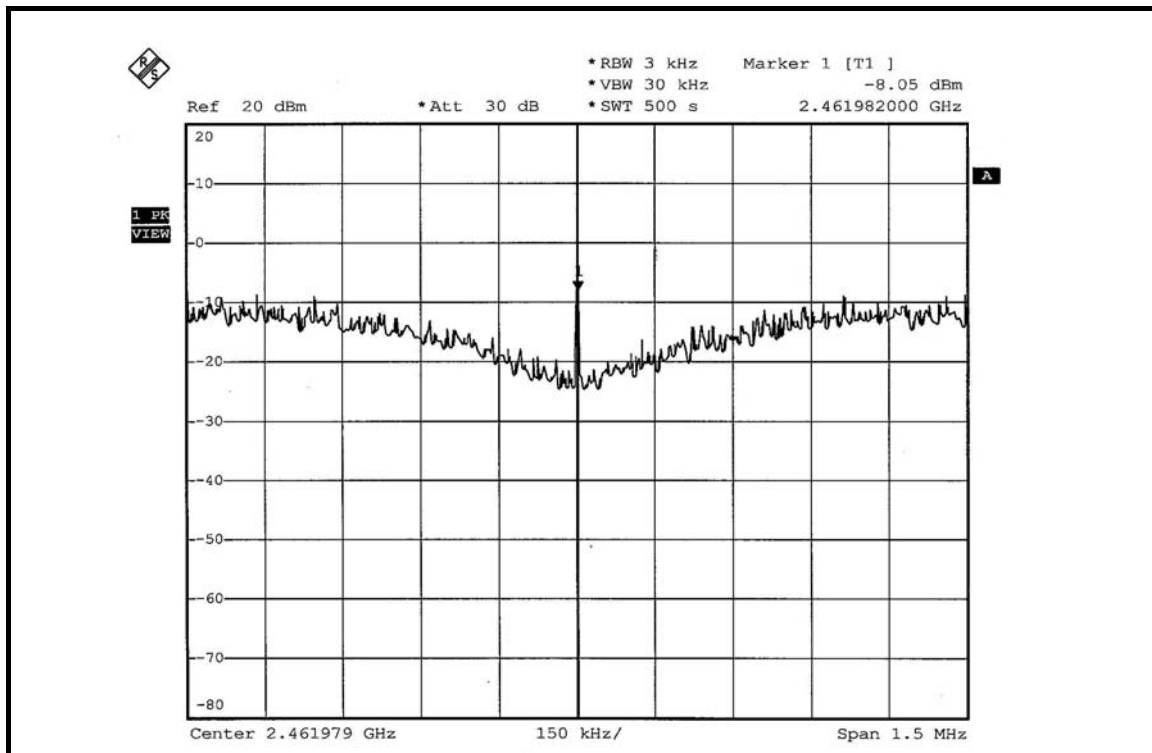

### 802.11g OFDM MODULATION:

<b>MODULATION TYPE</b>	BPSK	<b>TRANSFER RATE</b>	6Mbps
<b>INPUT POWER (SYSTEM)</b>	120Vac, 60 Hz	<b>ENVIRONMENTAL CONDITIONS</b>	25deg.C, 63%RH, 991hPa
<b>TESTED BY</b>	Long Chen		

CHANNEL	CHANNEL FREQUENCY (MHz)	RF POWER LEVEL IN 3kHz BW (dBm)	MAXIMUM LIMIT (dBm)	PASS / FAIL
1	2412	-12.27	8	PASS
6	2437	-12.23	8	PASS
11	2462	-12.21	8	PASS

### CH 1

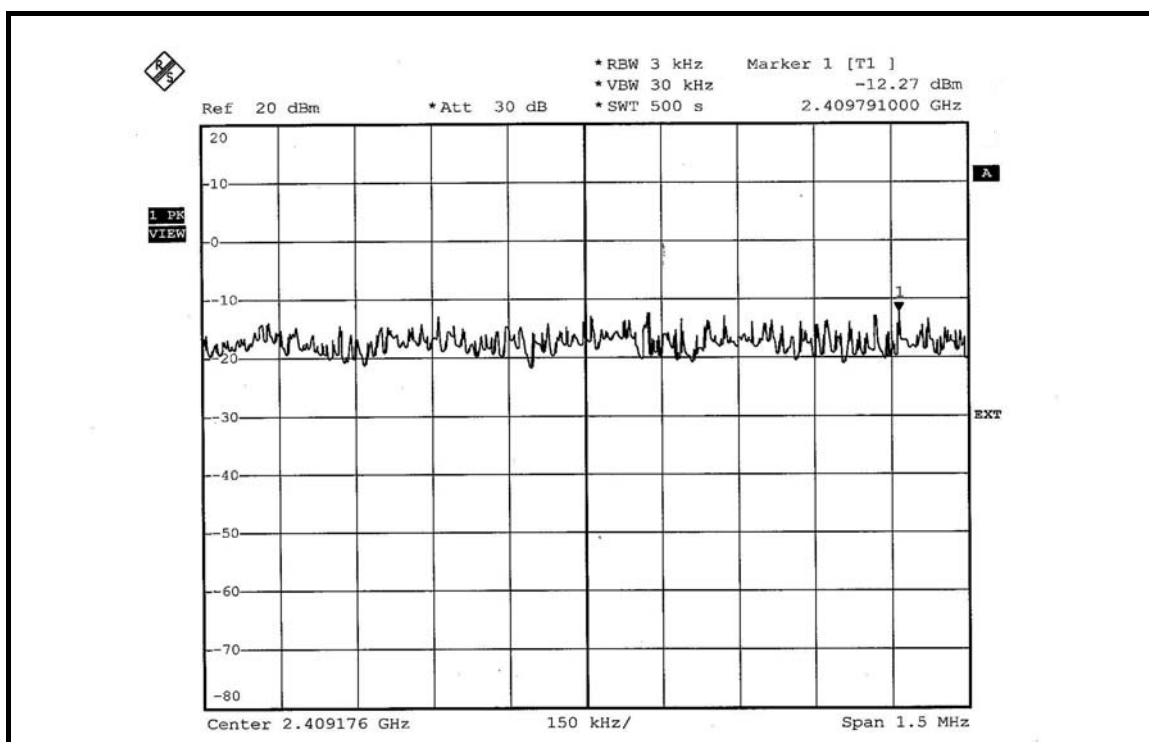

CH 6

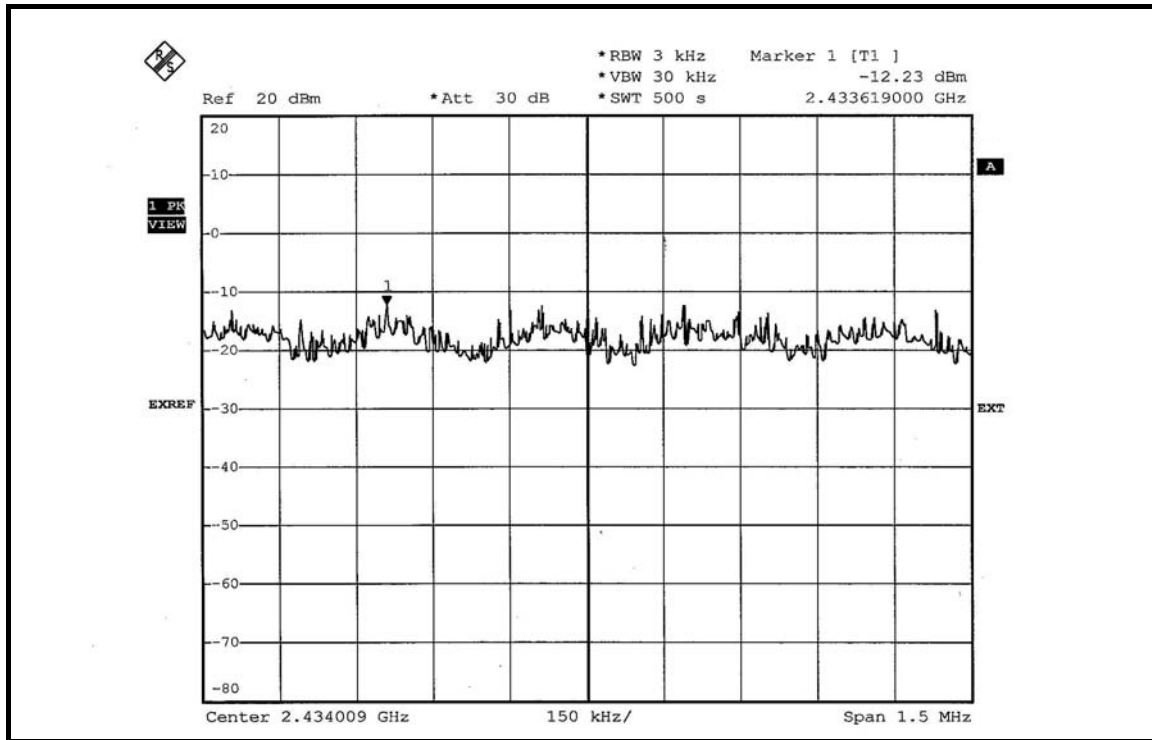

CH 11

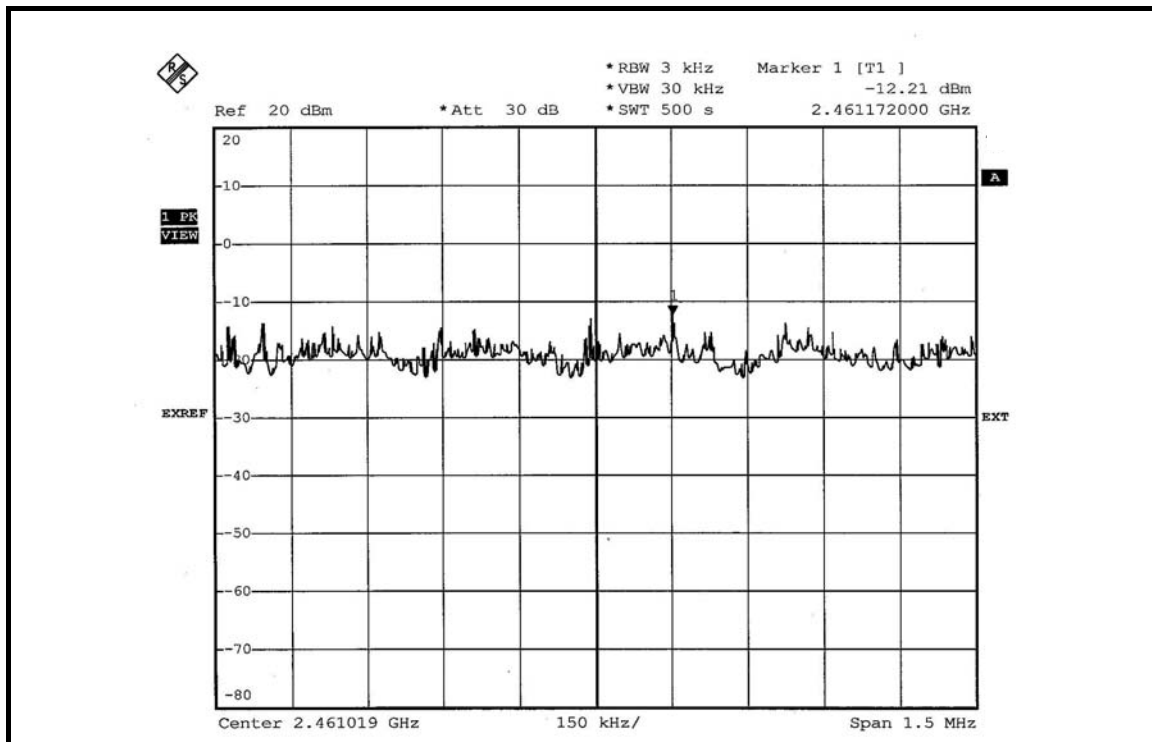

### DRAFT 802.11n (20MHz) OFDM MODULATION: DUAL TX:

<b>MODULATION TYPE</b>	BPSK	<b>TRANSFER RATE</b>	13Mbps
<b>INPUT POWER (SYSTEM)</b>	120Vac, 60 Hz	<b>ENVIRONMENTAL CONDITIONS</b>	25deg.C, 63%RH, 991hPa
<b>TESTED BY</b>	Long Chen		

CHANNEL	CHANNEL FREQUENCY (MHz)	RF POWER LEVEL IN 3kHz BW (mW)		RF POWER LEVEL IN 3kHz BW (dBm)		TOTAL POWER DENSITY (mW)	TOTAL POWER DENSITY (dBm)	MAX. LIMIT (dBm)	PASS / FAIL
		CHAIN 0	CHAIN 1	CHAIN 0	CHAIN 1				
1	2412	0.058	0.053	-12.38	-12.73	0.111	-9.54	8	PASS
6	2437	0.059	0.057	-12.32	-12.43	0.116	-9.36	8	PASS
11	2462	0.058	0.053	-12.38	-12.76	0.111	-9.56	8	PASS

### FOR CHAIN 0: CH 1

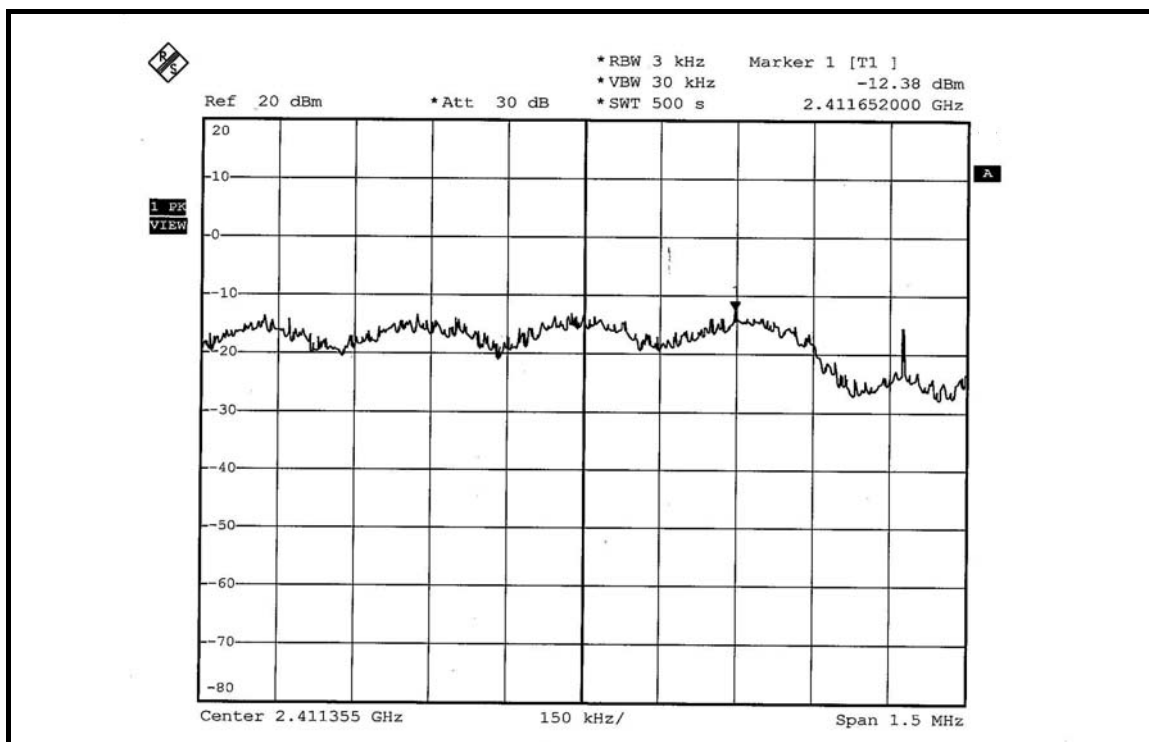

CH 6

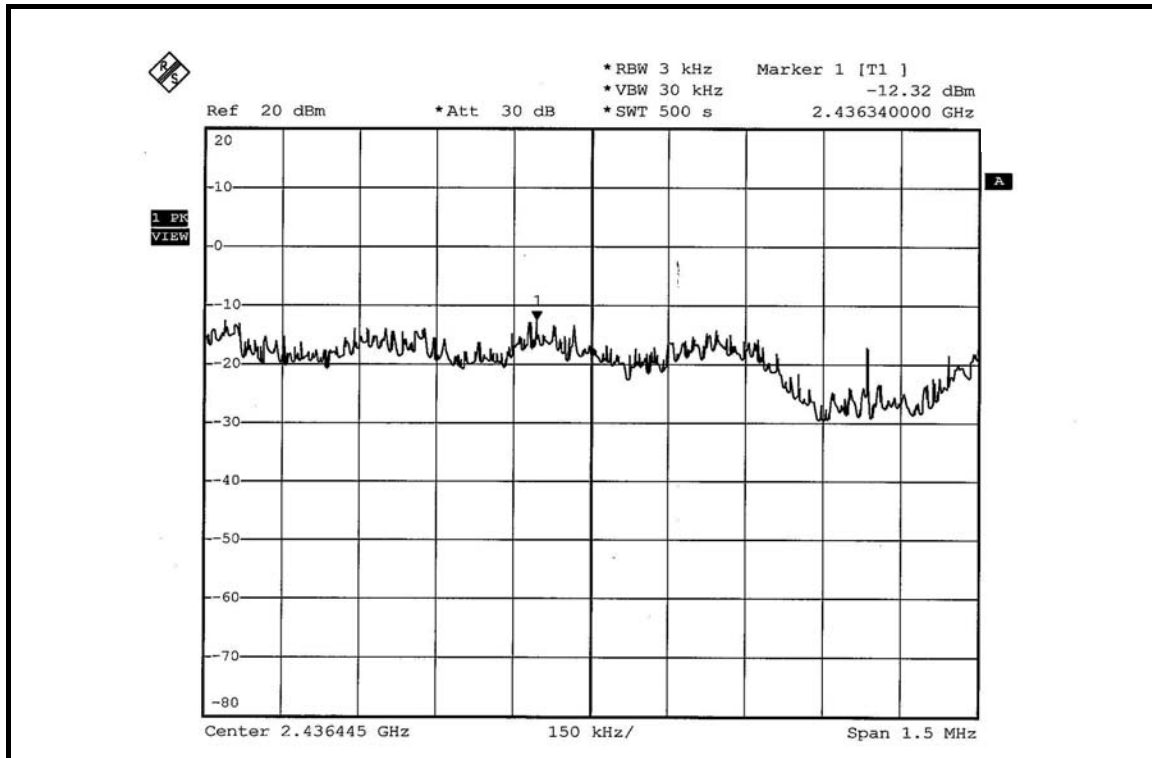

CH 11

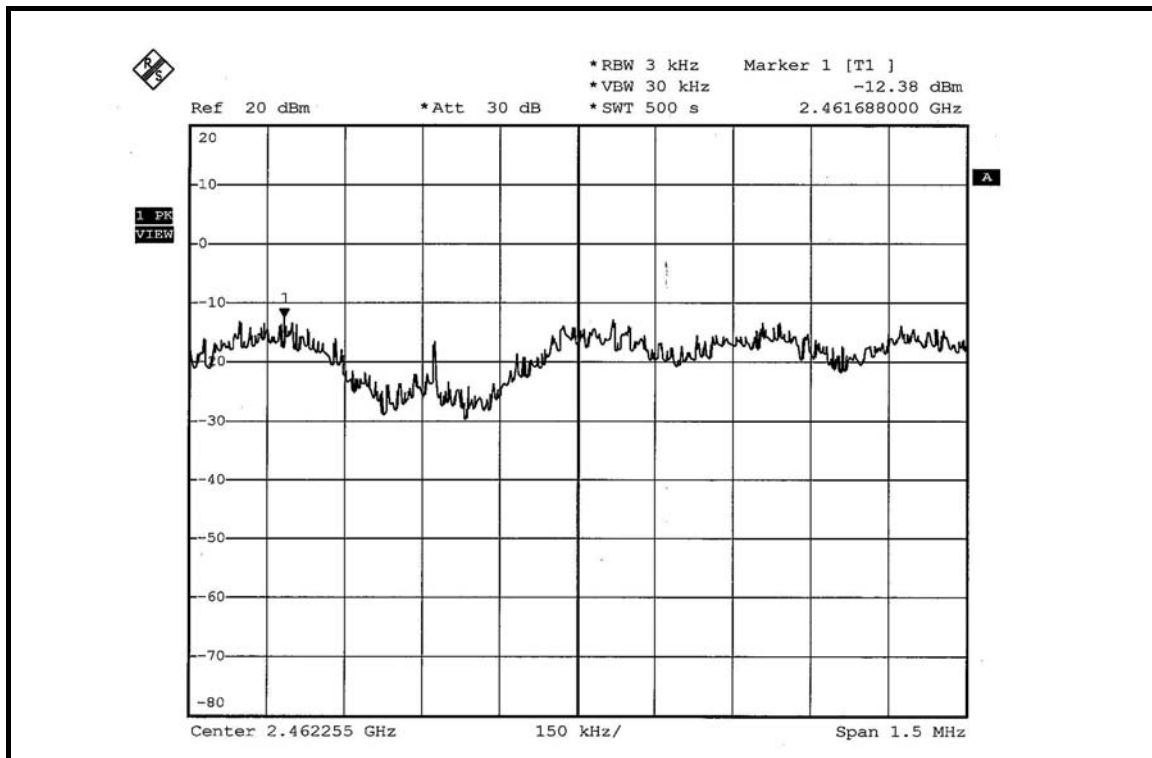

FOR CHAIN 1: CH 1

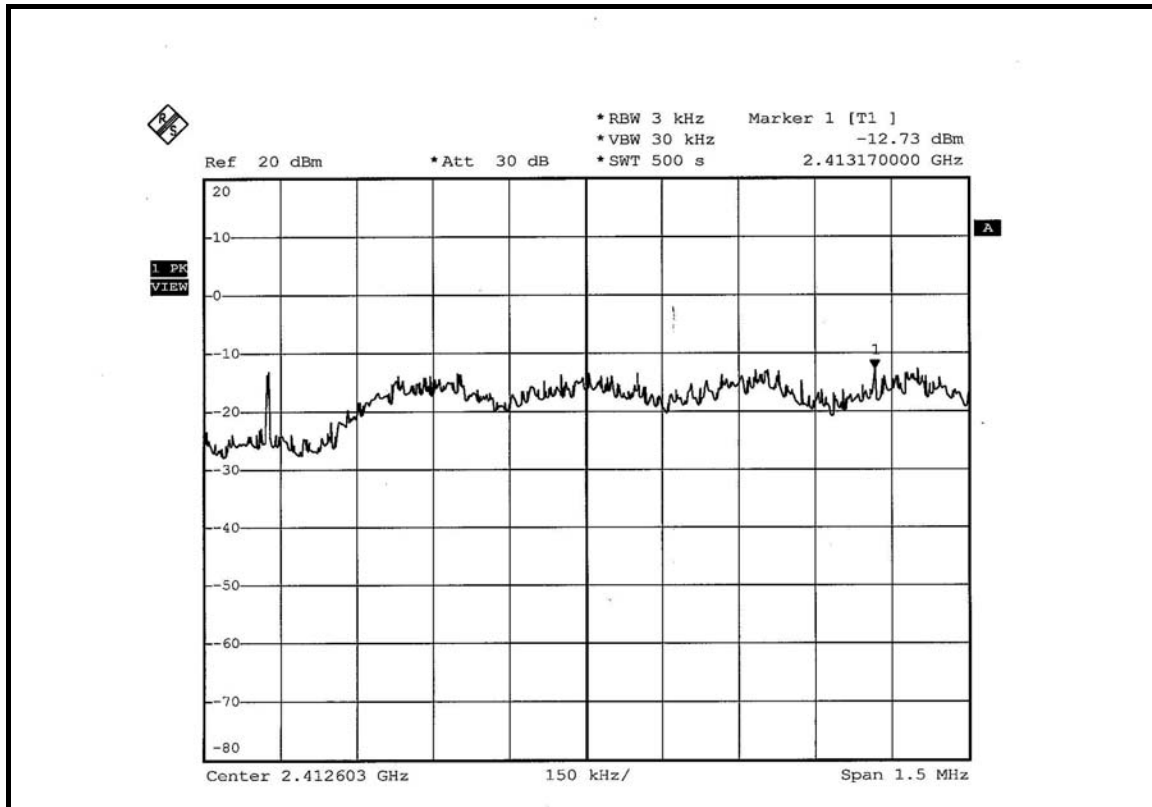

CH 6

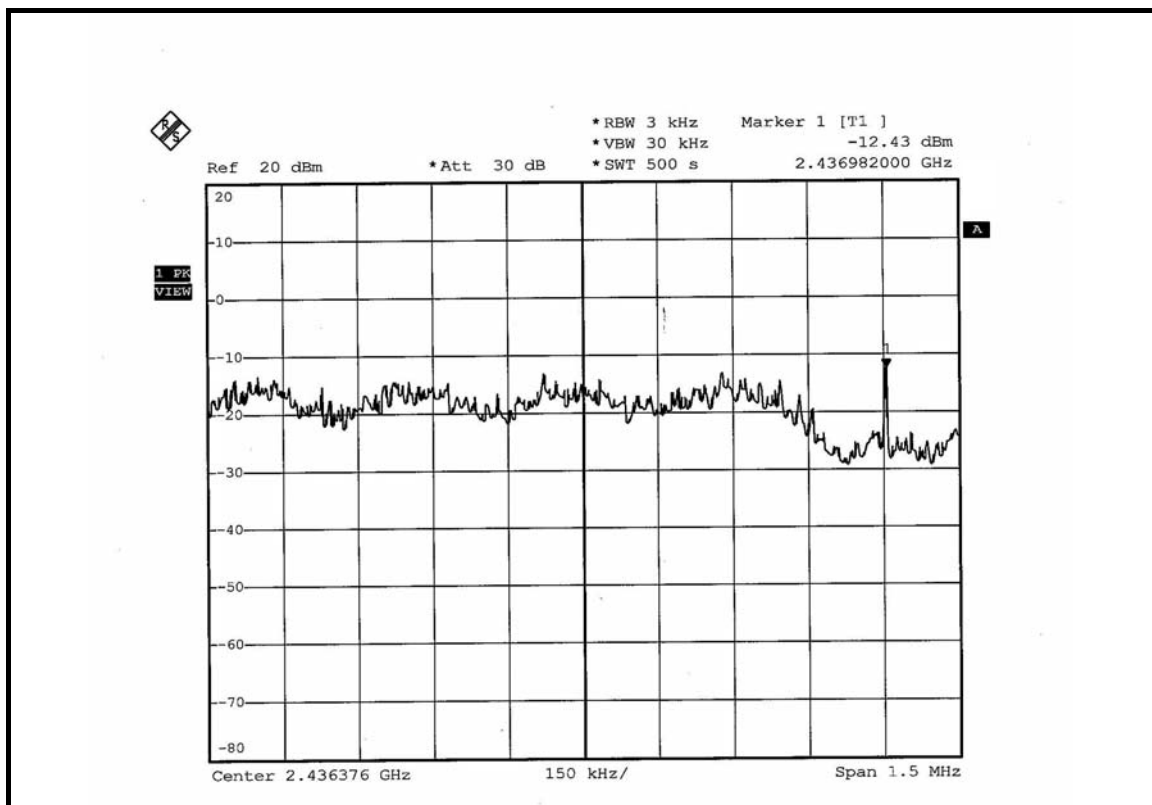

CH 11

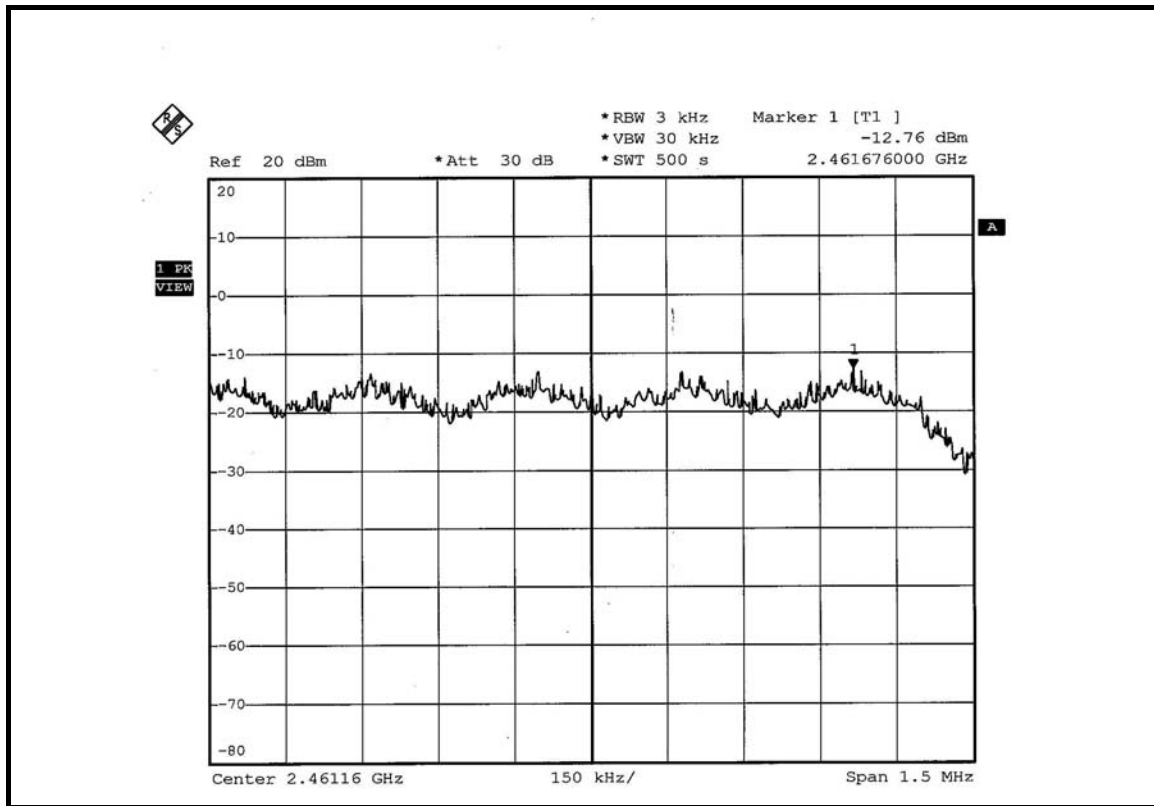



**DRAFT 802.11n (40MHz) OFDM MODULATION: DUAL TX:**

<b>MODULATION TYPE</b>	BPSK	<b>TRANSFER RATE</b>	27Mbps
<b>INPUT POWER (SYSTEM)</b>	120Vac, 60 Hz	<b>ENVIRONMENTAL CONDITIONS</b>	25deg.C, 63%RH, 991hPa
<b>TESTED BY</b>	Long Chen		

CHANNEL	CHANNEL FREQUENCY (MHz)	RF POWER LEVEL IN 3kHz BW (mW)		RF POWER LEVEL IN 3kHz BW (dBm)		TOTAL POWER DENSITY (mW)	TOTAL POWER DENSITY (dBm)	MAX. LIMIT (dBm)	PASS / FAIL
		CHAIN 0	CHAIN 1	CHAIN 0	CHAIN 1				
1	2412	0.025	0.027	-15.95	-15.62	0.053	-12.77	8	PASS
6	2437	0.026	0.027	-15.81	-15.74	0.053	-12.76	8	PASS
11	2462	0.025	0.025	-16.01	-15.98	0.050	-12.98	8	PASS

**FOR CHAIN 0: CH 1**

