

FCC TEST REPORT

REPORT NO.: RF930303R01B

MODEL NO.: P-520r

RECEIVED: Aug. 04, 2006

TESTED: Aug. 04 ~ Aug. 11, 2006

ISSUED: Aug. 15, 2006

APPLICANT: Gemtek Technology Co., Ltd.

ADDRESS: No.1, Jen Ai Road, Hsinchu Industrial Park,
Hukou Hsinchu, Taiwan, R.O.C. 303

ISSUED BY: Advance Data Technology Corporation

LAB ADDRESS: No. 47, 14th Ling, Chia Pau Tsuen, Lin Kou
Hsiang 244, Taipei Hsien, Taiwan, R.O.C.

TEST LOCATION: No. 19, Hwa Ya 2nd Rd., Wen Hwa Tsuen, Kwei
Shan Hsiang, Taoyuan Hsien 333, Taiwan,
R.O.C.

This test report consists of 37 pages in total. It may be duplicated completely for legal use with the approval of the applicant. It should not be reproduced except in full, without the written approval of our laboratory. The client should not use it to claim product endorsement by CNLA, A2LA or any government agencies. The test results in the report only apply to the tested sample.





Table of Contents

1	CERTIFICATION	3
2	SUMMARY OF TEST RESULTS	4
2.1	MEASUREMENT UNCERTAINTY	4
3	GENERAL INFORMATION.....	5
3.1	GENERAL DESCRIPTION OF EUT.....	5
3.2	DESCRIPTION OF TEST MODES.....	6
3.2.1	CONFIGURATION OF SYSTEM UNDER TEST	6
3.2.2	TEST MODE APPLICABILITY AND TESTED CHANNEL DETAIL	8
3.3	GENERAL DESCRIPTION OF APPLIED STANDARDS.....	9
3.4	DESCRIPTION OF SUPPORT UNITS.....	9
4	TEST TYPES AND RESULTS	10
4.1	CONDUCTED EMISSION MEASUREMENT	10
4.1.1	LIMITS OF CONDUCTED EMISSION MEASUREMENT	10
4.1.2	TEST INSTRUMENTS	10
4.1.3	TEST PROCEDURES.....	11
4.1.4	DEVIATION FROM TEST STANDARD	11
4.1.5	TEST SETUP	12
4.1.6	EUT OPERATING CONDITIONS.....	12
4.1.7	TEST RESULTS (A)	13
4.1.8	TEST RESULTS (B)	19
4.2	RADIATED EMISSION MEASUREMENT	25
4.2.1	LIMITS OF RADIATED EMISSION MEASUREMENT	25
4.2.2	TEST INSTRUMENTS	26
4.2.3	TEST PROCEDURES.....	27
4.2.4	DEVIATION FROM TEST STANDARD	27
4.2.5	TEST SETUP	28
4.2.6	EUT OPERATING CONDITIONS.....	28
4.2.7	TEST RESULTS (A)	29
4.2.8	TEST RESULTS (B)	30
4.2.9	TEST RESULTS (A)	31
5	INFORMATION ON THE TESTING LABORATORIES	35
	APPENDIX-A	A-1



1 CERTIFICATION

PRODUCT : 54Mb Operator Access Point
MODEL NO.: P-520r
BRAND: BROWAN
APPLICANT : Gemtek Technology Co., Ltd.
TESTED: Aug. 04 ~ Aug. 11, 2006
TEST SAMPLE: ENGINEERING SAMPLE
STANDARDS : FCC Part 15, Subpart C (Section 15.247),
ANSI C63.4-2003

The above equipment have been tested by **Advance Data Technology Corporation**, and found compliance with the requirement of the above standards. The test record, data evaluation & Equipment Under Test (EUT) configurations represented herein are true and accurate accounts of the measurements of the sample's EMC characteristics under the conditions specified in this report.

PREPARED BY : Peggy Chen , **DATE:** Aug. 15, 2006
Peggy Chen

TECHNICAL ACCEPTANCE : Long Chen , **DATE:** Aug. 15, 2006
Responsible for RF Long Chen

APPROVED BY : Gary Chang , **DATE:** Aug. 15, 2006
Gary Chang / Supervisor

2 SUMMARY OF TEST RESULTS

The EUT has been tested according to the following specifications:

APPLIED STANDARD: FCC Part 15, Subpart C			
Standard Section	Test Type and Limit	Result	REMARK
15.207	AC Power Conducted Emission	PASS	Meet the requirement of limit. Minimum passing margin is -16.06dB at 0.175MHz.
15.247(d)	Transmitter Radiated Emissions Limit: Table 15.209	PASS	Meet the requirement of limit. Minimum passing margin is -1.90dB at 500.42MHz.

2.1 MEASUREMENT UNCERTAINTY

Where relevant, the following measurement uncertainty levels have been estimated for tests performed on the EUT as specified in CISPR 16-4:

Measurement	Frequency	Uncertainty
Conducted emissions	9kHz~30MHz	2.44 dB
Radiated emissions	30MHz ~ 200MHz (Horizontal)	3.47 dB
	30MHz ~ 200MHz (Vertical)	3.64 dB
	200MHz ~1000MHz (Horizontal)	3.65 dB
	200MHz ~1000MHz (Vertical)	3.64 dB
	1GHz ~ 18GHz	2.26 dB
	18GHz ~ 40GHz	1.94 dB

This uncertainty represents an expanded uncertainty expressed at approximately the 95% confidence level using a coverage factor of k=2.



3 GENERAL INFORMATION

3.1 GENERAL DESCRIPTION OF EUT

PRODUCT	54Mb Operator Access Point
MODEL NO.	P-520r
FCC ID	MXF-AP930301G
POWER SUPPLY	5Vdc from AC Adapter 48Vdc from POE
MODULATION TYPE	CCK, DQPSK, DBPSK for DSSS 64QAM, 16QAM, QPSK, BPSK for OFDM
MODULATION TECHNOLOGY	DSSS, OFDM
TRANSFER RATE	802.11b: 11/5.5/2/1Mbps 802.11g: 54/48/36/24/18/12/9/6Mbps
FREQUENCY RANGE	2412MHz ~ 2462MHz
NUMBER OF CHANNEL	11
MAXIMUM OUTPUT POWER	71.45mW
ANTENNA TYPE	Two integrated diversity antennas: 6dBi directional antenna vertical polarizaion & 4dBi horizontal polarized antenna
I/O PORTS	RJ45
DATA CABLE	NA
ASSOCIATED DEVICES	NA

NOTE:

1. This report is issued as a supplementary report of RF930303R01. This report shall be used combined together with its original report.
2. This report is prepared for FCC class II permissive change. The differences are version of RoHS, components, layout and AC to DC power circuit (DC output voltage is the same as original test report), so we re-test conducted emission and radiated emission tests on Aug. 04 ~ Aug. 11, 2006.
3. RF output power is the same as the original test report.
4. The EUT was powered by the following adapter:

Brand:	BALANCE ELECTRONICS CO., LTD.
Model:	GPSA-0500255
Input:	100-240Vac, 50/60Hz, 0.5A
Output:	5Vdc, 2A
Power Cord:	DC: 1.8m shielded cable without core

5. The POE is for support unit only.
6. The EUT, operates in the 2.4GHz frequency range, lets you connect IEEE 802.11g or IEEE 802.11b devices to the network. With its high-speed data transmissions of up to 54Mbps.
7. The above EUT information was declared by the manufacturer and for more detailed features description, please refer to the manufacturer's specifications or User's Manual.

3.2 DESCRIPTION OF TEST MODES

Eleven channels are provided to this EUT for normal mode.

Channel	Frequency	Channel	Frequency
1	2412 MHz	7	2442 MHz
2	2417 MHz	8	2447 MHz
3	2422 MHz	9	2452 MHz
4	2427 MHz	10	2457 MHz
5	2432 MHz	11	2462 MHz
6	2437 MHz		

3.2.1 CONFIGURATION OF SYSTEM UNDER TEST

Test Mode A

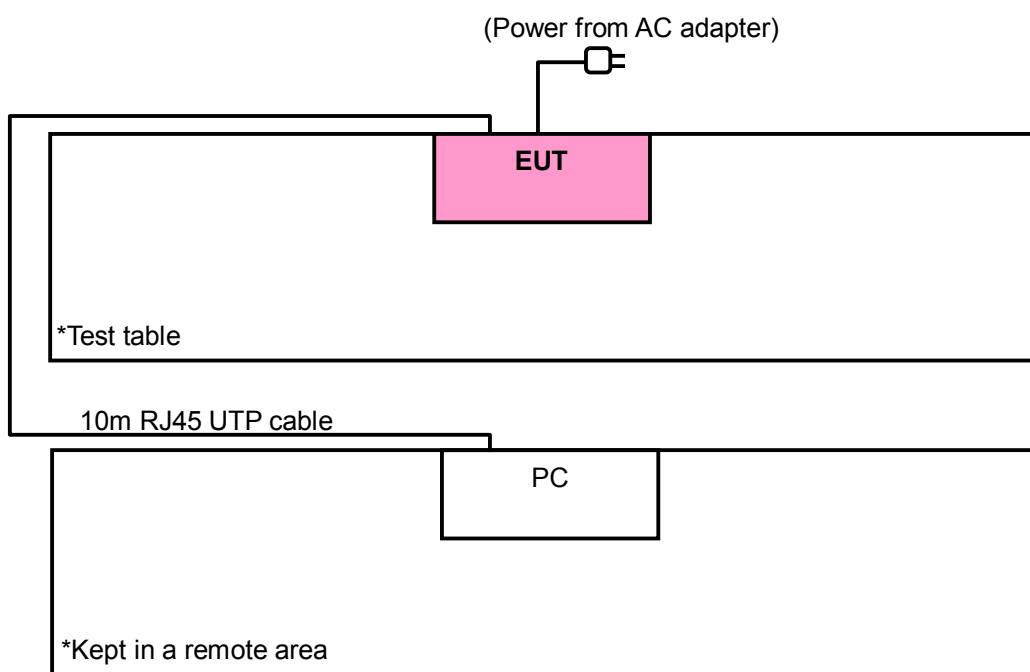

Test Mode B

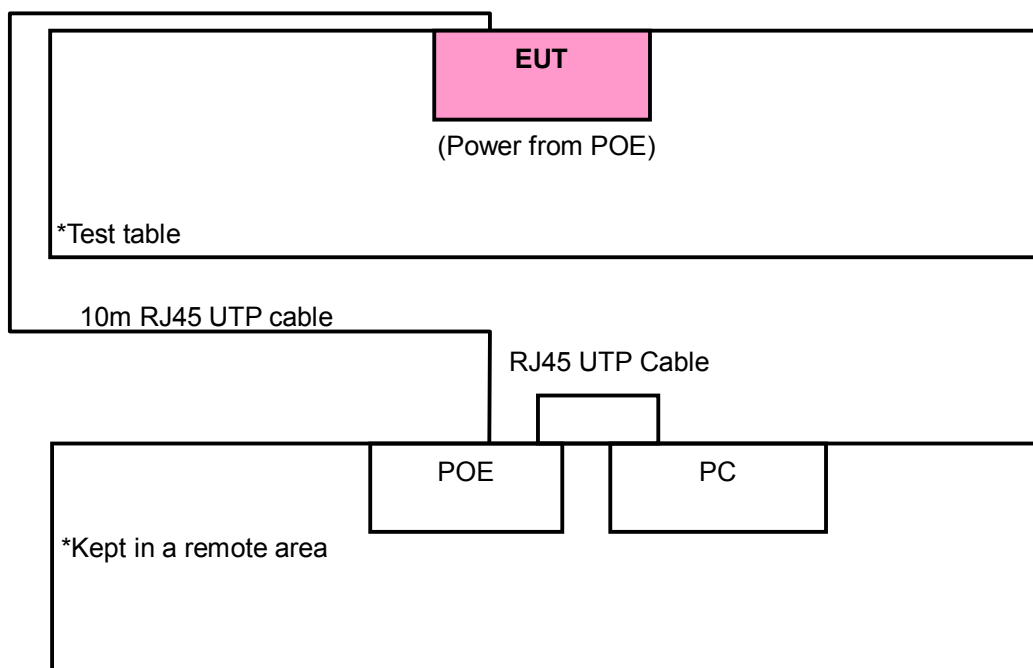

3.2.2 TEST MODE APPLICABILITY AND TESTED CHANNEL DETAIL

EUT CONFIGURE MODE	APPLICABLE TO			Description
	PLC	RE<1G	RE≥1G	
A	√	√	√	Power from AC Adapter
B	√	√	-	Power from POE

Where **PLC**: Power Line Conducted Emission **RE<1G**: Radiated Emission below 1GHz

RE≥1G: Radiated Emission above 1GHz

Power Line Conducted Emission Test:

- Pre-Scan has been conducted to determine the worst-case mode from all possible combinations between available modulations, data rates and antenna ports (if EUT with antenna diversity architecture).
- Following channel(s) was (were) selected for the final test as listed below.

EUT CONFIGURE MODE	MODE	AVAILABLE CHANNEL	TESTED CHANNEL	MODULATION TECHNOLOGY	MODULATION TYPE	DATA RATE (Mbps)
A	802.11g	1 to 11	1, 6, 11	OFDM	BPSK	6
B	802.11g	1 to 11	1, 6, 11	OFDM	BPSK	6

Radiated Emission Test (Below 1 GHz):

- Pre-Scan has been conducted to determine the worst-case mode from all possible combinations between available modulations, data rates and antenna ports (if EUT with antenna diversity architecture).
- Following channel(s) was (were) selected for the final test as listed below.

EUT CONFIGURE MODE	MODE	AVAILABLE CHANNEL	TESTED CHANNEL	MODULATION TECHNOLOGY	MODULATION TYPE	DATA RATE (Mbps)
A	802.11g	1 to 11	11	OFDM	BPSK	6
B	802.11g	1 to 11	11	OFDM	BPSK	6

Radiated Emission Test (Above 1 GHz):

- Pre-Scan has been conducted to determine the worst-case mode from all possible combinations between available modulations, data rates and antenna ports (if EUT with antenna diversity architecture).
- Following channel(s) was (were) selected for the final test as listed below.

EUT CONFIGURE MODE	MODE	AVAILABLE CHANNEL	TESTED CHANNEL	MODULATION TECHNOLOGY	MODULATION TYPE	DATA RATE (Mbps)
A	802.11b	1 to 11	1, 11	DSSS	CCK	11
A	802.11g	1 to 11	1, 11	OFDM	BPSK	6



3.3 GENERAL DESCRIPTION OF APPLIED STANDARDS

The EUT is a RF product. According to the specifications of the manufacturer, it must comply with the requirements of the following standards:

FCC Part 15, Subpart C. (15.247)
ANSI C63.4-2003

All test items have been performed and recorded as per the above standards.

NOTE: The EUT is also considered as a kind of computer peripheral, because the connection to computer is necessary for typical use. It has been verified to comply with the requirements of FCC Part 15, Subpart B, Class B (DoC). The test report has been issued separately.

3.4 DESCRIPTION OF SUPPORT UNITS

The EUT has been tested as an independent unit together with other necessary accessories or support units. The following support units or accessories were used to form a representative test configuration during the tests.

NO.	PRODUCT	BRAND	MODEL NO.	SERIAL NO.	FCC ID
1	PC	MSI	Hetis 865G Giga	3AS0119572	FCC DoC Approved
2	POE	Power Dsine	PowerDsine 3001	NA	FCC DoC Approved

NO.	SIGNAL CABLE DESCRIPTION OF THE ABOVE SUPPORT UNITS
1	NA

NOTE:

1. All power cords of the above support units are non shielded (1.8m).
2. Item 1 & 2 acted as communication partners to transfer data.
3. Item 2 was provided by client and only for test result B.

4 TEST TYPES AND RESULTS

4.1 CONDUCTED EMISSION MEASUREMENT

4.1.1 LIMITS OF CONDUCTED EMISSION MEASUREMENT

FREQUENCY OF EMISSION (MHz)	CONDUCTED LIMIT (dB μ V)	
	Quasi-peak	Average
0.15-0.5	66 to 56	56 to 46
0.5-5	56	46
5-30	60	50

- NOTE:**
1. The lower limit shall apply at the transition frequencies.
 2. The limit decreases in line with the logarithm of the frequency in the range of 0.15 to 0.50 MHz.
 3. All emanations from a class A/B digital device or system, including any network of conductors and apparatus connected thereto, shall not exceed the level of field strengths specified above.

4.1.2 TEST INSTRUMENTS

DESCRIPTION & MANUFACTURER	MODEL NO.	SERIAL NO.	CALIBRATED UNTIL
Test Receiver ROHDE & SCHWARZ	ESCS30	100288	Nov. 02, 2006
RF signal cable Woken	5D-FB	Cable-HYCO3-01	Jan. 06, 2007
LISN ROHDE & SCHWARZ	ESH2-Z5	100100	Jan. 09, 2007
LISN ROHDE & SCHWARZ	ESH3-Z5	100311	Jan. 22, 2007
Software ADT	ADT_Cond_V3	NA	NA

- NOTE:**
1. The calibration interval of the above test instruments is 12 months and the calibrations are traceable to NML/ROC and NIST/USA.
 2. The test was performed in HwaYa Shielded Room 2.
 3. The VCCI Site Registration No. is C-2047.

4.1.3 TEST PROCEDURES

- a. The EUT was placed 0.4 meters from the conducting wall of the shielded room with EUT being connected to the power mains through a line impedance stabilization network (LISN). Other support units were connected to the power mains through another LISN. The two LISNs provide 50 ohm/ 50uH of coupling impedance for the measuring instrument.
- b. Both lines of the power mains connected to the EUT were checked for maximum conducted interference.
- c. The frequency range from 150kHz to 30MHz was searched. Emission levels under Limit - 20dB was not recorded.

4.1.4 DEVIATION FROM TEST STANDARD

No deviation

4.1.5 TEST SETUP

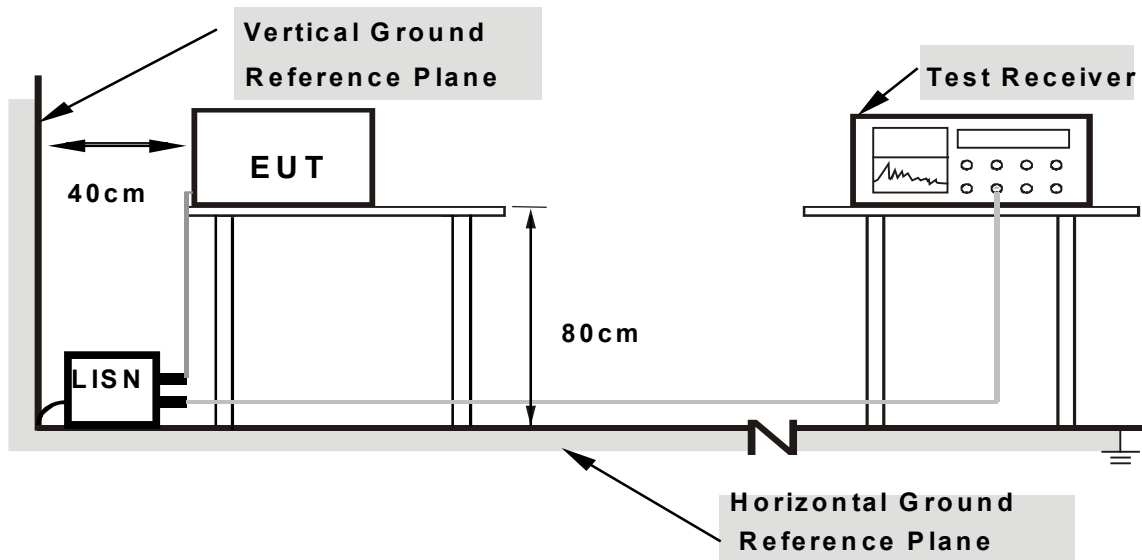

Note: 1. Support units were connected to second LISN.

2. Both of LISNs (AMN) are 80 cm from EUT and at least 80 cm from other units and other metal planes

For the actual test configuration, please refer to the related item – Photographs of the Test Configuration.

4.1.6 EUT OPERATING CONDITIONS

- a. The EUT connected with PC system via a RJ45 cable.
- b. The notebook system ran a test program (provided by manufacturer) to enable EUT under transmission condition continuously at specific channel frequency.

4.1.7 TEST RESULTS (A)

CONDUCTED WORST-CASE DATA

EUT TEST CONDITION		MEASUREMENT DETAIL	
CHANNEL	Channel 1	PHASE	Line 1
MODULATION TYPE	BPSK	6dB BANDWIDTH	9 kHz
TRANSFER RATE	6Mbps	INPUT POWER (SYSTEM)	120Vac, 60 Hz
ENVIRONMENTAL CONDITIONS	20deg. C, 60%RH, 991hPa	TESTED BY	Match Tsui

No	Freq. [MHz]	Corr. Factor [dB]	Reading Value [dB (uV)]		Emission Level [dB (uV)]		Limit [dB (uV)]		Margin (dB)	
			Q.P.	AV.	Q.P.	AV.	Q.P.	AV.	Q.P.	AV.
			1	0.206	0.10	39.57	-	39.67	-	63.37
2	0.275	0.10	35.76	-	35.86	-	60.97	50.97	-25.11	-
3	0.482	0.10	37.64	-	37.74	-	56.30	46.30	-18.56	-
4	0.552	0.10	35.56	-	35.66	-	56.00	46.00	-20.34	-
5	3.172	0.30	24.44	-	24.74	-	56.00	46.00	-31.26	-
6	21.168	0.65	36.87	-	37.52	-	60.00	50.00	-22.48	-

- REMARKS:**
1. Q.P. and AV. are abbreviations of quasi-peak and average individually.
 2. "-": The Quasi-peak reading value also meets average limit and measurement with the average detector is unnecessary.
 3. The emission levels of other frequencies were very low against the limit.
 4. Margin value = Emission level - Limit value
 5. Correction factor = Insertion loss + Cable loss
 6. Emission Level = Correction Factor + Reading Value.

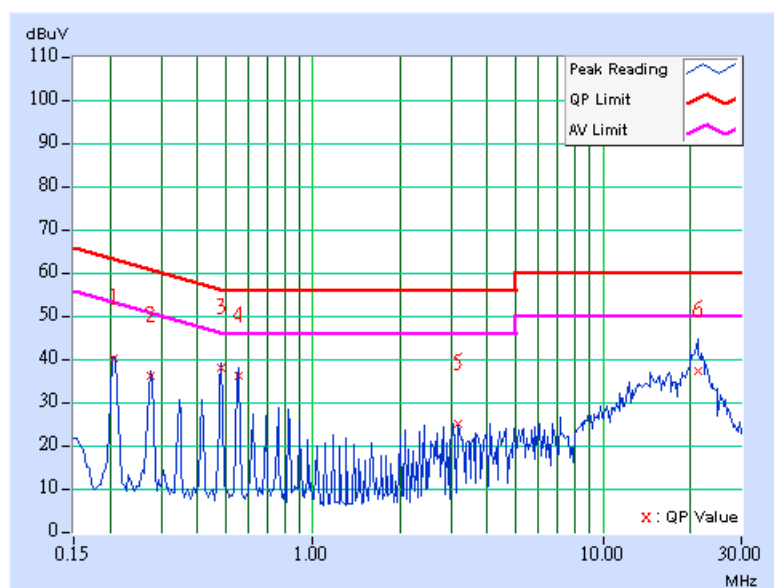

EUT TEST CONDITION		MEASUREMENT DETAIL	
CHANNEL	Channel 1	PHASE	Line 2
MODULATION TYPE	BPSK	6dB BANDWIDTH	9 kHz
TRANSFER RATE	6Mbps	INPUT POWER (SYSTEM)	120Vac, 60 Hz
ENVIRONMENTAL CONDITIONS	20deg. C, 60%RH, 991hPa	TESTED BY	Match Tsui

No	Freq. [MHz]	Corr. Factor [dB]	Reading Value [dB (uV)]		Emission Level [dB (uV)]		Limit [dB (uV)]		Margin (dB)	
			Q.P.	AV.	Q.P.	AV.	Q.P.	AV.	Q.P.	AV.
1	0.209	0.10	35.28	-	35.38	-	63.26	53.26	-27.88	-
2	0.275	0.10	30.76	-	30.86	-	60.97	50.97	-30.11	-
3	0.345	0.10	28.29	-	28.39	-	59.07	49.07	-30.68	-
4	0.482	0.11	30.19	-	30.30	-	56.30	46.30	-26.00	-
5	1.656	0.20	27.11	-	27.31	-	56.00	46.00	-28.69	-
6	20.969	0.61	38.31	-	38.92	-	60.00	50.00	-21.08	-

- REMARKS:**
1. Q.P. and AV. are abbreviations of quasi-peak and average individually.
 2. "-": The Quasi-peak reading value also meets average limit and measurement with the average detector is unnecessary.
 3. The emission levels of other frequencies were very low against the limit.
 4. Margin value = Emission level - Limit value
 5. Correction factor = Insertion loss + Cable loss
 6. Emission Level = Correction Factor + Reading Value.

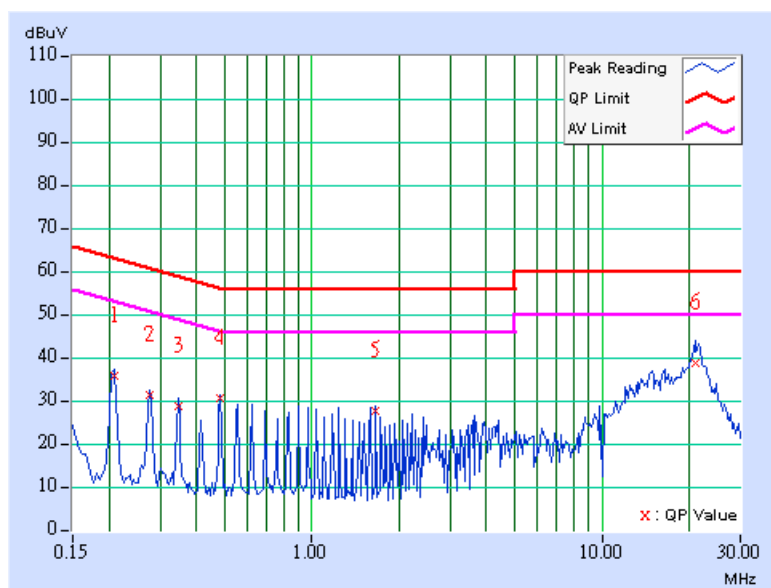

EUT TEST CONDITION		MEASUREMENT DETAIL	
CHANNEL	Channel 6	PHASE	Line 1
MODULATION TYPE	BPSK	6dB BANDWIDTH	9 kHz
TRANSFER RATE	6Mbps	INPUT POWER (SYSTEM)	120Vac, 60 Hz
ENVIRONMENTAL CONDITIONS	20deg. C, 60%RH, 991hPa	TESTED BY	Match Tsui

No	Freq. [MHz]	Corr. Factor [dB]	Reading Value [dB (uV)]		Emission Level [dB (uV)]		Limit [dB (uV)]		Margin (dB)	
			Q.P.	AV.	Q.P.	AV.	Q.P.	AV.	Q.P.	AV.
1	0.205	0.10	38.81	-	38.91	-	63.42	53.42	-24.51	-
2	0.275	0.10	35.76	-	35.86	-	60.97	50.97	-25.11	-
3	0.482	0.10	37.62	-	37.72	-	56.30	46.30	-18.58	-
4	0.552	0.10	35.41	-	35.51	-	56.00	46.00	-20.49	-
5	2.961	0.28	25.35	-	25.63	-	56.00	46.00	-30.37	-
6	20.871	0.62	38.49	-	39.11	-	60.00	50.00	-20.89	-

- REMARKS:**
1. Q.P. and AV. are abbreviations of quasi-peak and average individually.
 2. "-": The Quasi-peak reading value also meets average limit and measurement with the average detector is unnecessary.
 3. The emission levels of other frequencies were very low against the limit.
 4. Margin value = Emission level - Limit value
 5. Correction factor = Insertion loss + Cable loss
 6. Emission Level = Correction Factor + Reading Value.

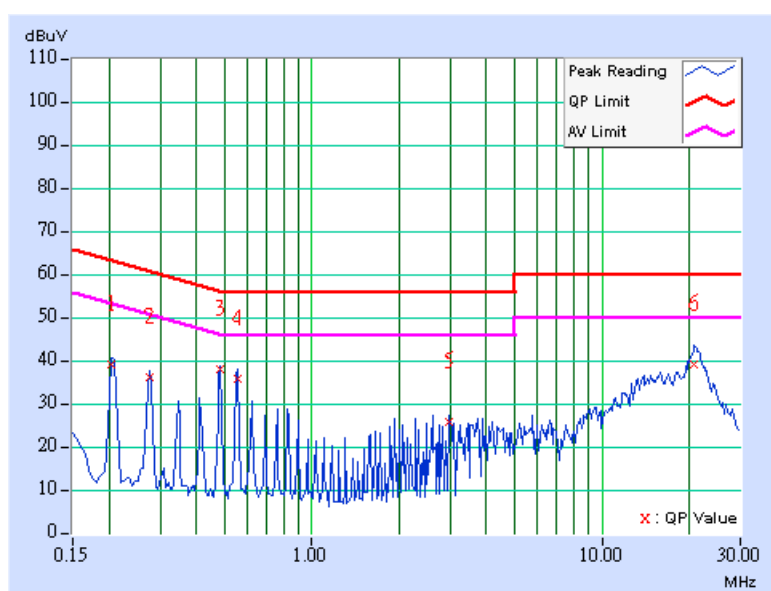

EUT TEST CONDITION		MEASUREMENT DETAIL	
CHANNEL	Channel 6	PHASE	Line 2
MODULATION TYPE	BPSK	6dB BANDWIDTH	9 kHz
TRANSFER RATE	6Mbps	INPUT POWER (SYSTEM)	120Vac, 60 Hz
ENVIRONMENTAL CONDITIONS	20deg. C, 60%RH, 991hPa	TESTED BY	Match Tsui

No	Freq. [MHz]	Corr. Factor [dB]	Reading Value [dB (uV)]		Emission Level [dB (uV)]		Limit [dB (uV)]		Margin (dB)	
			Q.P.	AV.	Q.P.	AV.	Q.P.	AV.	Q.P.	AV.
1	0.209	0.10	34.90	-	35.00	-	63.26	53.26	-28.26	-
2	0.275	0.10	30.68	-	30.78	-	60.97	50.97	-30.19	-
3	0.482	0.11	30.29	-	30.40	-	56.30	46.30	-25.90	-
4	1.172	0.20	26.61	-	26.81	-	56.00	46.00	-29.19	-
5	1.930	0.20	26.43	-	26.63	-	56.00	46.00	-29.37	-
6	20.883	0.61	37.81	-	38.42	-	60.00	50.00	-21.58	-

- REMARKS:**
1. Q.P. and AV. are abbreviations of quasi-peak and average individually.
 2. "-": The Quasi-peak reading value also meets average limit and measurement with the average detector is unnecessary.
 3. The emission levels of other frequencies were very low against the limit.
 4. Margin value = Emission level - Limit value
 5. Correction factor = Insertion loss + Cable loss
 6. Emission Level = Correction Factor + Reading Value.

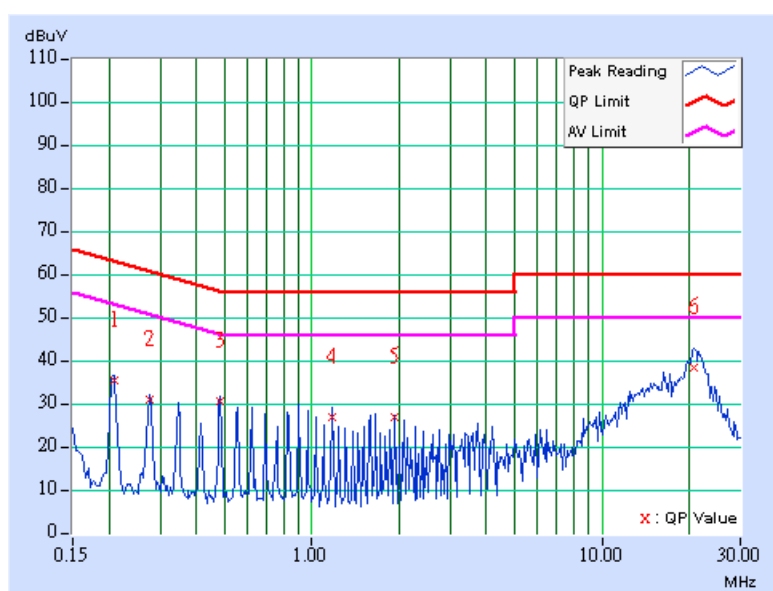

EUT TEST CONDITION		MEASUREMENT DETAIL	
CHANNEL	Channel 11	PHASE	Line 1
MODULATION TYPE	BPSK	6dB BANDWIDTH	9 kHz
TRANSFER RATE	6Mbps	INPUT POWER (SYSTEM)	120Vac, 60 Hz
ENVIRONMENTAL CONDITIONS	20deg. C, 60%RH, 991hPa	TESTED BY	Match Tsui

No	Freq. [MHz]	Corr. Factor [dB]	Reading Value [dB (uV)]		Emission Level [dB (uV)]		Limit [dB (uV)]		Margin (dB)	
			Q.P.	AV.	Q.P.	AV.	Q.P.	AV.	Q.P.	AV.
1	0.205	0.10	38.63	-	38.73	-	63.42	53.42	-24.69	-
2	0.275	0.10	35.33	-	35.43	-	60.97	50.97	-25.54	-
3	0.482	0.10	37.46	-	37.56	-	56.30	46.30	-18.74	-
4	0.552	0.10	34.99	-	35.09	-	56.00	46.00	-20.91	-
5	3.238	0.31	22.22	-	22.53	-	56.00	46.00	-33.47	-
6	20.859	0.62	37.72	-	38.34	-	60.00	50.00	-21.66	-

- REMARKS:**
1. Q.P. and AV. are abbreviations of quasi-peak and average individually.
 2. "-": The Quasi-peak reading value also meets average limit and measurement with the average detector is unnecessary.
 3. The emission levels of other frequencies were very low against the limit.
 4. Margin value = Emission level - Limit value
 5. Correction factor = Insertion loss + Cable loss
 6. Emission Level = Correction Factor + Reading Value.

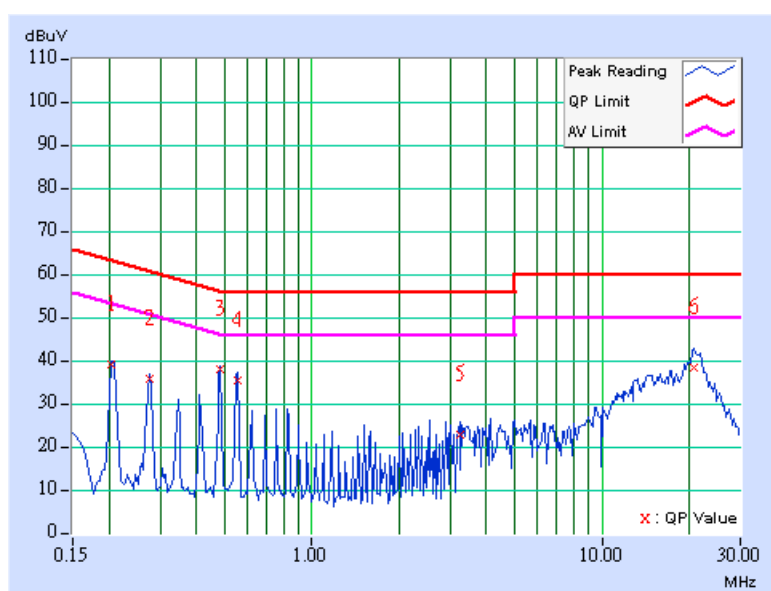

EUT TEST CONDITION		MEASUREMENT DETAIL	
CHANNEL	Channel 11	PHASE	Line 2
MODULATION TYPE	BPSK	6dB BANDWIDTH	9 kHz
TRANSFER RATE	6Mbps	INPUT POWER (SYSTEM)	120Vac, 60 Hz
ENVIRONMENTAL CONDITIONS	20deg. C, 60%RH, 991hPa	TESTED BY	Match Tsui

No	Freq. [MHz]	Corr. Factor [dB]	Reading Value [dB (uV)]		Emission Level [dB (uV)]		Limit [dB (uV)]		Margin (dB)	
			Q.P.	AV.	Q.P.	AV.	Q.P.	AV.	Q.P.	AV.
1	0.205	0.10	34.64	-	34.74	-	63.42	53.42	-28.68	-
2	0.275	0.10	30.30	-	30.40	-	60.97	50.97	-30.57	-
3	0.482	0.11	30.09	-	30.20	-	56.30	46.30	-26.10	-
4	0.826	0.17	26.49	-	26.66	-	56.00	46.00	-29.34	-
5	1.859	0.20	26.48	-	26.68	-	56.00	46.00	-29.32	-
6	21.137	0.62	39.48	-	40.10	-	60.00	50.00	-19.90	-

- REMARKS:**
1. Q.P. and AV. are abbreviations of quasi-peak and average individually.
 2. "-": The Quasi-peak reading value also meets average limit and measurement with the average detector is unnecessary.
 3. The emission levels of other frequencies were very low against the limit.
 4. Margin value = Emission level - Limit value
 5. Correction factor = Insertion loss + Cable loss
 6. Emission Level = Correction Factor + Reading Value.

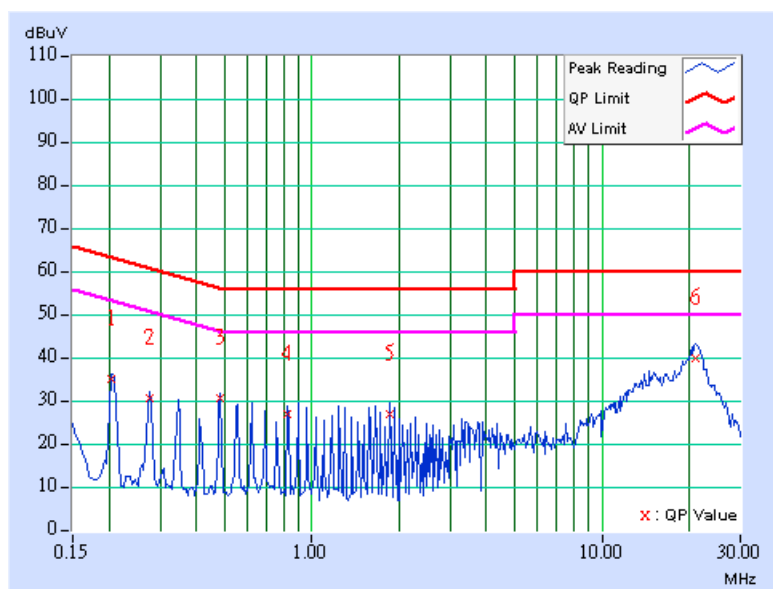

4.1.8 TEST RESULTS (B)

CONDUCTED WORST-CASE DATA

EUT TEST CONDITION		MEASUREMENT DETAIL	
CHANNEL	Channel 1	PHASE	Line 1
MODULATION TYPE	BPSK	6dB BANDWIDTH	9 kHz
TRANSFER RATE	6Mbps	INPUT POWER (SYSTEM)	120Vac, 60 Hz
ENVIRONMENTAL CONDITIONS	20deg. C, 60%RH, 991hPa	TESTED BY	Match Tsui

No	Freq. [MHz]	Corr. Factor [dB]	Reading Value [dB (uV)]		Emission Level [dB (uV)]		Limit [dB (uV)]		Margin (dB)	
			Q.P.	AV.	Q.P.	AV.	Q.P.	AV.	Q.P.	AV.
1	0.177	0.10	45.98	-	46.08	-	64.61	54.61	-18.53	-
2	0.349	0.10	37.85	-	37.95	-	58.98	48.98	-21.03	-
3	0.439	0.10	33.46	-	33.56	-	57.08	47.08	-23.52	-
4	0.615	0.10	33.51	-	33.61	-	56.00	46.00	-22.39	-
5	3.422	0.32	32.22	-	32.54	-	56.00	46.00	-23.46	-
6	9.823	0.36	41.51	-	41.87	-	60.00	50.00	-18.13	-

- REMARKS:**
1. Q.P. and AV. are abbreviations of quasi-peak and average individually.
 2. "-": The Quasi-peak reading value also meets average limit and measurement with the average detector is unnecessary.
 3. The emission levels of other frequencies were very low against the limit.
 4. Margin value = Emission level - Limit value
 5. Correction factor = Insertion loss + Cable loss
 6. Emission Level = Correction Factor + Reading Value.

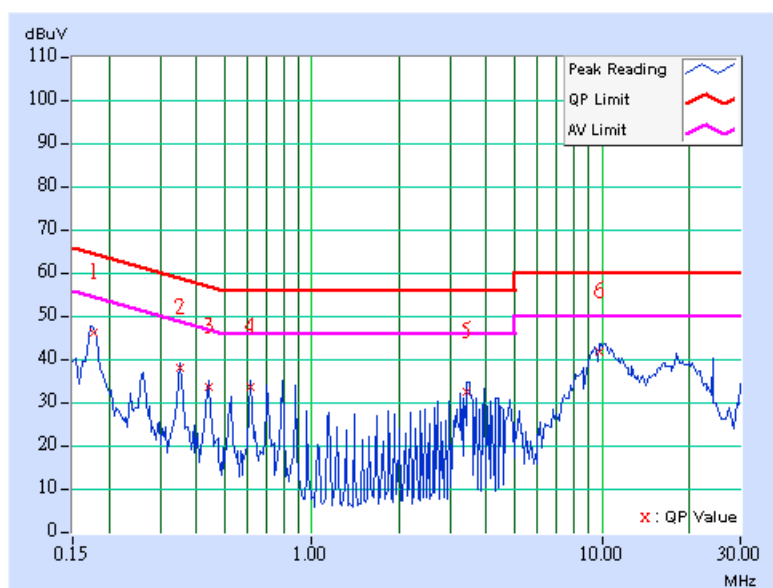

EUT TEST CONDITION		MEASUREMENT DETAIL	
CHANNEL	Channel 1	PHASE	Line 2
MODULATION TYPE	BPSK	6dB BANDWIDTH	9 kHz
TRANSFER RATE	6Mbps	INPUT POWER (SYSTEM)	120Vac, 60 Hz
ENVIRONMENTAL CONDITIONS	20deg. C, 60%RH, 991hPa	TESTED BY	Match Tsui

No	Freq. [MHz]	Corr. Factor [dB]	Reading Value [dB (uV)]		Emission Level [dB (uV)]		Limit [dB (uV)]		Margin (dB)	
			Q.P.	AV.	Q.P.	AV.	Q.P.	AV.	Q.P.	AV.
1	0.173	0.10	48.17	-	48.27	-	64.79	54.79	-16.52	-
2	0.349	0.10	34.24	-	34.34	-	58.98	48.98	-24.64	-
3	0.439	0.11	31.91	-	32.02	-	57.08	47.08	-25.06	-
4	0.787	0.16	32.85	-	33.01	-	56.00	46.00	-22.99	-
5	3.945	0.37	30.48	-	30.85	-	56.00	46.00	-25.15	-
6	9.905	0.46	41.02	-	41.48	-	60.00	50.00	-18.52	-

- REMARKS:**
1. Q.P. and AV. are abbreviations of quasi-peak and average individually.
 2. "-": The Quasi-peak reading value also meets average limit and measurement with the average detector is unnecessary.
 3. The emission levels of other frequencies were very low against the limit.
 4. Margin value = Emission level - Limit value
 5. Correction factor = Insertion loss + Cable loss
 6. Emission Level = Correction Factor + Reading Value.

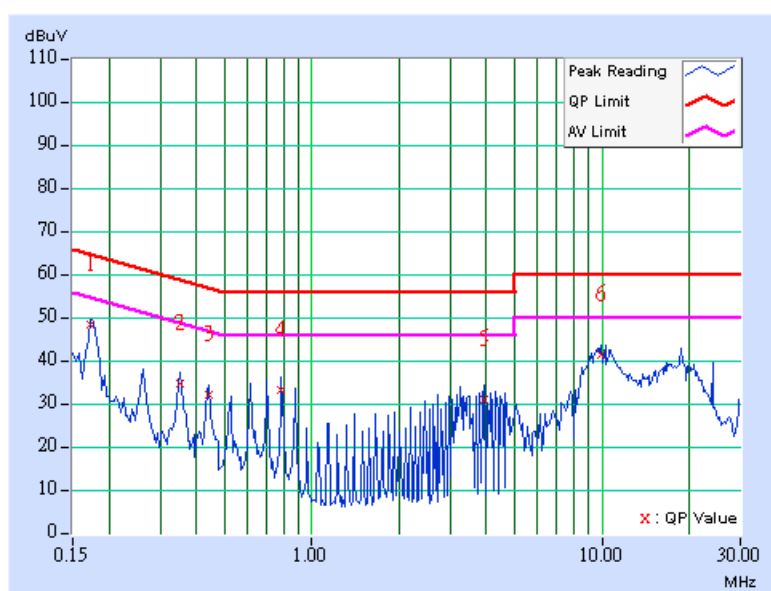

EUT TEST CONDITION		MEASUREMENT DETAIL	
CHANNEL	Channel 6	PHASE	Line 1
MODULATION TYPE	BPSK	6dB BANDWIDTH	9 kHz
TRANSFER RATE	6Mbps	INPUT POWER (SYSTEM)	120Vac, 60 Hz
ENVIRONMENTAL CONDITIONS	20deg. C, 60%RH, 991hPa	TESTED BY	Match Tsui

No	Freq. [MHz]	Corr. Factor [dB]	Reading Value [dB (uV)]		Emission Level [dB (uV)]		Limit [dB (uV)]		Margin (dB)	
			Q.P.	AV.	Q.P.	AV.	Q.P.	AV.	Q.P.	AV.
1	0.173	0.10	45.51	-	45.61	-	64.79	54.79	-19.18	-
2	0.349	0.10	37.53	-	37.63	-	58.98	48.98	-21.35	-
3	0.615	0.10	33.83	-	33.93	-	56.00	46.00	-22.07	-
4	0.791	0.10	34.86	-	34.96	-	56.00	46.00	-21.04	-
5	3.512	0.33	33.95	-	34.28	-	56.00	46.00	-21.72	-
6	10.277	0.37	42.16	-	42.53	-	60.00	50.00	-17.47	-

- REMARKS:**
1. Q.P. and AV. are abbreviations of quasi-peak and average individually.
 2. "-": The Quasi-peak reading value also meets average limit and measurement with the average detector is unnecessary.
 3. The emission levels of other frequencies were very low against the limit.
 4. Margin value = Emission level - Limit value
 5. Correction factor = Insertion loss + Cable loss
 6. Emission Level = Correction Factor + Reading Value.

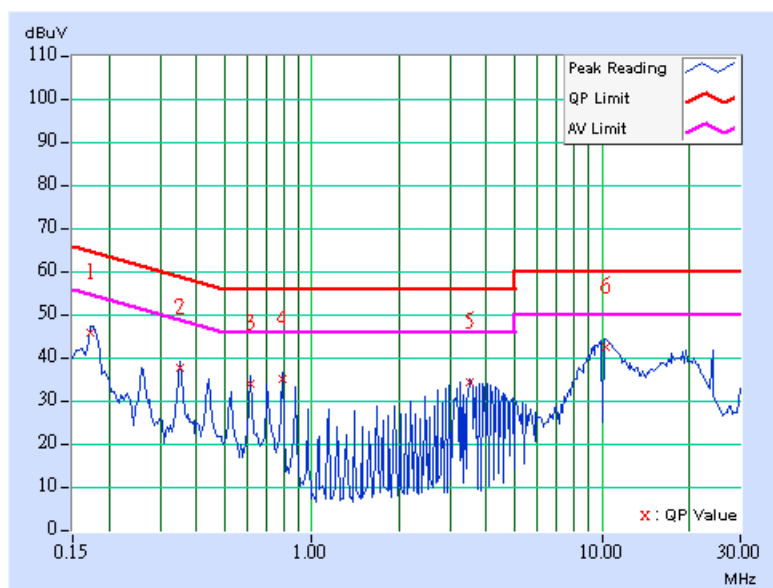

EUT TEST CONDITION		MEASUREMENT DETAIL	
CHANNEL	Channel 6	PHASE	Line 2
MODULATION TYPE	BPSK	6dB BANDWIDTH	9 kHz
TRANSFER RATE	6Mbps	INPUT POWER (SYSTEM)	120Vac, 60 Hz
ENVIRONMENTAL CONDITIONS	20deg. C, 60%RH, 991hPa	TESTED BY	Match Tsui

No	Freq. [MHz]	Corr. Factor [dB]	Reading Value [dB (uV)]		Emission Level [dB (uV)]		Limit [dB (uV)]		Margin (dB)	
			Q.P.	AV.	Q.P.	AV.	Q.P.	AV.	Q.P.	AV.
1	0.175	0.10	48.57	-	48.67	-	64.73	54.73	-16.06	-
2	0.353	0.10	33.58	-	33.68	-	58.89	48.89	-25.21	-
3	0.439	0.11	32.07	-	32.18	-	57.08	47.08	-24.90	-
4	0.791	0.17	33.97	-	34.14	-	56.00	46.00	-21.86	-
5	3.508	0.33	32.39	-	32.72	-	56.00	46.00	-23.28	-
6	10.443	0.48	41.66	-	42.14	-	60.00	50.00	-17.86	-

- REMARKS:**
1. Q.P. and AV. are abbreviations of quasi-peak and average individually.
 2. "-": The Quasi-peak reading value also meets average limit and measurement with the average detector is unnecessary.
 3. The emission levels of other frequencies were very low against the limit.
 4. Margin value = Emission level - Limit value
 5. Correction factor = Insertion loss + Cable loss
 6. Emission Level = Correction Factor + Reading Value.

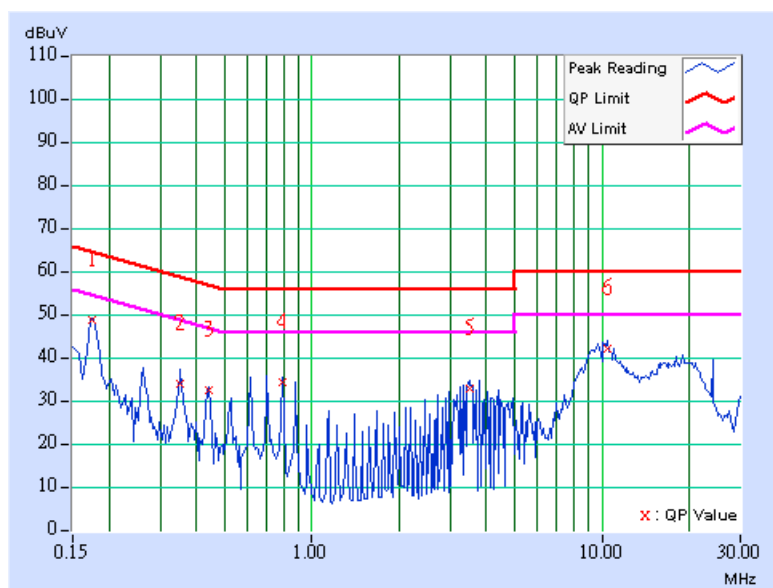

EUT TEST CONDITION		MEASUREMENT DETAIL	
CHANNEL	Channel 11	PHASE	Line 1
MODULATION TYPE	BPSK	6dB BANDWIDTH	9 kHz
TRANSFER RATE	6Mbps	INPUT POWER (SYSTEM)	120Vac, 60 Hz
ENVIRONMENTAL CONDITIONS	20deg. C, 60%RH, 991hPa	TESTED BY	Match Tsui

No	Freq. [MHz]	Corr. Factor [dB]	Reading Value [dB (uV)]		Emission Level [dB (uV)]		Limit [dB (uV)]		Margin (dB)	
			Q.P.	AV.	Q.P.	AV.	Q.P.	AV.	Q.P.	AV.
1	0.173	0.10	45.13	-	45.23	-	64.79	54.79	-19.56	-
2	0.353	0.10	37.71	-	37.81	-	58.89	48.89	-21.08	-
3	0.615	0.10	33.93	-	34.03	-	56.00	46.00	-21.97	-
4	0.791	0.10	34.94	-	35.04	-	56.00	46.00	-20.96	-
5	3.777	0.35	32.96	-	33.31	-	56.00	46.00	-22.69	-
6	10.457	0.38	40.50	-	40.88	-	60.00	50.00	-19.12	-

- REMARKS:**
1. Q.P. and AV. are abbreviations of quasi-peak and average individually.
 2. "-": The Quasi-peak reading value also meets average limit and measurement with the average detector is unnecessary.
 3. The emission levels of other frequencies were very low against the limit.
 4. Margin value = Emission level - Limit value
 5. Correction factor = Insertion loss + Cable loss
 6. Emission Level = Correction Factor + Reading Value.

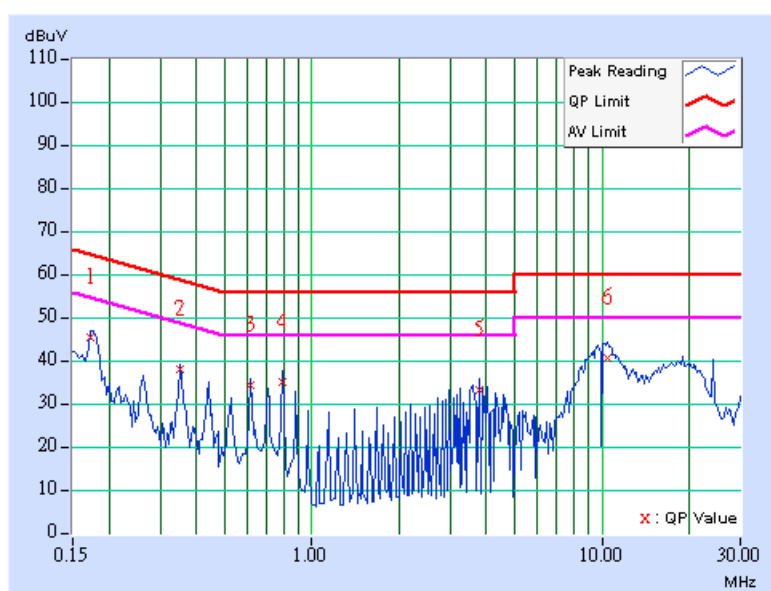

EUT TEST CONDITION		MEASUREMENT DETAIL	
CHANNEL	Channel 11	PHASE	Line 2
MODULATION TYPE	BPSK	6dB BANDWIDTH	9 kHz
TRANSFER RATE	6Mbps	INPUT POWER (SYSTEM)	120Vac, 60 Hz
ENVIRONMENTAL CONDITIONS	20deg. C, 60%RH, 991hPa	TESTED BY	Match Tsui

No	Freq. [MHz]	Corr. Factor [dB]	Reading Value [dB (uV)]		Emission Level [dB (uV)]		Limit [dB (uV)]		Margin (dB)	
			Q.P.	AV.	Q.P.	AV.	Q.P.	AV.	Q.P.	AV.
1	0.177	0.10	47.81	-	47.91	-	64.61	54.61	-16.70	-
2	0.353	0.10	33.80	-	33.90	-	58.89	48.89	-24.99	-
3	0.615	0.14	33.57	-	33.71	-	56.00	46.00	-22.29	-
4	0.791	0.17	34.01	-	34.18	-	56.00	46.00	-21.82	-
5	3.863	0.36	32.06	-	32.42	-	56.00	46.00	-23.58	-
6	9.665	0.45	41.36	-	41.81	-	60.00	50.00	-18.19	-

- REMARKS:**
1. Q.P. and AV. are abbreviations of quasi-peak and average individually.
 2. "-": The Quasi-peak reading value also meets average limit and measurement with the average detector is unnecessary.
 3. The emission levels of other frequencies were very low against the limit.
 4. Margin value = Emission level - Limit value
 5. Correction factor = Insertion loss + Cable loss
 6. Emission Level = Correction Factor + Reading Value.

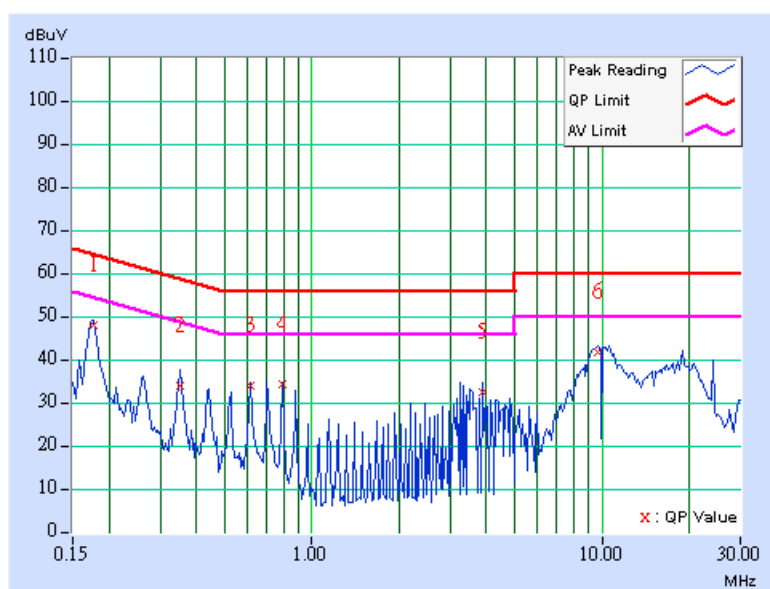

4.2 RADIATED EMISSION MEASUREMENT

4.2.1 LIMITS OF RADIATED EMISSION MEASUREMENT

Emissions radiated outside of the specified bands, shall be according to the general radiated limits in 15.209 as following:

Frequencies (MHz)	Field strength (microvolts/meter)	Measurement distance (meters)
0.009-0.490	2400/F(kHz)	300
0.490-1.705	24000/F(kHz)	30
1.705-30.0	30	30
30-88	100	3
88-216	150	3
216-960	200	3
Above 960	500	3

NOTE:

1. The lower limit shall apply at the transition frequencies.
2. Emission level (dBuV/m) = 20 log Emission level (uV/m).
3. As shown in 15.35(b), for frequencies above 1000MHz, the field strength limits are based on average detector, however, the peak field strength of any emission shall not exceed the maximum permitted average limits, specified above by more than 20dB under any condition of modulation.



4.2.2 TEST INSTRUMENTS

DESCRIPTION & MANUFACTURER	MODEL NO.	SERIAL NO.	CALIBRATED UNTIL
Test Receiver ROHDE & SCHWARZ	ESI7	838496/016	Jan. 01, 2007
Spectrum Analyzer ROHDE & SCHWARZ	FSP40	100041	Dec. 04, 2006
BILOG Antenna SCHWARZBECK	VULB9168	9168-155	Jan. 15, 2007
HORN Antenna SCHWARZBECK	BBHA 9120D	9120D-404	Jan. 01, 2007
HORN Antenna SCHWARZBECK	BBHA 9170	BBHA9170242	Jan. 19, 2007
Preamplifier Agilent	8449B	3008A01960	Nov. 09, 2006
RF signal cable HUBER+SUHNNER	SUCOFLEX 104	219268/4	Dec. 20, 2006
RF signal cable HUBER+SUHNNER	SUCOFLEX 104	230129/4	Dec. 20, 2006
Software ADT.	ADT_Radiated_V5.14	NA	NA
Antenna Tower inn-co GmbH	MA 4000	010303	NA
Antenna Tower Controller inn-co GmbH	CO2000	019303	NA
Turn Table ADT.	TT100.	TT93021704	NA
Turn Table Controller ADT.	SC100.	SC93021704	NA

- NOTE:**
1. The calibration interval of the above test instruments is 12 months and the calibrations are traceable to NML/ROC and NIST/USA.
 2. The test was performed in HwaYa Chamber 3.
 3. The horn antenna and HP preamplifier (model: 8449B) are used only for the measurement of emission frequency above 1GHz if tested.
 4. The IC Site Registration No. is IC4924-4.

4.2.3 TEST PROCEDURES

- a. The EUT was placed on the top of a rotating table 0.8 meters above the ground at a 3 meters semi-anechoic chamber. The table was rotated 360 degrees to determine the position of the highest radiation.
- b. The EUT was set 3 meters away from the interference-receiving antenna, which was mounted on the top of a variable-height antenna tower.
- c. The antenna is a broadband antenna, and its height is varied from one meter to four meters above the ground to determine the maximum value of the field strength. Both horizontal and vertical polarizations of the antenna are set to make the measurement.
- d. For each suspected emission, the EUT was arranged to its worst case and then the antenna was tuned to heights from 1 meter to 4 meters and the rotatable table was turned from 0 degrees to 360 degrees to find the maximum reading.
- e. The test-receiver system was set to Peak Detect Function and Specified Bandwidth with Maximum Hold Mode.
- f. If the emission level of the EUT in peak mode was lower than the limit specified, then testing could be stopped and the peak values of the EUT would be reported. Otherwise the emissions would be re-tested one by one using peak, quasi-peak or average method as specified and then reported in a data sheet.

NOTE:

1. The resolution bandwidth and video bandwidth of test receiver/spectrum analyzer is 120kHz for Peak detection (PK) and Quasi-peak detection (QP) at frequency below 1GHz.
2. The resolution bandwidth and video bandwidth of test receiver/spectrum analyzer is 1 MHz for Peak detection at frequency above 1GHz.
3. The resolution bandwidth of test receiver/spectrum analyzer is 1MHz and the video bandwidth is 10Hz for Average detection (AV) at frequency above 1GHz.

4.2.4 DEVIATION FROM TEST STANDARD

No deviation

4.2.5 TEST SETUP

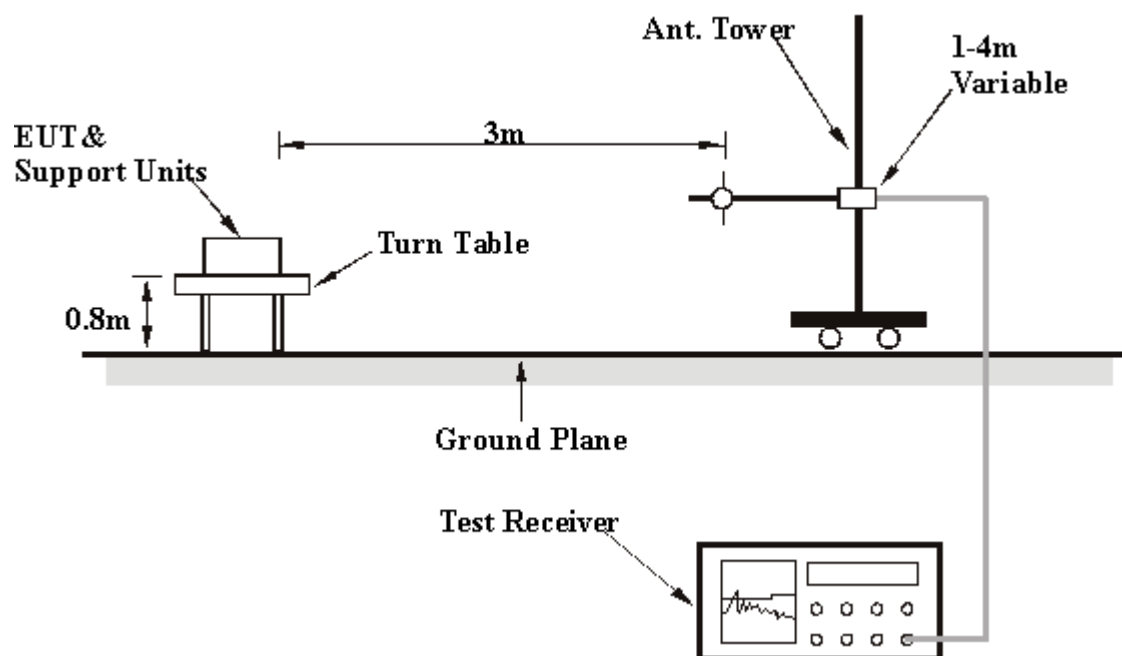

For the actual test configuration, please refer to the related item – Photographs of the Test Configuration.

4.2.6 EUT OPERATING CONDITIONS

Same as 4.1.6

4.2.7 TEST RESULTS (A)

RADIATED WORST-CASE DATA: BELOW 1GHz

EUT TEST CONDITION		MEASUREMENT DETAIL	
CHANNEL	Channel 11	FREQUENCY RANGE	Below 1000MHz
MODULATION TYPE	BPSK	DETECTOR FUNCTION	Quasi-Peak
TRANSFER RATE	6Mbps	INPUT POWER (SYSTEM)	120Vac, 60 Hz
ENVIRONMENTAL CONDITIONS	25deg. C, 65%RH, 991hPa	TESTED BY	Brad Wu

ANTENNA POLARITY & TEST DISTANCE: HORIZONTAL AT 3 M								
No.	Freq. (MHz)	Emission Level (dBuV/m)	Limit (dBuV/m)	Margin (dB)	Antenna Height (m)	Table Angle (Degree)	Raw Value (dBuV)	Correction Factor (dB/m)
1	123.31	39.93 QP	43.50	-3.57	2.00 H	286	28.65	11.28
2	374.07	40.09 QP	46.00	-5.91	1.50 H	1	23.16	16.93
3	659.82	40.93 QP	46.00	-5.07	2.00 H	331	17.61	23.32
4	792.00	40.57 QP	46.00	-5.43	1.50 H	193	14.51	26.06
5	875.59	40.22 QP	46.00	-5.78	2.00 H	256	13.12	27.10
6	914.47	41.64 QP	46.00	-4.36	1.00 H	1	13.52	28.13

ANTENNA POLARITY & TEST DISTANCE: VERTICAL AT 3 M								
No.	Freq. (MHz)	Emission Level (dBuV/m)	Limit (dBuV/m)	Margin (dB)	Antenna Height (m)	Table Angle (Degree)	Raw Value (dBuV)	Correction Factor (dB/m)
1	33.89	36.61 QP	40.00	-3.39	1.50 V	103	23.74	12.87
2	123.31	38.47 QP	43.50	-5.03	1.50 V	214	27.19	11.28
3	374.07	37.50 QP	46.00	-8.50	1.00 V	22	20.58	16.93
4	416.83	36.02 QP	46.00	-9.98	1.50 V	142	17.92	18.10
5	500.42	39.07 QP	46.00	-6.93	1.00 V	184	19.12	19.95
6	924.19	38.81 QP	46.00	-7.19	1.00 V	106	10.23	28.58

- REMARKS:**
1. Emission level(dBuV/m)=Raw Value(dBuV) + Correction Factor(dB/m)
 2. Correction Factor(dB/m) = Antenna Factor (dB/m) + Cable Factor (dB)
 3. The other emission levels were very low against the limit.
 4. Margin value = Emission level – Limit value.

4.2.8 TEST RESULTS (B)

RADIATED WORST-CASE DATA: BELOW 1GHz

EUT TEST CONDITION		MEASUREMENT DETAIL	
CHANNEL	Channel 11	FREQUENCY RANGE	Below 1000MHz
MODULATION TYPE	BPSK	DETECTOR FUNCTION	Quasi-Peak
TRANSFER RATE	6Mbps	INPUT POWER (SYSTEM)	120Vac, 60 Hz
ENVIRONMENTAL CONDITIONS	25deg. C, 65%RH, 991hPa	TESTED BY	Brad Wu

ANTENNA POLARITY & TEST DISTANCE: HORIZONTAL AT 3 M								
No.	Freq. (MHz)	Emission Level (dBuV/m)	Limit (dBuV/m)	Margin (dB)	Antenna Height (m)	Table Angle (Degree)	Raw Value (dBuV)	Correction Factor (dB/m)
1	123.31	40.68 QP	43.50	-2.82	1.50 H	319	29.40	11.28
2	374.07	40.17 QP	46.00	-5.83	2.00 H	358	23.24	16.93
3	500.42	40.55 QP	46.00	-5.45	1.50 H	322	20.60	19.95
4	659.82	40.85 QP	46.00	-5.15	2.00 H	58	17.53	23.32
5	751.18	40.38 QP	46.00	-5.62	2.00 H	310	14.59	25.79
6	792.00	41.11 QP	46.00	-4.89	1.50 H	322	15.06	26.06

ANTENNA POLARITY & TEST DISTANCE: VERTICAL AT 3 M								
No.	Freq. (MHz)	Emission Level (dBuV/m)	Limit (dBuV/m)	Margin (dB)	Antenna Height (m)	Table Angle (Degree)	Raw Value (dBuV)	Correction Factor (dB/m)
1	123.31	34.26 QP	43.50	-9.24	1.50 V	40	22.98	11.28
2	374.07	41.57 QP	46.00	-4.43	1.00 V	58	24.64	16.93
3	500.42	44.10 QP	46.00	-1.90	1.00 V	199	24.15	19.95
4	624.83	42.39 QP	46.00	-3.61	1.00 V	169	19.55	22.83
5	751.18	36.95 QP	46.00	-9.05	1.50 V	52	11.16	25.79
6	924.19	38.29 QP	46.00	-7.71	1.00 V	166	9.71	28.58

- REMARKS:**
1. Emission level(dBuV/m)=Raw Value(dBuV) + Correction Factor(dB/m)
 2. Correction Factor(dB/m) = Antenna Factor (dB/m) + Cable Factor (dB)
 3. The other emission levels were very low against the limit.
 4. Margin value = Emission level – Limit value.

4.2.9 TEST RESULTS (A)

802.11b DSSS MODULATION

EUT TEST CONDITION		MEASUREMENT DETAIL	
CHANNEL	Channel 1	FREQUENCY RANGE	1 ~ 25GHz
MODULATION TYPE	CCK	DETECTOR FUNCTION	Peak(PK) Average (AV)
TRANSFER RATE	11Mbps	ENVIRONMENTAL CONDITIONS	25deg. C, 65%RH, 991hPa
INPUT POWER (SYSTEM)	120Vac, 60 Hz	TESTED BY	Brad Wu

ANTENNA POLARITY & TEST DISTANCE: HORIZONTAL AT 3 M								
No.	Freq. (MHz)	Emission Level (dBuV/m)	Limit (dBuV/m)	Margin (dB)	Antenna Height (m)	Table Angle (Degree)	Raw Value (dBuV)	Correction Factor (dB/m)
1	2390.00	51.71 PK	74.00	-22.29	1.89 H	172	19.61	32.10
1	2390.00	43.76 AV	54.00	-10.24	1.89 H	172	11.66	32.10
2	*2412.00	108.08 PK			1.89 H	172	75.90	32.18
2	*2412.00	100.13 AV			1.89 H	172	67.95	32.18
3	4824.00	51.12 PK	74.00	-22.88	1.08 H	214	12.49	38.63
3	4824.00	41.03 AV	54.00	-12.97	1.08 H	214	2.40	38.63

ANTENNA POLARITY & TEST DISTANCE: VERTICAL AT 3 M								
No.	Freq. (MHz)	Emission Level (dBuV/m)	Limit (dBuV/m)	Margin (dB)	Antenna Height (m)	Table Angle (Degree)	Raw Value (dBuV)	Correction Factor (dB/m)
1	2390.00	60.84 PK	74.00	-13.16	1.13 V	162	28.74	32.10
1	2390.00	49.75 AV	54.00	-4.25	1.13 V	162	17.65	32.10
2	*2412.00	113.89 PK			1.13 V	168	81.71	32.18
2	*2412.00	106.12 AV			1.13 V	168	73.94	32.18
3	4824.00	53.85 PK	74.00	-20.15	1.02 V	306	15.22	38.63
3	4824.00	44.84 AV	54.00	-9.16	1.02 V	306	6.21	38.63

- REMARKS:**
1. Emission level(dBuV/m)=Raw Value(dBuV) + Correction Factor(dB/m)
 2. Correction Factor(dB/m) = Antenna Factor (dB/m) + Cable Factor (dB)
 3. The other emission levels were very low against the limit.
 4. Margin value = Emission level – Limit value.
 5. “ * ” : Fundamental frequency.

EUT TEST CONDITION		MEASUREMENT DETAIL	
CHANNEL	Channel 11	FREQUENCY RANGE	1 ~ 25GHz
MODULATION TYPE	CCK	DETECTOR FUNCTION	Peak(PK) Average (AV)
TRANSFER RATE	11Mbps	ENVIRONMENTAL CONDITIONS	25deg. C, 65%RH, 991hPa
INPUT POWER (SYSTEM)	120Vac, 60 Hz	TESTED BY	Brad Wu

ANTENNA POLARITY & TEST DISTANCE: HORIZONTAL AT 3 M								
No.	Freq. (MHz)	Emission Level (dBuV/m)	Limit (dBuV/m)	Margin (dB)	Antenna Height (m)	Table Angle (Degree)	Raw Value (dBuV)	Correction Factor (dB/m)
1	*2462.00	107.26 PK			1.88 H	170	74.90	32.36
1	*2462.00	99.02 AV			1.88 H	170	66.66	32.36
2	2483.50	50.89 PK	74.00	-23.11	1.88 H	170	18.45	32.44
2	2483.50	42.65 AV	54.00	-11.35	1.88 H	170	10.21	32.44
3	4924.00	51.04 PK	74.00	-22.96	1.21 H	224	12.14	38.90
3	4924.00	40.87 AV	54.00	-13.13	1.21 H	224	1.97	38.90

ANTENNA POLARITY & TEST DISTANCE: VERTICAL AT 3 M								
No.	Freq. (MHz)	Emission Level (dBuV/m)	Limit (dBuV/m)	Margin (dB)	Antenna Height (m)	Table Angle (Degree)	Raw Value (dBuV)	Correction Factor (dB/m)
1	*2462.00	113.26 PK			1.15 V	184	80.90	32.36
1	*2462.00	105.26 AV			1.15 V	184	72.90	32.36
2	2483.50	59.55 PK	74.00	-14.45	1.15 V	184	27.11	32.44
2	2483.50	50.17 AV	54.00	-3.83	1.15 V	184	17.73	32.44
3	4924.00	53.96 PK	74.00	-20.04	1.05 V	313	15.06	38.90
3	4924.00	44.91 AV	54.00	-9.09	1.05 V	313	6.01	38.90

- REMARKS:**
1. Emission level(dBuV/m)=Raw Value(dBuV) + Correction Factor(dB/m)
 2. Correction Factor(dB/m) = Antenna Factor (dB/m) + Cable Factor (dB)
 3. The other emission levels were very low against the limit.
 4. Margin value = Emission level – Limit value.
 5. “ * “ : Fundamental frequency.

802.11g OFDM MODULATION

EUT TEST CONDITION		MEASUREMENT DETAIL	
CHANNEL	Channel 1	FREQUENCY RANGE	1 ~ 25GHz
MODULATION TYPE	BPSK	DETECTOR FUNCTION	Peak(PK) Average (AV)
TRANSFER RATE	6Mbps	ENVIRONMENTAL CONDITIONS	25deg. C, 65%RH, 991hPa
INPUT POWER (SYSTEM)	120Vac, 60 Hz	TESTED BY	Brad Wu

ANTENNA POLARITY & TEST DISTANCE: HORIZONTAL AT 3 M								
No.	Freq. (MHz)	Emission Level (dBuV/m)	Limit (dBuV/m)	Margin (dB)	Antenna Height (m)	Table Angle (Degree)	Raw Value (dBuV)	Correction Factor (dB/m)
1	2390.00	52.42 PK	74.00	-21.58	1.04 H	171	20.32	32.10
1	2390.00	43.08 AV	54.00	-10.92	1.04 H	171	10.98	32.10
2	*2412.00	103.15 PK			1.04 H	171	70.97	32.18
2	*2412.00	93.81 AV			1.04 H	171	61.63	32.18
3	4824.00	48.97 PK	74.00	-25.03	1.15 H	30	10.34	38.63
3	4824.00	38.95 AV	54.00	-15.05	1.15 H	30	0.32	38.63

ANTENNA POLARITY & TEST DISTANCE: VERTICAL AT 3 M								
No.	Freq. (MHz)	Emission Level (dBuV/m)	Limit (dBuV/m)	Margin (dB)	Antenna Height (m)	Table Angle (Degree)	Raw Value (dBuV)	Correction Factor (dB/m)
1	2390.00	62.68 PK	74.00	-11.32	1.20 V	186	30.58	32.10
1	2390.00	49.70 AV	54.00	-4.30	1.20 V	186	17.60	32.10
2	*2412.00	109.61 PK			1.16 V	185	77.43	32.18
2	*2412.00	100.43 AV			1.16 V	185	68.25	32.18
3	4824.00	51.87 PK	74.00	-22.13	1.09 V	42	13.24	38.63
3	4824.00	44.78 AV	54.00	-9.22	1.09 V	42	6.15	38.63

- REMARKS:**
1. Emission level(dBuV/m)=Raw Value(dBuV) + Correction Factor(dB/m)
 2. Correction Factor(dB/m) = Antenna Factor (dB/m) + Cable Factor (dB)
 3. The other emission levels were very low against the limit.
 4. Margin value = Emission level – Limit value.
 5. " * " : Fundamental frequency.

EUT TEST CONDITION		MEASUREMENT DETAIL	
CHANNEL	Channel 11	FREQUENCY RANGE	1 ~ 25GHz
MODULATION TYPE	BPSK	DETECTOR FUNCTION	Peak(PK) Average (AV)
TRANSFER RATE	6Mbps	ENVIRONMENTAL CONDITIONS	25deg. C, 64%RH, 991hPa
INPUT POWER (SYSTEM)	120Vac, 60 Hz	TESTED BY	Brad Wu

ANTENNA POLARITY & TEST DISTANCE: HORIZONTAL AT 3 M								
No.	Freq. (MHz)	Emission Level (dBuV/m)	Limit (dBuV/m)	Margin (dB)	Antenna Height (m)	Table Angle (Degree)	Raw Value (dBuV)	Correction Factor (dB/m)
1	*2462.00	101.64 PK			1.03 H	164	69.28	32.36
1	*2462.00	92.28 AV			1.03 H	164	59.92	32.36
2	2483.50	51.26 PK	74.00	-22.74	1.03 H	164	18.82	32.44
2	2483.50	42.02 AV	54.00	-11.98	1.03 H	164	9.58	32.44
3	4924.00	48.86 PK	74.00	-25.14	1.16 H	33	9.96	38.90
3	4924.00	38.85 AV	54.00	-15.15	1.16 H	33	-0.05	38.90

ANTENNA POLARITY & TEST DISTANCE: VERTICAL AT 3 M								
No.	Freq. (MHz)	Emission Level (dBuV/m)	Limit (dBuV/m)	Margin (dB)	Antenna Height (m)	Table Angle (Degree)	Raw Value (dBuV)	Correction Factor (dB/m)
1	*2462.00	108.27 PK			1.16 V	180	75.91	32.36
1	*2462.00	98.97 AV			1.16 V	180	66.61	32.36
2	2483.50	59.32 PK	74.00	-14.68	1.12 V	181	26.88	32.44
2	2483.50	48.59 AV	54.00	-5.41	1.12 V	181	16.15	32.44
3	4924.00	51.62 PK	74.00	-22.38	1.04 V	34	12.72	38.90
3	4924.00	44.53 AV	54.00	-9.47	1.04 V	34	5.63	38.90

- REMARKS:**
1. Emission level(dBuV/m)=Raw Value(dBuV) + Correction Factor(dB/m)
 2. Correction Factor(dB/m) = Antenna Factor (dB/m) + Cable Factor (dB)
 3. The other emission levels were very low against the limit.
 4. Margin value = Emission level – Limit value.
 5. “ * ” : Fundamental frequency.



5 INFORMATION ON THE TESTING LABORATORIES

We, ADT Corp., were founded in 1988 to provide our best service in EMC, Radio, Telecom and Safety consultation. Our laboratories are accredited and approved by the following approval agencies according to ISO/IEC 17025

USA	FCC, UL, A2LA
Germany	TUV Rheinland
Japan	VCCI
Norway	NEMKO
Canada	INDUSTRY CANADA , CSA
R.O.C.	CNLA, BSMI, DGT
Netherlands	Telefication
Singapore	PSB , GOST-ASIA(MOU)
Russia	CERTIS(MOU)

Copies of accreditation certificates of our laboratories obtained from approval agencies can be downloaded from our web site:

www.adt.com.tw/index.5/phtml. If you have any comments, please feel free to contact us at the following:

Linko EMC/RF Lab:

Tel: 886-2-26052180

Fax: 886-2-26051924

Hsin Chu EMC/RF Lab:

Tel: 886-3-5935343

Fax: 886-3-5935342

Hwa Ya EMC/RF/Safety/Telecom Lab:

Tel: 886-3-3183232

Fax: 886-3-3185050

Web Site: www.adt.com.tw

The address and road map of all our labs can be found in our web site also.



APPENDIX-A

MODIFICATIONS RECORDERS FOR ENGINEERING CHANGES TO THE EUT BY THE LAB

No any modifications are made to the EUT by the lab during the test.