



# FCC TEST REPORT

**REPORT NO.:** RF940520L05

**MODEL NO.:** WACM-123G  
(refer to page 7 for other models)

**RECEIVED:** May 31, 2005

**TESTED:** May 31 ~ Aug. 10, 2005

**ISSUED:** Aug. 17, 2005

**APPLICANT:** Gemtek Technology Co., Ltd.

**ADDRESS:** No.1, Jen Ai Road, Hsinchu Industrial Park, Hukou  
Hsinchu, Taiwan, R.O.C. 303

**ISSUED BY:** Advance Data Technology Corporation

**LAB ADDRESS:** No. 47, 14<sup>th</sup> Ling, Chia Pau Tsuen, Lin Kou Hsiang  
244, Taipei Hsien, Taiwan, R.O.C.

**TEST LOCATION:** No. 19, Hwa Ya 2<sup>nd</sup> Rd., Wen Hwa Tsuen, Kwei  
Shan Hsiang, Taoyuan Hsien 333, Taiwan, R.O.C.

This test report consists of 62 pages in total. It may be duplicated completely for legal use with the approval of the applicant. It should not be reproduced except in full, without the written approval of our laboratory. The client should not use it to claim product endorsement by CNLA, A2LA or any government agencies. The test results in the report only apply to the tested sample.



0528  
ILAC MRA



No. 2177-01



## TABLE OF CONTENTS

1.	CERTIFICATION.....	4
2.	SUMMARY OF TEST RESULTS .....	5
2.1	MEASUREMENT UNCERTAINTY.....	5
3.	GENERAL INFORMATION.....	6
3.1	GENERAL DESCRIPTION OF EUT .....	6
3.2	DESCRIPTION OF TEST MODES.....	7
3.2.1	CONFIGURATION OF SYSTEM UNDER TEST .....	7
3.2.2	TEST MODE APPLICABILITY AND TESTED CHANNEL DETAIL .....	8
3.2.3	GENERAL DESCRIPTION OF APPLIED STANDARDS .....	10
3.2.4	DESCRIPTION OF SUPPORT UNITS .....	10
4.	TEST TYPES AND RESULTS .....	11
4.1	CONDUCTED EMISSION MEASUREMENT .....	11
4.1.1	LIMITS OF CONDUCTED EMISSION MEASUREMENT .....	11
4.1.2	TEST INSTRUMENTS.....	11
4.1.3	TEST PROCEDURES .....	12
4.1.4	DEVIATION FROM TEST STANDARD.....	12
4.1.5	TEST SETUP.....	13
4.1.6	EUT OPERATING CONDITIONS .....	13
4.1.7	TEST RESULTS .....	14
4.2	RADIATED EMISSION MEASUREMENT .....	20
4.2.1	LIMITS OF RADIATED EMISSION MEASUREMENT.....	20
4.2.2	TEST INSTRUMENTS.....	21
4.2.3	TEST PROCEDURES .....	22
4.2.4	DEVIATION FROM TEST STANDARD.....	23
4.2.5	TEST SETUP.....	23
4.2.6	EUT OPERATING CONDITIONS .....	23
4.2.7	TEST RESULTS .....	24
4.3	6dB BANDWIDTH MEASUREMENT.....	31
4.3.1	LIMITS OF 6dB BANDWIDTH MEASUREMENT .....	31
4.3.2	TEST INSTRUMENTS.....	31
4.3.3	TEST PROCEDURE.....	32
4.3.4	DEVIATION FROM TEST STANDARD.....	32
4.3.5	TEST SETUP.....	32
4.3.6	EUT OPERATING CONDITIONS .....	32
4.3.7	TEST RESULTS .....	33
4.4	MAXIMUM PEAK OUTPUT POWER.....	39
4.4.1	LIMITS OF MAXIMUM PEAK OUTPUT POWER MEASUREMENT .....	39
4.4.2	INSTRUMENTS.....	39
4.4.3	TEST PROCEDURES .....	40
4.4.4	DEVIATION FROM TEST STANDARD.....	40
4.4.5	TEST SETUP.....	40
4.4.6	EUT OPERATING CONDITIONS .....	40
4.4.7	TEST RESULTS .....	41
4.5	POWER SPECTRAL DENSITY MEASUREMENT .....	42
4.5.1	LIMITS OF POWER SPECTRAL DENSITY MEASUREMENT .....	42
4.5.2	TEST INSTRUMENTS.....	42
4.5.3	TEST PROCEDURE.....	43



4.5.4	DEVIATION FROM TEST STANDARD.....	43
4.5.5	TEST SETUP.....	43
4.5.6	EUT OPERATING CONDITION.....	43
4.5.7	TEST RESULTS .....	44
4.6	BAND EDGES MEASUREMENT .....	50
4.6.1	LIMITS OF BAND EDGES MEASUREMENT .....	50
4.6.2	TEST INSTRUMENTS.....	50
4.6.3	TEST PROCEDURE.....	50
4.6.4	DEVIATION FROM TEST STANDARD.....	50
4.6.5	EUT OPERATING CONDITION.....	50
4.6.6	TEST RESULTS .....	51
4.7	ANTENNA REQUIREMENT .....	59
4.7.1	STANDARD APPLICABLE .....	59
4.7.2	ANTENNA CONNECTED CONSTRUCTION .....	59
5.	PHOTOGRAPHS OF THE TEST CONFIGURATION.....	60
6.	INFORMATION ON THE TESTING LABORATORIES .....	62



## 1. CERTIFICATION

**PRODUCT:** Wireless 11g Range Expander (refer to page 7 for other products)

**MODEL:** WACM-123G (refer to page 7 for other models)

**BRAND:** Gemtek (refer to page 7 for other brands)

**APPLICANT:** Gemtek Technology Co., Ltd.

**TESTED:** May 31 ~ Aug. 10, 2005

**TEST SAMPLE:** ENGINEERING SAMPLE

**STANDARDS:** FCC Part 15, Subpart C (Section 15.247),  
ANSI C63.4-2003

The above equipment (Model: WACM-123G) have been tested by **Advance Data Technology Corporation**, and found compliance with the requirement of the above standards. The test record, data evaluation & Equipment Under Test (EUT) configurations represented herein are true and accurate accounts of the measurements of the sample's EMC characteristics under the conditions specified in this report.

**PREPARED BY** : Andrea Hsia , **DATE:** Aug. 17, 2005  
Andrea Hsia

**TECHNICAL**  
**ACCEPTANCE** : Gary Chang , **DATE:** Aug. 17, 2005  
Responsible for RF Gary Chang

**APPROVED BY** : Cody Chang , **DATE:** Aug. 17, 2005  
Cody Chang / Deputy Manager

## 2. SUMMARY OF TEST RESULTS

The EUT has been tested according to the following specifications:

<b>APPLIED STANDARD: FCC Part 15, Subpart C</b>			
<b>STANDARD SECTION</b>	<b>TEST TYPE AND LIMIT</b>	<b>RESULT</b>	<b>REMARK</b>
15.207	AC Power Conducted Emission	PASS	Meet the requirement of limit. Minimum passing margin is -21.04dB at 0.365MHz
15.247(a)(2)	Spectrum Bandwidth of a Direct Sequence Spread Spectrum System Limit: min. 500kHz	PASS	Meet the requirement of limit.
15.247(b)	Maximum Peak Output Power Limit: max. 30dBm	PASS	Meet the requirement of limit.
15.247(d)	Radiated Emissions Limit: Table 15.209	PASS	Meet the requirement of limit. Minimum passing margin is -1.55dB at 2240.00MHz
15.247(e)	Power Spectral Density Limit: max. 8dBm	PASS	Meet the requirement of limit.
15.247(d)	Band Edge Measurement Limit: 20dB less than the peak value of fundamental frequency	PASS	Meet the requirement of limit.

### 2.1 MEASUREMENT UNCERTAINTY

Where relevant, the following measurement uncertainty levels have been estimated for tests performed on the EUT as specified in CISPR 16-4:

<b>MEASUREMENT</b>	<b>FREQUENCY</b>	<b>UNCERTAINTY</b>
Conducted emissions	9kHz ~ 30MHz	2.44 dB
Radiated emissions	30MHz ~ 200MHz	3.73 dB
	200MHz ~ 1000MHz	3.74 dB
	1GHz ~ 18GHz	2.20 dB
	18GHz ~ 40GHz	1.88 dB

This uncertainty represents an expanded uncertainty expressed at approximately the 95% confidence level using a coverage factor of k=2.



### 3. GENERAL INFORMATION

#### 3.1 GENERAL DESCRIPTION OF EUT

<b>EUT</b>	Wireless 11g Range Expander (refer to NOTE 2 as below)
<b>MODEL NO.</b>	WACM-123G (refer to NOTE 2 as below)
<b>POWER SUPPLY</b>	5Vdc from AC adapter
<b>MODULATION TYPE</b>	CCK, DQPSK, DBPSK for DSSS 64QAM, 16QAM, QPSK, BPSK for OFDM
<b>RADIO TECHNOLOGY</b>	DSSS, OFDM
<b>TRANSFER RATE</b>	802.11b: 11/5.5/2/1Mbps 802.11g: 54/48/36/24/18/12/9/6Mbps
<b>FREQUENCY RANGE</b>	2412MHz ~ 2462MHz
<b>NUMBER OF CHANNEL</b>	11
<b>OUTPUT POWER</b>	80.353mW
<b>ANTENNA TYPE</b>	Dipole antenna with 2.48dBi gain
<b>I/O PORT</b>	RJ45
<b>DATA CABLE</b>	NA
<b>ASSOCIATED DEVICES</b>	NA

#### NOTE:

- The EUT was tested with the following adapters:

<b>MODEL:</b>	RH41-0501000DG
<b>INPUT:</b>	230Vac, 50Hz, 60mA
<b>OUTPUT:</b>	5V, 1A, 5VA
<b>POWER LINE:</b>	DC 1.8m non-shielded cable without core

- The models as below are identical to each other except for their model due to marketing requirement.

Brand	Model	Product name	Remark
Gemtek	WACM-123G	Wireless 11g Range Expander	For Marketing different
Gemtek	WAPM-146G	Wireless 11g Access Point	For Marketing different
AirLink	AP311W	802.11g Universal Repeater	For Marketing different
SparkLAN	WX-1590M	Wireless 802.11g Hotspot AP	For Marketing different

- The EUT, operates in the 2.4GHz frequency range, lets you connect IEEE 802.11g or IEEE 802.11b devices to the network. With its high-speed data transmissions of up to 54Mbps.
- The above EUT information was declared by manufacturer and for more detailed features description, please refer to the manufacturer's specifications or User's Manual.

### 3.2 DESCRIPTION OF TEST MODES

Eleven channels are provided to this EUT.

CHANNEL	FREQUENCY	CHANNEL	FREQUENCY
1	2412 MHz	7	2442 MHz
2	2417 MHz	8	2447 MHz
3	2422 MHz	9	2452 MHz
4	2427 MHz	10	2457 MHz
5	2432 MHz	11	2462 MHz
6	2437 MHz		

#### 3.2.1 CONFIGURATION OF SYSTEM UNDER TEST

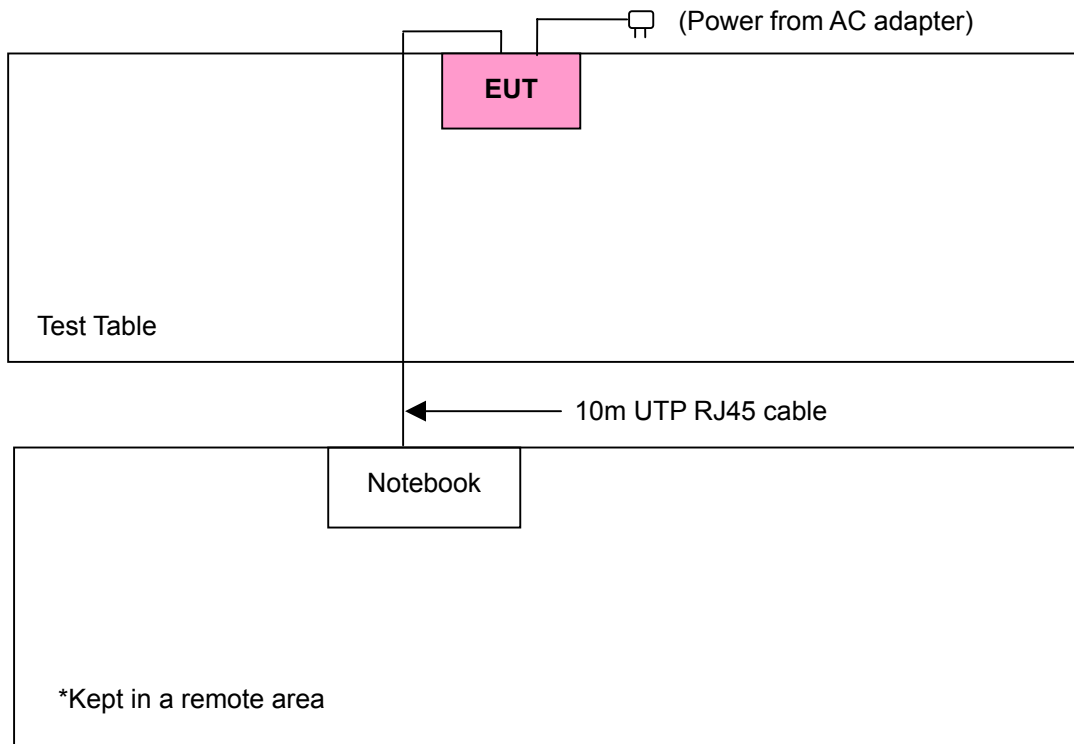



### 3.2.2 TEST MODE APPLICABILITY AND TESTED CHANNEL DETAIL

EUT CONFIGURE MODE	APPLICABLE TO				DESCRIPTION
	PLC	RE<1G	RE≥1G	APCM	
-	√	√	√	√	NA

Where **PLC**: Power Line Conducted Emission

**RE<1G**: Radiated Emission below 1GHz

**RE≥1G**: Radiated Emission above 1GHz

**APCM**: Antenna Port Conducted Measurement

#### **POWER LINE CONDUCTED EMISSION TEST:**

- Pre-Scan has been conducted to determine the worst-case mode from all possible combinations between available modulations, data rates and antenna ports (if EUT with antenna diversity architecture).
- Following channel(s) was (were) selected for the final test as listed below.

MODE	AVAILABLE CHANNEL	TESTED CHANNEL	MODULATION TECHNOLOGY	MODULATION TYPE	DATA RATE (Mbps)
802.11g	1 to 11	1, 6, 11	OFDM	BPSK	6

#### **RADIATED EMISSION TEST (BELOW 1 GHz):**

- Pre-Scan has been conducted to determine the worst-case mode from all possible combinations between available modulations, data rates and antenna ports (if EUT with antenna diversity architecture).
- Following channel(s) was (were) selected for the final test as listed below.

MODE	AVAILABLE CHANNEL	TESTED CHANNEL	MODULATION TECHNOLOGY	MODULATION TYPE	DATA RATE (Mbps)
802.11g	1 to 11	11	OFDM	BPSK	6

#### **RADIATED EMISSION TEST (ABOVE 1 GHz):**

- Pre-Scan has been conducted to determine the worst-case mode from all possible combinations between available modulations, data rates and antenna ports (if EUT with antenna diversity architecture).
- Following channel(s) was (were) selected for the final test as listed below.

MODE	AVAILABLE CHANNEL	TESTED CHANNEL	MODULATION TECHNOLOGY	MODULATION TYPE	DATA RATE (Mbps)
802.11b	1 to 11	1, 6, 11	DSSS	CCK	11
802.11g	1 to 11	1, 6, 11	OFDM	BPSK	6





**BANDEDGE MEASUREMENT:**

- Pre-Scan has been conducted to determine the worst-case mode from all possible combinations between available modulations, data rates and antenna ports (if EUT with antenna diversity architecture).
- Following channel(s) was (were) selected for the final test as listed below.

MODE	AVAILABLE CHANNEL	TESTED CHANNEL	MODULATION TECHNOLOGY	MODULATION TYPE	DATA RATE (Mbps)
802.11b	1 to 11	1, 11	DSSS	CCK	11
802.11g	1 to 11	1, 11	OFDM	BPSK	6

**ANTENNA PORT CONDUCTED MEASUREMENT:**

- Pre-Scan has been conducted to determine the worst-case mode from all possible combinations between available modulations, data rates and antenna ports (if EUT with antenna diversity architecture).
- Following channel(s) was (were) selected for the final test as listed below.

MODE	AVAILABLE CHANNEL	TESTED CHANNEL	MODULATION TECHNOLOGY	MODULATION TYPE	DATA RATE (Mbps)
802.11b	1 to 11	1, 6, 11	DSSS	CCK	11
802.11g	1 to 11	1, 6, 11	OFDM	BPSK	6



### 3.2.3 GENERAL DESCRIPTION OF APPLIED STANDARDS

The EUT is a Wireless 11g Range Expander. According to the specifications of the manufacturer, it must comply with the requirements of the following standards:

**FCC Part 15, Subpart C. (15.247)**

**ANSI C63.4- 2003**

All test items have been performed and recorded as per the above standards.

**NOTE:** The EUT is also considered as a kind of computer peripheral, because the connection to computer is necessary for typical use. It has been verified to comply with the requirements of FCC Part 15, Subpart B, Class B (DoC). The test report has been issued separately.

### 3.2.4 DESCRIPTION OF SUPPORT UNITS

The EUT has been tested as an independent unit together with other necessary accessories or support units. The following support units or accessories were used to form a representative test configuration during the tests.

NO.	PRODUCT	BRAND	MODEL NO.	SERIAL NO.	FCC ID
1	NOTEBOOK COMPUTER	DELL	PP05L	12130898320	E2K24CLNS

NO.	SIGNAL CABLE DESCRIPTION OF THE ABOVE SUPPORT UNITS
1	NA

**NOTE:** 1. All power cords of the above support units are non shielded (1.8m).



## 4. TEST TYPES AND RESULTS

### 4.1 CONDUCTED EMISSION MEASUREMENT

#### 4.1.1 LIMITS OF CONDUCTED EMISSION MEASUREMENT

FREQUENCY OF EMISSION (MHz)	CONDUCTED LIMIT (dB $\mu$ V)	
	Quasi-peak	Average
0.15-0.5	66 to 56	56 to 46
0.5-5	56	46
5-30	60	50

- NOTE:**
1. The lower limit shall apply at the transition frequencies.
  2. The limit decreases in line with the logarithm of the frequency in the range of 0.15 to 0.50 MHz.
  3. All emanations from a class A/B digital device or system, including any network of conductors and apparatus connected thereto, shall not exceed the level of field strengths specified above.

#### 4.1.2 TEST INSTRUMENTS

DESCRIPTION & MANUFACTURER	MODEL NO.	SERIAL NO.	CALIBRATED UNTIL
Test Receiver ROHDE & SCHWARZ	ESCS30	100291	Nov. 16, 2005
RF signal cable Woken	5D-FB	Cable-HYC01-01	Jan. 09, 2006
LISN SCHWARZBECK	NNBL 8226-2	8226-142	May. 02, 2006
LISN ROHDE & SCHWARZ	ESH2-Z5	100104	Feb. 15, 2006
Software ADT	ADT_Cond_V3	NA	NA

- NOTE:**
1. The calibration interval of the above test instruments is 12 months and the calibrations are traceable to NML/ROC and NIST/USA.
  2. The test was performed in HwaYa Shielded Room 1.
  3. The VCCI Site Registration No. is C-2040.



#### 4.1.3 TEST PROCEDURES

- a. The EUT was placed 0.4 meters from the conducting wall of the shielded room with EUT being connected to the power mains through a line impedance stabilization network (LISN). Other support units were connected to the power mains through another LISN. The two LISNs provide 50 ohm/ 50uH of coupling impedance for the measuring instrument.
- b. Both lines of the power mains connected to the EUT were checked for maximum conducted interference.
- c. The frequency range from 150kHz to 30MHz was searched. Emission levels under (Limit - 20dB) was not recorded.

#### 4.1.4 DEVIATION FROM TEST STANDARD

No deviation

#### 4.1.5 TEST SETUP

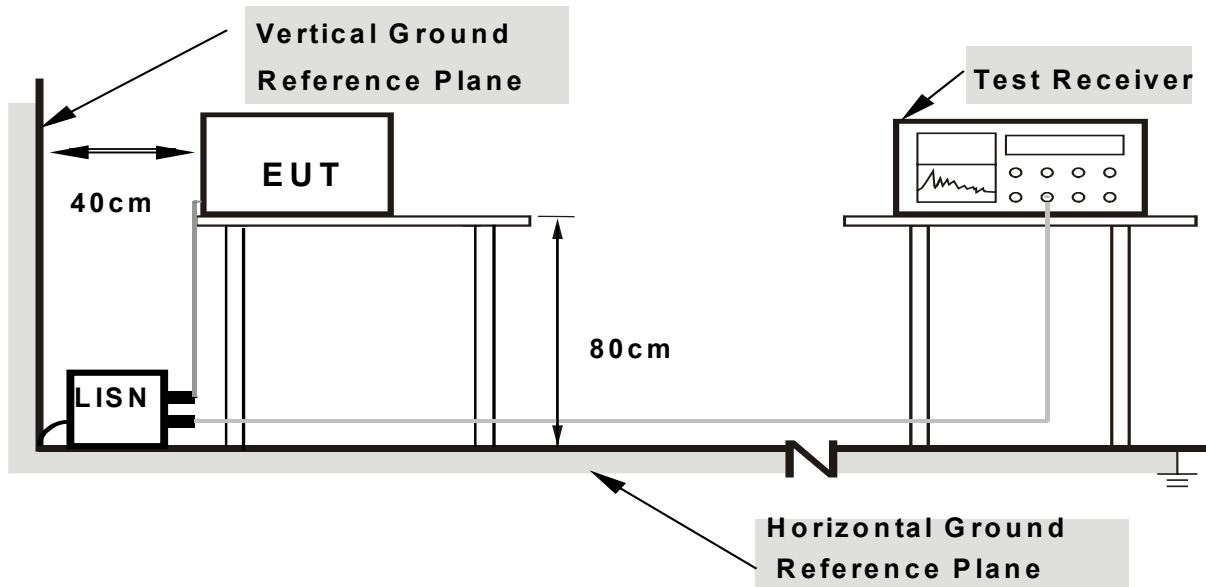

- Note:**
1. Support units were connected to second LISN.
  2. Both of LISNs (AMN) are 80 cm from EUT and at least 80 cm from other units and other metal planes

For the actual test configuration, please refer to the related item – Photographs of the Test Configuration.

#### 4.1.6 EUT OPERATING CONDITIONS

- a. Placed the EUT on the testing table.
- b. Prepared another notebook system to act as a communication partner and placed it outside of testing area.
- c. The communication partner run a test program (provided by manufacturer) to enable EUT under transmission/receiving condition continuously at specific channel frequency via an RJ45 cable.
- d. The communication partner sent data to EUT by command "PING".



4.1.7 TEST RESULTS

CONDUCTED WORST-CASE DATA

<b>EUT</b>	Wireless 11g Range Expander	<b>MEASUREMENT DETAIL</b>	
<b>MODEL</b>	WACM-123G	<b>PHASE</b>	Line 1
<b>CHANNEL</b>	Channel 1	<b>6dB BANDWIDTH</b>	9 kHz
<b>MODULATION TYPE</b>	BPSK	<b>ENVIRONMENTAL CONDITIONS</b>	25deg. C, 68%RH, 991hPa
<b>TRANSFER RATE</b>	6Mbps	<b>INPUT POWER (SYSTEM)</b>	120Vac, 60 Hz
<b>TESTED BY</b>	William Chien		

No	Freq. [MHz]	Corr. Factor (dB)	Reading Value [dB (uV)]		Emission Level [dB (uV)]		Limit [dB (uV)]		Margin (dB)	
			Q.P.	AV.	Q.P.	AV.	Q.P.	AV.	Q.P.	AV.
			1	0.357	0.11	37.42	-	37.53	-	58.80
2	0.564	0.15	29.24	-	29.39	-	56.00	46.00	-26.61	-
3	0.959	0.23	27.44	-	27.67	-	56.00	46.00	-28.33	-
4	6.809	0.46	28.66	-	29.12	-	60.00	50.00	-30.88	-
5	13.527	0.55	18.30	-	18.85	-	60.00	50.00	-41.15	-
6	26.426	1.52	21.17	-	22.69	-	60.00	50.00	-37.31	-

- REMARKS:**
1. Q.P. and AV. are abbreviations of quasi-peak and average individually.
  2. "-": The Quasi-peak reading value also meets average limit and measurement with the average detector is unnecessary.
  3. The emission levels of other frequencies were very low against the limit.
  4. Margin value = Emission level - Limit value
  5. Correction factor = Insertion loss + Cable loss
  6. Emission Level = Correction Factor + Reading Value.

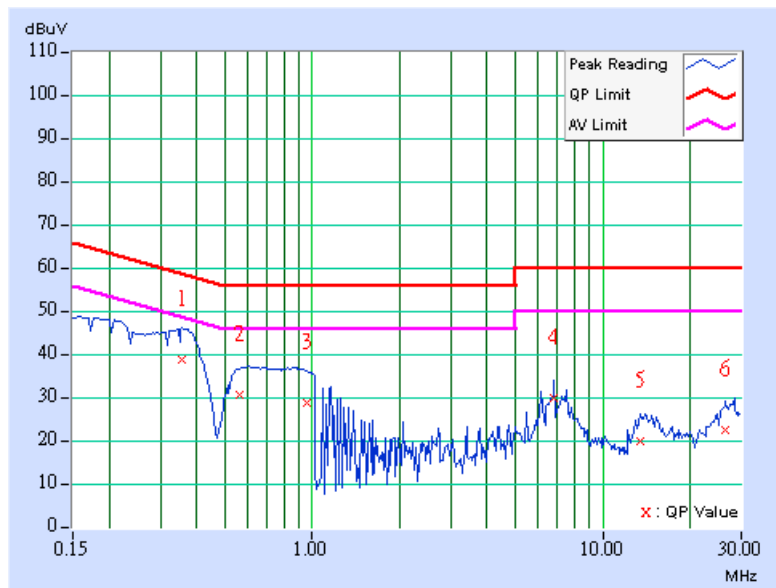



<b>EUT</b>	Wireless 11g Range Expander	<b>MEASUREMENT DETAIL</b>	
<b>MODEL</b>	WACM-123G	<b>PHASE</b>	Line 2
<b>CHANNEL</b>	Channel 1	<b>6dB BANDWIDTH</b>	9 kHz
<b>MODULATION TYPE</b>	BPSK	<b>ENVIRONMENTAL CONDITIONS</b>	25deg. C, 68%RH, 991hPa
<b>TRANSFER RATE</b>	6Mbps	<b>INPUT POWER (SYSTEM)</b>	120Vac, 60 Hz
<b>TESTED BY</b>	William Chien		

No	Freq. [MHz]	Corr. Factor (dB)	Reading Value [dB (uV)]		Emission Level [dB (uV)]		Limit [dB (uV)]		Margin (dB)	
			Q.P.	AV.	Q.P.	AV.	Q.P.	AV.	Q.P.	AV.
			1	0.244	0.11	36.58	-	36.69	-	61.97
2	0.533	0.14	32.90	-	33.04	-	56.00	46.00	-22.96	-
3	0.990	0.24	24.08	-	24.32	-	56.00	46.00	-31.68	-
4	6.785	0.41	31.23	-	31.64	-	60.00	50.00	-28.36	-
5	13.645	0.45	20.44	-	20.89	-	60.00	50.00	-39.11	-
6	27.059	1.02	20.04	-	21.06	-	60.00	50.00	-38.94	-

- REMARKS:**
1. Q.P. and AV. are abbreviations of quasi-peak and average individually.
  2. "-": The Quasi-peak reading value also meets average limit and measurement with the average detector is unnecessary.
  3. The emission levels of other frequencies were very low against the limit.
  4. Margin value = Emission level - Limit value
  5. Correction factor = Insertion loss + Cable loss
  6. Emission Level = Correction Factor + Reading Value.

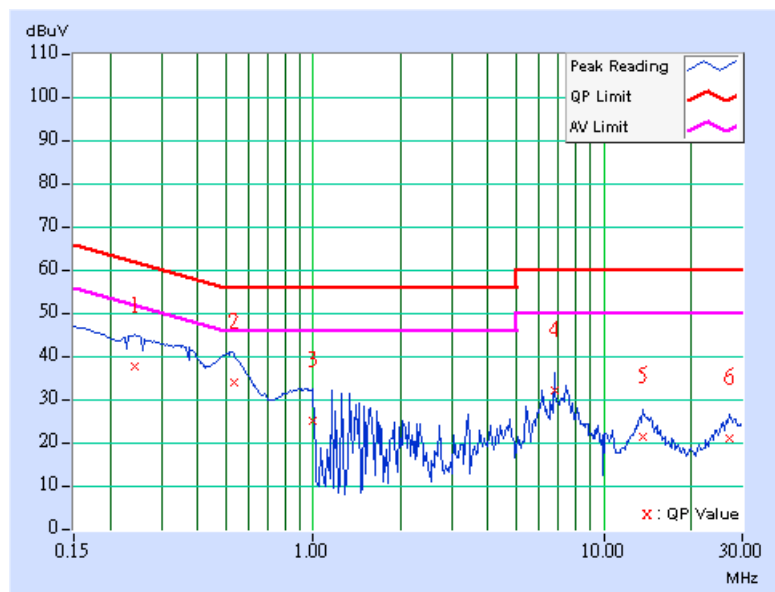



<b>EUT</b>	Wireless 11g Range Expander	<b>MEASUREMENT DETAIL</b>	
<b>MODEL</b>	WACM-123G	<b>PHASE</b>	Line 1
<b>CHANNEL</b>	Channel 6	<b>6dB BANDWIDTH</b>	9 kHz
<b>MODULATION TYPE</b>	BPSK	<b>ENVIRONMENTAL CONDITIONS</b>	25deg. C, 68%RH, 991hPa
<b>TRANSFER RATE</b>	6Mbps	<b>INPUT POWER (SYSTEM)</b>	120Vac, 60 Hz
<b>TESTED BY</b>	William Chien		

No	Freq. [MHz]	Corr. Factor (dB)	Reading Value [dB (uV)]		Emission Level [dB (uV)]		Limit [dB (uV)]		Margin (dB)	
			Q.P.	AV.	Q.P.	AV.	Q.P.	AV.	Q.P.	AV.
			1	0.365	0.11	37.47	-	37.58	-	58.62
2	0.572	0.15	29.65	-	29.80	-	56.00	46.00	-26.20	-
3	0.923	0.22	28.45	-	28.67	-	56.00	46.00	-27.33	-
4	1.395	0.25	20.34	-	20.59	-	56.00	46.00	-35.41	-
5	6.770	0.46	30.39	-	30.85	-	60.00	50.00	-29.15	-
6	13.512	0.55	21.49	-	22.04	-	60.00	50.00	-37.96	-

- REMARKS:**
1. Q.P. and AV. are abbreviations of quasi-peak and average individually.
  2. "-": The Quasi-peak reading value also meets average limit and measurement with the average detector is unnecessary.
  3. The emission levels of other frequencies were very low against the limit.
  4. Margin value = Emission level - Limit value
  5. Correction factor = Insertion loss + Cable loss
  6. Emission Level = Correction Factor + Reading Value.

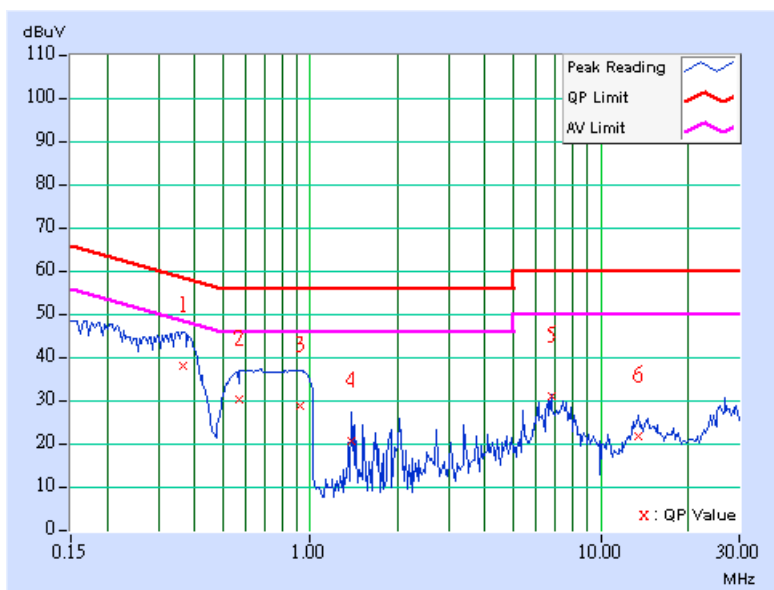





<b>EUT</b>	Wireless 11g Range Expander	<b>MEASUREMENT DETAIL</b>	
<b>MODEL</b>	WACM-123G	<b>PHASE</b>	Line 2
<b>CHANNEL</b>	Channel 6	<b>6dB BANDWIDTH</b>	9 kHz
<b>MODULATION TYPE</b>	BPSK	<b>ENVIRONMENTAL CONDITIONS</b>	25deg. C, 68%RH, 991hPa
<b>TRANSFER RATE</b>	6Mbps	<b>INPUT POWER (SYSTEM)</b>	120Vac, 60 Hz
<b>TESTED BY</b>	William Chien		

No	Freq. [MHz]	Corr. Factor (dB)	Reading Value [dB (uV)]		Emission Level [dB (uV)]		Limit [dB (uV)]		Margin (dB)	
			Q.P.	AV.	Q.P.	AV.	Q.P.	AV.	Q.P.	AV.
			1	0.240	0.11	36.52	-	36.63	-	62.10
2	0.498	0.13	33.35	-	33.48	-	56.04	46.04	-22.56	-
3	1.152	0.24	25.58	-	25.82	-	56.00	46.00	-30.18	-
4	1.539	0.25	21.13	-	21.38	-	56.00	46.00	-34.62	-
5	6.762	0.41	31.61	-	32.02	-	60.00	50.00	-27.98	-
6	13.543	0.45	21.14	-	21.59	-	60.00	50.00	-38.41	-

- REMARKS:**
1. Q.P. and AV. are abbreviations of quasi-peak and average individually.
  2. "-": The Quasi-peak reading value also meets average limit and measurement with the average detector is unnecessary.
  3. The emission levels of other frequencies were very low against the limit.
  4. Margin value = Emission level - Limit value
  5. Correction factor = Insertion loss + Cable loss
  6. Emission Level = Correction Factor + Reading Value.

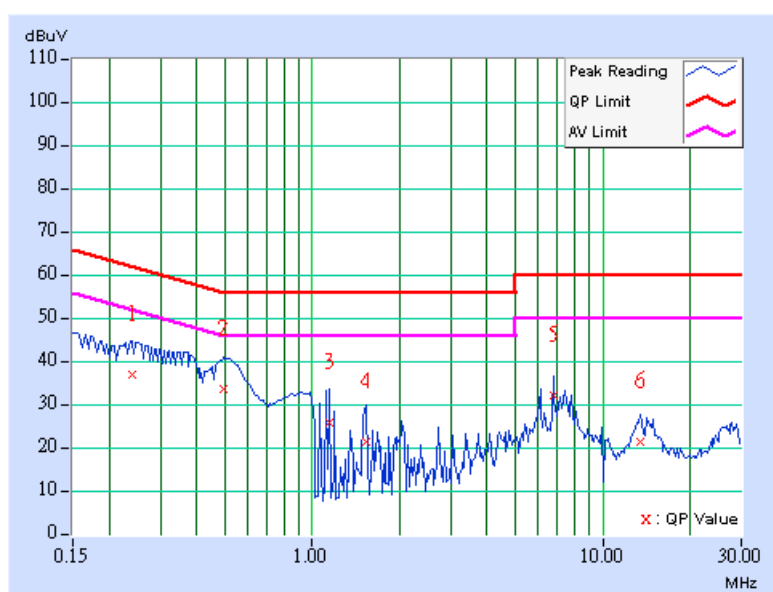



<b>EUT</b>	Wireless 11g Range Expander	<b>MEASUREMENT DETAIL</b>	
<b>MODEL</b>	WACM-123G	<b>PHASE</b>	Line 1
<b>CHANNEL</b>	Channel 11	<b>6dB BANDWIDTH</b>	9 kHz
<b>MODULATION TYPE</b>	BPSK	<b>ENVIRONMENTAL CONDITIONS</b>	25deg. C, 68%RH, 991hPa
<b>TRANSFER RATE</b>	6Mbps	<b>INPUT POWER (SYSTEM)</b>	120Vac, 60 Hz
<b>TESTED BY</b>	William Chien		

No	Freq. [MHz]	Corr. Factor (dB)	Reading Value [dB (uV)]		Emission Level [dB (uV)]		Limit [dB (uV)]		Margin (dB)	
			Q.P.	AV.	Q.P.	AV.	Q.P.	AV.	Q.P.	AV.
			1	0.349	0.11	37.11	-	37.22	-	58.98
2	0.568	0.15	29.41	-	29.56	-	56.00	46.00	-26.44	-
3	0.935	0.23	28.19	-	28.42	-	56.00	46.00	-27.58	-
4	1.066	0.24	26.57	-	26.81	-	56.00	46.00	-29.19	-
5	6.102	0.44	27.12	-	27.56	-	60.00	50.00	-32.44	-
6	27.438	1.65	20.70	-	22.35	-	60.00	50.00	-37.65	-

- REMARKS:**
1. Q.P. and AV. are abbreviations of quasi-peak and average individually.
  2. "-": The Quasi-peak reading value also meets average limit and measurement with the average detector is unnecessary.
  3. The emission levels of other frequencies were very low against the limit.
  4. Margin value = Emission level - Limit value
  5. Correction factor = Insertion loss + Cable loss
  6. Emission Level = Correction Factor + Reading Value.

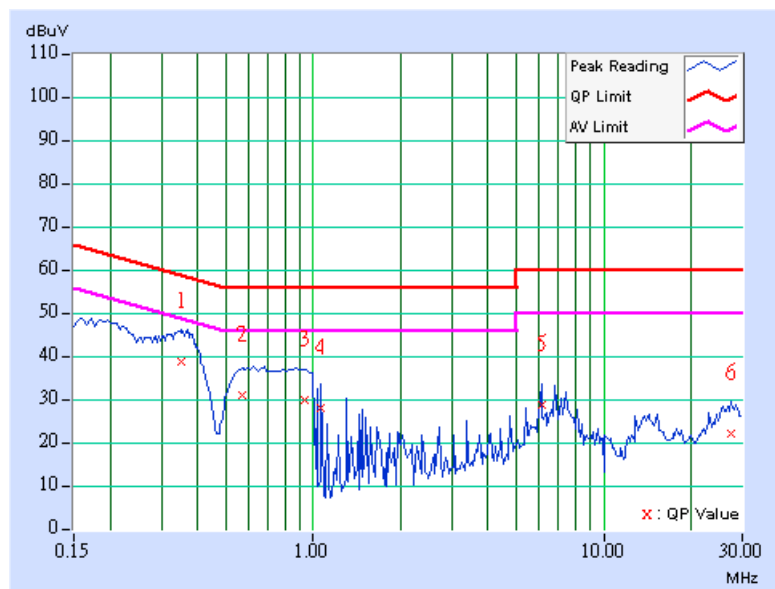



<b>EUT</b>	Wireless 11g Range Expander	<b>MEASUREMENT DETAIL</b>	
<b>MODEL</b>	WACM-123G	<b>PHASE</b>	Line 2
<b>CHANNEL</b>	Channel 11	<b>6dB BANDWIDTH</b>	9 kHz
<b>MODULATION TYPE</b>	BPSK	<b>ENVIRONMENTAL CONDITIONS</b>	25deg. C, 68%RH, 991hPa
<b>TRANSFER RATE</b>	6Mbps	<b>INPUT POWER (SYSTEM)</b>	120Vac, 60 Hz
<b>TESTED BY</b>	William Chien		

No	Freq. [MHz]	Corr. Factor (dB)	Reading Value [dB (uV)]		Emission Level [dB (uV)]		Limit [dB (uV)]		Margin (dB)	
			Q.P.	AV.	Q.P.	AV.	Q.P.	AV.	Q.P.	AV.
			1	0.228	0.11	36.10	-	36.21	-	62.52
2	0.500	0.13	32.42	-	32.55	-	56.00	46.00	-23.45	-
3	1.141	0.24	25.90	-	26.14	-	56.00	46.00	-29.86	-
4	7.453	0.42	32.04	-	32.46	-	60.00	50.00	-27.54	-
5	13.563	0.45	20.84	-	21.29	-	60.00	50.00	-38.71	-
6	28.652	1.15	16.75	-	17.90	-	60.00	50.00	-42.10	-

- REMARKS:**
1. Q.P. and AV. are abbreviations of quasi-peak and average individually.
  2. "-": The Quasi-peak reading value also meets average limit and measurement with the average detector is unnecessary.
  3. The emission levels of other frequencies were very low against the limit.
  4. Margin value = Emission level - Limit value
  5. Correction factor = Insertion loss + Cable loss
  6. Emission Level = Correction Factor + Reading Value.

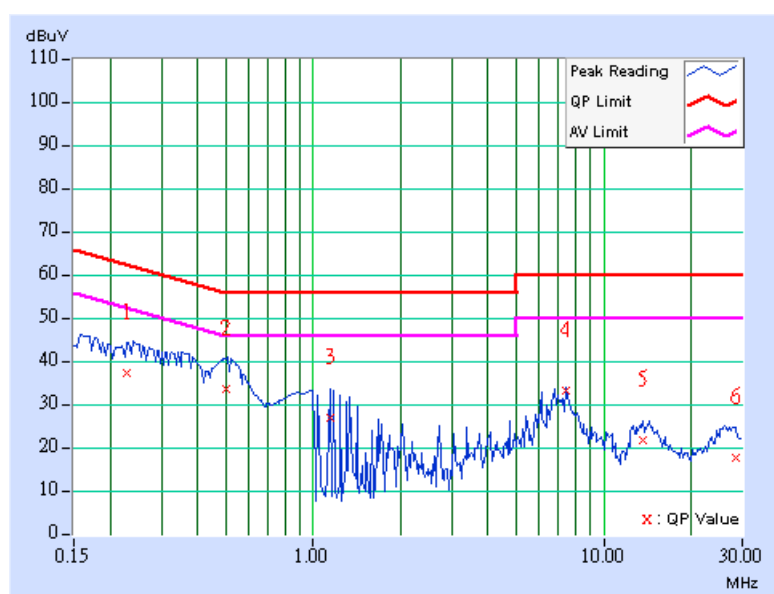



## 4.2 RADIATED EMISSION MEASUREMENT

### 4.2.1 LIMITS OF RADIATED EMISSION MEASUREMENT

Emissions radiated outside of the specified bands, shall be according to the general radiated limits in 15.209 as following:

FREQUENCIES (MHz)	FIELD STRENGTH (microvolts/meter)	MEASUREMENT DISTANCE (meters)
0.009 ~ 0.490	2400/F(kHz)	300
0.490 ~ 1.705	24000/F(kHz)	30
1.705 ~ 30.0	30	30
30 ~ 88	100	3
88 ~ 216	150	3
216 ~ 960	200	3
Above 960	500	3

**NOTE:**

1. The lower limit shall apply at the transition frequencies.
2. Emission level (dBuV/m) = 20 log Emission level (uV/m).
3. As shown in 15.35(b), for frequencies above 1000MHz, the field strength limits are based on average detector, however, the peak field strength of any emission shall not exceed the maximum permitted average limits, specified above by more than 20dB under any condition of modulation.



#### 4.2.2 TEST INSTRUMENTS

DESCRIPTION & MANUFACTURER	MODEL NO.	SERIAL NO.	CALIBRATED UNTIL
Test Receiver ROHDE & SCHWARZ	ESIB7	100188	Dec. 19, 2005
Spectrum Analyzer ROHDE & SCHWARZ	FSP40	100039	Nov. 21, 2005
BILOG Antenna SCHWARZBECK	VULB9168	9168-157	Jan. 22, 2006
HORN Antenna SCHWARZBECK	BBHA 9120 D	9120D-407	Jan. 16, 2006
HORN Antenna SCHWARZBECK	BBHA 9170	BBHA 9170241	Feb. 23, 2006
Preamplifier Agilent	8449B	3008A01961	Nov. 09, 2005
Preamplifier Agilent	8447D	2944A10629	Nov. 09, 2005
RF signal cable HUBER+SUHNER	SUCOFLEX 104	218182/4	Feb. 17, 2006
RF signal cable HUBER+SUHNER	SUCOFLEX 104	218194/4	Feb. 17, 2006
Software ADT.	ADT_Radiated_V5.14	NA	NA
Antenna Tower ADT.	AT100	AT93021702	NA
Turn Table ADT.	TT100.	TT93021702	NA
Controller ADT.	SC100.	SC93021702	NA

- NOTE:**
1. The calibration interval of the above test instruments is 12 months and the calibrations are traceable to NML/ROC and NIST/USA.
  2. The test was performed in HwaYa Chamber 1.
  3. The horn antenna and HP preamplifier (model: 8449B) are used only for the measurement of emission frequency above 1GHz if tested.
  4. The IC Site Registration No. is IC4924-2.



#### 4.2.3 TEST PROCEDURES

- a. The EUT was placed on the top of a rotating table 0.8 meters above the ground at a 3 meter semi-anechoic chamber. The table was rotated 360 degrees to determine the position of the highest radiation.
- b. The EUT was set 3 meters away from the interference-receiving antenna, which was mounted on the top of a variable-height antenna tower.
- c. The antenna is a broadband antenna, and its height is varied from one meter to four meters above the ground to determine the maximum value of the field strength. Both horizontal and vertical polarizations of the antenna are set to make the measurement.
- d. For each suspected emission, the EUT was arranged to its worst case and then the antenna was tuned to heights from 1 meter to 4 meters and the rotatable table was turned from 0 degrees to 360 degrees to find the maximum reading.
- e. The test-receiver system was set to Peak Detect Function and Specified Bandwidth with Maximum Hold Mode.
- f. If the emission level of the EUT in peak mode was lower than the limit specified, then testing could be stopped and the peak values of the EUT would be reported. Otherwise the emissions would be re-tested one by one using peak, quasi-peak method or average method as specified and then reported in data sheet.

**NOTE:**

1. The resolution bandwidth and video bandwidth of test receiver/spectrum analyzer is 120kHz for Quasi-peak detection at frequency below 1GHz.
2. The resolution bandwidth and video bandwidth of test receiver/spectrum analyzer is 1 MHz for Peak detection (PK) at frequency above 1GHz.
3. The resolution bandwidth of test receiver/spectrum analyzer is 1 MHz and the video bandwidth is 10 Hz for Average detection (AV) at frequency above 1GHz.

#### 4.2.4 DEVIATION FROM TEST STANDARD

No deviation

#### 4.2.5 TEST SETUP

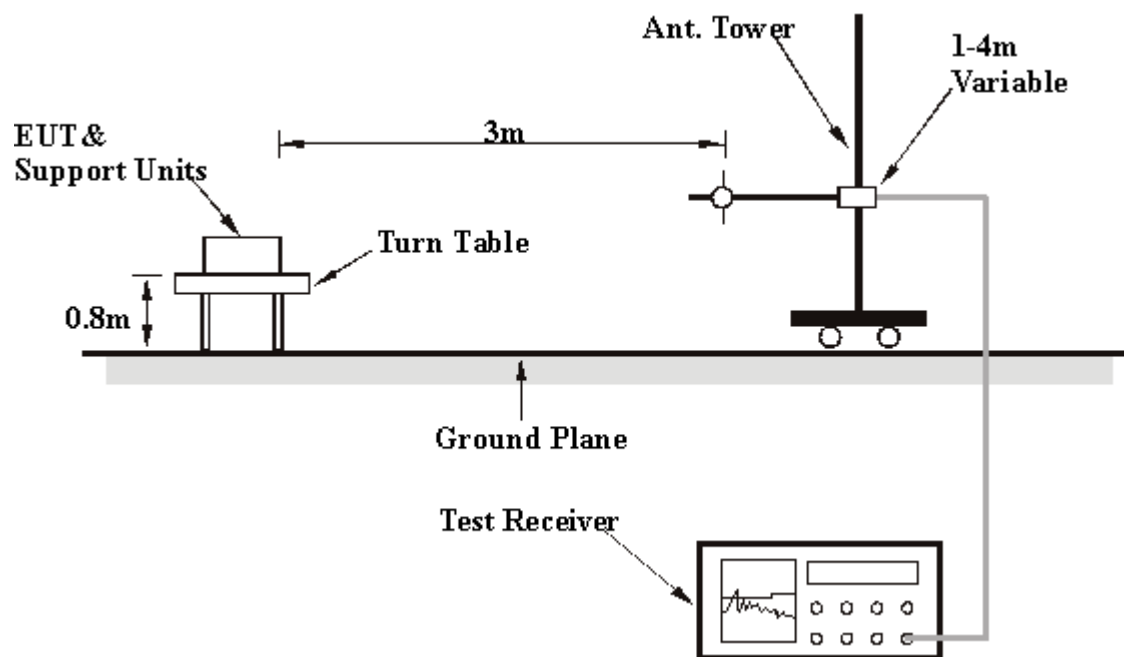

For the actual test configuration, please refer to the related item – Photographs of the Test Configuration.

#### 4.2.6 EUT OPERATING CONDITIONS

Same as 4.1.6



## 4.2.7 TEST RESULTS

## RADIATED WORST-CASE DATA: BELOW 1GHz

<b>EUT</b>	Wireless 11g Range Expander	<b>MEASUREMENT DETAIL</b>	
<b>MODEL</b>	WACM-123G	<b>FREQUENCY RANGE</b>	Below 1000MHz
<b>CHANNEL</b>	Channel 11	<b>DETECTOR FUNCTION</b>	Quasi-Peak
<b>MODULATION TYPE</b>	BPSK	<b>ENVIRONMENTAL CONDITIONS</b>	26deg. C, 69%RH, 991hPa
<b>TRANSFER RATE</b>	6Mbps	<b>INPUT POWER (SYSTEM)</b>	120Vac, 60 Hz
<b>TESTED BY</b>	Match Tsui		

**ANTENNA POLARITY & TEST DISTANCE: HORIZONTAL AT 3 M**

No.	Freq. (MHz)	Emission Level (dBuV/m)	Limit (dBuV/m)	Margin (dB)	Antenna Height (m)	Table Angle (Degree)	Raw Value (dBuV)	Correction Factor (dB/m)
1	160.24	37.42 QP	43.50	-6.08	1.75 H	247	22.79	14.63
2	319.64	38.91 QP	46.00	-7.09	1.00 H	13	24.14	14.77
3	479.04	39.17 QP	46.00	-6.83	1.75 H	349	20.86	18.30
4	640.38	39.11 QP	46.00	-6.89	1.25 H	67	17.66	21.45
5	800.00	42.94 QP	46.00	-3.06	1.00 H	307	19.24	23.70
6	961.12	41.68 QP	54.00	-12.32	1.25 H	40	16.05	25.62

**ANTENNA POLARITY & TEST DISTANCE: VERTICAL AT 3 M**

No.	Freq. (MHz)	Emission Level (dBuV/m)	Limit (dBuV/m)	Margin (dB)	Antenna Height (m)	Table Angle (Degree)	Raw Value (dBuV)	Correction Factor (dB/m)
1	47.49	32.52 QP	40.00	-7.48	1.00 V	10	17.75	14.76
2	84.43	36.48 QP	40.00	-3.52	1.25 V	40	26.64	9.84
3	160.24	40.63 QP	43.50	-2.87	1.00 V	10	25.99	14.63
4	319.64	40.10 QP	46.00	-5.90	1.50 V	319	25.33	14.77
5	479.04	37.91 QP	46.00	-8.09	1.25 V	121	19.61	18.30
6	640.38	38.11 QP	46.00	-7.89	1.50 V	346	16.65	21.45
7	799.78	41.52 QP	46.00	-4.48	1.25 V	328	17.82	23.70

- REMARKS:**
1. Emission level (dBuV/m) = Raw Value (dBuV) + Correction Factor (dB/m).
  2. Correction Factor (dB/m) = Antenna Factor (dB/m) + Cable Factor (dB).
  3. The other emission levels were very low against the limit.
  4. Margin value = Emission level – Limit value.



**802.11b DSSS MODULATION**

<b>EUT</b>	Wireless 11g Range Expander	<b>MEASUREMENT DETAIL</b>	
<b>MODEL</b>	WACM-123G	<b>FREQUENCY RANGE</b>	1 ~ 25GHz
<b>CHANNEL</b>	Channel 1	<b>DETECTOR FUNCTION</b>	Peak (PK) Average (AV)
<b>MODULATION TYPE</b>	CCK	<b>ENVIRONMENTAL CONDITIONS</b>	25deg. C, 65%RH, 991hPa
<b>TRANSFER RATE</b>	11Mbps	<b>INPUT POWER (SYSTEM)</b>	120Vac, 60 Hz
<b>TESTED BY</b>	Jamison Chen		

<b>ANTENNA POLARITY &amp; TEST DISTANCE: HORIZONTAL AT 3 M</b>								
No.	Freq. (MHz)	Emission Level (dBuV/m)	Limit (dBuV/m)	Margin (dB)	Antenna Height (m)	Table Angle (Degree)	Raw Value (dBuV)	Correction Factor (dB/m)
1	1280.00	51.52 PK	85.74	-34.22	1.11 H	61	23.40	28.12
1	1280.00	49.68 AV	77.81	-28.13	1.11 H	61	21.56	28.12
2	2240.00	52.23 PK	74.00	-21.77	1.29 H	238	20.84	31.39
2	2240.00	47.97 AV	54.00	-6.03	1.29 H	238	16.58	31.39
3	2360.00	57.99 PK	74.00	-16.01	1.07 H	105	26.09	31.90
3	2360.00	47.32 AV	54.00	-6.68	1.07 H	105	15.42	31.90
4	*2412.00	105.74 PK			1.07 H	105	73.61	32.13
4	*2412.00	97.81 AV			1.07 H	105	65.68	32.13
5	4824.00	47.12 PK	74.00	-26.88	1.24 H	145	8.93	38.20
5	4824.00	35.09 AV	54.00	-18.91	1.24 H	145	-3.10	38.20

<b>ANTENNA POLARITY &amp; TEST DISTANCE: VERTICAL AT 3 M</b>								
No.	Freq. (MHz)	Emission Level (dBuV/m)	Limit (dBuV/m)	Margin (dB)	Antenna Height (m)	Table Angle (Degree)	Raw Value (dBuV)	Correction Factor (dB/m)
1	1280.00	46.81 PK	94.45	-47.64	1.15 V	116	17.43	29.38
1	1280.00	43.79 AV	86.26	-42.47	1.15 V	116	14.41	29.38
2	2240.00	56.39 PK	74.00	-17.61	1.09 V	160	23.67	32.72
<b>2</b>	<b>2240.00</b>	<b>52.45 AV</b>	<b>54.00</b>	<b>-1.55</b>	<b>1.09 V</b>	<b>160</b>	<b>19.73</b>	<b>32.72</b>
3	2360.00	61.88 PK	74.00	-12.12	1.09 V	160	28.69	33.19
3	2360.00	51.28 AV	54.00	-2.72	1.09 V	160	18.09	33.19
4	*2412.00	114.45 PK			1.09 V	160	81.04	33.41
4	*2412.00	106.26 AV			1.09 V	160	72.85	33.41
5	4824.00	51.53 PK	74.00	-22.47	1.15 V	211	11.74	39.79
5	4824.00	39.15 AV	54.00	-14.85	1.15 V	211	-0.64	39.79

- REMARKS:**
1. Emission level (dBuV/m) = Raw Value (dBuV) + Correction Factor (dB/m).
  2. Correction Factor (dB/m) = Antenna Factor (dB/m) + Cable Factor (dB).
  3. The other emission levels were very low against the limit.
  4. Margin value = Emission level – Limit value.
  5. “ \* “: Fundamental frequency.



<b>EUT</b>	Wireless 11g Range Expander	<b>MEASUREMENT DETAIL</b>	
<b>MODEL</b>	WACM-123G	<b>FREQUENCY RANGE</b>	1 ~ 25GHz
<b>CHANNEL</b>	Channel 6	<b>DETECTOR FUNCTION</b>	Peak (PK) Average (AV)
<b>MODULATION TYPE</b>	CCK	<b>ENVIRONMENTAL CONDITIONS</b>	25deg. C, 65%RH, 991hPa
<b>TRANSFER RATE</b>	11Mbps	<b>INPUT POWER (SYSTEM)</b>	120Vac, 60 Hz
<b>TESTED BY</b>	Jamison Chen		

#### ANTENNA POLARITY & TEST DISTANCE: HORIZONTAL AT 3 M

No.	Freq. (MHz)	Emission Level (dBuV/m)	Limit (dBuV/m)	Margin (dB)	Antenna Height (m)	Table Angle (Degree)	Raw Value (dBuV)	Correction Factor (dB/m)
1	1280.00	53.31 PK	88.16	-34.85	1.30 H	25	23.93	29.38
1	1280.00	51.59 AV	79.94	-28.35	1.30 H	25	22.21	29.38
2	*2437.00	108.16 PK			1.28 H	237	74.64	33.52
2	*2437.00	99.94 AV			1.28 H	237	66.42	33.52
3	4874.00	50.65 PK	74.00	-23.35	1.00 H	236	10.72	39.93
3	4874.00	37.36 AV	54.00	-16.64	1.00 H	236	-2.57	39.93

#### ANTENNA POLARITY & TEST DISTANCE: VERTICAL AT 3 M

No.	Freq. (MHz)	Emission Level (dBuV/m)	Limit (dBuV/m)	Margin (dB)	Antenna Height (m)	Table Angle (Degree)	Raw Value (dBuV)	Correction Factor (dB/m)
1	1280.00	48.67 PK	96.92	-48.25	1.20 V	338	20.55	28.12
1	1280.00	45.53 AV	88.65	-43.12	1.20 V	338	17.41	28.12
2	*2437.00	116.92 PK			1.00 V	359	84.67	32.25
2	*2437.00	108.65 AV			1.00 V	359	76.40	32.25
3	4874.00	57.94 PK	74.00	-16.06	1.21 V	237	19.62	38.32
3	4874.00	46.08 AV	54.00	-7.92	1.21 V	237	7.76	38.32

- REMARKS:**
1. Emission level (dBuV/m) = Raw Value (dBuV) + Correction Factor (dB/m).
  2. Correction Factor (dB/m) = Antenna Factor (dB/m) + Cable Factor (dB).
  3. The other emission levels were very low against the limit.
  4. Margin value = Emission level – Limit value.
  5. “ \* “: Fundamental frequency.



<b>EUT</b>	Wireless 11g Range Expander	<b>MEASUREMENT DETAIL</b>	
<b>MODEL</b>	WACM-123G	<b>FREQUENCY RANGE</b>	1 ~ 25GHz
<b>CHANNEL</b>	Channel 11	<b>DETECTOR FUNCTION</b>	Peak (PK) Average (AV)
<b>MODULATION TYPE</b>	CCK	<b>ENVIRONMENTAL CONDITIONS</b>	25deg. C, 65%RH, 991hPa
<b>TRANSFER RATE</b>	11Mbps	<b>INPUT POWER (SYSTEM)</b>	120Vac, 60 Hz
<b>TESTED BY</b>	Jamison Chen		

### ANTENNA POLARITY & TEST DISTANCE: HORIZONTAL AT 3 M

No.	Freq. (MHz)	Emission Level (dBuV/m)	Limit (dBuV/m)	Margin (dB)	Antenna Height (m)	Table Angle (Degree)	Raw Value (dBuV)	Correction Factor (dB/m)
1	1280.00	53.21 PK	80.07	-26.86	1.19 H	42	25.09	28.12
1	1280.00	51.52 AV	72.40	-20.88	1.19 H	42	23.40	28.12
2	*2462.00	100.07 PK			1.24 H	232	67.71	32.36
2	*2462.00	92.40 AV			1.24 H	232	60.04	32.36
3	2488.00	57.32 PK	74.00	-16.68	1.24 H	232	24.84	32.48
3	2488.00	46.78 AV	54.00	-7.22	1.24 H	232	14.30	32.48
4	4924.00	47.93 PK	74.00	-26.07	1.21 H	213	9.48	38.46
4	4924.00	35.12 AV	54.00	-18.88	1.21 H	213	-3.33	38.46

### ANTENNA POLARITY & TEST DISTANCE: VERTICAL AT 3 M

No.	Freq. (MHz)	Emission Level (dBuV/m)	Limit (dBuV/m)	Margin (dB)	Antenna Height (m)	Table Angle (Degree)	Raw Value (dBuV)	Correction Factor (dB/m)
1	1280.00	48.12 PK	91.54	-43.42	1.10 V	277	20.00	28.12
1	1280.00	45.48 AV	83.59	-38.11	1.10 V	277	17.36	28.12
2	*2462.00	111.54 PK			1.17 V	225	79.18	32.36
2	*2462.00	103.59 AV			1.17 V	225	71.23	32.36
3	2488.00	60.80 PK	74.00	-13.20	1.17 V	225	28.32	32.48
3	2488.00	50.74 AV	54.00	-3.26	1.17 V	225	18.26	32.48
4	4924.00	48.32 PK	74.00	-25.68	1.16 V	110	9.87	38.46
4	4924.00	33.95 AV	54.00	-20.05	1.16 V	110	-4.50	38.46

- REMARKS:**
1. Emission level (dBuV/m) = Raw Value (dBuV) + Correction Factor (dB/m).
  2. Correction Factor (dB/m) = Antenna Factor (dB/m) + Cable Factor (dB).
  3. The other emission levels were very low against the limit.
  4. Margin value = Emission level – Limit value.
  5. “ \* “: Fundamental frequency.



### 802.11g OFDM MODULATION

<b>EUT</b>	Wireless 11g Range Expander	<b>MEASUREMENT DETAIL</b>	
<b>MODEL</b>	WACM-123G	<b>FREQUENCY RANGE</b>	1 ~ 25GHz
<b>CHANNEL</b>	Channel 1	<b>DETECTOR FUNCTION</b>	Peak (PK) Average (AV)
<b>MODULATION TYPE</b>	BPSK	<b>ENVIRONMENTAL CONDITIONS</b>	25deg. C, 65%RH, 991hPa
<b>TRANSFER RATE</b>	6Mbps	<b>INPUT POWER (SYSTEM)</b>	120Vac, 60 Hz
<b>TESTED BY</b>	Jamison Chen		

#### ANTENNA POLARITY & TEST DISTANCE: HORIZONTAL AT 3 M

No.	Freq. (MHz)	Emission Level (dBuV/m)	Limit (dBuV/m)	Margin (dB)	Antenna Height (m)	Table Angle (Degree)	Raw Value (dBuV)	Correction Factor (dB/m)
1	1280.00	52.90 PK	77.31	-24.41	1.29 H	29	24.78	28.12
1	1280.00	51.31 AV	67.13	-15.82	1.29 H	29	23.19	28.12
2	2360.00	58.39 PK	74.00	-15.61	1.29 H	96	26.49	31.90
2	2360.00	47.51 AV	54.00	-6.49	1.29 H	96	15.61	31.90
3	*2412.00	97.31 PK			1.29 H	96	65.18	32.13
3	*2412.00	87.13 AV			1.29 H	96	55.00	32.13
4	4824.00	46.98 PK	74.00	-27.02	1.08 H	160	8.79	38.20
4	4824.00	33.32 AV	54.00	-20.68	1.08 H	160	-4.87	38.20

#### ANTENNA POLARITY & TEST DISTANCE: VERTICAL AT 3 M

No.	Freq. (MHz)	Emission Level (dBuV/m)	Limit (dBuV/m)	Margin (dB)	Antenna Height (m)	Table Angle (Degree)	Raw Value (dBuV)	Correction Factor (dB/m)
1	1280.00	49.05 PK	88.30	-39.25	1.24 V	336	20.93	28.12
1	1280.00	45.82 AV	78.92	-33.10	1.24 V	336	17.70	28.12
2	2360.00	60.99 PK	74.00	-13.01	1.08 V	153	29.09	31.90
2	2360.00	51.29 AV	54.00	-2.71	1.08 V	153	19.39	31.90
3	*2412.00	108.30 PK			1.08 V	153	76.17	32.13
3	*2412.00	98.92 AV			1.08 V	153	66.79	32.13
4	4824.00	48.56 PK	74.00	-25.44	1.22 V	242	10.37	38.20
4	4824.00	34.14 AV	54.00	-19.86	1.22 V	242	-4.05	38.20

- REMARKS:**
1. Emission level (dBuV/m) = Raw Value (dBuV) + Correction Factor (dB/m).
  2. Correction Factor (dB/m) = Antenna Factor (dB/m) + Cable Factor (dB).
  3. The other emission levels were very low against the limit.
  4. Margin value = Emission level – Limit value.
  5. “ \* “: Fundamental frequency.



<b>EUT</b>	Wireless 11g Range Expander	<b>MEASUREMENT DETAIL</b>	
<b>MODEL</b>	WACM-123G	<b>FREQUENCY RANGE</b>	1 ~ 25GHz
<b>CHANNEL</b>	Channel 6	<b>DETECTOR FUNCTION</b>	Peak (PK) Average (AV)
<b>MODULATION TYPE</b>	BPSK	<b>ENVIRONMENTAL CONDITIONS</b>	25deg. C, 65%RH, 991hPa
<b>TRANSFER RATE</b>	6Mbps	<b>INPUT POWER (SYSTEM)</b>	120Vac, 60 Hz
<b>TESTED BY</b>	Jamison Chen		

#### ANTENNA POLARITY & TEST DISTANCE: HORIZONTAL AT 3 M

No.	Freq. (MHz)	Emission Level (dBuV/m)	Limit (dBuV/m)	Margin (dB)	Antenna Height (m)	Table Angle (Degree)	Raw Value (dBuV)	Correction Factor (dB/m)
1	1280.00	53.29 PK	84.35	-31.06	1.21 H	41	25.17	28.12
1	1280.00	51.48 AV	74.95	-23.47	1.21 H	41	23.36	28.12
2	*2437.00	104.35 PK			1.49 H	226	72.10	32.25
2	*2437.00	94.95 AV			1.49 H	226	62.70	32.25
3	4874.00	47.38 PK	74.00	-26.62	1.17 H	120	9.06	38.32
3	4874.00	33.67 AV	54.00	-20.33	1.17 H	120	-4.65	38.32

#### ANTENNA POLARITY & TEST DISTANCE: VERTICAL AT 3 M

No.	Freq. (MHz)	Emission Level (dBuV/m)	Limit (dBuV/m)	Margin (dB)	Antenna Height (m)	Table Angle (Degree)	Raw Value (dBuV)	Correction Factor (dB/m)
1	1280.00	48.75 PK	91.13	-42.38	1.30 V	116	20.63	28.12
1	1280.00	45.92 AV	81.71	-35.79	1.30 V	116	17.80	28.12
2	*2437.00	111.13 PK			1.39 V	223	78.88	32.25
2	*2437.00	101.71 AV			1.39 V	223	69.46	32.25
3	4874.00	48.26 PK	74.00	-25.74	1.02 V	131	9.94	38.32
3	4874.00	34.08 AV	54.00	-19.92	1.02 V	131	-4.24	38.32

- REMARKS:**
1. Emission level (dBuV/m) = Raw Value (dBuV) + Correction Factor (dB/m).
  2. Correction Factor (dB/m) = Antenna Factor (dB/m) + Cable Factor (dB).
  3. The other emission levels were very low against the limit.
  4. Margin value = Emission level – Limit value.
  5. “ \* “: Fundamental frequency.



<b>EUT</b>	Wireless 11g Range Expander	<b>MEASUREMENT DETAIL</b>	
<b>MODEL</b>	WACM-123G	<b>FREQUENCY RANGE</b>	1 ~ 25GHz
<b>CHANNEL</b>	Channel 11	<b>DETECTOR FUNCTION</b>	Peak (PK) Average (AV)
<b>MODULATION TYPE</b>	BPSK	<b>ENVIRONMENTAL CONDITIONS</b>	25deg. C, 65%RH, 991hPa
<b>TRANSFER RATE</b>	6Mbps	<b>INPUT POWER (SYSTEM)</b>	120Vac, 60 Hz
<b>TESTED BY</b>	Jamison Chen		

### ANTENNA POLARITY & TEST DISTANCE: HORIZONTAL AT 3 M

No.	Freq. (MHz)	Emission Level (dBuV/m)	Limit (dBuV/m)	Margin (dB)	Antenna Height (m)	Table Angle (Degree)	Raw Value (dBuV)	Correction Factor (dB/m)
1	1280.00	53.04 PK	82.92	-29.88	1.23 H	45	23.66	29.38
1	1280.00	51.42 AV	73.30	-21.88	1.23 H	45	22.04	29.38
2	*2462.00	102.92 PK			1.17 H	232	69.29	33.63
2	*2462.00	93.30 AV			1.17 H	232	59.67	33.63
3	2488.00	58.57 PK	74.00	-15.43	1.17 H	232	24.83	33.74
3	2488.00	48.41 AV	54.00	-5.59	1.17 H	232	14.67	33.74
4	4924.00	47.73 PK	74.00	-26.27	1.17 H	45	7.65	40.08
4	4924.00	34.76 AV	54.00	-19.24	1.17 H	45	-5.32	40.08

### ANTENNA POLARITY & TEST DISTANCE: VERTICAL AT 3 M

No.	Freq. (MHz)	Emission Level (dBuV/m)	Limit (dBuV/m)	Margin (dB)	Antenna Height (m)	Table Angle (Degree)	Raw Value (dBuV)	Correction Factor (dB/m)
1	1280.00	48.57 PK	91.97	-43.40	1.27 V	120	20.45	28.12
1	1280.00	45.90 AV	81.13	-35.23	1.27 V	120	17.78	28.12
2	*2462.00	111.97 PK			1.00 V	360	79.61	32.36
2	*2462.00	101.13 AV			1.00 V	360	68.77	32.36
3	2486.00	62.21 PK	74.00	-11.79	1.00 V	360	29.74	32.47
3	2486.00	50.26 AV	54.00	-3.74	1.00 V	360	17.79	32.47
4	4924.00	47.84 PK	74.00	-26.16	1.49 V	349	9.39	38.46
4	4924.00	34.31 AV	54.00	-19.69	1.49 V	349	-4.14	38.46

- REMARKS:**
1. Emission level (dBuV/m) = Raw Value (dBuV) + Correction Factor (dB/m).
  2. Correction Factor (dB/m) = Antenna Factor (dB/m) + Cable Factor (dB).
  3. The other emission levels were very low against the limit.
  4. Margin value = Emission level – Limit value.
  5. “ \* “: Fundamental frequency.



### 4.3 6dB BANDWIDTH MEASUREMENT

#### 4.3.1 LIMITS OF 6dB BANDWIDTH MEASUREMENT

The minimum of 6dB Bandwidth Measurement is 0.5 MHz.

#### 4.3.2 TEST INSTRUMENTS

DESCRIPTION & MANUFACTURER	MODEL NO.	SERIAL NO.	CALIBRATED UNTIL
SPECTRUM ANALYZER	FSEK 30	100049	Aug. 14, 2006

**NOTE:** The calibration interval of the above test instruments is 12 months and the calibrations are traceable to NML/ROC and NIST/USA.

#### 4.3.3 TEST PROCEDURE

The transmitter output was connected to the spectrum analyzer through an attenuator. The bandwidth of the fundamental frequency was measured by spectrum analyzer with 100kHz RBW and 100kHz VBW. The 6dB bandwidth is defined as the total spectrum the power of which is higher than peak power minus 6dB.

#### 4.3.4 DEVIATION FROM TEST STANDARD

No deviation

#### 4.3.5 TEST SETUP

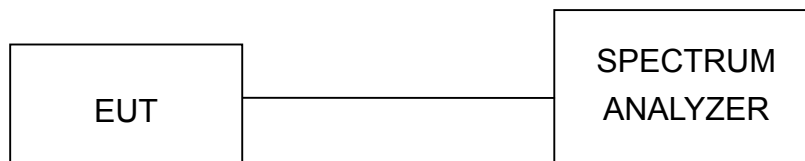

#### 4.3.6 EUT OPERATING CONDITIONS

The software provided by client to enable the EUT under transmission condition continuously at lowest, middle and highest channel frequencies individually.





4.3.7 TEST RESULTS

**802.11b DSSS MODULATION**

<b>EUT</b>	Wireless 11g Range Expander	<b>MODEL</b>	WACM-123G
<b>MODULATION TYPE</b>	CCK	<b>TRANSFER RATE</b>	11Mbps
<b>INPUT POWER (SYSTEM)</b>	120Vac, 60 Hz	<b>ENVIRONMENTAL CONDITIONS</b>	25deg. C, 69%RH, 991hPa
<b>TESTED BY</b>	Match Tsui		

<b>CHANNEL</b>	<b>CHANNEL FREQUENCY (MHz)</b>	<b>6dB BANDWIDTH (MHz)</b>	<b>MINIMUM LIMIT (MHz)</b>	<b>PASS/FAIL</b>
1	2412	9.52	0.5	PASS
6	2437	9.40	0.5	PASS
11	2462	8.28	0.5	PASS



CH1

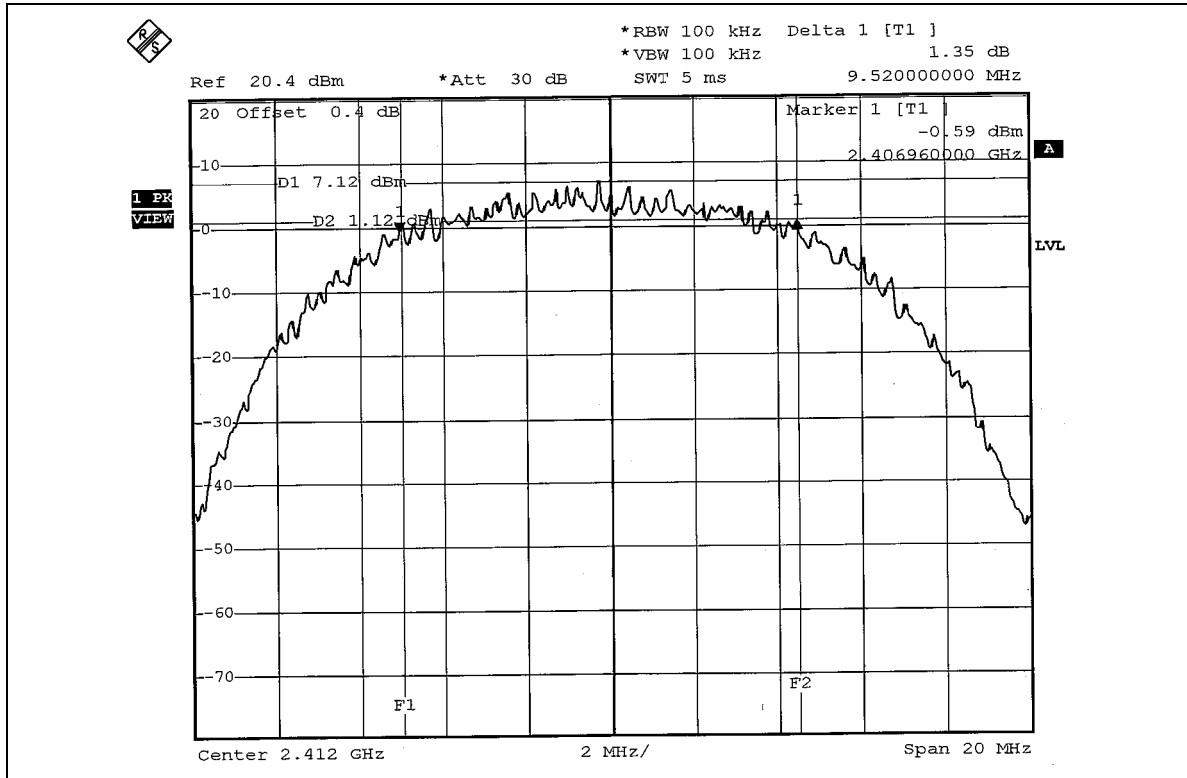

CH6

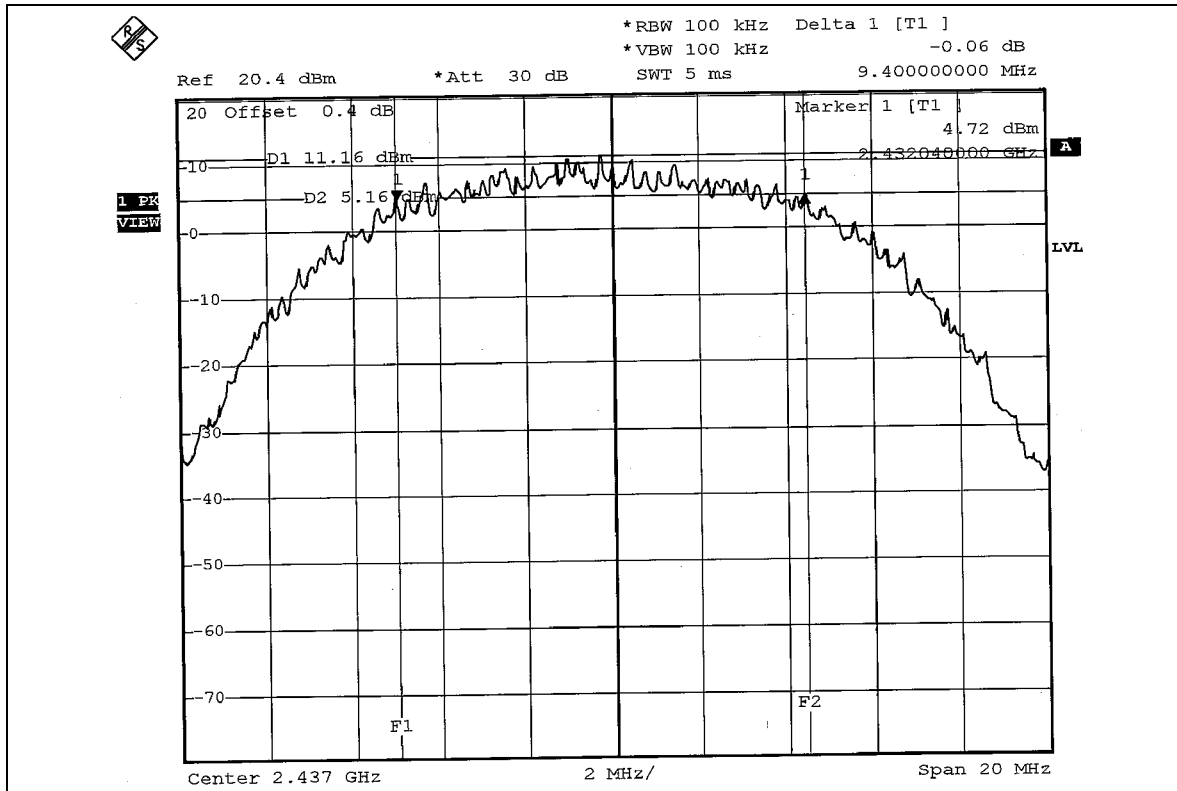



CH11

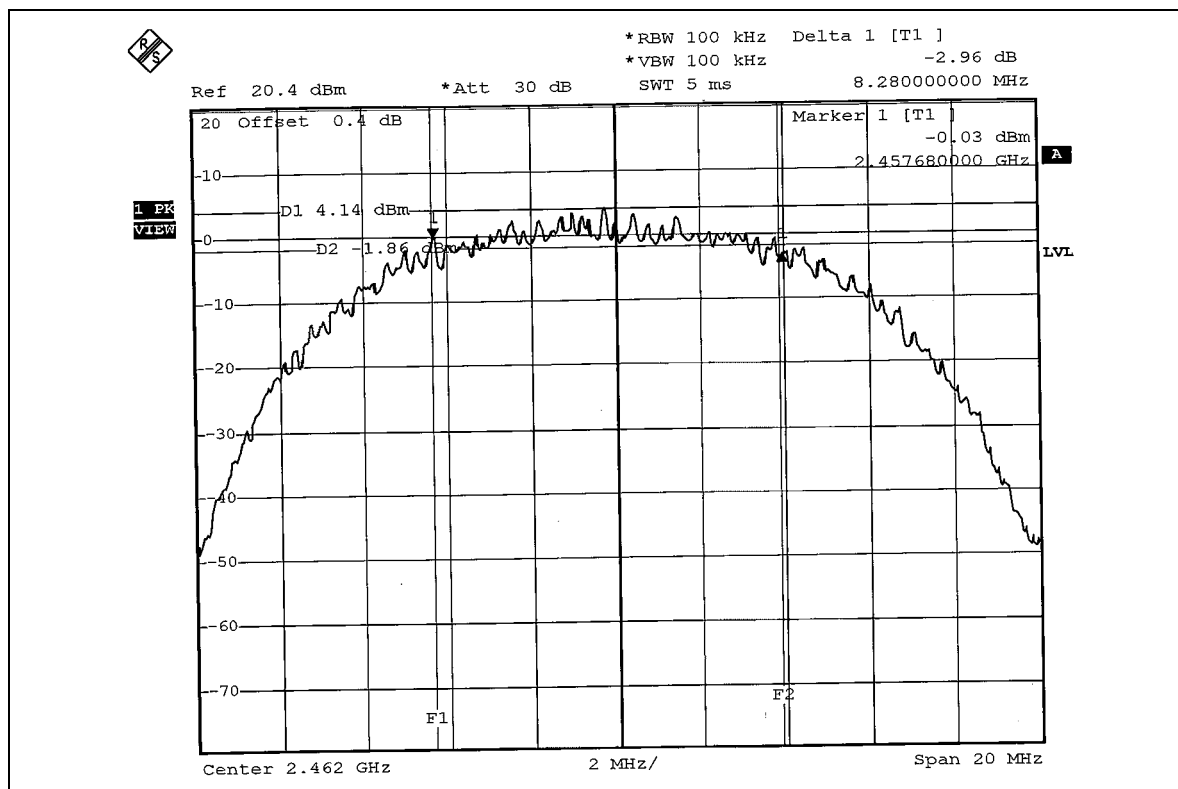



**802.11g OFDM MODULATION**

<b>EUT</b>	Wireless 11g Range Expander	<b>MODEL</b>	WACM-123G
<b>MODULATION TYPE</b>	BPSK	<b>TRANSFER RATE</b>	6Mbps
<b>INPUT POWER (SYSTEM)</b>	120Vac, 60 Hz	<b>ENVIRONMENTAL CONDITIONS</b>	25deg. C, 65%RH, 991hPa
<b>TESTED BY</b>	Match Tsui		

<b>CHANNEL</b>	<b>CHANNEL FREQUENCY (MHz)</b>	<b>6dB BANDWIDTH (MHz)</b>	<b>MINIMUM LIMIT (MHz)</b>	<b>PASS/FAIL</b>
1	2412	16.12	0.5	PASS
6	2437	15.76	0.5	PASS
11	2462	16.04	0.5	PASS



CH1

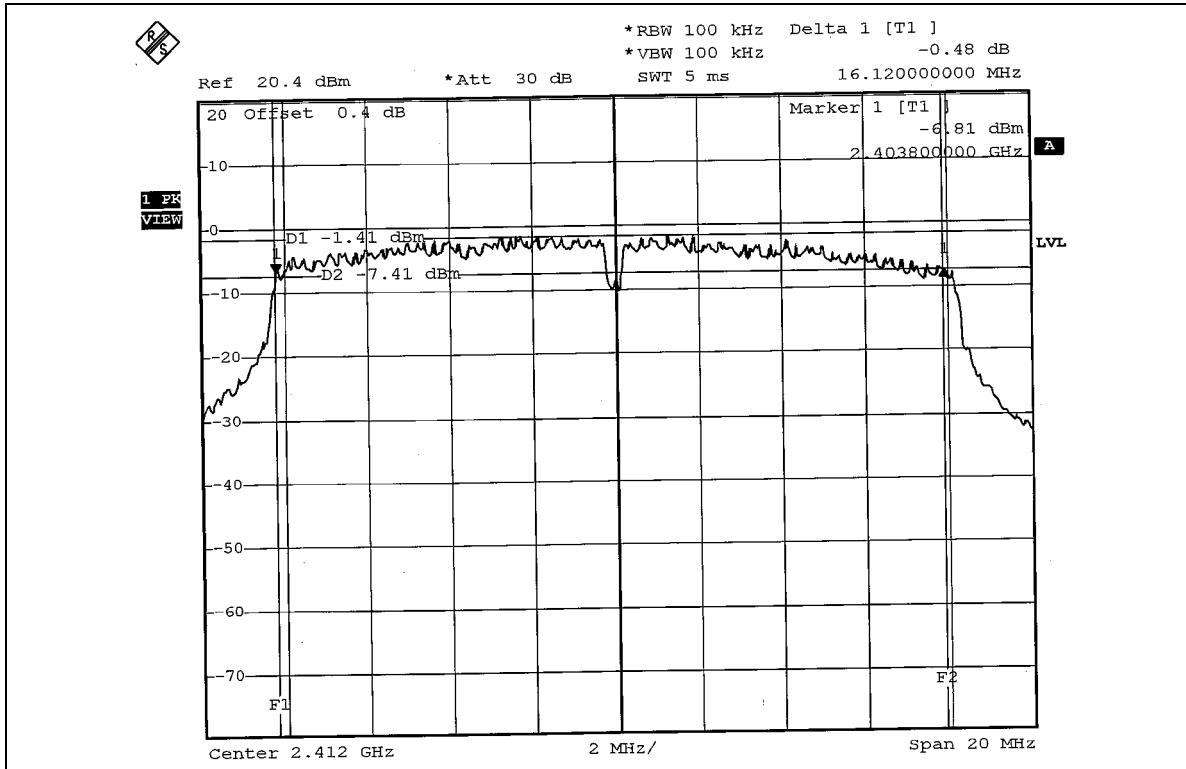

CH6

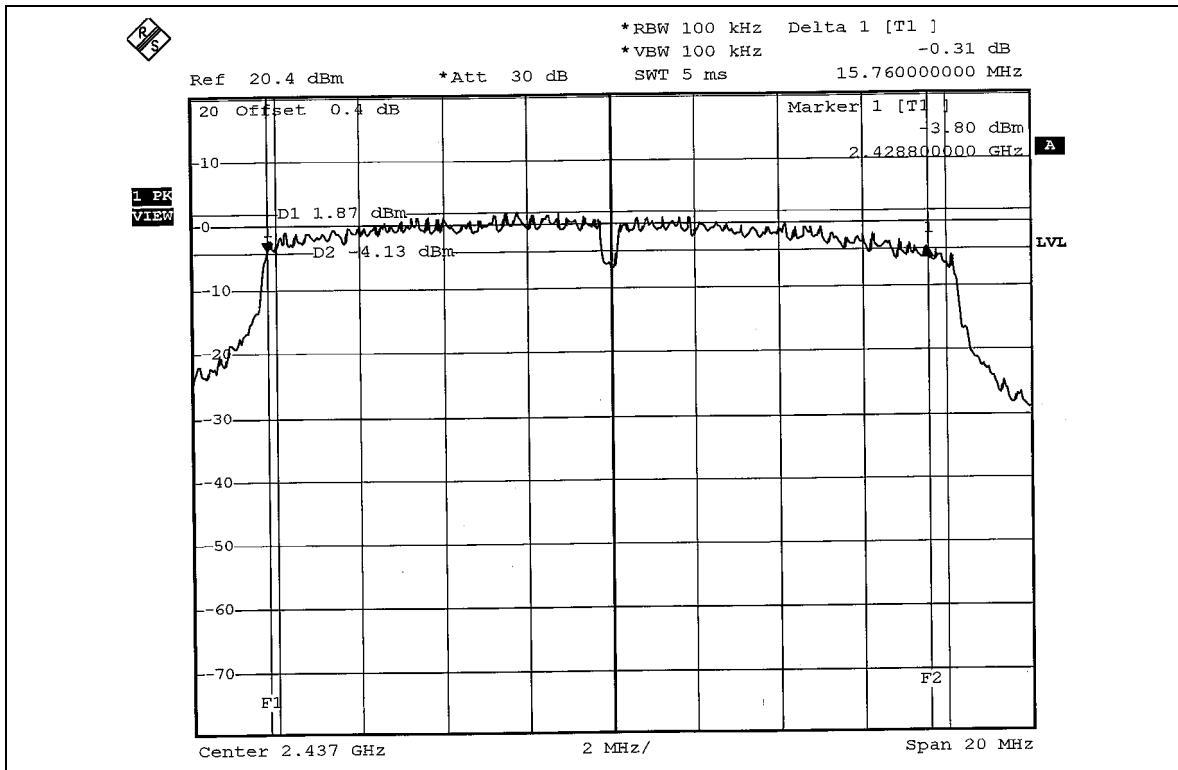



CH11

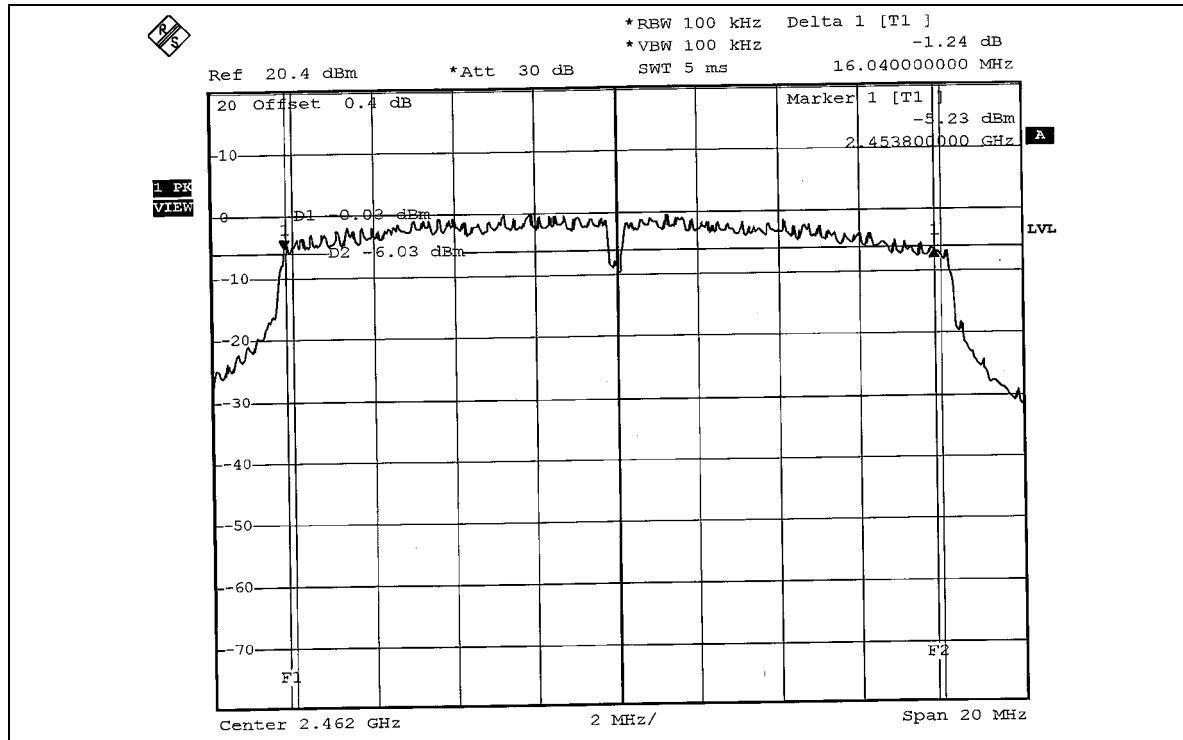



#### 4.4 MAXIMUM PEAK OUTPUT POWER

##### 4.4.1 LIMITS OF MAXIMUM PEAK OUTPUT POWER MEASUREMENT

The Maximum Peak Output Power Measurement is 30dBm.

##### 4.4.2 INSTRUMENTS

DESCRIPTION & MANUFACTURER	MODEL NO.	SERIAL NO.	CALIBRATED UNTIL
R&S SPECTRUM ANALYZER	FSEK30	100049	Aug. 14, 2006
AGILENT SIGNAL GENERATOR	E8257C	MY43320668	Dec. 06, 2005
DIGITAL RT OSCILLOSCOPE	TDS1012	C037299	Dec. 07, 2005
NARDA DETECTOR	4503A	FSCM99899	NA

**NOTE:** The calibration interval of the above test instruments is 12 months and the calibrations are traceable to NML/ROC and NIST/USA.



#### 4.4.3 TEST PROCEDURES

1. A detector was used on the output port of the EUT. An oscilloscope was used to read the response of the detector.
2. Replaced the EUT by the signal generator. The center frequency of the S.G was adjusted to the center frequency of the measured channel.
3. Adjusted the power to have the same reading on oscilloscope. Record the power level.

#### 4.4.4 DEVIATION FROM TEST STANDARD

No deviation

#### 4.4.5 TEST SETUP



#### 4.4.6 EUT OPERATING CONDITIONS

Same as Item 4.3.6





#### 4.4.7 TEST RESULTS

##### 802.11b DSSS MODULATION

<b>EUT</b>	Wireless 11g Range Expander	<b>MODEL</b>	WACM-123G
<b>MODULATION TYPE</b>	CCK	<b>TRANSFER RATE</b>	11Mbps
<b>INPUT POWER (SYSTEM)</b>	120Vac, 60 Hz	<b>ENVIRONMENTAL CONDITIONS</b>	25deg. C, 69%RH, 991hPa
<b>TESTED BY</b>	Match Tsui		

CHANNEL	CHANNEL FREQUENCY (MHz)	PEAK POWER OUTPUT (mW)	PEAK POWER OUTPUT (dBm)	PEAK POWER LIMIT (dBm)	PASS/FAIL
1	2412	32.063	15.06	30	PASS
6	2437	80.353	19.05	30	PASS
11	2462	20.324	13.08	30	PASS

##### 802.11g OFDM MODULATION

<b>EUT</b>	Wireless 11g Range Expander	<b>MODEL</b>	WACM-123G
<b>MODULATION TYPE</b>	BPSK	<b>TRANSFER RATE</b>	6Mbps
<b>INPUT POWER (SYSTEM)</b>	120Vac, 60 Hz	<b>ENVIRONMENTAL CONDITIONS</b>	25deg. C, 69%RH, 991hPa
<b>TESTED BY</b>	Match Tsui		

CHANNEL	CHANNEL FREQUENCY (MHz)	PEAK POWER OUTPUT (mW)	PEAK POWER OUTPUT (dBm)	PEAK POWER LIMIT (dBm)	PASS/FAIL
1	2412	25.410	14.05	30	PASS
6	2437	40.087	16.03	30	PASS
11	2462	39.994	16.02	30	PASS



#### 4.5 POWER SPECTRAL DENSITY MEASUREMENT

##### 4.5.1 LIMITS OF POWER SPECTRAL DENSITY MEASUREMENT

The Maximum of Power Spectral Density Measurement is 8dBm.

##### 4.5.2 TEST INSTRUMENTS

DESCRIPTION & MANUFACTURER	MODEL NO.	SERIAL NO.	CALIBRATED UNTIL
R&S SPECTRUM ANALYZER	FSEK30	100049	Aug. 14, 2006

**NOTE:** The calibration interval of the above test instruments is 12 months and the calibrations are traceable to NML/ROC and NIST/USA.

#### 4.5.3 TEST PROCEDURE

The transmitter output was connected to the spectrum analyzer through an attenuator, the bandwidth of the fundamental frequency was measured with the spectrum analyzer using 3kHz RBW and 30kHz VBW, set sweep time = span/3kHz. The power spectral density was measured and recorded.

The sweep time is allowed to be longer than span/3kHz for a full response of the mixer in the spectrum analyzer.

#### 4.5.4 DEVIATION FROM TEST STANDARD

No deviation

#### 4.5.5 TEST SETUP

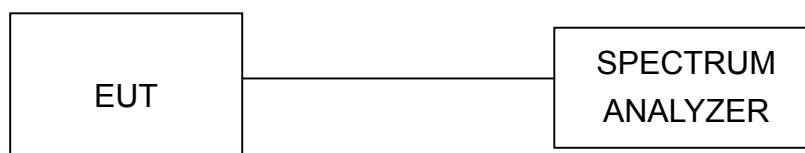

#### 4.5.6 EUT OPERATING CONDITION

Same as Item 4.3.6



4.5.7 TEST RESULTS

802.11b DSSS MODULATION

<b>EUT</b>	Wireless 11g Range Expander	<b>MODEL</b>	WACM-123G
<b>MODULATION TYPE</b>	CCK	<b>TRANSFER RATE</b>	11Mbps
<b>INPUT POWER (SYSTEM)</b>	120Vac, 60 Hz	<b>ENVIRONMENTAL CONDITIONS</b>	25deg. C, 69%RH, 991hPa
<b>TESTED BY</b>	Match Tsui		

CHANNEL	CHANNEL FREQUENCY (MHz )	RF POWER LEVEL IN 3kHz BW (dBm)	MAXIMUM LIMIT (dBm)	PASS/FAIL
1	2412	-6.67	8	PASS
6	2437	-2.59	8	PASS
11	2462	-9.44	8	PASS



CH1

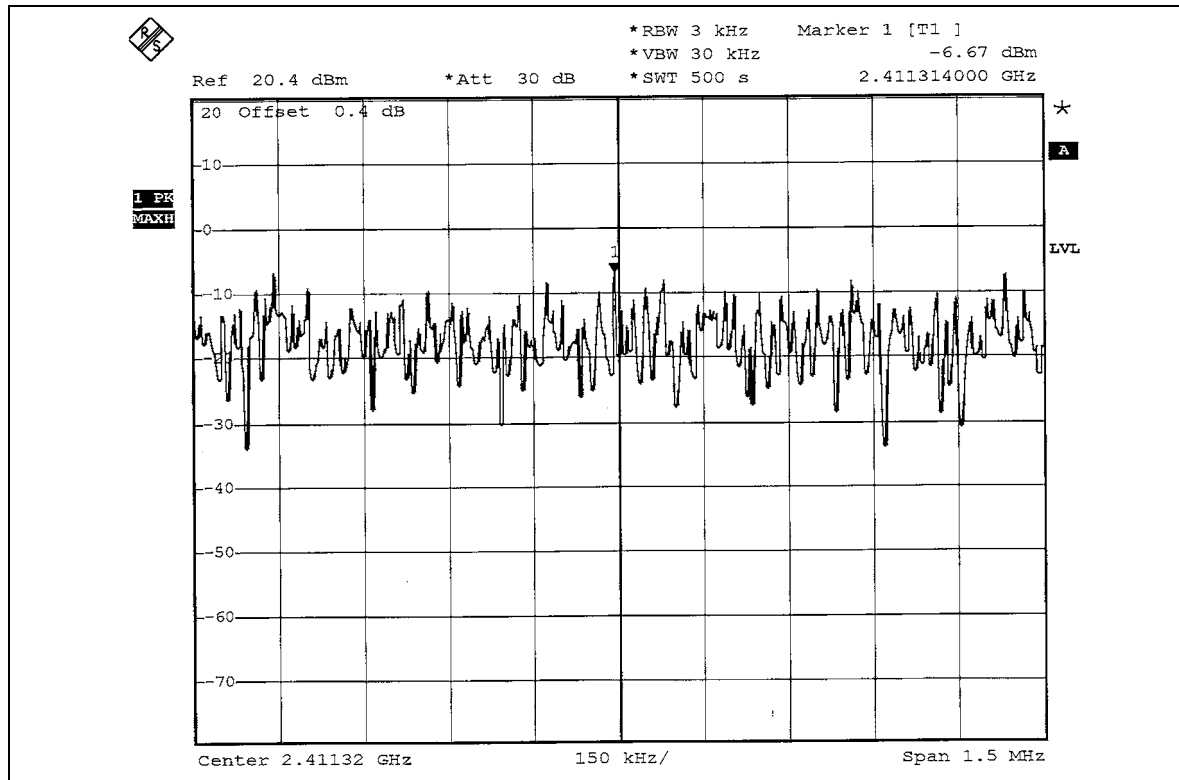

CH6

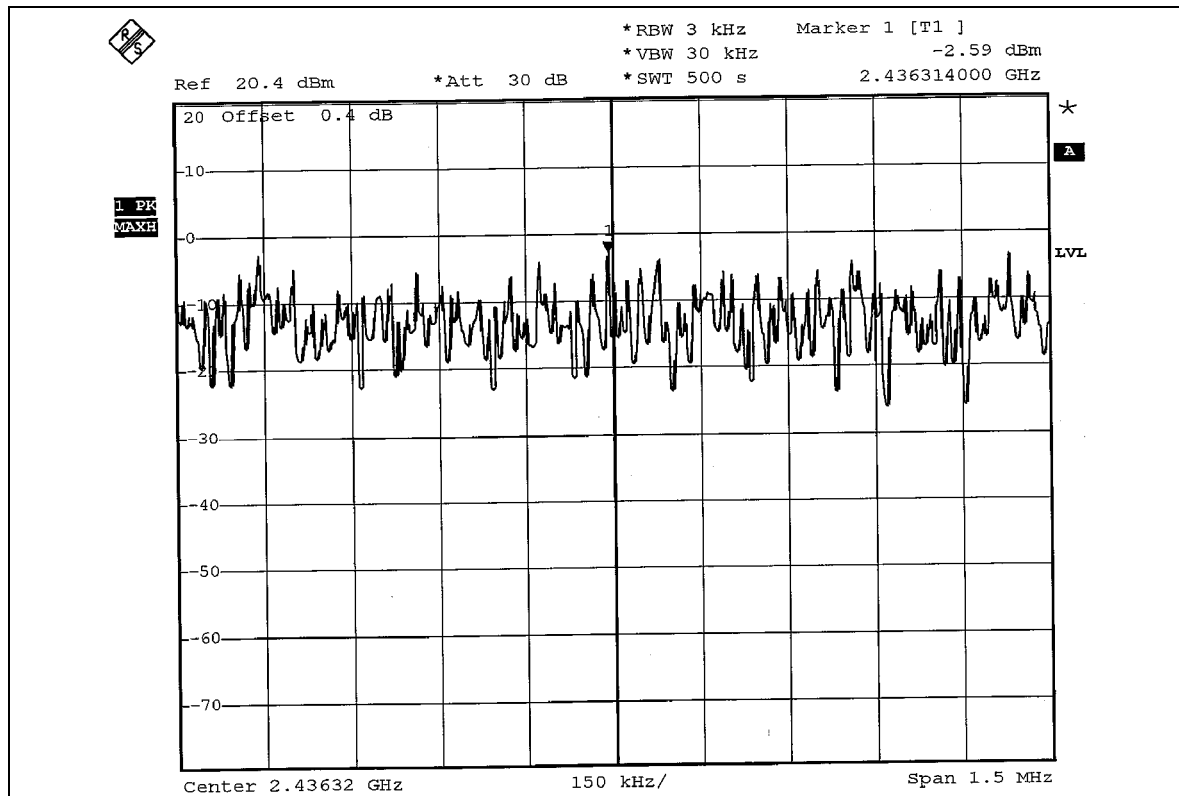



CH11

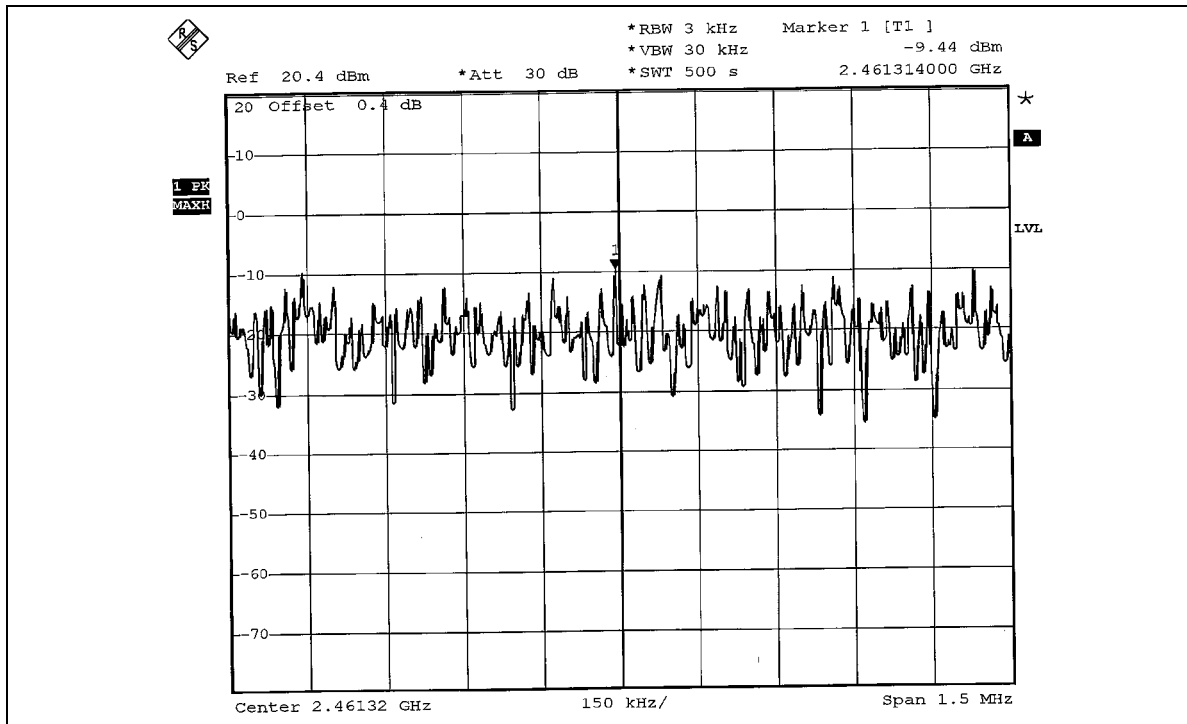



**802.11g OFDM MODULATION**

<b>EUT</b>	Wireless 11g Range Expander	<b>MODEL</b>	WACM-123G
<b>MODULATION TYPE</b>	BPSK	<b>TRANSFER RATE</b>	6Mbps
<b>INPUT POWER (SYSTEM)</b>	120Vac, 60 Hz	<b>ENVIRONMENTAL CONDITIONS</b>	25deg. C, 69%RH, 991hPa
<b>TESTED BY</b>	Match Tsui		

<b>CHANNEL</b>	<b>CHANNEL FREQUENCY (MHz )</b>	<b>RF POWER LEVEL IN 3kHz BW (dBm)</b>	<b>MAXIMUM LIMIT (dBm)</b>	<b>PASS/FAIL</b>
1	2412	-14.72	8	PASS
6	2437	-12.28	8	PASS
11	2462	-12.11	8	PASS







CH11

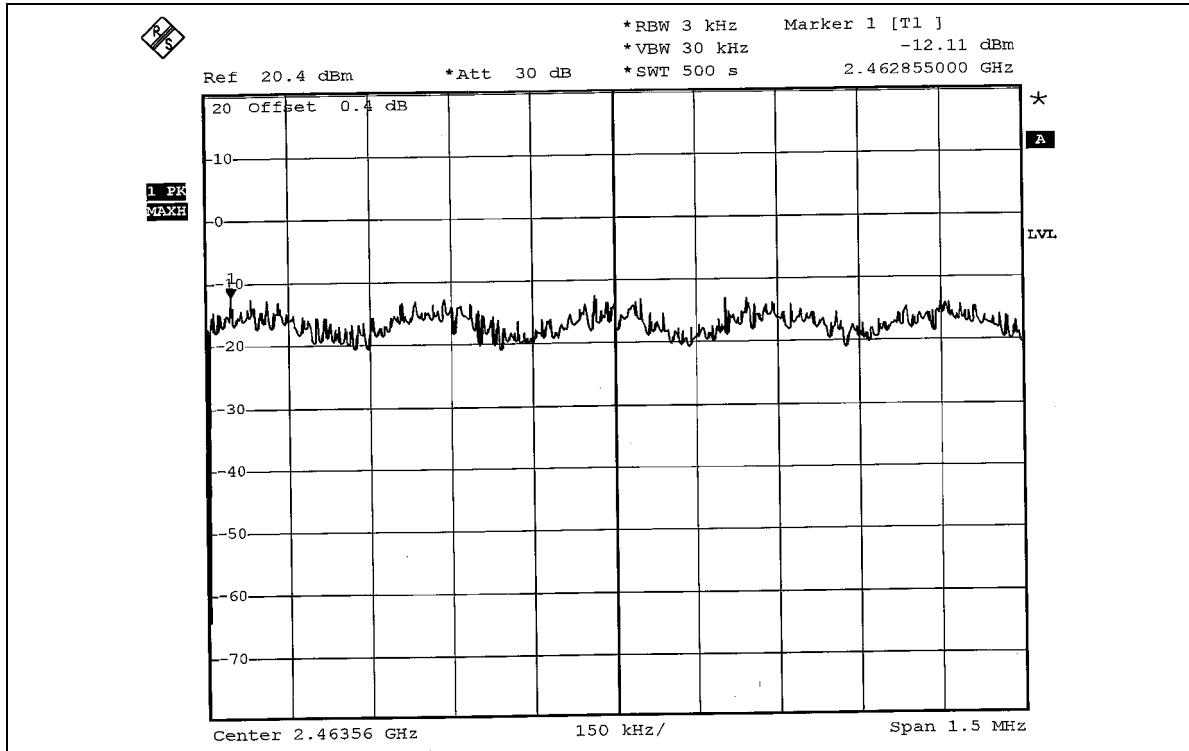



## 4.6 BAND EDGES MEASUREMENT

### 4.6.1 LIMITS OF BAND EDGES MEASUREMENT

Below  $-20\text{dB}$  of the highest emission level of operating band (in 100kHz Resolution Bandwidth).

### 4.6.2 TEST INSTRUMENTS

DESCRIPTION & MANUFACTURER	MODEL NO.	SERIAL NO.	CALIBRATED UNTIL
R&S SPECTRUM ANALYZER	FSEK30	100049	Aug. 14, 2006

**NOTE:** The calibration interval of the above test instruments is 12 months and the calibrations are traceable to NML/ROC and NIST/USA.

### 4.6.3 TEST PROCEDURE

The transmitter output was connected to the spectrum analyzer via a low lose cable. Set both RBW and VBW of spectrum analyzer to 100 kHz and 100 kHz with suitable frequency span including 100 MHz bandwidth from band edge. The band edges was measured and recorded.

The spectrum plots (Peak RBW=VBW=100kHz; Average RBW=1MHz, VBW=10Hz) are attached on the following pages.

### 4.6.4 DEVIATION FROM TEST STANDARD

No deviation

### 4.6.5 EUT OPERATING CONDITION

Same as Item 4.3.6



#### 4.6.6 TEST RESULTS

The spectrum plots are attached on the following 12 images. D1 line indicates the highest level, and D2 line indicates the 20dB offset below D1. It shows compliance with the requirement in part 15.247(d).

#### 802.11b DSSS MODULATION

##### NOTE 1:

The band edge emission plot on page 52 show 52.54dBc delta between carrier maximum power and local maximum emission in restrict band (2.3579GHz). The emission of carrier strength list in the test result of channel 1 at the item 4.2.7 is 114.45dBuV/m (Peak), so the maximum field strength in restrict band is  $114.45 - 52.54 = 61.91$ dBuV/m, which is under 74dBuV/m limit.

The band edge emission plot on page 52 show 55.61dBc delta between carrier maximum power and local maximum emission in restrict band (2.3580GHz). The emission of carrier strength list in the test result of channel 1 at the item 4.2.7 is 106.26dBuV/m (Average), so the maximum field strength in restrict band is  $106.26 - 55.61 = 50.65$ dBuV/m, which is under 54dBuV/m limit.

##### NOTE 2:

The band edge emission plot on the page 53 show 52.45dBc delta between carrier maximum power and local maximum emission in restrict band (2.4921GHz). The emission of carrier strength list in the test result of channel 11 at the item 4.2.7 is 111.54dBuV/m (Peak), so the maximum field strength in restrict band is  $111.54 - 52.45 = 59.09$ dBuV/m, which is under 74dBuV/m limit.

The band edge emission plot on the page 54 show 58.40dBc delta between carrier maximum power and local maximum emission in restrict band (2.5000GHz). The emission of carrier strength list in the test result of channel 11 at the item 4.2.7 is 103.59dBuV/m (Average), so the maximum field strength in restrict band is  $103.59 - 58.40 = 45.19$ dBuV/m, which is under 54dBuV/m limit.

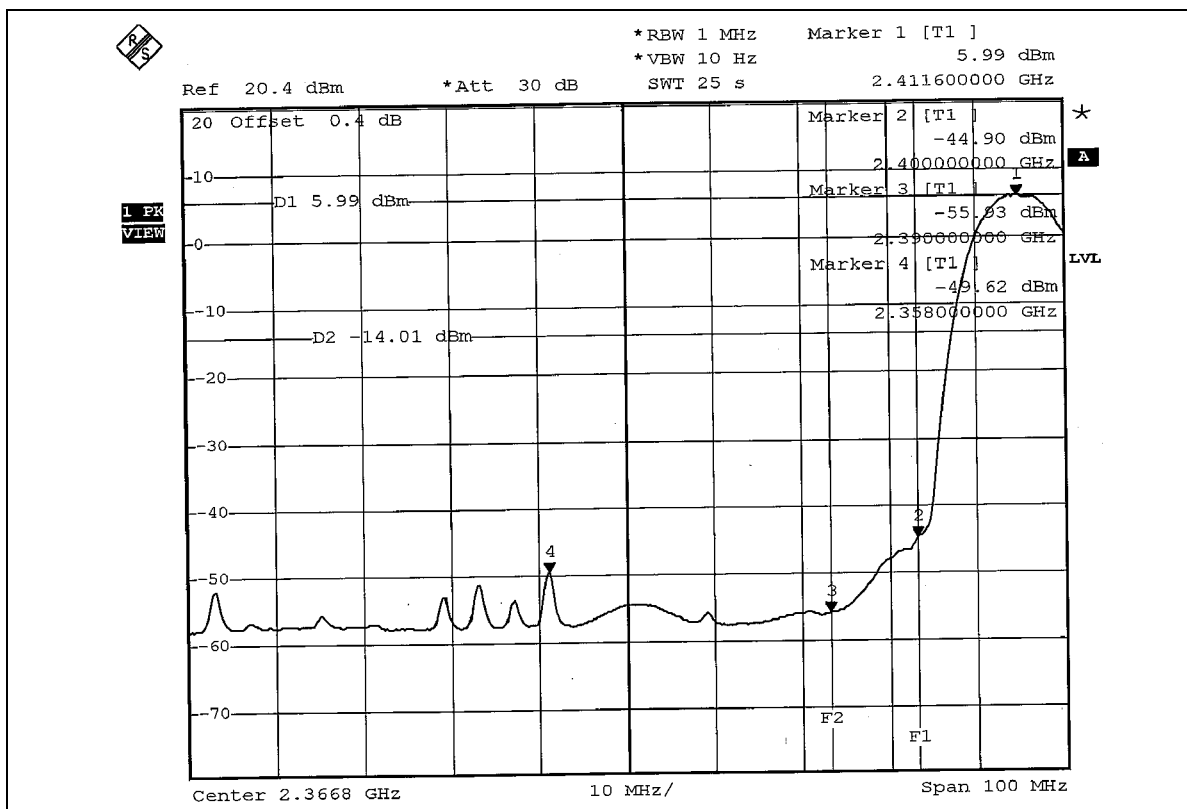
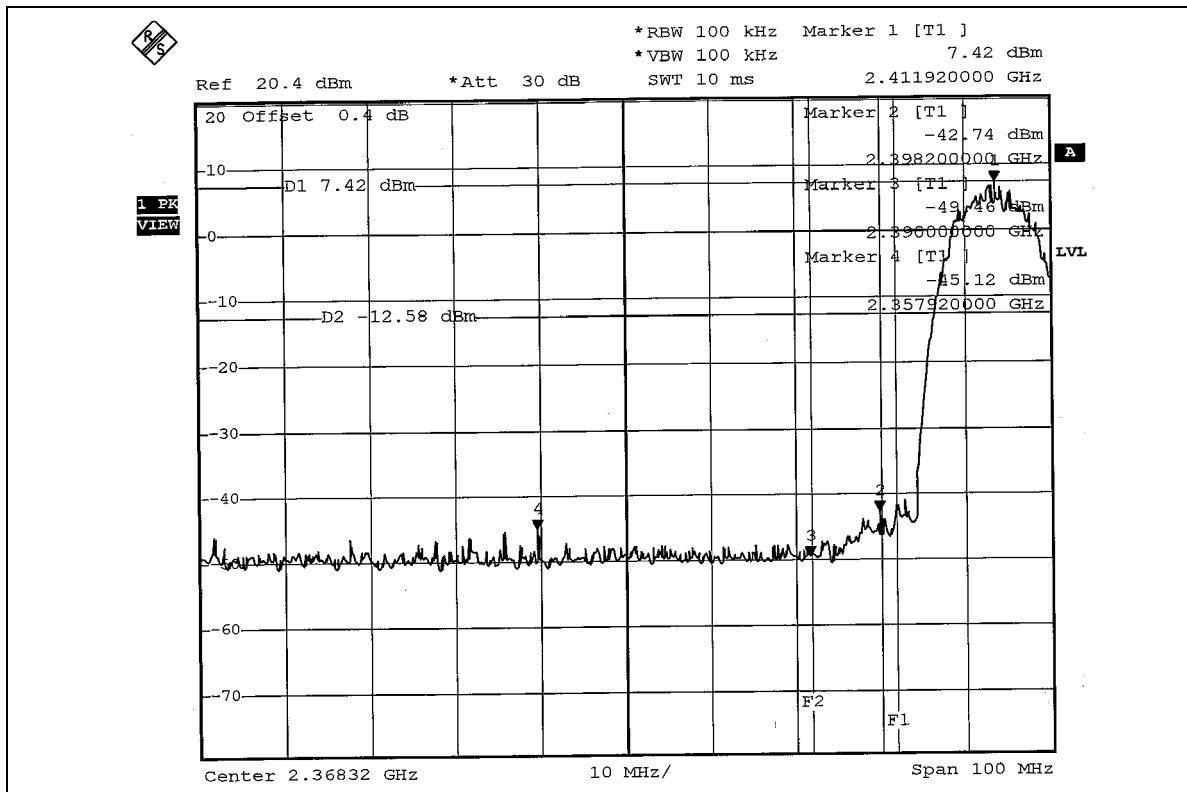

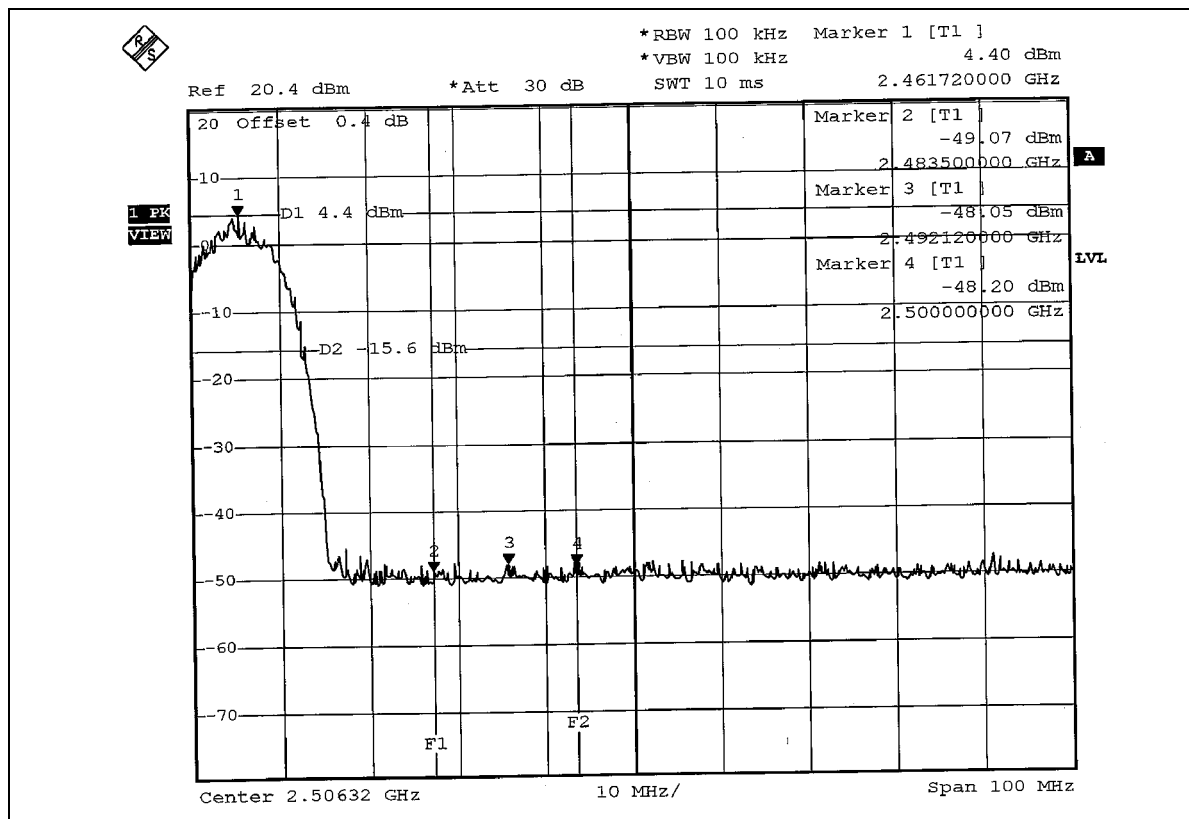
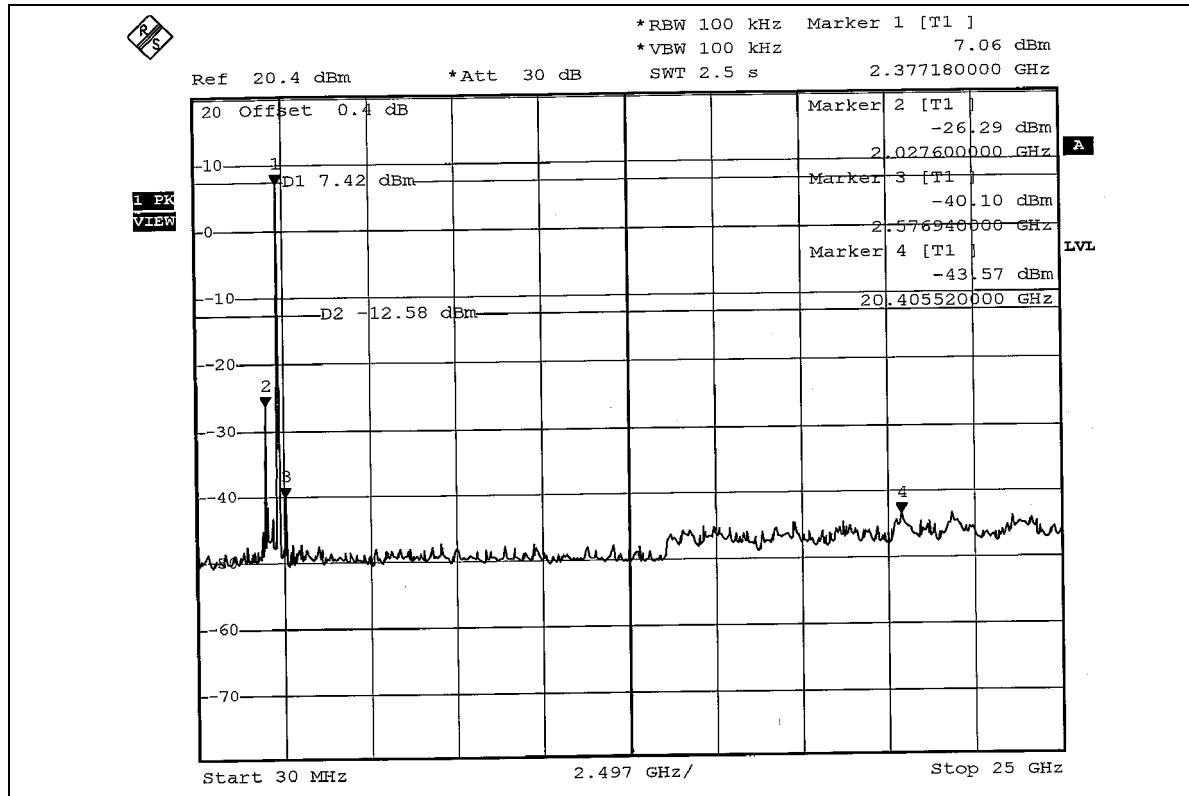

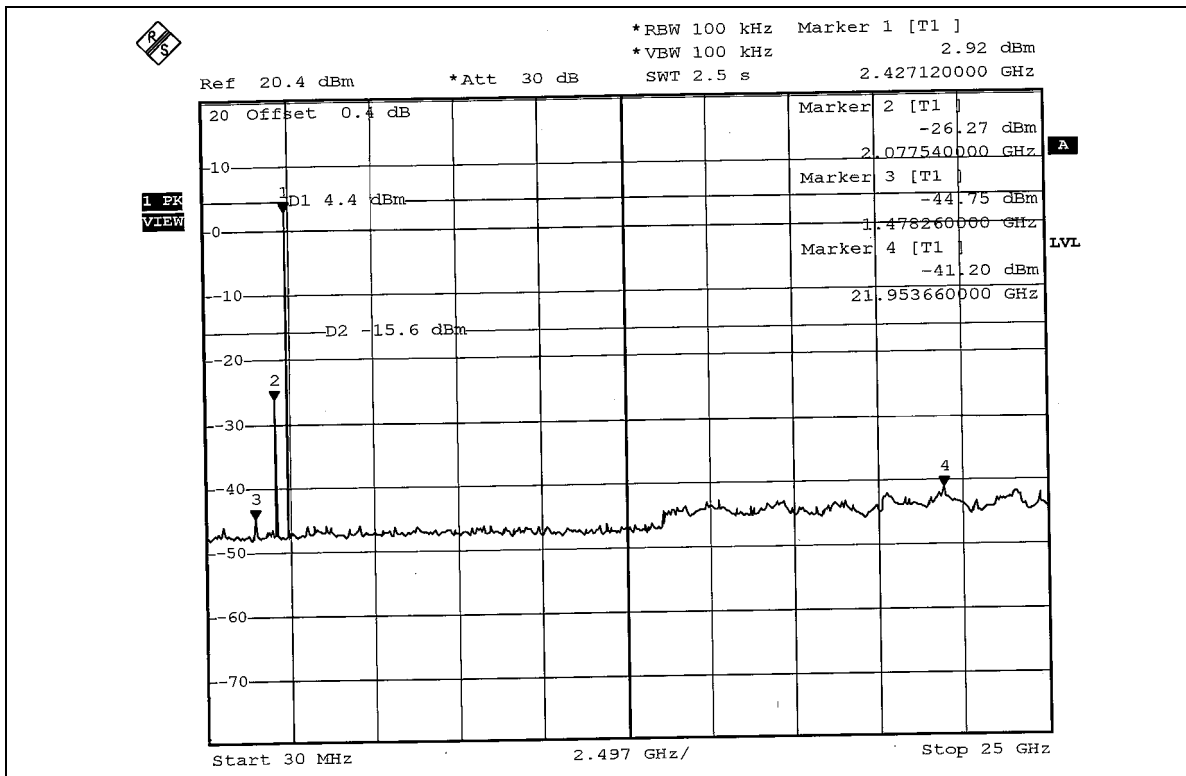
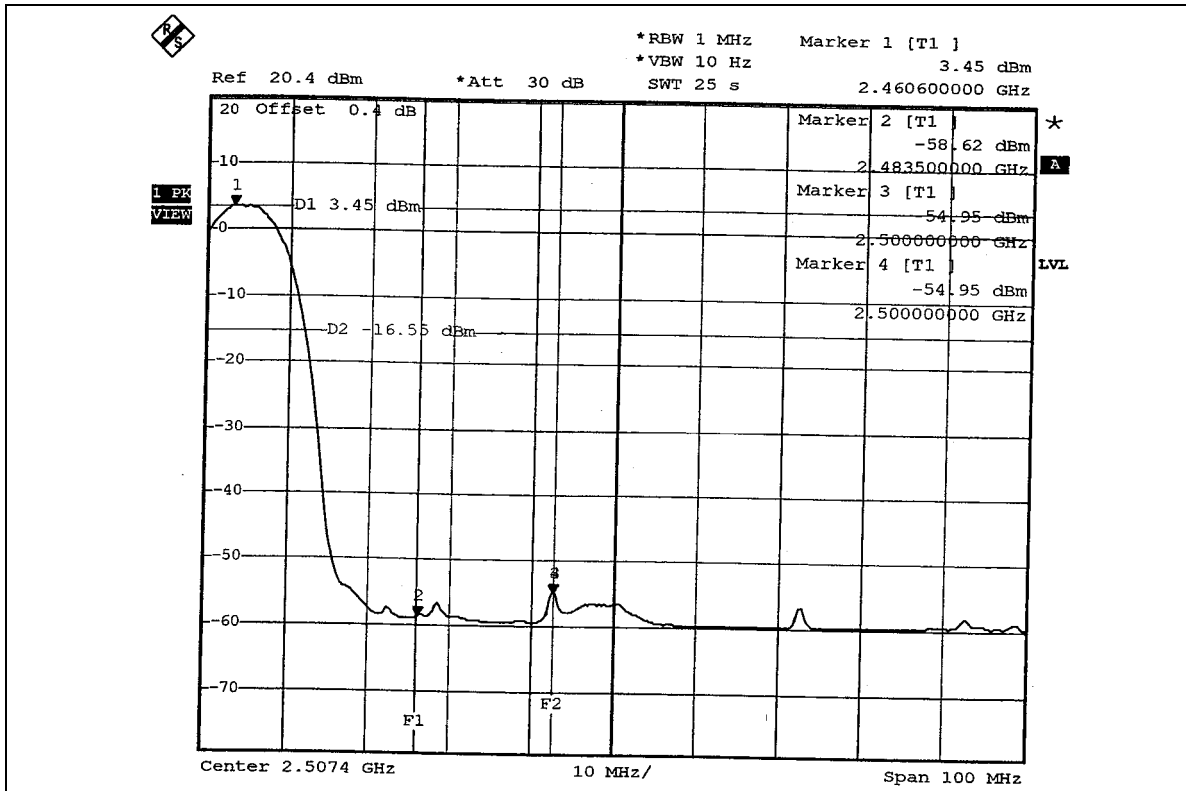



## 802.11g OFDM MODULATION

### NOTE 1:

The band edge emission plot on page 56 show 45.85dBc delta between carrier maximum power and local maximum emission in restrict band (2.3580GHz). The emission of carrier strength list in the test result of channel 1 at the item 4.2.7 is 108.30dBuV/m (Peak), so the maximum field strength in restrict band is  $108.30 - 45.85 = 62.45$ dBuV/m, which is under 74dBuV/m limit.

The band edge emission plot on page 56 show 49.65dBc delta between carrier maximum power and local maximum emission in restrict band (2.3580GHz). The emission of carrier strength list in the test result of channel 1 at the item 4.2.7 is 98.92dBuV/m (Average), so the maximum field strength in restrict band is  $98.92 - 49.65 = 49.27$ dBuV/m, which is under 54dBuV/m limit.

### NOTE 2:

The band edge emission plot on the page 57 show 43.20dBc delta between carrier maximum power and local maximum emission in restrict band (2.5000GHz). The emission of carrier strength list in the test result of channel 11 at the item 4.2.7 is 111.97dBuV/m (Peak), so the maximum field strength in restrict band is  $111.97 - 43.20 = 68.77$ dBuV/m, which is under 74dBuV/m limit.

The band edge emission plot on the page 58 show 48.13dBc delta between carrier maximum power and local maximum emission in restrict band (2.5000GHz). The emission of carrier strength list in the test result of channel 11 at the item 4.2.7 is 101.13dBuV/m (Average), so the maximum field strength in restrict band is  $101.13 - 48.13 = 53.00$ dBuV/m, which is under 54dBuV/m limit.

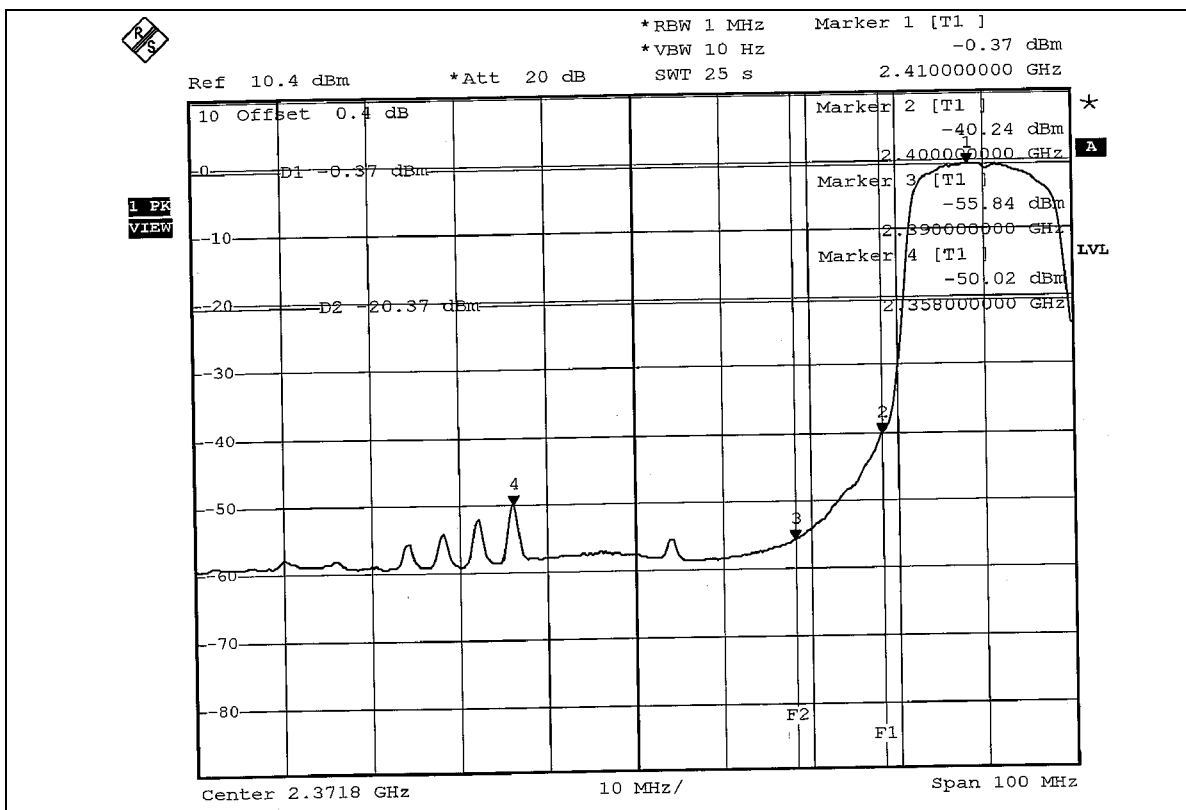
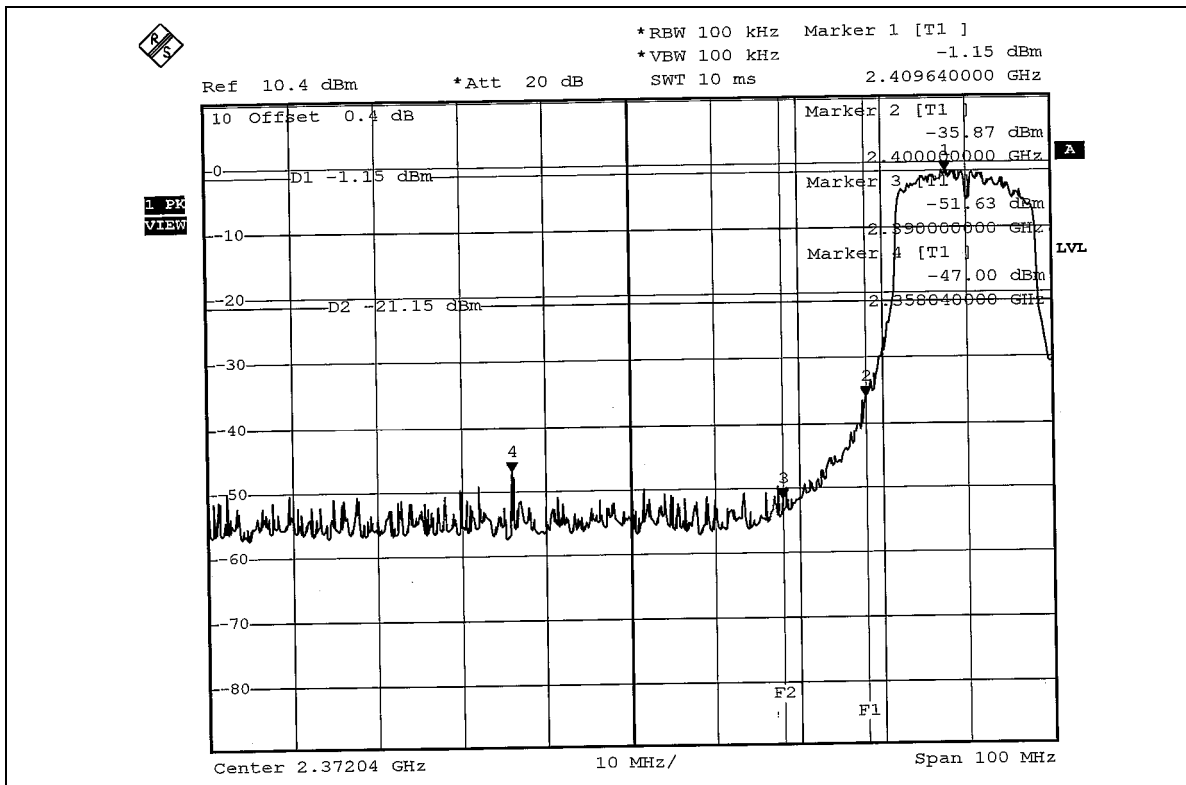



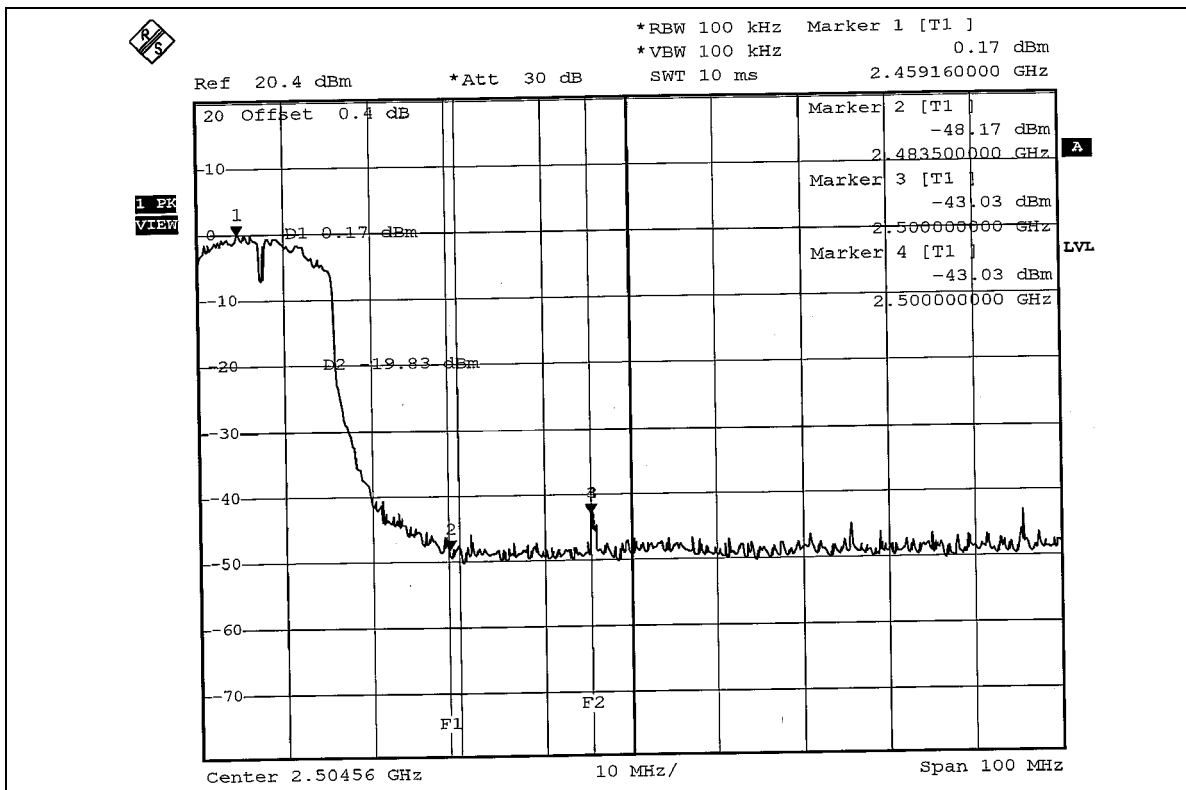
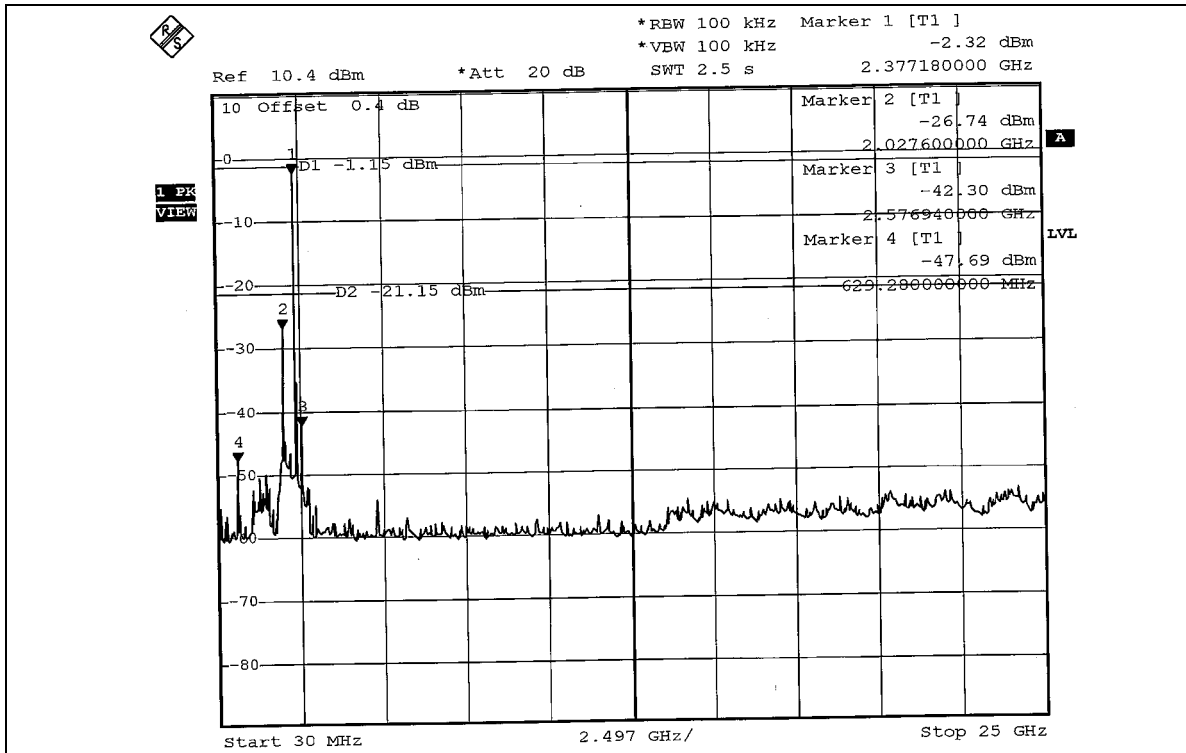

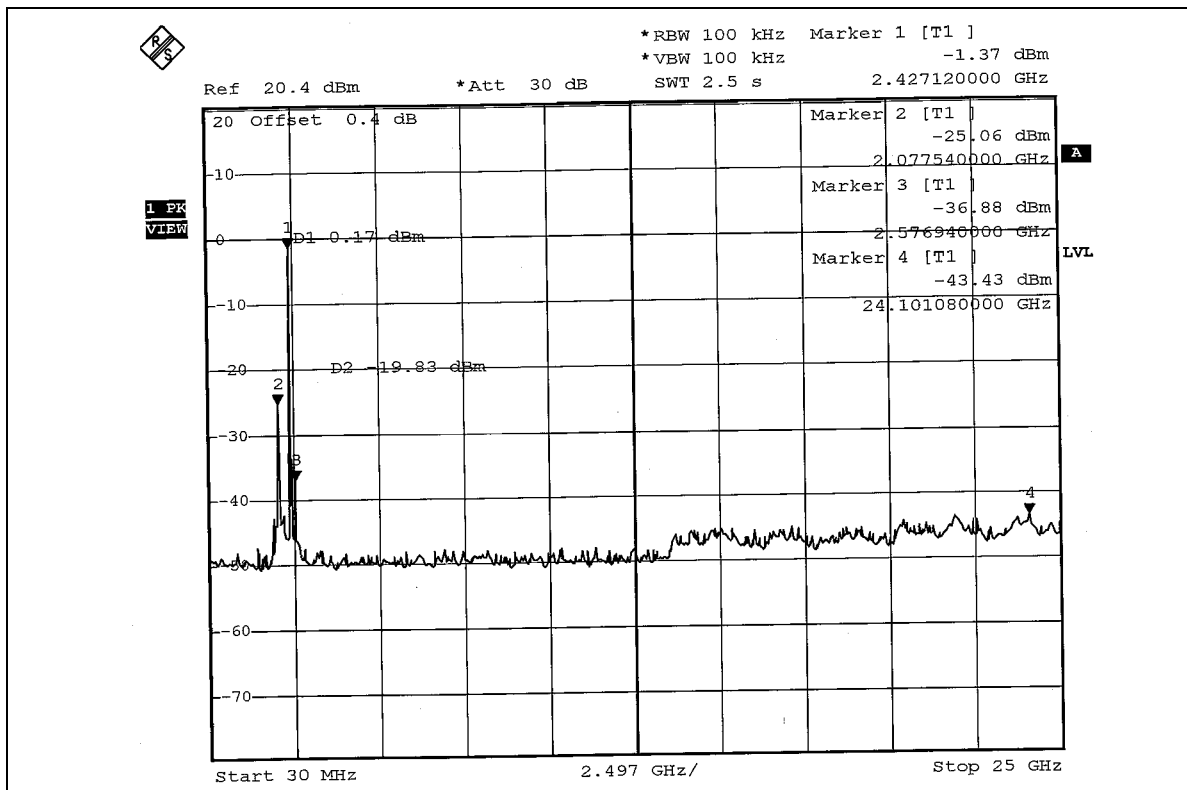
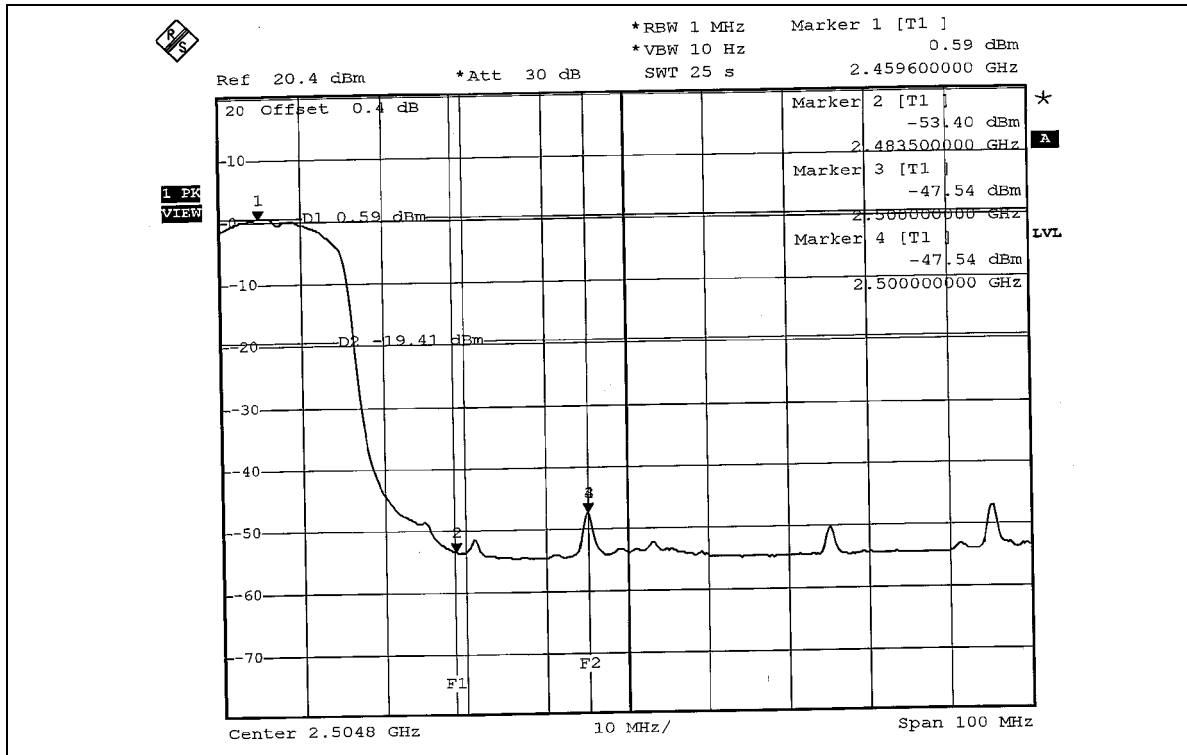



## **4.7 ANTENNA REQUIREMENT**

### **4.7.1 STANDARD APPLICABLE**

For intentional device, according to FCC 47 CFR Section 15.203, an intentional radiator shall be designed to ensure that no antenna other than that furnished by the responsible party shall be used with the device. And according to FCC 47 CFR Section 15.247 (b), if transmitting antennas of directional gain greater than 6dBi are used, the power shall be reduced by the amount in dB that the directional gain of the antenna exceeds 6dBi.

### **4.7.2 ANTENNA CONNECTED CONSTRUCTION**

The antenna used in this product is Dipole antenna with R-SMA antenna connector. The maximum Gain of the antenna is 2.48dBi.

## 5. PHOTOGRAPHS OF THE TEST CONFIGURATION

### CONDUCTED EMISSION TEST



### RADIATED EMISSION TEST

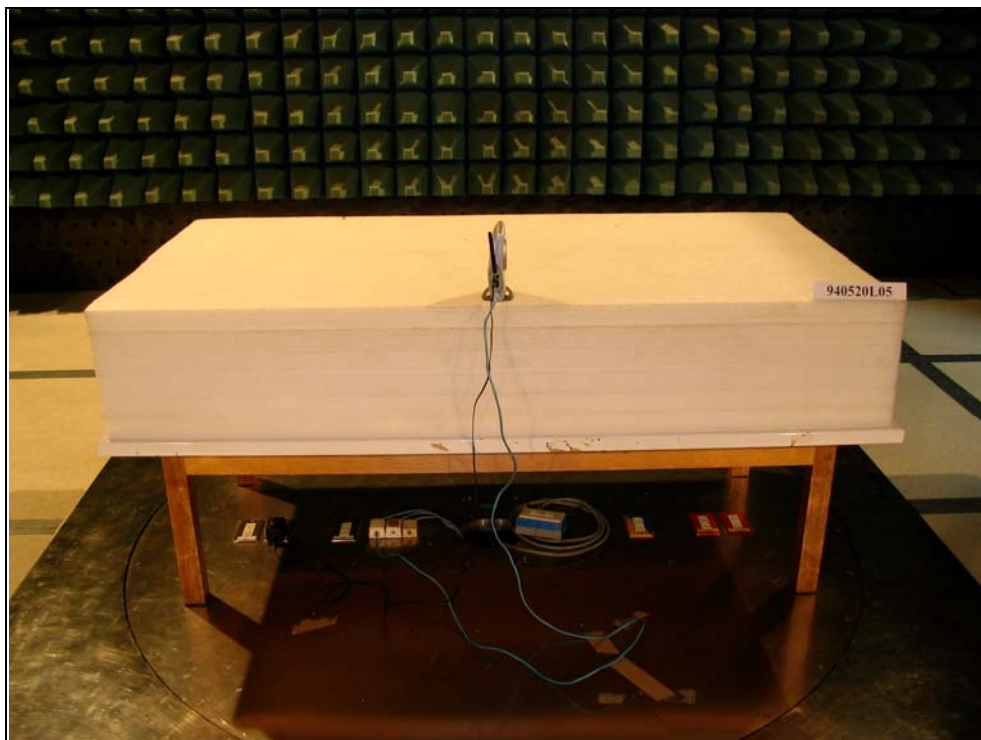



## 6. INFORMATION ON THE TESTING LABORATORIES

We, ADT Corp., were founded in 1988 to provide our best service in EMC, Radio, Telecom and Safety consultation. Our laboratories are accredited and approved by the following approval agencies according to ISO/IEC 17025.

<b>USA</b>	FCC, NVLAP, UL, A2LA
<b>Germany</b>	TUV Rheinland
<b>Japan</b>	VCCI
<b>Norway</b>	NEMKO
<b>Canada</b>	INDUSTRY CANADA , CSA
<b>R.O.C.</b>	CNLA, BSMI, DGT
<b>Netherlands</b>	Telefication
<b>Singapore</b>	PSB , GOST-ASIA(MOU)
<b>Russia</b>	CERTIS(MOU)

Copies of accreditation certificates of our laboratories obtained from approval agencies can be downloaded from our web site:

[www.adt.com.tw/index.5/phtml](http://www.adt.com.tw/index.5/phtml). If you have any comments, please feel free to contact us at the following:

**Linko EMC/RF Lab:**

Tel: 886-2-26052180

Fax: 886-2-26052943

**Hsin Chu EMC/RF Lab:**

Tel: 886-3-5935343

Fax: 886-3-5935342

**Hwa Ya EMC/RF/Safety Telecom Lab:**

Tel: 886-3-3183232

Fax: 886-3-3185050

**Linko RF Lab.**

Tel: 886-3-3270910

Fax: 886-3-3270892

**Web Site:** [www.adt.com.tw](http://www.adt.com.tw)

The address and road map of all our labs can be found in our web site also