

INSIGNIA™

Digital Wireless Headphones

NS-HAWHP2



Before using your new product, please read these instructions to prevent any damage.

Contents

Safety information	3
Features	4
Setting up your system	8
Using your system	15
Understanding indicator lights	17
Maintaining your system	17
Troubleshooting	18
Specifications	20
Legal notices	20
ONE-YEAR LIMITED WARRANTY	22

Safety information

WARNING: To reduce the risk of fire or electric shock, do not expose this system to rain or moisture.

- Read these instructions.
- Keep these instructions.
- Heed all warnings.
- Follow all instructions.
- Do not use this system near water.
- Clean only with a dry cloth.
- Do not install near any heat sources such as radiators, heat registers, stoves, or other apparatus (including amplifiers) that produce heat.
- Do not defeat the safety purpose of the polarized or grounding-type plug. A polarized plug has two blades with one wider than the other. A grounding type plug has two blades and a third grounding prong. The wide blade or the third prong is provided for your safety. If the provided plug does not fit into your outlet, consult an electrician for replacement of the obsolete outlet.
- Protect the power cord from being walked on or pinched particularly at plugs, power outlets, and the point where they exit from the system.
- Only use attachments or accessories specified by the manufacturer.
- Unplug this system during lightning storms or when unused for long periods of time.
- Refer all servicing to qualified service personnel. Servicing is required when the system has been damaged in any way, such as power-supply cord or plug is damaged, liquid has been spilled or objects have fallen into the system, the system has been exposed to rain or moisture, does not operate normally, or has been dropped.
- To reduce the risk of fire or electric shock, do not expose this system to rain or moisture.
- The shock hazard marking and associated graphical symbol are provided on the supplied AC adapter.
- The system shall not be exposed to dripping or splashing and objects filled with liquids should not be placed on the system.
- The AC plug or AC adapter is used as the disconnect device. The disconnect device shall remain readily available.
- Excessive sound pressure from headphones can cause hearing loss.
- Batteries (battery pack and batteries installed) should not be exposed to excessive heat such as sunshine or fire.
- Do not place any conductive material on the docking station to avoid short circuits involving the charging pins.

Features

- Strong 2.40 Ghz digital wireless signal reaches up to 33 ft (10 m)
- Built-in lithium-ion battery recharges on a convenient docking station
- Over-the-ear design with adjustable headband provides a secure fit
- Analog and digital audio inputs provide multiple connection options
- Digital optional input gives you the best sound quality
- Lightweight construction for comfortable wear
- Works with all your audio components (TV, CD/DVD player, A/V receiver)

Package contents

Examine the contents of the box for your digital wireless stereo headphones. The box should contain:

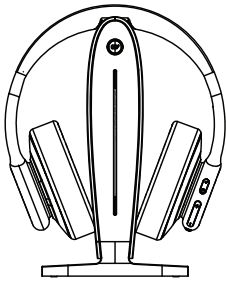

Headphones and docking station

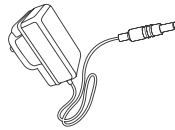

AC adapter



Quick Start Guide



RCA audio cable

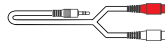

3.5 mm-to-RCA
adapter cable



Digital optical audio
cable

Note: The RCA audio and 3.5 mm-to-RCA adapter cables are connected together in the box.

Headphones

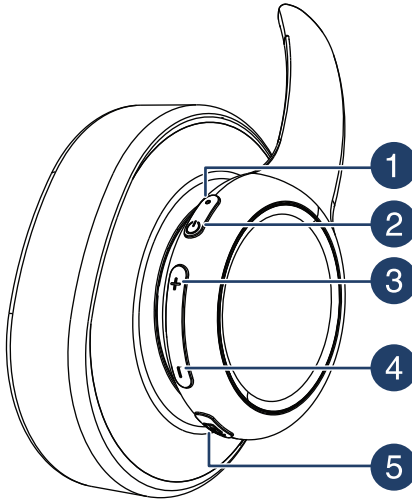

Item	Description
1	Power/Pairing indicator (red/blue): <ul style="list-style-type: none"> • Blue - blinks every second if the headphone and docking station are paired. • Blue and Red - blinks alternately if the headphone and docking station are pairing. • Red - blinks three times a minute if the headphone batteries are low. Lights when the batteries are charging.
2	Headphone  (power) button (on right earpiece). Press and release to turn the headphones on. Press and hold (for more than two seconds) to turn the headphones off.
3	Volume Up (+) button. Press to increase the volume.
4	Volume Down (-) button. Press to decrease the volume.
5	Input source button. Press to change audio sources.

Docking station

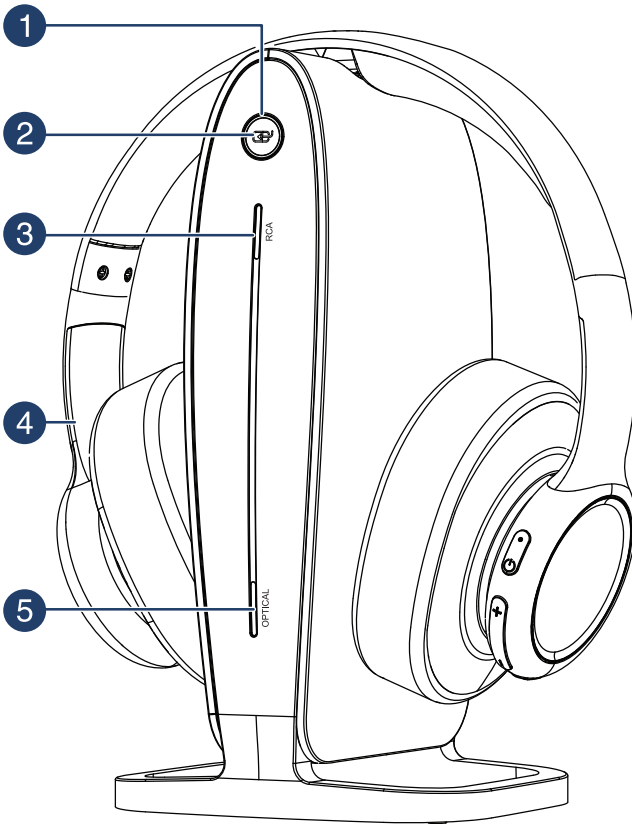

Item	Description
1	Charging indicator: <ul style="list-style-type: none">• Turns red when the headphones are charging.• Turns green when the headphones are charged. Pairing indicator (blue): <ul style="list-style-type: none">• Blinks every second if the headphones and docking station are paired.• Blinks alternately blue and red if the headphones and docking station are pairing.
2	Input source button. Press to switch between audio input sources.
3	RCA source indicator. Lights when the RCA input source is selected.
4	Headphones.
5	OPTICAL source indicator. Lights when the digital optical source is selected.

Docking station back

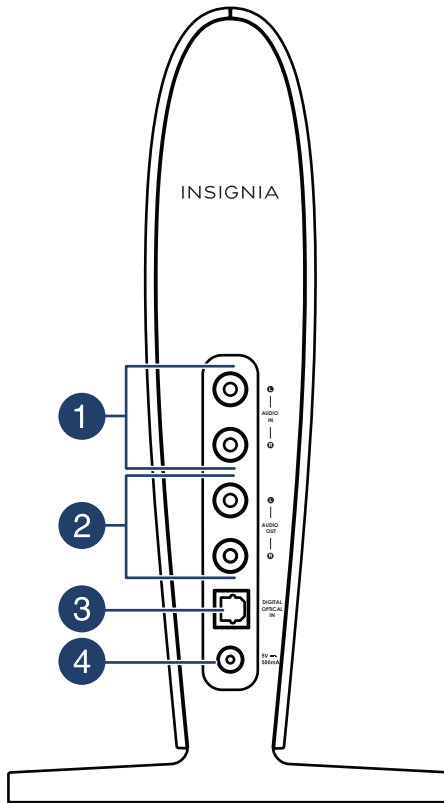

Item	Description
1	AUDIO IN jacks (L and R). Connect a TV or other sound source to these jacks.
2	AUDIO OUT jacks (L and R). Optional. Connect to a stereo system or other audio device.
3	DIGITAL OPTICAL IN . Connect a digital optical cable to this jack.
4	DC 5V jack. Connect the AC adapter to this jack.

Setting up your system

Step 1- Powering the docking station

CAUTION:

- To avoid risk of fire and to prevent damage, only use the AC adapter supplied with your wireless headphones. Make sure that the AC power outlet matches the AC adapter's 100-240V before making the connection.
- Connect one end of the AC adapter to the docking station's DC IN jack and the other end to a power outlet. The **PAIRING** indicator blinks blue while it searches for a connection.

Notes:

- **Standby mode:** Press and hold **Input Source** for more than 10 seconds to put the docking station in standby mode.
- **Normal mode:** Press **Input Source** to turn on the docking station. The indicators turn solid red while the headphones are charging.

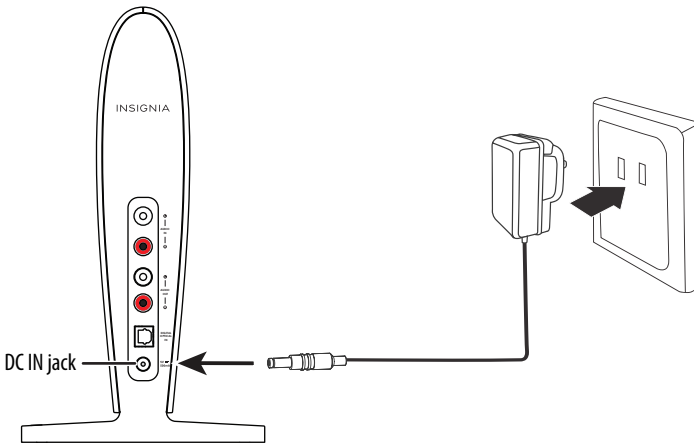

Step 2 - Charging the headphones

Important: Before using the wireless headphones for the first time, make sure that the batteries are fully charged, which can take up to four hours. The docking station's **Charging** indicator turns solid green when the batteries are fully charged.

- 1 Make sure that the AC adapter is connected to the docking station and the docking station's LEDs (red, blue, or green round source button and/or white source indicators) are active.

- Place the headphones onto the docking station. Make sure that the headphone charging contacts and the docking station charging pins make contact by aligning the arrows (as shown below) when you put the headphones in the charging station.

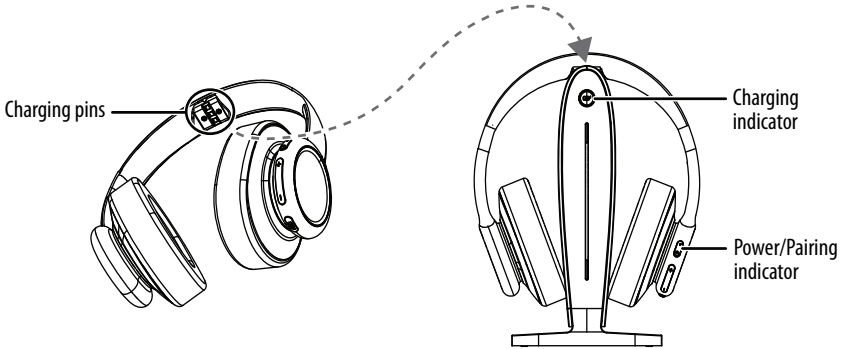

- The docking station's **Charging** indicator turns solid red to indicate the headphones are charging. The headphones' power/pairing indicator also turns red.
- When the headphones are fully charged (up to two hours), the docking station's **Charging** indicator turns solid green. The headphone LED turns off.
- When the headphone battery charge is low, the **Power/Pairing** indicator on the headphones blinks red twice every minute. The **Power/Pairing** indicator on the headphones turns solid red 30 minutes prior to the batteries being exhausted.





Notes:

- It can take up to two hours to charge the headphone batteries. When fully charged, the headphone batteries will last up to ten hours with continuous use (depending on the headphone volume level and distance from the docking station).
- The headphones cannot be charged when the docking station is turned off.
- If the charge on the headphone batteries is low, the Power/Pairing indicator on the headphones blinks red. You should charge the headphones.
- The headphones will automatically power off if the battery is not charged after emitting a low-battery warning.

Step 3 - Connecting the headphone docking station

Note: Do not connect the RCA cables to the AV jacks on the back of your TV. AV jacks are for video and audio INPUT, not audio OUTPUT.

Look at the ports on your audio source device, such as a TV, stereo system, home theater, smartphone, computer, or tablet to identify your audio OUT ports. Choose the connection option below that fits your audio source device.

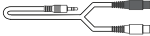
Jack type on audio source	Cable	When to use
	 Digital OPTICAL cable	If your audio source device has a digital optical OUTPUT port, see “Option A - Digital OPTICAL connection” on page 11 for connection instructions.
	 RCA cable (included)	If your audio source device has red and white audio OUTPUT ports (do not connect to audio INPUT ports), see “Option B - RCA connection” on page 12 for connection instructions. OR If your audio source device only has one audio output, but you want to connect it to both the docking station and a stereo system, see “Option D - Multiple Connections (Optional)” on page 14 for connection instructions.
		If your audio source has a 3.5 mm headphone jack, see “Option C - 3.5 mm connection” on page 13 for connection instructions.

CAUTION: Turn off or unplug all devices while you are making connections.

Option A - Digital OPTICAL connection

- 1 Connect one end of a digital optical cable into the **DIGITAL OPTICAL IN** port on the docking station.
- 2 Plug the other end of the digital optical cable into the digital optical output port on a TV, stereo system, home theater, or other audio source.
- 3 Press  (input source) on the headphones or dock to change the input to OPTICAL. The OPTICAL source indicator on the base lights white.

Note: You cannot change the input source while the headphones are on the dock.

Tip: To activate the Optical output on your TV, you may need to change the audio output settings. Refer to your TV's user guide for more information.

Headphone docking station

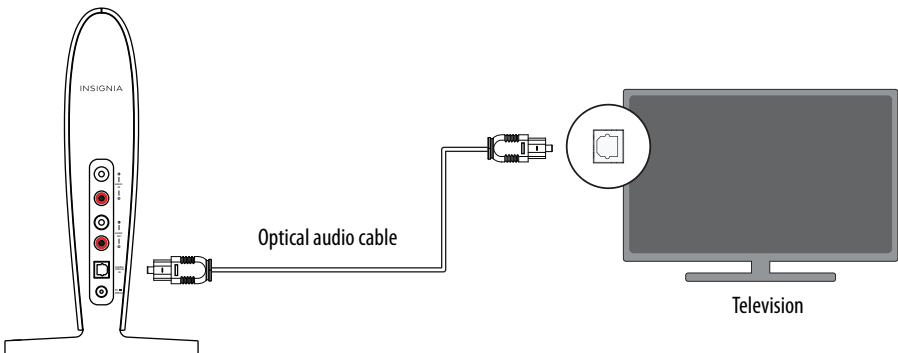

Option B - RCA connection

- 1 Connect one end of the RCA cable to the red and white **AUDIO IN** ports on the docking station.
- 2 Connect the other end into the red and white **AUDIO OUT** ports on your audio source device.
- 3 Press  (input source) on the headphones or dock to change the input to RCA. The RCA source indicator on the base lights white.

Note: You cannot change the input source while the headphones are on the dock.

Headphone docking station

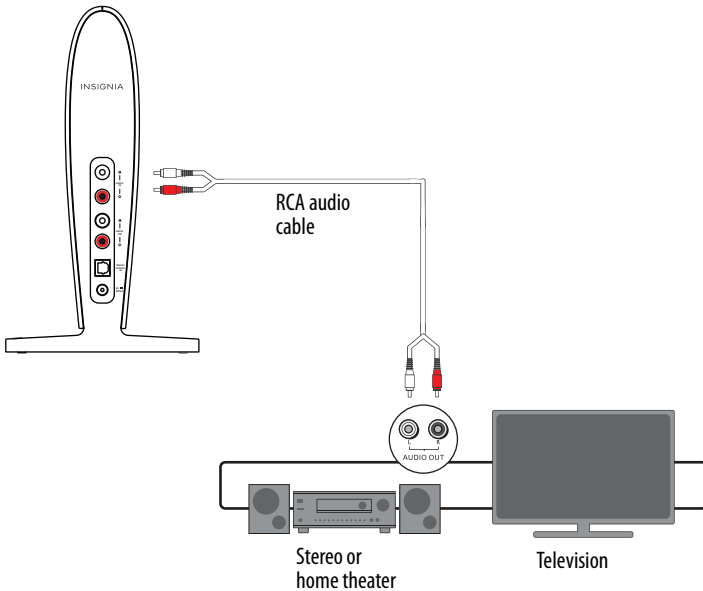

Option C - 3.5 mm connection

- 1 Plug one end of the RCA cable (included) into the **AUDIO IN** ports on the docking station, red to red and white to white.
- 2 Connect the other end of the RCA cable into the red and white connectors on the 3.5 mm-to-RCA adapter cable (included).
- 3 Connect the 3.5 mm end of the 3.5 mm-to-RCA adapter cable into the 3.5 mm headphone jack on your audio source.
- 4 Press  (input source) on the headphones or dock to change the input to RCA. The RCA source indicator on the base lights white.

Note: You cannot change the input source while the headphones are on the dock.

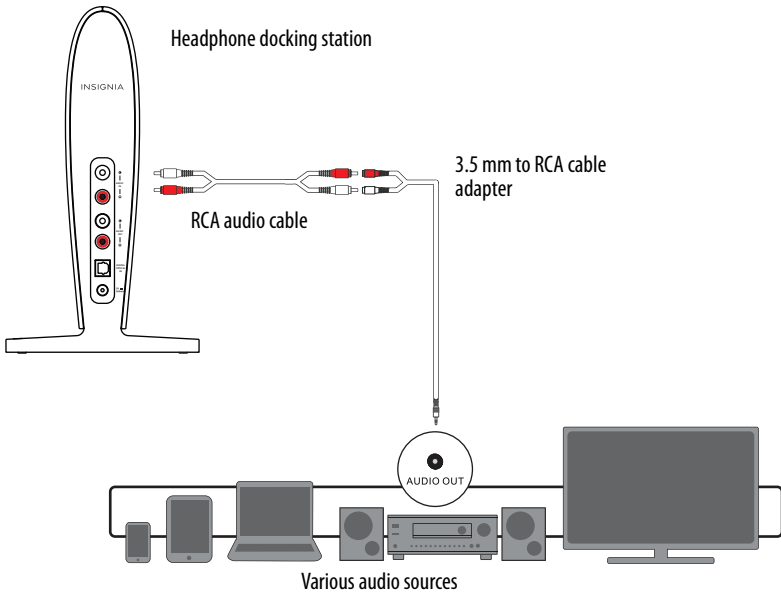

Option D - Multiple Connections (Optional)

If your audio source device (a TV in the example shown) only has one audio output, but you want to connect it to both the docking station and a stereo system or home theater, do this.

- 1 Connect one end of the RCA cable (included) to the red and white AUDIO IN ports on the docking station.
- 2 Connect the other end into the red and white audio out ports on your audio source device.

Note: Use the 3.5mm-to-RCA cable adapter to connect to a headphone jack, if necessary.

- 3 Connect one end of another RCA cable (not included) to the red and white AUDIO OUT ports on the docking station.
- 4 Connect the other end into the red and white audio in ports on your stereo system or home theater. The audio should now play through your home theater speakers (check the manual for your home theater system to activate its RCA inputs).
- 5 Press  (input source) on the headphones or dock to change the input to RCA. The source indicator on the base lights white to show which source is selected.

Note: You cannot change the input source while the headphones are on the dock.

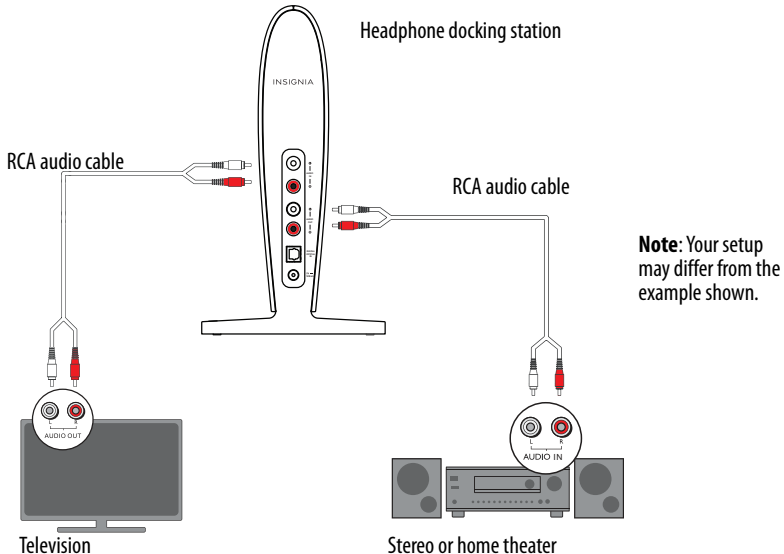

Using your system

Turning on and pairing the system

- 1 The docking station is turned on by plugging in the AC adapter. The Power/Pairing indicator on the docking station blinks (blue).
- 2 To turn on your headphones:
 - Press and hold  (power) on the right earpiece for two seconds.
OR
 - If the headphones are on the base, lift them off.The **Power/Pairing** indicator on headphone lights solid blue.

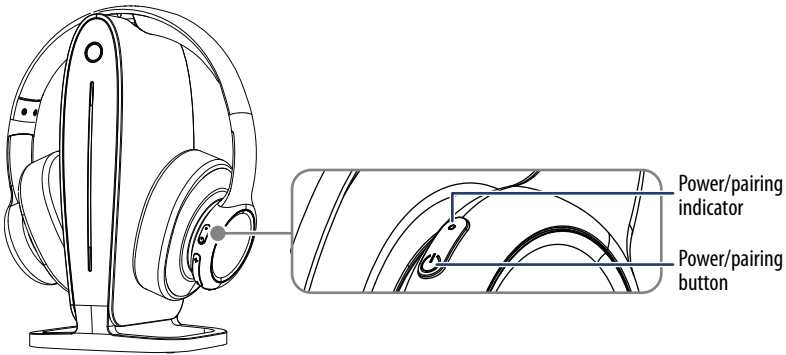

- 3 When the **Power/Pairing** indicator on the headphones and the **Pairing** indicator on the docking station both light solid blue, an active link is established between the headphones and the docking station. The system is now on and ready to use.

Note: Autopairing takes 5-20 seconds.

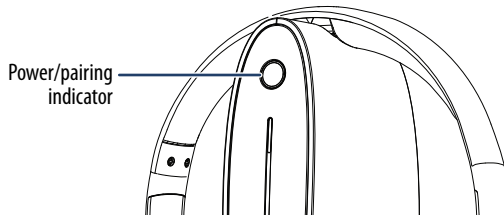

Note: If the charge on the headphone batteries is low, the **Power/Pairing** indicator on the headphones blinks red (three times a minute) and beeps (twice a minute). When this happens, you should charge the headphones. For instructions, see “Using your system” on page 15.

If the power indicators on the headphones and docking station continue to blink once a second, they are no longer paired to each other. If this happens, follow these steps:

- Make sure that the headphones and docking station are within range of each other (ideally in the same room).
- Turn off the headphones and unplug the docking station.
- Turn on the headphones and plug in the docking station. The blue LED on the headphones and docking station will blink every five seconds when paired.

Listening to your headphones

- 1 Turn on the headphones and docking station. Make sure that your docking station and headphones are paired. See “Turning on and pairing the system” on page 15.
- 2 Set the headphone volume level to the minimum.
- 3 Put your headphones on your head. Adjust the fit until you feel comfortable.
- 4 Turn on your audio source (such as a TV or stereo system) and begin playback. You may need to turn up the volume on your audio source to hear playback.
- 5 Adjust the headphone volume to your normal listening level.

CAUTION: Continuous use at high volume may permanently damage your hearing.

Notes:

- If the system is connected to a TV, you may want to turn off the TV sound to prevent hearing sound from the TV speakers. Refer to your TV manual.
- If the docking station does not have audio input for more than 15 minutes, the headphones will power off automatically.
- If the headphones are unpaired from the docking station for more than 15 minutes, the headphones will power off automatically.

Turning off the system

Note: It's important to turn the headphones off when not in use to conserve the battery. OR, if you prefer, you can leave them on as long as they are placed in the docking station.

- 1 Press and hold (more than two seconds) the  (power) button on the headphones.
- 2 Disconnect the AC power adapter to turn off the docking station.

Understanding indicator lights

LED Behavior	Description
Solid blue	The headphones are paired to the dock.
Blinks blue	Searching for a connection.
Solid red	The headphones are charging.
Solid green	The headphones are fully charged.
LED off	Headphones' power/pairing LED: <ul style="list-style-type: none"> • If not on the dock, the headphones are turned off, or • If on the dock, the headphones are fully charged. Dock charging LED: <ul style="list-style-type: none"> • The headphones are turned off and not on the dock, or • The dock is not connected to power.
Solid white	An input source is selected (RCA or OPTICAL). Note: You must remove the headphones from the dock to select a source.
Headphones' LED blinks red 3 times every minute	The headphones' battery is low. Place your headphones on the dock to charge.

Maintaining your system

With the docking station unplugged and the headphones turned off, use a soft cloth dampened with a weak solution of mild detergent and water. Dry the device immediately afterwards with a clean cloth. Do not use abrasive cloth, thinners, alcohol, or other chemical solvents, because they may damage the finish or remove the panel lettering.

Troubleshooting

Check this list for a possible solution before calling for service.

Problem	Solution
No power	<ul style="list-style-type: none"> • Make sure that the batteries have been charged. • Try power cycling the docking station by unplugging it and plugging it back in. • Try another power outlet.
My headphones are not charging	<ul style="list-style-type: none"> • Make sure that the headphone's charging contacts and the docking station's charging pins make contact. You might have to rock them back and forth to make a good connection. The docking station Charging indicator turns red to indicate the headphones are charging.
There is no sound	<ul style="list-style-type: none"> • Check the volume level of the headphones or audio sources connected to the docking station. • Make sure that all of the cables are connected correctly and that the cables are not connected to the AV input jacks on your TV, or the AV Output jacks of the docking station. • Make sure that your source device is turned on. • Make sure that the Power/Pairing indicators of the headphones and Pairing indicator on the docking station are blinking blue (every five seconds), see "Turning on and pairing the system" on page 15. • Make sure that the audio source has internal/external speaker settings that allow the internal speakers to be turned off and for the sound to be heard from the external source (your headphones). • Make sure that your audio source is not set to Mute. • To maximize your volume level through the system, make sure that your audio source (for example, a TV or MP3 player) has its volume turned up to at least 50% of its volume level.

Problem	Solution
There is sound interference	<ul style="list-style-type: none">• Move the docking station slowly to find the best reception position for your headphones.• Shorten the distance between your headphones and the docking station. The maximum distance is 33 feet (10 m), but walls and other obstructions will limit this distance.• Make sure that all of the cables are connected correctly.• It is possible that other devices like cordless phones, microwaves, or wireless routers may be causing interference. Try turning one device off at a time to determine which device is causing interference.• If your cordless phone or wireless router is causing interference, try changing the channel it is using. Also, try moving the docking station away from all WiFi routers, cordless phones, cell phones, Smart TVs, and microwave ovens. Refer to your device's owner manual.
There is sound coming from the audio source	<ul style="list-style-type: none">• Turn off the internal speakers of your audio sound source. Contact the manufacturer of the audio sound source, such as your TV, for support.
No communication between the headphones and docking station	<ul style="list-style-type: none">• Make sure that the AC adapter is connected to the docking station.• Make sure the headphone batteries are charged.• Make sure that the Power/Pairing indicator on the headphones and Pairing indicator on the docking station are on. If they are lit solidly blue, a communication link has been successfully established between the system. If they are blinking on one or both devices, see "Turning on and pairing the system" on page 15.

Problem	Solution
Cannot pair the headphones	<ul style="list-style-type: none"> • Shorten the distance between the docking station and your headphones. • Make sure that the docking station is in pairing mode. Press and hold the pairing button for five seconds to re-enter pairing mode. • Turn on the docking station, then place the headphones onto the station. They will enter autopairing mode (this may take 2-20 seconds). <p>Tip: If the power indicators on the headphones and docking station continue to blink after 20 seconds, they are no longer paired to each other. If this happens, follow these steps:</p> <ol style="list-style-type: none"> 1 Make sure that the headphones and docking station are within range of each other (ideally in the same room). 2 Turn off the headphones and the docking station. 3 Turn on both the headphones and the docking station. The lights will initially blink, then they light solid blue when connected.

Specifications

Headphone dimensions (H x W x D)	7.5 x 3.0 x 6.7 in. (191.2 x 76.8 x 171.2 mm)
Docking station dimensions (H x W x D)	8.5 x 3.8 x 4.7 in. (214.7 x 96.5 x 119.9 mm)
Input	AC 100-240V~ 50/60 Hz 0.3 A
Output	5V, 500mA
Battery life	Up to 10 hours
Range	33 feet (10 m)
Charging time	2 hours
Audio resolution	48 Khz @ 24 bits
Audio Source Ports	Analog: RCA Digital: Optical PCM (does not support DTS and Dolby Audio)

Legal notices

FCC and IC Information:

This device complies with Part 15 of the FCC Rules. Operation is subject to the following two conditions: (1) This device may not cause harmful interference, and (2) this device must accept any interference received, including interference that may cause undesired operation.

This device complies with Industry Canada licence-exempt RSS standard(s). Operation is subject to the following two conditions: (1) this device may not cause interference, and (2) this device must accept any interference, including interference that may cause undesired operation of the device.

This equipment has been tested and found to comply with the limits for a Class B digital device, pursuant to Part 15 of the FCC Rules. These limits are designed to provide reasonable protection against harmful interference in a residential installation. This equipment generates, uses, and can radiate radio frequency energy and, if not installed and used in accordance with the instructions, may cause harmful interference to radio communications. However, there is no guarantee that interference will not occur in a particular installation. If this equipment does cause harmful interference to radio or television reception, which can be determined by turning the equipment off and on, the user is encouraged to try to correct the interference by one or more of the following measures:

- Reorient or relocate the receiving antenna.
- Increase the separation between the equipment and receiver.
- Connect the equipment into an outlet on a circuit different from that to which the receiver is connected.
- Consult the dealer or an experienced radio/TV technician for help.

Warning: Changes or modifications not expressly approved by the party responsible for compliance could void the user's authority to operate the equipment.

This equipment complies with FCC and Industry Canada radiation exposure limits set forth for an uncontrolled environment, this transmitter must be installed to provide a separation distance of at least 20cm from all persons.

Information for Users on Disposal of Old Equipment

European Union

Note: This symbol is only valid in the European Union.



This symbol indicates that the electrical and electronic equipment should not be disposed as general household waste at its end-of-life. Instead, the product should be handed over to the applicable collection point for the recycling in accordance with your national legislation.

By disposing of this product correctly, you will help to conserve natural resources and will help prevent potential negative effects on the environment and human health that could otherwise be caused by inappropriate waste handling of this product. For more information about collection point and recycling of this product, please contact your local municipal office, your household waste disposal service, or the shop where you purchased the product.

Penalties may be applicable for incorrect disposal of this waste, in accordance with national legislation.

Other Countries Outside the European Union

If you wish to dispose of this product, please do so in accordance with applicable national legislation or other rules in your country for the treatment of old electrical and electronic equipment.

ONE-YEAR LIMITED WARRANTY

Definitions:

The Distributor* of Insignia branded products warrants to you, the original purchaser of this new Insignia-branded product ("Product"), that the Product shall be free of defects in the original manufacturer of the material or workmanship for a period of one (1) year from the date of your purchase of the Product ("Warranty Period").

For this warranty to apply, your Product must be purchased in the United States or Canada from a Best Buy branded retail store or online at www.bestbuy.com or www.bestbuy.ca and is packaged with this warranty statement.

How long does the coverage last?

The Warranty Period lasts for 1 year (365 days) from the date you purchased the Product. Your purchase date is printed on the receipt you received with the Product.

What does this warranty cover?

During the Warranty Period, if the original manufacture of the material or workmanship of the Product is determined to be defective by an authorized Insignia repair center or store personnel, Insignia will (at its sole option): (1) repair the Product with new or rebuilt parts; or (2) replace the Product at no charge with new or rebuilt comparable products or parts. Products and parts replaced under this warranty become the property of Insignia and are not returned to you. If service of Products or parts are required after the Warranty Period expires, you must pay all labor and parts charges. This warranty lasts as long as you own your Insignia Product during the Warranty Period. Warranty coverage terminates if you sell or otherwise transfer the Product.

How to obtain warranty service?

If you purchased the Product at a Best Buy retail store location or from a Best Buy online website (www.bestbuy.com or www.bestbuy.ca), please take your original receipt and the Product to any Best Buy store. Make sure that you place the Product in its original packaging or packaging that provides the same amount of protection as the original packaging.

To obtain warranty service, in the United States and Canada call 1-877-467-4289. Call agents may diagnose and correct the issue over the phone.

Where is the warranty valid?

This warranty is valid only in the United States and Canada at Best Buy branded retail stores or websites to the original purchaser of the product in the country where the original purchase was made.

What does the warranty not cover?

This warranty does not cover:

- Food loss/spoilage due to failure of refrigerator or freezer
- Customer instruction/education
- Installation
- Set up adjustments
- Cosmetic damage
- Damage due to weather, lightning, and other acts of God, such as power surges
- Accidental damage
- Misuse
- Abuse
- Negligence
- Commercial purposes/use, including but not limited to use in a place of business or in communal areas of a multiple dwelling condominium or apartment complex, or otherwise used in a place of other than a private home.
- Modification of any part of the Product, including the antenna
- Display panel damaged by static (non-moving) images applied for lengthy periods (burn-in).
- Damage due to incorrect operation or maintenance

- Connection to an incorrect voltage or power supply
- Attempted repair by any person not authorized by Insignia to service the Product
- Products sold "as is" or "with all faults"
- Consumables, including but not limited to batteries (i.e. AA, AAA, C etc.)
- Products where the factory applied serial number has been altered or removed
- Loss or Theft of this product or any part of the product
- Display panels containing up to three (3) pixel failures (dots that are dark or incorrectly illuminated) grouped in an area smaller than one tenth (1/10) of the display size or up to five (5) pixel failures throughout the display. (Pixel based displays may contain a limited number of pixels that may not function normally.)
- Failures or Damage caused by any contact including but not limited to liquids, gels or pastes.

REPAIR REPLACEMENT AS PROVIDED UNDER THIS WARRANTY IS YOUR EXCLUSIVE REMEDY FOR BREACH OF WARRANTY. INSIGNIA SHALL NOT BE LIABLE FOR ANY INCIDENTAL OR CONSEQUENTIAL DAMAGES FOR THE BREACH OF ANY EXPRESS OR IMPLIED WARRANTY ON THIS PRODUCT, INCLUDING, BUT NOT LIMITED TO, LOST DATA, LOSS OF USE OF YOUR PRODUCT, LOST BUSINESS OR LOST PROFITS. INSIGNIA PRODUCTS MAKES NO OTHER EXPRESS WARRANTIES WITH RESPECT TO THE PRODUCT, ALL EXPRESS AND IMPLIED WARRANTIES FOR THE PRODUCT, INCLUDING BUT NOT LIMITED TO ANY IMPLIED WARRANTIES OF AND CONDITIONS OF MERCHANTABILITY AND FITNESS FOR A PARTICULAR PURPOSE, ARE LIMITED IN DURATION TO THE WARRANTY PERIOD SET FORTH ABOVE AND NO WARRANTIES, WHETHER EXPRESS OR IMPLIED, WILL APPLY AFTER THE WARRANTY PERIOD. SOME STATES, PROVINCES AND JURISDICTIONS DO NOT ALLOW LIMITATIONS ON HOW LONG AN IMPLIED WARRANTY LASTS, SO THE ABOVE LIMITATION MAY NOT APPLY TO YOU. THIS WARRANTY GIVES YOU SPECIFIC LEGAL RIGHTS, AND YOU MAY ALSO HAVE OTHER RIGHTS, WHICH VARY FROM STATE TO STATE OR PROVINCE TO PROVINCE.

Contact Insignia:

1-877-467-4289

www.insigniaproducts.com

INSIGNIA is a trademark of Best Buy and its affiliated companies.

*Distributed by Best Buy Purchasing, LLC

7601 Penn Ave South, Richfield, MN 55423 U.S.A.

©2021 Best Buy. All rights reserved.

INSIGNIA™

www.insigniaproducts.com
1-877-467-4289 (U.S. and Canada)

INSIGNIA is a trademark of Best Buy and its affiliated companies.
Distributed by Best Buy Purchasing, LLC
7601 Penn Ave South, Richfield, MN 55423 U.S.A.
©2021 Best Buy. All rights reserved.

V2 ENGLISH
21-0916