

**FCC 47 CFR PART 15 SUBPART C
INDUSTRY CANADA RSS-247 ISSUE 2 February 2017**

CERTIFICATION TEST REPORT

For

Product: Bluetooth Around Neck Headset

**MODEL No.:
NS-HNECKPLUS (USA Version)
NS-HNECKPLUS-C (Canada Version)**

FCC ID: MV3-HNECKPLUS

IC: 9029A-HNECKPLUS

HVIN: NS-HNECKPLUS-C

Trade Mark: N/A

REPORT NO:ES180820004W

ISSUE DATE:August 31, 2018

Prepared for

**Country Mate Technology Ltd
5/F, Blk E, Hing Yip Center. 31 Hing Yip Street, Kwun Tong, Kln,
HongKong**

Prepared by

**EMTEK(SHENZHEN) CO., LTD.
Bldg 69, Majialong Industry Zone, NanshanDistrict,Shenzhen,
Guangdong, China
TEL: 86-755-26954280
FAX: 86-755-26954282**

Table of Contents

1	TEST RESULT CERTIFICATION	3
2	EUT TECHNICAL DESCRIPTION.....	4
3	SUMMARY OF TEST RESULT	5
4	TEST METHODOLOGY	6
4.1	GENERAL DESCRIPTION OF APPLIED STANDARDS.....	6
4.2	MEASUREMENT EQUIPMENT USED	6
4.3	DESCRIPTION OF TEST MODES.....	7
5	FACILITIES AND ACCREDITATIONS	8
5.1	FACILITIES	8
5.2	LABORATORY ACCREDITATIONS AND LISTINGS	8
6	TEST SYSTEM UNCERTAINTY	9
7	SETUP OF EQUIPMENT UNDER TEST	10
7.1	RADIO FREQUENCY TEST SETUP 1.....	10
7.2	RADIO FREQUENCY TEST SETUP 2.....	10
7.3	CONDUCTED EMISSION TEST SETUP.....	11
7.4	SUPPORT EQUIPMENT	12
8	FREQUENCY HOPPING SYSTEM REQUIREMENTS	13
8.1	STANDARD APPLICABLE	13
8.2	EUT PSEUDORANDOM FREQUENCY HOPPING SEQUENCE	13
8.3	EQUAL HOPPING FREQUENCY USE.....	14
8.4	FREQUENCY HOPPING SYSTEM.....	14
9	TEST REQUIREMENTS.....	15
9.1	20DB BANDWIDTH	15
9.2	CARRIER FREQUENCY SEPARATION.....	25
9.3	NUMBER OF HOPPING FREQUENCIES	30
9.4	AVERAGE TIME OF OCCUPANCY (DWELL TIME)	32
9.5	MAXIMUM PEAK CONDUCTED OUTPUT POWER	45
9.6	CONDUCTED SUPRIIOUS EMISSION	50
9.7	RADIATED SPURIOUS EMISSION.....	63
9.8	CONDUCTED EMISSION TEST.....	113
9.9	ANTENNA APPLICATION.....	116

1 TEST RESULT CERTIFICATION

Applicant:	Country Mate Technology Ltd 5/F, Blk E, Hing Yip Center. 31 Hing Yip Street, Kwun Tong, Kln, HongKong
Manufacturer:	Country Mate Technology Ltd 5/F, Blk E, Hing Yip Center. 31 Hing Yip Street, Kwun Tong, Kln, HongKong
Product Description:	Bluetooth Around Neck Headset
Model Number:	NS-HNECKPLUS (USA Version) NS-HNECKPLUS-C (Canada Version)
Trade Mark:	N/A
File Number:	ES180820004W

Measurement Procedure Used:

APPLICABLE STANDARDS	
STANDARD	TEST RESULT
FCC 47 CFR Part 2, Subpart J FCC 47 CFR Part 15, Subpart C IC RSS-GEN, Issue5, April 2018 IC RSS-247 Issue2, February 2017	PASS

The above equipment was tested by EMTEK (SHENZHEN) CO., LTD. The test data, data evaluation, test procedures, and equipment configurations shown in this report were made in accordance with the procedures given in ANSI C63.10 (2013) and the energy emitted by the sample EUT tested as described in this report is in compliance with the requirements of FCC Rules Part 2, Part 15.247, IC RSS-247 IC RSS-GEN.

The test results of this report relate only to the tested sample identified in this report.

Date of Test : August 15, 2018 to August 31, 2018

Prepared by: *Yaping Shen*
Yaping Shen/Editor

Reviewer: *Joe Xia*
Sevin Li /Supervisor

Approve & Authorized Signer : *[Signature]*
Lisa Wang/Manager

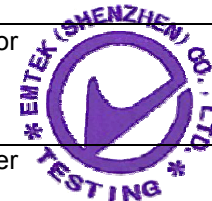

2 EUT TECHNICAL DESCRIPTION

Characteristics	Description
Data Rate	1Mbps for GFSK modulation 2Mbps for pi/4-DQPSK modulation 3Mbps for 8DPSK modulation
Modulation	GFSK modulation (1Mbps) pi/4-DQPSK modulation (2Mbps) 8DPSK modulation (3Mbps)
Operating Frequency Range	2402-2480MHz
Number of Channels	79 channels
Transmit Power Max	5.28dBm
Antenna Type	Internal antenna
Gain	0.6 dBi
Power supply	<input checked="" type="checkbox"/> DC 3.7V internal rechargeable lithium battery <input checked="" type="checkbox"/> DC 5V from Adapter

Note: for more details, please refer to the User's manual of the EUT.

3 SUMMARY OF TEST RESULT

FCC&IC Part Clause	Test Parameter	Verdict
FCC 15.247(a)(1) RSS-247.5.1(a)	20 dB Bandwidth	PASS
FCC 15.247(a)(1) RSS-247.5.1(b)	Carrier Frequency Separation	PASS
FCC 15.247(a)(1)(iii) RSS-247.5.1(d)	Number of Hopping Frequencies	PASS
FCC 15.247(a)(1) RSS-247.5.4(b)	Average Time of Occupancy (Dwell Time)	PASS
FCC 15.247(b)1 RSS-247.5.4(b)	Maximum Peak Conducted Output Power and EIRP Power	PASS
FCC 15.247(d) RSS-247 5.5	Conducted Spurious Emissions	PASS
FCC Part 15.247(d) & FCC Part 15.209 & FCC Part 15.205 RSS-247 Clause 3.3	Radiated Spurious Emissions	PASS
FCC 15.207 RSS-Gen 8.8	Conducted Emission	PASS
FCC 15.203 RSS-Gen 6.7	Antenna Application	PASS
RSS-Gen.6.6	99% Occupied Bandwidth	PASS
NOTE1: N/A (Not Applicable)		

RELATED SUBMITTAL(S) / GRANT(S):

This submittal(s) (test report) is intended for FCC ID: MV3-HNECKPLUS filing to comply with Section 15.247 of the FCC Part 15, Subpart C.

This submittal(s) (test report) is intended for IC: 9029A-HNECKPLUS filing to comply with IC RSS-247 Issue 2 and IC RSS-GEN, Issue 5

4 TEST METHODOLOGY

4.1 GENERAL DESCRIPTION OF APPLIED STANDARDS

According to its specifications, the EUT must comply with the requirements of the following standards:
 FCC 47 CFR Part 2, Subpart J
 FCC 47 CFR Part 15, Subpart C
 DA 00-705
 IC RSS-GEN, Issue5, April 2018
 IC RSS-247, ISSUE 2 February 2017.

4.2 MEASUREMENT EQUIPMENT USED

4.2.1 Conducted Emission Test Equipment

EQUIPMENT TYPE	MFR	MODEL NUMBER	SERIAL NUMBER	LASTCAL.	DUE CAL.
Test Receiver	Rohde & Schwarz	ESCI	26115-010-0027	May 20, 2018	May 20, 2019
L.I.S.N.	Rohde & Schwarz	ENV216	101161	May 20, 2018	May 20, 2019
50Ω Coaxial Switch	Anritsu	MP59B	6100175589	May 20, 2018	May 20, 2019
Voltage Probe	Rohde & Schwarz	ESH2-Z3	100122	May 20, 2018	May 20, 2019
Pulse Limiter	Rohde & Schwarz	ESH3-Z2	100006	May 20, 2018	May 20, 2019
I.S.N	Teseq GmbH	ISN T800	30327	May 20, 2018	May 20, 2019

4.2.2 Radiated Emission Test Equipment

EQUIPMENT TYPE	MFR	MODEL NUMBER	SERIAL NUMBER	LAST CAL.	DUE CAL.
EMI Test Receiver	Rohde & Schwarz	ESU	1302.6005.26	May 20, 2018	May 20, 2019
Pre-Amplifier	HP	8447F	2944A07999	May 20, 2018	May 20, 2019
Bilog Antenna	Schwarzbeck	VULB9163	142	May 20, 2018	May 20, 2019
Loop Antenna	ARA	PLA-1030/B	1029	May 20, 2018	May 20, 2019
Horn Antenna	Schwarzbeck	BBHA 9170	BBHA9170399	May 20, 2018	May 20, 2019
Horn Antenna	Schwarzbeck	BBHA 9120	D143	May 20, 2018	May 20, 2019
Cable	Schwarzbeck	AK9513	ACRX1	May 20, 2018	May 20, 2019
Cable	Rosenberger	N/A	FP2RX2	May 20, 2018	May 20, 2019
Cable	Schwarzbeck	AK9513	CRPX1	May 20, 2018	May 20, 2019
Cable	Schwarzbeck	AK9513	CRRX2	May 20, 2018	May 20, 2019

4.2.3 Radio Frequency Test Equipment

EQUIPMENT TYPE	MFR	MODEL NUMBER	SERIAL NUMBER	LASTCAL.	DUE CAL.
Spectrum Analyzer	Agilent	E4407B	88156318	May 20, 2018	May 20, 2019
Signal Analyzer	Agilent	N9010A	My53470879	May 20, 2018	May 20, 2019
Power meter	Anritsu	ML2495A	0824006	May 20, 2018	May 20, 2019
Power sensor	Anritsu	MA2411B	0738172	May 20, 2018	May 20, 2019

Remark: Each piece of equipment is scheduled for calibration once a year.

4.3 DESCRIPTION OF TEST MODES

The EUT has been tested under its typical operating condition.

The EUT configuration for testing is installed on RF field strength measurement to meet the Commissions requirement and operating in a manner which intends to maximize its emission characteristics in a continuous normal application.

The Transmitter was operated in the normal operating mode. The TX frequency was fixed which was for the purpose of the measurements.

Test of channel included the lowest and middle and highest frequency to perform the test, then record on this report.

Those data rates (1Mbps for Bluetooth GFSK modulation; 2Mbps for Bluetooth pi/4-DQPSK modulation; 3Mbps for Bluetooth 8DPSK modulation) were used for all test.

Pre-defined engineering program for regulatory testing used to control the EUT for staying in continuous transmitting and receiving mode is programmed.

Frequency and Channel list for Bluetooth BT4.1+EDR:

Channel	Frequency (MHz)	Channel	Frequency (MHz)	Channel	Frequency (MHz)
0	2402	39	2441
1	2403	40	2442	76	2478
2	2404	41	2443	77	2479
...	78	2480
Note: $f_c = 2402\text{MHz} + (k-1) \times 1\text{MHz}$ k=1 to 79					

Test Frequency and channel for BT4.1+EDR:

Lowest Frequency		Middle Frequency		Highest Frequency	
Channel	Frequency (MHz)	Channel	Frequency (MHz)	Channel	Frequency (MHz)
0	2402	39	2441	78	2480

5 FACILITIES AND ACCREDITATIONS

5.1 FACILITIES

All measurement facilities used to collect the measurement data are located at

Bldg 69, Majialong Industry Zone District, Nanshan District, Shenzhen, China

The sites are constructed in conformance with the requirements of ANSI C63.7, ANSI C63.10 and CISPR Publication 22.

5.2 LABORATORY ACCREDITATIONS AND LISTINGS

Site Description

EMC Lab.

- : Accredited by CNAS, 2016.10.24
The certificate is valid until 2022.10.28
The Laboratory has been assessed and proved to be in compliance with CNAS-CL01: 2006(identical to ISO/IEC17025: 2005)
The Certificate Registration Number is L2291

- : Accredited by TUV Rheinland Shenzhen, 2016.5.19
The Laboratory has been assessed according to the requirements ISO/IEC 17025.

- : Accredited by FCC, August 06, 2018
The certificate is valid until August 07, 2020
Designation Number: CN1204
Test Firm Registration Number: 882943

- : Accredited by Industry Canada, November 24, 2015
The Certificate Registration Number is 4480A

6 TEST SYSTEM UNCERTAINTY

The following measurement uncertainty levels have been estimated for tests performed on the apparatus:

Parameter	Uncertainty
Radio Frequency	$\pm 1 \times 10^{-5}$
Maximum Peak Output Power Test	$\pm 1.0\text{dB}$
Conducted Emissions Test	$\pm 2.0\text{dB}$
Radiated Emission Test	$\pm 2.0\text{dB}$
Occupied Bandwidth Test	$\pm 1.0\text{dB}$
Band Edge Test	$\pm 3\text{dB}$
All emission, radiated	$\pm 3\text{dB}$
Antenna Port Emission	$\pm 3\text{dB}$
Temperature	$\pm 0.5^\circ\text{C}$
Humidity	$\pm 3\%$

Measurement Uncertainty for a level of Confidence of 95%

7 SETUP OF EQUIPMENT UNDER TEST

7.1 RADIO FREQUENCY TEST SETUP 1

The Bluetooth component's antenna ports(s) of the EUT are connected to the measurement instrument per an appropriate attenuator. The EUT is controlled by PC/software to emit the specified signals for the purpose of measurements.

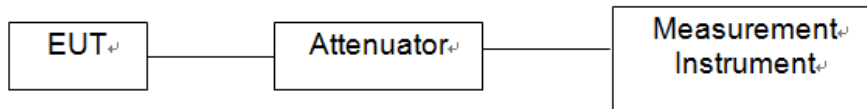

7.2 RADIO FREQUENCY TEST SETUP 2

The test site semi-anechoic chamber has met the requirement of NSA tolerance 4 dB according to the standards: ANSI C63.10. The test distance is 3m. The setup is according to the requirements in Section 13.1.4.1 of ANSI C63.10-2013 and CAN/CSA-CEI/IEC CISPR 22.

Below 30MHz:

The EUT is placed on a turntable 0.8 meters above the ground in the chamber, 3 meter away from the antenna (loop antenna). The Antenna should be positioned with its plane vertical at the specified distance from the EUT and rotated about its vertical axis for maximum response at each azimuth about the EUT. The center of the loop shall be 1 m above the ground. For certain applications, the loop antenna plane may also need to be positioned horizontally at the specified distance from the EUT.

30MHz-1GHz:

The EUT is placed on a turntable 0.8 meters above the ground in the chamber, 3 meter away from the antenna. The maximal emission value is acquired by adjusting the antenna height, polarisation and turntable azimuth. Normally, the height range of antenna is 1 m to 4 m, the azimuth range of turntable is 0° to 360°, and the receive antenna has two polarizations Vertical (V) and Horizontal (H).

Above 1GHz:

The EUT is placed on a turntable 1.5 meters above the ground in the chamber, 3 meter away from the antenna. The maximal emission value is acquired by adjusting the antenna height, polarisation and turntable azimuth. Normally, the height range of antenna is 1 m to 4 m, the azimuth range of turntable is 0° to 360°, and the receive antenna has two polarizations Vertical (V) and Horizontal (H).

(a) Radiated Emission Test Set-Up, Frequency Below 30MHz

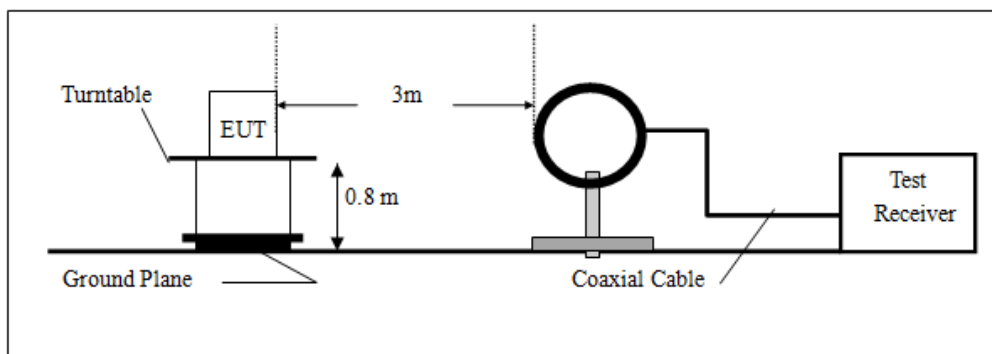

(b) Radiated Emission Test Set-Up, Frequency Below 1000MHz

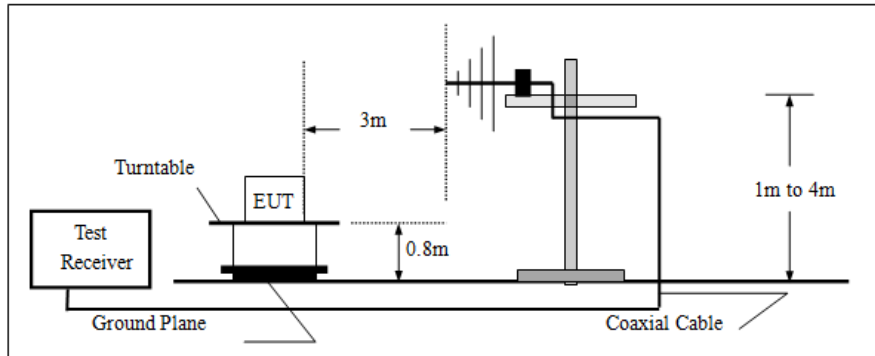

(c) Radiated Emission Test Set-Up, Frequency above 1000MHz

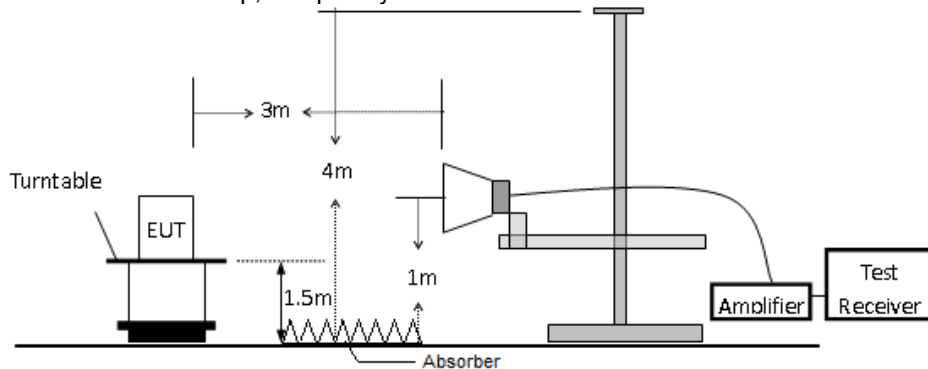

7.3 CONDUCTED EMISSION TEST SETUP

The mains cable of the EUT (Game fitness board) must be connected to LISN. The LISN shall be placed 0.8 m from the boundary of EUT and bonded to a ground reference plane for LISN mounted on top of the ground reference plane. This distance is between the closest points of the LISN and the EUT. All other units of the EUT and associated equipment shall be at least 0.8m from the LISN.

Ground connections, where required for safety purposes, shall be connected to the reference ground point of the LISN and, where not otherwise provided or specified by the manufacturer, shall be of same length as the mains cable and run parallel to the mains connection at a separation distance of not more than 0.1 m.

According to the requirements in Section 13.1.4.1 of ANSI C63.10-2013 Conducted emissions from the EUT measured in the frequency range between 0.15 MHz and 30 MHz using CISPR Quasi-Peak and average detector mode.

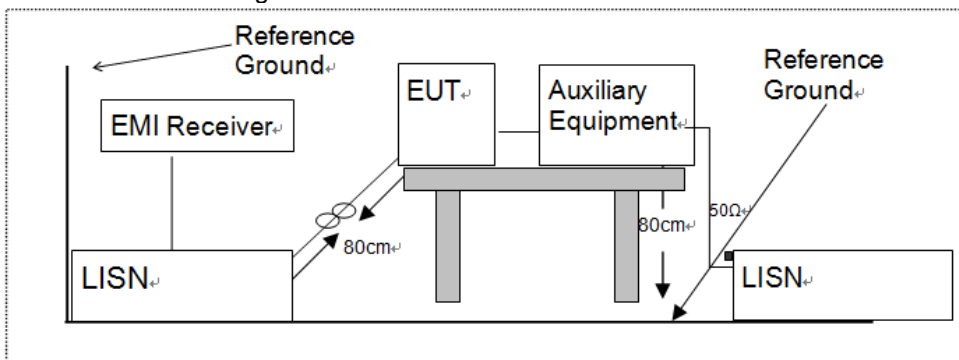

7.4 SUPPORT EQUIPMENT

Item	Equipment	Mfr/Brand	Model/Type No.	Note
1.	Adapter	TEKE	TEKA006-0501500UKU	N/A
2.	iPhone	Apple	A1526	N/A

Notes:

1. *All the equipment/cables were placed in the worst-case configuration to maximize the emission during the test.*
2. *Grounding was established in accordance with the manufacturer's requirements and conditions for the intended use.*

8 FREQUENCY HOPPING SYSTEM REQUIREMENTS

8.1 Standard Applicable

According to FCC Part 15.247(a)(1), The system shall hop to channel frequencies that are selected at the system hopping rate from a pseudo randomly ordered list of hopping frequencies. Each frequency must be used equally on the average by each transmitter. The system receivers shall have input bandwidths that match the hopping channel bandwidths of their corresponding transmitters and shall shift frequencies in synchronization with the transmitted signals.

(g) Frequency hopping spread spectrum systems are not required to employ all available hopping channels during each transmission. However, the system, consisting of both the transmitter and the receiver, must be designed to comply with all of the regulations in this section should the transmitter be presented with a continuous data (or information) stream. In addition, a system employing short transmission bursts must comply with the definition of a frequency hopping system and must distribute its transmissions over the minimum number of hopping channels specified in this section.

(h) The incorporation of intelligence within a frequency hopping spread spectrum system that permits the system to recognize other users within the spectrum band so that it individually and independently chooses and adapts its hopsets to avoid hopping on occupied channels is permitted. The coordination of frequency hopping systems in any other manner for the express purpose of avoiding the simultaneous occupancy of individual hopping frequencies by multiple transmitters is not permitted.

8.2 EUT Pseudorandom Frequency Hopping Sequence

The channel is represented by a pseudo-random hopping sequence hopping through the 79 RF channels. The hopping sequence is unique for the piconet and is determined by the Bluetooth device address of the master; the phase in the hopping sequence is determined by the Bluetooth clock of the master. The channel is divided into time slots where each slot corresponds to an RF hop frequency. Consecutive hops correspond to different RF hop frequencies. The normal hop is 1 600 hops/s.

The pseudorandom sequence may be generated in a nine-stage shift register whose 5th and 9th stage outputs are added in a modulo-two addition stage, and the result is fed back to the input of the first stage. The sequence begins with the first ONE of 9 consecutive ONES; i.e. the shift register is initialized with nine ones. Number of shift register stages: 9
Length of pseudo-random sequence: $2^9 - 1 = 511$ bits
Longest sequence of zeros: 8 (non-inverted signal)

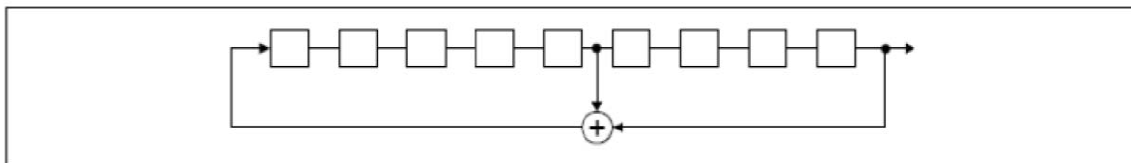

Linear Feedback Shift Register for Generation of the PRBS sequence

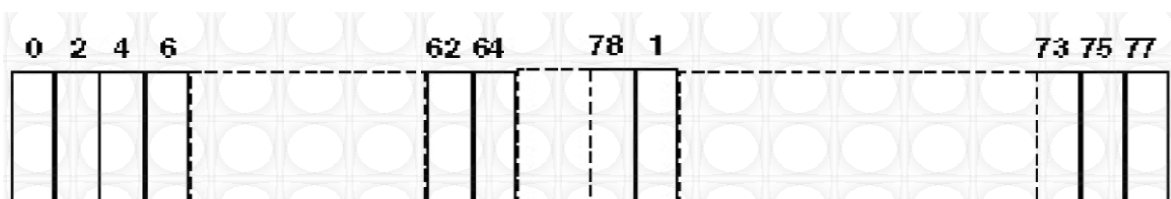

Each frequency used equally on the average by each transmitter.

The system receiver have input bandwidths that match the hopping channel bandwidths of their corresponding transmitters and shift frequencies in synchronization with the transmitted signals.

8.3 Equal Hopping Frequency Use

All Bluetooth units participating in the piconet are time and hop-synchronized to the channel.

Example of a 79 hopping sequence in data mode:

35, 27, 6, 44, 14, 61, 74, 32, 1, 11, 23, 2, 55, 65, 29, 3, 9, 52, 78, 58, 40, 25, 0, 7, 18, 26, 76, 60, 47, 50, 2, 5, 16, 37, 70, 63, 66, 54, 20, 13, 4, 8, 15, 21, 26, 10, 73, 77, 67, 69, 43, 24, 57, 39, 46, 72, 48, 33, 17, 31, 75, 19, 41, 62, 68, 28, 51, 66, 30, 56, 34, 59, 71, 22, 49, 64, 38, 45, 36, 42, 53

Each Frequency used equally on the average by each transmitter

8.4 Frequency Hopping System

This transmitter device is frequency hopping device, and complies with FCC part 15.247 rule.

This device uses Bluetooth radio which operates in 2400-2483.5 MHz band. Bluetooth uses a radio technology called frequency-hopping spread spectrum, which chops up the data being sent and transmits chunks of it on up to 79 bands (1 MHz each; centred from 2402 to 2480 MHz) in the range 2,400-2,483.5 MHz. The transmitter switches hop frequencies 1,600 times per second to assure a high degree of data security. All Bluetooth devices participating in a given piconet are synchronized to the frequency-hopping channel for the piconet. The frequency hopping sequence is determined by the master's device address and the phase of the hopping sequence (the frequency to hop at a specific time) is determined by the master's internal clock. Therefore, all slaves in a piconet must know the master's device address and must synchronize their clocks with the master's clock.

Adaptive Frequency Hopping (AFH) was introduced in the Bluetooth specification to provide an effective way for a Bluetooth radio to counteract normal interference. AFH identifies "bad" channels, where either other wireless devices are interfering with the Bluetooth signal or the Bluetooth signal is interfering with another device. The AFH-enabled Bluetooth device will then communicate with other devices within its piconet to share details of any identified bad channels. The devices will then switch to alternative available "good" channels, away from the areas of interference, thus having no impact on the bandwidth used.

Test Model	20dB Bandwidth	
	Channel 0: 2402MHz	GFSKModulation

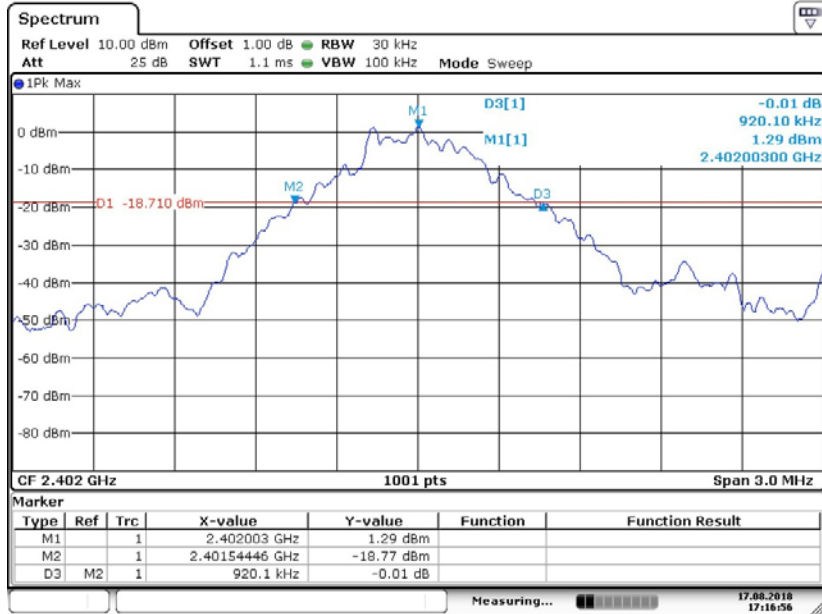

Date: 17.AUG.2018 17:16:55

Test Model	20dB Bandwidth	
	Channel 39: 2441MHz	GFSKModulation

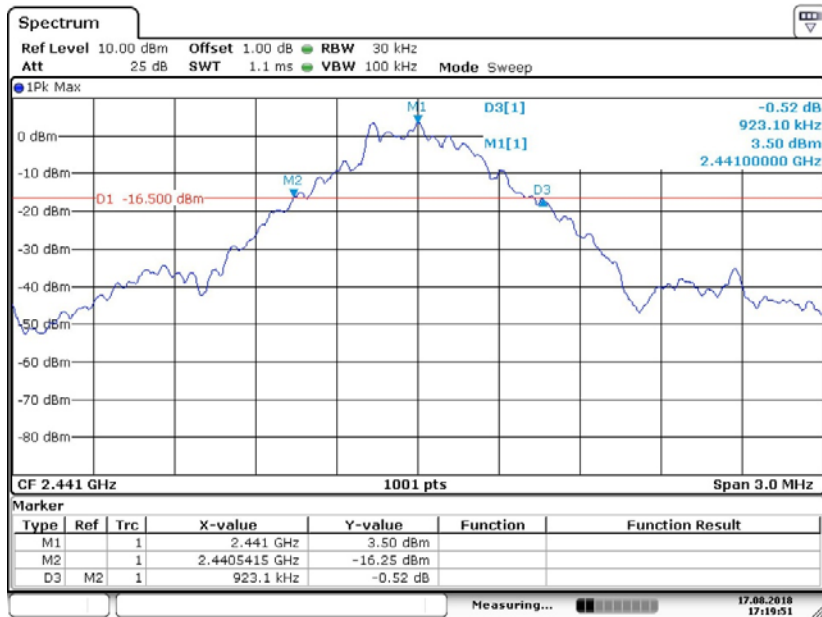

Date: 17.AUG.2018 17:19:52

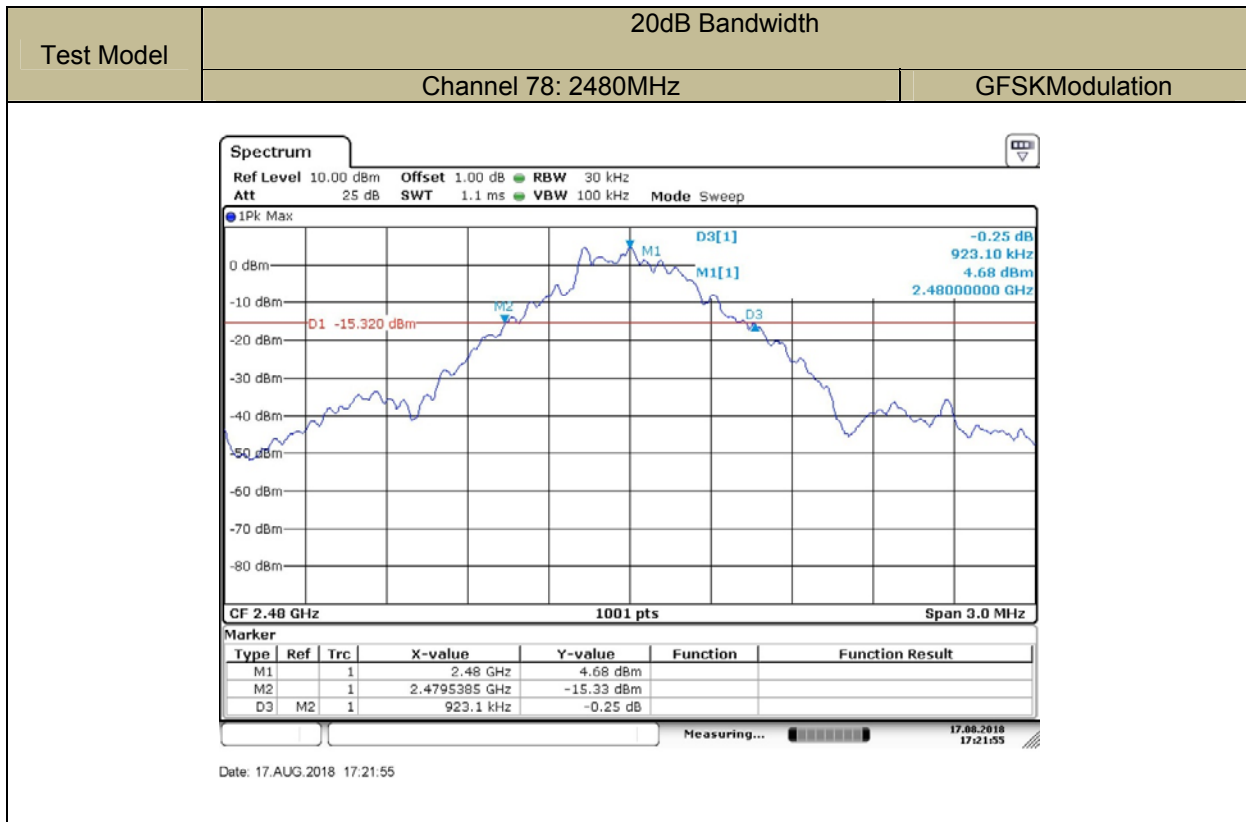

Test Model	20dB Bandwidth	
	Channel 0: 2402MHz	8DPSKModulation

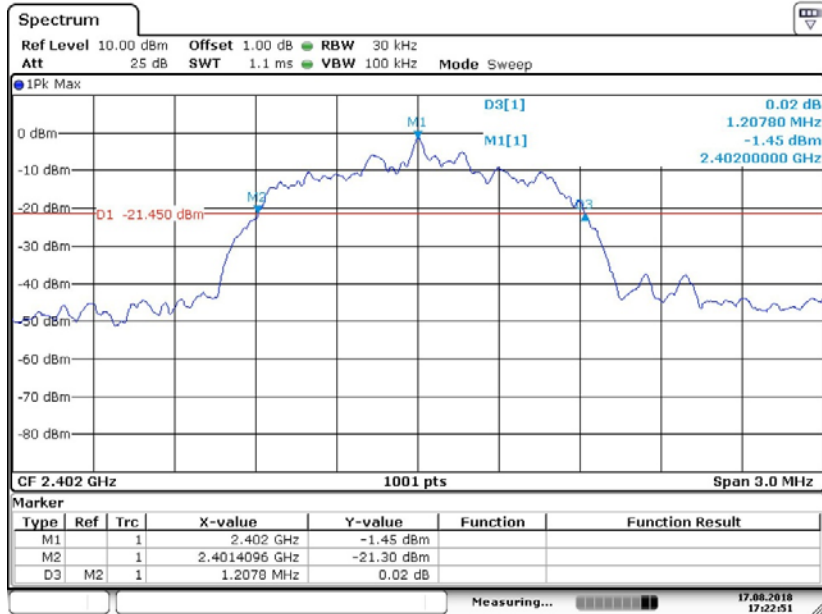

Date: 17.AUG.2018 17:22:51

Test Model	20dB Bandwidth	
	Channel 39: 2441MHz	8DPSKModulation

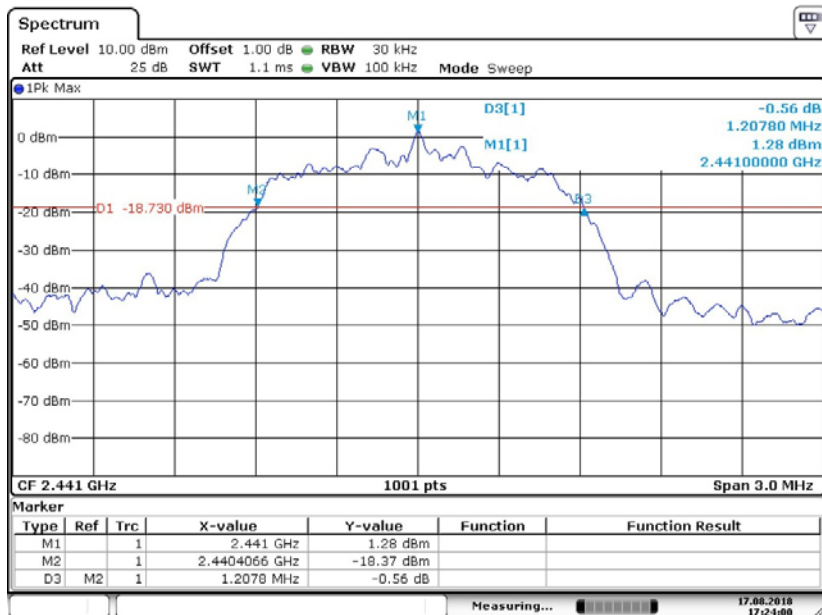

Date: 17.AUG.2018 17:24:00

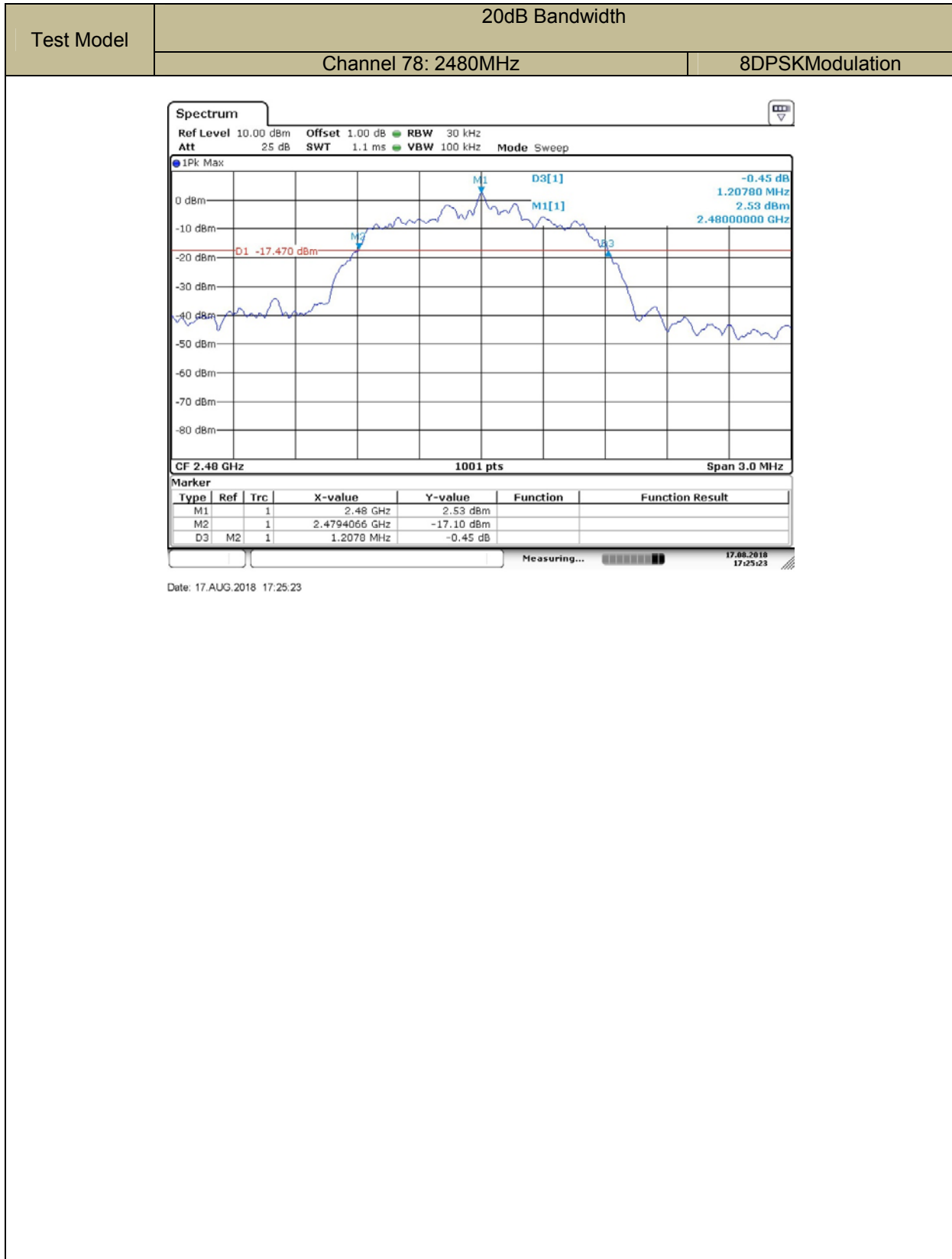

Test Model	99% Bandwidth	
	Channel 0: 2402MHz	GFSKModulation

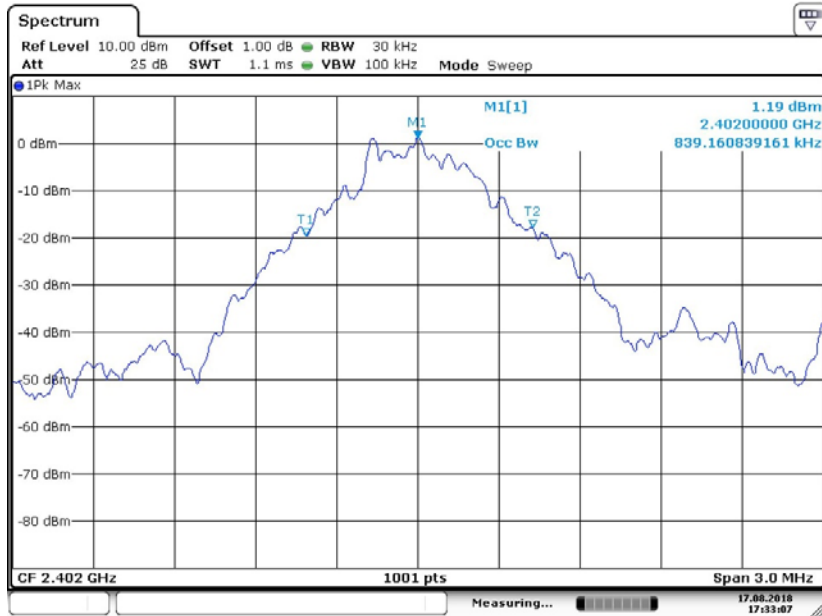

Date: 17.AUG.2018 17:33:07

Test Model	99% Bandwidth	
	Channel 39: 2441MHz	GFSKModulation

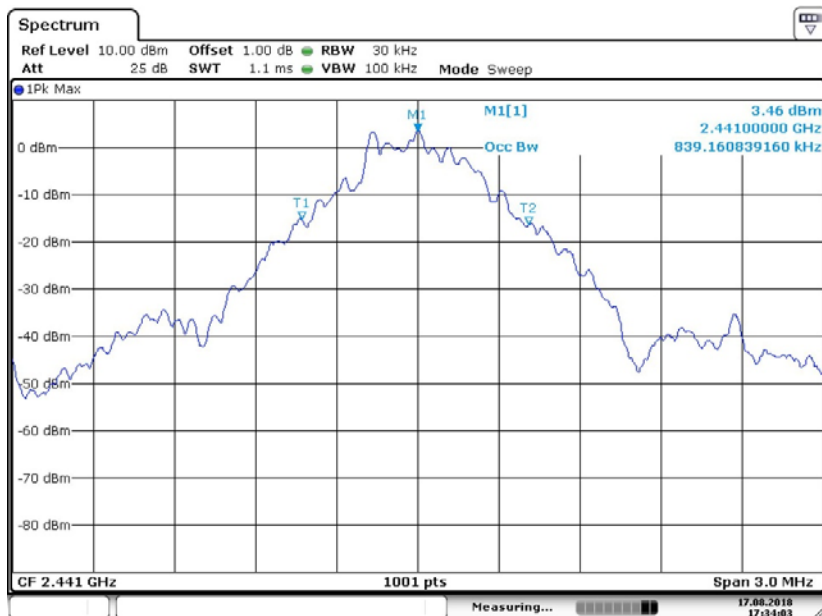

Date: 17.AUG.2018 17:34:03

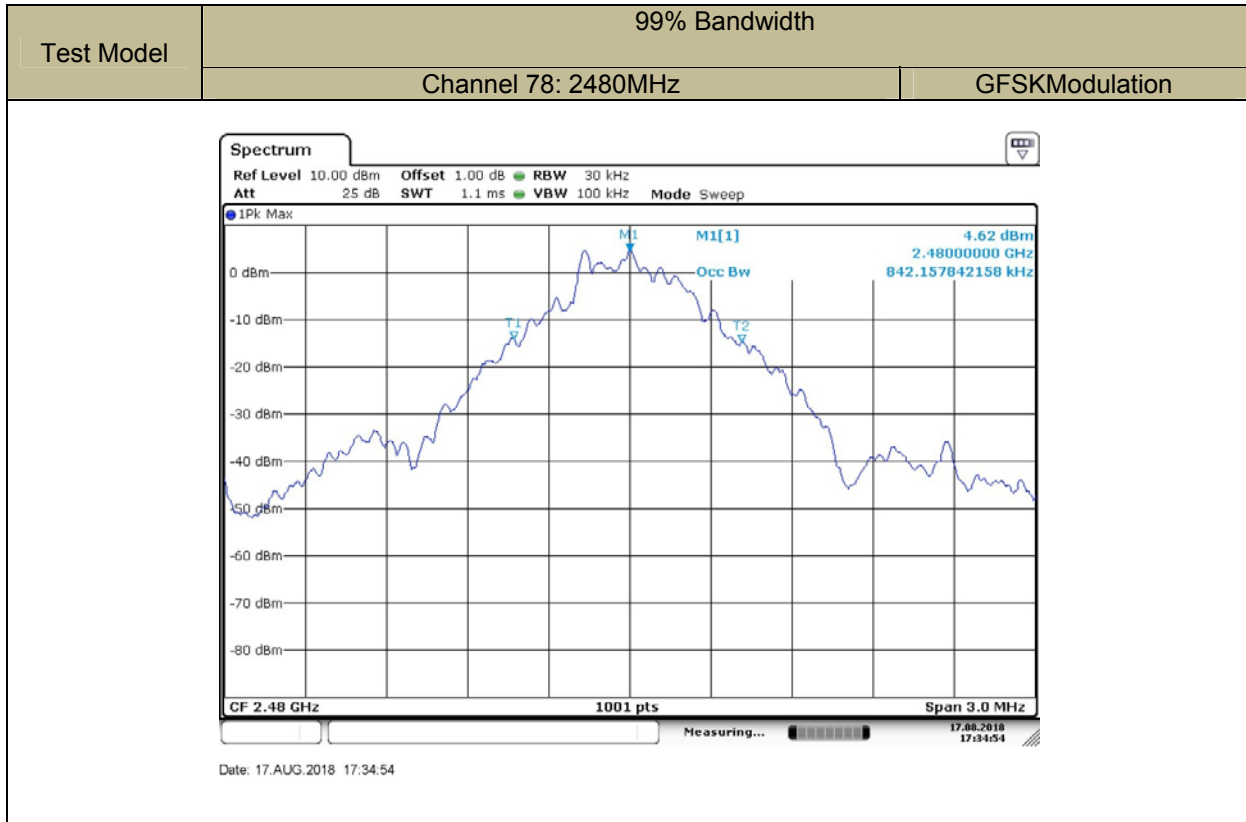

Test Model	99% Bandwidth	
	Channel 0: 2402MHz	8DPSKModulation

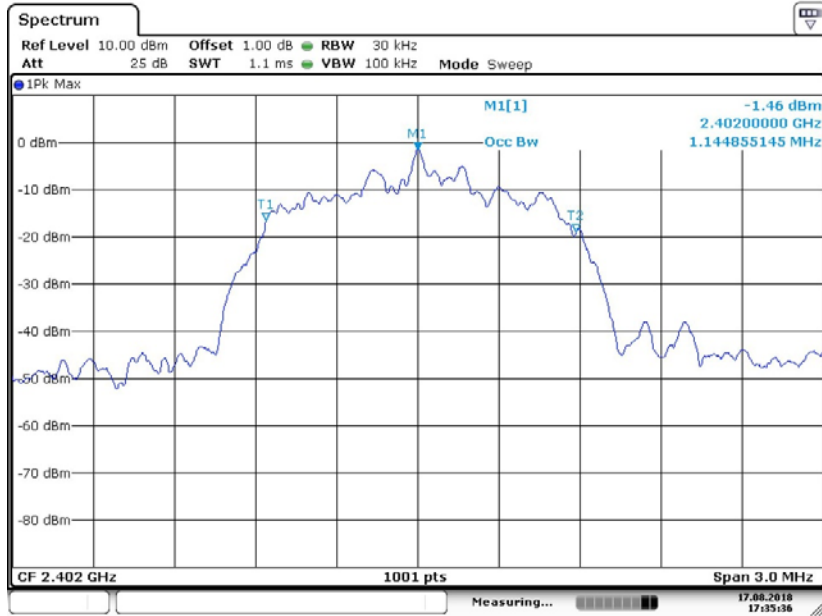

Date: 17.AUG.2018 17:35:37

Test Model	99% Bandwidth	
	Channel 39: 2441MHz	8DPSKModulation

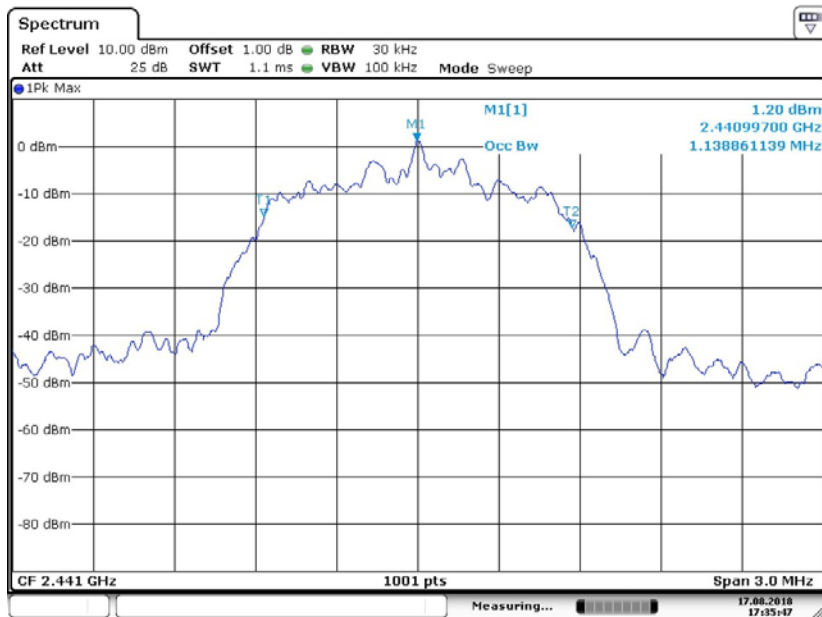

Date: 17.AUG.2018 17:35:47



Test Model	Carrier Frequency Separation	
	Channel 0: 2402MHz	GFSKModulation

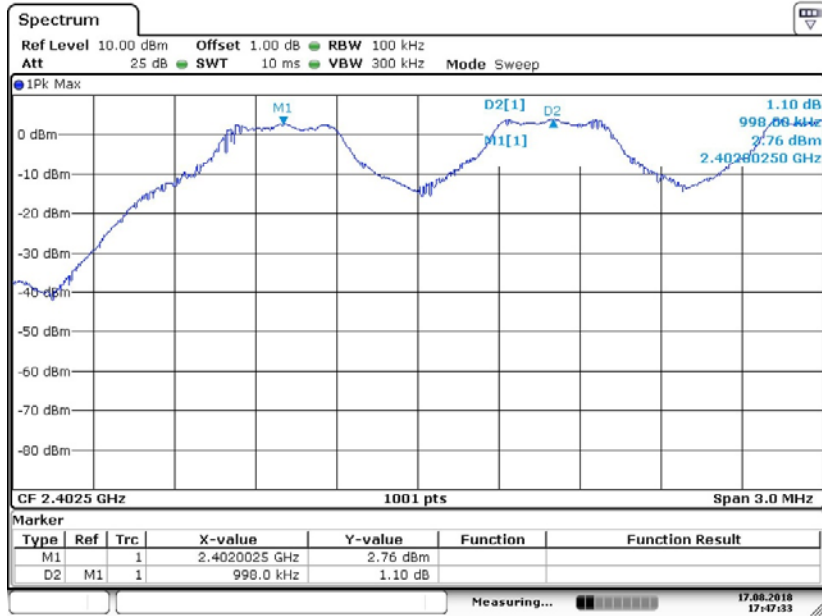

Date: 17.AUG.2018 17:47:34

Test Model	Carrier Frequency Separation	
	Channel 39: 2441MHz	GFSKModulation

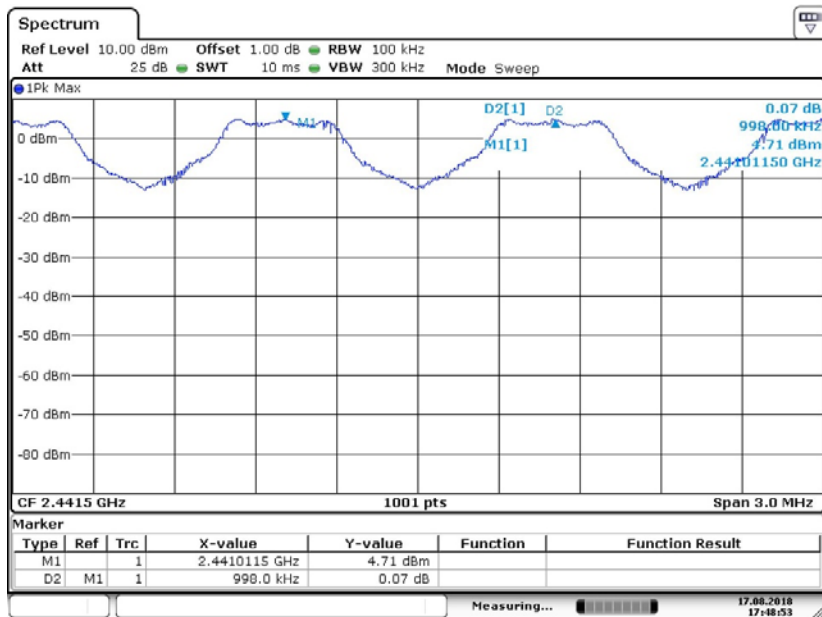

Date: 17.AUG.2018 17:48:53

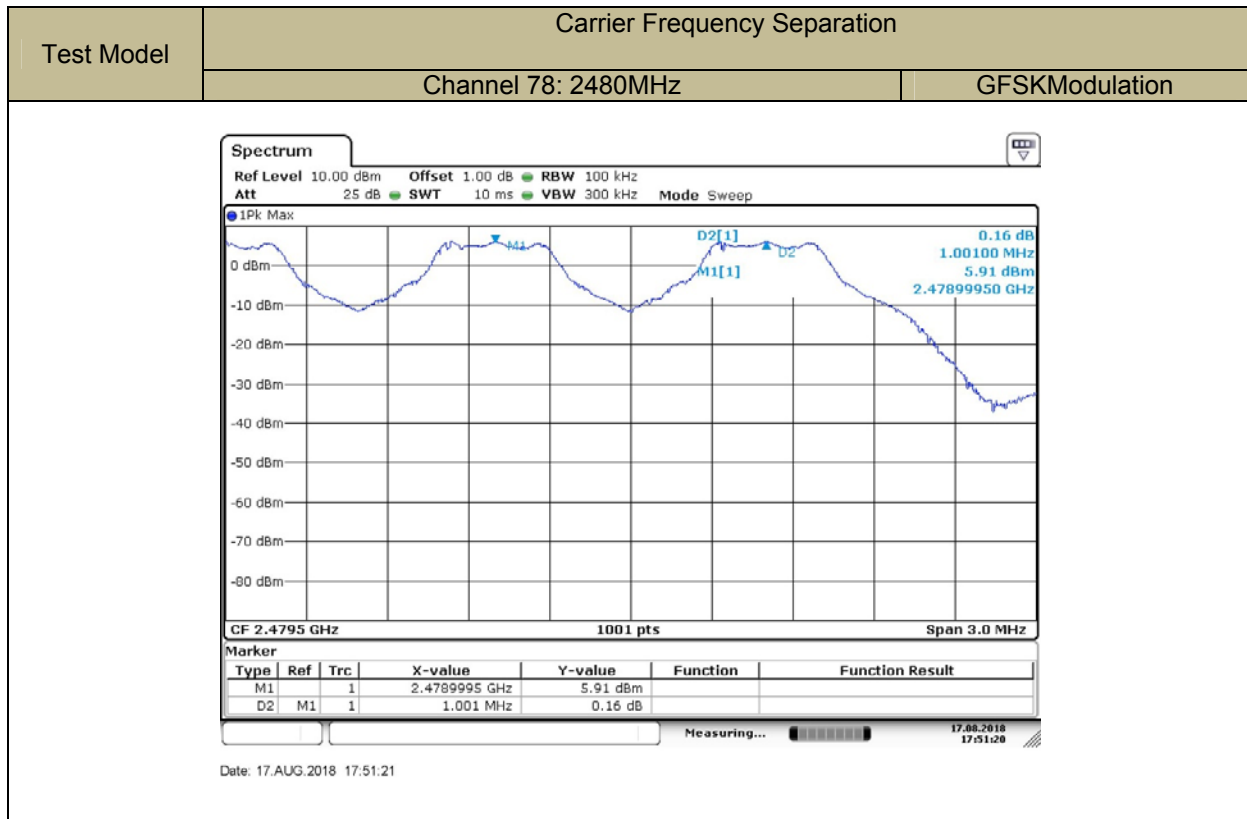

Test Model	Carrier Frequency Separation	
	Channel 0: 2402MHz	8DPSKModulation

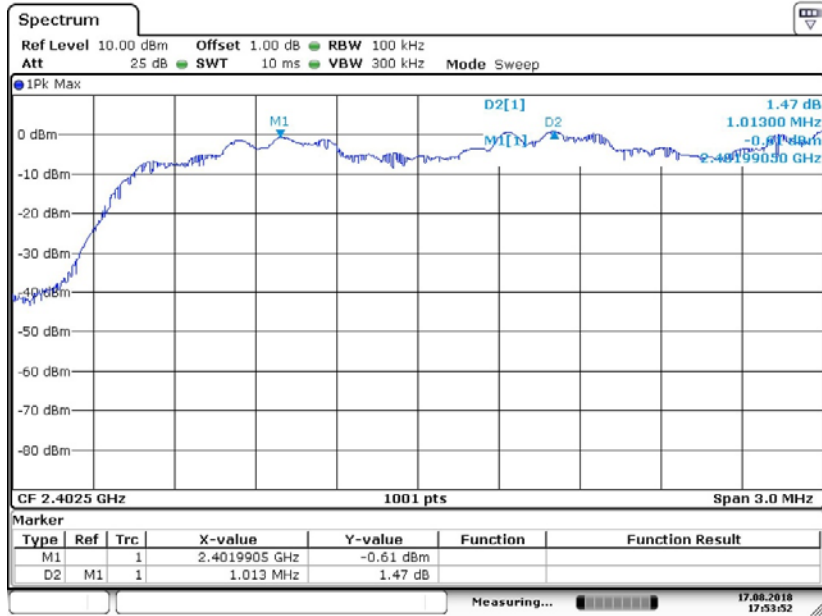

Date: 17.AUG.2018 17:53:51

Test Model	Carrier Frequency Separation	
	Channel 39: 2441MHz	8DPSKModulation

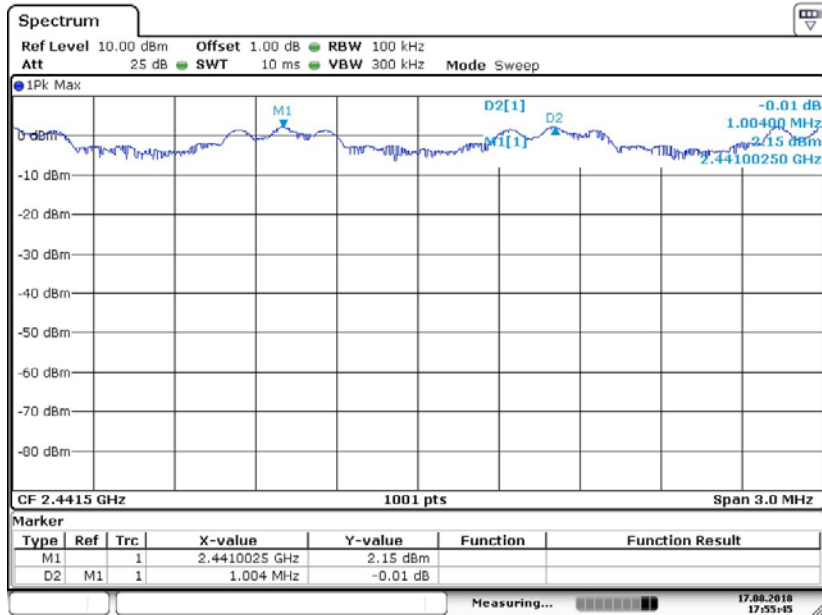

Date: 17.AUG.2018 17:53:45



9.4 NUMBER OF HOPPING FREQUENCIES

9.4.1 Applicable Standard

According to FCC Part 15.247(a)(1) (iii) and DA 00-705

9.4.2 Conformance Limit

Frequency hopping systems operating in the 2400-2483.5MHz band shall use at least 15 channels.

9.4.3 Test Configuration

Test according to clause 7.1 radio frequency test setup 1

9.4.4 Test Procedure

- According to FCC Part 15.247(a)(1)(iii)

The EUT must have its hopping function enabled. Use the following spectrum analyzer settings:

Span = the frequency band of operation

RBW = 100kHz

VBW ≥ RBW

Sweep = auto

Detector function = peak

Trace = max hold

Allow the trace to stabilize. It may prove necessary to break the span up to sections, in order to clearly show all of the hopping frequencies.

Test Results

All modulation were test, the worst case as follow:

Temperature:	24°C	Test Date:	August 17, 2018
Humidity:	53 %	Test By:	KK

Hopping Channel Frequency Range	Quantity of Hopping Channel	Quantity of Hopping Channel limit
2402-2480	79	> 15
Note: Both BR & EDR mode has been evaluated, and the worst result recorded was report.		

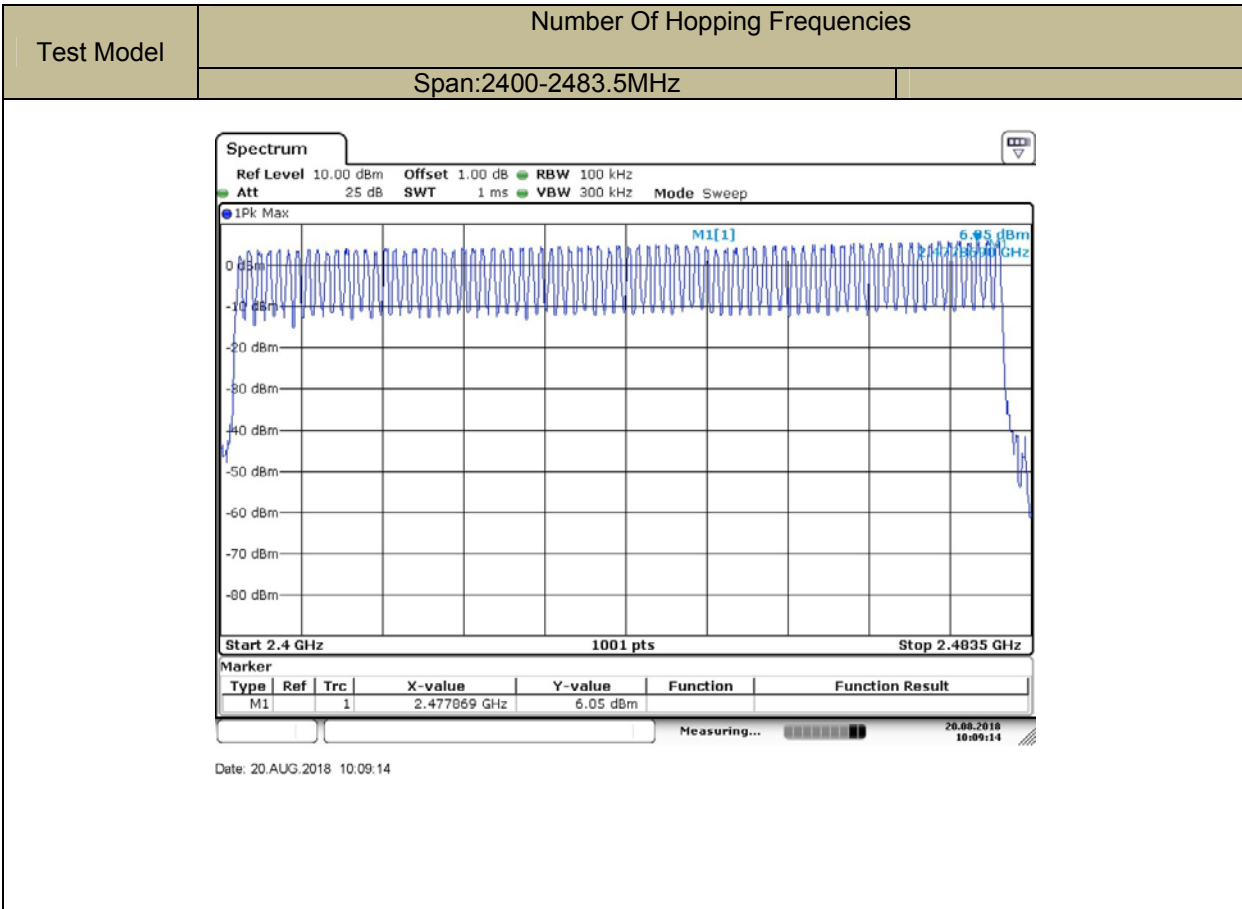

Test Model	Average Time Of Occupancy (Dwell Time)	
	CH 0: 2402MHz	GFSK DH1

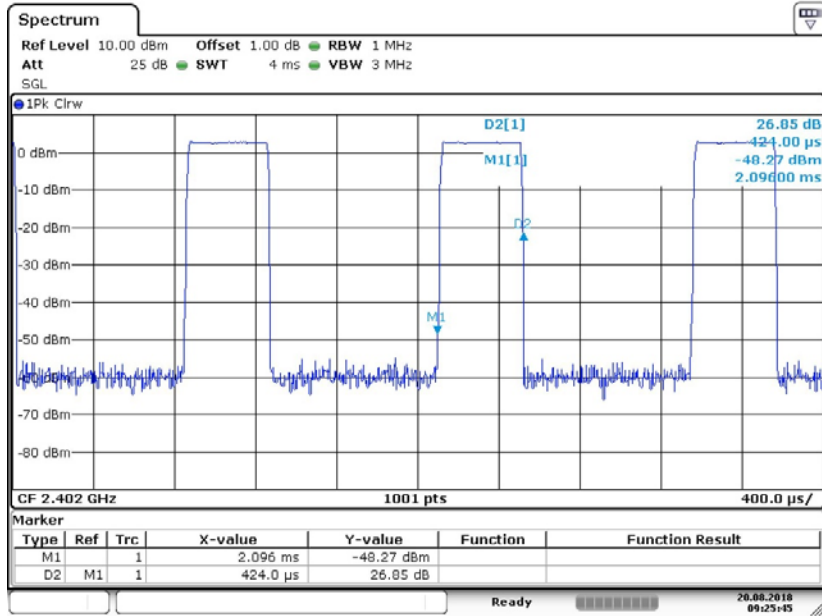

Date: 20.AUG.2018 09:25:45

Test Model	Average Time Of Occupancy (Dwell Time)	
	CH 0: 2402MHz	GFSK DH3

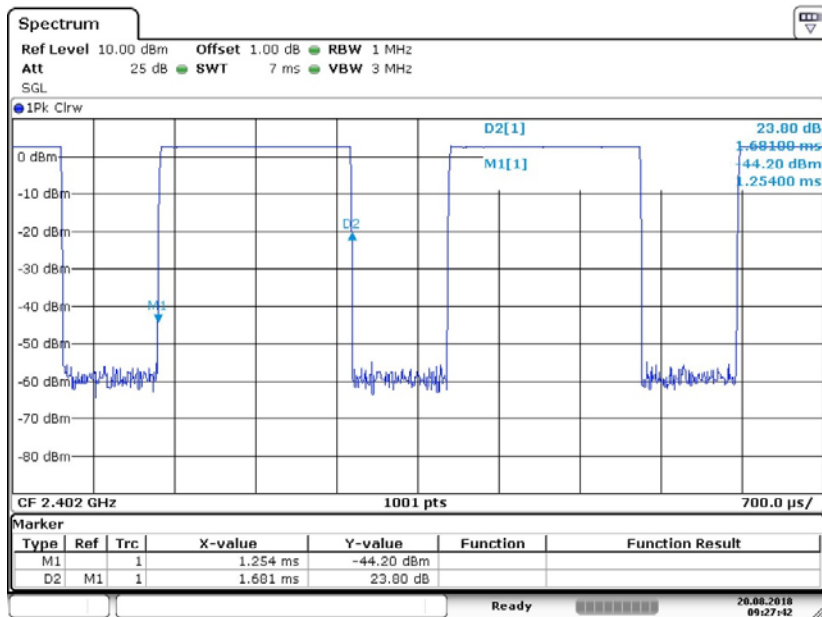

Date: 20.AUG.2018 09:27:42

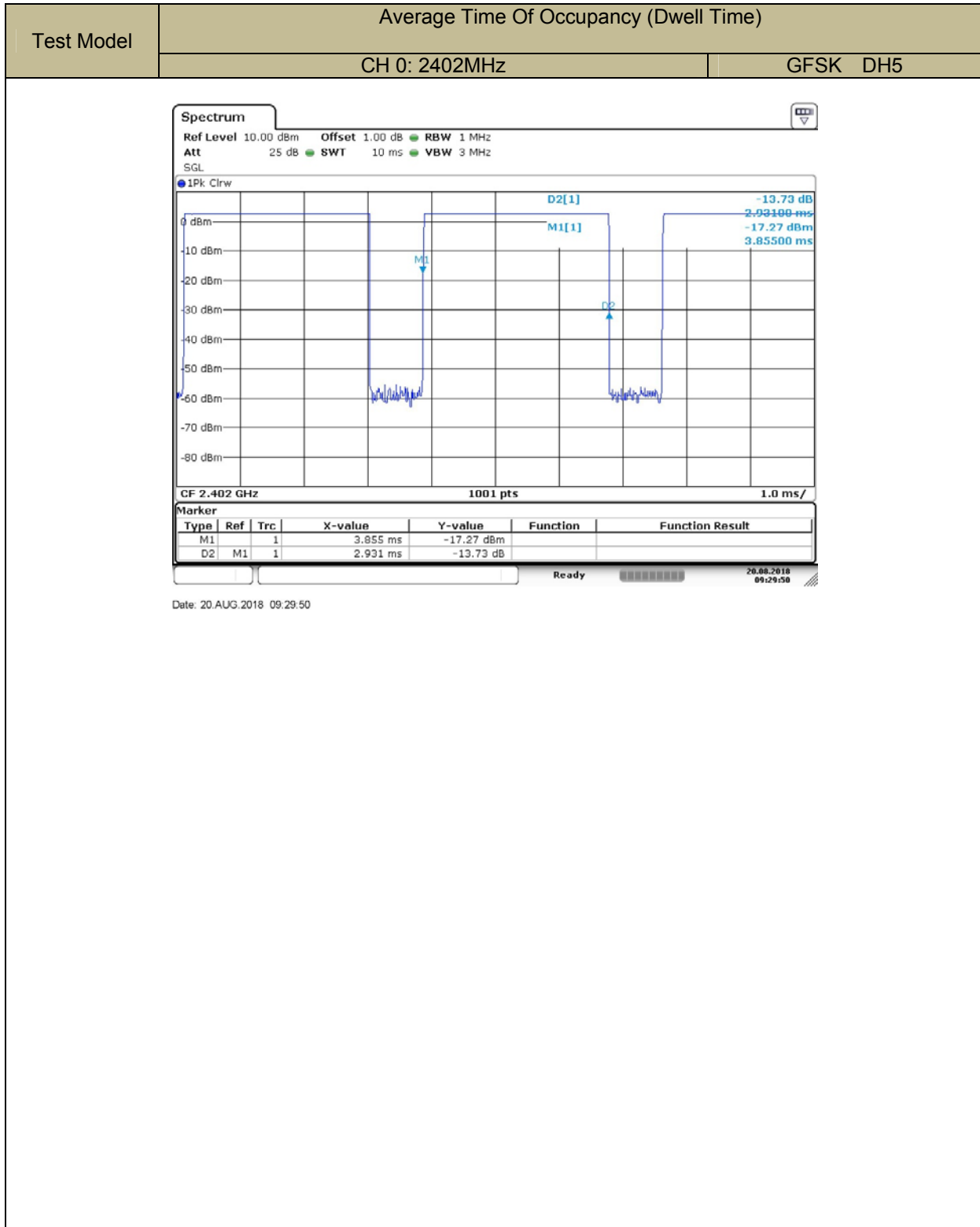

Test Model	Average Time Of Occupancy (Dwell Time)	
	CH 39: 2441MHz	GFSK DH1

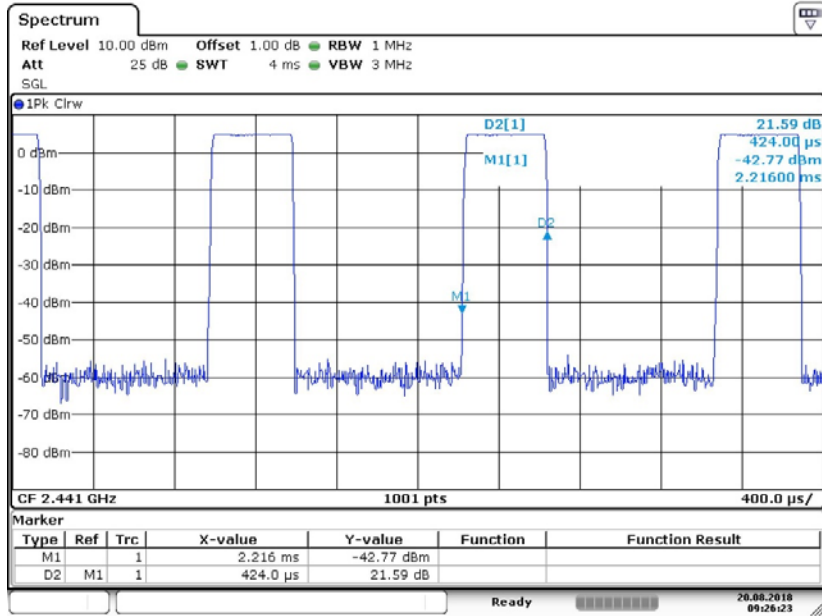

Date: 20.AUG.2018 09:26:23

Test Model	Average Time Of Occupancy (Dwell Time)	
	CH 39: 2441MHz	GFSK DH3

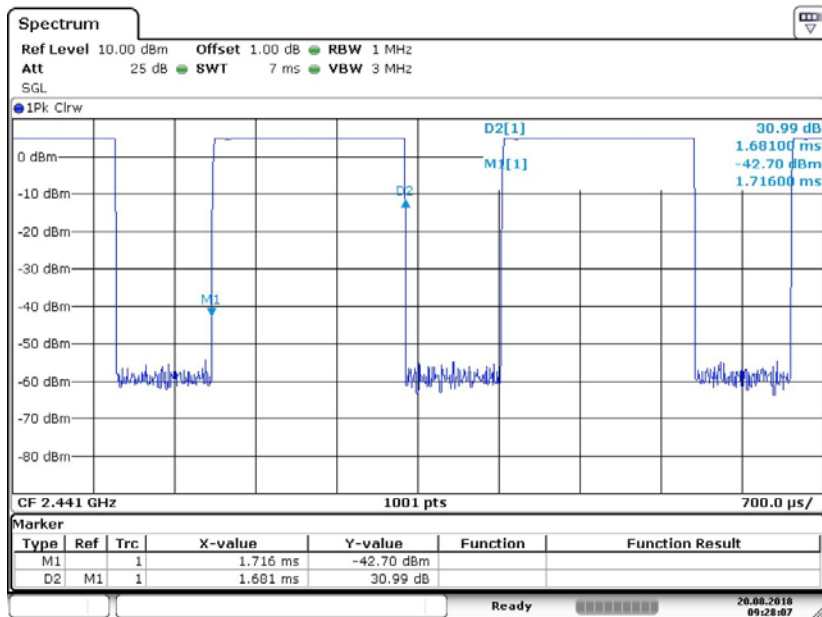

Date: 20.AUG.2018 09:26:07

Test Model	Average Time Of Occupancy (Dwell Time)	
	CH 39: 2441MHz	GFSK DH5

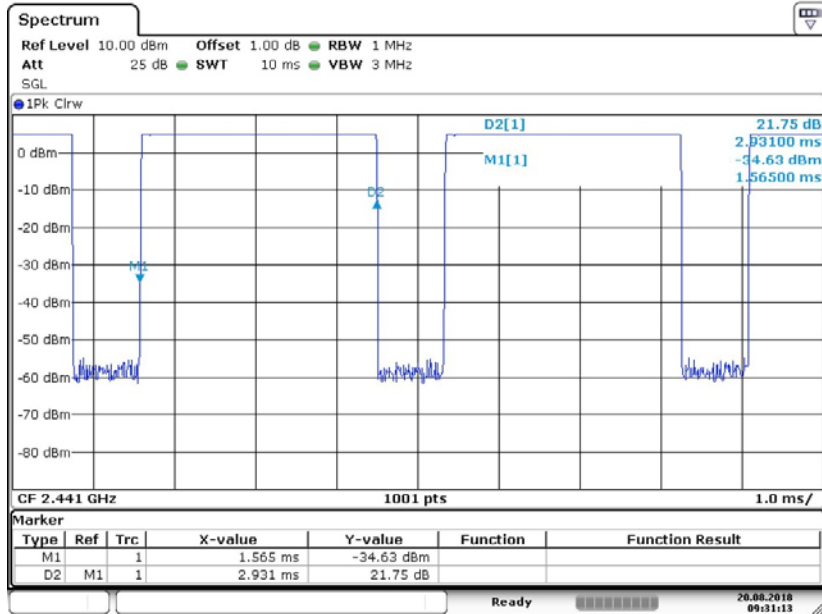

Date: 20.AUG.2018 09:31:13

Test Model	Average Time Of Occupancy (Dwell Time)	
	CH 78: 2480MHz	GFSK DH1

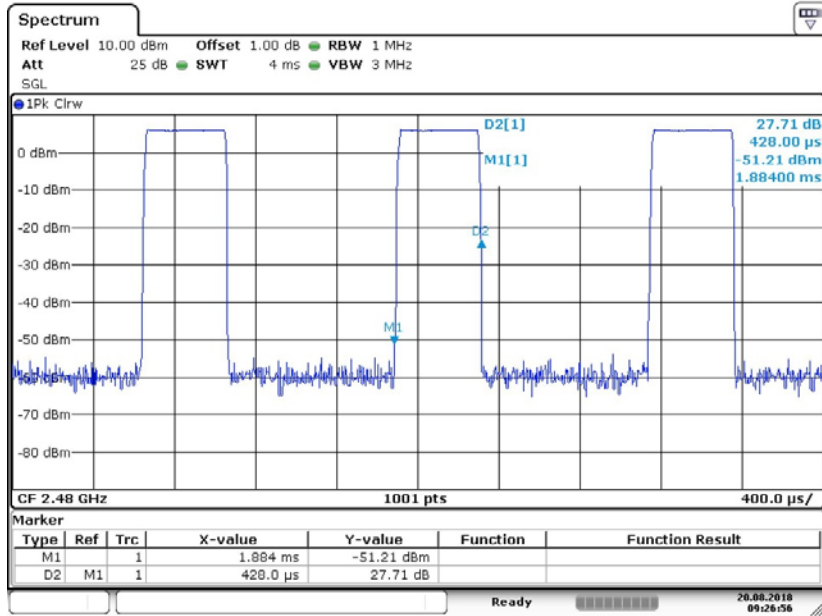

Date: 20.AUG.2018 09:26:56

Test Model	Average Time Of Occupancy (Dwell Time)	
	CH 78: 2480MHz	GFSK DH3

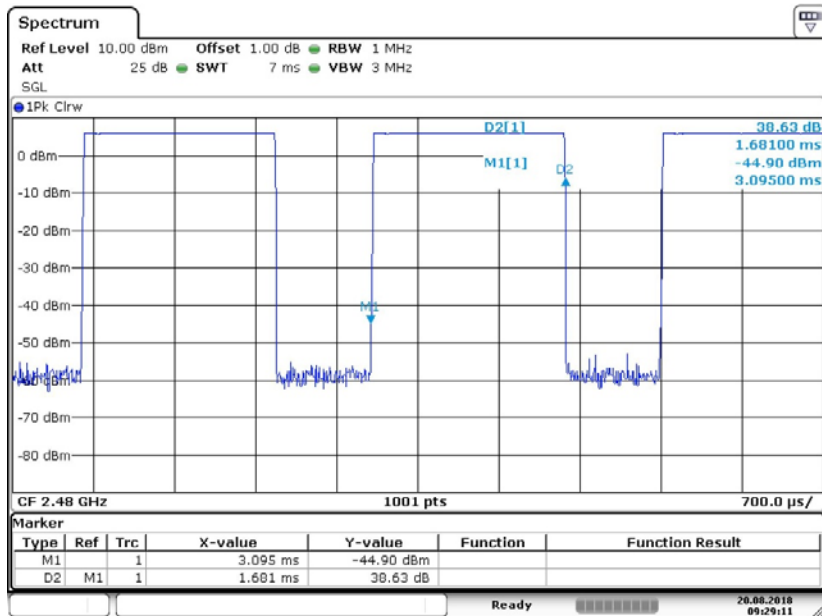

Date: 20.AUG.2018 09:29:11

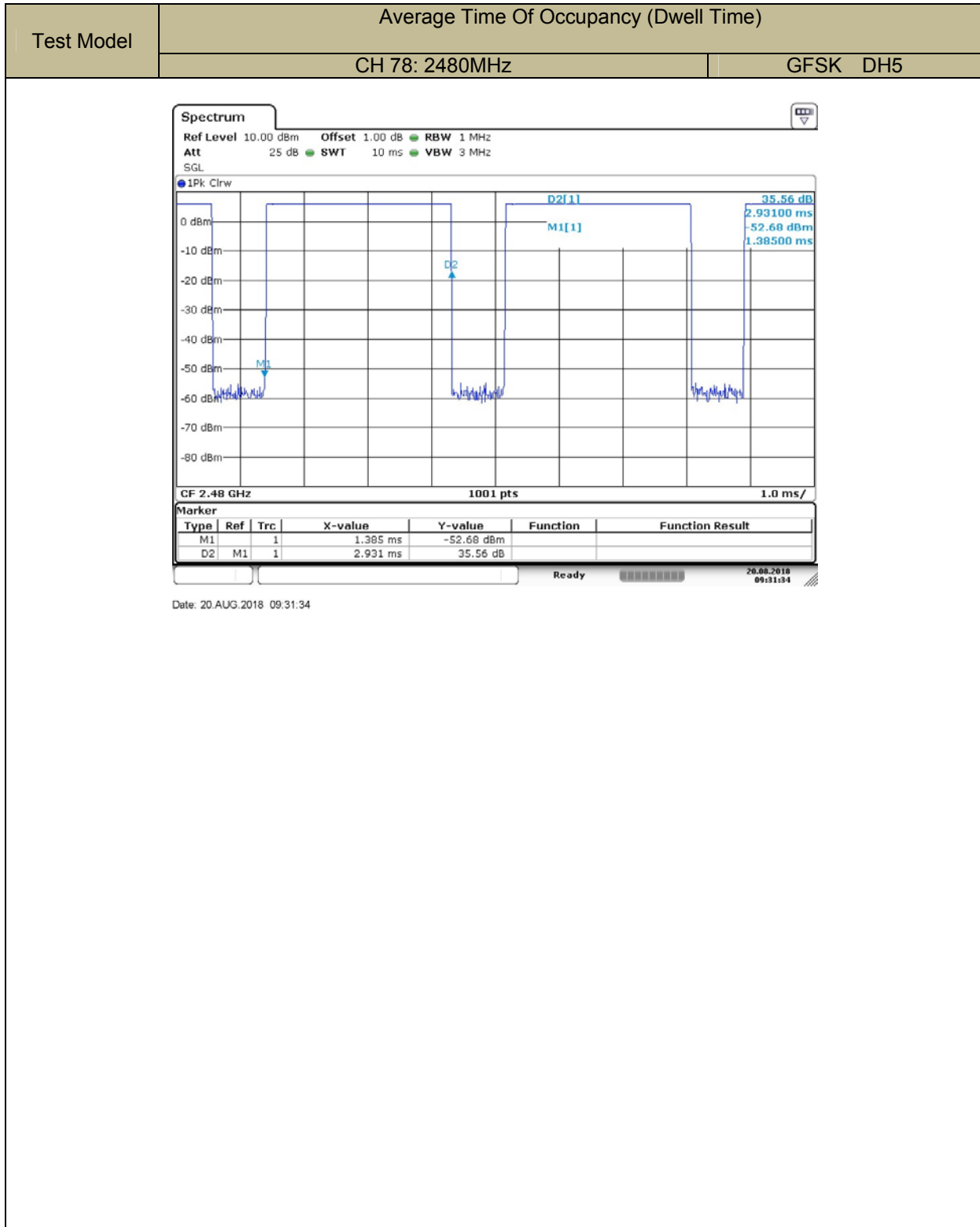

Test Model	Average Time Of Occupancy (Dwell Time)	
	CH 0: 2402MHz	8DPSK DH1

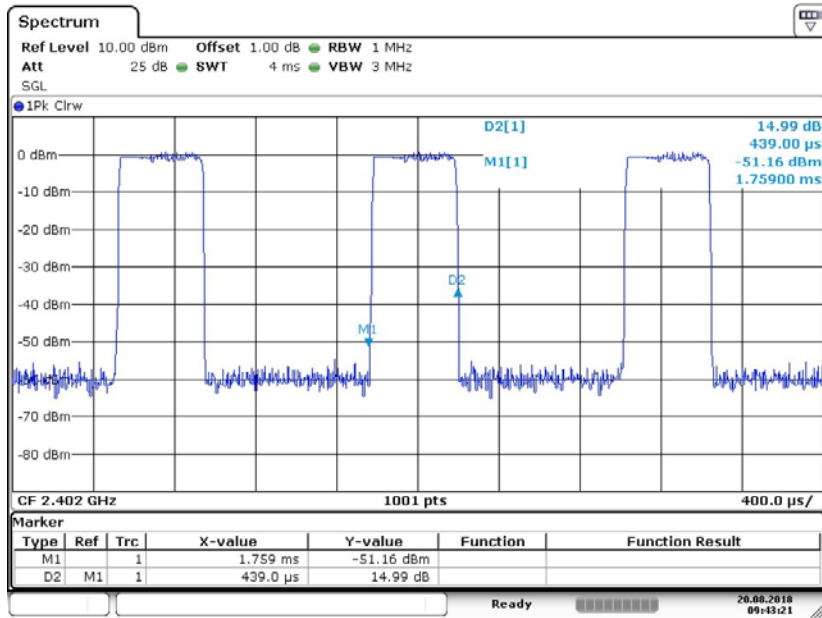

Date: 20.AUG.2018 09:43:21

Test Model	Average Time Of Occupancy (Dwell Time)	
	CH 0: 2402MHz	8DPSK DH3

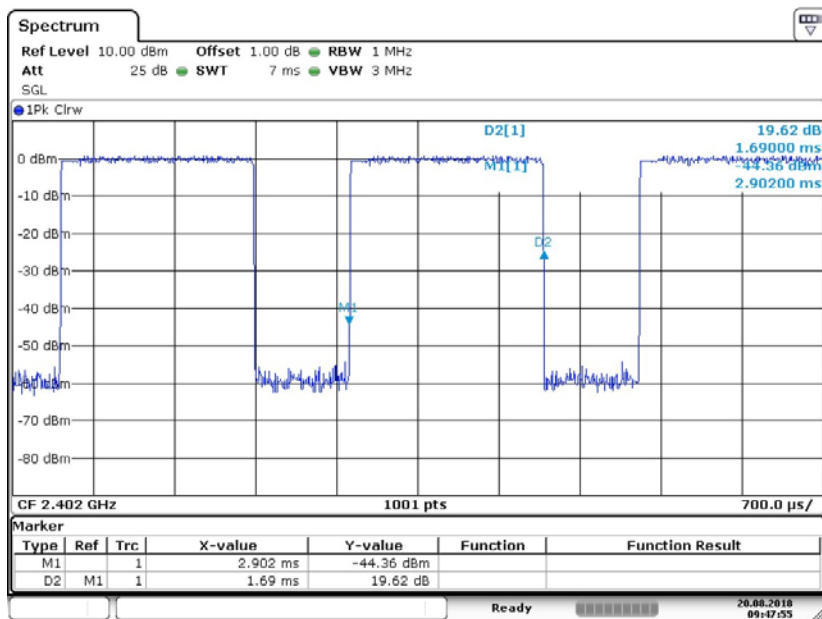

Date: 20.AUG.2018 09:47:54

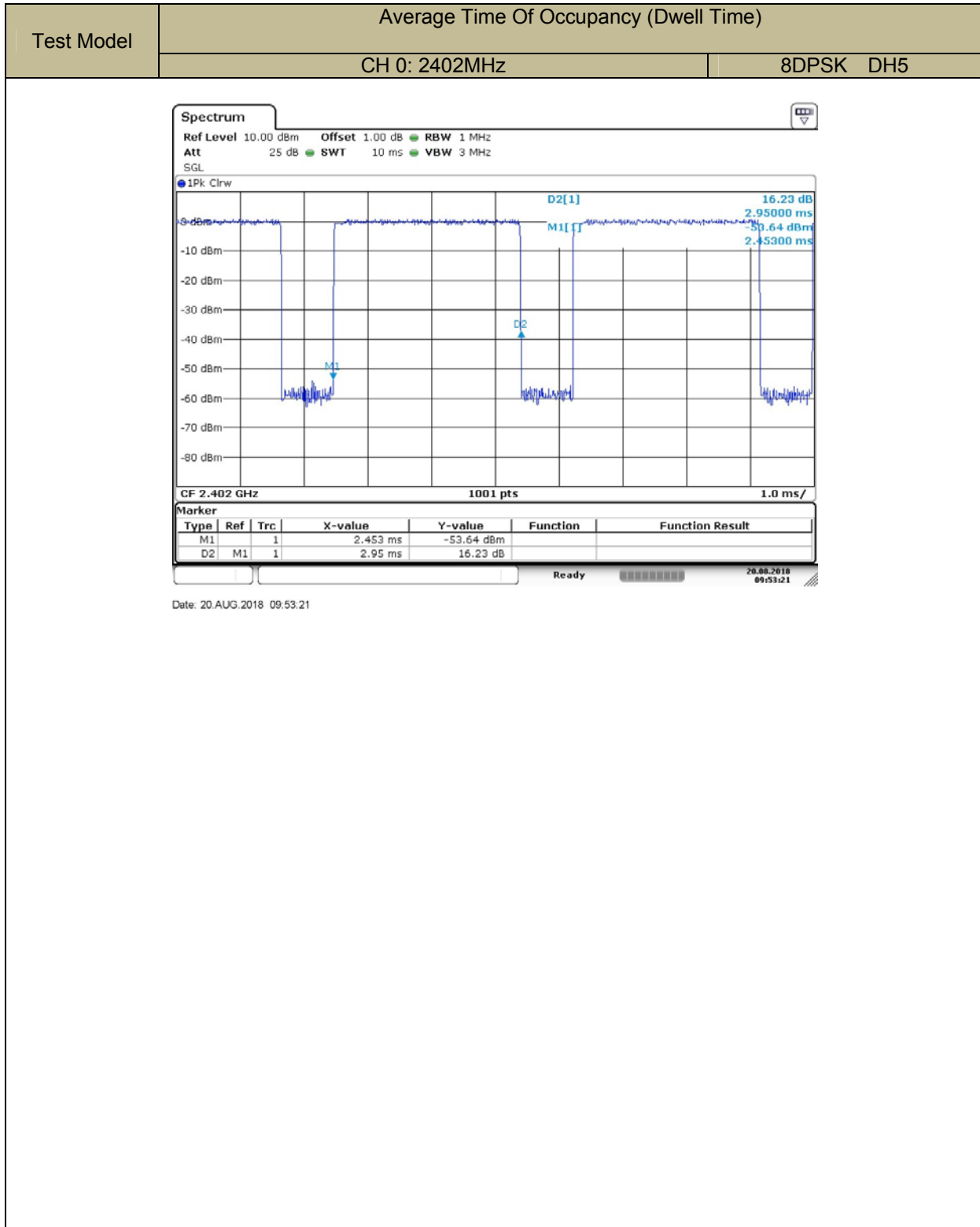

Test Model	Average Time Of Occupancy (Dwell Time)	
	CH 39: 2441MHz	8DPSK DH1

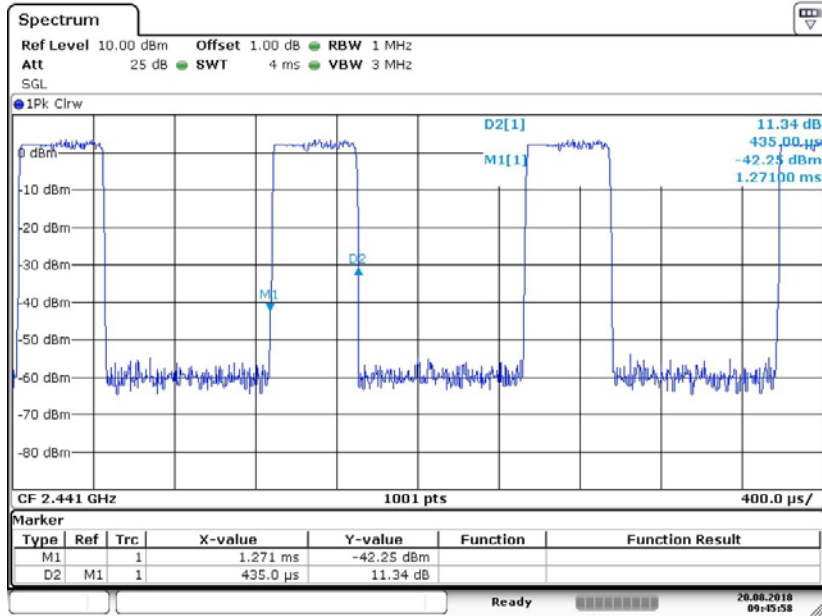

Date: 20.AUG.2018 09:45:58

Test Model	Average Time Of Occupancy (Dwell Time)	
	CH 39: 2441MHz	8DPSK DH3

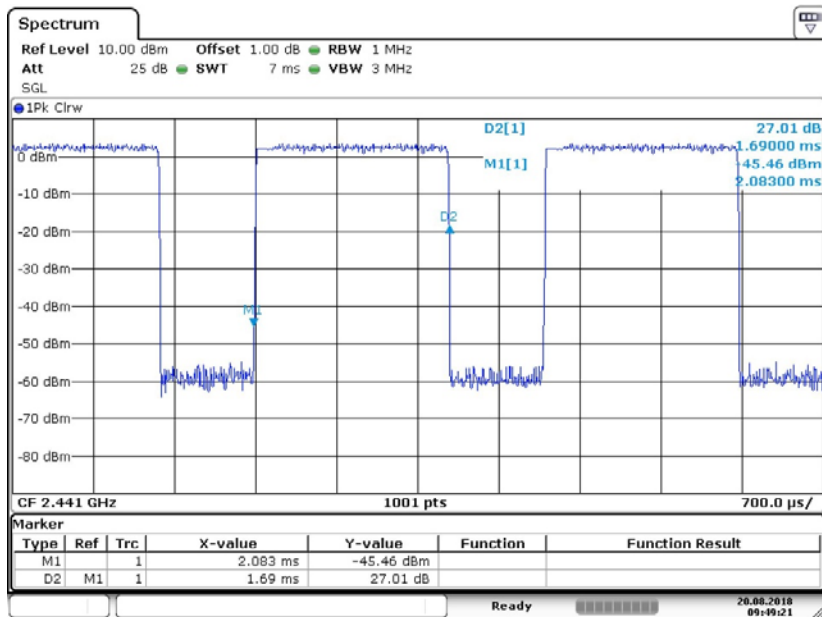

Date: 20.AUG.2018 09:49:20

Test Model	Average Time Of Occupancy (Dwell Time)	
	CH 0: 2441MHz	8DPSK DH5

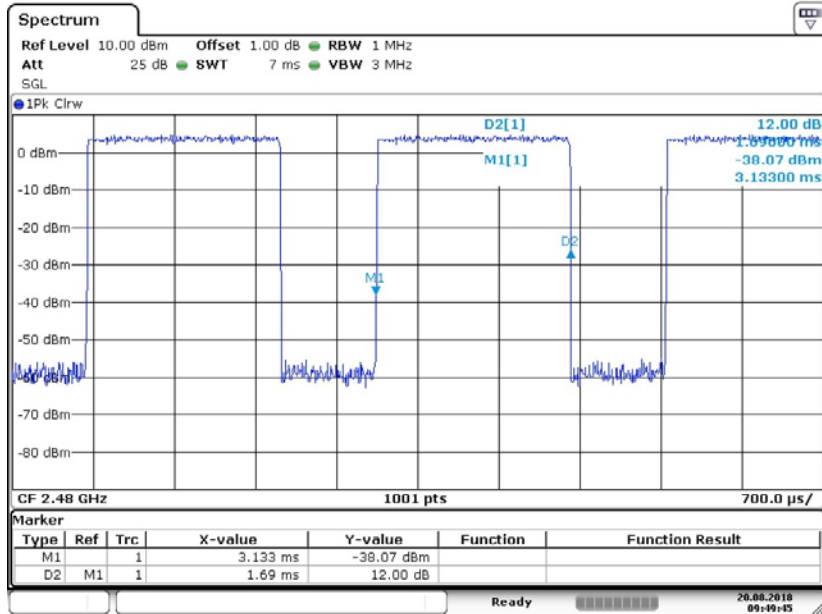

Date: 20.AUG.2018 09:49:45

Test Model	Average Time Of Occupancy (Dwell Time)	
	CH 78: 2480MHz	8DPSK DH1

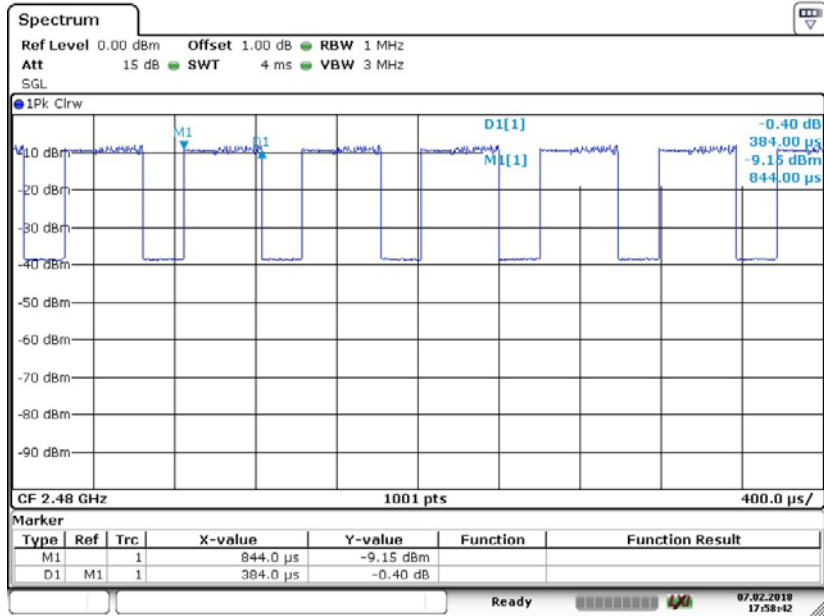

Date: 7.FEB.2018 17:58:42

Test Model	Average Time Of Occupancy (Dwell Time)	
	CH 78: 2480MHz	8DPSK DH3

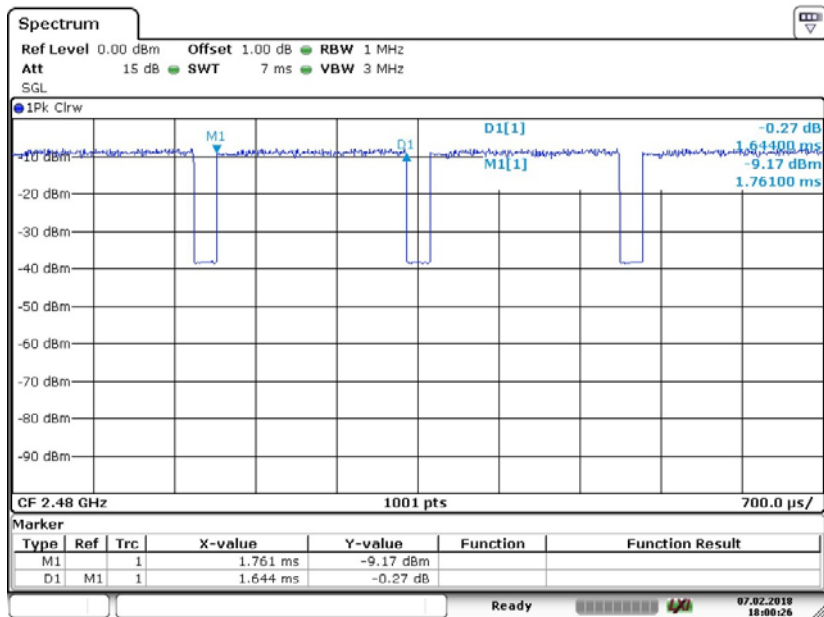

Date: 7.FEB.2018 18:00:25

