

AVB32V02C



**Programmable Digital Thermostat
Commercial**

7 Day Programmable • Up to 3-heat & 2-cool

with
Wi-Fi
and
Local API

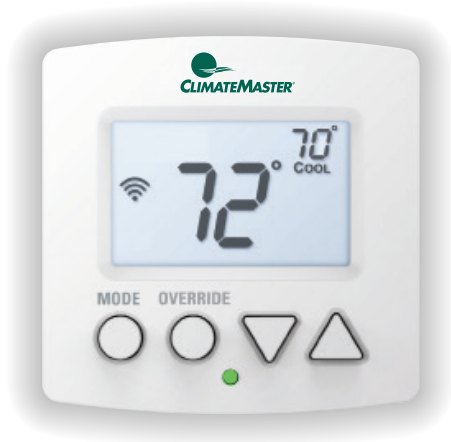

**Owner's Manual &
Installation Instructions**



CAUTION

Follow the Installation Instructions before proceeding. Set the thermostat mode to “OFF” prior to changing settings in setup or restoring Factory Defaults.

FCC Compliance Statement

This equipment has been tested and found to comply with the limits for a Class B digital device, pursuant to part 15 of the FCC Rules. These limits are designed to provide reasonable protection against harmful interference in a residential installation. This equipment generates, uses and can radiate radio frequency energy and, if not installed and used in accordance with the instructions, may cause harmful interference to radio communications. However, there is no guarantee that interference will not occur in a particular installation. If this equipment does cause harmful interference to radio or television reception, which can be determined by turning the equipment off and on, the user is encouraged to try to correct the interference by one or more of the following measures:

- Reorient or relocate the receiving antenna.
- Increase the separation between the equipment and receiver.
- Connect the equipment into an outlet on a circuit different from that of the receiver.
- Consult the dealer or an experienced radio or TV technician for help.

Notice: Only peripherals complying with FCC limits may be attached to this equipment. Operation with noncompliant peripherals or peripherals not recommended by Venstar, is likely to result in interference to radio and TV reception. Changes or modifications to the product, not expressly approved by Venstar could void the user's authority to operate the equipment.

FCC - INDOOR Mobile Radio Information:

To comply with FCC/IC RF exposure limits for general population / uncontrolled exposure, the antenna(s) used for this transmitter must be installed to provide a separation distance of at least 20 cm from all persons and must not be co-located or operating in conjunction with any other antenna or transmitter.

This Device complies with Industry Canada License-exempt RSS standard(s). Operation is subject to the following two conditions: 1) this device may not cause interference, and 2) this device must accept any interference, including interference that may cause undesired operation of the device.

Under Industry Canada regulations, this radio transmitter may only operate using an antenna of a type and maximum (or lesser) gain approved for the transmitter by Industry Canada. To reduce potential radio interference to other users, the antenna type and its gain should be so chosen that the equivalent isotropically radiated power (e.i.r.p.) is not more than that necessary for successful communication.

Cet appareil est conforme avec Industrie Canada, exempts de licence standard RSS(s). Son fonctionnement est soumis aux deux conditions suivantes: 1) ce dispositif ne doit pas causer d'interférences, et 2) ce dispositif doit accepter toute interférence, y compris les interférences qui peuvent causer un mauvais fonctionnement de l'appareil.

En vertu des règlements d'Industrie Canada, cet émetteur de radio ne peut fonctionner en utilisant une antenne d'un type et maximale (ou moins) Gain approuvé pour l'émetteur par Industrie Canada. Pour réduire les interférences radio potentielles aux autres utilisateurs, le type d'antenne et son gain doivent être choisis afin que la puissance isotrope rayonnée équivalente (PIRE) ne est pas plus de ce qui est nécessaire pour une communication réussie.

We, Climate Master, declare under our sole responsibility that the device to which this declaration relates: Complies with Part 15 of the FCC Rules. Operation is subject to the following two conditions: (1) this device may not cause harmful interference, and (2) this device must accept any interference received, including interference that may cause undesired operation.

FCC ID: MUH-SKYPORT10

IC: 12547A-SKYPORT10

This Mini thermostat has the ability to receive updates to its firmware. Periodically firmware updates are released by the manufacturer to add features and/or performance enhancements. This manual was produced reflecting the most current firmware/feature set at the time of publication, firmware rev. 1.0. Firmware releases after rev. 1.0 may not be adequately depicted in this manual. Please refer to the appropriate website or contact your place of purchase to learn about changes to the thermostat after firmware release 1.0.



Innovation, Science and Economic Development Canada
ICES-003 Compliance Label: CAN ICES-3 (B)/NMB-3(B)

Table of Contents

Installation Instructions	1
Wire Connections	2
Thermostat Backplate	3
Dip Switch Settings	4
Connect to Wi-Fi	9
Front Panel	12
Display	13
Basic Operation	15
User Setup	17
Backlight Operation	19
Setpoint Limits	21
Service Filter	24
Installer Setup	25
Programming a Daily Schedule	32
About Advanced Features & Operation	34
Factory Defaults	37
Advanced Setup Table	39



IMPORTANT

Follow Installation Instructions carefully. Disconnect Power to the Heater/Air Conditioner before removing the old thermostat and installing the new thermostat.

Glossary of Terms

Auto-Changeover: A mode in which the thermostat will turn on the heating or cooling based on room temperature demand.

Cool Setpoint: The warmest temperature that the space should rise to before cooling is turned on (without regard to deadband).

Deadband: The number of degrees the thermostat will wait, once a setpoint has been reached, before energizing heating or cooling.

Differential: The forced temperature difference between the heat setpoint and the cool setpoint.

Heat Setpoint: The coolest temperature that the space should drop to before heating is turned on (without regard to deadband).

Icon: The word or symbol that appears on the thermostat display.

Mode: The current operating condition of the thermostat (i.e. Off, Heat, Cool, Auto).

Non-Programmable Thermostat: A thermostat that does not have the capability of running Time Period Programming.

Programmable Thermostat: A thermostat that has the capability of running Time Period Programming.

Pre-Occupancy Purge: Fan operation prior to Occupied 1.

Temperature Swing: Same as Deadband.

Time Period Programming: A program that allows the thermostat to automatically adjust the *heat setpoint* and/or the *cool setpoint* based on the time of the day.

Installation Instructions

Remove and Replace the old thermostat

To install the thermostat properly, please follow these step by step instructions. If you are unsure about any of these steps, call a qualified technician for assistance.

- Installation tools: Small flat blade screwdriver, Phillips screwdriver, wire cutters and wire strippers.



- Make sure your Heater/Air Conditioner is working properly before beginning installation of the thermostat.
- Carefully unpack the thermostat. Save the screws, any brackets, and instructions.
- Turn off the power to the Heating/Air Conditioning system at the main fuse panel. Most residential systems have a separate breaker or switch for disconnecting power to the furnace.
- Remove the cover of the old thermostat. If it does not come off easily, check for screws.
- Loosen the screws holding the thermostat base or subbase to the wall and lift away.
- If you have a smart phone handy, take a photo of the wiring for future reference.
- Disconnect the wires from the old thermostat. Tape the ends of the wires as you disconnect them, and mark them with the letter of the terminal for easy reconnection to the new thermostat.
- Keep the old thermostat for reference purposes, until your new thermostat is functioning properly.

Installation Instructions

Wire Connections

If the terminal designations on your old thermostat do not match those on the new thermostat, **refer to the chart below or the wiring diagrams that follow.**

Wire from the old thermostat terminal possibly marked	Function (Heatpump)	Function (Gas/Electric)	Install on the new thermostat connector marked
G,F	Fan	Fan	G
Y,Y1	1st stage heating/cooling	1st stage cooling	Y1
Y2	2nd stage heating/cooling	2nd stage cooling	Y2
W,W1		1st stage heating	O
W2		2nd stage heating	W
W (on CLM products)	3rd stage heating emergency heat		W
O	reversing valve		O
	humidifier	humidifier	D/H (note 1)
DH (on CLM products)	ClimaDry		D/H (note 2)
	dehumidifier	dehumidifier	D/H (note 2)
	dry contact	dry contact	CK1 (note 3)
R,Rh,M,Vr,A	power	power	R
C	common	common	C

Note 1 : set the AUX USE (setup step #32) to humidifier. Also, set the HUM WITH HEAT ONLY (setup step #37) as required

Note 2 : set the AUX USE (setup step #32) to dehumidifier. Also, set the DEHUM WITH COOL ONLY (setup step #37) as required

Note 3 : external device should switch CK1 to R to enable the function specified in DRY CONTACT USE (setup step #29), default = condensate pan

Installation Instructions

The Thermostat Backplate

To remove the thermostat backplate:

Gently separate the display from the base by pulling from the center.

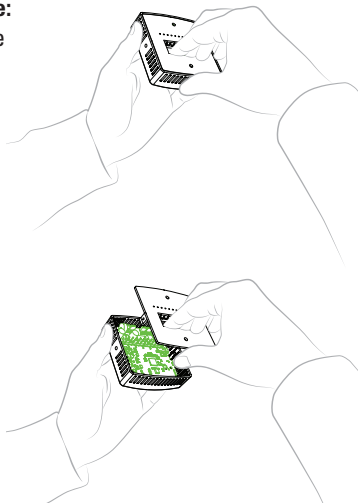
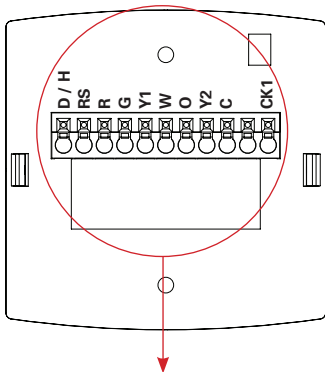

D/H dehumidify or humidify output

RS wired remote sensor input

R 24 VAC power

G fan output

Y1 1st stage compressor

W strip heat (HP) or 2nd stage gas (GAS) output

O reversing valve (HP) or 1st stage gas (GAS)

Y2 2nd stage compressor

C 24 VAC common

CK1 dry contact

IMPORTANT: This thermostat requires both **R (24 VAC Return)** and **C (24 VAC Common)** wires be connected to the backplate terminals to operate properly.

Installation Instructions

Check Dip Switch

Ensure which switch is correct for your system. Dip switches are located on the back of the thermostat.

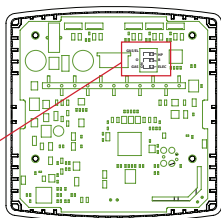

This switch (GAS or ELEC) controls how the thermostat will control the Fan (G) terminal in heating mode. When **GAS** is chosen, the thermostat will not energize the Fan (G) terminal in heating. When **ELEC** is chosen the thermostat will energize the fan in heating.



This dip switch configures the thermostat to control a conventional gas/electric system or a heat pump. Note that when set for HP, the thermostat will only drive a type O reversing valve.

Installation Instructions

1 Stage Heat, 1 stage Cool

Dip Switch Settings

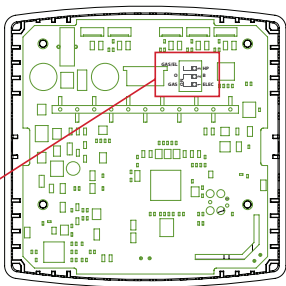
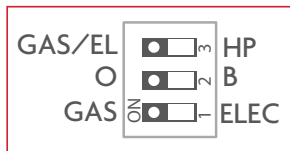

Thermostat

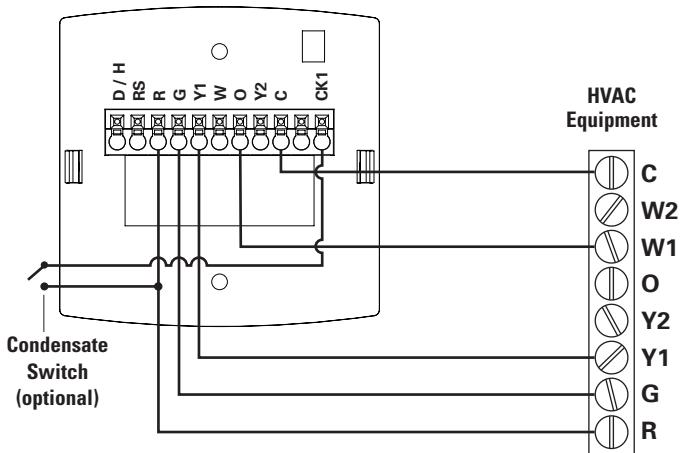

Installation Instructions

2 Stage Heat, 2 Stage Cool

with wired remote sensor

Dip Switch Settings

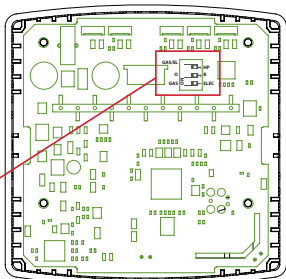
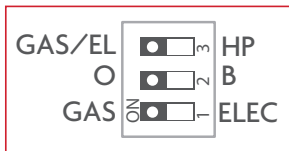

Thermostat

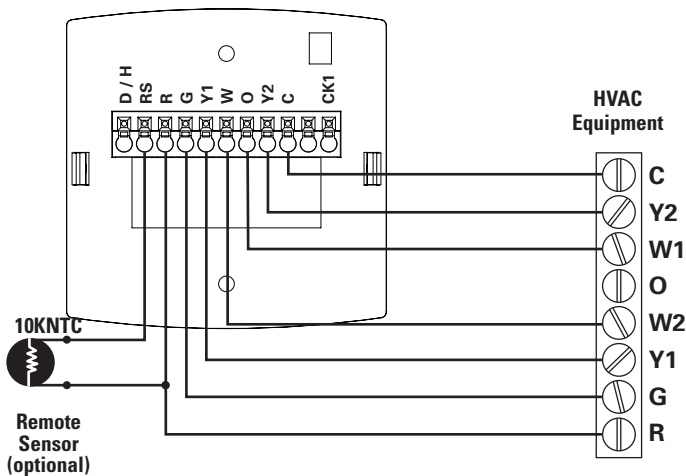

Installation Instructions

Single Stage Heat Pump with AUX Heat

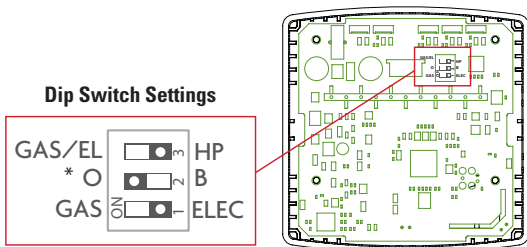

Single Stage Unit, CXM

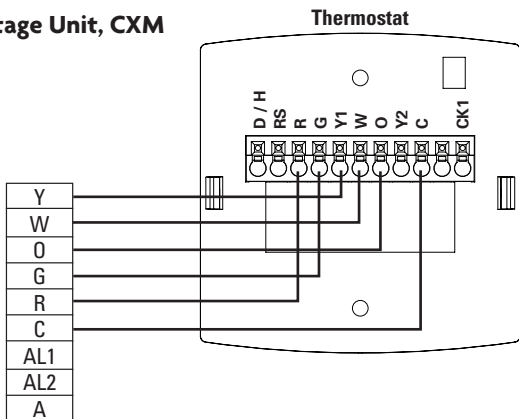

Installation Instructions

Dual Stage Heat Pump with AUX Heat and ClimaDry

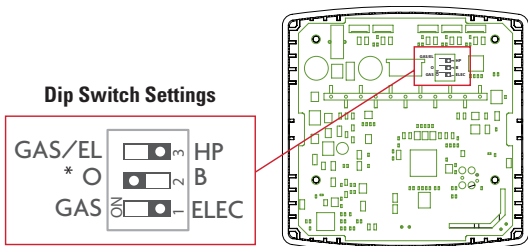

Two Stage Unit, DXM2

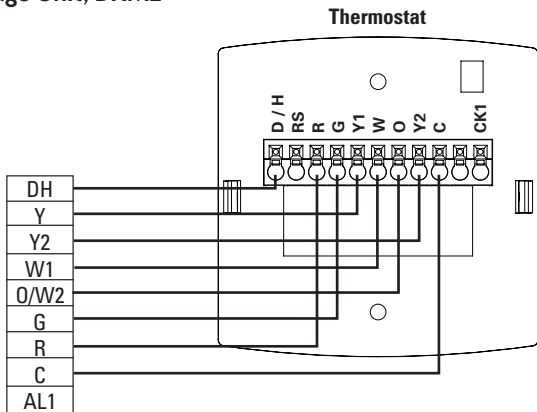

Connect to Wi-Fi Overview

At minimum the first 3 tasks below must be completed to access your thermostat remotely from a browser. The 4th step is optional (highly recommended) and only is needed to access your thermostat(s) from a mobile device.

These steps are:

1. Successful connection to a local Wi-Fi Access Point with internet access.
2. Confirm receipt of a Skyport generated verification email (this only occurs once during the Skyport account setup).
3. A 6-digit code obtained from the thermostat is successfully entered into a Skyport account.
4. Successfully download and install the ClimateMaster Skyport app on your mobile device(s).

Your thermostat operates on the 2.4 Ghz, Wi-Fi b/g/n band.

Wi-Fi Symbol Legend



When the only the 'dot' of the Wi-Fi symbol appears = not connected to an access point.



When the full Wi-Fi symbol appears = connected to an access point.



When the full Wi-Fi symbol appears and the 'dot' of the symbol is flashing = connected to Skyport.

Connect to Wi-Fi Overview

Wi-Fi Setup

The ClimateMaster Configurator App is needed to configure the Wi-Fi Settings of this thermostat

- **Download the ClimateMaster Configurator App** from your mobile device's App Store.



ICON

- **Open the ClimateMaster Configurator App**
 - Choose the Explorer Mini thermostat by sliding the thermostat pictures at the top of the apps' display to the left until you see a picture of the Explorer Mini.
 - Press and hold the OVERRIDE button of the thermostat for approximately 5 seconds to enter Wi-Fi setup screens.
 - Press the cooler button to setup Wi-Fi.
 - Follow the instructions that appear on the ClimateMaster Configurator App.

Connect to Skyport

Although there is more than one way to create a Skyport account, the steps below illustrate account creation from a browser. To create a Skyport account a thermostat must be joined to the account.

If the thermostat is connected to the local Wi-Fi Access Point, but you do not have a Skyport account, you may create an account and join the thermostat to the account by doing the following:

1. Open your browser to: <http://ClimateMaster.skyportcloud.com>
2. Select "Create account now"

 Create Account Now

3. Follow on screen instructions to create an account and add a thermostat to the Skyport account.

Connect to Wi-Fi Overview

Join a Thermostat to Skyport

If the thermostat is connected to the local Wi-Fi access point but not yet joined to an existing Skyport account, you may join the thermostat to the account by doing the following:

1. Log in to your Skyport account.
2. Select the “Location” you want to add a thermostat into.
3. Select the “Thermostat tab”.
4. Select “+ Add thermostat”. A screen will ‘pop-up’ asking for a six digit code.
5. Press the OVERRIDE button on the thermostat for 5 seconds.
6. Press the WARMER button on the thermostat.
7. A six digit code will appear on the thermostat’s display.
8. Enter the six digit code into your Skyport account.

Wi-Fi Status Screens

Press and hold the OVERRIDE button on the thermostat for 5 seconds. When “Wi-Fi Setup” appears on the display, press the MODE button. Pressing the up or down button will sequence through the following information:

- AP Name
- AP Signal Strength
- IP Address
- Skyport Status
- API Status

Front Panel

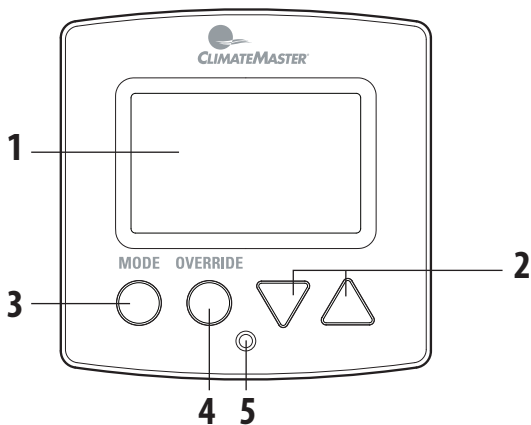

- 1 Backlit Display
- 2 Up/Warmer, Down/Cooler Buttons
- 3 Mode Button
- 4 Override Button
- 5 Heat or Cool Indicator
Heat = Red, Cool = Green

Display

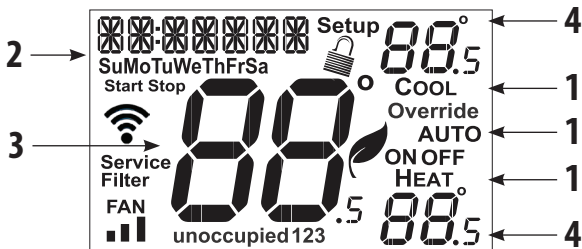

1 Mode Indicators

Selects the operational mode of the equipment.

HEAT - Indicates the heating mode.

COOL - Indicates the cooling mode.

AUTO - Indicates the system will automatically changeover between heat and cool modes as the temperature varies.

OFF - Indicates heating and cooling are turned off.

2 Clock with Day of the Week

Indicates the current time and day. This clock is also used to program the time period schedules.

3 Room Temperature Display

Indicates current room temperature.

4 Desired Set Temperature

Indicates desired room temperature.

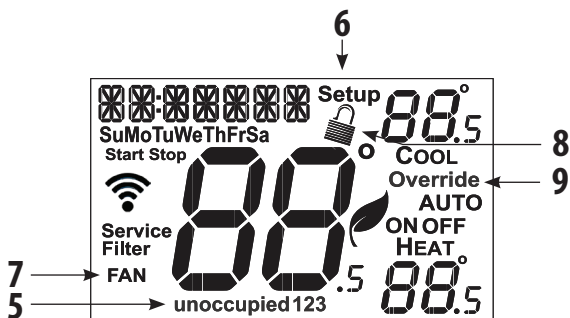

5 Occupied and Unoccupied icons

Indicates the part of the time period program.

6 Setup icon

Indicates the thermostat is in the setup mode.

7 Fan icon

When only the FAN icon is displayed, the fan is always on (except in off mode). If the FAN is not on the display, then the FAN is in Auto mode and will run only when necessary to heat or cool.

8 Locked icon

Indicates the thermostat's control buttons have been locked.

9 Override icon

Indicates OVERRIDE is enabled.

Basic Operation

Selecting Your Desired Temperature (adjusting the setpoints)

Auto-Changeover Mode

Pressing the UP or DOWN button in Auto mode will adjust both the heat and cool setpoints simultaneously. To adjust the heat and cool setpoints individually, choose HEAT mode to adjust the heat setpoint, and COOL mode to adjust the cool setpoint, then return to AUTO mode.



Adjust the desired set temperature with these buttons



Heat or Cool Mode

Pressing the UP or DOWN buttons in Heat or Cool mode will adjust only the heat or cool set temperature.

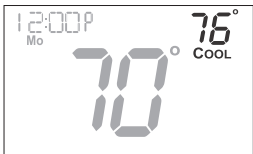

Using the Override Button

Unoccupied Operation -

During programmed, unoccupied periods, pressing the **OVERRIDE** button will force the thermostat into Occupied 1 settings for 30 minutes. Each press of the **OVERRIDE** button will add another 30 minutes of time up to the amount specified in Setup Step 9. If the maximum time has been set, the next press of the **OVERRIDE** button will reset the timer and return the thermostat to the correct time period program for the day.

Occupied Operation - During programmed, occupied periods, pressing the **OVERRIDE** button will force the thermostat into an unoccupied period for the rest of the day. During this forced unoccupied period the **OVERRIDE** button will operate as described above.

OVERRIDE



NOTE: OVERRIDE may only be used when the thermostat is set to PROGRAM ON.

Basic Operation

Selecting Your Desired Humidity

This thermostat is a perfect solution for reducing space humidity when using Climate Master two stage system with ClimaDry. To control dehumidification, be sure to set AUX USE (Setup Step 32) to 'dehumidifier'. Conversely, you can control a humidifier by setting AUX USE (Setup Step 32) to humidify. You cannot control both.

To adjust the humidity/dehumidify setpoint, first press/hold MODE for two seconds. The screen will change to show:



Next, press MODE again. The screen will show:

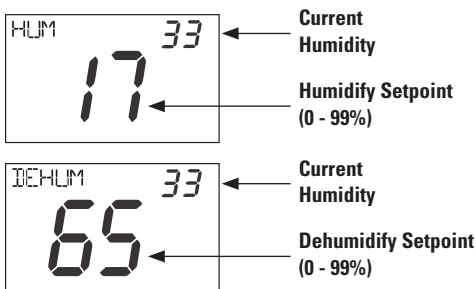

Adjust the desired set humidify/dehumidify value with UP or DOWN buttons



Finally, press MODE to return to normal operation.

User Setup

Table for button presses that are required for entering various menus

TO ENTER MENUS	BUTTON PRESS
Setup Steps	MODE & OVERRIDE for 5 seconds
Time Schedule	MODE & UP for 2 seconds
Emergency Heat	UP & OVERRIDE for 2 seconds
Lockout Buttons	MODE, UP & DOWN for 2 seconds
Calibration	MODE & DOWN for 2 seconds, then MODE
Wireless Setup	OVERRIDE for 5 seconds
Adjust Humidity	MODE for 2 seconds

How to Change Settings in the Setup Screens

To enter the setup screens, press the **MODE** button, and simultaneously press **OVERRIDE** button for 5 seconds. Release the buttons when you see "Setup" on the display. Use the **UP** or **DOWN** buttons to adjust the value of your selection. Press **MODE** to advance to the next setup step. Press **MODE** and **OVERRIDE** together again to leave the setup screens.

MODE **OVERRIDE**



press together for
5 seconds

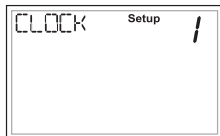

User Setup

Setting the Clock and Day

(setup step 1 & 2)

When your thermostat is connected to Skyport Cloud Services, the time and day of the week are controlled by Skyport. There is no local adjustment, Skyport also adjusts the time for Daylight Savings Time as well.

To set the time and day when not connected to Skyport; enter the setup screens by pressing the MODE button and simultaneously pressing the OVERRIDE button for 5 seconds.

Clock (Setup Step 1) adjusts the clock. Use the Warmer/Up or Cooler/Down buttons to adjust the time. Press the MODE button to advance to **step 2**.

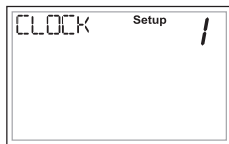

Week Day (Setup Step 2)

Select the day of the week using the Warmer/Up or Cooler/Down buttons.

Leave the setup screens by again pressing the MODE button and simultaneously pressing the OVERRIDE button for 5 seconds.



Show Clock (Setup Step 3)

This setup step will allow for removal of the clock and day of the week from the display. OFF removes the time and day from the display.

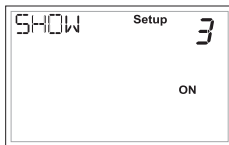

User Setup: Programming & Backlight Operation

Prog (Setup Step 4)

Adjust to ON or OFF to allow the thermostat to be 7 day programmable

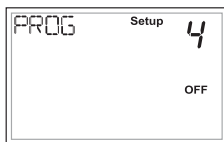

Backlight (Setup Steps 5-8)

Backlight (Setup Step 5)

OFF - Backlight turns on only with a button press and turns off after 8 seconds.

ON - Backlight is on continuously.



Night Light (setup step 6)

Selecting **ON** allows for turning off the backlight of the display during specific times of the day, usually at night.

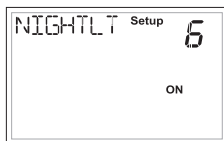

Night Light OffStart Time (setup step 7)

12:00 am to 12:00 am

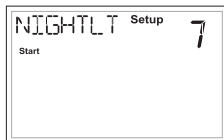

Night Light Off Stop Time (setup step 8)

12:00 am to 12:00 am



User Setup: Maximum Override & Fan Operation

Maximum Override Time in Hours

(Setup Step 9)

This feature limits the maximum override time when using the OVERRIDE button 1 - 4 hours.

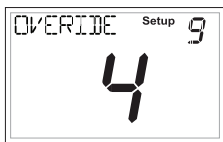

Fan (Setup Step 10)

FAN ON - indicates constant fan operation. Fan On is not allowed when the thermostat is in the Off Mode or unoccupied.

If **FAN AUTO** is selected, the fan will only operate during a heat or cool demand.

The Fan is forced into **FAN AUTO** when running a program and the thermostat shows "unoccupied".

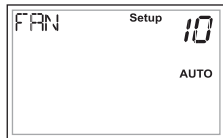

Display Fahrenheit or Celsius

(Setup Step 11)

This feature allows the thermostat to display temperature in Fahrenheit or Celsius.

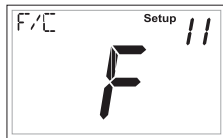

Minimum Heat/Cool Spread

(Setup Step 12)

This feature allows the user to set the minimum gap between Heat and Cool setpoints in AUTO mode. Select from 0 to 6 degrees.



User Setup: Setpoints

Setpoint Limits (Setup Step 13)

When this feature is set to ON, the Heat and Cool Setpoints may be restricted to preset levels in Setup Steps 14 and 15.



Maximum Heat Setpoint (Setup Step 14)



Minimum Cool Setpoint (Setup Step 15)

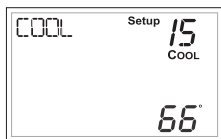

Lock OVERRIDE and MODE Buttons

This feature is available when the thermostat is connected to Skyport Cloud Services and may only be accessed through Skyport.

This security feature is not accessible locally at the thermostat.

When this setting is enabled; pressing the OVERRIDE or MODE buttons on the thermostat will have no effect.

This feature is often used in conjunction with setpoint limits.

Available Modes (Setup Step 16)

This setup step may restrict the use of this thermostat to: Heat only, Cool only, or Heat and Cool.

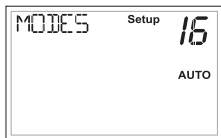

User Setup

Deadband Settings (Setup Steps 17-20)

The Deadband is the number of degrees or minutes that the thermostat waits before it initiates the stages of heating or cooling.

1st Stage Deadband (Setup Step 17)

Specifies the temperature difference between the room temperature and the desired setpoint before the 1st stage of heating or cooling is allowed to turn on. (1 - 6 degrees) For example, if the heat setpoint is 68° and the 1st Stage deadband is set to 2 degrees, the room temperature will need to reach **66°** before the heat turns on.

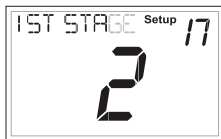

2nd Stage Deadband (Setup Step 18)

Specifies the additional temperature difference after the 1st stage turns on before the 2nd stage is activated. (0° - 10°)



Minutes Between 1st and 2nd Stage (Setup Step 19)

Specifies the minimum time (in minutes) after the 1st stage turns on before the 2nd stage can turn on. (0 - 60)



2nd Stage Turnoff Point (Setup Step 20)

Specifies whether 2nd stage will turn off at 1st stage deadband or remain on until the room temperature demand is satisfied. Choose between Deadband or Setpoint.

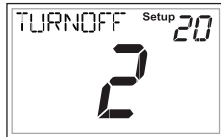

User Setup

Fan Off Delay (Setup Step 21)

This feature allows the user to increase the cooling or electric strip heating efficiency of the system. The thermostat may be programmed to continue running the fan after a call for cooling or electric strip heating has been satisfied. This delay can be set for 0, 30, 60, 90, or 120 seconds. If set to 0, the fan will not run after a call for cooling or electric strip heating has been satisfied.

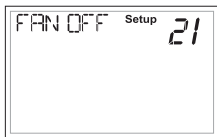

User Setup: Service Filter

These setup steps allow the user to monitor FAN runtimes and program service alerts. Service alerts appear on the display. If the thermostat is joined to a Skyport account, then the user may be alerted by Skyport Cloud Services when to change the filter.

Runtime hours
or days appear in
the clock display.

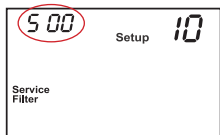

OVERRIDE



Press and hold **OVERRIDE** for 2 seconds to clear reset runtime.

Service Filter Runtime (Setup Steps 22-25)

Filter Runtime (Setup Step 22) - This counter keeps track of the number of hours of fan runtime in the Heating mode, Cooling mode, and in stand alone Fan operation. Press **OVERRIDE** for 2 seconds to reset.



Filter Runtime (Setup Step 23) - This counter displays the total number of calendar days that have elapsed since the counter was reset to help the user track Fan runtime. Press **OVERRIDE** for 2 seconds to reset.



Service Filter Alert Hours (Setup Step 24) - This timer allows the user to specify the number of hours the fan will run before the "Replace Filter" alert will be displayed. Press **DOWN** continuously until **OFF** is displayed to disable this alert.



Service Filter Alert Days (Setup Step 25) - This timer allows the user to specify the number of calendar days that will elapse before the "Replace Filter" alert will be displayed. Press **DOWN** continuously until **OFF** is displayed to disable this feature.

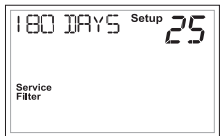

User Setup

Pre-Occupancy Fan Purge Time

(Setup Step 26)

When this feature is activated, the fan will turn on during an unoccupied period at a preset amount of time prior to Occupied 1. This preoccupancy fan purge timer may be set from zero to three hours, in 15 minute increments. Zero (0) means this feature is turned off.

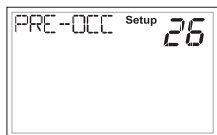

Comfort Recovery (Setup Step 27)

With Comfort Recovery on, the thermostat will attempt to reach the OCCUPIED 1 setpoint temperature at the exact time programmed into the thermostat. Comfort Recovery, only works when the thermostat enters the OCCUPIED 1 from the UNOCCUPIED.

For example, if OCCUPIED 1 is set for 6am at 72°F heating and 75°F cooling, the thermostat will turn the system on before 6am in an effort to bring the temperature to its correct setting at exactly 6am. The thermostat learns from experience how early to turn on, so please allow 4-8 days after a program change or after initial installation to give Comfort Recovery time to adjust. If used with a heat pump, electric strip heat will be disabled while Comfort Recovery is active.

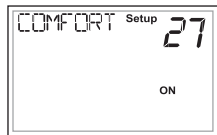

User Setup

Dry Contact Operation

Dry Contact Polarity (Setup Step 28)

Open (Normally Open) - The dry contact is open until the connected device closes the circuit.



'Idle'



'Active'



Closed (Normally Closed) - The dry contact is closed until the connected device opens the circuit.



'Idle'



'Active'

Dry Contact Use (Setup Step 29)

Condensate Pan - If selected when the Dry Contact is active, the thermostat will lockout compressor terminal(s) and "CONDENSATE PAN" will appear on the display.

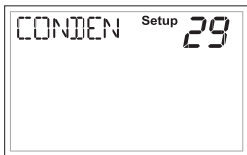

Holiday - If Holiday is selected when the dry contact is active, the thermostat will be forced into HOLIDAY/ Unoccupied settings.

FDD - If FDD is selected when the dry contact is active, "EQUIP FAULT" will appear on the display.

Occupied - If Occupied is selected when the dry contact is active, the thermostat will be forced into occupied settings.

User Setup

Wired Sensor Type (Setup Step 30)

RETURN, OUTDOOR, SUPPLY = the sensor temperature which is reported to Skyport to monitor only.

REMOTE = the sensor can be used for temperature control.

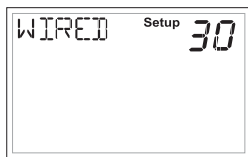

Control to Sensor (Setup Step 31)

Select LOCAL SENSOR ONLY to control to the temperature sensor inside the thermostat.

Select WIRED SENSOR ONLY to control to a temperature sensor connected to the RS & R terminals of the thermostat backplate.

Select AVERAGE LOCAL AND WIRED SENSORS to control to the average of those two temperatures.



NOTE: for wireless sensor control, additional options appear on the Skyport website.

Aux Use (Setup Step 32)

Select DEHUMIDIFIER or HUMIDIFIER to specify what type of equipment is connected to the D / H output.

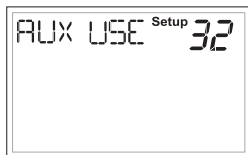

User Setup

Aux Polarity (Setup Step 33)

Select NORMAL, OPENED or NORMAL CLOSED to specify the output voltage on D / H terminal when there is no dehumidify/humidify call.

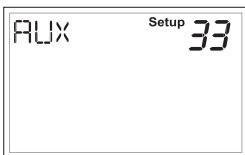

Cool to Dehum (Setup Step 34)

For use with non-ClimaDry equipment. Set to ON to possibly allow cooling to turn on exclusively to lower the room humidity.

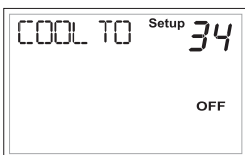

Dehum Overcool Degrees Below Set Point (Setup Step 35)

When Cool to Dehum set to ON, this step appears. Use this setting to specify how far below the cool setpoint that the room can cool to simply when cooling to satisfy a dehumidification demand.

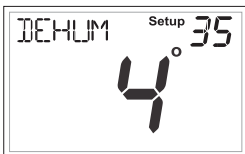

Fan with Dehum or Fan with Hum (Setup Step 36)

Depending on how AUX USE (Setup Step 32) is configured, this step is used to control whether the indoor blower should be turned on during a dehumidify or humidify demand (ON = blower, OFF = no blower).



User Setup

Dehum with Cool Only or Hum with Heat Only (Setup Step 37)

Depending on how AUX USE (Setup Step 32) is configured, this step is used to control whether the equipment must be running before the D / H output can turn on. when Humidifying, for example, you might not want to turn on the humidifier unless the thermostat is calling for heat. Answering ON to this step will mean no dehumidifying unless cool is active or no humidifying unless heat is active. Answering OFF to this step will allow the D / H output to simply reflect whether the room humidity is above the dehumidify setpoint (AUX USE = Dehum) or below the humidify setpoint (AUX USE = HUM).



User Setup

Skyport (Setup Step 38)

If set to ON, the thermostat may communicate and receive data from the Skyport Cloud Services.



API (Setup Step 39)

Turning on the local API allows 3rd party software to interface with the thermostat such as a home automation system.

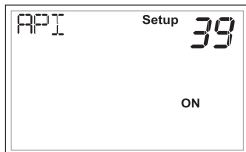

Time API (Setup Step 40)

Only appears when prior step for Local API is set to ON. This step allows the internal clock to be altered using the API.

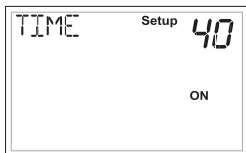

NOTE: *It is permissible to enable both Skyport and the local API at the same time.*

User Setup

Locking/Unlocking the Keypad

To prevent unauthorized use of the thermostat, the front panel buttons may be disabled. To disable, or 'lock' the keypad, press and hold the MODE button. While holding the MODE button, press the UP and DOWN buttons together, for two seconds.

When the  icon appears on the display, release the buttons.

Press all three buttons in the order outlined for keypad lockout

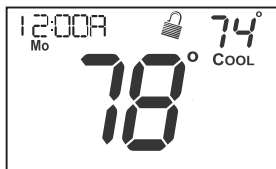

MODE



To **unlock** the keypad, press and hold the MODE button. While holding the MODE button, press the UP and DOWN buttons together for 2 seconds.

When the  icon disappears from the display, release the buttons.

Programming a Daily Schedule

Programming a Daily Schedule

To enter Time Period Programming screens, Press and hold **MODE** and **UP** until the scrolling prompt appears.



Select the number of Occupied time periods – Press the **UP** or **DOWN** buttons to choose the maximum number (up to 3 maximum) of Occupied time periods in a day.

Select the Mode for the Occupied period – Press the **UP** or **DOWN** buttons to choose the mode for the occupied period. The choices are: Off, Heat only, Cool only and AUTO changeover.

Adjust the Occupied Cool Setpoint – Press the **UP** or **DOWN** buttons to adjust the Cooling setpoint for comfort.

Adjust the Occupied Heat Setpoint – Press the **UP** or **DOWN** buttons to adjust the Heating setpoint for comfort.

Set the Unoccupied Mode – Press the **UP** or **DOWN** buttons to choose the mode for the Unoccupied period. The thermostat is in Unoccupied when the Time Period Schedule is running and there is not an active Occupied period. The choices are: Off, Heat only, Cool only and AUTO changeover.

Adjust the Unoccupied Cool Setpoint – Press the **Warmer** or **Cooler** buttons to adjust the Cooling setpoint for times when the thermostat is in Unoccupied.

Continued

Programming a Daily Schedule

Continued

Adjust the Unoccupied Heat Setpoint – Press the UP or DOWN button to adjust the Heating setpoint for times when the thermostat is in Unoccupied.

The following steps determine when the Occupied period(s) will be active.

Enable Occupied 1 – Press the UP or DOWN button to enable (On) or to disable (Off) Occupied 1 on Monday.

Adjust the Start Time for Occupied 1 – Press the UP or DOWN button to adjust the start time for Occupied 1 on Monday.

Adjust the Stop Time for Occupied 1 – Press the Warmer or Cooler button to adjust the stop time for Occupied 1 on Monday.

Upon pressing MODE after the above step, you will be prompted to Save and Exit or Copy this Occupied schedule to another day.

To save and exit – Press the MODE and UP button.

To Copy Monday's settings/schedule to Tuesday – Press Up and then MODE. Press MODE again to copy the Monday Settings/schedule to subsequent days.

To Program Another Day – Press MODE and then press the UP or DOWN button to select the day to program. Repeat the above steps for each day you would like to program.

Press and hold the MODE and UP Buttons to exit Time Period Programming at any time.

About Advanced Features & Operation

DEADBAND OPERATION - Controls heat pump up to three Heat and two Cool stages and heat/cool up to two heat and two cool stages.

The **1st Stage** of heat or cool is turned on when:

- (A) The temperature spread from the setpoint is equal to or greater than: the setpoint plus the 1st stage deadband (Setup Step 17). This 1st stage deadband is adjustable from 1-6 degrees and the default is 2 degrees.

The **2nd Stage** of heat or cool is turned on when:

- (A) The 1st Stage has been on for a minimum time as specified in minutes between 1st and 2nd stage (Setup Step 19). Default is 2 minutes.

AND

- (B) The temperature spread from the setpoint is equal to or greater than: the setpoint plus the 1st stage deadband, plus the 2nd stage deadband (Setup Step 18).

The **3rd Stage** of heat is only available in heatpump applications and is turned on when:

- (A) The 2nd Stage is running for a heat demand.

AND

- (B) The temperature spread from the setpoint is equal to or greater than the setpoint plus the 1st stage deadband, plus the 2nd stage deadband plus the 3rd stage deadband. The 3rd stage deadband is fixed at 2 degrees and is not adjustable.

TURNOFF TEMPERATURE - once started, the 2nd stage will turnoff at either the same temperature at which it started or remain on until the 1st stage turns off. **2nd STAGE TURNOFF POINT** (Setup Step 20) specifies if 2nd stage turns off at its turn on point (deadband) or keeps running longer (setpoint).

About Advanced Features & Operation

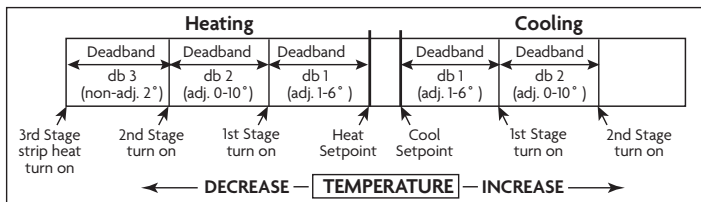

The above figure assumes the minimum on time for the prior stage has been met to allow the next stage to turn on, once the deadbands have been exceeded.

Emergency Heat

Only available if you have a Heat Pump installed. To initiate the **Emergency Heat** feature, press the **VERRIDE** button. While holding the **VERRIDE** button press the **UP** button for 2 seconds. The display will read 'EM HEAT' (Emergency Heat).

VERRIDE



Press for
Emergency Heat

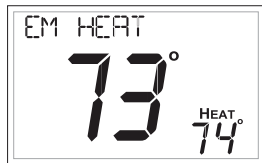

During Emergency Heat operation the thermostat will turn on the fan and the Aux strip heat when there is a demand for heat. Also during Emergency Heat, heatpump operation will be unavailable.

Exit Emergency Heat

Follow the same steps as entering **Emergency Heat** by pressing the **VERRIDE** and **UP** buttons for 2 seconds. During Emergency Heat, only OFF and HEAT modes are available by pressing the **MODE** button.

About Advanced Features & Operation

Calibration

Under normal circumstances it will not be necessary to adjust the calibration of the temperature sensor. If calibration is required, please contact a trained HVAC technician to correctly perform the following procedure.

- 1 **MODE** Place the thermostat in the OFF mode.

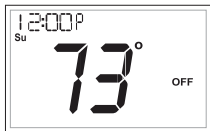

- 2 **MODE** Press and hold the MODE button. While holding the **MODE** button, press and hold the **DOWN** button for 5 seconds.



All icons will appear on the display.

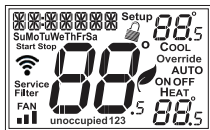

- 3 **MODE** Press the **MODE** button once. The thermostat temperature will be displayed and may be calibrated using the **UP** or **DOWN** buttons. The calibrated offset from the "raw" temperature reading is displayed in the lower right corner.



Additionally, on this screen you may view the Software Version in the upper left corner.

- 4 **MODE** After calibration is complete, press the **MODE** button **once** to save your changes and return to normal operation.

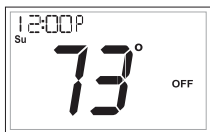



About Advanced Features & Operation

Factory Defaults

If, for any reason, you desire to return all the stored settings back to the factory default settings, follow the instructions below.

WARNING: This will reset all Time Period and Advanced Programming to the default settings. Any information entered prior to this reset will be permanently lost.

- MODE**
 Place the thermostat in the OFF mode.

- MODE**

 Press and hold the MODE button. While holding the MODE button, press and hold the DOWN button for 5 seconds. All icons will appear on the display.

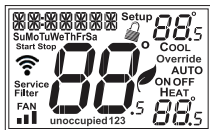
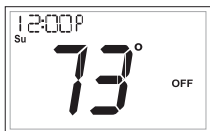
- 3**
OVERRIDE

 - After all of the icons appear, release the MODE and DOWN buttons.
 - Press and hold the OVERRIDE button for 2 seconds. Fd (Factory default settings) and ALL will appear on the display.



(Continued)

About Advanced Features & Operation

(Continued)

You now have the option of restoring the factory settings to just Wi-Fi (**Wi-Fi**), or just the thermostat (**STAT**), or both the thermostat and Wi-Fi (**ALL**).

C. Select one of the above options using the Up or Down buttons.

D. Press **VERRIDE** for 2 seconds to restore the factory settings.



VERRIDE



After factory settings are restored, the thermostat display will return to the "all icon" screen.

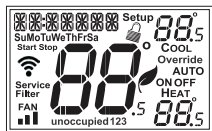

4

MODE



To return to normal operation;
Press the **MODE** button twice.

Advanced Setup Table

FD = Factory Default Setting

Step#	Description	Pg#	Range	FD
1	CLOCK		12A - 12A	12P
2	WEEKDAY		Monday - Sunday	Monday
3	SHOW CLOCK		On, Off	On
4	PROG		On, Off	On
5	BACKLIGHT		On, Off	Off
6	NIGHTLT		On, Off	Off
7	NIGHTLT START		12A - 12A	8:00P
8	NIGHTLT STOP		12A - 12A	6:00A
9	MAX OVRRIIDE TIME IN HOURS		0 - 4 hrs	4
10	FAN		on,auto	auto
11	DISPLAY F/C		F, C	F
12	MINIMUM HEAT/COOL SPREAD		0 - 6 degrees	2
13	SETPOINT LIMITS		on,off	off
14	MAX HEAT SETPOINT		35 - 99 degrees	82
15	MIN COOL SETPOINT		35 - 99 degrees	66
16	AVAILABLE MODES		auto, cool, heat, cool & heat	auto
17	1ST STAGE DEADBAND		1 - 6 degrees	2
18	2ND STAGE DEADBAND		0 - 10 degrees	2
19	MINUTES BETWEEN 1st AND 2nd STAGE		0 - 60 min	2
20	2ND STAGE TURNOFF POINT		deadband, setpoint	deadband
21	FAN OFF DELAY		0, 30, 60, 90 seconds	0
22	FILTER RUNTIME		runtime in hours	
23	FILTER RUNTIME		runtime in days	
24	SERVICE FILTER ALERT HOURS		off - 2000 hrs	off
25	SERVICE FILTER ALERT DAYS		off - 720 days	off
26	PRE-OCC FAN PURGE TIME		off - 3 hrs	off
27	COMFORT RECOVERY		On, Off	Off
28	DRY CONTACT POLARTY		NORMAL OPENED, NORMAL CLOSED	NORMAL OPENED
29	DRY CONTACT USE		occupied, condensate, fdd, holiday	condensate

(continued)

Advanced Setup Table

FD = Factory Default Setting

Step#	Description	Pg#	Range	FD
30	WIRED SENSOR TYPE		return, outdoor, supply, remote	return
31	CONTROL TO SENSOR		local, wired, average	local
32	AUX USE		dehumidifier, humidifier	dehumidifier
33	AUX POLARTY		NORMAL OPENED, NORMAL CLOSED	NORMAL OPENED
34	COOL TO DE-HUM		On, Off	Off
35	DEHUM OVER-COOL		1 - 20 degrees	4
36	FAN WITH DEHUM / FAN WITH HUM		On, off	Off
37	DEHUM WITH COOL ONLY / HUM WITH HEAT ONLY		On, Off	Off
38	SKYPORT		On, Off	On
39	API		On, Off	Off
40	TIME API		On, Off	Off

TO ENTER MENUS BUTTON PRESS

Setup Steps MODE & OVERRIDE for 5 sec.
 Time Schedule MODE & UP for 2 seconds
 Emergency Heat UP & OVERRIDE for 2 seconds

TO ENTER MENUSBUTTON PRESS

Lockout Buttons.....MODE, UP & DOWN for 2 sec.
 Calibration.....MODE & DOWN for 2 sec., then MODE
 Wireless SetupOVERRIDE for 5 Seconds

Warranty

One-Year Warranty - This Product is warranted to be free from defects in material and workmanship. If it appears within one year from the date of original installation, whether or not actual use begins on that date, that the product does not meet this warranty, a new or remanufactured part, at the manufacturer's sole option to replace any defective part, will be provided without charge for the part itself provided the defective part is returned to the distributor through a qualified servicing dealer.

THIS WARRANTY DOES NOT INCLUDE LABOR OR OTHER COSTS incurred for diagnosing, repairing, removing, installing, shipping, servicing or handling of either defective parts or replacement parts. Such costs may be covered by a separate warranty provided by the installer.

THIS WARRANTY APPLIES ONLY TO PRODUCTS IN THEIR ORIGINAL INSTALLATION LOCATION AND BECOMES VOID UPON REINSTALLATION.

LIMITATIONS OF WARRANTIES – ALL IMPLIED WARRANTIES (INCLUDING IMPLIED WARRANTIES OF FITNESS FOR A PARTICULAR PURPOSE AND MERCHANTABILITY) ARE HEREBY LIMITED IN DURATION TO THE PERIOD FOR WHICH THE LIMITED WARRANTY IS GIVEN. SOME STATES DO NOT ALLOW LIMITATIONS ON HOW LONG AN IMPLIED WARRANTY LASTS, SO THE ABOVE MAY NOT APPLY TO YOU. THE EXPRESSED WARRANTIES MADE IN THIS WARRANTY ARE EXCLUSIVE AND MAY NOT BE ALTERED, ENLARGED, OR CHANGED BY ANY DISTRIBUTOR, DEALER, OR OTHER PERSON WHATSOEVER.

ALL WORK UNDER THE TERMS OF THIS WARRANTY SHALL BE PERFORMED DURING NORMAL WORKING HOURS. ALL REPLACEMENT PARTS, WHETHER NEW OR REMANUFACTURED, ASSUME AS THEIR WARRANTY PERIOD ONLY THE REMAINING TIME PERIOD OF THIS WARRANTY. THE

MANUFACTURER WILL NOT BE RESPONSIBLE FOR:

1. Normal maintenance as outlined in the installation and servicing instructions or owner's manual, including filter cleaning and/or replacement and lubrication.
2. Damage or repairs required as a consequence of faulty installation, misapplication, abuse, improper servicing, unauthorized alteration or improper operation.
3. Failure to start due to voltage conditions, blown fuses, open circuit breakers or other damages due to the inadequacy or interruption of electrical service.
4. Damage as a result of floods, winds, fires, lightning, accidents, corrosive environments or other conditions beyond the control of the Manufacturer.
5. Parts not supplied or designated by the Manufacturer, or damages resulting from their use.
6. Manufacturer products installed outside the continental U.S.A., Alaska, Hawaii, and Canada.
7. Electricity or fuel costs or increases in electricity or fuel costs for any reason whatsoever including additional or unusual use of supplemental electric heat.
8. ANY SPECIAL INDIRECT OR CONSEQUENTIAL PROPERTY OR COMMERCIAL DAMAGE OF ANY NATURE WHATSOEVER. Some states do not allow the exclusion of incidental or consequential damages, so the above may not apply to you.

This warranty gives you specific legal rights and you may also have other rights which may vary from state to state.

P/N 88-1357
08/12/19

